

版次	變更原因	變更日期	備註
D→E	新機PC外觀及結構	95.05.09	

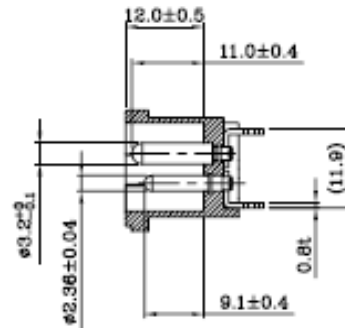

A-A

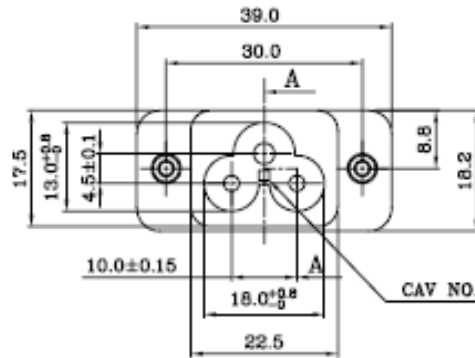
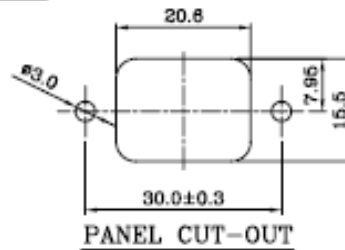
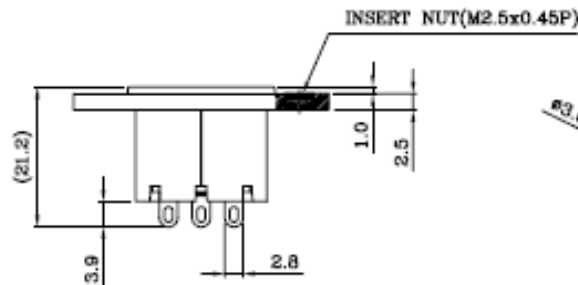
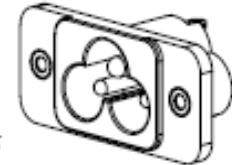
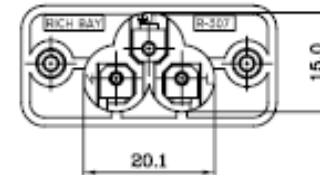

PANEL CUT-OUT

SPECIFICATION:

1. Insulation Resistance: Over 100MΩ at 500V DC.
2. Dielectric strength: 2000V AC 1 Minute.
3. Body Material: Thermoplastic 94V-2-V-0.

Rating:AC 2.5A 250V	
Mark	Safety Regulation
	UL
	CUL
Rating:AC 2.5A 250V	
Mark	Safety Regulation
	VDE
	CCC
	TSE60
	SS60
	NEM60
	TS60

DRAWING:C:DG\NEW-R\T\307\00).DWG

IMPORTANT THIS DRAWING FOR REFERENCE ONLY 注意：此圖只供參考用

SCHURTER
ELECTRONIC COMPONENTS

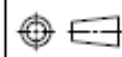

DRAWN BY

UNIT
mm
研發
95.05.09
黃靜芳

UNIT QTY
1
APPROVED BY

SCALE
1:1
RD
95.05.10
李耀魁

TOLERANCE
X.XX±0.1
XX.XX±0.2
XXX.XX±0.3

ID NO
060510A04

DESCRIPTION

PRODUCT NO.
4719.0100
INTERIM NO.
NEW NO.
REV
E

X-ON Electronics

Largest Supplier of Electrical and Electronic Components

Click to view similar products for [schurter](#) manufacturer:

Other Similar products are found below :

[4420.0380](#) [4310.0028](#) [0034.7115](#) [0040.1102](#) [0001.1007.PT](#) [0034.3406](#) [0034.9889](#) [7040.3140](#) [FMAC-0934-3610](#) [FMAD-0931-0810](#) [FMBD-B92B-2512](#) [FMW-65-0005](#) [1241.3663](#) [1241.2506](#) [1301.9211](#) [DC11.0001.301](#) [9632.5100](#) [FMBC-0994-1000](#) [3-101-015](#) [4400.0344](#)
[4420.0361](#) [4752.4000](#) [5500.2605.01](#) [3404.2330.11](#) [3405.0176.11](#) [KD13.1101.105](#) [4303.1061](#) [4420.0210](#) [4430.1129](#) [4430.1892](#) [DKIP-0229-1005](#) [091132B](#) [5500.2267](#) [6162.0083](#) [8020.5081](#) [5120.1006.0.21](#) [5130.2101](#) [CD24.4101.151](#) [CD44.4199.151](#) [AS168X-CB2H030](#)
[6136.0137.0210](#) [FMBC-A91C-1610](#) [FMAC-0932-2510](#) [1068.1012.1110001](#) [GSP1.8101.1](#) [TA35-CFTBLJ04C0](#) [1241.2903.002](#)
[1241.6623.1124000](#) [1241.3008](#) [0001.2535](#)