

1

2

3

4

5

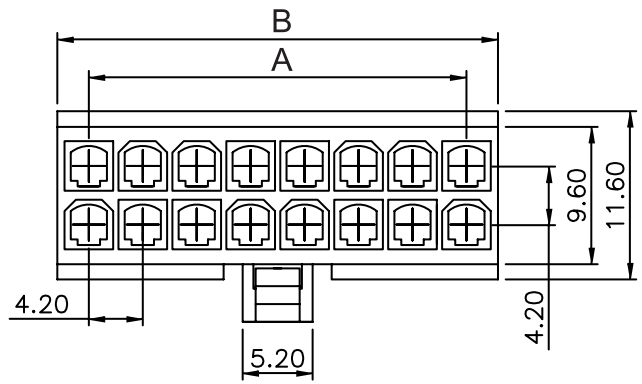
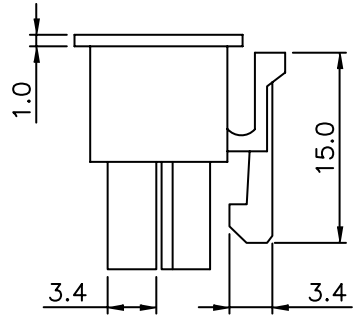
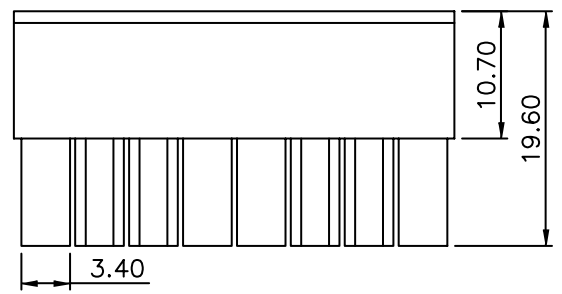
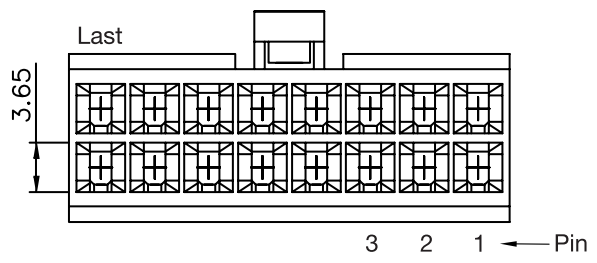

TECHNICAL CHARACTERISTICS

MATERIAL
 INSULATOR: NYLON 66
 FLAMABILITY RATING: UL94-V0
 COLOR: WHITE
 PITCH: 4.20MM

ENVIRONMENTAL
 OPERATING TEMPERATURE: -40 UP TO 105°C
 COMPLIANCE: LEAD FREE AND ROHS

ELECTRICAL
 CURRENT RATING: 6 TO 9A

| | | | | |
|---------------|-------|-------|--------|-------|
| NB CIRCUITS □ | 2-3 □ | 4-6 □ | 7-10 □ | 12-24 |
| AMPERES □ | 9 □ | 8 □ | 7 □ | 6 |

WORKING VOLTAGE: 600V AC
 INSULATOR RESISTANCE: >1000 MOHM
 DIELECTRIC WITHSTANDING VOLTAGE: 1500V AC/MN

STANDARD
 CERTIFIED: E323964 / MODEL NUMBER 649-1133

PACKAGING
 BAG

DIMENSION
 A = 4.20 x (NB. PIN / 2 - 1)
 B = 4.20 x (NB. PIN / 2) + 1.20

RoHS Compliant

| | | | |
|-----|-------------|-------------------|----|
| G | | | |
| F | 18-NOV-09 | STANDARD | JP |
| E | 24-JUN-09 | BAG PACKAGING | JP |
| D | 23-AVR-09 | PACKAGING | JC |
| C | 12-NOV-08 | UL 94-V0 & PINING | JP |
| B □ | 20-MAR-07 □ | DRAW □ □ | EC |
| A □ | □ □ | LEAD FREE □ | JP |
| REV | DATE | FILE | BY |

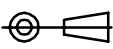
PROJECTION:

APPROVAL: RJ

GENERAL TOLERANCE
 .X = +/- 0.2
 .XX = +/- 0.15

UNIT: MM
 SCALE:
 SHEET: 1/2
 DRAW: PEARL



DESCRIPTION: 4.20MM FEMALE DUAL ROW RECEPTACLE
 WERI PART NO: 649 0xx 113 322

SIZE
A4

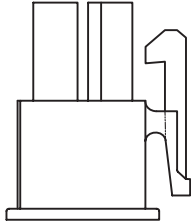
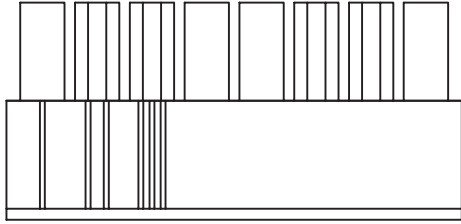
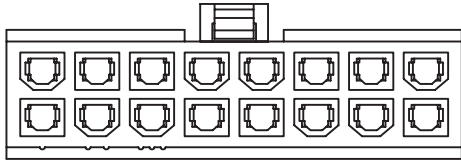

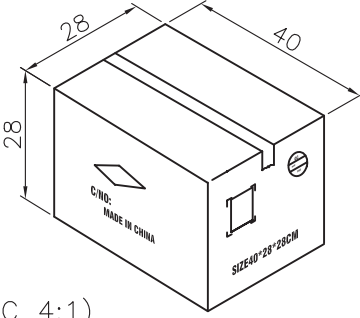
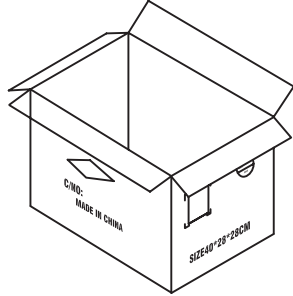
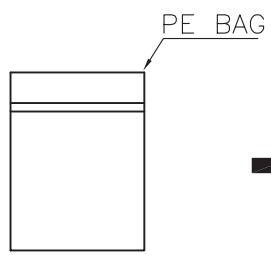

Note:
 1.Dimension:
 Carton Size:40*28*28(cm)
 2.Quantity:

| Pin. | Pcs/Bag | Pcs/Carton | Pin. | Pcs/Bag | Pcs/Carton |
|------|---------|------------|------|---------|------------|
| 2 | 1000 | 13000 | 14 | 500 | 2000 |
| 4 | 1000 | 8000 | 16 | 500 | 1500 |
| 6 | 1000 | 5000 | 18 | 500 | 1500 |
| 8 | 1000 | 4000 | 20 | 300 | 1200 |
| 10 | 500 | 3500 | 22 | 300 | 1200 |
| 12 | 500 | 3000 | 24 | 300 | 900 |

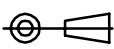

Carton (SC 4:1)

| | | | | | | |
|----------------|------|------|----|--|---|--|
| RoHS Compliant | | | | PROJECTION:  | GENERAL TOLERANCE .X = +/- 0.2 .XX = +/- 0.15 |  |
| G | | | | | | |
| F | | | | | | |
| E | | | | | | |
| D | | | | APPROVAL: RJ | UNIT: MM | DESCRIPTION: 4.20MM FEMALE DUAL ROW RECEPTACLE WERI PART NO: 6490 xx 113322_TPK |
| C | | | | | SCALE: | |
| B | | | | | SHEET: 2/2 | |
| A | | | | | DRAW: PEARL | |
| REV | DATE | FILE | BY | | | SIZE A4 |

X-ON Electronics

Largest Supplier of Electrical and Electronic Components

Click to view similar products for [wurth manufacturer](#):

Other Similar products are found below :

[687001](#) [744741101](#) [750314624](#) [750341638](#) [31402](#) [686626050001](#) [744741471](#) [744772681](#) [744777](#) [749119950](#) [750312504](#) [890334025009](#)
[IC-744885](#) [875115350002](#) [865230143004](#) [600690282801](#) [178050601](#) [615008138221](#) [750311898](#) [744999](#) [7446823003](#) [7446323004](#) [744028](#)
[66201621822](#) [7446221012](#) [744720](#) [760895431](#) [760895651](#) [662006236022](#) [64900621822](#) [418117270910](#) [890334026014](#) [744839208072](#)
[744762A/RFI](#) [74651174R](#) [744838180160](#) [885300](#) [750310346](#) [861011384014](#) [750817018](#) [33008](#) [3020903](#) [885342](#) [2603019321001](#)
[2603019021001](#) [2606039021001](#) [2608019324001](#) [2607019213001](#) [2605039241001](#) [2605049281001](#)