

60x60x15 mm

SUNON

MagLev Motor Fan

15~21 CFM



Model	P/N	Bearing ● VAPO ⊙ 2BALL	Rating Voltage (VDC)	Power Current (AMP)	Power Consumption (WATTS)	Speed (RPM)	Air Flow (CFM)	Static Pressure (Inch-H ₂ O)	Noise (dBA)	Weight (g)
KDE0506PHV2	MS.A.GN	●	5	0.18	0.9	3800	18	0.14	31	44
KDE0506PHV3	MS.A.GN	●	5	0.10	0.5	3000	15	0.12	25	44
KDE1206PHV1	MS.A.GN	●	12	0.13	1.6	4300	21	0.18	36	42
KDE1206PHV2	MS.A.GN	●	12	0.08	1.0	3800	18	0.14	31	42
KDE1206PHV3	MS.A.GN	●	12	0.05	0.6	3000	15	0.12	25	42
KDE2406PHV1	MS.A.GN	●	24	0.077	1.9	4300	21	0.18	36	44
KDE2406PHV2	MS.A.GN	●	24	0.054	1.3	3800	18	0.14	31	44

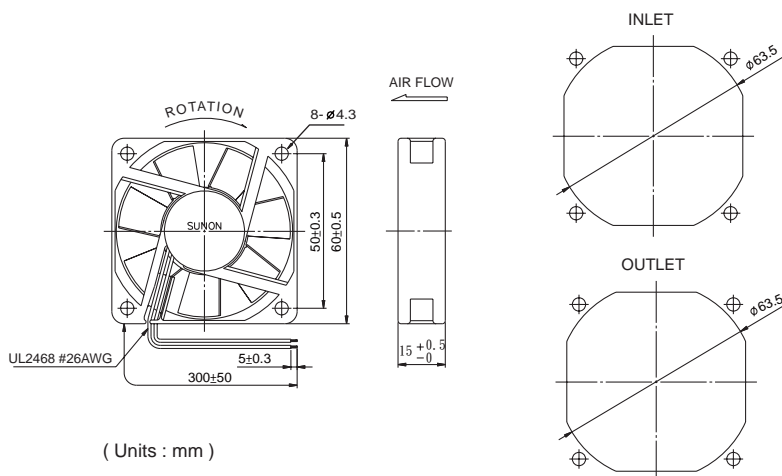
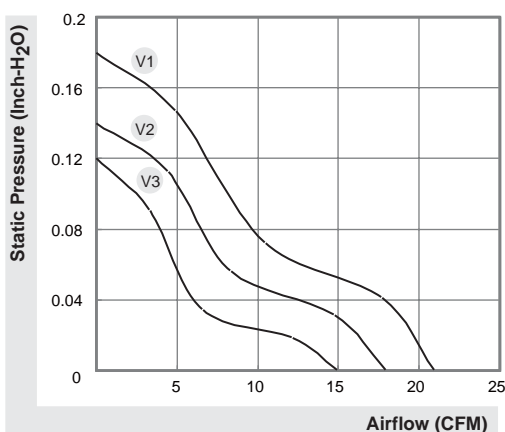

*All model could be customized on voltage or any other requirements to fit your need.

*Specifications subject to change without notice. Please Visit SUNON web site at <http://www.sunon.com> for update information.

Fan 3rd Wire Signal

Fan with switching driving circuit designed for rpm measurement:

These fan motors have three lead wires:

+:Red,

-:Black,

output signal for 3rd wire:

F Type : Yellow

R Type : White

● R Type (Rotation Detector)

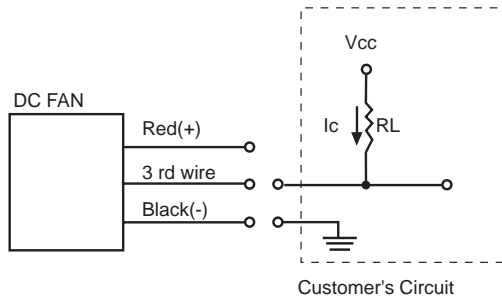
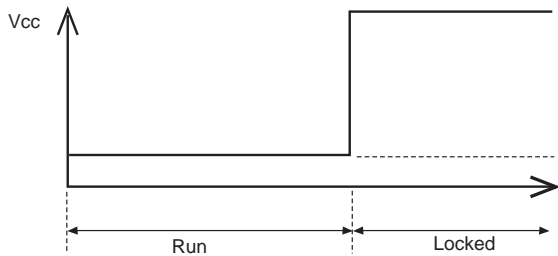

● F Type (Frequency Generator)

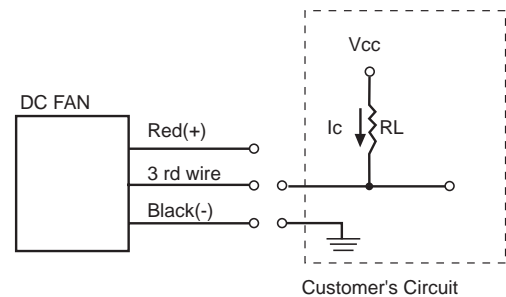
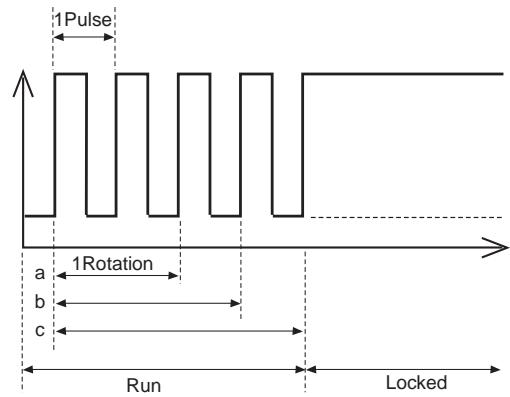

The relationship between rotation & output pulses signal from 3rd wire are as follows:

- (a) 1 Rotation=2 Pulses(4 poles' motor)
- (b) 1 Rotation=3 Pulses(6 poles' motor)
- (c) 1 Rotation=4 Pulses(8 poles' motor)

Notice:

For 8 poles' motor: normally, 1Rotation=4 pulses, if frequency divided circuit is implemented in this motor then 1Rotation=2 pulses.

Safety



DC Fan and Blower Model Numbering System

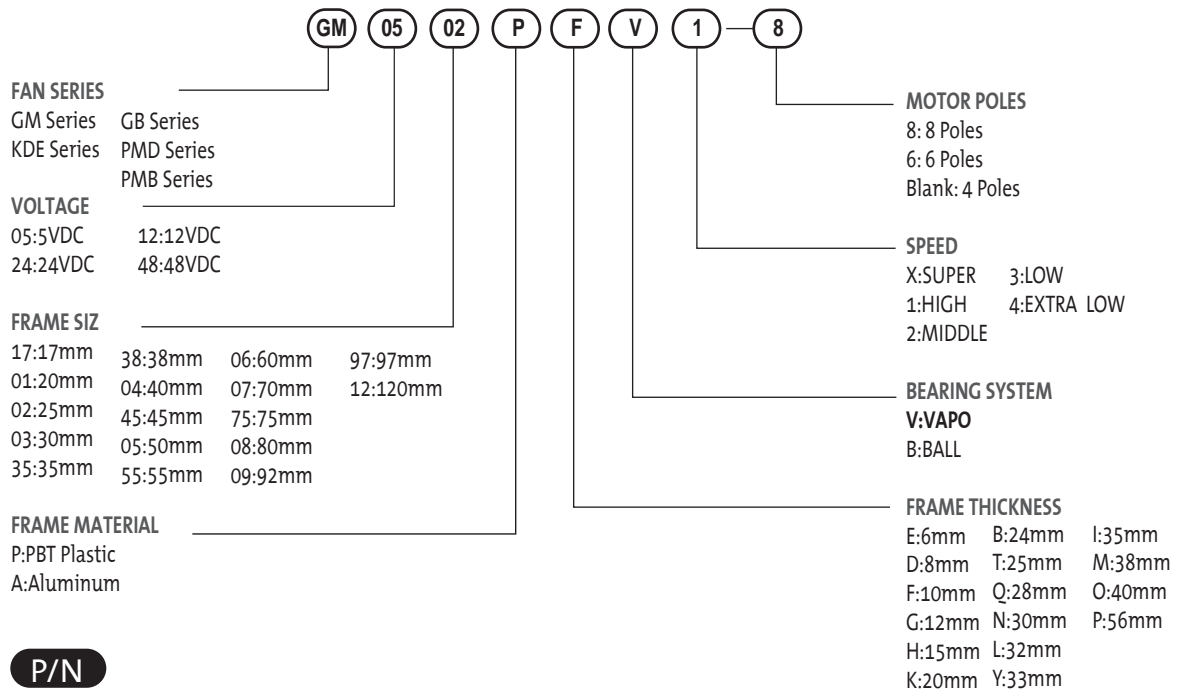

P/N

Example: KDE1208PTV1 P/N:13.MS.A.GN

- 11/13 Motor model
- MS MagLev Design
- (2) Two ball bearing
- G Big hub
- (9) 9 Blades
- N Smaller hub
- A Auto restart
- F 3rd wire with frequency generation waveform
- R 3rd wire with rotation detector waveform
- U Upgrade
- GN RoHS compliance

Sunon Connector recommendation

Connector pitch	Manufacturer	Housing	Terminal
1.25mm	HIROSE	DF13-2S-1.25C	DF13-2630SCF
	MOLEX	51021-0300	50058-8200
1.5mm	JST	ZHR-2	SZH-002T-P0.5 or SZH-003T-P0.5
2.0mm	JST	PHR-2	SPH-002T-P0.5S
2.54mm	ECI	2510-02	2511-P
	Molex	50-57-9405	16-02-0069(70058-0004) or 16-02-0082(70058-0006)
	Molex	2695-02RP	2759T(39-00-0372)
	Molex	2695-03RP	2759T(39-00-0372)
	Molex	6471-021	4809-C-P914
2.50mm	Molex	6471-031	4809-C-P914
	JAM	SC25-02HG	725462-2MA
	JST	SMR-02V-B	SYM-001T-P0.6
	JST	XHP-2	SXH-001T-0.6
	JST	EHR-2(H28J-2)	SEH-001T-P0.6
	JST	SMP-02V-BC	SHF-001T-0.8BS
	JWT	A2502H02-2P	A2502TOP-2
	JWT	A2502H02-3P	A2502TOP-2
	Molex	5051-02	2759T(39-00-0372)
Molex	5264-02	5263PBT(08-70-1039)	

X-ON Electronics

Largest Supplier of Electrical and Electronic Components

Click to view similar products for [sunon](#) manufacturer:

Other Similar products are found below :

[MB50151V2-000U-A99](#) [3113HQ/MC40101V2-Q00U-S99](#) [UF3A3-700](#) [UB3H3-500](#) [PMB2475PNB3-AY.\(2\).GN](#) [KD1208PHB1.13.\(2\).GN](#)
[KD1204PKB3 \(2\).GN](#) [GB1205PKV2-8AY.F.GN](#) [EE60251B1-000U-C99](#) [3236HQ/PF40281B1-D17U-S99](#) [A2175HBT-TC.R.GN](#) [B2-10](#)
[SM203-13002](#) [PE80254V1-000U-A99](#) [GE80252B1-000U-AC9](#) [PF92251V1-1000U-A99](#) [ME80201V2-000U-A99](#) [PE92252B1-000C-AB9](#)
[MC30101V2-000C-A99\(165mm\)](#) [MF20100V4-1Q04C-G99](#) [PE92254B2-000C-F99](#) [MC30150V1-000C-A99](#) [PE80252B1-000C-AB9](#)
[MF20060V3-1Q07A-G99](#) [MC25100V2-000C-G99](#) [PMD2412PMB1-A\(2\).R.GN.I55](#) [AB1123-HST.GN](#) [PF80381BX-000U-A99](#) [MF25100V1-](#)
[1000U-A99](#) [PF80251V1-1000U-F99](#) [PF92381B1-000U-A99](#) [VF40281BX-000U-A9H](#) [LA004-024A83DY](#) [SM203-14001Y](#) [EE60251B2-](#)
[000U-999](#) [SM203-13004Y](#) [SM205-13001](#) [F92-B](#) [FG-8/45](#) [LA004-011A99DN](#) [SF11592A-1092HSL.GN](#) [CF4113HBL-000U-ABD](#)
[MF20100V1-1000U-A99](#) [DP203A-2123LBL.\(5\).GN](#) [PF40281B3-000U-A99](#) [MF30060V1-1000U-G99](#) [MC20100V3-Q00C-G99](#)
[MEC0382V1-000U-A99](#) [PB-08](#) [SM203-14002Y](#)