

Kingbright®

3.5x2.8mm SURFACE MOUNT LED LAMPS

KA-3528

KAA-3528

Features

- SINGLE COLOR AND BI-COLOR SMT LED.
- BOTH CHIPS CAN BE CONTROLLED SEPARATELY.
- SUITABLE FOR ALL SMT ASSEMBLY AND SOLDER PROCESS.
- AVAILABLE ON TAPE AND REEL.
- IDEAL FOR BACKLIGHTING.

Description

The Super Bright Green source color devices are made with Gallium Phosphide Green Light Emitting Diode.

The High Efficiency Red source color devices are made with Gallium Arsenide Phosphide on Gallium Phosphide Orange Light Emitting Diode.

The Yellow source color devices are made with Gallium Arsenide Phosphide on Gallium Phosphide Yellow Light Emitting Diode.

The Super Bright Red source color devices are made with Gallium Aluminum Arsenide Red Light Emitting Diode.

The Super Bright Yellow source color devices are made with DH InGaAlP on GaAs substrate Light Emitting Diode.

The Blue source color devices are made with GaN on SiC Light Emitting Diode.

Static electricity and surge damage the LEDs. It is recommended to use a wrist band or anti-electrostatic or anti-electrostatic glove when handling the LEDs.

All devices, equipment and machinery must be electrically grounded.

Package Dimensions

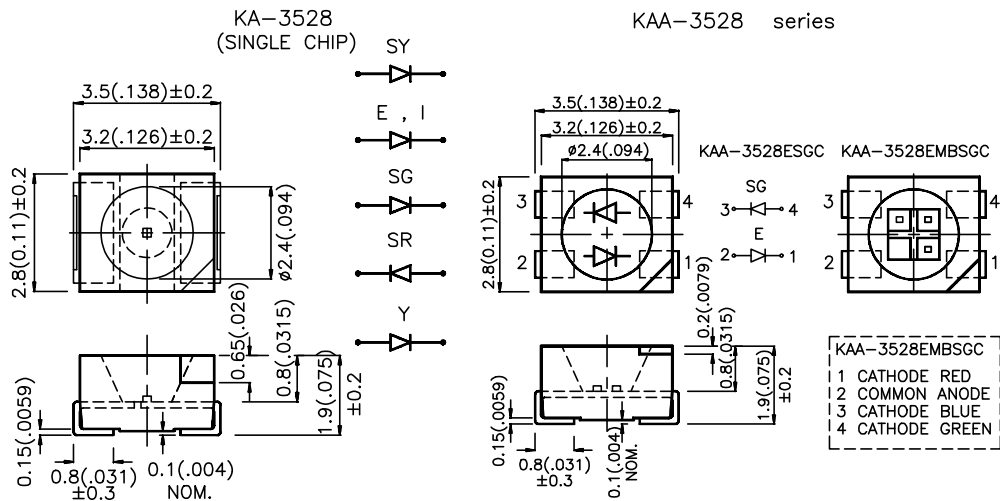

- Notes:
1. All dimensions are in millimeters (inches).
 2. Tolerance is $\pm 0.25(0.01)$ unless otherwise noted.
 3. Lead spacing is measured where the lead emerge package.
 4. Specifications are subjected to change without notice.

Selection Guide

Part No.	Dice	Lens Type	Iv (mcd) @ 20 mA		Viewing Angle
			Min.	Max.	$\theta_{1/2}$
KA-3528IT	HIGH EFFICIENCY RED (GaAsP/GaP)	RED TRANSPARENT	12.5	40	120°
KA-3528EC	HIGH EFFICIENCY RED (GaAsP/GaP)	WATER CLEAR	12.5	40	120°
KA-3528YT	YELLOW (GaAsP/GaP)	YELLOW TRANS.	8	20	120°
KA-3528YC	YELLOW (GaAsP/GaP)	WATER CLEAR	8	20	120°
KA-3528SRT	SUPER BRIGHT RED (GaAlAs)	RED TRANSPARENT	70	300	120°
KA-3528SRC	SUPER BRIGHT RED (GaAlAs)	WATER CLEAR	70	300	120°
KA-3528SGT	SUPER BRIGHT GREEN (GaP)	GREEN TRANSPARENT	12.5	40	120°
KA-3528SGC	SUPER BRIGHT GREEN (GaP)	WATER CLEAR	12.5	40	120°
KA-3528SYT	SUPER BRIGHT YELLOW (InGaAlP)	YELLOW TRANSPARENT	12.5	40	120°
KA-3528SYC	SUPER BRIGHT YELLOW (InGaAlP)	WATER CLEAR	12.5	40	120°
KAA-3528ESGC	HIGH EFFICIENCY RED (GaAsP/GaP)	WATER CLEAR	12.5	40	120°
	SUPER BRIGHT GREEN (GaP)		12.5	40	
KAA-3528EMBSGC	HIGH EFFICIENCY RED (GaAsP/GaP)	WATER CLEAR	12.5	40	120°
	SUPER BRIGHT GREEN (GaP)		12.5	40	
	BLUE (GaN)		2	8	

Notes:

1. $\theta_{1/2}$ is the angle from optical centerline where the luminous intensity is 1/2 the optical centerline value.

Electrical / Optical Characteristics at T_A=25°C

Symbol	Parameter	Device	Typ.	Max.	Units	Test Conditions
λ_{peak}	Peak Wavelength	High Efficiency Red Yellow Super Bright Red Super Bright Green Super Bright Yellow	625 590 660 565 595		nm	IF=20mA
$\Delta\lambda_{1/2}$	Spectral Line Halfwidth	High Efficiency Red Yellow Super Bright Red Super Bright Green Super Bright Yellow	45 35 20 30 20		nm	IF=20mA
C	Capacitance	High Efficiency Red Yellow Super Bright Red Super Bright Green Super Bright Yellow	12 10 95 45 33		pF	VF=0V;f=1MHz
V _F	Forward Voltage	High Efficiency Red Yellow Super Bright Red Super Bright Green Super Bright Yellow	2.0 2.1 1.85 2.2 2.0	2.5 2.5 2.5 2.5 2.4	V	IF=20mA
I _R	Reverse Current	All	10		uA	VR = 5V

Absolute Maximum Ratings at $T_A=25^\circ\text{C}$

Parameter	High Efficiency Red	Yellow	Super Bright Red	Super Bright Green	Super Bright Yellow	Units
Power dissipation	105	105	100	105	125	mW
DC Forward Current	30	30	30	25	30	mA
Peak Forward Current [1]	150	150	150	150	150	mA
Reverse Voltage	5	5	5	5	5	V
Operating/Storage Temperature	-40 °C To +85 °C					

Note:

1. 1/10 Duty Cycle, 0.1ms Pulse Width .

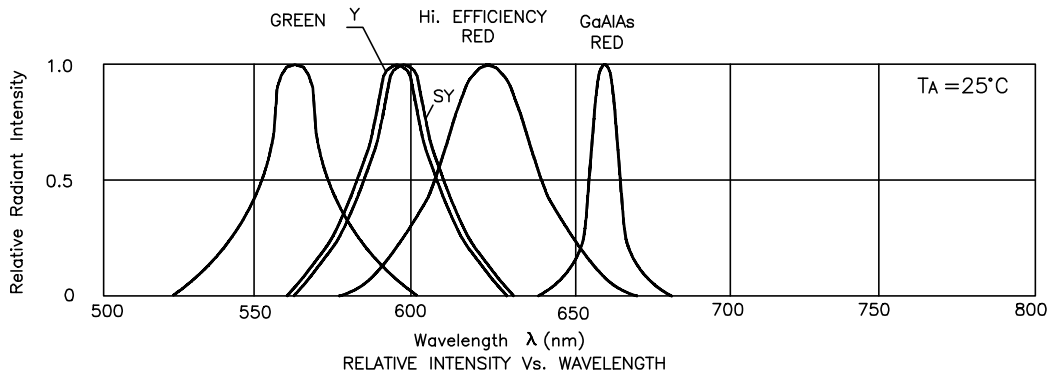

High Efficiency Red KA-3528EC, KA-3528IT

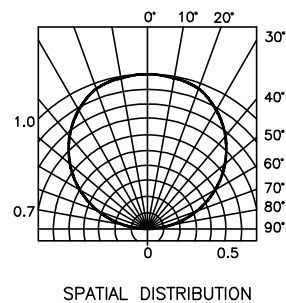
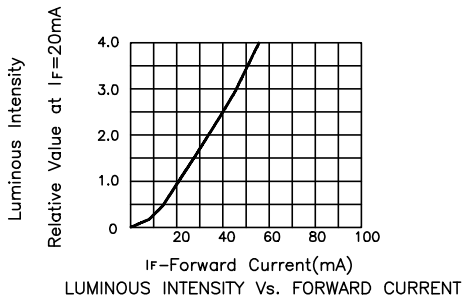
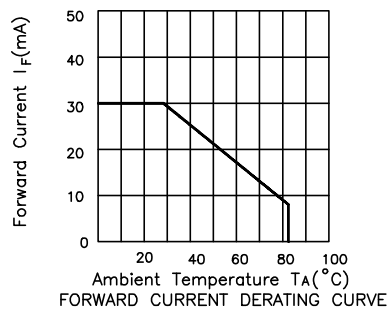
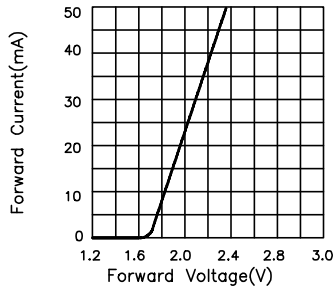

Yellow KA-3528YC , KA-3528YT

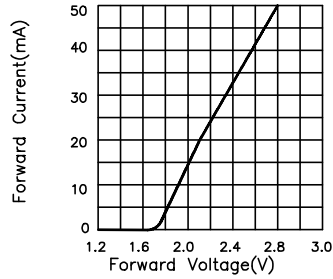

FORWARD CURRENT Vs. FORWARD VOLTAGE

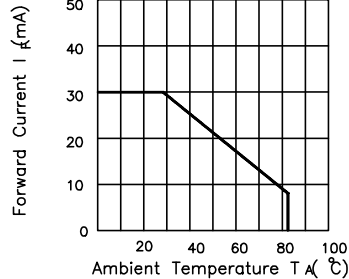

FORWARD CURRENT DERATING CURVE

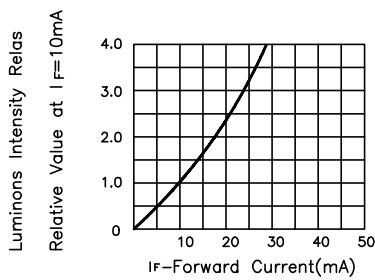

LUMINOUS INTENSITY Vs. FORWARD CURRENT

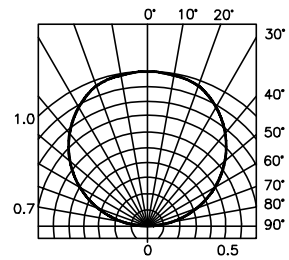

SPATIAL DISTRIBUTION

Super Bright Red KA-3528SRC , KA-3528SRT

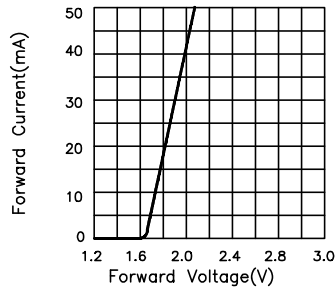

FORWARD CURRENT Vs. FORWARD VOLTAGE

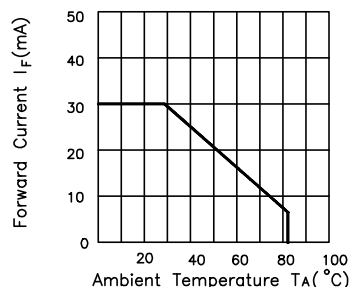

FORWARD CURRENT DERATING CURVE

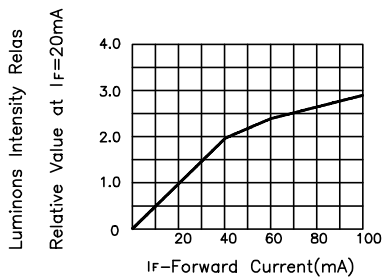

LUMINOUS INTENSITY Vs. FORWARD CURRENT

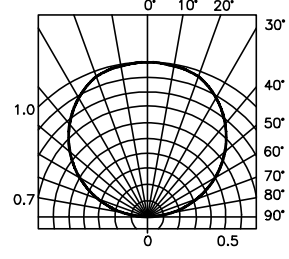

SPATIAL DISTRIBUTION

Super Bright Green KA-3528SGC, KA-3528SGT

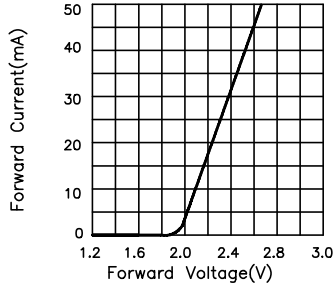

FORWARD CURRENT Vs. FORWARD VOLTAGE

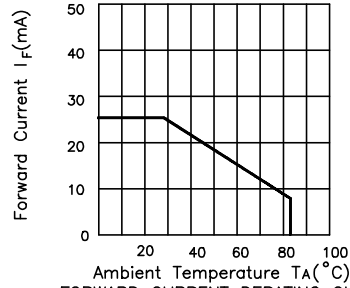

FORWARD CURRENT DERATING CURVE

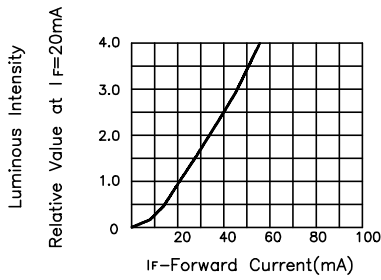

LUMINOUS INTENSITY Vs. FORWARD CURRENT

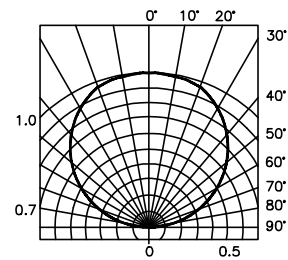

SPATIAL DISTRIBUTION

Super Bright Yellow KA-3528SYC, KA-3528SYT

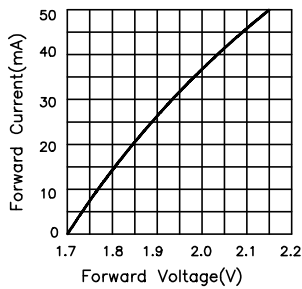

FORWARD CURRENT Vs. FORWARD VOLTAGE

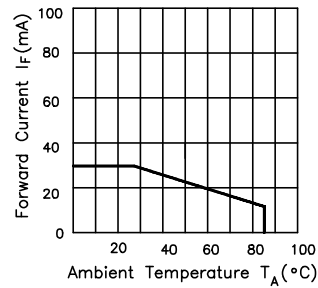

FORWARD CURRENT DERATING CURVE

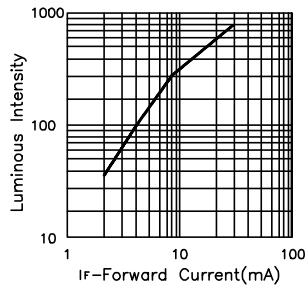

LUMINOUS INTENSITY Vs. FORWARD CURRENT

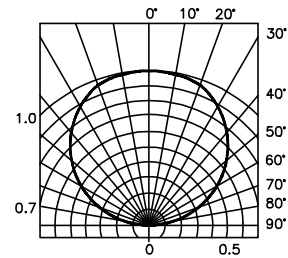

SPATIAL DISTRIBUTION

High Efficiency Red / Super Bright Green KAA-3528ESGC

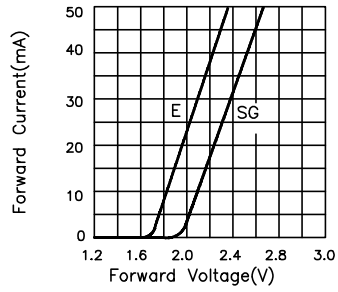

FORWARD CURRENT Vs. FORWARD VOLTAGE

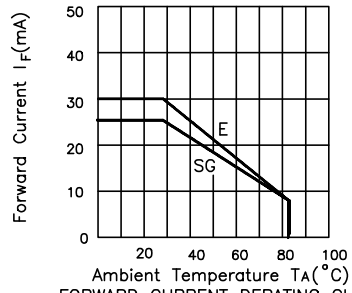

FORWARD CURRENT DERATING CURVE

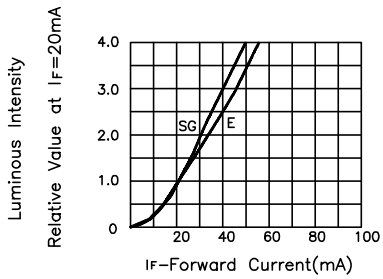

LUMINOUS INTENSITY Vs. FORWARD CURRENT

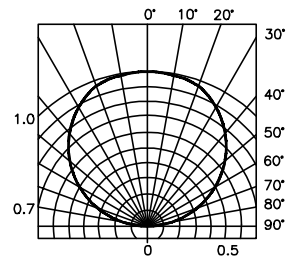

SPATIAL DISTRIBUTION

KAA-3528EMBSGC
High Efficiency Red / Super Bright Green

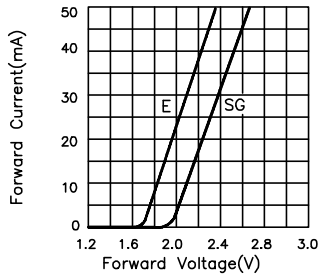

FORWARD CURRENT Vs. FORWARD VOLTAGE

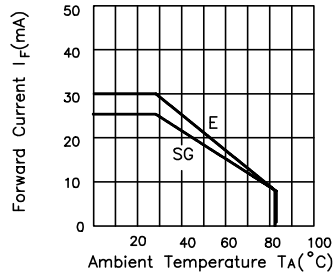

FORWARD CURRENT DERATING CURVE

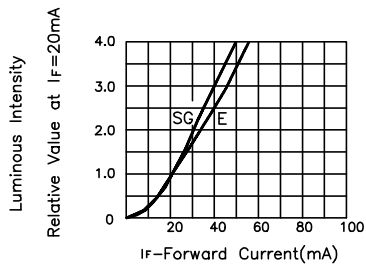

LUMINOUS INTENSITY Vs. FORWARD CURRENT

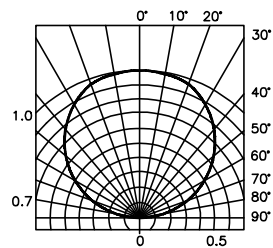

SPATIAL DISTRIBUTION

Blue

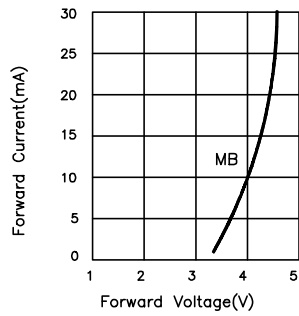

FORWARD CURRENT Vs. FORWARD VOLTAGE

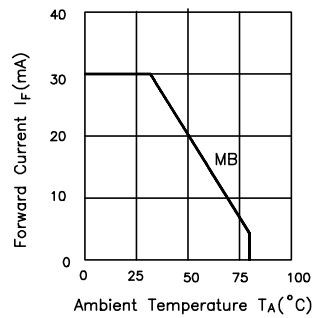

FORWARD CURRENT DERATING CURVE

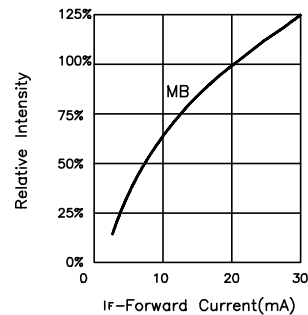

RELATIVE INTENSITY Vs. FORWARD CURRENT

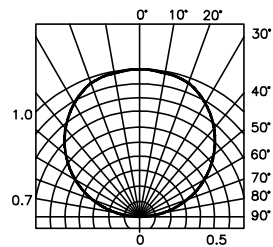

SPATIAL DISTRIBUTION

KA-3528 , KAA-3528 Series SMT Reflow Soldering Instructions

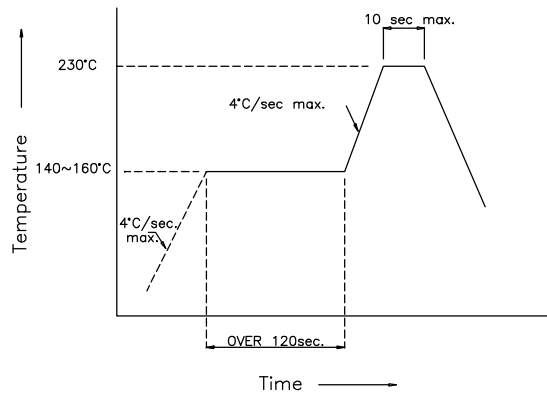

KA-3528 , KAA-3528 Series Recommended Soldering Pattern (Units : mm)

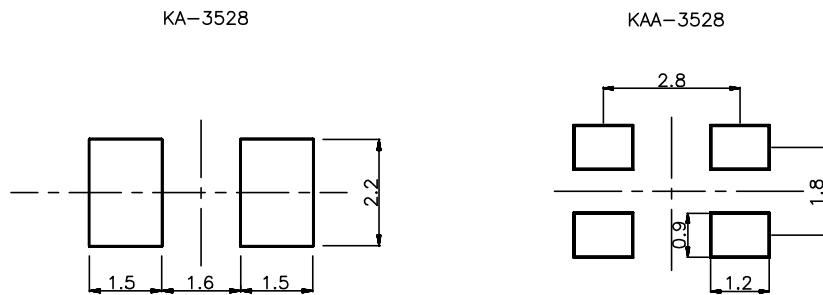

KA-3528 , KAA-3528 Series Tape Specifications
 (Units : mm)

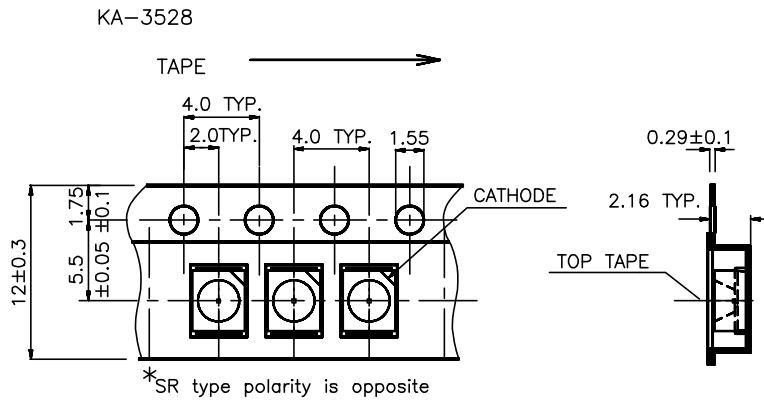

KAA-3528ESGC
 KAA-3528EMBSCG

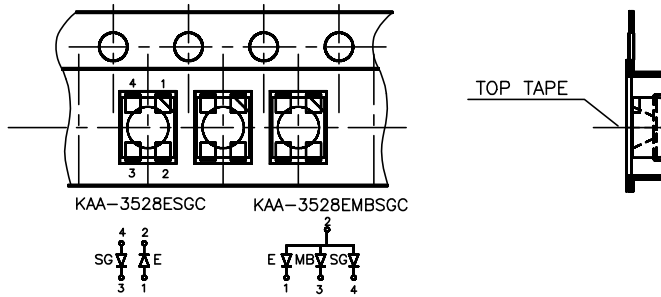

X-ON Electronics

Largest Supplier of Electrical and Electronic Components

Click to view similar products for [kingbright](#) manufacturer:

Other Similar products are found below :

[BR-8.24](#) [L-934EW/1GD](#) [AA4040PGS](#) [CC04-41SRWA](#) [PSA05-11GWA](#) [BC04-11SYKWA](#) [KB-2600ID](#) [L53YC13](#) [SA40-19GWA](#) [CC56-21SRWA](#) [WP4060VH/2ID](#) [DC10GWA](#) [DC-05YWA](#) [KA-3535SELZ4S](#) [KB-2755SYKW](#) [SA56-11GWA](#) [DE2CGKD](#) [AA4040SF4S-P22](#)
[BR9.52](#) [L-1384AL/1ID](#) [SA15-11PBWA-A](#) [KB-2855SGW](#) [BA56-11SYKWA](#) [ACSA03-41EWA-F01](#) [L-59GYC](#) [WP7113SF4BT-P22](#) [SA03-11PBWA/A](#) [SC40-19EWA](#) [DA03-11GWA](#) [L-934EB/2ID](#) [WP132WUM/EGW](#) [WP1503CB/GD](#) [WP1384AD/GD](#) [AA3528AVUACGSK](#) [L-964ID](#) [KPBD-3224SURKCGKC](#) [WP1533BQ/GD](#) [SA08-11SURKWA](#) [AM2520SYCK09](#) [L-138A8QMP/1ID](#) [SA23-12EWA](#) [WP934MD/2ID](#)
[KPHBM-2012ETSGTC](#) [KPTR-3216SGC](#) [WP4060VH/2GD](#) [PDC54-12SRWA](#) [WP53MGD](#) [DLC-6MBD](#) [SC18-11EWA](#) [SC40-18EWA](#)