

Control and Signaling Diameter 22mm **XB5 / ZB5**

Catalog
February
2004

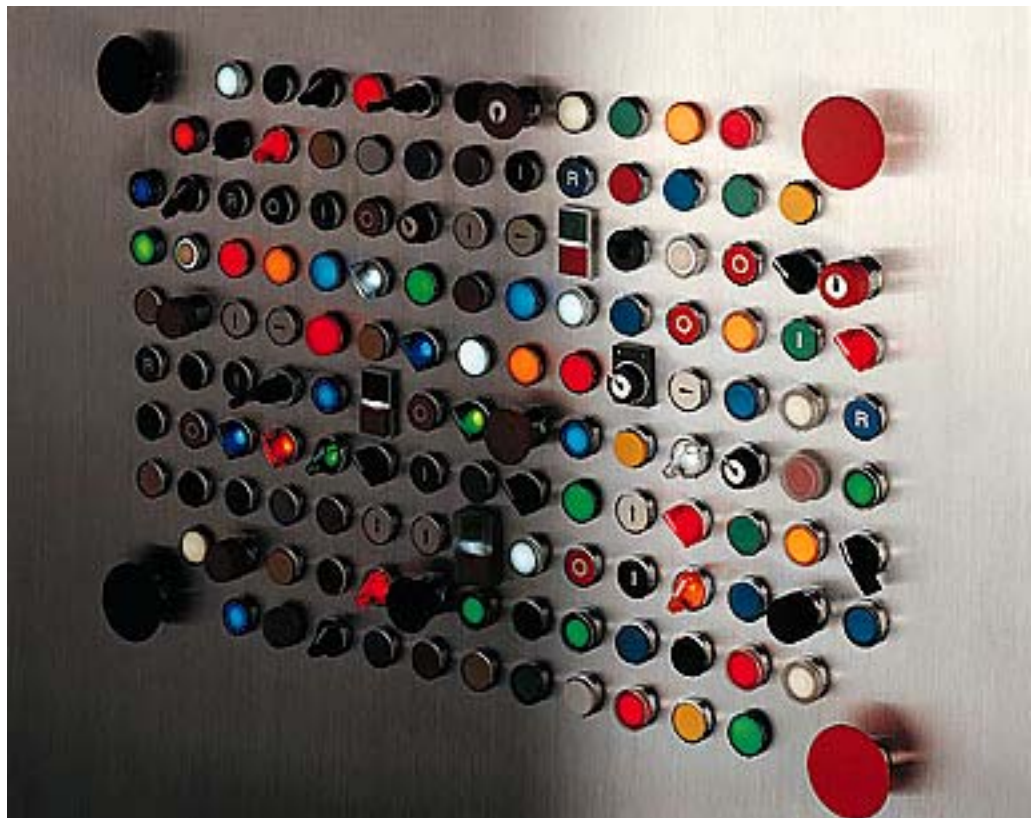

Harmony® style 5

Pushbuttons, switches and pilot lights with double insulated bezel

Complete units, XB5 A

Complete units

Contact functions

Pushbuttons, spring return

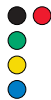

Flush push

XB5 AA*1/AA42
see page 36012/2

XB5 AA3311/AA33*1
see page 36012/2

XB5 AA4322
see page 36012/2

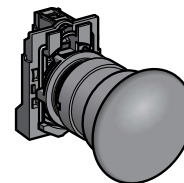

Booted flush push

XB5 AP*1/AP42
see page 36012/2

Projecting push

XB5 AL42
see page 36012/2

Mushroom head

XB5 AC21
see page 36012/2

Double-headed pushbuttons, spring return

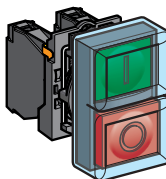
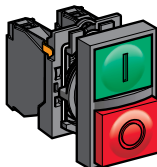

Flush push + projecting push

XB5 AL845
see page 36012/2

Booted flush push + projecting push

XB5 AL945
see page 36012/2

Ø 40 Emergency stop mushroom head pushbuttons with or without trigger action

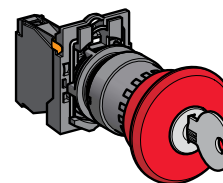
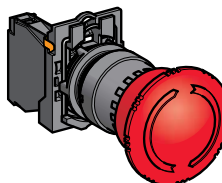
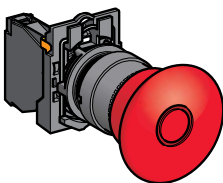

Push-pull

XB5 AT42/AT845
see page 36012/3

Turn to release

XB5 AS542/AS8445
see page 36012/3

Key release

XB5 AS142/AS9445
see page 36012/3

Selector switches and key switches

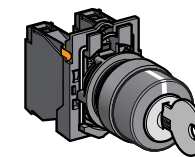

Standard black handle

XB5 AD
see page 36012/3

Long black handle

XB5 AJ
see page 36012/3

Key switch

XB5 AG
see page 36012/3

Harmony® style 5

Pushbuttons, switches and pilot lights with double insulated bezel

Complete units, XB5 A

Complete units

(continued)

Pilot lights

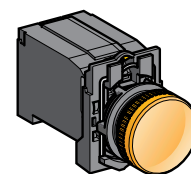
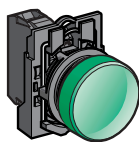

With integral LED

XB5 AVB/AVG/AVM
see page 36013/2

For BA 9s bulb
Direct supply

XB5 AV
see page 36013/3

Via integral transformer

XB5 AV3/AV4
see page 36013/3

Combined functions (contact + signalling)

Illuminated pushbuttons, spring return, flush push

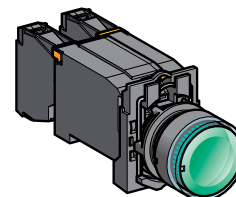

With integral LED

XB5 AW3•B6/AW3•G5/AW3•M5
see page 36014/2

For BA 9s bulb
Direct supply

XB5 AW3•65
see page 36014/2

Via integral transformer

XB5 AW3•35/AW3•45
see page 36014/2

Double-headed pushbuttons, spring return, with pilot light

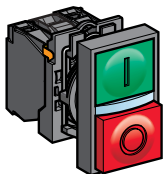

With integral LED

XB5 AW84•5
see page 36014/3

Illuminated selector switches, standard handle

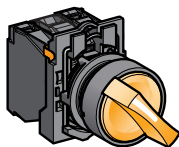

With integral LED

XB5 AK12•B5/AK12•G5/BK12•M5
see page 36014/3

Harmony® style 5

Pushbuttons, switches and pilot lights with double insulated bezel

Sub-assemblies, ZB5 A

Non illuminated units for user assembly

For pushbuttons, spring return, without marking

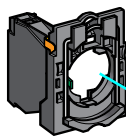

Screw clamp terminals
ZB5 AZ10/AZ141
see page 36015/2

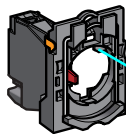

Plug-in connector
ZB5 AZ10/AZ1414
see page 36015/2

For pushbuttons, spring return, with marking

For "push-turn to release" pushbuttons

For double-headed pushbuttons, spring return

For "push-push to release" pushbuttons

Contact functions

Body sub-assemblies

Head sub-assemblies

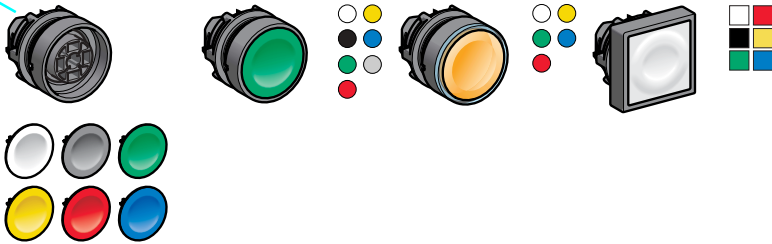

Flush push with cap mounted or not mounted

ZB5 AA0/AA9
see page 36015/3

ZB5 AA●
see page 36015/3

Flush push for insertion of legend

ZB5 AA●8
see page 36015/3

Flush push

ZB5 CA●
see page 36015/5



Projecting push

ZB5 AL●
see page 36015/3

Recessed push

ZB5 AA●
see page 36015/3

Booted flush push

ZB5 AP●/AP●8
see page 36015/3

Projecting push

ZB5 CL●
see page 36015/3



Flush push

ZB5 AA●3/AA●4●
see page 36015/4

Projecting push

ZB5 AL
see page 36015/4

Flush push

ZB5 CA●3/CA●9
see page 36015/4

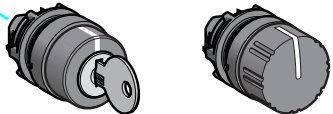

Key switch

ZB5 AFD
see page 36015/4

Knurled knob (1)

ZB5 AF
see page 36015/4

(1) Knob positions

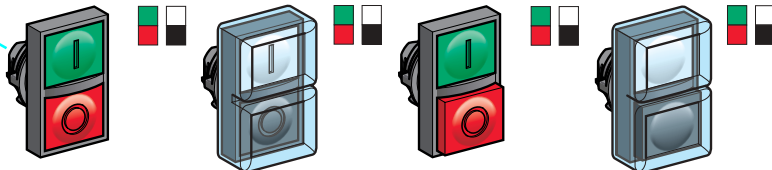
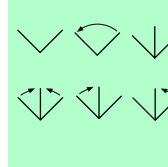

Flush pushes (IP 40/IP 66)
Without/with marking

ZB5 AA81/AA82
see page 36015/5

ZB5 AA91/AA92
see page 36015/5

Flush push + projecting push (IP 40/IP 66)
Without/with marking

ZB5 AL83/AL84
see page 36015/5

ZB5 AL93/AL94
see page 36015/5

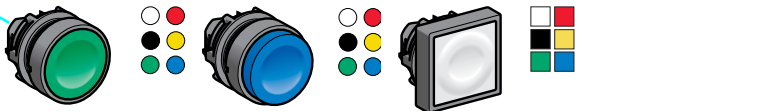

Flush push

ZB5 AH0/CH0
see page 36015/5

Projecting push

ZB5 AH●
see page 36015/5

Flush push

ZB5 CH●
see page 36015/5

Harmony® style 5

Pushbuttons, switches and pilot lights with double insulated bezel

Sub-assemblies, ZB5 A

Non illuminated units for user assembly

(continued)

Contact functions (continued)

For mushroom head pushbuttons, spring return

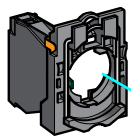

Screw clamp terminals
ZB5 AZ10/AZ141
see page 36015/2

Head sub-assemblies

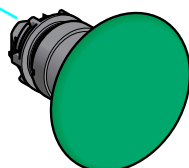

● ●
○ ●
● 30
○ 40
○ 60

Spring return
ZB5 AC/AR
see page 36015/6

For mushroom head pushbuttons, latching, with or without trigger action

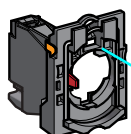

Plug-in connector
ZB5 AZ10/4/AZ1414
see page 36015/2

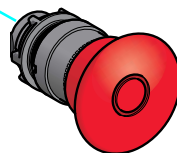

● ●
● ●
○ 30
○ 40
○ 60

Push-pull
ZB5 AT84/AT/AX
see page 36015/7

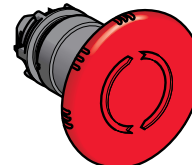

● ●
● ●
○ 30
○ 40
○ 60

Turn to release
ZB5 AS8/4/AS4/ AS5/AS6
see page 36015/7

For selector switches and key switches

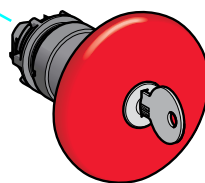

● ●
● ●
○ 30
○ 40
○ 60

Key release
ZB5 AS9/4/AS7/AS1/AS2
see page 36015/7



Standard handle (1)
ZB5 AD
see page 36015/8

Long black handle (1)
ZB5 AJ
see page 36015/9



Knurled black knob (1)
ZB5 AD/9
see page 36015/10

Key switch (2)
ZB5 AG/AG0
see page 36015/11

(1) Switch handle and knob positions

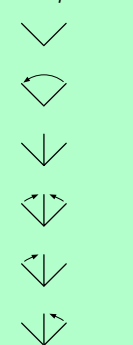

(2) Key switch positions
⌘ Key withdrawal positions

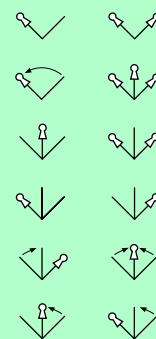

For toggle switches

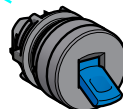

2-position
ZB5 AD/8
see page 36016/11

Pilot lights
 for user assembly

Signalling functions

Body sub-assemblies
 with integral LED

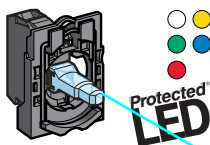

Screw clamp terminals
 ZB5 AVB/AVG/AVM
 see page 36016/2

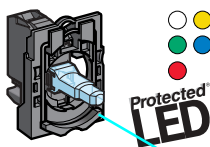

Plug-in connector
 ZB5 AVB4/AVC4/
 AVM4
 see page 36016/2

Head sub-assemblies

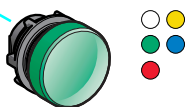

With lens mounted
 ZB5 AV03
 see page 36016/3

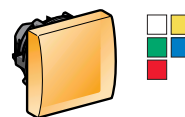

ZB5 CV03
 see page 36016/3



With 5 separate lenses not mounted

ZB5 AV003
 see page 36016/3

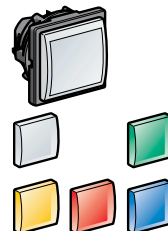

ZB5 CV003
 see page 36016/3

Body sub-assemblies
 for BA 9s bulb

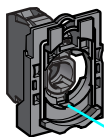

Direct supply
 Screwclamp terminals
 ZB5 AV6
 see page 36016/3

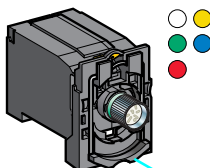

Via integral transformer
 Screw clamp terminals
 ZB5 AV4/AV3D/AV5D
 see page 36016/3

Head sub-assemblies



With lens mounted
 ZB5 AV0
 see page 36016/3

Harmony® style 5

Pushbuttons, switches and pilot lights with double insulated bezel

Sub-assemblies, ZB5 A

Illuminated pushbuttons for user assembly

For illuminated push-buttons, spring return

Body sub-assemblies with integral LED

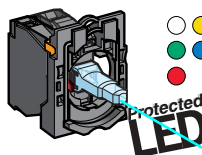

Screw clamp terminals
ZB5 AW0B/AW0G/AW0M see pages 36017/4 and 36025/3

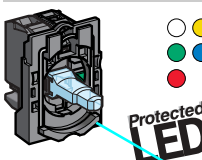

Plug-in connector
ZB5 AW0B/AW0G/AW0M see pages 36017/4 and 36026/3

For double-headed pushbuttons, spring return, with pilot light

For illuminated "push-push to release" push-buttons and illuminated selector switches with standard handle

Body sub-assemblies for BA9s bulb

For illuminated push-buttons, spring return

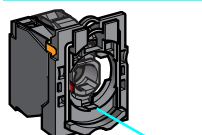

Direct supply
Screw clamp terminals
ZB5 AW0S see page 36017/6

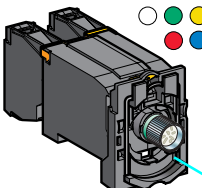

Via integral transformer
Screw clamp terminals
ZB5 AW03/4/5/3D/5D see page 36017/6

Combined functions (contact + signalling)

Head sub-assemblies



Flush push with cap mounted/not mounted
ZB5 AW3/AW9 see page 36017/7

Flush push for insertion of legend
ZB5 AA see page 36017/7

Booted flush push
ZB5 AW5 see page 36017/7

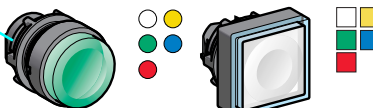

Projecting push
ZB5 AW1/AL see page 36017/7

Flush or projecting push
ZB5 CW3/CW1 see page 36017/7

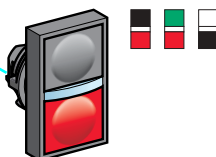

Flush push Without markings
ZB5 AW81 see page 36017/8



ZB5 AW82 see page 36017/8

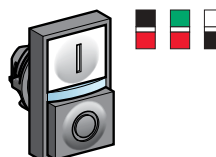

Flush push + projecting push Without markings
ZB5 AW83 see page 36017/8

ZB5 AW84 see page 36017/8

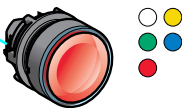

Flush or projecting "push-push to release"
ZB5 AH0/AH3 see page 36017/8



Standard handle operator
ZB5 AK1 see page 36017/9

Head sub-assemblies

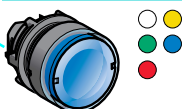

Flush push
ZB5 AW3 see page 36017/7

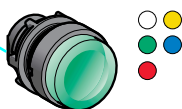

Projecting push
ZB5 AW1 see page 36017/7

Harmony style 3 Pushbuttons, switches and pilot lights with double insulated bezel

Environment			
Protective treatment standard version			"TH"
Ambient air temperature around the device	Storage	°C	- 40...+ 70
	Operation	°C	- 25...+ 70 unless otherwise stated
Electric shock protection	Conforming to IEC 60536		Class II
Degree of protection	Conforming to IEC 60529		IP 65, unless otherwise stated IP 66, for booted pushbutton heads
	Conforming to NEMA		NEMA type 4X and 13, unless otherwise stated
Resistance to high pressure washer		Pa	70 x 10 ⁵ (70 bar); distance: 0.1 m Temperature: 55°C
Mechanical shock protection	Conforming to IEC 50102		Non illuminated heads: IK 03
			Illuminated heads: IK 05
Conforming to standards			IEC/EN 60947-1, IEC/EN 60947-5-1, IEC/EN 60947-5-4, JIS C 4520, UL 508, CSA C22-2 n° 14
Product certifications	UL Listed, CSA		Standard single contact blocks with screw clamp terminals: A600; Q600 Double contact blocks with screw clamp terminals: A600; Q600 Light blocks with screw clamp terminals Joystick controllers XD5 PA/ZD5 PA: A600; R300
	UL Recognized, CSA		Standard single contact blocks for plug-in connector: A300; R300 Standard contact blocks for printed circuit board: B300; R300
	BV, RINA, LROS, DNV, GL (pending)		Standard single and double contact blocks with screw clamp terminals:
Terminal identification	Conforming to EN 50005 and EN 50013		

Characteristics of contact or combined contact and signalling functions			
Mechanical characteristics			
Contact operation	N/C or N/O		Slow break
Positive operation	Conforming to IEC/EN 60947-5-1 appendix K		All functions incorporating a N/C contact are positive opening operation
Operating travel (to change the electrical state)	Pushbutton	mm	Changing N/C state: 1.5 Changing N/O state: 2.6 Total travel: 4.3
Operating force	Pushbutton	N	Changing N/C state: 3.5 Changing N/O state: 3.8
	Additional contact (extra to change state)	N	Single N/C contact: 2 Single N/O contact: 2.3
		N	Double N/C contact: 3.4 Double N/O contact: 5 Double contact N/C + N/O: 4.6
	Emergency stop with N/C + N/O	N	Standard push-pull: 45 Trigger action push-pull: 50
N		Standard turn to release and key release: 40 Trigger action turn to release and key release: 44	

Characteristics of contact or combined contact and signalling functions (continued)

Mechanical characteristics (continued)

Operating torque (to change the electrical state)	Selector switches		N.m	N/O contact: 0.14
	Additional contact (extra)		N.m	N/O contact: 0.05
Mechanical durability (in millions of operating cycles)	Pushbuttons	Spring return		5
		Double-headed		1
		Push-push to release		0.5
	Selector switches	Non illuminated		3
		Illuminated		1
	Toggle switches			0.5
	Emergency stop pushbuttons			0.3
	Joystick controllers			1
	Standard contact blocks only			5
	Low power switching contact blocks only (dust protected)			0.5
Vibration resistance	Conforming to IEC 60068-2-6		gn	Frequency: 2 to 500 Hz: 5
Electric shock resistance	Conforming to IEC 60068-2-27		gn	All functions except mushroom head pushbuttons half sine wave acceleration 11 ms: 50 half sine wave acceleration 18 ms: 30
			gn	Mushroom head pushbutton (half sine wave acceleration 11 ms: 10)
Electrical characteristics				
Cabling capacity	Conforming to IEC 60947-1		mm²	Screw clamp terminals Min: 1 x 0.22 without cable end Max: 2 x 1.5 with cable end Cross headed screw (Pozidrive or Philips type 1), slotted for flat 4 and 5.5 mm screwdriver Tightening torque: 0.8 N.m (max 1.2 N.m)
Contact material	Silver alloy (Ag / Ni)			Standard single and double blocks with screw clamp terminals Blocks for plug-in connector Standard blocks for printed circuit board connection
	Gold flashed (Ag / Ni / Au)			Low power switching contact blocks with screw clamp terminals Low power switching contact blocks for printed circuit board connection
Short-circuit protection	Conforming to IEC/EN 60947-5-1		A	Standard single and double blocks with screw clamp terminals: 10 (gG cartridge fuse conforming to IEC 60269-1) Blocks for plug-in connector: 4 (gG cartridge fuse conforming to IEC 60269-1) Standard blocks for printed circuit board connection: 4 (gG cartridge fuse conforming to IEC 60269-1)
Rated thermal current	Conforming to IEC/EN 60947-5-1		A	Standard single and double blocks with screw clamp terminals: 10 Blocks for plug-in connector: 10 Standard blocks for printed circuit board connection: 6
Rated insulation voltage	Conforming to IEC 60947-1		V	Standard single and double blocks with screw clamp terminals: Ui = 600 degree of pollution 3 Blocks for plug-in connector or Faston connectors: Ui = 250 degree of pollution 3 Standard blocks for printed circuit board connection: Ui = 250 degree of pollution 3
Rated impulse withstand voltage	Conforming to IEC 60947-1		kV	Standard single and double blocks with screw clamp terminals: Uimp = 6 Blocks for plug-in connector: Uimp = 4 Standard blocks for printed circuit board connection: Uimp = 4

Characteristics of contact or combined contact and signalling functions (continued)

Electrical characteristics (continued)

Rated operational characteristics
Conforming to IEC/EN 60947-5-1

a.c. supply:
utilisation category AC-15

Standard single and double blocks with screw clamp terminals:
A600: $U_e = 600\text{ V}$ and $I_e = 1.2\text{ A}$ or $U_e = 240\text{ V}$ and $I_e = 3\text{ A}$ or $U_e = 120\text{ V}$ and $I_e = 6\text{ A}$

Blocks for plug-in connector:
A300: $U_e = 120\text{ V}$ and $I_e = 6\text{ A}$
or $U_e = 240\text{ V}$ and $I_e = 3\text{ A}$

Standard blocks for printed circuit board connection:
B300: $U_e = 120\text{ V}$ and $I_e = 3\text{ A}$
or $U_e = 240\text{ V}$ and $I_e = 1.5\text{ A}$

d.c. supply:
utilisation category DC-13

Standard single and double blocks with screw clamp terminals:
Q600: $U_e = 600\text{ V}$ and $I_e = 0.1\text{ A}$ or $U_e = 250\text{ V}$ and $I_e = 0.27\text{ A}$ or $U_e = 125\text{ V}$ and $I_e = 0.55\text{ A}$

Joystick controllers XD5 PA/ZD5 PA :
R300: $U_e = 125\text{ V}$ and $I_e = 0.22\text{ A}$
or $U_e = 250\text{ V}$ and $I_e = 0.1\text{ A}$

Blocks for plug-in connector:
R300: $U_e = 125\text{ V}$ and $I_e = 0.22\text{ A}$
or $U_e = 250\text{ V}$ and $I_e = 0.1\text{ A}$

Standard blocks for printed circuit board connection:
R300: $U_e = 125\text{ V}$ and $I_e = 0.22\text{ A}$
or $U_e = 250\text{ V}$ and $I_e = 0.1\text{ A}$

Characteristics of special contact blocks for low power switching

**VA
A
V**

P max: 12
I max: 0.1
U max: 24

Electrical durability

Conforming to IEC/EN 60947-5-1 appendix C
Operating rate 3600 operating cycles/hour.
Load factor: 0.5

a.c. supply
for 1 million operating cycles
utilisation category AC-15

**V
A**

Standard single blocks with screw clamp terminals:

24	120	230
4	3	2

**V
A**

Standard double blocks with screw clamp terminals and blocks for plug-in connector:

24	120	230
3	1.5	1

d.c. supply
for 1 million operating cycles
utilisation category DC-13

**V
A**

Standard single blocks with screw clamp terminals:

24	110
0.5	0.2

**V
A**

Standard double blocks with screw clamp terminals and blocks for plug-in connector:

24	110
0.4	0.15

Electrical reliability

Failure rate
Conforming to IEC/EN 60947-5-4

- In clean environment

Standard blocks:
- at 17 V and 5 mA, $\lambda < 10^{-8}$
- at 5 V and 1 mA, $\lambda < 10^{-6}$

Special blocks with gold flashed contacts, for low power switching:
- at 5 V and 1 mA, $\lambda < 10^{-7}$

- In dusty environment

Special blocks with gold flashed contacts and dust protection for low power switching only:
- at 5 V and 1 mA, $\lambda < 10^{-7}$

Characteristics of signalling units (pilot lights)

Mechanical characteristics

Vibration resistance	Conforming to IEC 60068-2-6	gn	Frequency: 12 to 500 Hz: 5
Electric shock resistance	Conforming to IEC 60068-2-27	gn	Half sine wave acceleration 11 ms: 50 Half sine wave acceleration 18 ms: 30

Electrical characteristics

Cabling capacity	Conforming to IEC 60947-1	mm ²	Screw clamp terminals Min: 1 x 0.22 without cable end (1 x 0.34 for linking) Max: 2 x 1.5 with cable end
Rated insulation voltage	Conforming to IEC 60947-1	V	Direct supply pilot light blocks (BA 9s bulb): U _i = 250 degree of pollution 3 Pilot light blocks with integral LED: U _i = 250 degree of pollution 3 Pilot light blocks with transformer: U _i = 600 degree of pollution 3
Rated impulse withstand voltage	Conforming to IEC 60947-1	kV	Direct supply pilot light blocks (BA 9s bulb): U _{imp} = 4 Pilot light blocks with integral LED: U _{imp} = 4 Pilot light blocks with transformer: U _{imp} = 6

Specific characteristics of single light blocks with integral LED

Voltage limits	For rated voltage	V	12 V: 10 to 15 $\overline{\sim}$; 10.2 to 13.8 \sim 24 V: 19.2 to 30 $\overline{\sim}$; 21.6 to 26.4 \sim 24 to 120 V: 20 to 132 $\overline{\sim}$ 48 to 120 V: 40 to 132 \sim 240 V: 195 to 264 \sim
Current consumption	Applicable to all colours	mA	Blocks with $\overline{\sim}$ 12 V supply: 18 Blocks with $\overline{\sim}$ 24 V supply: 18 Blocks with \sim 120 V supply: 14 Blocks with \sim 240 V supply: 14
Service life	At rated voltage and at an ambient temperature of 25 °C	H	100 000
Surge withstand	Conforming to IEC 61000-4-5	kV	1
Resistance to fast transients	Conforming to IEC 61000-4-4	kV	2
Resistance to electromagnetic fields	Conforming to IEC 61000-4-3	V/m	10
Resistance to electrostatic discharges	Conforming to IEC 61000-2-6	kV	8/6
Direct parallel connection across inductive load e.g.: contactor coil or solenoid	Maximum power of load	VA	For high power applications (≥ 30 VA), a ZBZ V● LED suppressor must be connected across the light block terminals (see page 36018/3)
Electromagnetic emission	Conforming to IEC 55011		Class B

Specific characteristics







Body/fixing collar

Tightening torque of fixing screw		N.m	0.8 (max 1.2)
-----------------------------------	--	-----	---------------

Hour counters and annunciators

Voltage limits	Hour counter and annunciator	V	$\pm 10\%$ of the rated voltage
Current consumption	Hour counter	mA	XB5 DSB : 7 to 15 XB5 DSG : 8 XB5 DSM : 8
	Annunciator	mA	5

Pushbuttons, spring return (screw clamp terminal connections)

Shape of head	Type of push	Type of contact		Marking	Colour of push	Reference	Weight
		N/O	N/C				
 563455 XB5 AA31	Flush	1	–	–	Black	XB5 AA21 (ZB5 AZ101 + ZB5 AA2)	0.037
		–	1	–	Green	XB5 AA31 (ZB5 AZ101 + ZB5 AA3)	0.037
		–	–	1	Yellow	XB5 AA51 (ZB5 AZ101 + ZB5 AA5)	0.037
		–	–	1	Blue	XB5 AA61 (ZB5 AZ101 + ZB5 AA6)	0.037
 563456 XB5 AA4322	Flush	1	–	“I” (white)	Green	XB5 AA3311 (ZB5 AZ101 + ZB5 AA331)	0.037
		–	1	“O” (white)	Red	XB5 AA4322 (ZB5 AZ102 + ZB5 AA432)	0.037
 563457 XB5 AP51	Flush (1)	1	–	↑ (black)	White	XB5 AA3341 (ZB5 AZ101 + ZB5 AA334)	0.037
		1	–	↑ (white)	Black	XB5 AA3351 (ZB5 AZ101 + ZB5 AA335)	0.037
 563458 XB5 AL42	Booted (clear silicone) (colour of push unobscured)	1	–	–	Black	XB5 AP21 (ZB5 AZ101 + ZB5 AP2)	0.039
		–	1	–	Green	XB5 AP31 (ZB5 AZ101 + ZB5 AP3)	0.039
		–	–	1	Yellow	XB5 AP51 (ZB5 AZ101 + ZB5 AP5)	0.039
		–	–	1	Blue	XB5 AP61 (ZB5 AZ101 + ZB5 AP6)	0.039
 563459 XB5 AC21	Projecting	–	1	–	Red	XB5 AP42 (ZB5 AZ102 + ZB5 AP4)	0.039
		–	1	–	Red	XB5 AL42 (ZB5 AZ102 + ZB5 AL4)	0.038
 563460 XB5 AL845	Mushroom head Ø 40	1	–	–	Black	XB5 AC21 (ZB5 AZ101 + ZB5 AC2)	0.062

Double-headed pushbuttons, spring return (screw clamp terminal connections)















Shape of head	Type of push	Type of contact		Degree of protection	Reference	Weight
		N/O	N/C			
	1 flush green push (marked “I”)	1	1	IP 40	XB5 AL845 (ZB5 AZ105 + ZB5 AL8434)	0.049
	1 projecting red push (marked “O”)	–	–	IP 66	XB5 AL945 (ZB5 AZ105 + ZB5 AL9434)	0.054

(1) Product supplied with cap not clipped-in, allowing orientation through 360° in 90° steps.

Emergency stop and mushroom head pushbuttons, Ø 40 (red) (screw clamp terminal connections)

Shape of head	Type of push	Type of contact		Reference	Weight kg
		N/O	N/C		
 563449 XB5 AS9445	Trigger action Push-pull	1	1	XB5 AT845 (ZB5 AZ105 + ZB5 AT84)	0.076
	Trigger action Turn to release	1	1	XB5 AS8445 (ZB5 AZ105 + ZB5 AS844)	0.072
	Trigger action Key release (key n° 455)	1	1	XB5 AS9445 (ZB5 AZ105 + ZB5 AS944)	0.112
 563450 XB5 AT42	Push-pull	–	1	XB5 AT42 (ZB5 AZ102 + ZB5 AT4)	0.065
 563451 XB5 AS542	Turn to release	–	1	XB5 AS542 (ZB5 AZ102 + ZB5 AS54)	0.060
	Key release (key n° 455)	–	1	XB5 AS142 (ZB5 AZ102 + ZB5 AS14)	0.075

Selector switches and key switches

Shape of head	Type of operator	Type of contact		Number and type of positions (1)	Reference	Weight kg
		N/O	N/C			
 563452 XB5 AD33	Standard handle, black	1	–	2 - stay put 	XB5 AD21 (ZB5 AZ101 + ZB5 AD2)	0.043
		2	–	3 - stay put 	XB5 AD33 (ZB5 AZ103 + ZB5 AD3)	0.052
				3 - spring return to centre 	XB5 AD53 (ZB5 AZ103 + ZB5 AD5)	0.052
 563453 XB5 AJ33	Long handle, black	1	–	2 - stay put 	XB5 AJ21 (ZB5 AZ101 + ZB5 AJ2)	0.043
		2	–	3 - stay put 	XB5 AJ33 (ZB5 AZ103 + ZB5 AJ3)	0.053
				3 - spring return to centre 	XB5 AJ53 (ZB5 AZ103 + ZB5 AJ5)	0.053
 563454 XB5 AG33	Key switch (n° 455)	1	–	2 - stay put 	XB5 AG21 (ZB5 AZ101 + ZB5 AG2)	0.066
					XB5 AG41 (ZB5 AZ101 + ZB5 AG4)	0.066
		2	–	2 - spring return to left 	XB5 AG61 (ZB5 AZ101 + ZB5 AG6)	0.066
				3 - stay put 	XB5 AG03 (ZB5 AZ103 + ZB5 AG0)	0.076
			XB5 AG33 (ZB5 AZ103 + ZB5 AG3)	0.076		

(1) The symbol  indicates key withdrawal position(s).

814388



XB5 AVB1

Protected
LED

Pilot lights with integral LED (screw clamp terminal connections)

Shape of head	Supply voltage V	Colour	Reference	Weight kg
With integral LED				
	≈ 24	White	XB5 AVB1 (ZB5 AVB1 + ZB5 AV013)	0.038
		Green	XB5 AVB3 (ZB5 AVB3 + ZB5 AV033)	0.038
		Red	XB5 AVB4 (ZB5 AVB4 + ZB5 AV043)	0.038
		Yellow	XB5 AVB5 (ZB5 AVB5 + ZB5 AV053)	0.038
		Blue	XB5 AVB6 (ZB5 AVB6 + ZB5 AV063)	0.038
		White	XB5 AVG1 (ZB5 AVG1 + ZB5 AV013)	0.038
	~ 48...120	Green	XB5 AVG3 (ZB5 AVG3 + ZB5 AV033)	0.038
		Red	XB5 AVG4 (ZB5 AVG4 + ZB5 AV043)	0.038
		Yellow	XB5 AVG5 (ZB5 AVG5 + ZB5 AV053)	0.038
		Blue	XB5 AVG6 (ZB5 AVG6 + ZB5 AV063)	0.038
		White	XB5 AVM1 (ZB5 AVM1 + ZB5 AV013)	0.038
		Green	XB5 AVM3 (ZB5 AVM3 + ZB5 AV033)	0.038
	~ 230...240	Red	XB5 AVM4 (ZB5 AVM4 + ZB5 AV043)	0.038
		Yellow	XB5 AVM5 (ZB5 AVM5 + ZB5 AV053)	0.038
		Blue	XB5 AVM6 (ZB5 AVM6 + ZB5 AV063)	0.038

Pilot lights for BA 9s bulb (screw clamp terminal connections)

Shape of head	Supply voltage V	Colour	Reference	Weight kg
---------------	------------------	--------	-----------	-----------

Direct supply, for BA 9s bulb, $U \leq 250$ V, 2.4 W (bulb not included)



XB5 AV63





	≤ 250	White	XB5 AV61 (ZB5 AV6 + ZB5 AV01)	0.037
		Green	XB5 AV63 (ZB5 AV6 + ZB5 AV03)	0.037
		Red	XB5 AV64 (ZB5 AV6 + ZB5 AV04)	0.037
		Yellow	XB5 AV65 (ZB5 AV6 + ZB5 AV05)	0.037

Via integral transformer with 1.2 VA, 6 V secondary. BA 9s incandescent bulb (bulb included)





XB5 AV34

	$\sim 110...120$ 50/60 Hz	White	XB5 AV31 (ZB5 AV3 + ZB5 AV01)	0.109	
		Green	XB5 AV33 (ZB5 AV3 + ZB5 AV03)	0.109	
		Red	XB5 AV34 (ZB5 AV3 + ZB5 AV04)	0.109	
		Yellow	XB5 AV35 (ZB5 AV3 + ZB5 AV05)	0.109	
		$\sim 230 - 50$ Hz $\sim 220...240 - 60$ Hz	White	XB5 AV41 (ZB5 AV4 + ZB5 AV01)	0.110
			Green	XB5 AV43 (ZB5 AV4 + ZB5 AV03)	0.110
	Red		XB5 AV44 (ZB5 AV4 + ZB5 AV04)	0.110	
	Yellow		XB5 AV45 (ZB5 AV4 + ZB5 AV05)	0.110	

Illuminated pushbuttons, spring return, flush push							
Shape of head	Description	Type of contact		Supply voltage	Colour of push	Reference	Weight
				V			kg
		N/O	N/C				
Screw clamp terminal connections							
	Integral LED Protected LED	1	1	~ 24	White	XB5 AW31B5 (ZB5 AW0B15 + ZB5 AW313)	0.056
					Green	XB5 AW33B5 (ZB5 AW0B35 + ZB5 AW333)	0.056
					Red	XB5 AW34B5 (ZB5 AW0B45 + ZB5 AW343)	0.056
					Yellow	XB5 AW35B5 (ZB5 AW0B55 + ZB5 AW353)	0.056
					Blue	XB5 AW36B5 (ZB5 AW0B65 + ZB5 AW363)	0.056
				~ 48...120	White	XB5 AW31G5 (ZB5 AW0G15 + ZB5 AW313)	0.056
					Green	XB5 AW33G5 (ZB5 AW0G35 + ZB5 AW333)	0.056
					Red	XB5 AW34G5 (ZB5 AW0G45 + ZB5 AW343)	0.056
					Yellow	XB5 AW35G5 (ZB5 AW0G55 + ZB5 AW353)	0.056
					Blue	XB5 AW36G5 (ZB5 AW0G65 + ZB5 AW363)	0.056
				~ 230...240	White	XB5 AW31M5 (ZB5 AW0M15 + ZB5 AW313)	0.056
					Green	XB5 AW33M5 (ZB5 AW0M35 + ZB5 AW333)	0.056
					Red	XB5 AW34M5 (ZB5 AW0M45 + ZB5 AW343)	0.056
					Yellow	XB5 AW35M5 (ZB5 AW0M55 + ZB5 AW353)	0.056
					Blue	XB5 AW36M5 (ZB5 AW0M65 + ZB5 AW363)	0.056
					Direct supply for BA 9s bulb, 2.4 W max. (not included)	1	1
	Green	XB5 AW3365 (ZB5 AW065 + ZB5 AW33)	0.057				
	Red	XB5 AW3465 (ZB5 AW065 + ZB5 AW34)	0.057				
	Yellow	XB5 AW3565 (ZB5 AW065 + ZB5 AW35)	0.057				



Illuminated pushbuttons, spring return, flush push (continued)

Shape of head	Description	Type of contact		Supply voltage	Colour of push	Reference	Weight
				V			kg
 XB5 AW3335	Via integral transformer 6 V secondary, BA9s incandescent bulb (included)	1	1	~ 110...120 50/60 Hz	White	XB5 AW3135 (ZB5 AW035 + ZB5 AW31)	0.128
					Green	XB5 AW3335 (ZB5 AW035 + ZB5 AW33)	0.128
					Red	XB5 AW3435 (ZB5 AW035 + ZB5 AW34)	0.128
					Yellow	XB5 AW3535 (ZB5 AW035 + ZB5 AW35)	0.128
					White	XB5 AW3145 (ZB5 AW045 + ZB5 AW31)	0.129
					Green	XB5 AW3345 (ZB5 AW045 + ZB5 AW33)	0.129
					Red	XB5 AW3445 (ZB5 AW045 + ZB5 AW34)	0.129
					Yellow	XB5 AW3545 (ZB5 AW045 + ZB5 AW35)	0.129
					White	XB5 AW3145 (ZB5 AW045 + ZB5 AW31)	0.129
					Green	XB5 AW3345 (ZB5 AW045 + ZB5 AW33)	0.129
					Red	XB5 AW3445 (ZB5 AW045 + ZB5 AW34)	0.129
					Yellow	XB5 AW3545 (ZB5 AW045 + ZB5 AW35)	0.129

Double-headed pushbuttons, spring return, with integral LED pilot light (IP 40) (1)

Screw clamp terminal connections							
 XB5 AW84B5	1 flush green push (marked "I") 1 yellow pilot light 1 red projecting push (marked "O")	1	1	~ 24	-	XB5 AW84B5 (ZB5 AW0B55 + ZB5 AW843743)	0.060
				~ 48...120	-	XB5 AW84G5 (ZB5 AW0G55 + ZB5 AW843743)	0.060
				~ 230...240	-	XB5 AW84M5 (ZB5 AW0M55 + ZB5 AW843743)	0.060

Illuminated selector switches with integral LED (2-position stay put)

Shape of head	Type of operator	Type of contact		Supply voltage	Colour of handle	Reference	Weight
				V			kg
 XB5 AK124B5	Standard handle	1	1	~ 24	Green	XB5 AK123B5 (ZB5 AW0B35 + ZB5 AK1233)	0.059
					Red	XB5 AK124B5 (ZB5 AW0B45 + ZB5 AK1243)	0.059
					Yellow	XB5 AK125B5 (ZB5 AW0B55 + ZB5 AK1253)	0.059
					Green	XB5 AK123G5 (ZB5 AW0G35 + ZB5 AK1233)	0.059
					Red	XB5 AK124G5 (ZB5 AW0G45 + ZB5 AK1243)	0.059
					Yellow	XB5 AK125G5 (ZB5 AW0G55 + ZB5 AK1253)	0.059
					Green	XB5 AK123M5 (ZB5 AW0M35 + ZB5 AK1233)	0.059
					Red	XB5 AK124M5 (ZB5 AW0M45 + ZB5 AK1243)	0.059
					Yellow	XB5 AK125M5 (ZB5 AW0M55 + ZB5 AK1253)	0.059

(1) For IP 66 degree of protection, fit a clear sealing boot: **ZBW 008** or **ZBW 008A**. See page 36018/15.

To combine with heads:
 see pages 36015/3 to 36015/9

Complete bodies (fixing collar + single contact block)

Description	Type of contact		Reference	Weight kg
	N/O	N/C		
Screw clamp terminal connections	1	–	ZB5 AZ101	0.021
	–	1	ZB5 AZ102	0.021
	2	–	ZB5 AZ103	0.030
	–	2	ZB5 AZ104	0.030
	1	1	ZB5 AZ105	0.030
Plug-in connector (1)	1	2	ZB5 AZ141	0.040
	1	–	ZB5 AZ1014	0.018
	–	1	ZB5 AZ1024	0.018
	2	–	ZB5 AZ1034	0.026
	–	2	ZB5 AZ1044	0.026
	1	1	ZB5 AZ1054	0.026
	1	2	ZB5 AZ1414	0.036

814411



ZB5 AZ101

814409



ZB5 AZ102

814408



ZB5 AZ1014

814410



ZB5 AZ1024

Contact blocks

Description

Separate contact blocks

See page 36018/12

(1) Connecting cables and connector for plug-in connector contact blocks: see page 36018/4.

Other versions

Complete bodies with Faston connector terminals (6.35 or 2 x 2.8).
 Please consult your Regional Sales Office.

To combine with bodies:
see page 36015/2

Heads for spring return pushbuttons - unmarked



Shape of head	Type of push	Colour of cap	Reference	Weight kg
	Without cap (1)	–	ZB5 AA0	0.022
	Flush, with set of 6 coloured caps	6 colours (2)	ZB5 AA9	0.027
	Flush	White	ZB5 AA1	0.018
		Black	ZB5 AA2	0.018
		Green	ZB5 AA3	0.018
		Red	ZB5 AA4	0.018
		Yellow	ZB5 AA5	0.018
		Blue	ZB5 AA6	0.018
		Grey	ZB5 AA8	0.018
			Flush with transparent cap, for insertion of legend (3)	White
Green	ZB5 AA38			0.018
Red	ZB5 AA48			0.018
Yellow	ZB5 AA58			0.018
	Projecting	White	ZB5 AL1	0.019
		Black	ZB5 AL2	0.019
		Green	ZB5 AL3	0.019
		Red	ZB5 AL4	0.019
		Yellow	ZB5 AL5	0.019
		Blue	ZB5 AL6	0.019
	Booted (clear silicone) Colour of push unobscured	White	ZB5 AP1	0.021
		Black	ZB5 AP2	0.021
		Green	ZB5 AP3	0.021
		Red	ZB5 AP4	0.021
		Yellow	ZB5 AP5	0.021
		Blue	ZB5 AP6	0.021
	Booted (coloured silicone) Can be replaced without dismantling the head. Compatible with legend holder	White	ZB5 AP1S	0.014
		Black	ZB5 AP2S	0.014
		Green	ZB5 AP3S	0.014
		Red	ZB5 AP4S	0.014
		Yellow	ZB5 AP5S	0.014
		Blue	ZB5 AP6S	0.014
	Booted (clear silicone), for insertion of legend (3) (colour of push unobscured)	White	ZB5 AP18	0.023
		Green	ZB5 AP38	0.023
		Red	ZB5 AP48	0.023
		Yellow	ZB5 AP58	0.023
		Blue	ZB5 AP68	0.023
			Flush (high bezel)	White
Black	ZB5 AA24			0.020
Green	ZB5 AA34			0.020
Red	ZB5 AA44			0.020
Yellow	ZB5 AA54			0.020
Blue	ZB5 AA64			0.020
	Recessed (high guard)	White	ZB5 AA16	0.020
		Black	ZB5 AA26	0.020
		Green	ZB5 AA36	0.020
		Red	ZB5 AA46	0.020
		Yellow	ZB5 AA56	0.020
		Blue	ZB5 AA66	0.020
	Without cap (1) Flush	–	ZB5 CA0	0.022
		White	ZB5 CA1	0.019
		Black	ZB5 CA2	0.019
		Green	ZB5 CA3	0.019
		Red	ZB5 CA4	0.019
		Yellow	ZB5 CA5	0.019
	Projecting	White	ZB5 CL1	0.021
		Black	ZB5 CL2	0.021
		Green	ZB5 CL3	0.021
		Red	ZB5 CL4	0.021
		Yellow	ZB5 CL5	0.021
		Blue	ZB5 CL6	0.021

(1) Cap to be ordered separately, see page 36018/6.
(2) Head supplied with 6 different coloured caps (white, black, green red, yellow, blue).
(3) For legend ordering information, see page 36018/12.

To combine with bodies:
see page 36015/2



ZB5 AA331



ZB5 AA432



ZB5 AL232

Heads for spring return pushbuttons - marked

Shape of head	Type of push	Marking		Colour of cap	Reference	Weight kg	
		Text	Colour				
	Flush (1)	I	White	Green	ZB5 AA331	0.018	
			Black	White	ZB5 AA131	0.018	
		II	White	Green	ZB5 AA336	0.018	
			Black	White	ZB5 AA136	0.018	
		START	White	Green	ZB5 AA333	0.018	
			Black	White	ZB5 AA133	0.018	
		ON	White	Green	ZB5 AA341	0.018	
			Black	White	ZB5 AA141	0.018	
		MARCHE	White	Green	ZB5 AA342	0.018	
			Black	White	ZB5 AA142	0.018	
				White	Black	ZB5 AA245	0.018
				Black	White	ZB5 AA145	0.018
		O	White	Red	Black	ZB5 AA432	0.018
				Black	Black	ZB5 AA232	0.018
		ARRET	White	Red	Black	ZB5 AA433	0.018
				Black	Black	ZB5 AA233	0.018
		STOP	White	Red	Black	ZB5 AA434	0.018
				Black	Black	ZB5 AA234	0.018
		OFF	White	Red	Black	ZB5 AA435	0.018
				Black	Black	ZB5 AA235	0.018
UP	Black	White	ZB5 AA343	0.018			
DOWN	White	Black	ZB5 AA344	0.018			
↑	White	Black	Black	ZB5 AA335	0.018		
		Black	White	ZB5 AA334	0.018		
	Projecting (1)	O	White	Red	ZB5 AL432	0.019	
			Black	Black	ZB5 AL232	0.019	
		ARRET	White	Red	Black	ZB5 AL433	0.019
				Black	Black	ZB5 AL233	0.019
		STOP	White	Red	Black	ZB5 AL434	0.019
				Black	Black	ZB5 AL234	0.019
OFF	White	Red	Black	ZB5 AL435	0.019		
	Flush (1)	I	White	Green	ZB5 CA331	0.019	
		O	White	Red	ZB5 CA432	0.019	
		+	White	Black	ZB5 CA2934	0.019	
		↑	White	Black	ZB5 CA2912	0.019	
		R	White	Blue	ZB5 CA6939	0.019	
			White	Blue	ZB5 CA6939	0.019	

Heads for lockable "push-turn" pushbuttons

Shape of head	Key type	Locking	Key withdrawal	Reference	Weight kg
	Key n° 4A185	Both positions	Both positions	ZB5 AFDA	0.050
		Actuated position	Actuated position	ZB5 AFDB	0.050
		Rest position	Rest position	ZB5 AFDC	0.050
		Actuated position	Both positions	ZB5 AFDD	0.050
	Key LU1	Both positions	Both positions	ZB5 AFDE01	0.050
	Key LU2	Both positions	Both positions	ZB5 AFDE02	0.050
	Key LU3	Both positions	Both positions	ZB5 AFDE03	0.050
	Key LU4	Both positions	Both positions	ZB5 AFDE04	0.050
	Key LU5	Both positions	Both positions	ZB5 AFDE05	0.050
	Key LU6	Both positions	Both positions	ZB5 AFDE06	0.050
	Key LU7	Both positions	Both positions	ZB5 AFDE07	0.050
	Key LU8	Both positions	Both positions	ZB5 AFDE08	0.050
	Key LU9	Both positions	Both positions	ZB5 AFDE09	0.050
	Key LU10	Both positions	Both positions	ZB5 AFDE10	0.050
	Key LU11	Both positions	Both positions	ZB5 AFDE11	0.050
	Key LU12	Both positions	Both positions	ZB5 AFDE12	0.050
	Key LU13	Both positions	Both positions	ZB5 AFDE13	0.050
Key LU14	Both positions	Both positions	ZB5 AFDE14	0.050	
Key LU15	Both positions	Both positions	ZB5 AFDE15	0.050	

(1) Push supplied with cap not clipped-in, allowing orientation through 360° in 90° steps.

To combine with bodies:
 see page 36015/2

Heads for "push-turn" pushbuttons with knurled knob

Shape of head	Description	Marking	Reference	Weight kg
	Knurled knob without cap	–	ZB5 AF	0.027
	Knurled knob with marked cap	↑ (white on black background)	ZB5 AF351	0.030

Heads for double-headed, spring return pushbuttons

Shape of head	Description	Colour of pushes	Degree of protection	Reference	Weight kg
---------------	-------------	------------------	----------------------	-----------	-----------

Without function marking on pushes

	2 flush pushes	Green	IP 40 (1)	ZB5 AA8134	0.022
		Red	IP 66	ZB5 AA9134	0.027
		White	IP 40 (1)	ZB5 AA8112	0.022
		Black	IP 66	ZB5 AA9112	0.027

	1 flush push 1 projecting push	Green	IP 40 (1)	ZB5 AL8334	0.021
		Red	IP 66	ZB5 AL9334	0.026
		White	IP 40 (1)	ZB5 AL8312	0.021
		Black	IP 66	ZB5 AL9312	0.026



With function marking on pushes

	2 flush pushes (marked "I") (marked "O")	Green	IP 40 (1)	ZB5 AA8234	0.022
		Red	IP 66	ZB5 AA9234	0.027
		White	IP 40 (1)	ZB5 AA8212	0.022
		Black	IP 66	ZB5 AA9212	0.027

	1 flush push 1 projecting push	Green	IP 40 (1)	ZB5 AL8434	0.021
		Red	IP 66	ZB5 AL9434	0.026
		White	IP 40 (1)	ZB5 AL8412	0.021
		Black	IP 66	ZB5 AL9412	0.026

Heads for "push-push to release" pushbuttons (2)

Shape of head	Type of push	Colour of push	Reference	Weight kg
---------------	--------------	----------------	-----------	-----------

	Without cap (3)	–	ZB5 AH0	0.018
	Flush	White	ZB5 AH01	0.018
		Black	ZB5 AH02	0.018
		Green	ZB5 AH03	0.018
		Red	ZB5 AH04	0.018
		Yellow	ZB5 AH05	0.018
		Blue	ZB5 AH06	0.018

	Projecting	White	ZB5 AH1	0.018
		Black	ZB5 AH2	0.018
		Green	ZB5 AH3	0.018
		Red	ZB5 AH4	0.018
		Yellow	ZB5 AH5	0.018
		Blue	ZB5 AH6	0.018

	Without cap (3)	–	ZB5 CH0	0.020
---	-----------------	---	---------	-------

	Flush	White	ZB5 CH01	0.020
		Black	ZB5 CH02	0.020
		Green	ZB5 CH03	0.020
		Red	ZB5 CH04	0.020
		Yellow	ZB5 CH05	0.020
		Blue	ZB5 CH06	0.020

(1) NEMA type 1.

(2) Maximum of 1 row of 3 contact blocks on associated body/fixing collar sub-assembly.

(3) Coloured cap to be ordered separately: see page 36018/6.



To combine with bodies:
see page 36015/2

Mushroom heads for spring return pushbuttons



ZB5 AC24



Shape of head	Diameter of push mm	Colour of push	Reference	Weight kg
30		Black	ZB5 AC24	0.027
		Green	ZB5 AC34	0.027
		Red	ZB5 AC44	0.027
		Yellow	ZB5 AC54	0.027
		Blue	ZB5 AC64	0.027
40		Black	ZB5 AC2	0.046
		Green	ZB5 AC3	0.046
		Red	ZB5 AC4	0.046
		Yellow	ZB5 AC5	0.046
		Blue	ZB5 AC6	0.046
60		Black	ZB5 AR2	0.065
		Green	ZB5 AR3	0.065
		Red	ZB5 AR4	0.065
		Yellow	ZB5 AR5	0.065
		Blue	ZB5 AR6	0.065
60 Hemispherical		Black	ZB5 AR216	0.048
		Green	ZB5 AR316	0.048
		Red	ZB5 AR416	0.048
		Yellow	ZB5 AR516	0.048
		Blue	ZB5 AR616	0.048



ZB5 AC2



ZB5 AR4





ZB5 AR216

To combine with bodies:
see page 36015/2

Mushroom heads for latching pushbuttons

(Emergency stop: colour red)

Shape of head	Type of push	Diameter of push mm	Colour of push	Reference	Weight kg		
		40	Red	ZB5 AT84	0.050		
		30	Red	ZB5 AS834	0.042		
		40	Red	ZB5 AS844	0.046		
		30	Red	ZB5 AS934	0.068		
		40	Red	ZB5 AS944 (2)	0.071		
		60	Red	ZB5 AS934	0.092		
		40	Red	ZB5 AS944D	0.071		
		30	Black	ZB5 AT24	0.044		
		40	Black	ZB5 AT2	0.049		
			Red	ZB5 AT4	0.049		
		60	Black	ZB5 AX2	0.067		
			Red	ZB5 AX4	0.067		
			Turn to release	30	Black	ZB5 AS42	0.040
					Red	ZB5 AS44	0.040
				40	Black	ZB5 AS52	0.044
					Red	ZB5 AS54	0.044
			Yellow	ZB5 AS55	0.044		
				60	Black	ZB5 AS62	0.064
	Red			ZB5 AS64	0.064		
	Key release (key n° 455) (3) (2 keys included with head)			30	Black	ZB5 AS72	0.040
					Red	ZB5 AS74	0.040
				40	Black	ZB5 AS12	0.044
					Red	ZB5 AS14 (2)	0.044
				60	Black	ZB5 AS22	0.064
					Red	ZB5 AS24	0.064
	Key release (key n° 4A185)	40	Red	ZB5 AS14D	0.044		

(1) Maximum number of contacts fitted to the associated body: 4.

Example : 4 single contact blocks, 2 double contact blocks, or 2 single contact blocks + 1 double contact block. See page 36018/2

(2) Other key numbers:

- key n° 421E: add suffix **12** to the reference.
- key n° 458A: add suffix **10** to the reference.
- key n° 520E: add suffix **14** to the reference.
- key n° 3131A: add suffix **20** to the reference.

Example : For a Ø 40 mushroom head for a trigger action, latching pushbutton, with release by key n° 421E, the reference becomes: **ZB5 AS94412**.

(3) For specific keys with other numbers, please consult your Regional Sales Office.

To combine with bodies:
see page 36015/2



Heads for selector switches (1)

Shape of head	Type of operator	Number and type of positions		Reference	Weight kg
	Standard handle, black	2 - stay put		ZB5 AD2	0.024
		2 - stay put with actuation of the centre contact		ZB5 AD2M	0.024
		2 - spring return from right to left		ZB5 AD4	0.024
		2 - spring return from right to left with actuation of centre contact		ZB5 AD4M	0.024
		3 - stay put		ZB5 AD3	0.024
		3 - spring return to centre		ZB5 AD5	0.024
		3 - spring return from left to centre		ZB5 AD7	0.024
		3 - spring return from right to centre		ZB5 AD8	0.024
	Standard handle, white	2 - stay put		ZB5 AD201	0.024
		2 - spring return from right to left		ZB5 AD401	0.024
		3 - stay put		ZB5 AD301	0.024
		3 - spring return to centre		ZB5 AD501	0.024
		3 - spring return from left to centre		ZB5 AD701	0.024
		3 - spring return from right to centre		ZB5 AD801	0.024
	Standard handle, green	2 - stay put		ZB5 AD203	0.024
2 - spring return from right to left			ZB5 AD403	0.024	
3 stay put			ZB5 AD303	0.024	
3 - spring return to centre			ZB5 AD503	0.024	
3 - spring return from left to centre			ZB5 AD703	0.024	
		3 - spring return from right to centre		ZB5 AD803	0.024





























(1) Can only be used for actuation of end row (side) mounted contacts.

To combine with bodies:
 see page 36015/2



ZB5 AD●●

Heads for selector switches (1) (continued)

Shape of head	Type of operator	Number and type of positions		Reference	Weight kg
	Standard handle, red	2 - stay put		ZB5 AD204	0.024
		2 - spring return from right to left		ZB5 AD404	0.024
		3 stay put		ZB5 AD304	0.024
		3 - spring return to centre		ZB5 AD504	0.024
		3 - spring return from left to centre		ZB5 AD704	0.024
		3 - spring return from right to centre		ZB5 AD804	0.024
	Standard handle, yellow	2 - stay put		ZB5 AD205	0.024
		2 - spring return from right to left		ZB5 AD405	0.024
		3 stay put		ZB5 AD305	0.024
		3 - spring return to centre		ZB5 AD505	0.024
		3 - spring return from left to centre		ZB5 AD705	0.024
		3 - spring return from right to centre		ZB5 AD805	0.024
	Standard handle, blue	2 - stay put		ZB5 AD206	0.024
		2 - spring return from right to left		ZB5 AD406	0.024
		3 stay put		ZB5 AD306	0.024
		3 - spring return to centre		ZB5 AD506	0.024
		3 - spring return from left to centre		ZB5 AD706	0.024
		3 - spring return from right to centre		ZB5 AD806	0.024
	Long handle, black	2 - stay put		ZB5 AJ2	0.025
		2 - stay put with actuation of the centre contact		ZB5 AJ2M	0.025
		2 - spring return from right to left		ZB5 AJ4	0.025
		2 - spring return from right to left with actuation of centre contact		ZB5 AJ4M	0.025
		3 - stay put		ZB5 AJ3	0.025
		3 - spring return to centre		ZB5 AJ5	0.025
		3 - spring return from left to centre		ZB5 AJ7	0.025
		3 - spring return from right to centre		ZB5 AJ8	0.025

(1) Can only be used for actuation of end row (side) mounted contacts.

To combine with bodies:
see page 36015/2



ZB5 AD●●

Heads for selector switches (1) (continued)

Shape of head	Type of operator	Number and type of positions (2)		Reference	Weight kg
	Knurled knob, black	2 - stay put		ZB5 AD29	0.027
		2 - spring return from right to left		ZB5 AD49	0.027
		3 - stay put		ZB5 AD39	0.027
		3 - spring return to centre		ZB5 AD59	0.027
		3 - spring return from left to centre		ZB5 AD79	0.027
		3 - spring return from right to centre		ZB5 AD89	0.027
	Key switch (key n° 455) (4)	2 - stay put		ZB5 AG2 (3)	0.050
				ZB5 AG4 (3)	0.050
		2 - stay put with actuation of the centre contact		ZB5 AG2M	0.050
				ZB5 AG4M	0.050
		2 - spring return from right to left		ZB5 AG6 (3)	0.050
		2 - spring return from right to left with actuation of centre contact		ZB5 AG6M	0.050
		3 - stay put		ZB5 AG0 (3)	0.050
				ZB5 AG3 (3)	0.050
				ZB5 AG5 (3)	0.050
				ZB5 AG9 (3)	0.050
				ZB5 AG09 (3)	0.050
		3 - spring return from left to centre		ZB5 AG1 (3)	0.050
		2 - spring return to centre		ZB5 AG7 (3)	0.050
		3 - spring return from right to centre		ZB5 AG8 (3)	0.050
		ZB5 AG08 (3)	0.050		

(1) Can only be used for actuation of end row (side) mounted contacts.

(2) The symbol indicates key withdrawal position(s).

(3) Other key numbers:

- key n° 421E: add suffix **12** to the reference,
- key n° 458A: add suffix **10** to the reference,
- key n° 520E: add suffix **14** to the reference,
- key n° 3131A: add suffix **20** to the reference.

Example :

For a switch head with key n° 421E, 2-position stay put with key withdrawal from the left-hand position, the reference becomes : **ZB5 AG212**.

(4) For specific keys with other numbers, please consult your Regional Sales Office.

To combine with bodies:
 see page 36015/2



ZB5 AG●●

Heads for selector switches (1) (continued)

Shape of head	Type of operator	Number and type of positions (2)		Reference	Weight kg
	Key switch (key n° 8D1)	2 - stay put		ZB5 AG2D	0.050
				ZB5 AG02D	0.050
				ZB5 AG4D	0.050
		2 - spring return from right to left		ZB5 AG6D	0.050
			3 - stay put		ZB5 AG0D
				ZB5 AG3D	0.050
				ZB5 AG5D	0.050
				ZB5 AG9D	0.050
				ZB5 AG09D	0.050
				ZB5 AG03D	0.050
				ZB5 AG04D	0.050
		3 - spring return from left to centre		ZB5 AG06D	0.050
				ZB5 AG1D	0.050
				ZB5 AG07D	0.050
		3 - spring return from right to centre		ZB5 AG8D	0.050
				ZB5 AG08D	0.050
				ZB5 AG05D	0.050
		2 - spring return to centre		ZB5 AG7D	0.050

Heads for toggle switches

Shape of head	Description	Lever	Type of position	Reference	Weight kg
	2-position	Black	Stay put	ZB5 AD28	0.023
			Spring return	ZB5 AD48	0.023
		White	Stay put	ZB5 AD2801	0.023
			Stay put	ZB5 AD2804	0.023
			Stay put	ZB5 AD2806	0.023
			Stay put	ZB5 AD2806	0.023



ZB5 AD28

(1) Can only be used for actuation of end row (side) mounted contacts.
 (2) The symbol indicates key withdrawal position(s).

563091



XB5 AA

Manual overload reset buttons (travel 10 mm) (1)

Shape of head	Actuation distance mm	Marking	Colour	Reference	Weight kg
---------------	-----------------------	---------	--------	-----------	-----------

Without cap (2)

	17...120	–	–	XB5 AA801	0.027
	120...257	–	–	XB5 AA802	0.040

With flush push

	17...120	Without	Green	XB5 AA831	0.027	
			Red	XB5 AA841	0.027	
			Blue	XB5 AA861	0.027	
	120...257	Without	O	Red	XB5 AA84101	0.027
			R	Blue	XB5 AA86102	0.027
			Green	XB5 AA832	0.040	
				Red	XB5 AA842	0.040
				Blue	XB5 AA862	0.040
			O	Red	XB5 AA84201	0.040
			R	Blue	XB5 AA86202	0.040

With projecting push

	17...120	O	Red	XB5 AL84101	0.027
	120...257	O	Red	XB5 AL84201	0.040

Heads + mounting base for potentiometer

Shape of head	Description	For use on	Reference	Weight kg
	For potentiometer with shaft length 44 to 50 mm (potentiometer not included)	Ø 6 mm shaft	ZB5 AD912	0.032
		Ø 6.35 mm shaft	ZB5 AD922	0.032

(1) NEMA type 13.

(2) Coloured cap to be ordered separately: see page 36018/6.

Joystick controllers (54 mm long operating shaft) (1)

Complete joystick controllers (screw clamp terminal connections)

Description	Operation	Spring return to zero position	Reference	Weight kg
2 direction	1 notch 1 N/O contact per direction	Without	XD5 PA12	0.060
		With	XD5 PA22	0.060
4 direction	1 notch 1 N/O contact per direction	Without	XD5 PA14	0.077
		With	XD5 PA24	0.077



XD5 PA12

Sub-assemblies for joystick controllers

Description	For use on	Reference	Weight kg	
Complete body/contact assemblies (screw clamp terminal connections)	2 direction	ZD5 PA103	0.049	
	4 direction	ZD5 PA203	0.058	
Complete head assemblies with operating shaft	2 direction, stay put	ZD5 PA12	0.022	
	2 direction, spring return to zero position	ZD5 PA22	0.022	
	4 direction, stay put	ZD5 PA14	0.022	
	4 direction, spring return to zero position	ZD5 PA24	0.022	
Legends 30 x 48 mm for engraving	2 direction	Black one side Red reverse	ZBG 2201	0.001
		White one side Yellow reverse	ZBG 2401	0.001
Legends 48 x 48 mm for engraving	4 direction	Black one side Red reverse	ZBG 4201	0.002
		White one side Yellow reverse	ZBG 4401	0.002



ZD5 PA103



ZD5 PA203



ZD5 PA12

Hour counters (2)

Characteristics	Supply voltage V	Reference	Weight kg
Indication 0...9999.9	≈ 12...24 - 50/60 Hz	XB5 DSB	0.045
	~ 120 - 60 Hz	XB5 DSG	0.045
	~ 230...240 - 50 Hz	XB5 DSM	0.045



XB5 DS●

Annunciators (IP 40 NEMA 1) (2)

Characteristics	Supply voltage V	Reference	Weight kg
85 db buzzer, basic: 4 kHz with continuous or intermittent operation (connection diagram: see page 36021/8)	≈ 24 - 50/60 Hz	XB5 KSB	0.035
	~ 120 - 50/60 Hz	XB5 KSG	0.035
	~ 230...240 - 50 Hz	XB5 KSM	0.035



XB5 KS●

Fuse carrier (2)

Description	For use with	Reference	Weight kg
Fuse carrier	5 x 20 mm fuse 6.3 A - 250 V	XB5 DT1S	0.022



XB5 DT1S

(1) Cannot be used with standard contact blocks ZBE 101 (single) or ZBE 20● (double).

(2) Replacement parts: fixing nut ZB5 AZ901, anti-rotation plate: ZB5 AZ902, tightening key: ZB5 AZ905.

Other versions

Joystick controllers and complete body/contact assemblies for joystick controllers with Faston connector terminals (6.35 or 2 x 2.8). Please consult your Regional Sales Office.

Harmony style 3 Illuminated pushbuttons and switches with double insulated bezel

Sub-assemblies ZB5 A : bodies

To combine with heads for integral LED:
see pages 36017/7 to 36017/9

Complete bodies (fixing collar + single contact block + light block with integral LED)

Light source	Supply voltage	Type of contact (1)		Colour of light source	Reference	Weight
		N/O	N/C			
	V					kg
Screw clamp terminal connections						
Integral LED	≈ 24	1	-	White	ZB5 AW0B11	0.032
				Green	ZB5 AW0B31	0.032
				Red	ZB5 AW0B41	0.032
				Yellow	ZB5 AW0B51	0.032
				Blue	ZB5 AW0B61	0.032
		-	1	White	ZB5 AW0B12	0.032
				Green	ZB5 AW0B32	0.032
				Red	ZB5 AW0B42	0.032
				Yellow	ZB5 AW0B52	0.032
				Blue	ZB5 AW0B62	0.032
		2	-	White	ZB5 AW0B13	0.042
				Green	ZB5 AW0B33	0.042
				Red	ZB5 AW0B43	0.042
				Yellow	ZB5 AW0B53	0.042
				Blue	ZB5 AW0B63	0.042
		1	1	White	ZB5 AW0B15	0.042
				Green	ZB5 AW0B35	0.042
				Red	ZB5 AW0B45	0.042
				Yellow	ZB5 AW0B55	0.042
				Blue	ZB5 AW0B65	0.042
	≈ 48...120	1	-	White	ZB5 AW0G11	0.032
				Green	ZB5 AW0G31	0.032
				Red	ZB5 AW0G41	0.032
				Yellow	ZB5 AW0G51	0.032
				Blue	ZB5 AW0G61	0.032
		-	1	White	ZB5 AW0G12	0.032
				Green	ZB5 AW0G32	0.032
				Red	ZB5 AW0G42	0.032
				Yellow	ZB5 AW0G52	0.032
				Blue	ZB5 AW0G62	0.032

(1) Can be fitted with additional contact blocks: see page 36018/2.

Other versions

Complete bodies with Faston connector terminals (6.35 or 2 x 2.8).
Please consult your Regional Sales Office.

8 14532



ZB5 AW0B01

Protected
LED

8 14533



ZB5 AW0B03

Harmony style 3 Illuminated pushbuttons and switches with double insulated bezel

To combine with heads for integral LED:
see pages 36017/7 to 36017/9

Sub-assemblies ZB5 A : bodies

Complete bodies (fixing collar + single contact block + light block with integral LED)

Light source	Supply voltage	Type of contact (1)		Colour of light source	Reference	Weight
		N/O	N/C			
	V					kg
Screw clamp terminal connections (continued)						
Integral LED	~ 48...120	2	-	White	ZB5 AW0G13	0.042
				Green	ZB5 AW0G33	0.042
Protected LED				Red	ZB5 AW0G43	0.042
				Yellow	ZB5 AW0G53	0.042
				Blue	ZB5 AW0G63	0.042
				White	ZB5 AW0G15	0.042
				Green	ZB5 AW0G35	0.042
				Red	ZB5 AW0G45	0.042
				Yellow	ZB5 AW0G55	0.042
				Blue	ZB5 AW0G65	0.042
	~ 230...240	1	-	White	ZB5 AW0B11	0.032
				Green	ZB5 AW0M31	0.032
				Red	ZB5 AW0M41	0.032
				Yellow	ZB5 AW0M51	0.032
				Blue	ZB5 AW0M61	0.032
				White	ZB5 AW0M12	0.032
				Green	ZB5 AW0M32	0.032
				Red	ZB5 AW0M42	0.032
				Yellow	ZB5 AW0M52	0.032
				Blue	ZB5 AW0M62	0.032
		2	-	White	ZB5 AW0M13	0.042
				Green	ZB5 AW0M33	0.042
				Red	ZB5 AW0M43	0.042
				Yellow	ZB5 AW0M53	0.042
				Blue	ZB5 AW0M63	0.042
				White	ZB5 AW0M15	0.042
				Green	ZB5 AW0M35	0.042
				Red	ZB5 AW0M45	0.042
				Yellow	ZB5 AW0M55	0.042
				Blue	ZB5 AW0M65	0.042

(1) Can be fitted with additional contact blocks : see page 36018/2.

Other versions

Complete bodies with Faston connector terminals (6.35 or 2 x 2.8).
Please consult your Regional Sales Office.

814536



ZB5 AW0003

814537



ZB5 AW0001

Complete bodies (fixing collar + single contact block + light block with integral LED) (continued)

Light source	Supply voltage	Type of contact (1)		Colour of light source	Reference	Weight
		N/O	N/C			
	V					kg
Plug-in connector (2)						
Integral LED Protected LED	~ 24	1	-	White	ZB5 AW0B114	0.028
				Green	ZB5 AW0B314	0.028
				Red	ZB5 AW0B414	0.028
				Yellow	ZB5 AW0B514	0.028
				Blue	ZB5 AW0B614	0.028
		-	1	White	ZB5 AW0B124	0.028
				Green	ZB5 AW0B324	0.028
				Red	ZB5 AW0B424	0.028
				Yellow	ZB5 AW0B524	0.028
				Blue	ZB5 AW0B624	0.028
	2	-	White	ZB5 AW0B134	0.035	
			Green	ZB5 AW0B334	0.035	
			Red	ZB5 AW0B434	0.035	
			Yellow	ZB5 AW0B534	0.035	
			Blue	ZB5 AW0B634	0.035	
	1	1	White	ZB5 AW0B154	0.035	
			Green	ZB5 AW0B354	0.035	
			Red	ZB5 AW0B454	0.035	
			Yellow	ZB5 AW0B554	0.035	
			Blue	ZB5 AW0B654	0.035	
~ 48...120	1	-	White	ZB5 AW0G114	0.028	
			Green	ZB5 AW0G314	0.028	
			Red	ZB5 AW0G414	0.028	
			Yellow	ZB5 AW0G514	0.028	
			Blue	ZB5 AW0G614	0.028	
	-	1	White	ZB5 AW0G124	0.028	
			Green	ZB5 AW0G324	0.028	
			Red	ZB5 AW0G424	0.028	
			Yellow	ZB5 AW0G524	0.028	
			Blue	ZB5 AW0G624	0.028	



(1) Can be fitted with additional contact blocks: see page 36018/4.

(2) Connecting cables and connector for plug-in connector electrical blocks: see page 36018/4.

Other versions

Complete bodies with Faston connector terminals (6.35 or 2 x 2.8).
Please consult your Regional Sales Office.

Complete bodies (fixing collar + single contact block + light block with integral LED) (continued)

Light source	Supply voltage V	Type of contact (1)		Colour of light source	Reference	Weight kg
		N/O	N/C			
Plug-in connector (2) (continued)						
Integral LED Protected LED	~ 48...120	2	-	White	ZB5 AW0G134	0.035
				Green	ZB5 AW0G334	0.035
				Red	ZB5 AW0G434	0.035
				Yellow	ZB5 AW0G534	0.035
				Blue	ZB5 AW0G634	0.035
		1	1	White	ZB5 AW0G154	0.035
				Green	ZB5 AW0G354	0.035
				Red	ZB5 AW0G454	0.035
				Yellow	ZB5 AW0G554	0.035
				Blue	ZB5 AW0G654	0.035
	~ 230...240	1	-	White	ZB5 AW0M114	0.028
				Green	ZB5 AW0M314	0.028
				Red	ZB5 AW0M414	0.028
				Yellow	ZB5 AW0M514	0.028
				Blue	ZB5 AW0M614	0.028
		-	1	White	ZB5 AW0M124	0.028
				Green	ZB5 AW0M324	0.028
				Red	ZB5 AW0M424	0.028
				Yellow	ZB5 AW0M524	0.028
				Blue	ZB5 AW0M624	0.028
2	-	White	ZB5 AW0M134	0.035		
		Green	ZB5 AW0M334	0.035		
		Red	ZB5 AW0M434	0.035		
		Yellow	ZB5 AW0M534	0.035		
		Blue	ZB5 AW0M634	0.035		
1	1	White	ZB5 AW0M154	0.035		
		Green	ZB5 AW0M354	0.035		
		Red	ZB5 AW0M454	0.035		
		Yellow	ZB5 AW0M554	0.035		
		Blue	ZB5 AW0M654	0.035		



(1) Can be fitted with additional contact blocks: see page 36018/4.

(2) Connecting cables and connector for plug-in connector electrical blocks: see page 36018/4.

Other versions

Complete bodies with Faston connector terminals (6.35 or 2 x 2.8).
Please consult your Regional Sales Office.

Complete bodies (fixing collar + single contact block + light block for BA 9s bulb, incandescent, neon or LED)

Description	Light source	Supply voltage V	Type of contact (1)		Colour of light source	Reference	Weight kg
			N/O	N/C			
Screw clamp terminal connections							
Direct supply	BA 9s bulb, 2.4 W max. Not included (2)	≤ 250	1	–	–	ZB5 AW061	0.031
			–	1	–	ZB5 AW062	0.031
			2	–	–	ZB5 AW063	0.041
			1	1	–	ZB5 AW065	0.041
Via integral transformer 1.2 VA, 6 V secondary	BA 9s incandescent bulb, included	~ 110...120 50/60 Hz	1	–	–	ZB5 AW031	0.110
			1	1	–	ZB5 AW035	0.119
		~ 230 - 50 Hz	1	–	–	ZB5 AW041	0.110
		~ 220...240 - 60 Hz	1	1	–	ZB5 AW045	0.119
		~ 400 - 50 Hz	1	–	–	ZB5 AW051	0.110
			1	1	–	ZB5 AW055	0.119
	BA 9s base fitting LED included	~ 110...120 50/60 Hz	1	1	White	ZB5 AW03D15	0.119
					Green	ZB5 AW03D35	0.119
					Red	ZB5 AW03D45	0.119
					Yellow	ZB5 AW03D55	0.119
					Blue	ZB5 AW03D65	0.119
~ 230 - 50 Hz ~ 220...240 - 60 Hz	~ 110...120 50/60 Hz	1	1	White	ZB5 AW04D15	0.119	
				Green	ZB5 AW04D35	0.119	
				Red	ZB5 AW04D45	0.119	
				Yellow	ZB5 AW04D55	0.119	
				Blue	ZB5 AW04D65	0.119	
~ 400 50/60 Hz	~ 110...120 50/60 Hz	1	1	White	ZB5 AW05D15	0.120	
				Green	ZB5 AW05D35	0.120	
				Red	ZB5 AW05D45	0.120	
				Yellow	ZB5 AW05D55	0.120	
				Blue	ZB5 AW05D65	0.120	

(1) Can be fitted with additional contact blocks: see page 36018/2.
(2) Bulb to be ordered separately: see page 36018/14.

Other versions

Complete bodies with integral transformer incorporating Faston connector terminals (6.35 or 2 x 2.8).
Please consult your Regional Sales Office.

81-4549



ZB5 AW065

563156











ZB5 AW035

Harmony style 3 Illuminated pushbuttons and switches with double insulated bezel

To combine with bodies:
see pages 36017/2 to 36017/6



Sub-assemblies ZB5 A : heads

Heads for spring return illuminated pushbuttons





Shape of head	Type of push	Colour	Reference	Weight kg
Plain lens				
Only for use with bodies comprising a light source with integral LED				
 ZB5 AW313	Flush	White	ZB5 AW313	0.017
		Green	ZB5 AW333	0.017
		Red	ZB5 AW343	0.017
		Yellow	ZB5 AW353	0.017
		Blue	ZB5 AW363	0.017
 ZB5 AW363	Flush with illuminated ring	White	ZB5 AW913	0.016
		Green	ZB5 AW933	0.016
		Red	ZB5 AW943	0.016
		Yellow	ZB5 AW953	0.016
		Blue	ZB5 AW963	0.016
 ZB5 AW143	Flush with clear boot	White	ZB5 AW513	0.019
		Green	ZB5 AW533	0.019
		Red	ZB5 AW543	0.019
		Yellow	ZB5 AW553	0.019
		Blue	ZB5 AW563	0.019
 ZB5 CW113	Flush for insertion of legend	White	ZB5 AA18	0.018
		Green	ZB5 AA38	0.018
		Red	ZB5 AA48	0.018
		Yellow	ZB5 AA58	0.018
		Blue	ZB5 AA68	0.018
 ZB5 AW33	Projecting	White	ZB5 AW113	0.018
		Green	ZB5 AW133	0.018
		Red	ZB5 AW143	0.018
		Yellow	ZB5 AW153	0.018
		Blue	ZB5 AW163	0.018
	Flush (legend can be inserted)	White	ZB5 CW313	0.023
		Green	ZB5 CW333	0.023
		Red	ZB5 CW343	0.023
		Yellow	ZB5 CW353	0.023
		Blue	ZB5 CW363	0.023
Projecting (legend can be inserted)	White	ZB5 CW113	0.024	
	Green	ZB5 CW133	0.024	
	Red	ZB5 CW143	0.024	
	Yellow	ZB5 CW153	0.024	
	Blue	ZB5 CW163	0.024	
Grooved lens (For use in bright ambient light conditions - outdoors in sunlight, for example)				
Only for use with bodies comprising a light source with integral LED				
 ZB5 AW33	Flush	White	ZB5 AW313S	0.017
		Green	ZB5 AW333S	0.017
		Red	ZB5 AW343S	0.017
		Yellow	ZB5 AW353S	0.017
		Blue	ZB5 AW363S	0.017
Plain lens (1)				
 ZB5 AW33	Flush	White	ZB5 AW31	0.018
		Green	ZB5 AW33	0.018
		Red	ZB5 AW34	0.018
		Yellow	ZB5 AW35	0.018
		Blue	ZB5 AW36	0.018
		Clear	ZB5 AW37	0.018
		 ZB5 AW33	Projecting	White
Green	ZB5 AW13			0.017
Red	ZB5 AW14			0.017
Yellow	ZB5 AW15			0.017
Blue	ZB5 AW16			0.017
Clear	ZB5 AW17			0.017
Grooved lens (1) (For use in bright ambient light conditions - outdoors in sunlight, for example)				
 ZB5 AW33	Flush	White	ZB5 AW31S	0.018
		Green	ZB5 AW33S	0.018
		Red	ZB5 AW34S	0.018
		Yellow	ZB5 AW35S	0.018
		Blue	ZB5 AW36S	0.018
		Clear	ZB5 AW37S	0.018

(1) Only for use with bodies comprising a light source with BA 9s bulb (incandescent, neon or LED).

Heads for illuminated "push-push to release" pushbuttons (1)

Shape of head	Type of push	Colour of lens	Reference	Weight kg
Only for use with bodies comprising a light source with integral LED				
Protected LED				
	Flush	White	ZB5 AH013	0.017
		Green	ZB5 AH033	0.017
		Red	ZB5 AH043	0.017
		Yellow	ZB5 AH053	0.017
		Blue	ZB5 AH063	0.017
	Projecting	White	ZB5 AH13	0.017
		Green	ZB5 AH33	0.017
		Red	ZB5 AH43	0.017
		Yellow	ZB5 AH53	0.017
		Blue	ZB5 AH63	0.017
	Flush	White	ZB5 CH313	0.018
		Green	ZB5 CH333	0.018
		Red	ZB5 CH343	0.018
		Yellow	ZB5 CH353	0.018
		Blue	ZB5 CH363	0.018

Heads with pilot light for double-headed, spring return pushbuttons (IP 40) (2)

Shape of head	Description	Colour of pushes	Colour of pilot light	Reference	Weight kg
Only for use with bodies comprising a light source with integral LED					
Protected LED					
(without function marking on push)					
	1 flush push 1 central pilot light 1 flush push	Black	Clear (3)	ZB5 AW812743	0.022
		Red	Clear (3)	ZB5 AW813743	0.022
		Green Red	Clear (3)	ZB5 AW811723	0.022
	1 flush push 1 central pilot light 1 projecting push	White Black	Clear (3)	ZB5 AW812743	0.021
		Black Red	Clear (3)	ZB5 AW833743	0.021
		Green Red	Clear (3)	ZB5 AW831723	0.021
	1 flush push (marked "I") 1 central pilot light 1 flush push (marked "O")	White Black	Clear (3)	ZB5 AW822743	0.022
		Black Red	Clear (3)	ZB5 AW823743	0.022
		Green Red	Clear (3)	ZB5 AW821723	0.021
	1 flush push (marked "I") 1 central pilot light 1 projecting push (marked "O")	White Black	Clear (3)	ZB5 AW842743	0.021
		Black Red	Clear (3)	ZB5 AW843743	0.021
		Green Red	Clear (3)	ZB5 AW841723	0.021

Only for use with bodies comprising a light source with integral LED
(with function marking on push)

Protected LED					
	1 flush push (marked "I") 1 central pilot light 1 flush push (marked "O")	White Black	Clear (3)	ZB5 AW822743	0.022
		Black Red	Clear (3)	ZB5 AW823743	0.022
		Green Red	Clear (3)	ZB5 AW821723	0.021
	1 flush push (marked "I") 1 central pilot light 1 projecting push (marked "O")	White Black	Clear (3)	ZB5 AW842743	0.021
		Black Red	Clear (3)	ZB5 AW843743	0.021
		Green Red	Clear (3)	ZB5 AW841723	0.021

(1) Maximum of 1 row of 2 contact blocks on associated body/fixing collar sub-assembly.

(2) NEMA type 1, for a head with IP 66 degree of protection (NEMA type 4X) fit a clear sealing boot **ZBW 008**: see page 36018/15.

(3) Colour of centrally positioned pilot light determined by the colour of the LED incorporated in the body assembly.

814567



ZB5 AW833743

814568



ZB5 AW823743

814569



ZB5 AW843743



ZB5 AW743

Heads for Ø 40 latching mushroom head pushbuttons

Shape of head	Type of push	Colour of push	Reference	Weight kg
	Turn to release	White	ZB5 AW713	0,022
		Green	ZB5 AW733	0.022
		Red	ZB5 AW743	0.022
		Yellow	ZB5 AW753	0.022
		Blue	ZB5 AW763	0.022



ZB5 AK1213

Heads for illuminated selector switches with standard handle (1)

Shape of head	Number and type of positions	Colour of handle	Reference	Weight kg
Only for use with bodies comprising a light source with integral LED				
	2 - stay put	White	ZB5 AK1213	0.021
		Green	ZB5 AK1233	0.021
		Red	ZB5 AK1243	0.021
		Yellow	ZB5 AK1253	0.021
		Blue	ZB5 AK1263	0.021
	2 - spring return from right to left	White	ZB5 AK1413	0.021
		Green	ZB5 AK1433	0.021
		Red	ZB5 AK1443	0.021
		Yellow	ZB5 AK1453	0.021
		Blue	ZB5 AK1463	0.021
	3 - stay put	White	ZB5 AK1313	0.021
		Green	ZB5 AK1333	0.021
		Red	ZB5 AK1343	0.021
		Yellow	ZB5 AK1353	0.021
		Blue	ZB5 AK1363	0.021
	3 - spring return to centre	White	ZB5 AK1513	0.021
		Green	ZB5 AK1533	0.021
		Red	ZB5 AK1543	0.021
		Yellow	ZB5 AK1553	0.021
		Blue	ZB5 AK1563	0.021
	3 - spring return from right to centre	White	ZB5 AK1813	0.021
		Green	ZB5 AK1833	0.021
		Red	ZB5 AK1843	0.021
		Yellow	ZB5 AK1853	0.021
		Blue	ZB5 AK1863	0.021
	3 - spring return from left to centre	White	ZB5 AK1713	0.021
		Green	ZB5 AK1733	0.021
		Red	ZB5 AK1743	0.021
		Yellow	ZB5 AK1753	0.021
		Blue	ZB5 AK1763	0.021



ZB5 AK1463

(1) NEMA type 13.

Harmony style 3 Pushbuttons, switches and pilot lights with double insulated bezel

Separate components and accessories : electrical blocks



ZBE 101



ZBE 102



ZBE 203



ZBE 204

Contact blocks with screw clamp terminal connections (1)

Description	Type of contact		Sold in lots of	Unit reference	Weight kg
	N/O	N/C			
Standard single contact blocks	1	–	5	ZBE 101	0.011
	–	1	5	ZBE 102	0.011
Standard double contact blocks	2	–	5	ZBE 203	0.020
	–	2	5	ZBE 204	0.020
Special contact blocks for low power switching with gold flashed contacts	1	1	5	ZBE 205	0.020
	1	–	5	ZBE 1016	0.012
Special contact blocks for low power switching with gold flashed contacts and dust protection (2)	–	1	5	ZBE 1026	0.012
	1	–	5	ZBE 1016P	0.012
	–	1	5	ZBE 1026P	0.012

Body/fixing collar

For use with	Sold in lots of	Unit reference	Weight kg
Electrical blocks (contact or light)	10	ZB5 AZ009	0.006



ZB5 AZ009

Clip-on legend holders for electrical blocks with screw clamp terminal connections

Identification of an XB5 A control or signalling unit	10	ZBZ 001	0.001
---	----	---------	-------

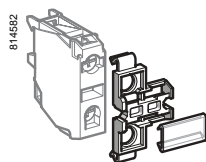

ZBZ 001

Sheet of 50 blank legends

Legend holder ZBY 001	10	ZBY 001	0.023
-----------------------	----	---------	-------

“SIS Label” labelling software (for legends ZBY 001)

Legend design for English, French, German, Italian, Spanish	1	XBY 2U	0.100
---	---	--------	-------

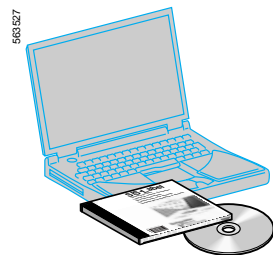

XBY 2U

- (1) The contact blocks enable variable composition of body sub-assemblies. Maximum number of rows possible: 3.
Either 3 rows of 3 single contacts or 1 row of 3 double contacts + 1 row of 3 single contacts (double contact blocks occupy 2 rows).
- (2) It is not possible to fit an additional contact block on the back of these blocks.

Other versions

Contact blocks with Faston connector terminals (6.35 or 2 x 2.8).
Please consult your Regional Sales Office.

Light blocks with screw clamp terminals

Description	Supply voltage V	Colour of light source	Sold in lots of	Unit reference	Weight kg	
Integral LED (to combine with heads for integral LED) Protected LED	≈ 12	White	5	ZBV J1 (1)	0.017	
		Green	5	ZBV J3 (1)	0.017	
		Red	5	ZBV J4 (1)	0.017	
		Yellow	5	ZBV J5 (1)	0.017	
		Blue	5	ZBV J6	0.017	
		White	5	ZBV B1 (1)	0.017	
	≈ 24	Green	5	ZBV B3 (1)	0.017	
		Red	5	ZBV B4 (1)	0.017	
		Yellow	5	ZBV B5 (1)	0.017	
		Blue	5	ZBV B6 (1)	0.017	
		≈ 24...120	White	5	ZBV BG1	0.017
			Green	5	ZBV BG3	0.017
	Red		5	ZBV BG4	0.017	
	Yellow		5	ZBV BG5	0.017	
	Blue		5	ZBV BG6	0.017	
	~ 48...120		White	5	ZBV G1 (1)	0.017
		Green	5	ZBV G3 (1)	0.017	
		Red	5	ZBV G4 (1)	0.017	
Yellow		5	ZBV G5 (1)	0.017		
Blue		5	ZBV G6 (1)	0.017		
~ 230...240		White	5	ZBV M1 (1)	0.017	
	Green	5	ZBV M3 (1)	0.017		
	Red	5	ZBV M4 (1)	0.017		
	Yellow	5	ZBV M5 (1)	0.017		
	Blue	5	ZBV M6 (1)	0.017		
	Direct supply for BA 9s bulb, 2.4 W max. Not included (1)	≤ 250	-	5	ZBV 6	0.016



ZBV B



ZBV V



ZB5 AZ009

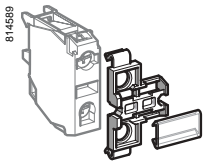

ZBZ 001

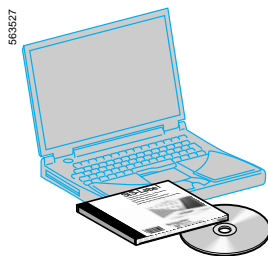

XBY 2U

LED suppressors

For use with	Supply voltage V	Reference	Weight kg
Light blocks with integral LED fitted with screw clamp terminal connections	~ 120	ZBZ VG	0.010
	~ 230	ZBZ VM	0.010

Body/fixing collar

For use with	Sold in lots of	Unit reference	Weight kg
Electrical block (contact or light)	10	ZB5 AZ009	0.006

Clip-on legend holders for electrical blocks with screw clamp terminal connections

Identification of an XB5 A control or signalling unit	10	ZBZ 001	0.001
---	----	---------	-------

Sheet of 50 blank legends

Legend holder ZBZ 001	10	ZBY 001	0.023
-----------------------	----	---------	-------

"SIS Label" labelling software (for legends ZBY 001)

Legend design for English, French, German, Italian, Spanish	1	XBY 2U	0.100
---	---	--------	-------

(1) To order a "high luminosity" version, add the suffix **S** to the reference (example: **ZBV B5S** for a yellow, 24 V, high luminosity light block).

(2) Bulb to be ordered separately: see page 36018/14.

Other versions

Light blocks with Faston connector terminals (6.35 or 2 x 2.8).
Please consult your Regional Sales Office.



ZBE 1014



ZBE 1024



ZBV B4

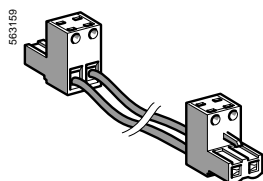

APE 1C2250

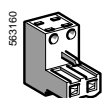

APE 1PAD21



ZB5 AZ009

Contact blocks for plug-in connector

Description	Type of contact		Sold in lots of	Unit reference	Weight
					kg
	N/O	N/C			
Standard contact blocks	1	–	5	ZBE 1014	0.009
	–	1	5	ZBE 1024	0.009

Light blocks for plug-in connector

Description	Supply voltage V	Colour of light source	Sold in lots of	Unit reference	Weight
					kg
Integral LED (to combine with heads for integral LED)	≈ 24	White	5	ZBV B14	0.016
		Green	5	ZBV B34	0.016
		Red	5	ZBV B44	0.016
		Yellow	5	ZBV B54	0.016
		Blue	5	ZBV B64	0.016
Protected LED	~ 48...120	White	5	ZBV G14	0.016
		Green	5	ZBV G34	0.016
		Red	5	ZBV G44	0.016
		Yellow	5	ZBV G54	0.016
		Blue	5	ZBV G64	0.016
	~ 230...240	White	5	ZBV M14	0.016
		Green	5	ZBV M34	0.016
		Red	5	ZBV M44	0.016
		Yellow	5	ZBV M54	0.016
		Blue	5	ZBV M64	0.016

Connecting cables and connector

Description	Number of connectors	Wire c.s.a. mm ²	Length mm	Sold in lots of	Unit reference	Weight
						kg
Cables with connectors 2-pin, 5.08 mm pitch	1	0.75	500	8	APE 1C2150	0.120
	2	0.75	500	8	APE 1C2250	0.180
Self-stripping connector 2-pin, 5.08 mm pitch	–	0.75	–	16	APE 1PAD21	0.080
Spring terminal connector 2-pin, 5.08 mm pitch	–	0.2 to 2.5	–	10	APE 1PRE21	0.003

Body/fixing collar

For use with	Sold in lots of	Unit reference	Weight
			kg
Electrical block (contact or light)	10	ZB5 AZ009	0.006

Harmony style 3 Pushbuttons, switches and pilot lights with double insulated bezel

Separate components and accessories : electrical blocks

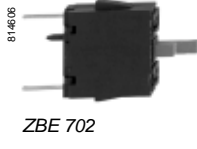
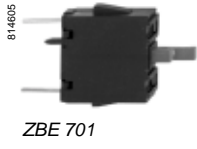

Contact blocks for printed circuit board connection (1)

Description	Type of contact		Sold in lots of	Unit reference	Weight kg
	N/O	N/C			
Standard contact blocks	1	–	10	ZBE 701	0.002
	–	1	10	ZBE 702	0.002
Special contact blocks for low power switching (with gold flashed contacts and dust protection)	1	–	10	ZBE 7016	0.003
	–	1	10	ZBE 7026	0.003

Light blocks for printed circuit board connection (1)

Description	Supply voltage V	Colour of LED	Sold in lots of	Unit reference	Weight kg
Integral LED (to combine with heads for integral LED)	~ 24	White	5	ZBV B17	0.004
		Green	5	ZBV B37	0.004
		Red	5	ZBV B47	0.004
		Yellow	5	ZBV B57	0.004
		Blue	5	ZBV B67	0.004

protected
LED

Adaptor (socket) for printed circuit board connection

For use with	Thickness of printed circuit board mm	Sold in lots of	Unit reference	Weight kg
Electrical block (contact or light)	1.6 ± 0.2	10	ZBZ 010	0.008
	2.2 ± 0.2	10	ZBZ 011	0.008
	3.2 ± 0.2	10	ZBZ 012	0.008

Accessories specifically for printed circuit board mounting (1)

Description	For use with	Sold in lots of	Unit reference	Weight kg
Fixing collar/pillar	Printed circuit board support	10	ZB5 AZ079	0.003
Fixing screw for printed circuit board	Fixing collar/pillar ZB5 AZ079	10	ZBZ 006	0.011

(1) For details of support drilling and of printed circuit board: see page 36021/9.
Must be used in conjunction with adaptor (socket) ZBZ 010.

Harmony style 3 Pushbuttons, switches and pilot lights with double insulated bezel

Separate components and accessories : for heads

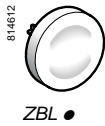
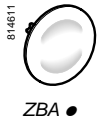

Pushbutton caps - unmarked

For use with	Type of push	Colour	Sold in lots of	Unit reference	Weight kg	
ZB5 AA0 circular pushbutton heads supplied without cap	Flush	White	10	ZBA 1	0.001	
		Black	10	ZBA 2	0.001	
		Green	10	ZBA 3	0.001	
		Red	10	ZBA 4	0.001	
		Yellow	10	ZBA 5	0.001	
		Blue	10	ZBA 6	0.001	
		6 colours (1)	1	ZBA 9	0.006	
		Projecting	White	10	ZBL 1	0.001
			Black	10	ZBL 2	0.001
			Green	10	ZBL 3	0.001
Red	10		ZBL 4	0.001		
Yellow	10		ZBL 5	0.001		
Blue	10		ZBL 6	0.001		
6 colours (1)	1		ZBL 9	0.006		

Pushbutton caps - marked (3) (sold in lots of 10)

For use with	Type of push	Marking		Colour of cap	Unit reference	Weight kg
		Text	Colour			
ZB5 AA0 circular pushbutton heads supplied without cap	Flush	I (2)	White	Green	ZBA 331	0.001
			Black	White	ZBA 131	0.001
		II	White	Green	ZBA 336	0.001
			Black	White	ZBA 136	0.001
		III	White	Green	ZBA 337	0.001
			Black	White	ZBA 137	0.001
		IV	White	Green	ZBA 338	0.001
			Black	White	ZBL 138	0.001
		START (2)	White	Green	ZBA 333	0.001
			Black	White	ZBA 133	0.001
		ON	White	Green	ZBA 341	0.001
			Black	White	ZBA 141	0.001
		MARCHE	White	Green	ZBA 342	0.001
			Black	White	ZBA 142	0.001
		UP (2)	Black	White	ZBA 343	0.001
		DOWN (2)	White	Black	ZBA 344	0.001
		⊕ (2)	White	Black	ZBA 245	0.001
			Black	White	ZBA 145	0.001
		↑	White	Black	ZBA 335	0.001
			Black	White	ZBA 334	0.001
		O (2)	White	Red	ZBA 432	0.001
			Black	Black	ZBA 232	0.001
		ARRET	White	Red	ZBA 433	0.001
			Black	Black	ZBA 233	0.001
		STOP (2)	White	Red	ZBA 434	0.001
			Black	Black	ZBA 234	0.001
		OFF	White	Red	ZBA 435	0.001
			Black	Black	ZBA 235	0.001
		⚠	White	Green	ZBA 346	0.001
		R (2)	White	Blue	ZBA 639	0.001
		+	White	Black	ZBA 2934	0.001
		-	White	Black	ZBA 2935	0.001

(1) Set of 6 different coloured caps: white, black, green, red, yellow, blue.

(2) Double injection moulded marking.

(3) Can be clipped-in at 90° steps, through 360°.

Harmony style 3 Pushbuttons, switches and pilot lights with double insulated bezel

Separate components and accessories : for heads

Standard (30 x 40 mm) legend holders for 8 x 27 mm legends (1)

Description	Legend Colour	Marking	Sold in lots of	Unit reference	Weight kg		
Without legend	–	–	10	ZBZ 32	0,001		
With blank legend (for engraving)	Black or red background	–	10	ZBY 2101	0.002		
	White or yellow background	–	10	ZBY 4101	0.002		
With 8 x 27 mm legend (with International marking)	Black or red background (2)	O (black background)	1	ZBY 2146	0.002		
		O (red background)	1	ZBY 2931	0.002		
		I	1	ZBY 2147	0.002		
		II	1	ZBY 2148	0.002		
		O-I	1	ZBY 2178	0.002		
		I-II	1	ZBY 2179	0.002		
		I-O-II	1	ZBY 2186	0.002		
		AUTO	1	ZBY 2115	0.002		
		STOP	1	ZBY 2304	0.002		
		With 8 x 27 mm legend (with French language marking)	Black or red background (2)	ARRET (red background)	1	ZBY 2104	0.002
				ARRET (black background)	1	ZBY 0104	0.002
				ARRET GENERAL	1	ZBY 2129	0.002
ARRET REARMEMENT	1			ZBY 2133	0.002		
ARRET D'URGENCE	1			ZBY 2130	0.002		
ARRET-MARCHE	1			ZBY 2166	0.002		
ARRIERE	1			ZBY 2106	0.002		
AUTO CYCLE-CYCLE	1			ZBY 2198	0.002		
AUTO CYCLE-MAIN	1			ZBY 2199	0.002		
AUTO-MAIN	1			ZBY 2164	0.002		
AUTO-O-MAIN	1			ZBY 2185	0.002		
AVANT	1			ZBY 2105	0.002		
AVANT-O-ARRIERE	1			ZBY 2184	0.002		
C-P-C-NORMAL	1			ZBY 2165	0.002		
CYCLE-MAIN	1			ZBY 2197	0.002		
DECLenchement	1			ZBY 2132	0.002		
DEFAULT (black background)	1			ZBY 2134	0.002		
DEFAULT (red background)	1			ZBY 2135	0.002		
DEPART CYCLE	1			ZBY 2195	0.002		
DESCENTE	1			ZBY 2108	0.002		
DROITE	1			ZBY 2109	0.002		
ENCLenchement	1			ZBY 2131	0.002		
EN SERVICE	1			ZBY 2111	0.002		
FERMETURE	1			ZBY 2114	0.002		
GAUCHE	1			ZBY 2110	0.002		
HORS SERVICE	1			ZBY 2112	0.002		
HORS-EN	1			ZBY 2167	0.002		
LENT	1			ZBY 2127	0.002		
MAIN	1			ZBY 2116	0.002		
MARCHE	1			ZBY 2103	0.002		
MONTEE	1			ZBY 2107	0.002		
Ouverture	1			ZBY 2113	0.002		
PHASE / PHASE	1	ZBY 2196	0.002				
REARMEMENT (red background)	1	ZBY 2123	0.002				
REARMEMENT (black background)	1	ZBY 0123	0.002				
SOUS TENSION	1	ZBY 2126	0.002				
VITE	1	ZBY 2128	0.002				

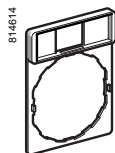

ZBZ 32

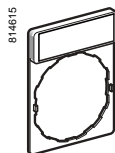

ZBY ●101

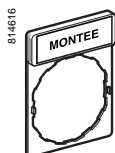

ZBY 2107

(1) For legends, see pages 36018/9 to 36018/11.

(2) "Start" functions: white letters on black background. "Stop" functions: white letters on red background (unless otherwise specified above).

Harmony style 3 Pushbuttons, switches and pilot lights with double insulated bezel

Separate components and accessories : for heads

Standard (30 x 40 mm) legend holders for 8 x 27 mm legends (continued)

Description	Legend Colour	Marking	Reference	Weight kg
With legend (with English language marking)	Black or red background (1)	AUTO-HAND	ZBY 2364	0.002
		AUTO-O-HAND	ZBY 2385	0.002
		CLOSE	ZBY 2314	0.002
		DOWN	ZBY 2308	0.002
		EMERGENCY STOP	ZBY 2330	0.002
		FAST	ZBY 2328	0.002
		FORWARD	ZBY 2305	0.002
		HAND	ZBY 2316	0.002
		HAND-OFF-AUTO	ZBY 2387	0.002
		INCH	ZBY 2321	0.002
		LEFT	ZBY 2310	0.002
		OFF	ZBY 2312	0.002
		OFF-ON	ZBY 2167	0.002
		ON	ZBY 2311	0.002
		OPEN	ZBY 2313	0.002
		POWER ON	ZBY 2326	0.002
		RESET (red background)	ZBY 2323	0.002
		RESET (black background)	ZBY 2322	0.002
		REVERSE	ZBY 2306	0.002
		RIGHT	ZBY 2309	0.002
		RUN	ZBY 2334	0.002
		SLOW	ZBY 2327	0.002
		START	ZBY 2303	0.002
		STOP-START	ZBY 2366	0.002
		UP	ZBY 2307	0.002
		With legend (with German language marking)	Black or red background(1)	AB
AUF	ZBY 2207			0.002
AUS	ZBY 2204			0.002
AUS-EIN	ZBY 2266			0.002
AUS-IN BETRIEB	ZBY 2267			0.002
AUS-RUCKSTELLUNG	ZBY 2233			0.002
AUSSCHALTEN	ZBY 2232			0.002
AUTO-HAND	ZBY 2364			0.002
AUTO-O-HAND	ZBY 2385			0.002
AUTOZYKL-HAND	ZBY 2299			0.002
AUTOZYKL-1 ZYKL	ZBY 2298			0.002
C-P-C-NORMAL	ZBY 2265			0.002
EIN	ZBY 2203			0.002
EINSCHALTEN	ZBY 2231			0.002
HAND	ZBY 2316			0.002
LANGSAM	ZBY 2227			0.002
LINKS	ZBY 2210			0.002
NOT-AUS (red background)	ZBY 2230			0.002
NOT-AUS (yellow background)	ZBY 22420001			0.002
NOT-HALT	ZBY 2229			0.002
ÖFFNEN	ZBY 2213			0.002
RECHTS	ZBY 2209			0.002
RUCKSTELLUNG	ZBY 2223			0.002
SCHLIESSEN	ZBY 2214			0.002
SCHNELL	ZBY 2228			0.002
SPANNUNG EIN	ZBY 2226			0.002
STEUERUNG AUS	ZBY 2212			0.002
STEUERUNG EIN	ZBY 2211			0.002
STORUNG (black background)	ZBY 2234			0.002
STORUNG (red background)	ZBY 2235			0.002
VOR	ZBY 2205			0.002
VOR-O-ZURUCK	ZBY 2284			0.002
ZURUCK	ZBY 2206			0.002
ZYKLUS-HAND	ZBY 2297			0.002
ZYKLUSSTART	ZBY 2295			0.002

(1) "Start" functions: white letters on black background. "Stop" functions: white letters on red background (unless otherwise specified above).

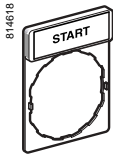

ZBY 2303

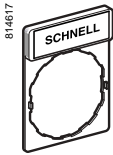

ZBY 2228

Harmony style 3 Pushbuttons, switches and pilot lights with double insulated bezel

Separate components and accessories : for heads

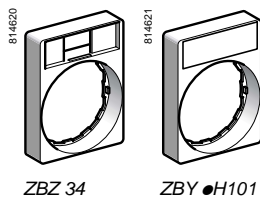

ZBZ 34

ZBY 6H10

30 x 40 mm legend holders (flush mounting with bezel) for 8 x 27 mm legends

Description	For use with	Colour	Sold in lots of	Unit reference	Weight kg
Without legend	Circular heads	–	10	ZBZ 34	0.003
	Square heads	–	10	ZBC Z34	0.002
With blank legend	Circular heads	Black or red background	10	ZBY 2H101	0.004
		White or yellow background	10	ZBY 4H101	0.004
	Square heads	Black or red background	10	ZBC Y2H101	0.002
		White or yellow background	10	ZBC Y4H101	0.002

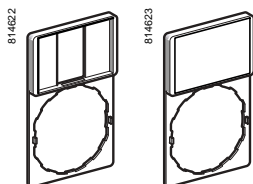

ZBZ 33

ZBY 610

Standard (30 x 50 mm) legend holders for 18 x 27 mm legends

Description	For use with	Colour	Sold in lots of	Unit reference	Weight kg
Without legend	Circular and square heads	–	10	ZBZ 33	0.001
With blank legend	Circular and square heads	Black or red background	10	ZBY 6101	0.002
		White or yellow background	10	ZBY 6102	0.002

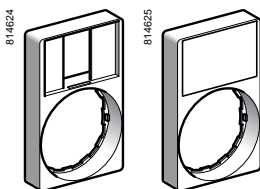

ZBZ 35

ZBY 6H10

30 x 50 mm legend holders (flush mounting with bezel) for 18 x 27 mm legends

Description	For use with	Colour	Sold in lots of	Unit reference	Weight kg
Without legend	Circular heads	–	10	ZBZ 35	0.003
	Square heads	–	10	ZBC Z35	0.002
With blank legend	Circular heads	Black or red background	10	ZBY 6H101	0.004
		White or yellow background	10	ZBY 6H102	0.004
	Square heads	Black or red background	10	ZBC Y6H101	0.003
		White or yellow background	10	ZBC Y6H102	0.003

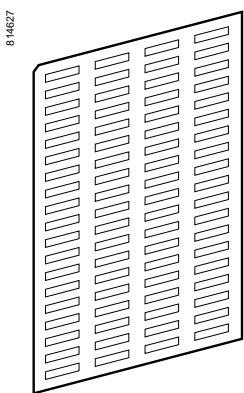

ZBY 4100

Legends for engraving

Description mm	For use with	Colour	Sold in lots of	Unit reference	Weight kg
8 x 27	30 x 40 mm legend holders	Black or red background	10	ZBY 0101	0.001
		White or yellow background	10	ZBY 0102	0.001
18 x 27	30 x 50 mm legend holders	Black or red background	10	ZBY 5101	0.001
		White or yellow background	10	ZBY 5102	0.001

Sheets of peel-off legends (with backing board and protective transparent cover)

Description	For use with	Sold in lots of	Unit reference	Weight kg
Sheet of 76 8 x 27 mm legends	30 x 40 mm legend holders ZBZ 32 and ZBZ 34	10	ZBY 4100	0.043
Sheet of 40 18 x 27 mm legends	30 x 50 mm legend holders ZBZ 33 and ZBZ 35	10	ZBY 5100	0.044

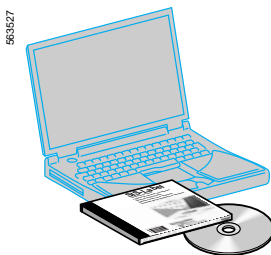

XBY 2U

“SIS Label” labelling software

Application	Reference	Weight kg
Legend design for English, French, German, Italian, Spanish	XBY 2U	0.100

Harmony style 3 Pushbuttons, switches and pilot lights with double insulated bezel

Separate components and accessories : for heads

8 x 27 mm marked legends (for 30 x 40 mm legend holders ZBZ 32 and ZBZ 34)

Colour	Marking	Reference	Weight kg		
Black or red background (1)	International	O (black background)	ZBY 02146	0,001	
		O (red background)	ZBY 02931	0,001	
		I	ZBY 02147	0,001	
		II	ZBY 02148	0,001	
		O-I	ZBY 02178	0,001	
		I-II	ZBY 02179	0,001	
		I-O-II	ZBY 02186	0,001	
		AUTO	ZBY 02115	0,001	
		STOP	ZBY 02304	0,001	
		French	ARRET (red background)	ZBY 02104	0,001
			ARRET (black background)	ZBY 00104	0,001
			ARRET GENERAL	ZBY 02129	0,001
			ARRET REARMEMENT	ZBY 02133	0,001
ARRET D'URGENCE	ZBY 02130		0,001		
ARRET-MARCHE	ZBY 02166		0,001		
ARRIERE	ZBY 02106		0,001		
AUTO CYCLE-CYCLE	ZBY 02198		0,001		
AUTO CYCLE-MAIN	ZBY 02199		0,001		
AUTO-MAIN	ZBY 02164		0,001		
AUTO-O-MAIN	ZBY 02185		0,001		
AVANT	ZBY 02105		0,001		
AVANT-O-ARRIERE	ZBY 02184		0,001		
C-P-C-NORMAL	ZBY 02165		0,001		
CYCLE-MAIN	ZBY 02197		0,001		
DECLENCHEMENT	ZBY 02132		0,001		
DEFAUT (black background)	ZBY 02134		0,001		
DEFAUT (red background)	ZBY 02135		0,001		
DEPART CYCLE	ZBY 02195		0,001		
DESCENTE	ZBY 02108		0,001		
DROITE	ZBY 02109		0,001		
ENCLENCHEMENT	ZBY 02131		0,001		
EN SERVICE	ZBY 02111		0,001		
FERMETURE	ZBY 02114		0,001		
GAUCHE	ZBY 02110		0,001		
HORS SERVICE	ZBY 02112		0,001		
HORS-EN	ZBY 02167		0,001		
LENT	ZBY 02127		0,001		
MAIN	ZBY 02116		0,001		
MARCHE	ZBY 02103		0,001		
MONTEE	ZBY 02107		0,001		
OUVERTURE	ZBY 02113		0,001		
PHASE / PHASE	ZBY 02196		0,001		
REARMEMENT (red background)	ZBY 02123	0,001			
REARMEMENT (black background)	ZBY 00123	0,001			
SOUS TENSION	ZBY 02126	0,001			
VITE	ZBY 02128	0,001			

(1) "Start" functions: white letters on black background. "Stop" functions: white letters on red background (unless otherwise specified above).

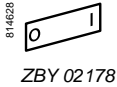

Harmony style 3 Pushbuttons, switches and pilot lights with double insulated bezel

Separate components and accessories : for heads

8 x 27 mm marked legends (for 30 x 40 mm legend holders ZBZ 32 and ZBZ 34) (continued)

Colour	Marking	Reference	Weight kg			
Black or red background (1)	English	AUTO-HAND	ZBY 02364	0,001		
		AUTO-O-HAND	ZBY 02385	0.001		
		CLOSE	ZBY 02314	0.001		
		DOWN	ZBY 02308	0.001		
		EMERGENCY STOP	ZBY 02330	0.001		
		FAST	ZBY 02328	0.001		
		FORWARD	ZBY 02305	0.001		
		HAND	ZBY 02316	0.001		
		HAND-OFF-AUTO	ZBY 02387	0.001		
		INCH	ZBY 02321	0.001		
		LEFT	ZBY 02310	0.001		
		OFF	ZBY 02312	0.001		
		OFF-ON	ZBY 02367	0.001		
		ON	ZBY 02311	0.001		
		OPEN	ZBY 02313	0.001		
		POWER ON	ZBY 02326	0.001		
		RESET (red background)	ZBY 02323	0.001		
		RESET (black background)	ZBY 02322	0.001		
		REVERSE	ZBY 02306	0.001		
		RIGHT	ZBY 02309	0.001		
		RUN	ZBY 02334	0.001		
		SLOW	ZBY 02327	0.001		
		START	ZBY 02303	0.001		
		STOP-START	ZBY 02366	0.001		
		UP	ZBY 02307	0.001		
			German	AB	ZBY 02208	0.001
				AUF	ZBY 02207	0.001
				AUS	ZBY 02204	0.001
				AUS-EIN	ZBY 02266	0.001
				AUS-IN BETRIEB	ZBY 02267	0.001
				AUS-RUCKSTELLUNG	ZBY 02233	0.001
				AUSSCHALLEN	ZBY 02232	0.001
				AUTO-HAND	ZBY 02364	0.001
AUTO-O-HAND	ZBY 02385			0.001		
AUTOZYKL-HAND	ZBY 02299			0.001		
AUTOZYKL- 1 ZYKL	ZBY 02298			0.001		
C-P-C-NORMAL	ZBY 02265			0.001		
EIN	ZBY 02203			0.001		
EINSCHALTEN	ZBY 02231			0.001		
HAND	ZBY 02316			0.001		
LANGSAM	ZBY 02227			0.001		
LINKS	ZBY 02210			0.001		
NOT-AUS (red background)	ZBY 02230			0.001		
NOT-AUS (yellow background)	ZBY 022420001			0.001		
NOT-HALT	ZBY 02229			0.001		
ÖFFNEN	ZBY 02213			0.001		
RECHTS	ZBY-02209			0.001		
RUCKSTELLUNG	ZBY-02223			0.001		
SCHLIESSEN	ZBY-02214			0.001		
SCHNELL	ZBY-02228			0.001		
SPANNUNG EIN	ZBY-02226			0.001		
STEUERUNG AUS	ZBY-02212			0.001		
STEUERUNG EIN	ZBY-02211			0.001		
STORUNG (black background)	ZBY-02234			0.001		
STORUNG (red background)	ZBY-02235			0.001		
VOR	ZBY-02205			0.001		
VOR-O-ZURUCK	ZBY-02284			0.001		
ZURUCK	ZBY-02206			0.001		
ZYKLUS-HAND	ZBY-02297	0.001				
ZYKLUSSTART	ZBY-02295	0.001				

(1) "Start" functions: white letters on black background. "Stop" functions: white letters on red background (unless otherwise specified above).

814633
START
ZBY 02303

814632
SCHNELL
ZBY 02228

Harmony style 3 Pushbuttons, switches and pilot lights with double insulated bezel

Separate components and accessories : for heads

Legends for pushbuttons, switches and pilot lights XB5 A

Description	Marking		Sold in lots of	Unit reference	Weight kg	
Sheets of 66 circular peel-off transparent self-adhesive legends	Without		10	ZBY 1101	0.017	
	International	O	10	ZBY 1146	0.017	
Strips of 66 circular peel-off transparent self-adhesive legends		I	10	ZBY 1147	0.017	
		II	10	ZBY 1148	0.017	
		III	10	ZBY 1149	0.017	
		STOP	10	ZBY 1304	0.017	
		↑	10	ZBY 1912	0.017	
	French	ARRET		10	ZBY 1104	0.017
		ARRIERE		10	ZBY 1106	0.017
		AUTO		10	ZBY 1115	0.017
		AVANT		10	ZBY 1105	0.017
		DESCENTE		10	ZBY 1108	0.017
		MAIN		10	ZBY 1116	0.017
		MARCHE		10	ZBY 1103	0.017
		MONTEE		10	ZBY 1107	0.017
	English	HAND		10	ZBY 1316	0.017
		OFF		10	ZBY 1312	0.017
		ON		10	ZBY 1311	0.017
		START		10	ZBY 1303	0.017
German	AB		10	ZBY 1208	0.017	
	AUF		10	ZBY 1207	0.017	
	AUS		10	ZBY 1204	0.017	
	EIN		10	ZBY 1203	0.017	
	ZU		10	ZBY 1214	0.017	
Strip of 66 square peel-off transparent self-adhesive legends	Without		10	ZBC Y1101	0.017	

8146334

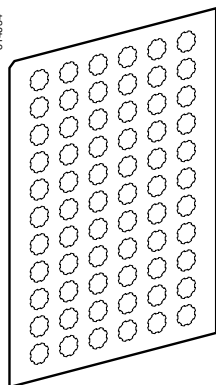

ZBY 1101

“SIS Label” labelling software

Application	Unit reference	Weight kg
Legend design for English, French, German, Italian, Spanish	XYB 2U	0.100

563927



XYB 2U

Circular legends for Emergency stop mushroom head pushbuttons (yellow)

Diameter mm	Marking on yellow background	Reference	Weight kg
60	Without	ZBY 9101	0.004
	ARRET D'URGENCE	ZBY 9130	0.004
	EMERGENCY STOP	ZBY 9330	0.004
	NOT-AUS	ZBY 9230	0.004
90	Without	ZBY 8101	0.008
	ARRET D'URGENCE	ZBY 8130	0.008
	EMERGENCY STOP	ZBY 8330	0.008
	NOT-AUS	ZBY 8230	0.008

563089



ZBY 9130

Harmony style 3 Pushbuttons, switches and pilot lights with double insulated bezel

Separate components and accessories

563155

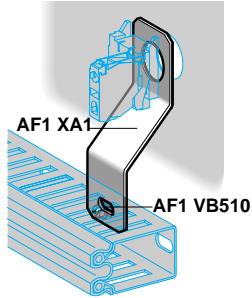

563156

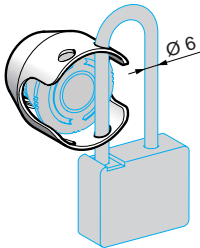

ZBZ 160

814640

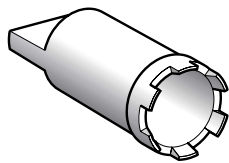

ZB5 AZ905

814645

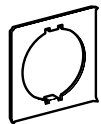

ZB5 AZ902



ZB4 BZ64

501562

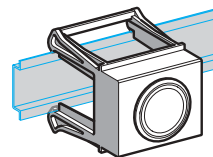

15151

563157

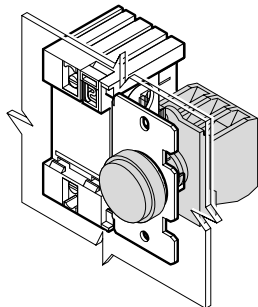

XBZ S43

Accessories

Description	Application		Sold in lots of	Unit reference	Weight kg
Cable ducting support	Fixing beneath head		10	AF1 XA1	0.030
M5 x 10 screw, with hexagonal slotted head	For fixing cable ducting		100	AF1 VB510	0.003
Support	For pushbuttons, switches and pilot lights XB5 A		1	DX1 AP52	0.160
Metal guards Padlockable (1)	For Emergency stop function only with the following Ø 40 trigger action pushbuttons: XB5 AT8●, XB5 AS8●, XB5 AS9●, ZB5 AT8●, ZB5 AS8●, ZB5 AS9●.	Chromium plated	1	ZBZ 1600	0.046
		Black	1	ZBZ 1602	0.046
		Red	1	ZBZ 1604	0.046
		Yellow	1	ZBZ 1605	0.046
		Blue	1	ZBZ 1606	0.046
Plastic guard	For selector switches with standard handle or key switches	Black	1	ZBZ 2102	0.005
Plastic blanking plug, round, black (2)	For Ø 22 control and signalling units with circular head		10	ZB5 SZ3	0.008
Plastic blanking plug, square, black (2)	For Ø 22 control and signalling units with square head		10	ZB5 SZ5	0.009
Add-on square trim	Gives a square appearance to ZB5 A circular heads		10	ZB5 AZ31	0.002
Nut	Fixing the head		10	ZB5 AZ901	0.002
Bezel tool	Tightening head fixing nut ZB5 AZ901		1	ZB5 AZ905	0.016
Anti-rotation plate	Prevents rotation of the head		10	ZB5 AZ902	0.008
Padlockable flaps	For pushbuttons	Black	1	ZB4 BZ62	0.076
		Red	1	ZB4 BZ64	0.076
		Yellow	1	ZB4 BZ65	0.076
		Blue	1	ZB4 BZ66	0.076
Pushbutton support	For 35 mm DIN rail, for use in modular enclosure (3)		1	15151	0.040

AS-Interface module for Ø 22 control and signalling units

Description	For use with	Unit reference	Weight kg
Panel fixing, in conjunction with a Harmony pushbutton or switch			
S7.F profile	4 inputs and 4 outputs direct supply from the bus	XBZ S43	0.100







- (1) No isolation function is possible when this guard is fitted.
 (2) Supplied complete with fixing nut.
 (3) Marketed under the Merlin Gerin brand.

Harmony style 3 Pushbuttons, switches and pilot lights with double insulated bezel

Separate components, accessories and replacement parts

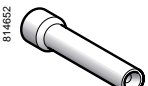
BA 9s bulbs and associated accessories

Description	Characteristics	Colour	Sold in lots of	Unit reference	Weight kg			
 DL1 CE●●●	≈ 24 V	White	1	DL1 CJ0241	0.002			
		Green	1	DL1 CJ0243	0.002			
		Red	1	DL1 CJ0244	0.002			
		Yellow	1	DL1 CJ0245	0.002			
		Blue	1	DL1 CJ0246	0.002			
		 DL1 CJ0●●●	≈ 48 V	Green	1	DL1 CJ0483	0.002	
				Red	1	DL1 CJ0484	0.002	
				Yellow	1	DL1 CJ0485	0.002	
				6 V -1.2 W	White	1	DL1 CD0061	0.002
					Green	1	DL1 CD0063	0.002
					Red	1	DL1 CD0064	0.002
		 DL1 CF●●●	6 V -1.2 W	Yellow	1	DL1 CD0065	0.002	
Blue	1			DL1 CD0066	0.002			
White	1			DL1 CD0061	0.002			
 XBF X13	6 V -1.2 W	–	10	DL1 CB006	0.002			
	24 V - 2 W	–	10	DL1 CE024	0.002			
	120...130 V - 2. W	–	10	DL1 CE130	0.002			
 ZBF X13	120...130 V	–	10	DL1 CF110	0.002			
	230...240 V	–	10	DL1 CF220	0.002			
Bulb extractor	–	–	1	XBF X13	0.005			
Lens cap tightening tool	Illuminated pushbuttons, with flush push	–	1	ZBZ 8	0.009			

Replacement keys for Emergency stop key release heads and key switches

Description	Key number	Reference	Weight kg
 ZBG 455	455	ZBG 455	0.013
	421E	ZBG 421E	0.014
	458A	ZBG 458A	0.014
	520E	ZBG 520E	0.014
	3131A	ZBG 3131A	0.014
	4A185	ZBD A185	0.014
	LU1	ZBD LU1	0.014
	LU2	ZBD LU2	0.014
	LU3	ZBD LU3	0.014
	LU4	ZBD LU4	0.014
	LU5	ZBD LU5	0.014
	LU6	ZBD LU6	0.014
	LU7	ZBD LU7	0.014
	LU8	ZBD LU8	0.014
	LU9	ZBD LU9	0.014
	LU10	ZBD LU10	0.014
	LU11	ZBD LU11	0.014
	LU12	ZBD LU12	0.014
	LU13	ZBD LU13	0.014
	LU14	ZBD LU14	0.014
8D1	ZBD 8D1	0.014	

Clear boots

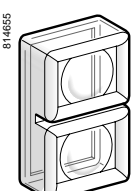
Description	For use with pushbuttons	Sold in lots of	Unit reference	Weight kg
 ZBW 008	Flush with circular head	10	ZBP A	0.002
	Projecting with circular head	10	ZBP 0	0.002
	Flush or projecting with circular head for food industry applications	10	ZBP 0A	0.002
Double boots	Flush or projecting double-headed	10	ZBW 008	0.005
	Flush double-headed	10	ZBW 008F	0.005
	Double-headed for food industry applications	10	ZBW 008A	0.005

Coloured boots

Description	Colour	Sold in lots of	Unit reference	Weight kg
Coloured boots (can be replaced without dismantling the head)	Black	10	ZB2 BP012	0.003
	Green	10	ZB2 BP013	0.003
	Red	10	ZB2 BP014	0.003
	Yellow	10	ZB2 BP015	0.003
	Blue	10	ZB2 BP016	0.003

Lens caps

For use with	Colour	Sold in lots of	Unit reference	Weight kg
--------------	--------	-----------------	----------------	-----------

Circular lens caps for light sources with integral LED

Pilot lights	White	10	ZBV 0113	0.002
	Green	10	ZBV 0133	0.002
	Red	10	ZBV 0143	0.002
	Yellow	10	ZBV 0153	0.002
	Blue	10	ZBV 0163	0.002
	5 different coloured grooved lenses (1)	1	ZBV 0103S	0.010
Illuminated pushbuttons, with flush push	White	10	ZBW 9113	0.002
	Green	10	ZBW 9133	0.002
	Red	10	ZBW 9143	0.002
	Yellow	10	ZBW 9153	0.002
	Blue	10	ZBW 9163	0.002
Illuminated pushbuttons, with projecting push	White	10	ZBW 9313	0.002
	Green	10	ZBW 9333	0.002
	Red	10	ZBW 9343	0.002
	Yellow	10	ZBW 9353	0.002
	Blue	10	ZBW 9363	0.002

Square lens caps for light sources with integral LED

Pilot lights	White	10	ZBC V0113	0.002
	Green	10	ZBC V0133	0.002
	Red	10	ZBC V0143	0.002
	Yellow	10	ZBC V0153	0.002
	Blue	10	ZBC V0163	0.002
	Illuminated pushbuttons, with flush push	White	10	ZBC W9113
Green		10	ZBC W9133	0.002
Red		10	ZBC W9143	0.002
Yellow		10	ZBC W9153	0.002
Blue		10	ZBC W9163	0.002
Illuminated pushbuttons, with projecting push	White	10	ZBC W9313	0.002
	Green	10	ZBC W9333	0.002
	Red	10	ZBC W9343	0.002
	Yellow	10	ZBC W9353	0.002
	Blue	10	ZBC W9363	0.002

Circular lens caps for light sources with BA 9s base fitting

Pilot lights	White	10	ZBV 011	0.002
	Green	10	ZBV 013	0.002
	Red	10	ZBV 014	0.002
	Yellow	10	ZBV 015	0.002
	Blue	10	ZBV 016	0.002
	Clear	10	ZBV 017	0.002
	Illuminated pushbuttons, with flush push	White	10	ZBW 911
Green		10	ZBW 913	0.002
Red		10	ZBW 914	0.002
Yellow		10	ZBW 915	0.002
Blue		10	ZBW 916	0.002
Clear		10	ZBW 917	0.002
Illuminated pushbuttons, with projecting push	White	10	ZBW 931	0.002
	Green	10	ZBW 933	0.002
	Red	10	ZBW 934	0.002
	Yellow	10	ZBW 935	0.002
	Blue	10	ZBW 936	0.002
	Clear	10	ZBW 937	0.002

(1) Clear, green, red, yellow, blue.



ZBV 0103



ZBV 010

Pilot lights

Integral LED

XB5 AVB●, AVG●, AVM●

Direct supply

XB5 AV6

Via integral transformer

XB5 AV3●, AV4●

Common face view

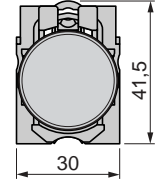
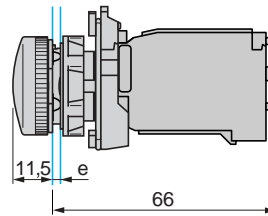
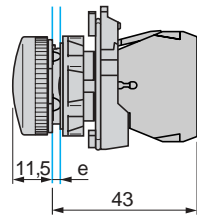
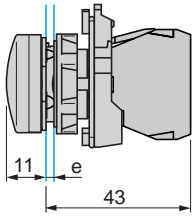

e: panel thickness: 1 to 6 mm

Illuminated pushbuttons

Integral LED

XB5 AW3●●5

Direct supply

XB5 AW3●65

Via integral transformer

XB5 AW3●●5

Common face view

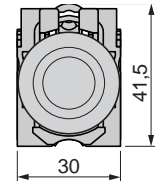
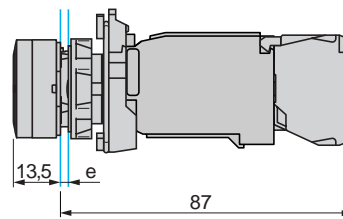
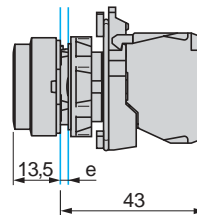
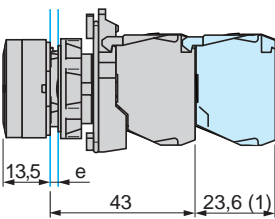

(1) Additional row of contacts or double contact.

Double-headed pushbuttons with pilot light

Integral LED

XB5 AW84●5

Illuminated selector switches

Integral LED

XB5 AK12●●5

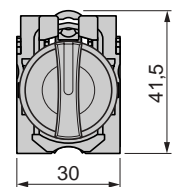
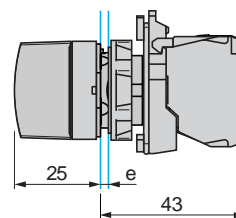
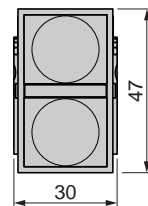
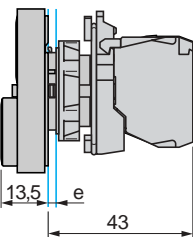

e: panel thickness: 1 to 6 mm

Panel cut-out for pushbuttons, switches and pilot lights (2)

Screw clamp terminal and plug-in connector models

Printed circuit board connection models

Detail of lug recess

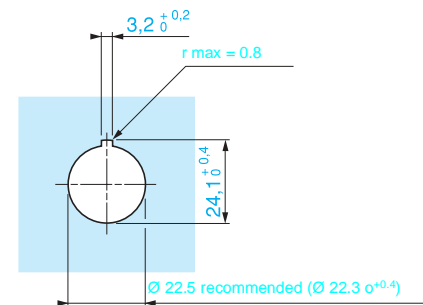
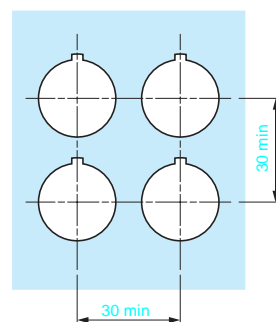
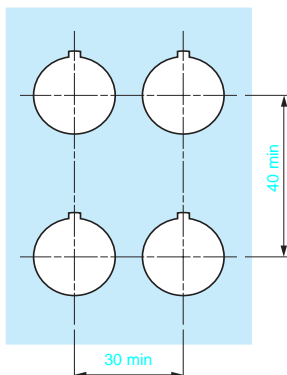

(2) Fixing centres for pushbuttons, switches and pilot lights fitted with Faston connector terminals 32 x 45 min.

Pushbuttons, spring return

XB5 AA●●

XB5 AL●●

Common face
view

XB5 AP●●

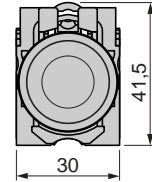
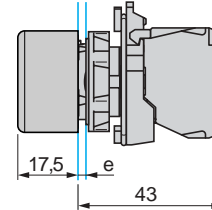
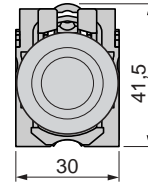
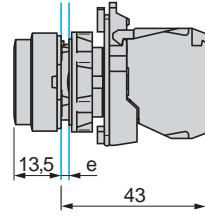
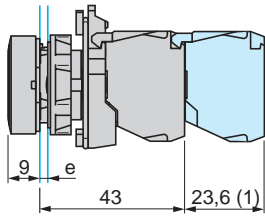

(1) Additional row of contacts or double contact.

Mushroom head

XB5 AC21

Double-headed

XB5 AL●45, AL●4C5

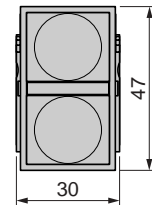
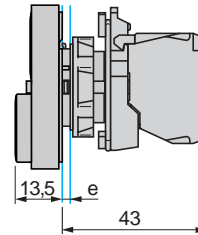
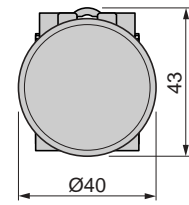
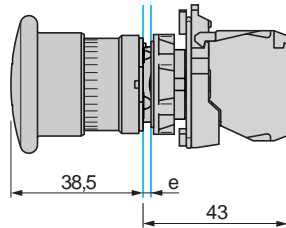

e: panel thickness: 1 to 6 mm

Emergency stop mushroom head pushbuttons

XB5 AT42, BT845

XB5 AS542, AS8445

XB5 AS142, A 9445

Common face view

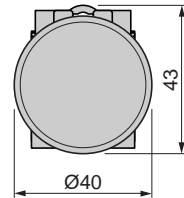
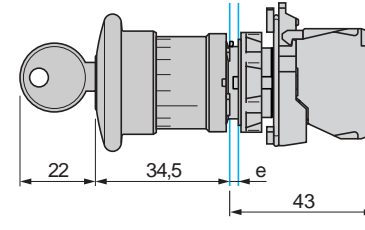
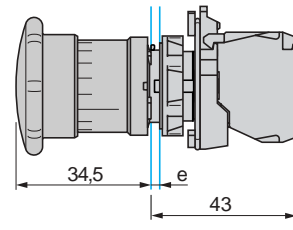
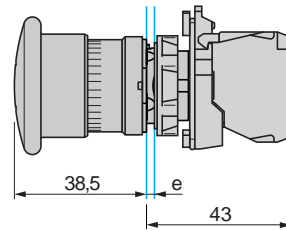

e: panel thickness: 1 to 6 mm

Selector switches

Standard handle operator

XB5 AD

Long handle operator

XB5 AJ

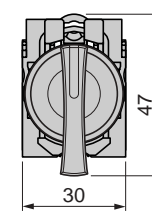
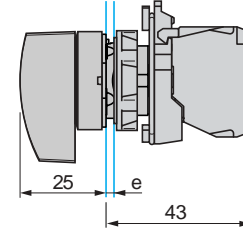
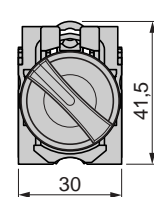
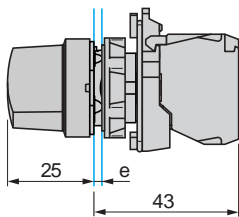

Key switches

XB5 AG

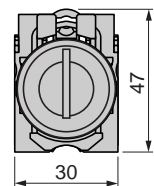
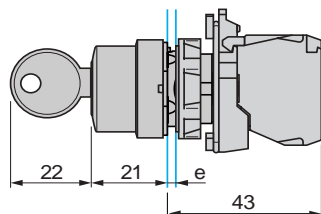

e: panel thickness: 1 to 6 mm

Heads for spring return pushbuttons

ZB5 AA●, AA●●●,
ZB5 AA●8

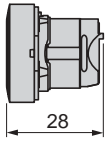

ZB5 AL●, AL●●●

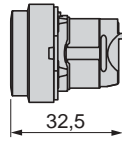

ZB5 AA●4, AA●6

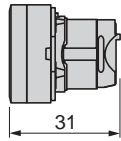

Common face view

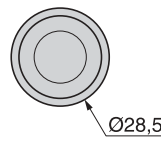

ZB5 AP●● ZB5
AP●S

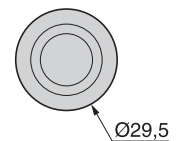
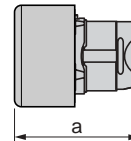

ZB5 CA●, CA0

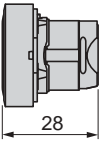

ZB5 CL●

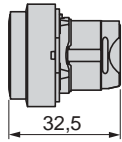

Common face view

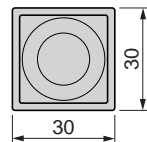

ZB4	a
AP●●	36,5
AP●S	33

Heads for pushbuttons

Lockable "push-turn"

ZB5 AFD

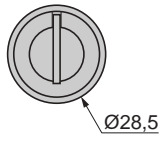
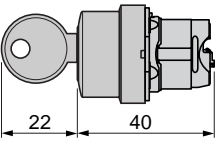

Push-push to release

ZB5 AH0●

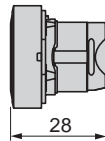

ZB5 AH●

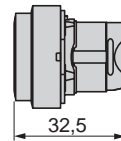

Common face view

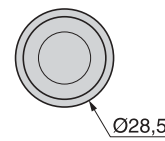

ZB5 CH0●

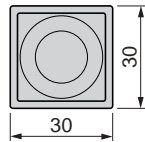
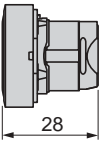

Heads for double-headed, spring return pushbuttons

ZB5 AA81●●, ZB5 AA82●●

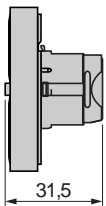

ZB5 AL83●●, ZB5 AL84●●

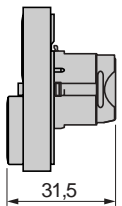

Common face view

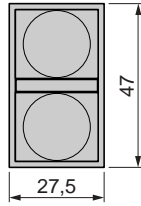

ZB5 AA91●●,
ZB5 AA92●●

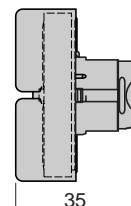

ZB5 AL93●●,
ZB5 AL94●●

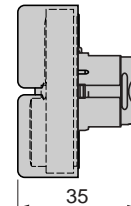

Common face view

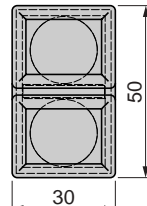

Heads for pushbuttons

Mushroom head

ZB5 AC●4

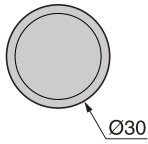
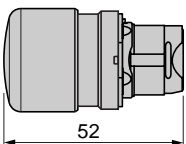

ZB5 AC●, AR●

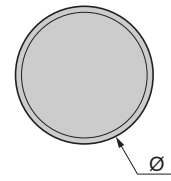
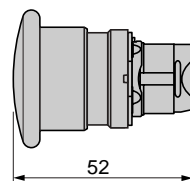

ZB5 AR●16

ZB5	Ø
AC●	40
AR●	60

Mushroom heads for latching pushbuttons

Push-pull

ZB5 AT44

ZB5 AT4, AT84, AX4

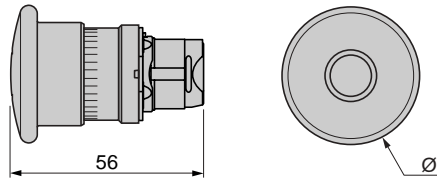
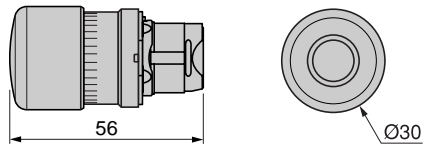

ZB5	Ø
AT4, AT84	40
AX4	60

Turn to release

ZB5 AS4●, AS834

ZB5 AS5●, AS844, AS6●

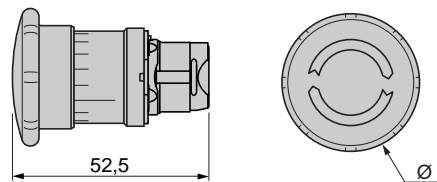
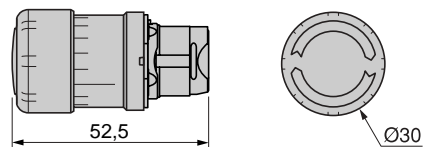

ZB5	Ø
AS5●, AS844	40
AS6●	60

Key release

ZB5 AS7●, AS934

ZB5 AS1●, AS2●, AS944, AS964

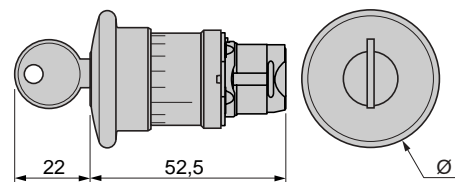
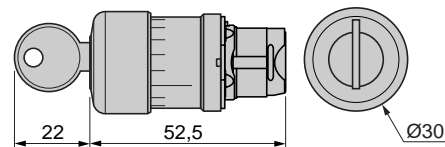

ZB5	Ø
AS1●, AS944	40
AS2●, AS964	60

ZB5 AS14D

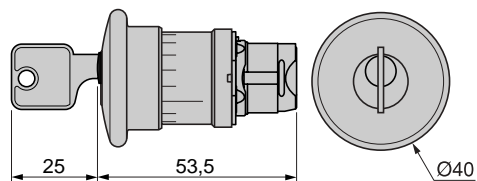

Heads for selector switches

Standard handle operator

ZB5 AD \bullet , AD \bullet M

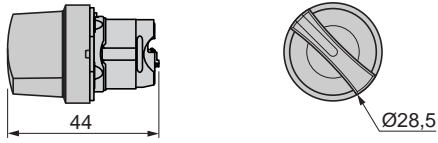

Long handle operator

ZB5 AJ \bullet , AJ \bullet M

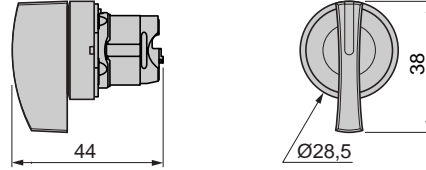

Knurled knob, black

ZB5 AD \bullet 9

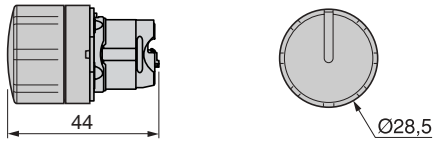

Key switch (Ronis n° 455)

ZB5 AG \bullet , AG0 \bullet , AG \bullet M

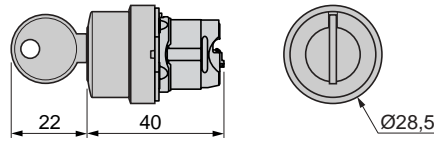

Key switch (DOM n° 8D1)

ZB5 AGD

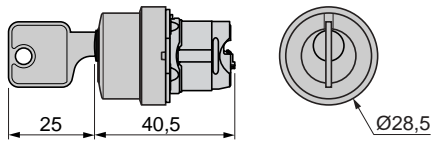

Heads for toggle switches

ZB5 AD \bullet 8

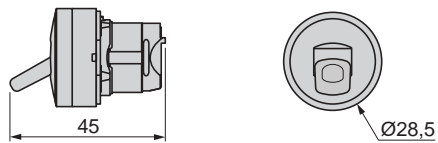

Bodies for pushbuttons and switches

Screw clamp terminal connections

ZB5 AZ10 \bullet , AZ141

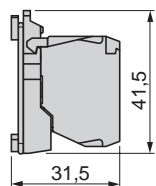

Plug-in connector

ZB5 AZ10 \bullet 4, AZ1414

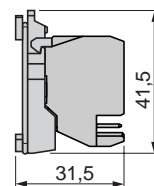

Heads for pilot lights, with light source

Integral LED
 ZB5 AV0●3

Incandescent, neon or LED
 ZB5 AV0●, AV0●S

Common face view

ZB5 CV0●3, CH3●3

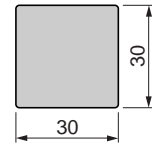
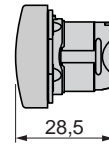
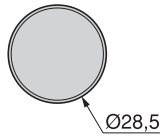
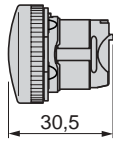
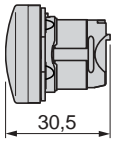

Bodies for pilot lights, screw clamp terminal connections

Integral LED
 ZB5 AV●●

Direct supply, for BA 9s bulb
 ZB5 AV6

Via integral transformer for BA 9s bulb
 ZB5 AV●, AV●D●

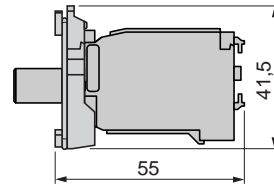
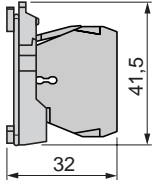
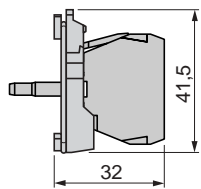

Bodies for pilot lights, plug-in connector

Integral LED
 ZB5 AV●●4

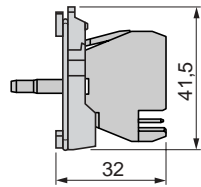

Heads for spring return illuminated pushbuttons, for light source

LED

ZB5 AW3●3, AW3●3S,
 ZB5 AA●8

ZB5 AW1●3, ZB5 AL●8

Common face view

ZB5 AW9●3

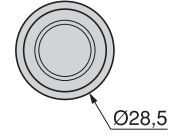
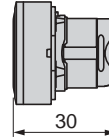
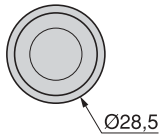
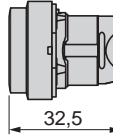
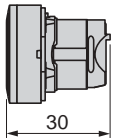

ZB5 AW5●3

ZB5 CW3●3

ZB5 CW1●3

Common face view

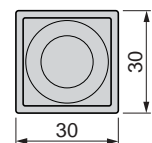
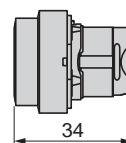
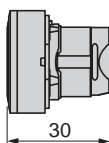
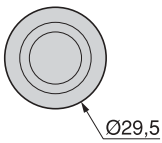
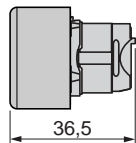

BA 9Ss bulb

ZB5 AW3●, AW3●S

ZB5 AW1●

Common face view

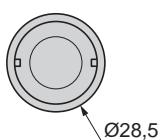
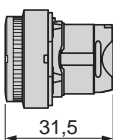
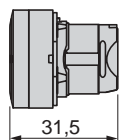

Heads for double-headed pushbuttons with pilot light

ZB5 AW81●●●3,
ZB5 AW82●●●3

ZB5 AW83●●●3,
ZB5 AW84●●●3

Common face view

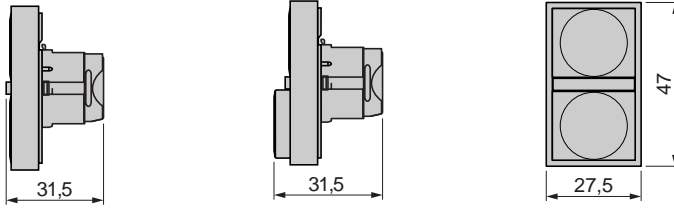

Mushroom heads for latching pushbuttons

ZB5 AW7●3

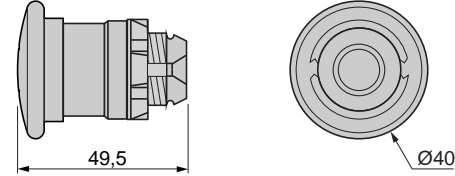

Heads for illuminated "push-push to release" pushbuttons

ZB5 AH0●3

ZB5 AH●3

Common face view

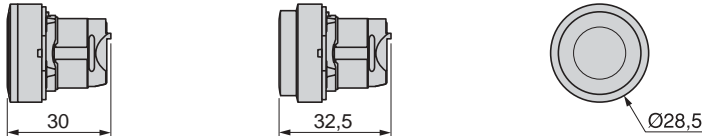

Heads for illuminated selector switches with standard handle

ZB5 AK1●●●3

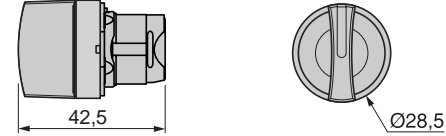

Bodies for illuminated pushbuttons and selector switches, screw clamp terminal connections

Integral LED

Direct supply, for
BA 9s bulb

Via integral transformer for BA 9s bulb

Bodies for illuminated push-
buttons/switches, plug-in connector
Integral LED

ZB5 AW0●●●

ZB5 AW06●

ZB5 AW0●●, AW0●D●●

ZB5 AW0●●●4

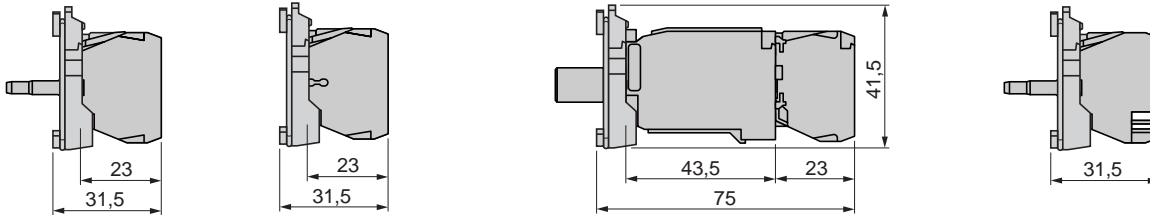

Manual overload reset buttons

XB5 A8●●●

XB5 AL8●●●

Common face view

Head + mounting base for potentiometer

ZB5 AD9●2

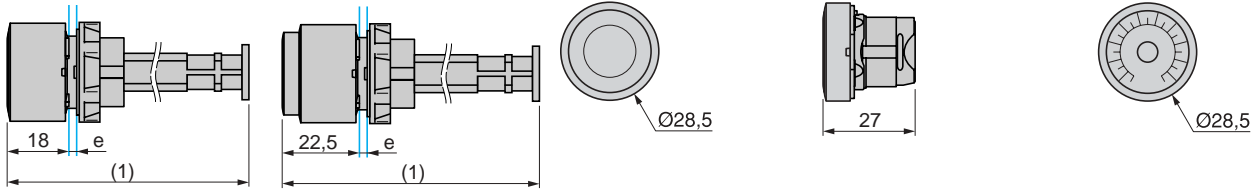

(1) Value not yet available

Joystick controllers

XD5 PA●2

XD5 PA●4

Common face view

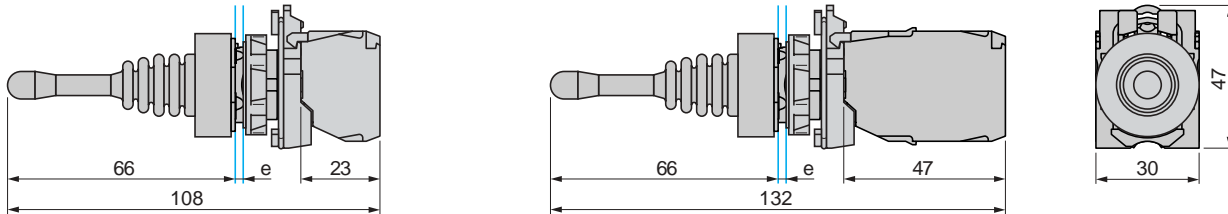

e: panel thickness 1 to 6 mm

Hour counters

XB5 DS●

Annunciators

XB5 KS●

Connection diagram

XB5 KS●

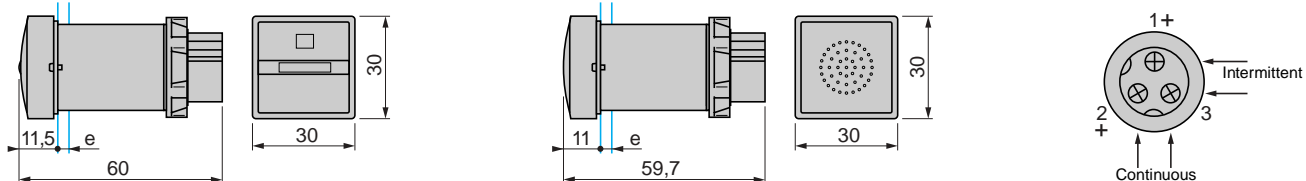

Pushbuttons, switches and pilot lights for printed circuit board connection

Panel cut-out (viewed from installer's side)

Dimensions in mm

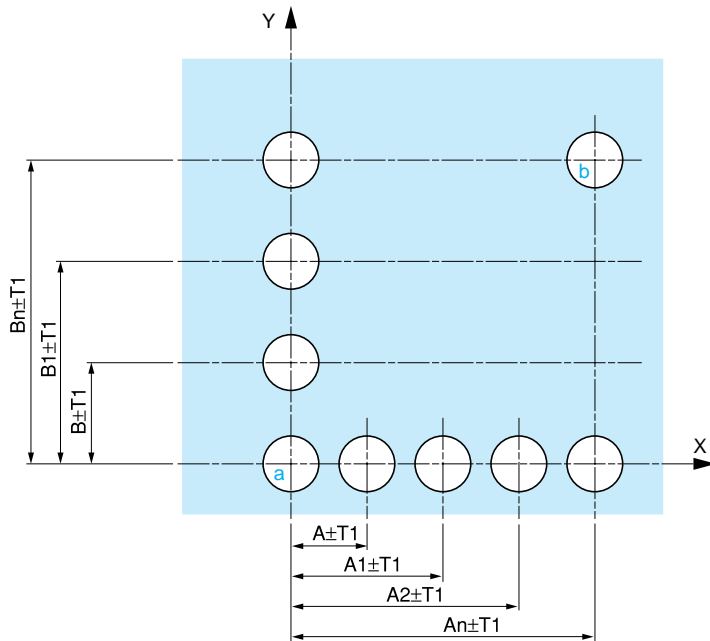

Printed circuit board drillings (viewed from electrical block side)

Dimensions in mm

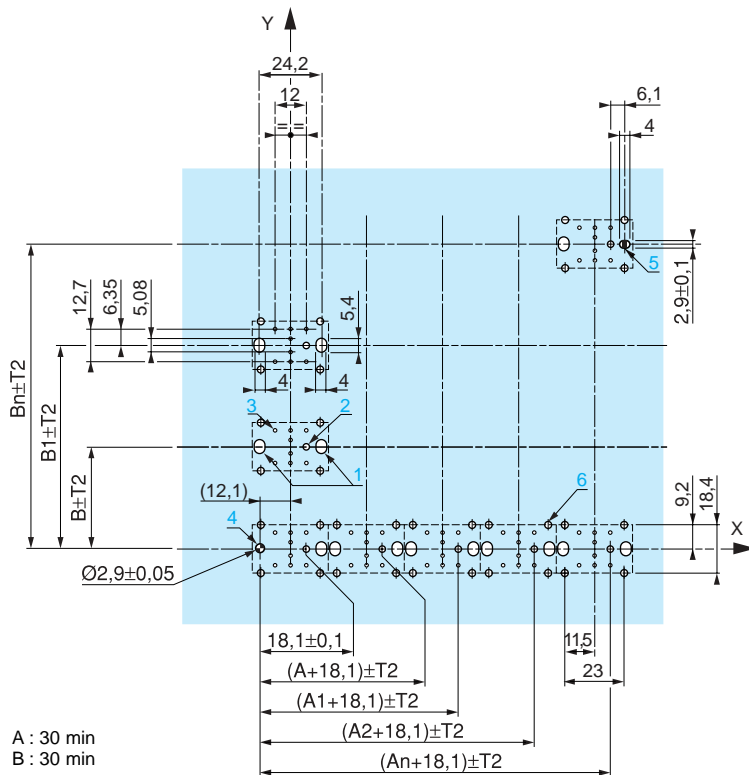

General tolerances of the panel and printed circuit board

The cumulative tolerance must not exceed 0.3 mm: $T1 + T2 = 0.3$ mm max.

Installation precautions:

Minimum thickness of circuit board: 1.6 mm.

Cut-out diameter: $22.5 \text{ mm} \pm 0.1 \text{ mm}$.

Orientation of body/fixing collar ZB5 BZ079: $\pm 2^\circ 30'$ (excluding cut-outs marked a and b).

Tightening torque of screws ZBZ 006: 0.6 N.m.

Allow for one ZB5 BZ079 pillar and its fixing screws:
 - every 90 mm horizontally (X) and every 120 mm vertically Y,
 - with each selector switch head (ZB5 AD●, ZB5 AJ●, ZB5 AG●).

The fixing centres marked a and b are diagonally opposed and must align with those marked 4 and 5 on the printed circuit board.

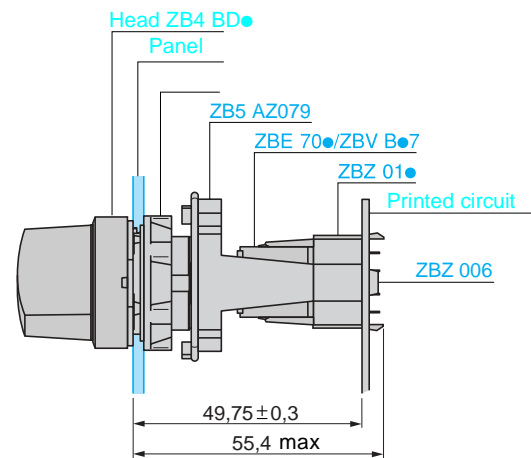

Mounting of adaptor (socket) ZBZ 01● :

- 1 2 elongated holes for ZBZ 006 screw access.
- 2 1 hole $\varnothing 2.4 \text{ mm} \pm 0.05$ for centring adaptor ZBZ 01●.
- 3 8 x $\varnothing 1.2 \text{ mm}$ holes.
- 4 1 hole $\varnothing 2.9 \text{ mm} \pm 0.05$, for centring the printed circuit board (with cut-out marked a).
- 5 1 elongated hole for orientation of the printed circuit board (with cut-out marked b).
- 6 4 holes $\varnothing 2.4 \text{ mm} \pm 0.05$ for clipping in adaptor ZBZ 01●.

Dimensions $An + 18.1$ relate to the $\varnothing 2.4 \text{ mm} \pm 0.05$ holes for centring adaptor ZBZ 01●.

Schneider Electric Industries SAS

Headquarters

89, bd Franklin Roosevelt
F - 92506 Rueil Malmaison Cedex

<http://www.schneider-electric.com>

Owing to changes in standards and equipment, the characteristics given in the text and images in this document are not binding until they have been confirmed with us.

Production : Schneider Electric Industries
Photos : Schneider Electric Industries
Printed by : CCI



April 2004

X-ON Electronics

Largest Supplier of Electrical and Electronic Components

Click to view similar products for [schneider](#) manufacturer:

Other Similar products are found below :

[LU9M1](#) [7D](#) [7S](#) [7XA1](#) [FNQR2](#) [8501RS44V24](#) [8501RSD14P14V51](#) [8501XO20V03Y414](#) [9001KXRK](#) [9001SKR9P35RH25](#) [9001SKT35L31](#)
[9003K2C003GA](#) [9007AA1](#) [9007BA1](#) [9007C54D](#) [9007C62A2](#) [9007CA11](#) [9007FA3](#) [9007HA4](#) [9007HA6](#) [9007KA1](#) [9007KB11](#)
[9007MS01S0206](#) [9007MS02S0300](#) [9012GAR4](#) [9012GAW2](#) [9012GBW1](#) [9012GDW5E3](#) [9012GFW1](#) [9012GNG1](#) [9012GNG3](#) [9012GNG6](#)
[9013FHG39J69](#) [9013GHG2J30](#) [9050JCK2F30V14](#) [GV2ME04](#) [GV2ME10](#) [GV2ME14](#) [GV2ME20](#) [GV2ME32](#) [GV2P06](#) [GV2P08](#) [GV2P10](#)
[GV2P16](#) [GV2P20](#) [GV2P21](#) [GV2RT07](#) [GV2RT21](#) [GVAD1001](#) [GVAN11](#)