

SPECIFICATION FOR APPROVAL

承 認 書

Description : Micro Dynamic Speaker
Kingstate Part No. : KDMG36008-10B
Customer's Model No. : _____
Specification No. : PKD-7431
Number Of The Edition : 2.1

CUSTOMER'S APPROVED SIGNATURE		

志豐電子股份有限公司 **KINGSTATE ELECTRONICS CORP.**



Address: 10F, No. 69-11, Sec. 2, Chung Cheng E. Rd., Tamshui County, Taipei Hsien, Taiwan, R.O.C.

International sales dept.: TEL:886-2-2809-5651 FAX:886-2-2809-7151

Domestic sales dept.: TEL:886-2-2809-0668 FAX:886-2-28096748

<http://www.kingstate.com.tw>

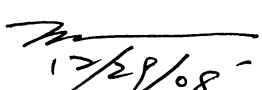
Approved by	Checked by	Issued by
 12/28/08	林小阿 2008.12.27	Chen 12/27/08'

A. SCOPE 範疇

This specification applies speaker, **KDMG36008-10B**

此規格書適用於喇叭, **KDMG36008-10B**

B. SPECIFICATION 規格

No.	Item	Symbol	Unit	Specification	Condition
1	Dimension 尺寸		mm	$\varnothing 36.0 \times 4.8$	
2	Power Rating 功率		W	Rated. 1.0/ MAX. 1.5	Maximum Power:IEC-60268-5 Filter 60s On/120s Off 10 Cycles (Room TEMP.)
3	Impedance 阻抗	Ω	ohm	$8 \pm 15\%$	At 1.5KHz 1.0V
4	Resonance Frequency 低音諧振	Fo	Hz	$570 \pm 20\%$	At 1.0V
5	Output S.P.L. 音壓位準		dB	$104 \pm 3\text{dB}(1\text{w}/10\text{cm})$ $88 \pm 3\text{dB}(1\text{w}/0.5\text{m})$	At 800Hz,1K,1.2K,1.5KHz (Average figures)
6	Frequency Range 有效頻寬		Hz	Fo--5K	Output S.P.L. $\pm 10\text{dB}$
7	Distortion 失真		%	5% Max.	At 1.0KHz , 1.0W
8	Voice Coil 音圈		mm		
9	Magnet 磁石		mm	$\varnothing 12.5 \times 1.5$	Nd-Fe-B (鈹鐵錳)
10	Flux Density 磁通密度		Gauss		
11	Operating temp. 操作溫度		$^{\circ}\text{C}$	-40 ~ +55	
12	Buzzer & Rattle 異常音				Not be audible at 2.83V sine wave between Fo ~ 5KHz 輸入 2.83V 正弦波從 Fo 到 5KHz 之間無異常音
13	Weight 重量		g	8.0	
14	Material 材質			Metal	
15	Polarity			Diaphragm shall move Forward when Apply a Positive DC. Current to the "+" or "Marked" Terminal.	
16	Environmental Protection Regulation 環保法規			RoHS	

C. TYPICAL FREQUENCY RESPONSE CURVE 頻率響應曲線

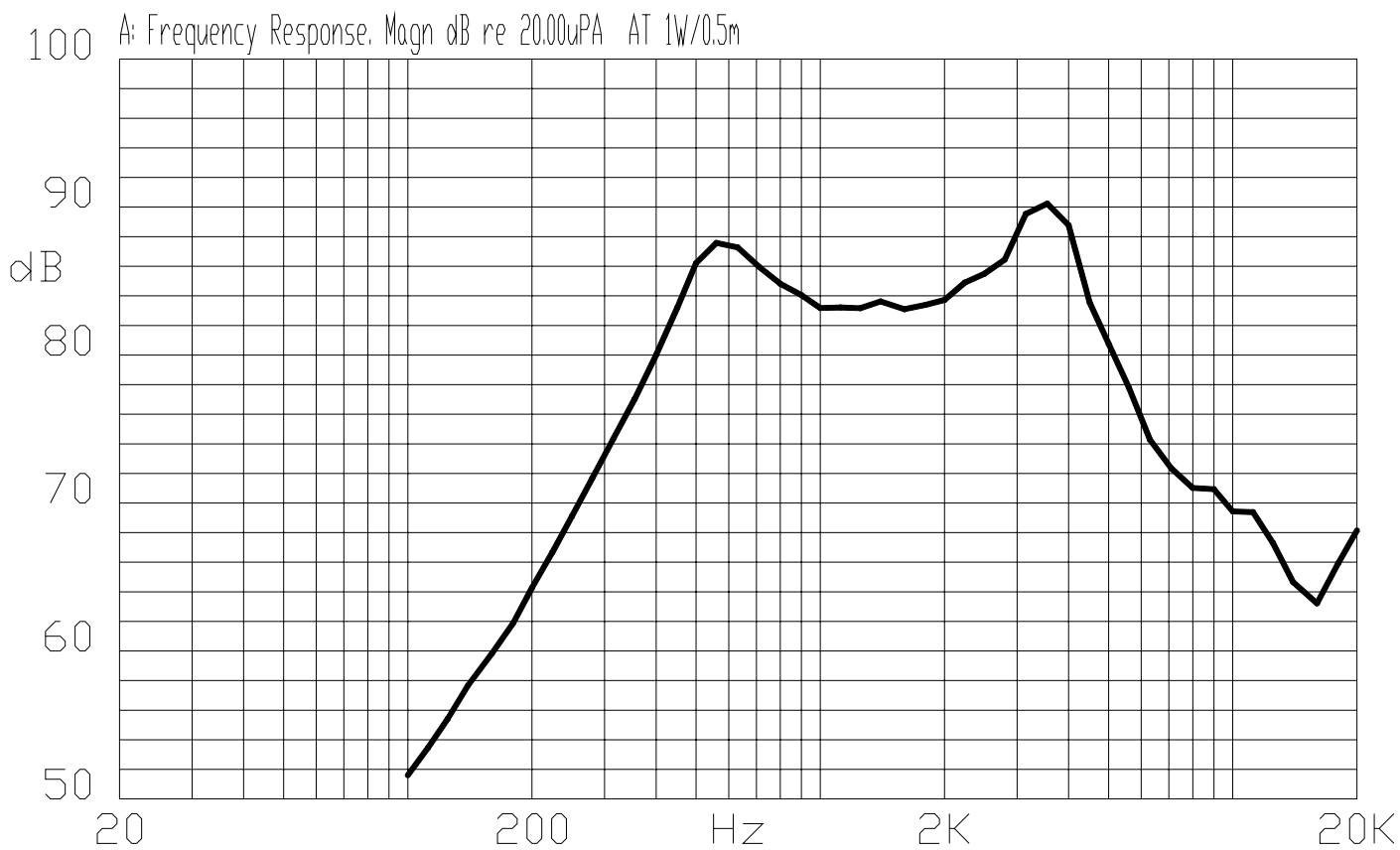
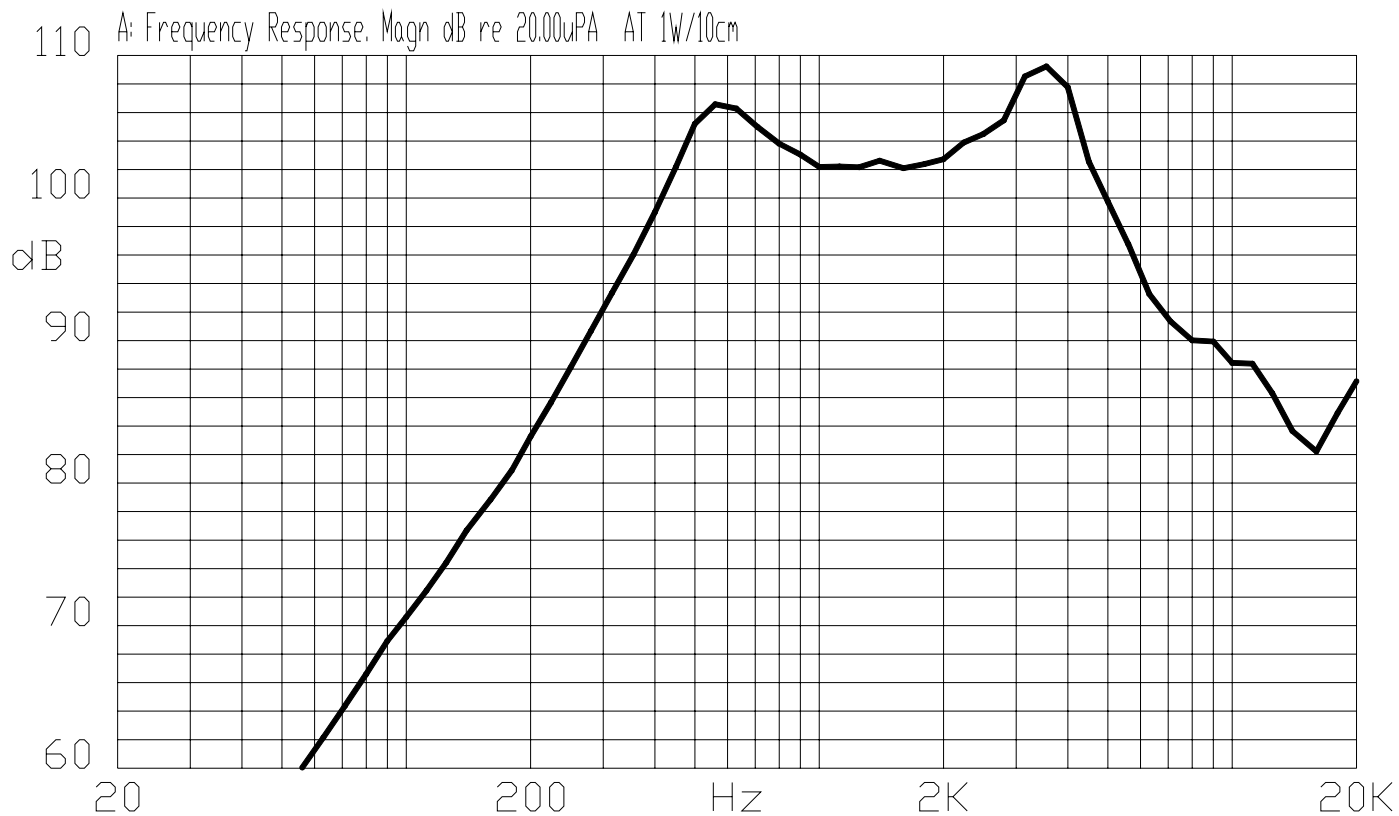

D. APPEARANCE DRAWING 外觀尺寸圖

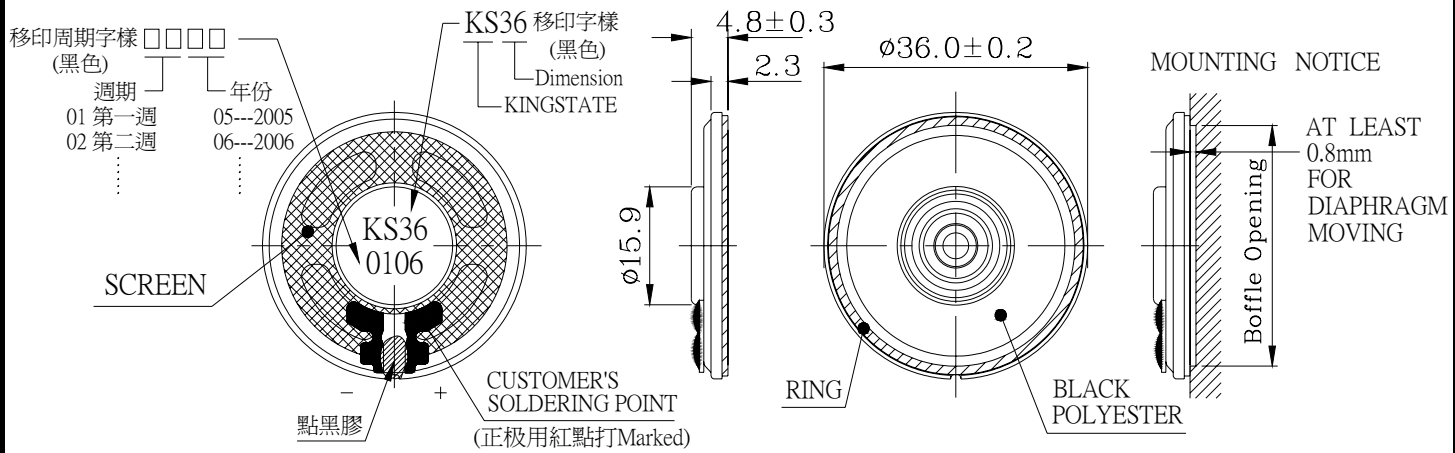

Tol : ± 0.5

Unit: mm

E. MEASUREMENT CIRCUIT 測量線路

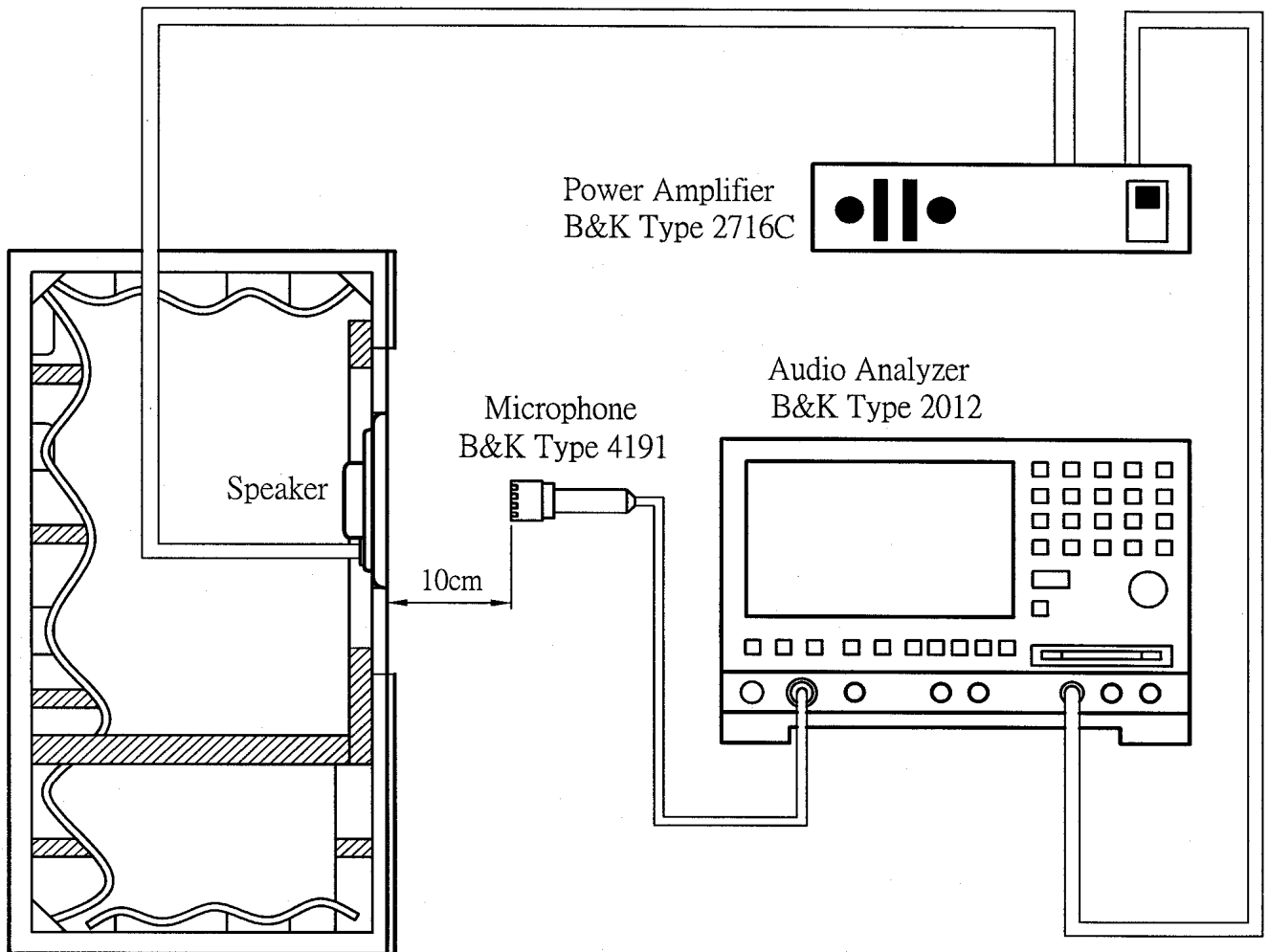

JIS C5531

940mm x 640mm x 1240mm

F. MECHANICAL CHARACTERISTICS 機械特性

No.	Item	Test condition	Evaluation standard
1	PCB Wire Pull Strength PCB 線材拉力	The pull force shall be applied to double lead wire : Horizontal 3.0N(0.306kg) for 30 seconds. 雙線材水平方向施以 3.0N(0.306kg)的力量, 30 秒.	No damage and cutting off 不鬆動, 不脫落.
2	Vibration Test 振動測試	Speaker shall be measured after being applied vibration of amplitude of 1.5mm with 10 to 55Hz band of vibration frequency to each of 3 perpendicular directions for 2 hours. 振動週波數 10~55Hz、全振幅 1.5mm 於 X.Y.Z 3 個方向, 各 2 小時.	No obstacle to be harmful to normal operation; damages, cracks, rusts and distortions. Should not be audible at 2.83V sine wave between Fo ~ 5KHz
3	Drop Test 落下測試	Drop the speakers contained in normal box onto the board 40mm thick 10 times from the height of 75cm. 將揚聲器置於盒中, 自 75 公分高度落在 40mm 木板上共 10 次.	測試後無任何障礙防礙正常操作.且在輸入 2.83V 正弦波從 Fo 到 5KHz 之間無異常音

G. ENVIRONMENTAL TEST 環境試驗

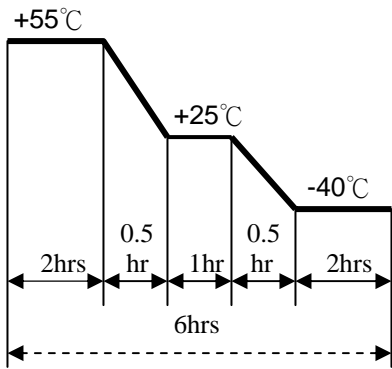
No.	Item	Test conditions	Evaluation standard
1	High temp. Test 高溫測試	After being placed in a chamber at +55°C for 96 hours 置於+55°C 環境中 96 小時	Being placed for 6 hours at +25°C, speaker shall be measured. No obstacle to be harmful to normal operation; damages, cracks, rusts, etc. Should not be audible at 2.83V sine wave between Fo ~ 5KHz. Fo should meet initial one. S.P.L. deviation of unit should be within ±3dB. 經測試後, 靜置於+25°C (室溫)環境中 6 小時後, 測試後無任何障礙防礙正常操作.且在輸入 2.83V 正弦波從 Fo 到 5KHz 之間無異常音. Fo 與原規格值相同, 輸出音壓變化量在±3dB 內.
2	Low temp. Test 低溫測試	After being placed in a chamber at -40°C for 96 hours. 置於-40°C 環境中 96 小時	
3	Humidity test 相對濕度測試	After being placed in a chamber at +40°C and 90±5% RH relative humidity for 96 hours. 置於+40°C, 相對濕度 90±5%環境中 96 小時	
4	Temp. cycle test 溫度循環測試	The part shall be subjected to 5 cycles. One cycle shall be consist of: 單體承受溫度循環測試 5 次, 其循環內容如圖示: 	

H. Recommended Temperature Profile For Hand Soldering 建議手焊溫度

Hand Soldering
370±10°C / 3±1 Sec

I. RELIABILITY TEST 信賴性試驗

No.	Item	Test conditions	Evaluation standard
1	Load test 連續負荷	1.0W white noise is applied for 96 hours, at room temp. 在室溫下,輸入功率 1.0W, 白雜音連續操作 96 小時.	Being placed for 1 hours at +25°C, speaker shall be measured. No obstacle to be harmful to normal operation; damages, cracks, rusts, etc. Should not be audible at 2.83V sine wave between Fo ~ 5KHz. Fo should meet initial one. S.P.L. deviation of unit should be within ±3dB. 經測試後,靜置於+25°C (室溫)環境中 1 小時後,測試後無任何障礙防礙正常操作.且在輸入 2.83V 正弦波從 Fo 到 5KHz 之間無異常音. Fo 與原規格值相同,輸出音壓變化量在±3dB 內.

TEST CONDITION.

Standard Test Condition :	a) Temperature : +5 ~ +35°C	b) Humidity : 45-85%	c) Pressure : 860-1060mbar
一般測試條件 :	a) 溫度 : +5 ~ +35°C	b) 濕度 : 45-85%	c) 氣壓 : 860-1060mbar
Judgment Test Condition	a) Temperature : +25 ± 2°C	b) Humidity : 60-70%	c) Pressure : 860-1060mbar
爭議時測試條件:	a) 溫度 : +25 ± 2°C	b) 濕度 : 60-70%	c) 氣壓 : 860-1060mbar

J. PACKING STANDARD 包裝規格

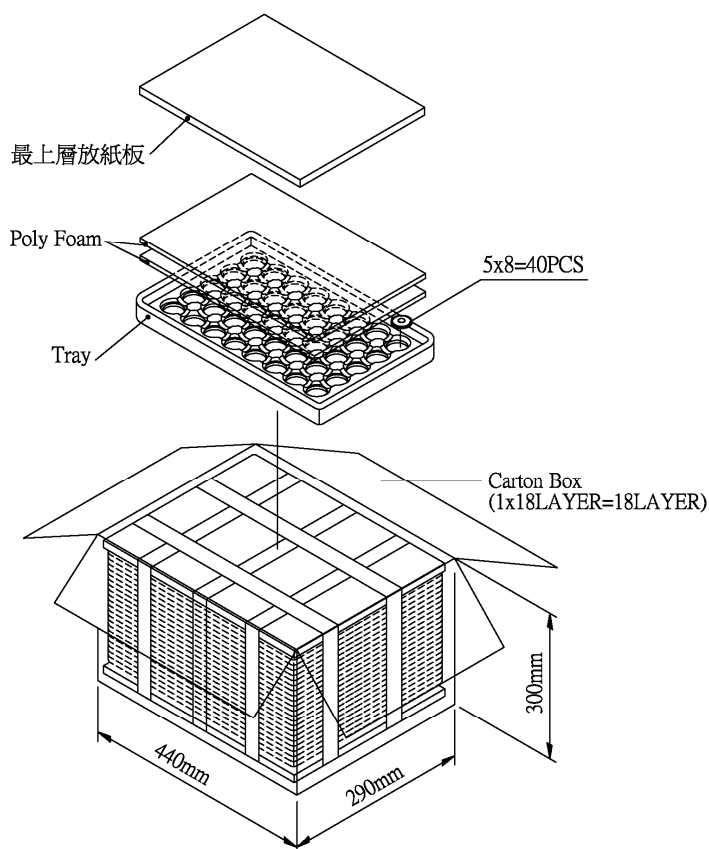

Tray	420mmx270mmx22mm	1x40PCS=40PCS
Carton Box	440mmx290mmx300mm	40PCSx18=720PCS

X-ON Electronics

Largest Supplier of Electrical and Electronic Components

Click to view similar products for [kingstate manufacturer](#):

Other Similar products are found below :

[KPEG352](#) [KXG1205](#) [KPEG130](#) [KMTG1261](#) [KPEG260H](#) [KDMG36008](#) [KPEG1600](#) [KPEG-202](#) [KPEG-653SAN](#) [KPEG623AN](#) [KPEG1501](#)
[KPEG260](#) [KPEG165](#) [KPEG270](#) [KDMG13008L-02](#) [KPEG228](#) [KECG2740PBJ](#) [KSSG3108](#) [KPEG280](#) [KPEG222](#) [KPEG960](#) [KEIG4537TFL-](#)
[N](#) [KPEG006](#) [KPEG214A](#) [KPEG153](#) [KMTG1102-A1](#) [KPEG106-HS](#) [KPEG203](#) [KMTG1303-1](#) [KTG1212](#) [KEEG1542PBL-A](#) [KPEG242](#)
[KSSG33J12](#) [KPEG163](#)