

# Selector Switch Type 01

- Compact 12 positions selector switch
- 25,000 switching cycles with up to 6.0 Ncm switching torque
- Gold plated contacts: 3 micron
- Robust metal housing with metal shaft
- Optional IP68 front panel sealing
- Operating temperature range: -40 to +85°C
- Various options and customization

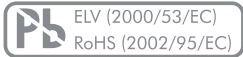

## Standard Product Variety

- Soldering eyelets or pins for PCB
- From 1 x 12 to 4 x 3 poles/positions per wafer
- Single or dual wafer
- 30, 36 or 60° indexing angle
- Shorting or non-shorting
- 2.0, 4.0 or 6.0 Ncm switching torque
- IP60 or IP68 front panel sealing
- Configurable end stops
- Shaft diameter: 3, 4 or 6 mm

## Possible Customization

- Shaft dimensions and shape
- Bushing dimensions
- Switching torque
- Hollow shaft, inner shaft
- Others

## Typical Applications

- Industrial controls
- Avionics, instrumentation, test systems
- Medical and audio equipment

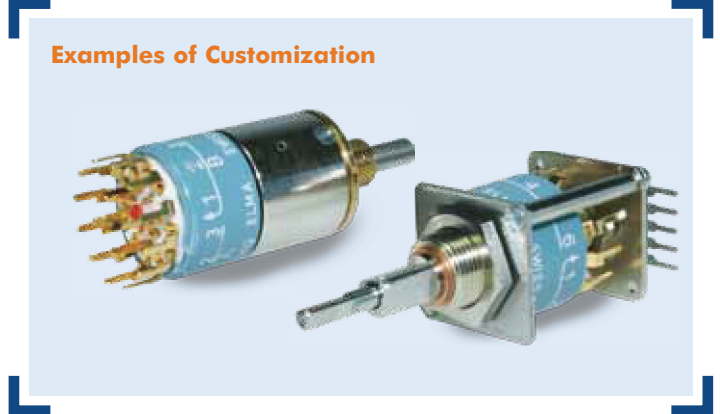

## Examples of Customization

## Examples of Customization

- Interlock function; pull-to-turn
- Dual concentric version with E33 Encoder feed through

# Selector Switch Type 01

## Preference Types Selection Chart<sup>1</sup>

### Indexing Angle 30°, Shorting

Contact Arrangement	Construction	Function (Poles x Positions)	With Solder Eyelets	With Pins for PCB
		1 x 12, endless rotating	01-1123	01-1123-20
		2 x 12, endless rotating	01-2123	–
		1 x 12	01-1183	01-1183-20
		2 x 12	01-2183	–
		1 x 11	01-1113	01-1113-20
		2 x 11	01-2113	–
		2 x 6	01-1263	01-1263-20
		4 x 6	01-2263	–
		4 x 3	01-1433	01-1433-20
		8 x 3	01-2433	–

### Indexing Angle 30°, Non-Shorting

Contact Arrangement	Construction	Function (Poles x Positions)	With Solder Eyelets	With Pins for PCB
		1 x 12, endless rotating	01-1124	01-1124-20
		1 x 12	01-1184	01-1184-20
		1 x 11	01-1114	01-1114-20
		2 x 6	01-1264	01-1264-20
		4 x 3	01-1434	01-1434-20

### Indexing Angle 36°, Shorting

Contact Arrangement	Construction	Function (Poles x Positions)	With Solder Eyelets	With Pins for PCB
		1 x 10, endless rotating	01-1103	01-1103-20
		1 x 10	01-1193	01-1193-20

### Indexing Angle 60°, Non-Shorting

Contact Arrangement	Construction	Function (Poles x Positions)	With Solder Eyelets	With Pins for PCB
		1 x 6, endless rotating	01-1104	01-1104-20
		1 x 6	01-1164	01-1164-20
		2 x 3	01-1234	01-1234-20
		4 x 2	01-1424	01-1424-20

### Stop Pins

Packaging Unit	Order Number
10 pcs.	4007-36
50 pcs.	4007-35

On switches with fixed end-stop, additional stops can be set, by means of a plastic pin, on any position between 2 and the maximum (stop pins to be ordered separately).

<sup>1</sup> For other types/options, see type key.

# Selector Switch Type 01

## Specifications

### Mechanical Data

Resolution:	12 positions max. (30° indexing); shorting or non-shorting 10 positions max. (36° indexing); shorting 6 positions max. (60° indexing); non-shorting
Switching torque (new condition):	2.0, 4.0 or 6.0 Ncm (+/- 25%), additional wafers may increase switching torque
Rotational life:	25,000 switching cycles min.
Fastening torque of nut:	300 Ncm max.

### Electrical Data

Functions:	From 1 x 12 to 4 x 3 poles/positions per wafer (max. 2 wafers)
Switching mode:	Shorting (for 30° and 36° indexing) Non-shorting (for 30° and 60° indexing)
Load current:	2 A max. (resistive load)
Switching voltage:	42 VDC max.
Contact resistance (new condition):	10 mOhms max.
Insulation resistance:	10 <sup>11</sup> Ohms min. (contact to contact/housing)
Switching capacitance:	1 pF max. (contact to contact)
Dielectric withstanding voltage:	500 VDC during 60 seconds

### Material Data

Shaft:	Stainless steel
Bushing:	Nickel silver
Housing:	Fiber enforced plastic
Nut:	Brass with glossy nickel plating
Contact plating:	AuCo (hard gold); 3 μm
Insulation material:	Wafer: HF ceramic, rotor: Polybutylene (PBTB)
Soldering leads:	Alloy copper, AuCo plated (hard gold)

### Environmental Data

Operating/storage temperature range:	-40 to +85°C
IP sealing:	IP60, optional IP68 (2 bar, 1 hour) shaft/front panel sealing
Vibration:	10 Grms max. @ 10 to 2000 Hz
Flammability:	UL94-HB

### Packaging Sizes

Tray:	10 pcs.
-------	---------

## Soldering Conditions

Hand soldering:	340°C max. during 2 s max.
Wave soldering:	280°C max. peak temperature during 5 s max.

## Switching Modes

### Non-Shorting

(break before make)

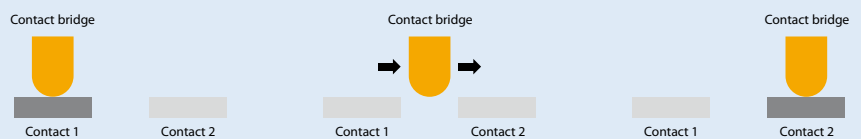

### Shorting

(make before break)

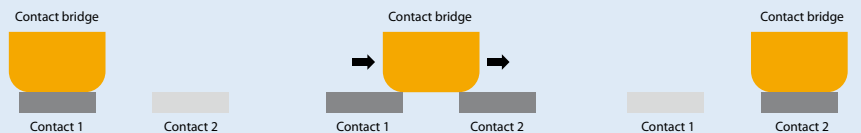

# Selector Switch Type 01

## Drawings

### With Solder Eyelets

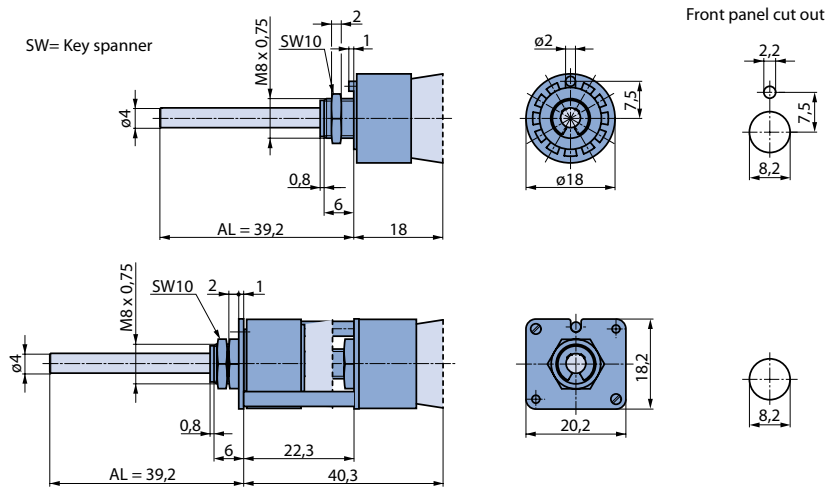

Drilling diagram for 30° indexing angle

Drilling diagram for 36° indexing

### With Pins for PCB Mounting

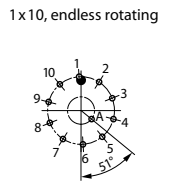
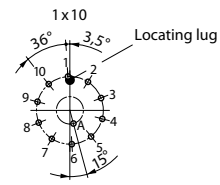
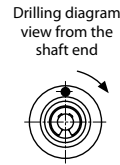
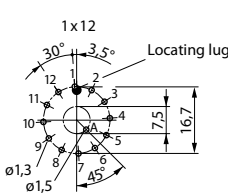
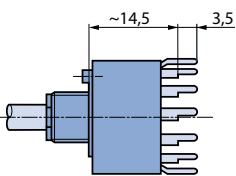

Drilling diagram for 60° indexing angle

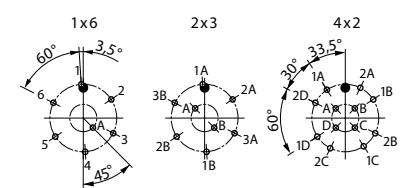
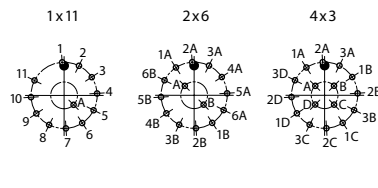

### Special Shaft Diameter

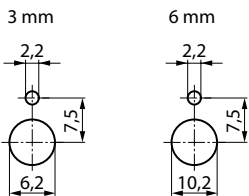

Type 01 switches are also available with the following shaft diameters:

Ø	AL	Bushing	Nut Size
3 mm	59 mm	M6 x 0.75 x 6.0 mm	10 mm
6 mm	28 mm	M10 x 0.75 x 8.0 mm	14 mm

### Hollow Shaft System

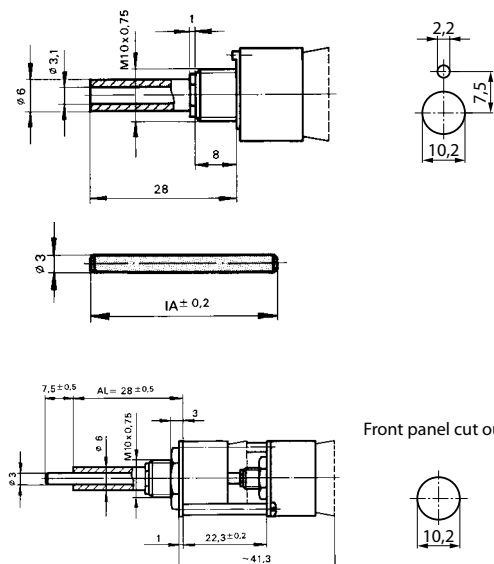

#### Hollow Shaft

Hollow shaft to allow concentric operation of either two switches or, for example, a switch and a potentiometer. The inner shaft (Ø 3 mm) must be ordered separately.

#### Inner Shaft

Must be ordered separately for switches with hollow shaft.

#### Switches with 2 Drive Shafts

It is possible for two switches to be operated individually by concentric shafts on the same mounting. When ordering, the type number of each switch should be given and specified.

# Selector Switch Type 01

## Type Key

0 1 - X X X X - X X X X X X X X

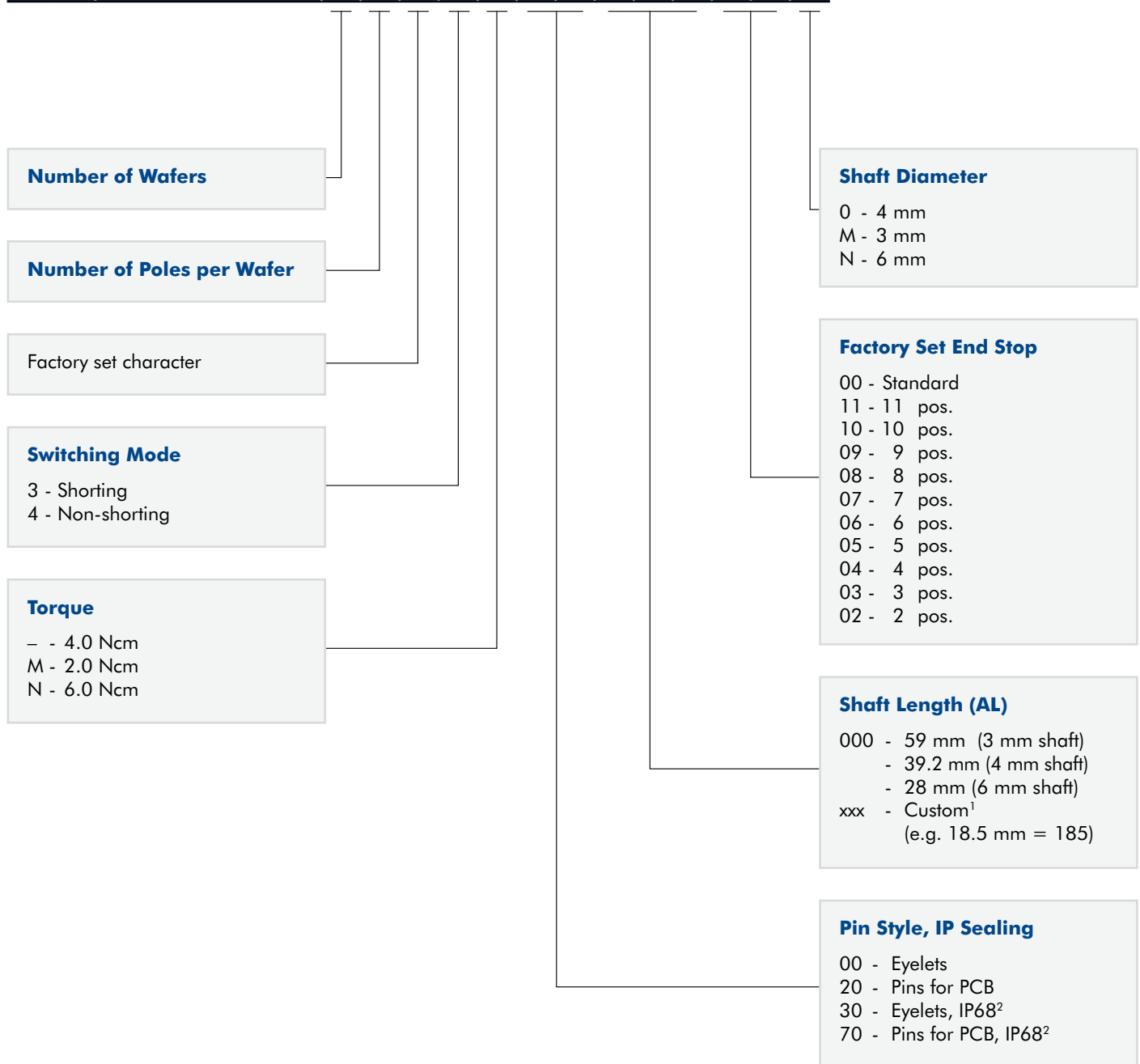

<sup>2</sup> Only available for one wafer versions with 3 or 4 mm shaft diameter.

### <sup>1</sup> Customized Shaft Length

Please state shaft length (AL) measured from mounting face (max. AL = 80 mm).

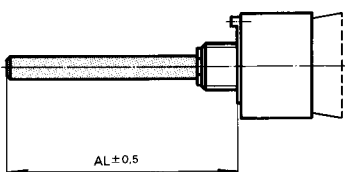

## X-ON Electronics

Largest Supplier of Electrical and Electronic Components

*Click to view similar products for [Coded Rotary Switches](#) category:*

*Click to view products by [Elma](#) manufacturer:*

Other Similar products are found below :

[PT65SG178](#) [PT65SG23](#) [DRS4010](#) [CW1S-2E11](#) [S-1031A](#) [SBS1004](#) [P36S101TR](#) [P65THR101L254](#) [RM3AF-10R-V-T/R](#) [RH3HAF-10R-V-B](#)  
[PT65501RT](#) [P25SMT101TR](#) [P65SMT101](#) [P65THR101V](#) [MSDR-10H1](#) [GSDR-10S](#) [01-1433](#) [07-3153](#) [07-3154](#) [CRD10CM0SBR](#) [DRS4116](#)  
[94HCB16RAT](#) [94HCB10T](#) [94HBB16WT](#) [94HBB16RAT](#) [94HBB10WT](#) [94HBB10RAT](#) [94HBB08RAT](#) [94HAC10T](#) [94HAB16WT](#)  
[94HAB16T](#) [94HAB10WT](#) [94HAB10RAT](#) [94HAB08WT](#) [94HAB08RAT](#) [ND3FR10P](#) [ND3FR16B-R](#) [DRR3110](#) [94HEB08WRT](#)  
[94HCB16WT](#) [94HCB16T](#) [94HCB10RAT](#) [94HCB08T](#) [94HBB16T](#) [94HBB10T](#) [94HBB08T](#) [94HAB16RAT](#) [94HAB10T](#) [94HAB08T](#) [S-2011A](#)