

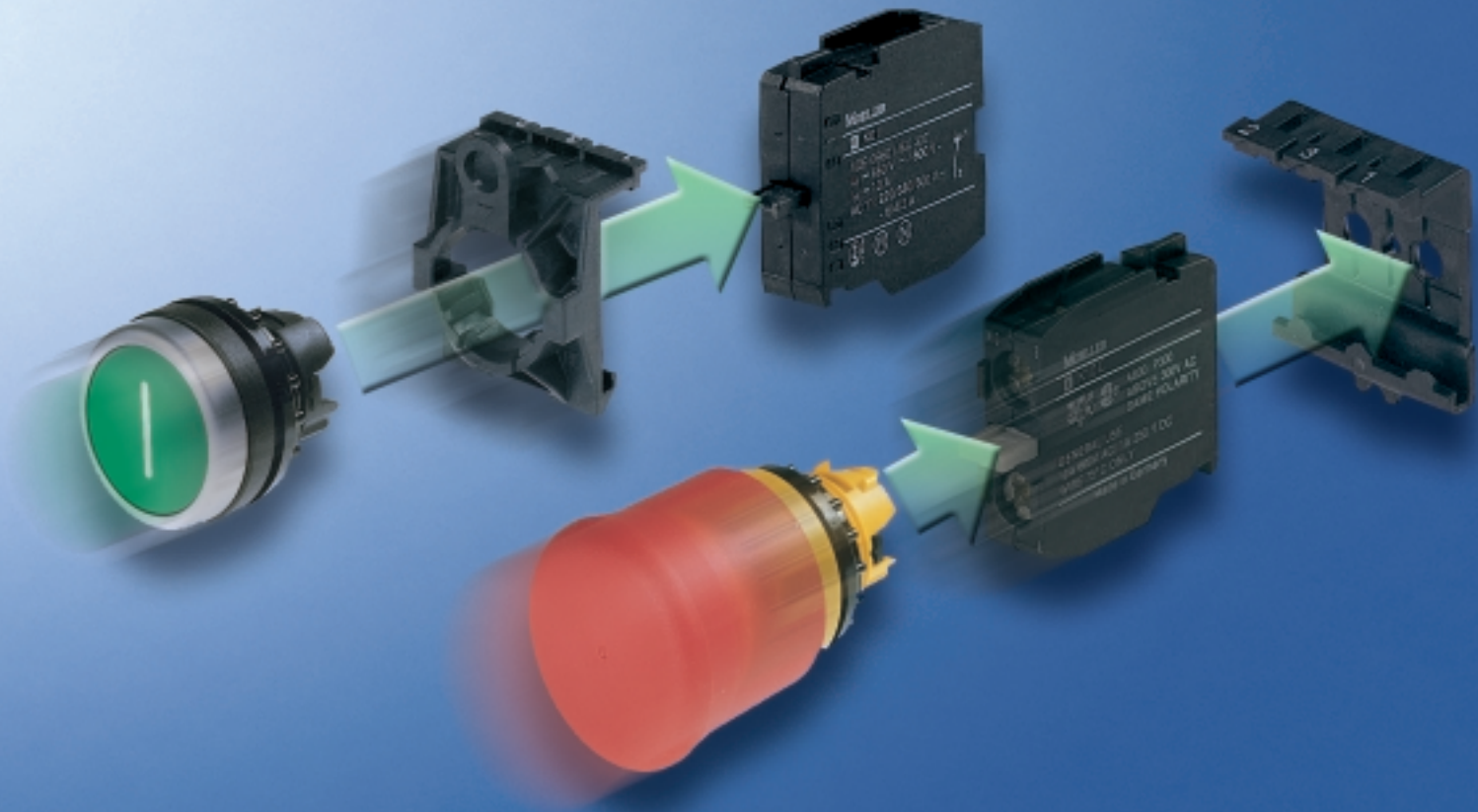









## Selection aid







# Reliable and Precise Command and Signalling















A22 control circuit devices





# Modular units

Push-button actuators, IP 65		Illuminated Push-button actuators, IP 65		Mushroom actuators, IP 65		
						
Button plate	Actuator flush, spring return	Button plate	Double actuator with indicator lens	Button plate	Mushroom	Mushroom actuator, spring return
	A22-RD-11		A22-QDDL-11/10			A22-RP-GN11
	A22-RD-10				A22-RP-RT10	
Without	A22-RD-X					

Emergency stop actuators, IP 65		Illuminated Push-button actuators, IP 65			
					
Funktion	Mushroom actuator, spring return	Button plate	Actuator flush, spring return	Actuator flush, stay put	Actuator extended, spring return
Pull to Release	A22-RPV		A22-RLT-WS11		A22-RLTH-WS11
			A22-RLT-WS	A22-RLTR-WS	A22-RLTH-WS
			A22-RLT-GN	A22-RLTR-RN	A22-RLTH-GN
			A22-RLT-RT	A22-RLTR-RT	A22-RLTH-RT
			A22-RLT-GE	A22-RLTR-GE	A22-RLTH-GE

Indicator light lens assemblies, IP 65			Selector switch actuators, IP 65		Key-operated actuators, IP 65
					
	Flush	Conical	<b>Function</b>	<b>Thumb-grip, 2 positions</b>	<b>KMS1 lock mechanism, 2 positions</b>
	A22-RLF-GN	A22-RL-GN	 90°	A22-RWK1V	
	A22-RLF-RT	A22-RL-RT	 60°	A22-RWK1R	A22-RS
	A22-RLF-GE	A22-RL-GE	 45°	A22-RWK1	
	A22-RLF-BL			<b>3 positions</b>	<b>3 positions</b>
			 60°	A22-RWK3R	A22-RS3
			 45°	A22-RWK3	A22-RS3-KMS1-A4
			 Stay-put	 Spring-Return	

Mushroom actuator IP 65		Adapters		BA9s Filament bulbs	
					
Funktion	KMS1 key release Mushroom actuator	Flushing mounting	Surface/rear mounting	BA9s Filament bulbs	Type
	A22-RPSR	A22-BE6	A22-BE3C	2W / 24 V	A22-GL24
				2.4 W / 130 V	A22-GL130

# Modular units

Contact elements,  
IP 20



Function	Flushing mounting	Surface/rear mounting
	A22-EK10	A22-EK10C
	A22-EK01	A22-EK01C
	A22-EC11	
	A22-EC20	
	A22-EC02	

Lamp Sockets,  
IP 20



Lamp voltage	Flushing mounting	Surface/rear mounting
Max. 2 W	A22-EF	A22-EFC
Max. 2.4 W	A22-EFR	A22-EFRC

# Complete units

Push-button actuators,  
IP 65



Button plate	Function	Flush
		A22-RD-11/K 10
		A22-RD-11/K 11
		A22-RD-10/K 01
		A22-RD-10/K 11

Double actuators with indicator light 220-240 V,  
IP 65



Button plate	Function	Flush
		A22-QDDL-11/10/K 11 F

Mushroom actuators,  
IP 65



Button plate	Function	Flush
		A22-RP-GN11/K 10

Key-release mushroom actuator with two keys,  
KMS1 lock mechanism, IP 65



Button plate	Function	Flush
		A22-RPSR/K 01

Illuminated push-button actuators, Flush with  
BA 9s filament bulb 230 V, IP 65



Color	Function	Flush
		A22-RLT-WS/K 10/FR
		A22-RLT-GN/K 10/FR
		A22-RLT-RT/K 01/FR

Indicator lights conical with  
BA 9s filament bulb 230 V, IP 65



Color	Function	Flush
		A22-RL-WS/FR
		A22-RL-GN/FR
		A22-RL-RT/FR
		A22-RL-GE/FR

# Complete units

Indicator light, compact without lights, Flush, with BA 9s lamp socket, IP 67, IP 69 K

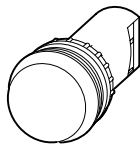

Color		
		A22-LC-W
		A22-LC-G
		A22-LC-R
		A22-LC-Y

Complete Units for surface mounting, IP 65



Button plate	Function	Push button actuators, Flush
		A22-RD-11/KC/I
		A22-RD-10/KC/I

# Accessories

## Accessories

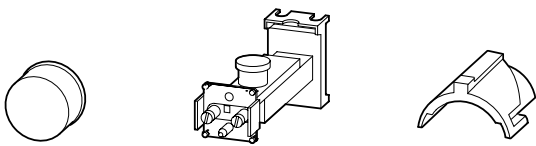

Actuator diaphragms for IP 67, Round style	A22-MT-D
Telescopic clip	A22-TC-RMO
Set of coding adapters for Selector switch actuators consist of two coding adapters	A22-SP-RMQ

Function			
Stay-put			
Spring-Return			

# Accessories

BA 9s single chip LED For 18-30 V DC / AC voltage (protected against polarity reversal)

Color/Symbol	Type
	A22-LED-W
	A22-LED-G
	A22-LED-R
	A22-LED-Y

## Push-button plates

	A22-01T
	A22-02T
	A22-03T
	A22-04T
	A22-05T
	A22-06T
	A22-10T
	A22-11T
	A22-12T
	A22-13T
	A22-14T
	A22-19T
	A22-20T
	A22-37T
	A22-38T
	A22-32T

## Complete Legend Plates,

Label mount, black, with aluminium colored insert plate

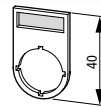

Text black	
	A22-RAS-32
	A22-RAS-33
	A22-RAS-90
	A22-RAS-93
	A22-RAS-98
STOP	A22-RAS-110
START	A22-RAS-111
MAN./AUTO	A22-RAS-395
MAN. 0 AUTO	A22-RAS-397

Insert plates, aluminium colored, can be engraved



Color	
	XA

## Label mounts

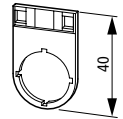

Color	
	RAS-X

## Emergency Stop Labels

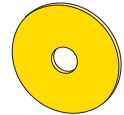

Text	
Blank	1 AK
Emergency-Stop	1 AK-999

## Enclosure, IP 65



Color	Enclosure, IP 65
Yellow/Black	A22-IGE 1M

## Enclosures IP 65, Gray / Black

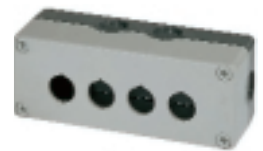

	Enclosures
(1 location)	A22-I1M
(2 locations)	A22-I2M
(3 locations)	A22-I3M
(4 locations)	A22-I4M
(5 locations)	A22-I5M

E-Mail:  
info@moeller.net  
www.moeller.net

© 2003 by Moeller GmbH  
Subject to alteration  
AH1160-0032GB MDS/?? 10/03  
Printed in the Federal Republic  
of Germany (10/03)  
Article No.: 274160

## X-ON Electronics

Largest Supplier of Electrical and Electronic Components

*Click to view similar products for [eaton](#) manufacturer:*

Other Similar products are found below :

[BK-MDL-3-R](#) [BK1-S506-500-R](#) [BK1-S506-6-3-R](#) [BK1-S506-2-R](#) [MPI4040R4-1R5-R](#) [TDC600-10A](#) [89096-015](#) [8946K153](#) [8961K155](#)  
[M22-DL-W-X0](#) [M22-D-R-GB0/K11](#) [M22-L-R/R](#) [M22S-ST-GB12](#) [630NHG3B](#) [63ET](#) [6422](#) [6580](#) [CTX20-16-52LP-R](#) [CWL530FI](#)  
[CXM/CO/GP/R/BB](#) [6HD36](#) [714125](#) [MBO-2](#) [ESR5-NO-41-24VAC-DC](#) [7314K36](#) [7321K2](#) [F02A-1-1/2A](#) [F02A-1-1/2AS](#) [F02A-1AS](#) [F02A-2AS](#) [F02A-3/4A](#) [F03A250V12A](#) [F03B125V4A](#) [MCR-4](#) [MDA-2-8/10-R](#) [MDA-30A](#) [MDA-V-1/16](#) [F60C500V10AS](#) [F60C500V15AS](#)  
[7563K84](#) [7634K36](#) [MDQ-3/16](#) [MDQ-7/10](#) [MDQ-V-1/10](#) [MDQ-V-1-1/4](#) [MDQ-V-1/16](#) [MDQ-V-1/2](#) [MDQ-V-1/4](#) [MDQ-V-3/16](#) [MDQ-V-3/8](#)