

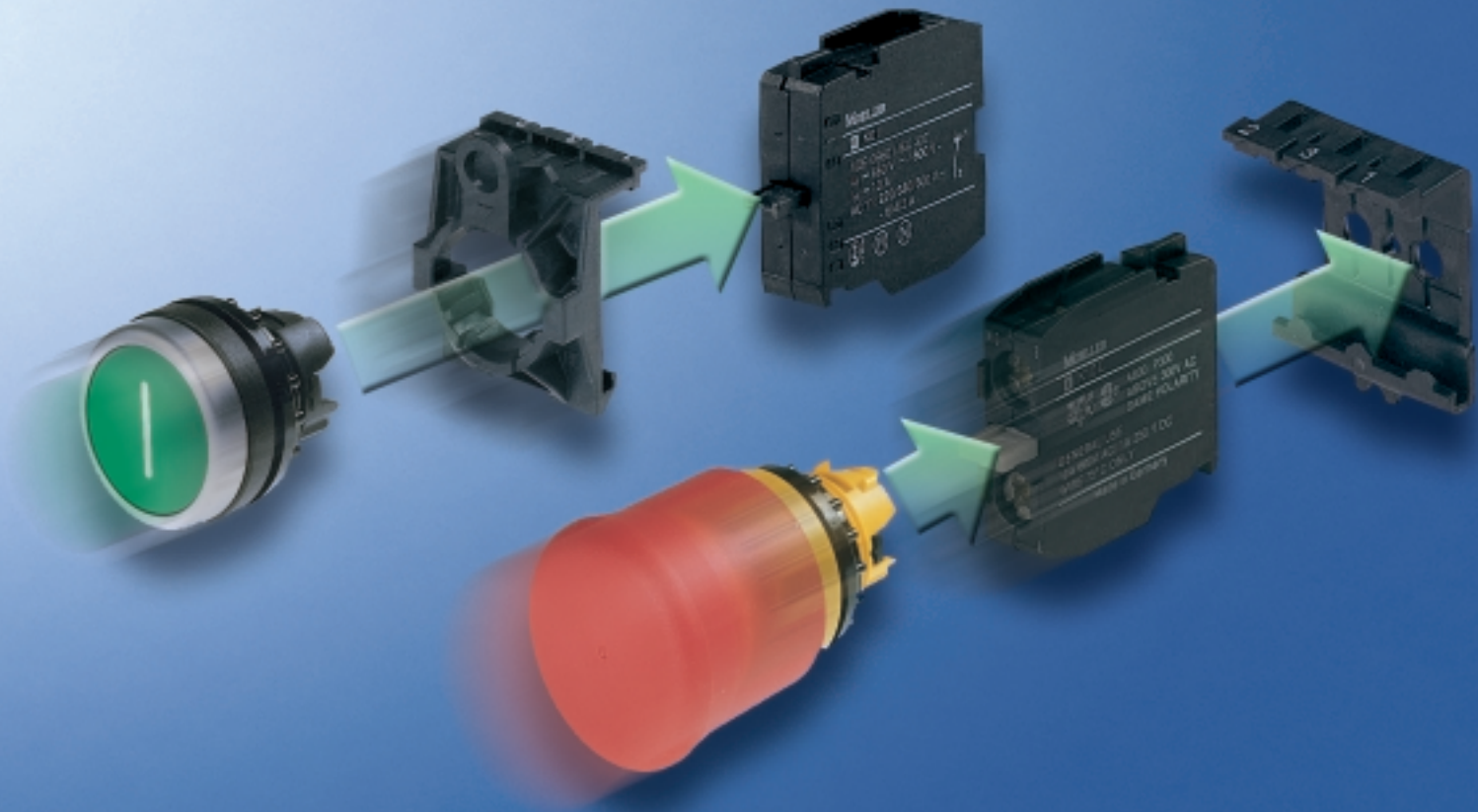











Selection aid







Reliable and Precise Command and Signalling

















A22 control circuit devices





Modular units

Push-button actuators, IP 65		Illuminated Push-button actuators, IP 65		Mushroom actuators, IP 65		
						
Button plate	Actuator flush, spring return	Button plate	Double actuator with indicator lens	Button plate	Mushroom	Mushroom actuator, spring return
	A22-RD-11		A22-QDDL-11/10			A22-RP-GN11
	A22-RD-10					A22-RP-RT10
Without	A22-RD-X					

Emergency stop actuators, IP 65		Illuminated Push-button actuators, IP 65			
					
Funktion	Mushroom actuator, spring return	Button plate	Actuator flush, spring return	Actuator flush, stay put	Actuator extended, spring return
Pull to Release	A22-RPV		A22-RLT-WS11		A22-RLTH-WS11
			A22-RLT-WS	A22-RLTR-WS	A22-RLTH-WS
			A22-RLT-GN	A22-RLTR-RN	A22-RLTH-GN
			A22-RLT-RT	A22-RLTR-RT	A22-RLTH-RT
			A22-RLT-GE	A22-RLTR-GE	A22-RLTH-GE

Indicator light lens assemblies, IP 65			Selector switch actuators, IP 65		Key-operated actuators, IP 65
					
	Flush	Conical	Funktion	Thumb-grip, 2 positions	KMS1 lock mechanism, 2 positions
	A22-RLF-WS	A22-RL-WS		A22-RWK1V	
	A22-RLF-GN	A22-RL-GN		A22-RWK1R	A22-RS
	A22-RLF-RT	A22-RL-RT		A22-RWK1	
	A22-RLF-GE	A22-RL-GE		3 positions	3 positions
	A22-RLF-BL			A22-RWK3R	A22-RS3
				A22-RWK3	A22-RS3-KMS1-A4
				Stay-put	
				Spring-Return	

Mushroom actuator IP 65		Adapters		BA9s Filament bulbs	
					
Funktion	KMS1 key release Mushroom actuator	Flushing mounting	Surface/rear mounting	BA9s Filament bulbs	Type
	A22-RPSR	A22-BE6	A22-BE3C	2W / 24 V	A22-GL24
				2.4 W / 130 V	A22-GL130

Modular units

Contact elements,
IP 20



Function	Flushing mounting	Surface/rear mounting
	A22-EK10	A22-EK10C
	A22-EK01	A22-EK01C
	A22-EC11	
	A22-EC20	
	A22-EC02	

Lamp Sockets,
IP 20



Lamp voltage	Flushing mounting	Surface/rear mounting
Max. 2 W	A22-EF	A22-EFC
Max. 2.4 W	A22-EFR	A22-EFRC

Complete units

Push-button actuators,
IP 65



Button plate	Function	Flush
		A22-RD-11/K 10
		A22-RD-11/K 11
		A22-RD-10/K 01
		A22-RD-10/K 11

Double actuators with indicator light 220-240 V,
IP 65



Button plate	Function	Flush
		A22-QDDL-11/10/K 11 F

Mushroom actuators,
IP 65



Button plate	Function	Flush
		A22-RP-GN11/K 10

Key-release mushroom actuator with two keys,
KMS1 lock mechanism, IP 65



Button plate	Function	Flush
		A22-RPSR/K 01

Illuminated push-button actuators, Flush with
BA 9s filament bulb 230 V, IP 65



Color	Function	Flush
		A22-RLT-WS/K 10/FR
		A22-RLT-GN/K 10/FR
		A22-RLT-RT/K 01/FR

Indicator lights conical with
BA 9s filament bulb 230 V, IP 65



Color	Function	Flush
		A22-RL-WS/FR
		A22-RL-GN/FR
		A22-RL-RT/FR
		A22-RL-GE/FR

Complete units

Indicator light, compact without lights, Flush, with BA 9s lamp socket, IP 67, IP 69 K

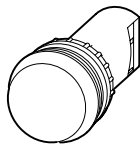

Color		
		A22-LC-W
		A22-LC-G
		A22-LC-R
		A22-LC-Y

Complete Units for surface mounting, IP 65



Button plate	Function	Push button actuators, Flush
		A22-RD-11/KC/I
		A22-RD-10/KC/I

Accessories

Accessories

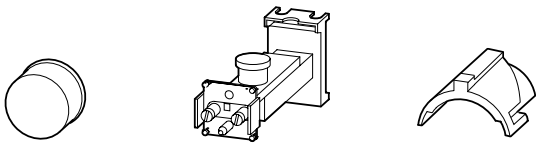

Actuator diaphragms for IP 67, Round style

A22-MT-D

Telescopic clip

A22-TC-RMO

Set of coding adapters for Selector switch actuators consist of two coding adapters

A22-SP-RMQ

Function			
Stay-put		-	
Spring-Return		-	

Accessories

BA 9s single chip LED For 18-30 V DC / AC voltage (protected against polarity reversal)

Color/Symbol	Type
	A22-LED-W
	A22-LED-G
	A22-LED-R
	A22-LED-Y

Push-button plates

	A22-01T
	A22-02T
	A22-03T
	A22-04T
	A22-05T
	A22-06T
	A22-10T
	A22-11T
	A22-12T
	A22-13T
	A22-14T
	A22-19T
	A22-20T
	A22-37T
	A22-38T
	A22-32T

Complete Legend Plates,

Label mount, black, with aluminium colored insert plate

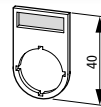

Text black	
	A22-RAS-32
	A22-RAS-33
	A22-RAS-90
	A22-RAS-93
	A22-RAS-98
STOP	A22-RAS-110
START	A22-RAS-111
MAN./AUTO	A22-RAS-395
MAN. 0 AUTO	A22-RAS-397

Insert plates, aluminium colored, can be engraved



Color	
	XA

Label mounts

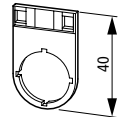

Color	
	RAS-X

Emergency Stop Labels

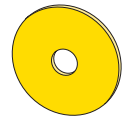

Text	
Blank	1 AK
Emergency-Stop	1 AK-999

Enclosure, IP 65



Color	Enclosure, IP 65
Yellow/Black	A22-IGE 1M

Enclosures IP 65, Gray / Black

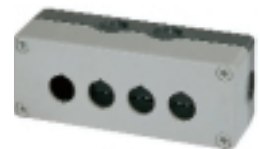

	Enclosures
(1 location)	A22-I1M
(2 locations)	A22-I2M
(3 locations)	A22-I3M
(4 locations)	A22-I4M
(5 locations)	A22-I5M

E-Mail:
info@moeller.net
www.moeller.net

© 2003 by Moeller GmbH
Subject to alteration
AH1160-0032GB MDS/?? 10/03
Printed in the Federal Republic
of Germany (10/03)
Article No.: 274160

X-ON Electronics

Largest Supplier of Electrical and Electronic Components

Click to view similar products for [Switch Hardware](#) category:

Click to view products by [Eaton](#) manufacturer:

Other Similar products are found below :

[893102000](#) [LZZ1A](#) [0098.9234](#) [61-9707.7](#) [61-9771.0](#) [M2PA-5011](#) [635401](#) [6PA104](#) [6PA113](#) [6PA147-E6](#) [6PA148-E6](#) [6PA32](#) [6PA9](#) [700106](#)
[700109](#) [700201A56](#) [700303A56](#) [700701264](#) [700C1GRY](#) [700C2GRN](#) [704-6001](#) [704.960.4](#) [704.960.9](#) [704.965.1](#) [704.965.2](#) [704.965.6](#)
[704.966.0](#) [7089-3](#) [71M1048](#) [757200264](#) [778000A56](#) [79215938](#) [MHU35](#) [MHU37](#) [825.003.011](#) [825.005.011](#) [825.053.011](#) [825.055.011](#)
[826.000.071](#) [827.020.011](#) [827.400.021](#) [835.900.023](#) [MML52C10C](#) [MML52E10C](#) [MML72EEK](#) [MML92HGH](#) [MML93K](#) [84211M02CNNS](#)
[84211M02LGRS](#) [84211M02LNNX3](#)