

96

Index

Series 96

	Description	Page 497
	Product Assembly	Page 498
	Product Range	
	- pushbuttons for standard mounting	Page 499
	- accessories / spare parts	Page 500
	Technical Data	Page 507
	Technical Drawing / Layout	Page 508
	Circuit Drawing	Page 511
	Marking	Page 512

General Notes

The input button of series 96 is a component specially designed for the requirements of modern electronic control systems. Since there is a choice of different lens shapes and colours, the panel can be arranged to suit the needs of the particular application.

Mounting

The input button is intended for mounting on printed circuit boards. Its dimensions and the arrangement of its contacts comply with a module of 2.54 mm (1/10"). Two centering pins ensure that rows or blocks are assembled without gaps, true to drawing. The input button is dust and sprayproof and suitable for machine soldering and cleaning.

Lenses

Lenses can be pressed singly on to the input button. Depending on requirements, the user can employ lenses having either a momentary or maintained action, with various standard widths and colours.

Marking

For engravings or film inserts (for lenses with window) see under "Markings" on page 512.

Illumination

For illumination, indication or functional check the input button can be equipped with one or two light-emitting diodes (LED) 3 mm dia. For illumination some lenses are provided with recesses for LEDs.

Number structure

96-323.837

96-9XX.X

Lens

96-9XX.X

Other accessories

Example:

- Lens 14.8 x 17.4 mm, red with momentary action
96-921.2

Specimen order

Indicator

- indicator element 96-302.807

Recommended accessories:

- cap for indicator,
12.4x17.4 mm, grey 96-909.8

- LED standard, 1 chip, yellow 10-2602.3174E

All dimensions in mm.

We reserve the right to modify technical data.

illuminated pushbutton

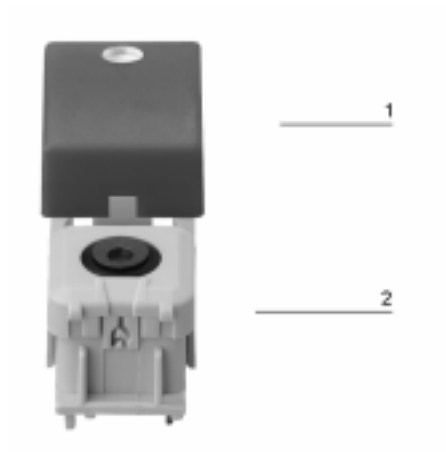

- 1 lens
- 2 switching element

indicator element



recommended accessories:

cap for indicator → 500

LED standard → 505

	connection method	part no.	technical drawing	components layout	
indicator element	P	96-302.807	1	1	0,001

connection method: P = PCB terminal

technical drawing as of page 508, components layouts as of page 510

switching element



recommended accessories:

lens standard single → 501; lens standard single for film insert → 503; lens standard double → 505

LED standard → 505

lens Euro-Style single → 504

LED Euro Style → 505

	contacts	connection method	part no.	circuit drawing	technical drawing	components layout	
switching element contact, momentary- or maintained action is determined by lens	1 C	P	96-323.837	1	2	2	0,002





connection method: P = PCB terminal

contacts: C = changeover

technical drawing as of page 508, components layouts as of page 510, circuit drawing as of page 511

at front





cap for indicator

	recess for LED	colour	 12.4 x 17.4 mm part no.	 17.4 x 17.4 mm part no.	 14.8 x 17.4 mm part no.	technical drawing		
cap for indicator	1	black (RAL 9011)	96-909.0	96-939.0	96-929.0	1	0,001	
		green (RAL 6005)	96-909.5	96-939.5	96-929.5	1	0,001	
		grey (RAL 7012)	96-909.8	96-939.8	96-929.8	1	0,001	
		red (RAL 3016)	96-909.2	96-939.2	96-929.2	1	0,001	
	2	black (RAL 9011)	96-910.0	96-940.0	96-930.0	1	0,001	
		green (RAL 6005)	96-910.5	96-940.5	96-930.5	1	0,001	
		grey (RAL 7012)	96-910.8	96-940.8	96-930.8	1	0,001	
		red (RAL 3016)	96-910.2	96-940.2	96-930.2	1	0,001	

marking see [page 512](#)





technical drawing as of [page 508](#)

lens standard single

lens stan- dard single	switching action	recess for LED	colour				technical drawing			
				12.4 x 17.4 mm part no.	17.4 x 17.4 mm part no.	14.8 x 17.4 mm part no.				
lens stan- dard single	main	0	black (RAL 9011)	96-905.0	96-935.0	96-925.0	3	0,001		
			blue	98-905.6	98-935.6	98-925.6	3	0,001		
			green	98-905.5	98-935.5	98-925.5	3	0,001		
			green (RAL 6005)	96-905.5	96-935.5	96-925.5	3	0,001		
			grey	98-905.8	98-935.8	98-925.8	3	0,001		
			grey (RAL 7012)	96-905.8	96-935.8	96-925.8	3	0,001		
			orange	98-905.3	98-935.3	98-925.3	3	0,001		
			red	98-905.2	98-935.2	98-925.2	3	0,001		
			red (RAL 3016)	96-905.2	96-935.2	96-925.2	3	0,001		
			white	98-905.9	98-935.9	98-925.9	3	0,001		
		yellow	98-905.4	98-935.4	98-925.4	3	0,001			
		1			black (RAL 9011)	96-906.0	96-936.0	96-926.0	3	0,001
					blue	98-906.6	98-936.6	98-926.6	3	0,001
					green	98-906.5	98-936.5	98-926.5	3	0,001
					green (RAL 6005)	96-906.5	96-936.5	96-926.5	3	0,001
					grey	98-906.8	98-936.8	98-926.8	3	0,001
					grey (RAL 7012)	96-906.8	96-936.8	96-926.8	3	0,001
					orange	98-906.3	98-936.3	98-926.3	3	0,001
					red	98-906.2	98-936.2	98-926.2	3	0,001
					red (RAL 3016)	96-906.2	96-936.2	96-926.2	3	0,001
					white	98-906.9	98-936.9	98-926.9	3	0,001
		yellow	98-906.4	98-936.4	98-926.4	3	0,001			
		2			black (RAL 9011)	96-907.0	96-937.0	96-927.0	3	0,001
					blue	98-907.6	98-937.6	98-927.6	3	0,001
					green	98-907.5	98-937.5	98-927.5	3	0,001
					green (RAL 6005)	96-907.5	96-937.5	96-927.5	3	0,001
					grey	98-907.8	98-937.8	98-927.8	3	0,001
					grey (RAL 7012)	96-907.8	96-937.8	96-927.8	3	0,001
					orange	98-907.3	98-937.3	98-927.3	3	0,001
					red	98-907.2	98-937.2	98-927.2	3	0,001
					red (RAL 3016)	96-907.2	96-937.2	96-927.2	3	0,001
					white	98-907.9	98-937.9	98-927.9	3	0,001
		yellow	98-907.4	98-937.4	98-927.4	3	0,001			





To be continued on next side

lens stan- dard single	switching action	recess for LED	colour				technical drawing		
				12.4 x 17.4 mm part no.	17.4 x 17.4 mm part no.	14.8 x 17.4 mm part no.			
lens stan- dard single	mom	0	black (RAL 9011)	96-901.0	96-931.0	96-921.0	3	0,001	
			blue	98-901.6	98-931.6	98-921.6	3	0,001	
			green	98-901.5	98-931.5	98-921.5	3	0,001	
			green (RAL 6005)	96-901.5	96-931.5	96-921.5	3	0,001	
			grey	98-901.8	98-931.8	98-921.8	3	0,001	
			grey (RAL 7012)	96-901.8	96-931.8	96-921.8	3	0,001	
			orange	98-901.3	98-931.3	98-921.3	3	0,001	
			red	98-901.2	98-931.2	98-921.2	3	0,001	
			red (RAL 3016)	96-901.2	96-931.2	96-921.2	3	0,001	
			white	98-901.9	98-931.9	98-921.9	3	0,001	
			yellow	98-901.4	98-931.4	98-921.4	3	0,001	
			1	0	black (RAL 9011)	96-902.0	96-932.0	96-922.0	3
		blue			98-902.6	98-932.6	98-922.6	3	0,001
		green			98-902.5	98-932.5	98-922.5	3	0,001
		green (RAL 6005)			96-902.5	96-932.5	96-922.5	3	0,001
		grey			98-902.8	98-932.8	98-922.8	3	0,001
		grey (RAL 7012)			96-902.8	96-932.8	96-922.8	3	0,001
		orange			98-902.3	98-932.3	98-922.3	3	0,001
		red			98-902.2	98-932.2	98-922.2	3	0,001
		red (RAL 3016)			96-902.2	96-932.2	96-922.2	3	0,001
		white			98-902.9	98-932.9	98-922.9	3	0,001
		yellow			98-902.4	98-932.4	98-922.4	3	0,001
		2			0	black (RAL 9011)	96-903.0	96-933.0	96-923.0
			blue	98-903.6		98-933.6	98-923.6	3	0,001
			green	98-903.5		98-933.5	98-923.5	3	0,001
			green (RAL 6005)	96-903.5		96-933.5	96-923.5	3	0,001
			grey	98-903.8		98-933.8	98-923.8	3	0,001
			grey (RAL 7012)	96-903.8		96-933.8	96-923.8	3	0,001
			orange	98-903.3		98-933.3	98-923.3	3	0,001
			red	98-903.2		98-933.2	98-923.2	3	0,001
			red (RAL 3016)	96-903.2		96-933.2	96-923.2	3	0,001
			white	98-903.9		98-933.9	98-923.9	3	0,001
			yellow	98-903.4		98-933.4	98-923.4	3	0,001



switching action: main = maintained action, mom = momentary action
 marking see page 512
 technical drawing as of page 508

lens standard single for film insert

	switching action	recess for LED	colour	 17.4 x 17.4 mm part no.	technical drawing			
lens standard single for film insert	main	0	black (RAL 9011)	96-945.0	4	0,001		
			blue	98-945.6	4	0,001		
			green	98-945.5	4	0,001		
			green (RAL 6005)	96-945.5	4	0,001		
			grey	98-945.8	4	0,001		
			grey (RAL 7012)	96-945.8	4	0,001		
			orange	98-945.3	4	0,001		
			red	98-945.2	4	0,001		
			red (RAL 3016)	96-945.2	4	0,001		
			white	98-945.9	4	0,001		
			yellow	98-945.4	4	0,001		
			1	black (RAL 9011)	96-946.0	4		0,001
		blue		98-946.6	4	0,001		
		green		98-946.5	4	0,001		
		green (RAL 6005)		96-946.5	4	0,001		
		grey		98-946.8	4	0,001		
		grey (RAL 7012)		96-946.8	4	0,001		
		orange		98-946.3	4	0,001		
		red		98-946.2	4	0,001		
		red (RAL 3016)		96-946.2	4	0,001		
		white		98-946.9	4	0,001		
		yellow		98-946.4	4	0,001		
		2		black (RAL 9011)	96-947.0	4		0,001
			blue	98-947.6	4	0,001		
			green	98-947.5	4	0,001		
			green (RAL 6005)	96-947.5	4	0,001		
			grey	98-947.8	4	0,001		
			grey (RAL 7012)	96-947.8	4	0,001		
			orange	98-947.3	4	0,001		
			red	98-947.2	4	0,001		
			red (RAL 3016)	96-947.2	4	0,001		
			white	98-947.9	4	0,001		
			yellow	98-947.4	4	0,001		
			mom	0	black (RAL 9011)	96-941.0		4
		blue			98-941.6	4		0,001
		green			98-941.5	4		0,001
	green (RAL 6005)	96-941.5			4	0,001		
	grey	98-941.8			4	0,001		
	grey (RAL 7012)	96-941.8			4	0,001		
	orange	98-941.3			4	0,001		
	red	98-941.2			4	0,001		
	red (RAL 3016)	96-941.2			4	0,001		
	white	98-941.9			4	0,001		
	yellow	98-941.4			4	0,001		
	1	black (RAL 9011)			96-942.0	4		0,001
blue		98-942.6		4	0,001			
green		98-942.5		4	0,001			
green (RAL 6005)		96-942.5		4	0,001			

To be continued on next side

	switching action	recess for LED	colour	17.4 x 17.4 mm part no.	technical drawing	
lens standard single for film insert	mom	1	grey	98-942.8	4	0,001
			grey (RAL 7012)	96-942.8	4	0,001
			orange	98-942.3	4	0,001
			red	98-942.2	4	0,001
			red (RAL 3016)	96-942.2	4	0,001
			white	98-942.9	4	0,001
		yellow	98-942.4	4	0,001	
		2	black (RAL 9011)	96-943.0	4	0,001
			blue	98-943.6	4	0,001
			green	98-943.5	4	0,001
	green (RAL 6005)		96-943.5	4	0,001	
	grey		98-943.8	4	0,001	
	grey (RAL 7012)		96-943.8	4	0,001	
	orange		98-943.3	4	0,001	
	red		98-943.2	4	0,001	
	red (RAL 3016)		96-943.2	4	0,001	
	white		98-943.9	4	0,001	
	yellow	98-943.4	4	0,001		



switching action: main = maintained action, mom = momentary action

marking see page 512

technical drawing as of page 508

lens Euro-Style single

	switching action	recess for LED	colour	12.4 x 17.4 mm part no.	technical drawing	
lens Euro-Style single	main	0	black (RAL 9011)	96-905.01	5	0,001
			green (RAL 6005)	96-905.51	5	0,001
			grey (RAL 7012)	96-905.81	5	0,001
			red (RAL 3016)	96-905.21	5	0,001
		1	black (RAL 9011)	96-906.01	5	0,001
			green (RAL 6005)	96-906.51	5	0,001
			grey (RAL 7012)	96-906.81	5	0,001
			red (RAL 3016)	96-906.21	5	0,001
		2	black (RAL 9011)	96-907.01	5	0,001
			green (RAL 6005)	96-907.51	5	0,001
			grey (RAL 7012)	96-907.81	5	0,001
			red (RAL 3016)	96-907.21	5	0,001
	mom	0	black (RAL 9011)	96-901.01	5	0,001
			green (RAL 6005)	96-901.51	5	0,001
			grey (RAL 7012)	96-901.81	5	0,001
			red (RAL 3016)	96-901.21	5	0,001
		1	black (RAL 9011)	96-902.01	5	0,001
			green (RAL 6005)	96-902.51	5	0,001
			grey (RAL 7012)	96-902.81	5	0,001
			red (RAL 3016)	96-902.21	5	0,001
		2	black (RAL 9011)	96-903.01	5	0,001
			green (RAL 6005)	96-903.51	5	0,001
			grey (RAL 7012)	96-903.81	5	0,001
			red (RAL 3016)	96-903.21	5	0,001



switching action: main = maintained action, mom = momentary action

marking see page 512

technical drawing as of page 508

lens standard double

	switching action	recess for LED	colour	17.4 x 35.2 mm part no.	technical drawing		
lens standard double	mom	0	black (RAL 9011)	96-951.0	6	0,002	
			green (RAL 6005)	96-951.5	6	0,002	
			grey (RAL 7012)	96-951.8	6	0,002	
			red (RAL 3016)	96-951.2	6	0,002	

switching action: mom = momentary action

marking see page 512

technical drawing as of page 508

blind plug

	colour	12.4 x 17.4 mm part no.	17.4 x 17.4 mm part no.	14.8 x 17.4 mm part no.		
blind plug	black (RAL 9011)	96-908.0	96-938.0	96-928.0	0,001	
	green (RAL 6005)	96-908.5	96-938.5	96-928.5	0,001	
	grey (RAL 7012)	96-908.8	96-938.8	96-928.8	0,001	
	red (RAL 3016)	96-908.2	96-938.2	96-928.2	0,001	

for lens

LED standard



	number of chips	voltage/current	colour	part no.		
LED standard Bi-Pin T1, 20 mA, without series resistor, typ. forward voltage 2.2 VDC, with special pin shape	1 chip	2,2 VDC/20 mA	green	10-2602.3175E	0,001	
			red	10-2602.3172E	0,001	
			yellow	10-2602.3174E	0,001	

LED Euro Style

	number of chips	voltage/current	colour	part no.		
LED Euro Style bi-pin T1, 20 mA, without ballast resistor, typ. forward voltage 2,2 VDC, with special pin crank	1 chip	2,2 VDC/20 mA	green	10-2602.3175J	0,001	
			red	10-2602.3172J	0,001	
			yellow	10-2602.3174J	0,001	

assembling

lens remover

	part no.	 kg	
lens remover	98-968	0,004	

Technical Data

snap-action switching element

switching system

Single-break, self-cleaning, snap-action switching element with tactile feel of operation.

material

actuator case

polyester, self-extinguishing

lens Euro-Style

ABS/PC or ABS, self-extinguishing

material of contacts

gold-plated on nickel

switch rating

switching voltage VDC/VAC min. 100 μ V max. 42 V
switching current VDC/VAC min. 50 μ A max. 100 mA

volume resistance

starting value (initial) \leq 100 m Ω as per IEC 512-2, test 2b

mechanical characteristics

actuating force

actuating force 1.4 \pm 0.3 N

actuating travel

lead distance 1.0 \pm 0.3 mm
total distance 1.7 \pm 0.5 mm

ambient air temperature

-25°C to +85°C
(as per DIN IEC 68-)

connection method

PCB terminal

degree of protection

IP 67 as per IEC 529

mechanical life

\geq 5 mio. operations as per IEC 512-5, test 9a

rebound time

\leq 2.5 ms

resistance to shock

(single impacts, semi-sinusoidal)
 \geq 30 g for 11 ms as per IEC 512-4-3

resistance to vibration

(sinusoidal)
10 g at 10-2000 Hz, amplitude 0.75 mm as per IEC 512-4-4

storage temperature

-40°C to +85°C
(as per DIN IEC 68-)

electrical characteristics

capacity

between contacts \leq 1 pF

continuous thermal current I_{th2}

100 mA

electric strength

500 VAC, 50 Hz, 1 min. between all terminals and earth, as per IEC 512-2-11

electrical life

\geq 5 x 100.000 operations at 30 VDC/100 mA as per IEC 512-5, test 9c

insulation resistance

\geq 10¹² Ω between contacts at 100 VDC, as per IEC 512-2, test 3a

technical drawing

1 indicator element, cap for indicator

page 499, 500

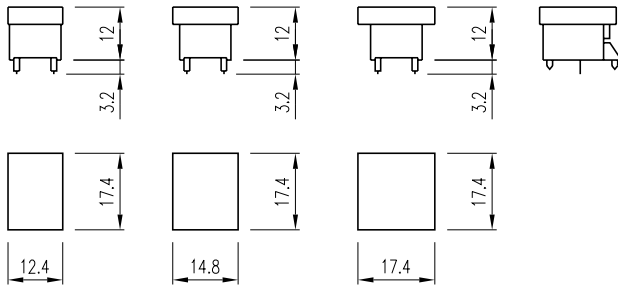

2 switching element

page 499

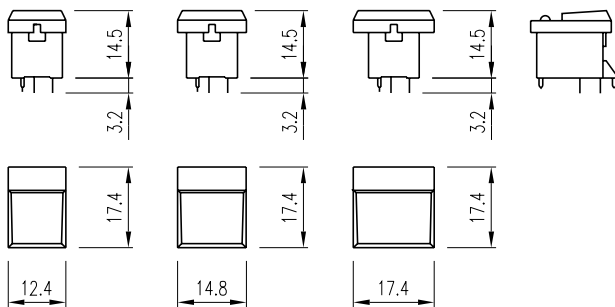

3 lens standard single

page 501

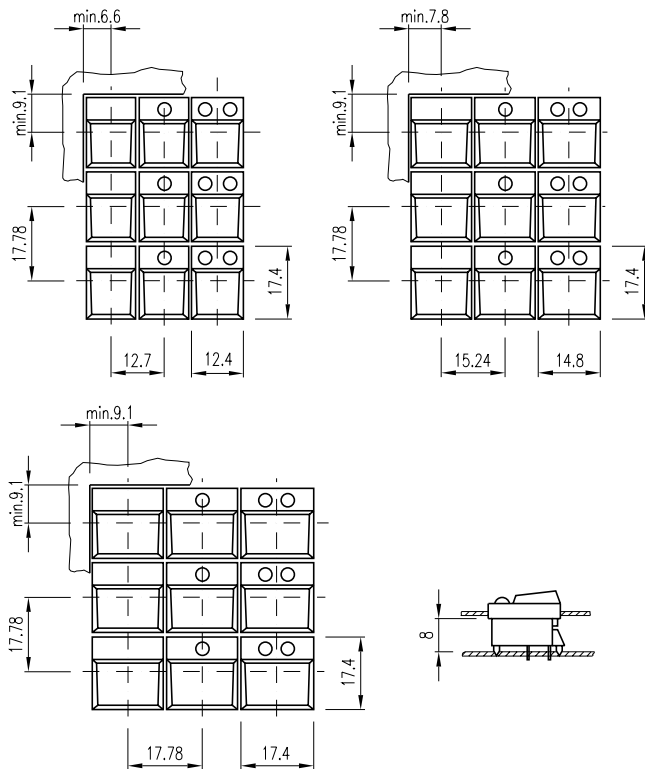

4 lens standard single for film insert
page 503

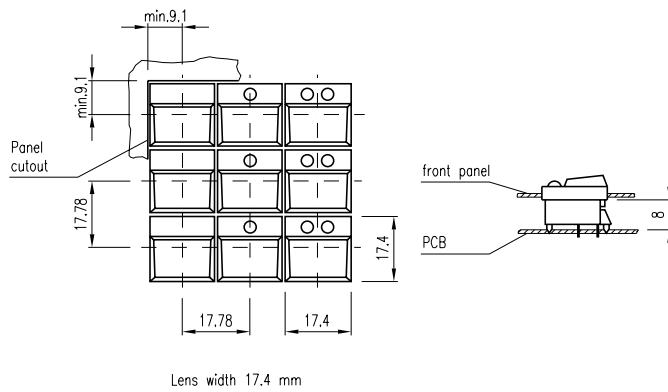

5 lens Euro-Style single
page 504

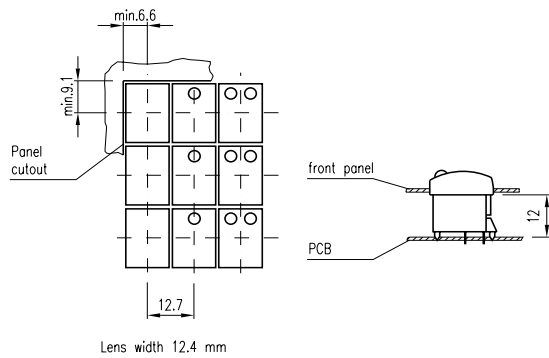

6 lens standard double
page 505

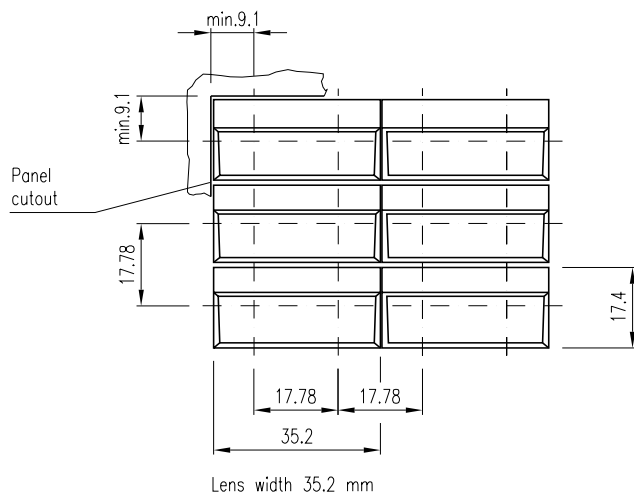

components layouts

1 indicator element

page 499

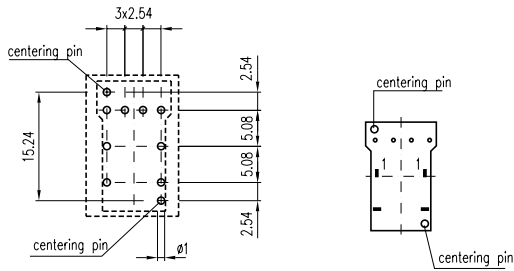

2 switching element

page 499

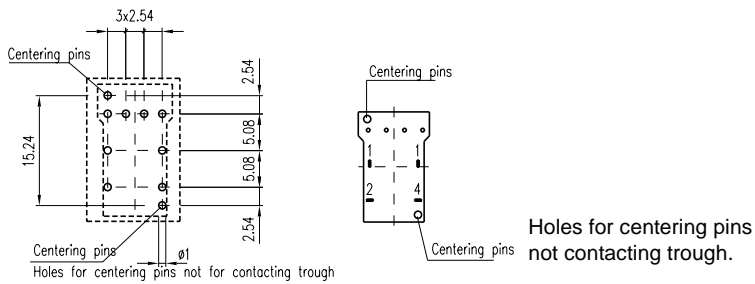

	1	2	4
	1		

1. Engraving

Typefaces

In addition to the most commonly used world languages (see DIN 1451) with close spacing, the following typefaces are available: Scandinavian, Slavian, Greek, Russian.

Coloured filling of engraving

Unless requested otherwise by the customer, the lettering on grey and green lenses will be in black, that on black and red lenses in white.

Symbols

A list of the symbols available can be supplied on request.

2. Stamping

- on request

3. Film inserts

A special lens, 17.4 x 17.4 mm, available for insertion of a colour foil or film.

Film/Colour foil dimensions

7 x 12 mm

Film thickness max. 0,2 mm

Height of letters mm		Thickness mm	Number of lines		Engraving area A Number of letters per line		Engraving area B Number of letters per line		Number of lines		Engraving area A Number of letters per line		Engraving area B Number of letters per line		Number of lines		Engraving area A Number of letters per line		Engraving area B Number of letters per line		Number of lines		Engraving area A Number of letters per line		Engraving area B Number of letters per line	
h	s		Engraving area A	Engraving area B	Capital	Small	Capital	Small	Engraving area A	Engraving area B	Capital	Small	Capital	Small	Engraving area A	Engraving area B	Capital	Small	Capital	Small	Engraving area A	Capital	Small	Engraving area A	Capital	Small
2,5	0,4	1	2	6	6-7	5	6-7	1	2	7	7-8	6	7-8	1	2	8-9	9-10	7-8	8-9	1	8-9	9-10				
3	0,4	1	2	4	5	4	4-5	1	2	5-6	6-7	5	6	1	2	7-8	8-9	6-7	7-8	1	7-8	8-9				
4	0,5	1	1	3-4	4	3-4	4	1	1	4	4-5	4	4	1	1	5	5-6	4-5	5-6	1	5	5-6				
5	0,5	-	1	-	-	2-3	3	-	1	-	-	3	3-4	-	1	-	-	3-4	4	-	-	-				
6	0,6	-	1	-	-	2	2	-	1	-	-	2-3	3	-	1	-	-	2-3	3	-	-	-				
8	0,6	-	1	-	-	1	1	-	1	-	-	1-3	2	-	1	-	-	2	2-3	-	-	-				

X-ON Electronics

Largest Supplier of Electrical and Electronic Components

Click to view similar products for [eao manufacturer](#):

Other Similar products are found below :

[01-951.5](#) [21-931.0](#) [01-261.022](#) [02-072.001](#) [61-0029.0](#) [61-1300.0](#) [61-221.50D](#) [61-2601.0/D](#) [61-2701.0/D](#) [61-8640.11](#) [61-8720.17](#) [704.012.0](#)
[704.062.218](#) [704.113.0](#) [704.117.0](#) [704.121.0](#) [704.411.018I](#) [704-6012](#) [704.901.1](#) [704.902.3](#) [704-9051](#) [704.950.0](#) [EUS-704.000.7](#) [82-](#)
[4151.2144](#) [82-4153.1000](#) [84-8515.8640](#) [92-343.400](#) [95-900.005](#) [14-136.025K](#) [14-810.910](#) [200-4000-00](#) [200-4001-00](#) [22-212.011](#) [95-](#)
[900.009](#) [22-225.011](#) [22-901.2](#) [31-426.036](#) [45-1231.21N6.000.101](#) [45-2134.4F10.000](#) [45-280X.1C90.003](#) [45-2C37.1920.000](#) [45-](#)
[2T00.10E0.000](#) [51-401.036K](#) [51-901.4](#) [31-953.3](#) [31-955.4](#) [41-461.036](#) [41-908.5/5](#) [45-1131.3150.000.101](#) [45-2131.2150.000](#)