

Contactors



Motor Protection and Monitoring Relays



Manual Motor Protectors and Controllers



Soft Starters



Drives



2.1 Contactors

Product Overview	V9-T2-2
Compact Definite Purpose Contactors	V9-T2-3
50 mm C25 Definite Purpose Contactors	V9-T2-5
XT IEC Miniature Contactors	V9-T2-7
XT IEC Contactors	V9-T2-9

2.2 Motor Protection and Monitoring Relays

Product Overview	V9-T2-15
D65 Series Monitoring Relays	V9-T2-17
D65C Series Monitoring Relays	V9-T2-19
XT IEC Miniature Overload Relays	V9-T2-22
XTOB, XTOT Thermal Overload Relays	V9-T2-23
XT Electronic Overload Relays	V9-T2-26
Motor Insight Overload and Monitoring Relays	V9-T2-32

2.3 Manual Motor Protectors and Controllers

Product Overview	V9-T2-34
XT IEC Manual Motor Protectors	V9-T2-35
XT IEC Manual and Combination Motor Controllers	V9-T2-39

2.4 Soft Starters

Product Overview	V9-T2-45
S701 Soft Start Controller	V9-T2-46
DS6 Soft Start Controller	V9-T2-48
S801 Soft Starter	V9-T2-49
S811 Communicating Soft Starter	V9-T2-55

2.5 Drives

Product Overview	V9-T2-61
M-Max Machinery Drive	V9-T2-62
SVX9000 Drives	V9-T2-64

For our complete product offering, see Volume 5—Motor Control and Protection, CA08100006E and Volume 6—Solid-State Motor Control, CA08100007E.

Product Overview

2 Contactors Selection Guide



Description	Definite Purpose Contactors Page V9-T2-3	X7IEC Miniature Contactors Page V9-T2-7	X7IEC Contactors Page V9-T2-9
Type	Definite purpose	IEC	IEC
Approvals	UL [®] Recognized, CSA [®] , CE, ARI, RoHS	UL, IEC EN 60947, CE, CSA, RoHS	UL, IEC EN 60947, CE, CSA, RoHS
Technical Data			
Pole configurations	1P, 2P, 3P, 4P	3P, 4P	3P, 4P
Inductive Amp ratings	To 360A	To 8.8A (AC-3)	To 1600A (AC-3)
Resistive Amp ratings	To 360A	To 20A (AC-1)	To 2450A (AC-1)
Typical electrical operations	To 300,000	To 750,000	To 1,400,000

For our complete product offering, see Volume 5—Motor Control and Protection, CA08100006E.

Compact Definite Purpose Contactors



Features

- Insulation voltage: 690V
- Current rated and hp/kW rated
- Magnet coil: Class F, 155°C
- Contact arc covers are standard on all contactors

Product Selection

Compact Definite Purpose Contactors—Open Type

Ampere Ratings ①

Inductive Full Load	Resistive	Locked Rotor 240–277V	Catalog Number ②
Single-Pole			
30	40	150	C25ANB130_
40	50	240	C25ANB140_
Single-Pole with Shunt			
30	40	150	C25CNB130_
40	50	240	C25CNB140_
Two-Pole			
25	35	150	C25BNB225_
30	40	150	C25BNB230_
40	50	240	C25BNB240_

Magnet Coil Selection

AC Coil Voltage 50/60 Hz	Coil Suffix
24	T
110–120	A
208–240	B

Notes

- ① Rating per pole.
- ② Replace underscore (_) in catalog number with coil suffix letter from table at left.

Catalog Number Selection

Definite Purpose Contactors

2

Definite Purpose Contactors

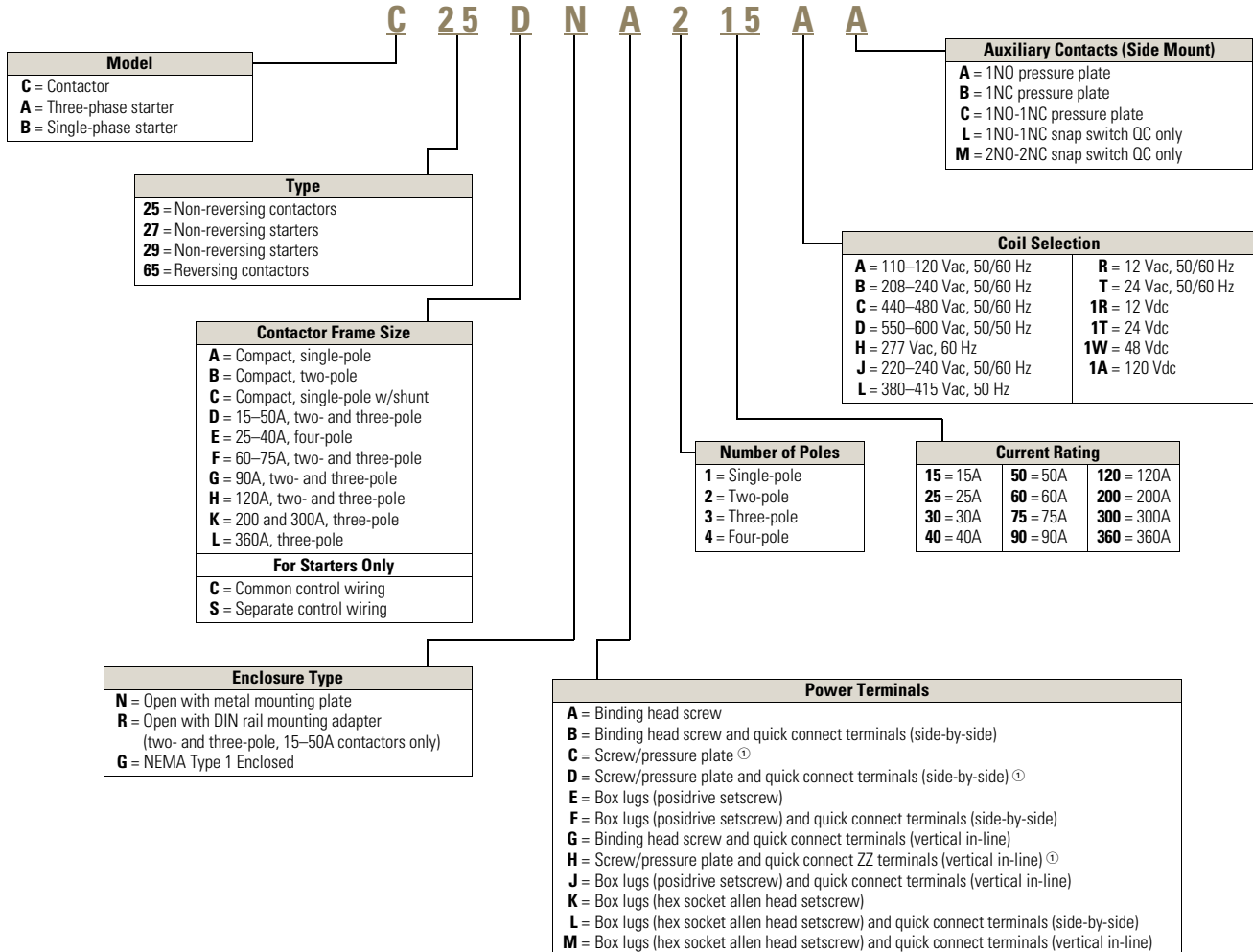

Note

^① Not available on 50A devices.

50 mm C25 Definite Purpose Contactors



Features

- Contactors are dual-rated with inductive and resistive ratings, as well as horsepower and kilowatt ratings
- Contactors rated 15–50A are available with DIN rail mount as a factory installed option
- Magnet coil: Class B (C25E, F, G, H and K), 130°C
- Ambient temperature: 150°F (65°C) maximum

Product Selection

50 mm C25 Definite Purpose Contactors

C25 Contactors—Open Type

Rating, Amperes Inductive Full Load	Resistive per Pole	Line Voltage	Locked Rotor	Maximum Motor Horsepower		Open Type with Metal Mounting Plate Catalog Number ^{①②}	Open Type with DIN Rail Adapter Catalog Number ^{①②}
				Single-Phase	Three-Phase		
15	20	230	90	2	3	C25DND315_	C25DRD315_
		460	75	—	5		
		575	60	—	5		
25	35	230	150	3	7-1/2	C25DND325_	C25DRD325_
		460	125	—	10	C25END425_	
		575	100	—	10		
30	40	230	180	5	10	C25DND330_	C25DRD330_
		460	150	—	15	C25END430_	
		575	120	—	15		
40	50	230	240	7-1/2	10	C25DNF340_	C25DRF340_
		460	200	—	20	C25ENF440_	
		575	160	—	20		
50	65	230	300	10	15	C25DNJ350_	C25DRJ350_
		460	250	—	30		
		575	200	—	30		
60	75	230	360	10	20	C25FNF360_	—
		460	300	—	40		
		575	240	—	40		
75	90	230	450	15	20	C25FNF375_	—
		460	375	—	50		
		575	300	—	50		

Magnet Coil Selection

Voltage	50 Hz	Coil Suffix
60 Hz		
AC ^③		
24 ^④	24	T
110–120 ^⑤	110–120 ^⑤	A
208–240 ^⑤	208–240	B
DC ^⑥		
24		1T

Notes

- ① Replace underscore (_) in catalog number with magnet coil suffix from table at left.
- ② Carton quantities including 20 individually packaged units are available for two- and three-pole units through 60A inductive.
- ③ Class H AC coils available as option for 15–50A contactor. Add 2 before AC coil suffix letter.
- ④ Available through 120A.
- ⑤ 104–120V 50/60 Hz for 60A, 75A and all four-pole contactors (25–40A).
- ⑥ Contactors with DC coils (only available up to 75A) include an early break NC auxiliary contact, C320KGD1.

2.1

Motor Control and Protection

Contactors

Reversing and Two-Speed Contactors—Open Type—Unwired, Mechanically Interlocked Only

2

Rating, Amperes Inductive Full Load	Resistive per Pole	Line Voltage	Locked Rotor	Maximum Motor Horsepower		Open Type with Metal Mounting Plate Catalog Number ^①
				Single-Phase	Three-Phase	
15	20	230	90	2	3	C65DND315_
		460	75	—	5	
		575	60	—	5	
25	35	230	150	3	7-1/2	C65DND325_
		460	125	—	10	
		575	100	—	10	
30	40	230	180	5	10	C65DND330_
		460	150	—	15	
		575	120	—	15	
40	50	230	240	7-1/2	10	C65DNF340_
		460	200	—	20	
		575	160	—	20	
50	65	230	300	10	15	C65DNJ350_
		460	250	—	30	
		575	200	—	30	

Magnet Coil Selection

Voltage 60 Hz	50 Hz	Coil Suffix ^②
24	24	T
110–120 ^③	110–120 ^③	A
208–240 ^④	208–240	B

Notes

- ① Replace underscore (_) with magnet coil suffix from table at left.
- ② Class H AC coils available as option for 15–50A contactor. Add Z before AC coil suffix letter.
- ③ 104–120V 50/60 Hz for 60A, 75A.
- ④ Available through 50A.

XTIEC Miniature Contactors



Features

- Reversing or non-reversing
- Three- and four-pole configurations
 - Three-pole XTMC
 - Four-pole XTMF
- Panel or DIN rail mounting
- IP20 finger and back-of-hand proof
- Direct mount with XTOM miniature overload relays

Catalog Number Selection

XTIEC Miniature Contactors

Miniature Contactors

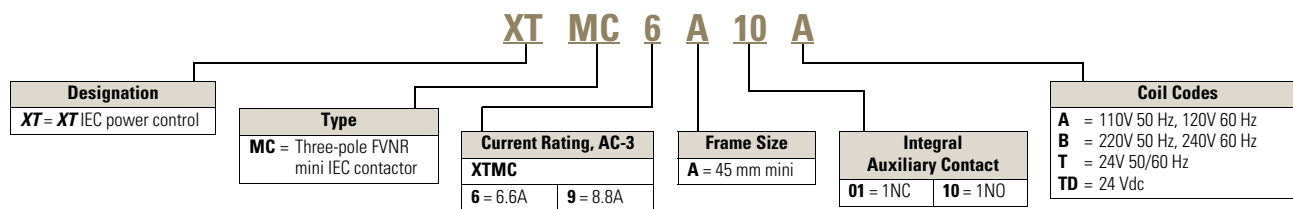

Product Selection

Full Voltage Non-Reversing Miniature Contactors

Operational Current AC-3 Amp Rating 380/400V	Conventional Free Air Thermal Current AC-1 at 50°C	Maximum kW Ratings AC-3 Three-Phase Motors, 50–60 Hz				Maximum Three-Phase Motor Ratings Single-Phase hp Ratings				Maximum Three-Phase Motor Ratings Three-Phase hp Ratings				Number of Power Poles	Auxiliary Contacts	Catalog Number—Screw Terminals ①
		220–240V	380–400V	550V	660/690V	115V	200V	230V	200V	230V	460V	575V				
6.6	20	1.5	3	3	3	1/4	3/4	1	1-1/2	2	3	3	3	1NO	XTMC6A10_	
6.6	20	1.5	3	3	3	1/4	3/4	1	1-1/2	2	3	3	3	1NC	XTMC6A01_	
8.8	20	2.2	4	4	4	1/2	1	1-1/2	2	3	5	5	3	1NO	XTMC9A10_	
8.8	20	2.2	4	4	4	1/2	1	1-1/2	2	3	5	5	3	1NC	XTMC9A01_	
8.8	20	2.2	4	4	4	1/2	1	1-1/2	2	3	5	5	4	—	XTMF9A00_	

Magnet Coil Suffix

Coil Voltage	Suffix Code
110V 50 Hz, 120V 60 Hz	A
220V 50 Hz, 240V 60 Hz	B
24V 50/60 Hz	T
24 Vdc	TD ②
415V 50 Hz, 480V 60 Hz	C
550V 50 Hz, 600V 60 Hz	D
208V 60 Hz	E

IEC Utilization Categories

- AC-1: Non-inductive or slightly inductive loads.
- AC-3: Squirrel cage motors—starting, switching of motors during running.
- AC-4: Squirrel cage motors—starting, plugging, inching.

Notes

- ① Underscore (_) indicates magnet coil suffix required. See table at left.
- ② With DC operation: Integrated diode resistor combination, coil rating 2.6W.

Accessories

2

Front Mount Auxiliary Contacts ^①

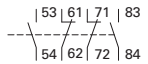
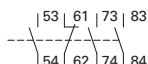
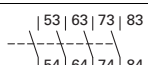
Conventional Free Air Thermal Current, $I_{th} = I_{\theta}$, AC-1 in Amps	Contact Configuration	Contact Sequence	Package Qty.	Catalog Number—Screw Terminals
10	1NO-1NC		5	XTMCXFA11
10	2NO-2NC		5	XTMCXFA22
10	3NO-1NC		5	XTMCXFA31
10	4NO		5	XTMCXFA40

XT IEC Miniature Contactors

Description	Package Qty.	Catalog Number
Mechanical interlock	5	XTMCXML
Reversing link kit—main current wiring for reversing contactors and starters	1	XTMCXRL ^②
Connector—for mechanically arranging contactors and timing relays in combinations	50	XTMCXCN ^③

Notes

- ① For two contactors with AC or DC operated magnet system that are horizontally or vertically mounted, the distance between contactors is 0 mm, and the mechanical lifespan is 2.5×10^6 operations. The following control cables are integrated as part of the electrical interlock:
K1M: A1—K2M: 21; K1M: 21—K2M: A1.
- ② Reversing link kit does not include mechanical interlock.
- ③ 0 mm distance between contactors.

XT IEC Contactors



Features

- Reversing or non-reversing contactors
- AC-3 contactor ratings to 1600A and AC-1 contactor ratings to 2000A
- Panel or DIN rail mounting to 65A
- IP20 finger and back-of-hand proof
- Built-in NO or NC auxiliary contacts to 32A
- Built-in surge suppression on DC coils XTCE Frame B-G and AC or DC coils on XTCE Frame L-R
- Can be used with **XT** or C396 overload relays
- Can be used with XTPR MMPs for manual motor controllers or UL508 Type F combination motor controllers

Catalog Number Selection

XT IEC Contactors

Contactors

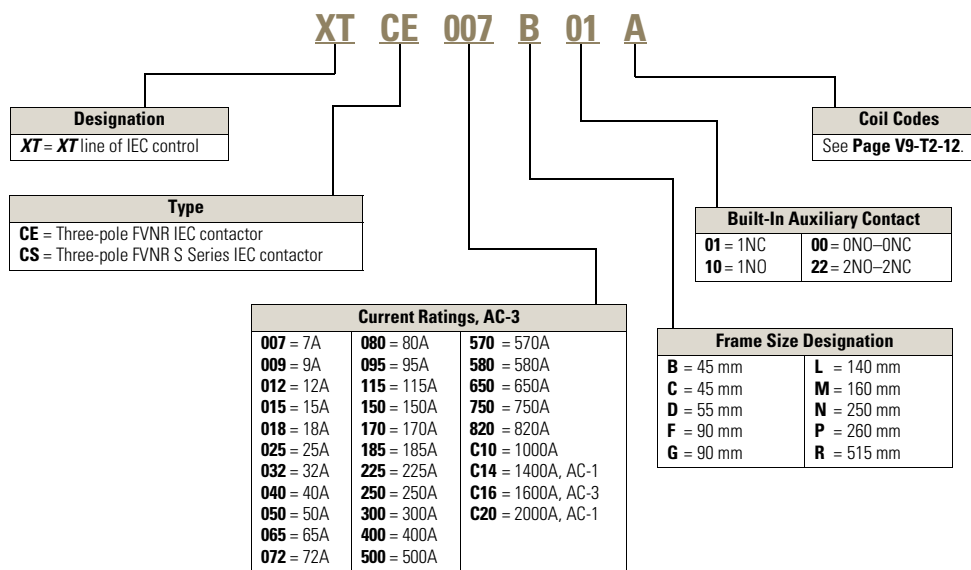

2.1

Motor Control and Protection

Contactors

Product Selection

2

Full Voltage Non-Reversing Three-Pole Contactors, Frames B–G

UL/CSA Ratings				IEC Ratings						Maximum kW Ratings AC-3 Three-Phase Motors 50–60 Hz				Auxiliary Contacts	Catalog Number—Screw Terminals ^{①②}
UL General Purpose Amp Rating	Single-Phase hp Ratings			Three-Phase hp Ratings			AC-3 I _e (A)	AC-1 (40°C) I _e = I _{th} (A)	220/230V	380/400V	415V	660/690V			
Frame B															
20	1/4	3/4	1	1-1/2	2	3	5	7	20	2.2	3	4	3.5	1NO	XTCE007B10_
20	1/4	3/4	1	1-1/2	2	3	5	7	20	2.2	3	4	3.5	1NC	XTCE007B01_
20	1/2	1	1-1/2	3	3	5	7-1/2	9	20	2.5	4	5.5	4.5	1NO	XTCE009B10_
20	1/2	1	1-1/2	3	3	5	7-1/2	9	20	2.5	4	5.5	4.5	1NC	XTCE009B01_
20	1	2	2	3	3	10 ^③	10	12	20	3.5	5.5	7	6.5	1NO	XTCE012B10_
20	1	2	2	3	3	10 ^③	10	12	20	3.5	5.5	7	6.5	1NC	XTCE012B01_
20	1	2	3	5	5	10 ^③	10	15.5	20	4	7.5	8	7	1NO	XTCE015B10_
20	1	2	3	5	5	10 ^③	10	15.5	20	4	7.5	8	7	1NC	XTCE015B01_
Frame C															
40	2	2	3	5	5	10 ^③	15	18	35	5	7.5	10	11	1NO	XTCE018C10_
40	2	2	3	5	5	10 ^③	15	18	35	5	7.5	10	11	1NC	XTCE018C01_
40	2	3	5	7-1/2	10	15	20	25	40	7.5	11	14.5	14	1NO	XTCE025C10_
40	2	3	5	7-1/2	10	15	20	25	40	7.5	11	14.5	14	1NC	XTCE025C01_
40	3	5	5	10	10	20	25	32	40	10	15	18	17	1NO	XTCE032C10_
40	3	5	5	10	10	20	25	32	40	10	15	18	17	1NC	XTCE032C01_
Frame D															
63	3	5	7-1/2	10	15	30	40	40	50	12.5	18.5	24	23	—	XTCE040D00_
80	3	7-1/2	10	15	20	40	50	50	65	15.5	22	30	30	—	XTCE050D00_
88	5	10	15	20	25	50	60	65	80	20	30	39	35	—	XTCE065D00_
88	5	10	15	20	25	50	60	72	80	22	37	41	35	—	XTCE072D00_
Frame F															
125	7-1/2	15	15	25	30	60	75	80	90	25	37	48	63	—	XTCE080F00_
125	7-1/2	15	15	25	40	75	75	95	110	30	45	57	75	—	XTCE095F00_
Frame G															
160	10	25	25	40	50	100	100	115	130	37	55	70	90	—	XTCE115G00_
180	10	25	30	40	60	125	125	150	160	48	75	91	96	—	XTCE150G00_
225 ^④	10	25	30	40	60	125	125	170	275 ^⑤	52	90	100	96	—	XTCE170G00_

Notes

The 7–32A XTCE contactors have positively driven contacts between the integrated auxiliary contact and the auxiliary contact module as well as within the auxiliary contact modules.

The 40–65A XTCE contactors have positively driven contacts within the auxiliary contact module. Six auxiliary contacts are possible with a combination of side mounted and front mount auxiliary contacts.

DC operated contactors (Frames B–G, 7–150A) have a built-in suppressor circuit.

Frames B–C contactors with 1NC built-in auxiliary are mirror contacts (XTCE...B01_–XTCE...C01_).

① Underscore (_) indicates magnet coil suffix required. See **Page V9-T2-12**.

② For spring cage terminals, insert C after the fourth digit of the catalog number. Example: XTCE C 007B10A.

For 7–12A XTCEC contactors, the power, auxiliary and coil terminals are spring cage.

For 18–32A XTCEC contactors, the auxiliary and coil terminals are spring cage.

For 40–150A XTCEC contactors, the coil terminals only are spring cage.

③ For electrical life contactor application data, see Volume 5—Motor Control and Protection, CA08100006E, Tab 27.

④ For 180–225A, use 2 x 3/0 AWG wire.

⑤ For 225–275A, use 2 x 70 mm² wire.

Full Voltage Non-Reversing Three-Pole Contactors, Frames L–R

UL/CSA Ratings			IEC Ratings				Maximum kW Ratings AC-3 Three-Phase Motors 50–60 Hz					Auxiliary Contacts	Catalog Number ^②
UL General Purpose Amp Rating	Three-Phase hp Ratings			AC-3 I _e (A)	AC-1 (40°C) I _e = I _{th} (A)	220/230V	380/400V	415V	660/690V ^①	1000V ^①			
Frame L – Standard Coil (110/120V, 230/240 Vac Coil Only)													
225	50	60	125	150	185	337	55	90	110	175	108	2NO-2NC	XTCS185L22_
250	60	75	150	200	225	386	70	110	132	215	108	2NO-2NC	XTCS225L22_
300	75	100	200	250	250	429	75	132	148	240	108	2NO-2NC	XTCS250L22_
Frame L – Electronic Coil													
225	50	60	125	150	185	337	55	90	110	175	108	2NO-2NC	XTCE185L22_
250	60	75	150	200	225	386	70	110	132	215	108	2NO-2NC	XTCE225L22_
300	75	100	200	250	250	429	75	132	148	240	108	2NO-2NC	XTCE250L22_
Frame M – Standard Coil (110/120V, 230/240 Vac Coil Only)													
350	100	125	250	300	300	490	90	160	180	286	132	2NO-2NC	XTCS300M22_
450	125	150	300	400	400	612	125	200	240	344	132	2NO-2NC	XTCS400M22_
550	150	200	400	500	500	857	155	250	300	344	132	2NO-2NC	XTCS500M22_
550	150	200	400	500	580	980	155	315	—	344	132	2NO-2NC	XTCS570M22_
Frame M – Electronic Coil													
350	100	125	250	300	300	490	90	160	180	286	132	2NO-2NC	XTCE300M22_
450	125	150	300	400	400	612	125	200	240	344	132	2NO-2NC	XTCE400M22_
550	150	200	400	500	500	857	155	250	300	344	132	2NO-2NC	XTCE500M22_
550	150	200	400	500	580	980	155	315	350	344	132	2NO-2NC	XTCE570M22_
Frame N – Electronic Coil													
630	200	200	400	600	580	980	185	315	348	560	600	2NO-2NC	XTCE580N22_ ^③
700	200	250	500	600	650	1041	205	355	390	630	600	2NO-2NC	XTCE650N22_ ^③
800	250	300	600	700	750	1102	240	400	455	720	800	2NO-2NC	XTCE750N22_ ^③
850	290	350	700	860	820	1225	260	450	500	750	800	2NO-2NC	XTCE820N22_ ^③
1100	350	420	850	980	1000	1225	315	560	610	1000	1000	2NO-2NC	XTCEC10N22_ ^③
Frame P – Electronic Coil													
1400	—	—	—	—	—	1714	—	—	—	—	—	2NO-2NC	XTCEC14P22_ ^③
Frame R – Electronic Coil													
1600	560	640	1200	1300	1600	2200	500	900	900	1600	1700	2NO-2NC	XTCEC16R22_ ^③
2000	—	—	—	—	—	2450	—	—	—	—	—	2NO-2NC	XTCEC20R22_ ^③

Contactor Application Data

Catalog Prefix	Electrical Life (Operations) for 10 hp, 480V (14.2A) Applications
XTCE012B	1 million
XTCE015B	1.2 million
XTCE018C	2 million

Notes

AC and DC operated contactors have a built-in suppressor circuit (Frames L–R, 185–2000A).

^① For 185–500A contactors at 660/690V or 1000V: Do not reverse directly.

^② Underscore (_) indicates magnet coil suffix required. See **Page V9-T2-12**.

^③ When operating the 580–2000A XTCE contactors with frequency inverters, the suppressor on the load side must be removed. The load side suppressor must also be removed when performing a high-voltage test—see Pub51204, Pub51209.

Full Voltage Non-Reversing Three-Pole Contactors – Contact Sequence (Circuit Symbols), Standard Offering

Contactor Frame	Auxiliary Contacts	Contact Sequence
B–C	1NO	
B–C	1NC	
D–G	—	
L–R	2NO-2NC	

2.1

Motor Control and Protection

Contactors

2

Magnet Coil Suffix

Coil Voltage	Suffix Code
Frames B–F	
110V 50 Hz, 120V 60 Hz	A
220V 50 Hz, 240V 60 Hz	B
24V 50/60 Hz	T
24 Vdc	TD
415V 50 Hz, 480V 60 Hz	C
550V 50 Hz, 600V 60 Hz	D
208V 60 Hz	E
Frame G	
100–120V 50/60 Hz	A
190–240V 50/60 Hz	B
24V 50/60 Hz	T
24–27 Vdc	TD
480–500V 50/60 Hz	C











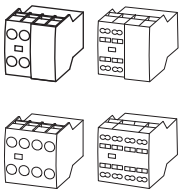

Coil Voltage	Suffix Code
Frames L–N	
110–250V 40–60 Hz/DC	A
250–500V 40–60 Hz	C
24–48 Vdc	TD
Frames L–M, S-Series	
110–120V 50/60 Hz	A
220–240V 50/60 Hz	B
Frames P–R	
220–250V 50–60 Hz/DC	B

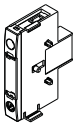
XTCR Reversing Contactor Components

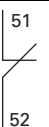
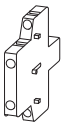
Qty.	Frame	B	C	D	F	G
2	Contactors	XTCE...B01_	XTCE...B01_	XTCE...D00_	XTCE...F00_	XTCE...G00_
2	Auxiliary contact	XTCEXFAC20	XTCEXFAC20	XTCEXFBG11	XTCEXFBG11	XTCEXFBG11
1	Mechanical interlock	XTCEXMLB	XTCEXMLC	XTCEXMLD	XTCEXMLG	XTCEXMLG
1	Reversing link kit	XTCEXRLB	XTCEXRLC	XTCEXRLD	XTCEXRLG	XTCEXRLG

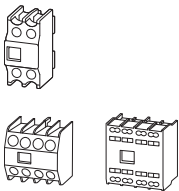
Accessories

Auxiliary Contacts—Frames B–G

		Conventional Thermal Current, Open at 60°C $I_{th} = I_{th}$, AC-1 in Amps	Poles	Contact Configuration	Circuit Symbol	Pkg. Qty.	Catalog Number—Screw Terminals
Frames B–C		Frames B–C—Front (Top) Mount ①					
	16	2	2NO		5	XTCEXFAC20	
	16	2	1NO-1NC		5	XTCEXFAC11	
	16	4	4NO		5	XTCEXFAC40	
	16	4	2NO-2NC		5	XTCEXFAC22	
Frame B		Frame B—Side Mount ①②					
	16	1	1NO		1	XTCEXSAB10	
	16	1	1NC		1	XTCEXSAB01	
Frame C		Frame C—Side Mount ①					
	10	2	1NO-1NC		1	XTCEXSAC11 ①	
Frames D–G		Frames D–G ③					
	16	2	2NO		5	XTCEXFBG20	
	16	2	1NO-1NC		5	XTCEXFBG11	
	16	4	4NO-0NC		5	XTCEXFBG40	
	16	4	2NO-2NC		5	XTCEXFBG22	

Notes

Interlocked opposing contacts, to IEC/EN 60947-5-1 Annex L (positively driven), within the auxiliary contact modules (not NO [early make] and NC [late break] contacts) and for the built-in auxiliary contacts of the XTCE007_–XTCE032_ Auxiliary break contact can be used as mirror contact to IEC/EN 60947-4-1 Annex F (not NC [late break] contact). No auxiliary contacts can be fitted between two contactors.

① Frames B–C cannot use both a side AND a top mount auxiliary contact at the same time.

② Can be mounted to the left side of contactor only.

Cannot be used in combination with front (top) mount auxiliary contacts or mechanical interlocks.

③ For Frame D, six auxiliary contacts maximum (can be a combination of side and top mount units).

Side Mount Auxiliary Contacts—Frames D–R, 40–2000A

Conventional Free Air

Thermal Current,
 $I_{th} = I_e$, AC-1 in Amps

Poles

Contact
Configuration

Circuit Symbol

Pkg. Qty.

Catalog Number—
Screw Terminals

Frame D–R ^{①②}

Frames D–R

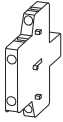

10	2	1NO-1NC		1	XTCEXSBN11
----	---	---------	--	---	-------------------

Frames L–R (Screw Mount) ^②

Frames L–R

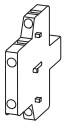

10	2	1NO-1NC		1	XTCEXSBR11
----	---	---------	--	---	-------------------

Mechanical Interlock ^③

For Use with ...

Package Qty.

Catalog Number

XTCEXMLB

XTCE007B–XTCE015B, XTCF020B

5

XTCEXMLB



XTCEXMLC

XTCE018C–XTCE032C

1

XTCEXMLC

XTCF032C–XTCF045C

XTCE040D–XTCE072D

XTCF063D–XTCF080D

1

XTCEXMLD

XTCE080F–XTCE170G

1

XTCEXMLG ^④

XTCF125G–XTCF200G



XTCEXMLM

XTCE185L–XTCE570M

1

XTCEXMLM

XTCE580N–XTCEC10N

1

XTCEXMLN ^④

XTCE500M–XTCE570M with XTCE500N–XTCEC10N

1

XTCEXMLNM ^④

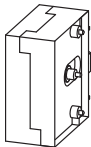

Reversing Link Kits

Reversing Link Kits

For Use with ...

Package Qty.

Catalog Number

XTCE007B–XTCE015B

1

XTCEXRLB ^⑤

XTCE018C–XTCE032C

1

XTCEXRLC

XTCE040D–XTCE065D

1

XTCEXRLD

XTCE080F–XTCE150G

1

XTCEXRLG

XTCE185L–XTCE250L

1

XTCEXRLN

XTCE300M–XTCE400M

1

XTCEXRLM400



Notes

^① For Frame D, six auxiliary contacts maximum (can be a combination of side and top mount units).

^② For Frames F–R, eight auxiliary contacts maximum (can be a combination of side and top mount units).

^③ For two contactors with AC or DC operated magnet system which are horizontally or vertically mounted. For B–G frames, mechanical lifespan is 2.5 x 10⁶ operations and the distance between contactors is 0 mm. For L–N frames, mechanical lifespan is 5 x 10⁶ operations and no auxiliary contact can be mounted between the mechanical interlock and the contactor—the distance between contactors is 15 mm.

^④ XTCEXMLG, XTCEXMLN and XTCEXMLNM consist of an interlock element and mounting plate.

^⑤ Also includes interlocking bridge (XTCEXLB). The following control cables are integrated for electrical interlock:
K1M: A1–K2M: 21; K1M: 21–K2M: A1; K1M: A2–K2M: A2.

Product Overview

Monitoring Relays Selection Guide



Description	D65 Series	D65C Series
	Page V9-T2-17	Page V9-T2-19
Approvals	cULus, CE	RoHS, cURus, cULus, CE
Features	Various combinations of protection available Compact cases for easy mounting LED indicators for quick troubleshooting	Monitors AC single-phase currents from 0.1–10 A External CT can be used to extend ranges LED indicates output relay status Choice of fixed or user-adjustable settings
Contact Data		
Configuration	SPDT or DPDT	—
Maximum allowable load	10A	Less than 5 VA
Material	—	—
Resistance	—	—
Dielectric strength	2000V	—
Coil Data		
AC	24–480 Vac	—
DC	24–120 Vdc	—
Power		
VA (Vac)	5 VA	—
Watts (Vdc)	—	—
General Data		
Ambient temperature		
Operational	–4° to 149°F (–20° to 65°C)	–20° to 131°F (–28° to 55°C)
Maximum pick-up	<= 500 milliseconds	Overcurrent: Adjustable throughout current range monitored Undercurrent: Fixed at 5% above adjustable drop-out setting
Maximum release	<= 500 milliseconds	Overcurrent: Fixed at 95% of pick-up setting for D65CE; adjustable from 50–95% of pick-up setting for D65CEK Undercurrent: Adjustable throughout current range monitored
Life		
Mechanical operations	10 million	10 million
Electrical operations	100,000	100,000

For our complete product offering, see Volume 5—Motor Control and Protection, CA08100006E.

Overload Relays Selection Guide

2



XTIEC Miniature Overload Relays



XTOB, XTOT Thermal Overload Relays



XT Electronic Overload Relays



Motor Insight Overload and Monitoring Relays

Description	Page V9-T2-22	Page V9-T2-23	Page V9-T2-26	Page V9-T2-32
Relay type	Thermal bi-metal	Thermal bi-metal	Electronic	Electronic
FLA range	0.1–12A	0.1–630A	0.1–1500A	1–540A
FLA max.:min. ratio	Approx. 1.5:1	Approx. 1.5:1	5:1	18:1 and 9:1
Trip class	10	10	Selectable 10A/10/20/30	5–30, stepped by 1's
Reset type	Selectable manual/automatic	Selectable manual/automatic	Selectable manual/automatic/remote	Selectable manual/automatic/remote
Direct connect to XT contactor	Yes, XTMC	Yes, XTCE	Yes, XTCE	—
Direct connect to DP contactor	—	—	Yes	—
Standalone mounting	—	Panel or DIN	Panel or DIN	Panel
Thermal overload protection	Yes	Yes	Yes	Yes, programmable
Jam	—	—	—	Yes, programmable
Current unbalance protection	—	—	Yes, selectable	Yes, programmable
Single-phasing	—	—	Yes, fixed level	Yes, fixed on or off
Ground fault	—	—	Yes, fixed	Yes, programmable
Phase reversal	—	—	—	Yes, programmable
Undercurrent	—	—	—	Yes, programmable
Overcurrent	—	—	—	—
Low power/high power	—	—	—	Yes, programmable
Overvoltage/undervoltage	—	—	—	Yes, programmable
Voltage unbalance	—	—	—	Yes, programmable
Current per phase and average rms	—	—	—	Yes
Current unbalance percent	—	—	Yes	Yes
Ground fault current	—	—	Yes	Yes
Voltage per phase and average rms	—	—	—	Yes
Voltage unbalance percent	—	—	—	Yes
Power/power factor	—	—	—	Yes
Thermal capacity	—	—	Yes	Yes
Frequency	—	—	Yes	Yes
Motor run hours	—	—	—	Yes
Motor starts count	—	—	—	Yes
Time to restart after fault	—	—	—	Yes
Overload status	—	—	Yes	Yes
Programmable reset timers/attempts	—	—	—	Yes
Programmable trip delays	—	—	—	Yes
Programmable auxiliary contact	—	—	—	—
Communications with I/O	—	—	Yes (Modbus®, DeviceNet™, PROFIBUS®)	Yes (Modbus, DeviceNet, PROFIBUS)
Remote display	—	—	—	Yes (NEMA 1, 12, and 3R)
Lockable user interface or tamperproof	—	—	Yes	Yes
Alarm no-trip mode	—	—	—	Yes, for GF and line faults
Diagnostics	—	—	—	Yes, 10 fault queue

For our complete product offering, see Volume 5—Motor Control and Protection, CA08100006E.

Catalog Number Selection

D65 Series Monitoring Relays

D65 Series

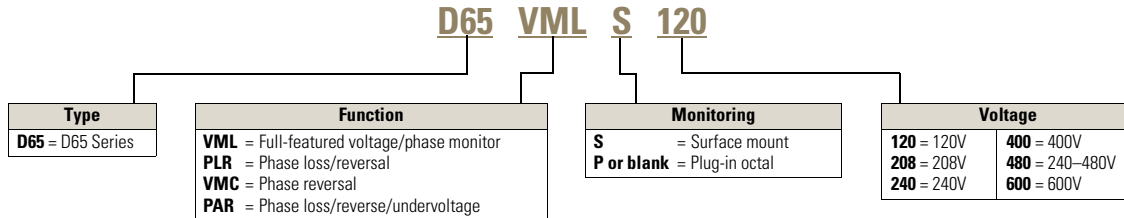

D65 Series Full-Featured Voltage/Phase Monitor

Features

- Full-featured voltage/phase monitoring relays
- Undervoltage, overvoltage, phase imbalance, phase loss (single-phasing), phase reversal
- Universal voltage range of 208–480V provides the flexibility to cover a variety of applications; 120V and 600V units also available
- Automatic or manual reset after the fault condition is corrected
- User-adjustable settings include nominal voltage, percent phase imbalance, undervoltage drop-out, time delay on undervoltage and time delay on restart after fault

Product Selection

D65VML_

D65VML Series



Style	Operating Voltage, 50/60 Hz	Catalog Number
Surface-mount (DIN rail or panel)	120V	D65VMLS120
	208–480V	D65VMLS480
	600V	D65VMLS600
Plug-in (DIN rail)	120V	D65VMLP120
	208–480V	D65VMLP480 ①
8-pin socket	—	D3PA2 ②
8-pin IP20 rated socket	—	D3PA6

D65 Series Phase Reversal Monitoring Relays

Features

- Protects against phase reversal
- One version works on 208–480V three-phase systems
- 10A SPDT output contacts

Product Selection

D65VMC_

D65VMC Series



Style	Nominal Voltage, 50/60 Hz	Catalog Number
Plug-in	120V	D65VMC120
	208–480V	D65VMC480 ①

Notes

- ① Requires a 600V rated socket when used on system voltages greater than 300V.
- ② The D3PA2 socket is rated 10A, 600V.

D65 Series Phase Loss and Reversal Monitoring Relays**Features**

2

- Protects against phase loss and phase reversal
- LED indicates both normal and fault conditions
- 10A SPDT output contacts

Product Selection**D65PLR_****D65PLR Series**

Style	Nominal Voltage, 50/60 Hz	Catalog Number
Plug-in	120V	D65PLR120
	208V	D65PLR208
	240V	D65PLR240
	400V	D65PLR400 ①
	480V	D65PLR480 ①

D65 Series Phase Loss, Reversal and Undervoltage**Features**

- Protects against phase loss, phase reversal and undervoltage
- Undervoltage setting is adjustable from 75–95% of nominal
- LED indicates both normal and fault conditions
- 10A SPDT output contacts

Product Selection**D65PAR_****D65PAR Series**

Style	Nominal Voltage, 60 Hz	Undervoltage Range	Catalog Number
Plug-in	120V	90–115V	D65PAR120
	208V	156–198V	D65PAR208
	240V	180–230V	D65PAR240
	400V	300–380V	D65PAR400 ①
	480V	360–460V	D65PAR480 ①

Note

① Requires a 600V rated socket when used on system voltages greater than 300V.

Catalog Number Selection

D65C Series Monitoring Relays

D65C Series

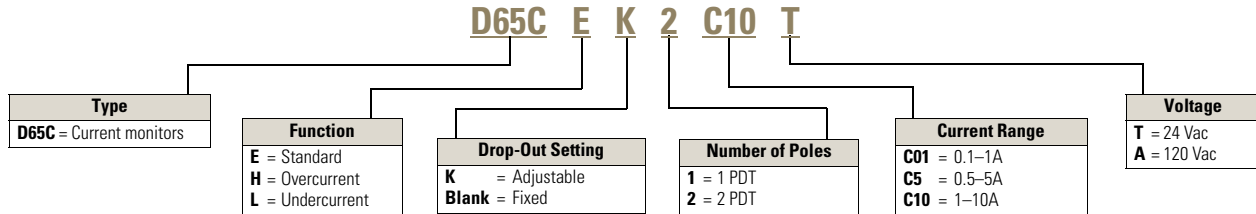

D65CE Standard Current Monitoring Relays

Features

- Monitors AC single-phase currents
- Three separate current monitoring ranges covering 0.1–10 amperes
- External CT can be used to extend ranges
- Fixed 100 ms pick-up and drop-out time delay

Product Selection

D65CE_ D65CE Series



Pick-Up Setting	Drop-Out Setting	Input Voltage	Current Range Monitored	Catalog Number
SPDT – 8-Pin Plug-In				
Adjustable	Fixed (at 95% of pick-up)	24 Vac	0.1–1A	D65CE1C01T
			0.5–5A	D65CE1C5T
			1–10A	D65CE1C10T
	120 Vac		0.1–1A	D65CE1C01A
			0.5–5A	D65CE1C5A
			1–10A	D65CE1C10A
Adjustable (50–95% of pick-up)	24 Vac		0.1–1A	D65CEK1C01T
			0.5–5A	D65CEK1C5T
			1–10A	D65CEK1C10T
	120 Vac		0.1–1A	D65CEK1C01A
			0.5–5A	D65CEK1C5A
			1–10A	D65CEK1C10A
DPDT – 11-Pin Plug-In				
Adjustable	Fixed (at 95% of pick-up)	24 Vac	0.1–1A	D65CE2C01T
			0.5–5A	D65CE2C5T
			1–10A	D65CE2C10T
	120 Vac		0.1–1A	D65CE2C01A
			0.5–5A	D65CE2C5A
			1–10A	D65CE2C10A
Adjustable (50–95% of pick-up)	24 Vac		0.1–1A	D65CEK2C01T
			0.5–5A	D65CEK2C5T
			1–10A	D65CEK2C10T
	120 Vac		0.1–1A	D65CEK2C01A
			0.5–5A	D65CEK2C5A
			1–10A	D65CEK2C10A

D65CH Series, Overcurrent Monitors

Features

- Monitors AC single-phase currents for overcurrent conditions
- Three separate current monitoring ranges covering 0.1–10 amperes
- External CT can be used to extend ranges
- Adjustable pick-up setting with either fixed or adjustable drop-out setting
- Adjustable time delay of 0.1–10 seconds on pick-up
- Fixed 100 ms time delay on drop-out
- LED indicates output

Product Selection

D65CH_

D65CH Series



Pick-Up Setting	Drop-Out Setting	Input Voltage	Current Range Monitored	Catalog Number	
SPDT—8-Pin Plug-In					
Adjustable	Fixed (at 95% of pick-up)	24 Vac	0.1–1A	D65CH1C1T	
			0.5–5A	D65CH1C5T	
			1–10A	D65CH1C10T	
	Adjustable (50–95% of pick-up)	24 Vac	120 Vac	0.1–1A	D65CH1C1A
				0.5–5A	D65CH1C5A
				1–10A	D65CH1C10A
		120 Vac	24 Vac	0.1–1A	D65CHK1C1T
				0.5–5A	D65CHK1C5T
				1–10A	D65CHK1C10T
Adjustable (50–95% of pick-up)	24 Vac	120 Vac	0.1–1A	D65CHK1C1A	
			0.5–5A	D65CHK1C5A	
			1–10A	D65CHK1C10A	
	DPDT—11-Pin Plug-In				
	Adjustable	Fixed (at 95% of pick-up)	24 Vac	0.1–1A	D65CH2C1T
				0.5–5A	D65CH2C5T
				1–10A	D65CH2C10T
			120 Vac	0.1–1A	D65CH2C1A
				0.5–5A	D65CH2C5A
1–10A				D65CH2C10A	
Adjustable (50–95% of pick-up)		24 Vac	120 Vac	0.1–1A	D65CHK2C1T
				0.5–5A	D65CHK2C5T
				1–10A	D65CHK2C10T
		120 Vac	0.1–1A	D65CHK2C1A	
			0.5–5A	D65CHK2C5A	
			1–10A	D65CHK2C10A	

D65CL Series, Undercurrent Monitoring Relays

Features

- Monitors AC single-phase currents for undercurrent conditions
- Three separate current monitoring ranges covering 0.1–10 amperes
- External CT can be used to extend ranges
- Adjustable drop-out setting with fixed pick-up setting
- Adjustable time delay of 0.1–10 seconds on drop-out
- Fixed 100 ms time delay on pick-up

Product Selection

D65CL_

D65CL Series



Pick-Up Setting	Drop-Out Setting	Input Voltage	Current Range Monitored	Catalog Number
SPDT – 8-Pin Plug-In				
Adjustable	Fixed (at 5% of drop-out)	24 Vac	0.1–1A	D65CL1C1T
			0.5–5A	D65CL1C5T
			1–10A	D65CL1C10T
		120 Vac	0.1–1A	D65CL1C1A
			0.5–5A	D65CL1C5A
			1–10A	D65CL1C10A
SPDT – 11-Pin Plug-In				
Adjustable	Fixed (at 5% of drop-out)	24 Vac	0.1–1A	D65CL2C1T
			0.5–5A	D65CL2C5T
			1–10A	D65CL210T
		120 Vac	0.1–1A	D65CL2C1A
			0.5–5A	D65CL2C5A
			1–10A	D65CL2C10A

XTIEC Miniature Overload Relays

2



Features

- Trip class 10A
- Ambient temperature compensated -5° to 50°C (23° to 122°F)
- Selectable manual/automatic reset
- 1NO-1NC auxiliary contact as standard
- Direct mount with XTMC contactors

Catalog Number Selection

XTIEC Miniature Overload Relays

Miniature Overload Relays

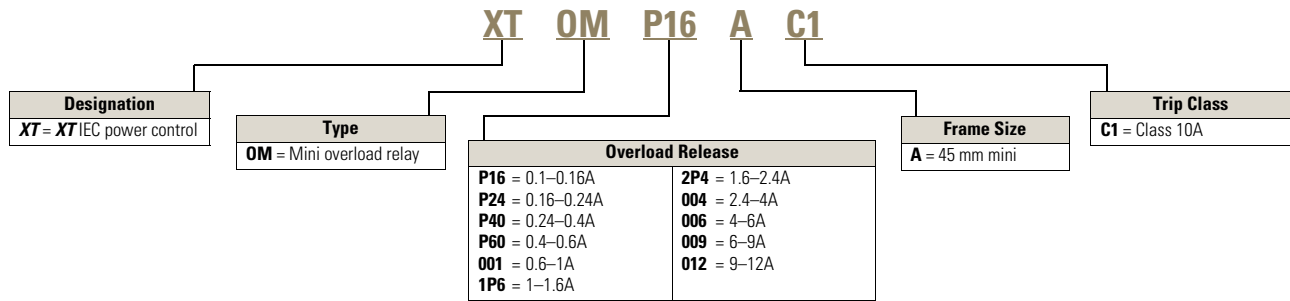

Product Selection

Miniature Overload Relays ①②

Overload Release It	Trip Class	Contact Sequence	Contact Configuration	Short Circuit Protection (A)		Circuit Breaker	CEC/NEC Fuse	Catalog Number
				Type 1 Coordination, gG/gL	Type 2 Coordination, gG/gL			
0.1–0.16A	10A	97 95	1NO-1NC	20	0.5	15	—	XTOMP16AC1
0.16–0.24A				20	1	15	—	XTOMP24AC1
0.24–0.4A		2 4 6 98 96		20	2	15	—	XTOMP40AC1
0.4–0.6A				20	2	15	—	XTOMP60AC1
0.6–1A				20	4	15	3	XTOM001AC1
1–1.6A				20	6	15	6	XTOM1P6AC1
1.6–2.4A				20	6	15	6	XTOM2P4AC1
2.4–4A				20	10	15	15	XTOM004AC1
4–6A				20	10	15	20	XTOM006AC1
6–9A				20	10	15	35	XTOM009AC1
9–12A				—	—	—	45	XTOM012AC1

Notes

- ① Short-circuit protection: Observe the maximum permissible fuse of the contactor with direct device mounting. See MN03402002E for more information.
- ② When fitted directly to the contactor, a clearance of at least 5 mm is required between the overload relays.

XTOB, XTOT Thermal Overload Relays



Features

- Direct mount to **XT** contactors or separate mount
- Class 10A
- Up to 630A

Catalog Number Selection

XTOB, XTOT Thermal Overload Relays

Thermal Overload Relays

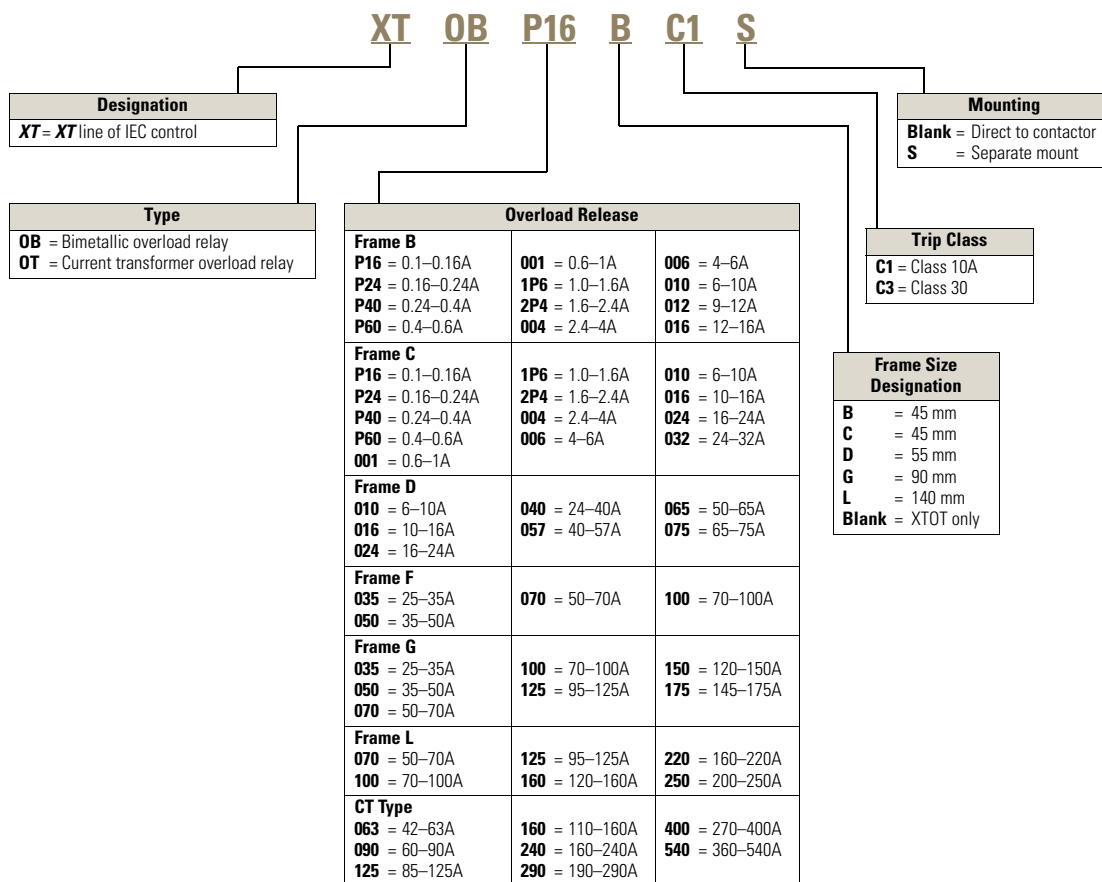

Product Selection

2

XTOB, XTOT Thermal Overload Relays

Overload Releases, I _r	Contact Sequence	Contact Configuration	For Use with Contactor Ampere Range	Short-Circuit Protection (A)		Catalog Number
				Maximum Circuit Breaker	CEC/NEC Fuse	
Frame B—Direct Mount to XTCE...B Contactor						
0.1–0.165		1NO-1NC	7–15A	25	3	XTOBP16BC1
0.16–0.24			7–15A	25	3	XTOBP24BC1
0.24–0.4			7–15A	25	3	XTOBP40BC1
0.4–0.6			7–15A	25	3	XTOBP60BC1
0.6–1			7–15A	25	3	XTOB001BC1
1–1.6			7–15A	25	6	XTOB1P6BC1
1.6–2.4			7–15A	25	6	XTOB2P4BC1
2.4–4			7–15A	25	15	XTOB004BC1
4–6			7–15A	25	20	XTOB006BC1
6–10			7–15A	25	35	XTOB010BC1
9–12			9–15A	25	45	XTOB012BC1
12–16			12–15A	30	45	XTOB016BC1
Frame C—Direct Mount to XTCE...C Contactor						
0.6–1		1NO-1NC	18–32A	25	3	XTOB001CC1
1–1.6			18–32A	25	6	XTOB1P6CC1
1.6–2.4			18–32A	25	6	XTOB2P4CC1
2.4–4			18–32A	25	15	XTOB004CC1
4–6			18–32A	25	20	XTOB006CC1
6–10			18–32A	25	25	XTOB010CC1
10–16			18–32A	30	25	XTOB016CC1
16–24			18–32A	30	25	XTOB024CC1
24–32			25–32A	30	25	XTOB032CC1
Frame D—Direct Mount to XTCE...D Contactor						
6–10		1NO-1NC	40–72A	25	25	XTOB010DC1
10–16			40–72A	25	25	XTOB016DC1
16–24			40–72A	30	25	XTOB024DC1
24–40			40–72A	125	125	XTOB040DC1
40–57			50–72A	150	150	XTOB057DC1
50–65			65–72A	150	200	XTOB065DC1
65–75			72A	150	200	XTOB075DC1
Frames F–G—Direct Mount to XTCE...F or XTCE...G Contactor						
35–50		1NO-1NC	80–170A	150	200	XTOB050GC1
50–70			80–170A	150	200	XTOB070GC1
70–100			80–170A	400	400	XTOB100GC1
95–125			80–170A	500	400	XTOB125GC1
120–150			80–170A	600	600	XTOB150GC1
145–175			150–170A	600	600	XTOB175GC1

Notes

Short circuit protection: Observe the maximum permissible fuse of the contactor with direct device mounting. See MN03402001E for more information on overload relays for Frames B–G.

Trip Class: 10A

Suitable for protection of EEx e-motors. EC prototype test certificate available upon request.

Observe manuals MN03402001E and MN03407001E. See documentation—manuals for overload monitoring of EEx e-motors.

XTOB, XTOT Thermal Overload Relays, continued

Overload Releases, I _r	Contact Sequence	Contact Configuration	For Use with Contactor Ampere Range	Short-Circuit Protection (A)		Catalog Number
				Maximum Circuit Breaker	CEC/NEC Fuse	
Frames F–G—Separate Mount						
35–50		1NO-1NC	80–170A	150	200	XTOB050GC1S
50–70			80–170A	150	200	XTOB070GC1S
70–100			80–170A	400	400	XTOB100GC1S
95–125			80–170A	500	400	XTOB125GC1S
120–150			80–170A	600	600	XTOB150GC1S
145–175			150–170A	600	600	XTOB175GC1S
Frame L—Direct Mount to XTC (E or S)...L or Separate Mount						
50–70		1NO-1NC	185–250A	150	200	XTOB070LC1
70–100			185–250A	400	400	XTOB100LC1
95–125			185–250A	500	400	XTOB125LC1
120–160			185–250A	600	600	XTOB160LC1
160–220			185–250A	800	800	XTOB220LC1
200–250			225–250A	600	700	XTOB250LC1

Current Transformer Operated Overload Relay

Overload Releases, I _r	Contact Sequence	Contact Configuration	For Use with Contactor Ampere Range	Short-Circuit Protection (A)		Catalog Number
				Maximum Circuit Breaker	CEC/NEC Fuse	
Frames M–N—Separate Mount						
160–240		1NO-1NC	300–500A	600	700	XTOT240C3S
190–290			300–500A	600	700	XTOT290C3S
270–400			300–500A	1000	1000	XTOT400C3S
360–540			500A	600	1000	XTOT540C3S
420–630			630A	600	1000	XTOT630C3S

Accessories

Adapter



DIN-Rail or Panel-Mount Adapter, Frames C–D ①

For Use With...	Package Qty.	Catalog Number
XTOB...CC1	5	XTOBXDINC
XTOB...DC1	2	XTOBXDIND

Terminal Lug Kit—Set of Three Lugs

Description	For Use With...	Package Qty.	Catalog Number
Set of three lugs #6 AWG-350MCM	XTOB...LC1	1	XTOBXTLL

Notes

Short circuit protection: Observe the maximum permissible fuse of the contactor with direct device mounting. See MN03402001E for more information on overload relays for Frames B–G.

Trip Class: 10A

Suitable for protection of EEx e-motors. EC prototype test certificate available upon request.

Observe manuals MN03402001E and MN03407001E. See documentation—manuals for overload monitoring of EEx e-motors.

① Can be snap fitted on a top hat rail (DIN rail) or can be screw fitted.

XT Electronic Overload Relays

2



Features

- Direct mount to **XT** contactors or separate mount
- Standard version: selectable trip class (10A, 10, 20, 30) with selectable manual or auto reset
- Broad 5:1 FLA range
- Self-powered design, will accept AC voltages from 12–690V 50/60 Hz
- Electrically isolated 1NO-1NC contacts (push-to-test)
- FLA range of 0.1–1500A

Catalog Number Selection

XT Electronic Overload Relays

XT Electronic Overload Relay—IEC ①

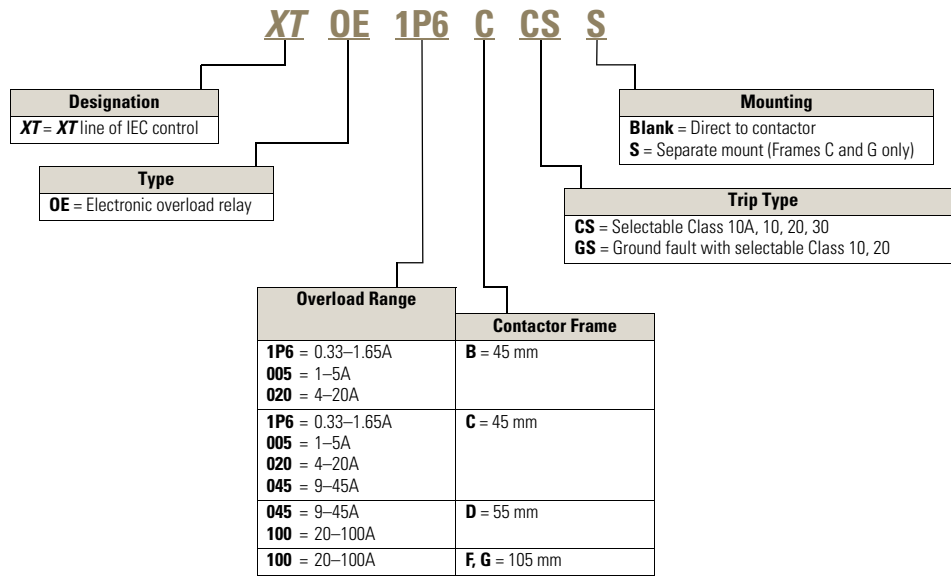

Note

① See Page V9-T2-27 for Product Selection.

Product Selection

XT Electronic Overload Relays

45 mm XT for Direct Mount



XT Electronic Overload Relays for Direct Mount to XT Contactors

For Use with XT Contactor Frame	For Use with Contactor	Overload Range (Amps)	Contact Sequence	Frame Size	Auxiliary Contact Configuration	Type	Catalog Number
B	XTCE007B_	0.33–1.65	97 95	45 mm	NO-NC	ZEB12-1.65	XTOE1P6BCS
	XTCE009B_	1–5				ZEB12-5	XTOE005BCS
	XTCE012B_	4–20				ZEB12-20	XTOE020BCS
	XTCE015B_						
C	XTCE018C_	0.33–1.65	97 95	45 mm	NO-NC	ZEB32-1.65	XTOE1P6CCS
	XTCE025C_	1–5				ZEB32-5	XTOE005CCS
	XTCE032C_	4–20				ZEB32-20	XTOE020CCS
		9–45				ZEB32-45	XTOE045CCS
D	XTCE040D_	9–45	97 95	45 mm	NO-NC	ZEB65-45	XTOE045DCS
	XTCE050D_	20–100		55 mm		ZEB65-100	XTOE100DCS
F, G	XTCE080F_	20–100	97 95	55 mm	NO-NC	ZEB150-100	XTOE100GCS
	XTCE095F_						
	XTCE115G_						
	XTCE150G_						
	XTCE170G_						

45 mm XT for Direct Mount with Ground Fault



XT Electronic Overload Relays with Ground Fault for Direct Mount to XT Contactors

For Use with XT Contactor Frame	For Use with Contactor	Overload Range (Amps)	Contact Sequence	Frame Size	Auxiliary Contact Configuration	Type	Catalog Number
B	XTCE007B_	0.33–1.65	97 95	45 mm	NO-NC	ZEB12-1.65-GF	XTOE1P6BGS
	XTCE009B_	1–5				ZEB12-5-GF	XTOE005BGS
	XTCE012B_	4–20				ZEB12-20-GF	XTOE020BGS
	XTCE015B_						
C	XTCE018C_	0.33–1.65	97 95	45 mm	NO-NC	ZEB32-1.65-GF	XTOE1P6CGS
	XTCE025C_	1–5				ZEB32-5-GF	XTOE005CGS
	XTCE032C_	4–20				ZEB32-20-GF	XTOE020CGS
		9–45				ZEB32-45-GF	XTOE045CGS
D	XTCE040D_	9–45	97 95	45 mm	NO-NC	ZEB65-45-GF	XTOE045DGS
	XTCE050D_	20–100		55 mm		ZEB65-100-GF	XTOE100DGS
F, G	XTCE080F_	20–100	97 95	55 mm	NO-NC	ZEB150-100-GF	XTOE100GGS
	XTCE095F_						
	XTCE115G_						
	XTCE150G_						
	XTCE170G_						

1-5A OL with CTs



XT Electronic Overload Relays for use with Large Frame XT Contactors (L-R)

Use CTs and 1-5A **XT** overload relay. CT kit does not include overload relay (order separately).

XT Contactor Frame	For Use with IEC Contactor Amp Range (AC-3)	CT Range (Amps)	Description	CT Kit Catalog Number	Terminal Size	Overload Relay Catalog Number	Overload Relay with Ground Fault Catalog Number
L, M	185–500A	60-300	300: 5 panel-mount CT kit with integrated lugs	ZEB-XCT300	750 kcmil (2) 250 kcmil 3/0 Cu/Al	XTOE005CCSS	XTOE005CGSS
M, N	300–820A	120-600	600: 5 panel-mount CT kit with integrated, pass through holes	ZEB-XCT600	(2) 750 kcmil 3/0 Cu/Al	XTOE005CCSS	XTOE005CGSS
N	580–1000A	200-1000	1000: 5 panel-mount CT kit with integrated, pass through holes	ZEB-XCT1000	(3) 750 kcmil 3/0 Cu/Al	XTOE005CCSS	XTOE005CGSS
R	1600A	300-1500	1500: 5 panel-mount CT kit with integrated, pass through holes	ZEB-XCT1500	(4) 750 kcmil 1/0 Cu/Al	XTOE005CCSS	XTOE005CGSS

45 mm XT for Separate Mount





XT Electronic Overload Relays for Separate Mount

Overload Range (Amps)	Frame Size	Contact Sequence	Type	Overload Relay Catalog Number	Overload Relay with Ground Fault Catalog Number
Overload Relay					
0.33–1.65	45 mm	1 3 5 97 95	ZEB32-1.65/KK	XTOE1P6CCSS	XTOE1P6CGSS
1–5					

Accessories

CT Kits

Accessories

	Description	Catalog Number
Safety Cover 	Safety Cover Clear Lexan cover that mounts on top of the FLA dial and DIP switches when closed.	ZEB-XSC
Reset Bar 	Reset Bar Assembles to the top of the overload to provide a larger target area for door mounted reset operators.	ZEB-XRB
Remote Reset 	Remote Reset Remote reset module (24 Vdc) ① Remote reset module (120 Vac) ① Remote reset module (24 Vac) ①	C440-XCOM ZEB-XRR-120 ZEB-XRR-24

Communication

The C440 is provided with two levels of communication capability.

Basic Communication via Expansion Module—Monitoring Only

Basic communication on the C440 is accomplished using an expansion module. The expansion module plugs into the expansion bay on the C440 overload relay, enabling communications with the overload via their Modbus RTU (RS-485) network. No additional parts are required. See figure below.



Basic Communication—Modbus

Advanced Communication—Monitoring and Control

C440 also has the ability to communicate on industrial protocols such as DeviceNet, PROFIBUS, Modbus RTU and Modbus TCP, and Ethernet (planned) while providing control capability using I/O.

An expansion module (mentioned earlier) combined with a communication adapter and a communication module allows easy integration onto the customer's network. See figure below.



Advanced Communication—Communication Adapter with Communication Module

Advanced Communication—Communication Module

The communication adapter comes standard with four inputs and two outputs (24 Vdc or 120 Vac) while providing the customer with flexible mounting options (DIN rail or panel).

Note

① Customer can wire remote mounted button to reset module (i.e., 22 mm pushbutton, catalog number M22-D-B-GB14-K10).

2.2

Motor Control and Protection



Motor Protection and Monitoring Relays

2

The following information can be viewed using the communication option:

- Motor status—running, stopped, tripped or resetting
- Individual rms phase currents (A, B, C)
- Average of three-phase rms current
- Percent thermal capacity
- Fault codes (only available prior to reset)
- Percent phase imbalance
- Ground fault current and percent
- Overload relay settings—trip class, DIP switch selections, reset selections
- Modbus address (can be set over the network)

Communication Accessories

	Description	Catalog Number
Expansion Module	Expansion module (Remote Reset/Modbus RTU, RS-485 Communication)	C440-XCOM
		
Communication Adapter	Communication adapter kit (DIN C Panel mounted adapter, required for advance communication option)	C440-COM-ADP
		
	DeviceNet communication module kit—120V I/O (consists of C440-XCOM + C441K + C440-COM-ADP)	C440-DN-120
	DeviceNet communication module kit—24 Vdc I/O (consists of C440-XCOM + C441L + C440-COM-ADP)	C440-DN-24
	PROFIBUS communication module kit—120V I/O (consists of C440-XCOM + C441S + C440-COM-ADP)	C440-DP-120
	PROFIBUS communication module kit—24V I/O (consists of C440-XCOM + C441Q + C440-COM-ADP)	C440-DP-24
	Modbus communication module kit—120V I/O (consists of C440-XCOM + C441N + C440-COM-ADP)	C440-MOD-120
	Modbus communication module kit—24 Vdc I/O (consists of C440-XCOM + C441P + C440-COM-ADP)	C440-MOD-24
	Ethernet IP communication module kit—120V I/O (consists of C440-XCOM + C441R + C440-COM-ADP)	C440-EIP-120

Short Circuit Ratings (North America CSA, cUL)

Changes to UL 508A and NEC in recent years have brought a focus to control panel safety with regard to short-circuit current ratings (SCCR). Eaton’s C440 electronic overload relays combined with **XT** series IEC and Freedom Series NEMA contactors provide a wide variety of SCCR solutions needed for a variety of applications. The SCCR data in this document reflects the latest information as of April 2010.

C440/XT Standalone Overload Relays (XT, C440)

Overload FLA Range	Maximum Operating Voltage	Standard-Fault Short Circuit Data			High-Fault Short Circuit Data Fuses (RK5, J, CC)			Thermal-Magnetic Circuit Breakers		
		600V (kA)	Maximum Fuse Size (A) (RK5)	Maximum Breaker Size (A)	480V (kA)	600V (kA)	Maximum Fuse Size	480V (kA)	600V (kA)	Maximum Breaker Size
0.33–1.65A	600 Vac	1	6	15	—	—	—	—	—	—
1–5A	600 Vac	5	20	20	100	100	30	100	35	20
4–20A	600 Vac	5	80	80	100	100	100	100	35	80
9–45A	600 Vac	5	175	175	100	100	100	100	35	100/175 (480/600)
20–100A	600 Vac	10	400	400	100	100	200	150	35	250/400 (480/600)

IEC XT Starters with XT Electronic Overload Relays

Contactor Frame Size	Maximum Operating Voltage	High-Fault Short Circuit Data Fuses (RK5, J, CC)			Thermal-Magnetic Circuit Breakers		
		480V	600V	Maximum Fuse Size	480V	600V	Maximum Breaker Size
B	1–5A	100	100	30	—	—	—
	4–20A	100	100	30	—	—	—
C	1–5A	100	100	60	—	—	—
	4–20A	100	100	60	—	—	—
	9–45A	100	100	60	—	—	—
D	9–45A	100	100	200	65	35	175
	20–100A	100	100	200	65	35	175
F	20–100A	100	100	200	65	65	350
G	20–100A	100	100	200	65	65	350

Motor Insight Overload and Monitoring Relays

2



Features

- Power, voltage and current monitoring, ground fault, flexible communications, motor and line protection in a single package
- Monitor energy consumption at individual loads to avoid peak demand charges
- Protect pumps from dead-head or starved conditions
- 0–660V, 1–540A with two relays
- Remote display allows for configuration without opening the panel, providing additional operator safety

Catalog Number Selection

Motor Insight Overload and Monitoring Relays

Overload and Monitoring Relays

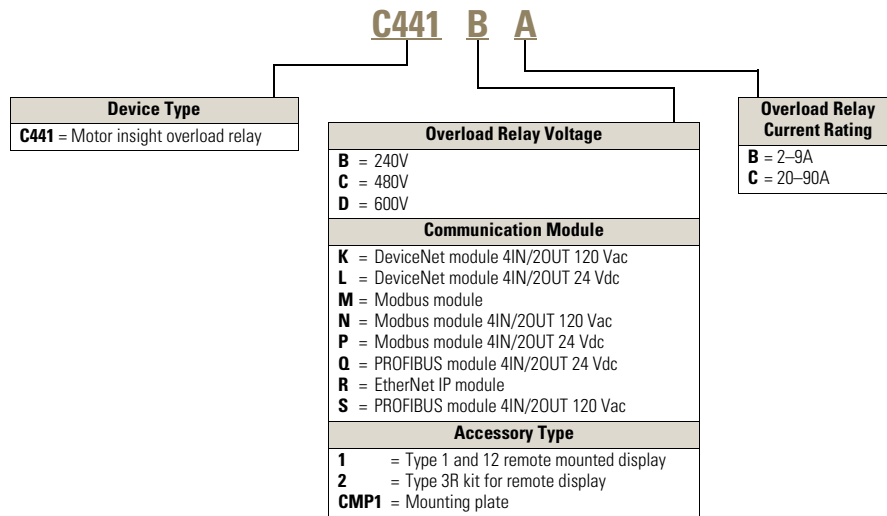

Product Selection

Motor Insight

Power Source	Monitoring Range	Current Range	Catalog Number
240 Vac (170–264)	170–264 Vac	1–9A	C441BA
		5–90A	C441BB
480 Vac (323–528)	323–528 Vac	1–9A	C441CA
		5–90A	C441CB
600 Vac (489–660)	489–660 Vac	1–9A	C441DA
		5–90A	C441DB
120 Vac (102–132)	170–660 Vac	1–9A	C4410109NOUI
		5–90A	C4410590NOUI

Motor Insight CT Multiplier and Wire Wrap Schedule

Motor FLA	Number of Loops	Number of Conductors Through CT Primary	CT Multiplier Setting	Catalog Number ^①
Current Range: 5–90A				
5–22.5	3	4	4	C441_B
6.67–30	2	3	3	
10–45	1	2	2	
20–90	0	1	1	
Current Range: 1–9A				
1–5	1	2	2	C441_A
2–9	0	1	1	
60–135	0	1	150–(150:5)	
120–270	0	1	300–(300:5)	
240–540	0	1	600–(600:5)	

Modbus Communication Module



Description	I/O	Catalog Number
Modbus communication module	None	C441M
Modbus communication module 4IN/2OUT	120 Vac	C441N
Modbus communication module 4IN/2OUT	240 Vdc	C441P

DeviceNet Modules

Description	I/O	Catalog Number
DeviceNet communication module	120 Vac	C441K
DeviceNet communication module	24 Vdc	C441L

Accessories

Motor Insight

Description	Catalog Number
Remote Display 	Remote display Type 1 C4411
Kit for Remote display 	Type 3R kit for remote display (remote display not included) C4413
Adaptive mounting plate	C441CMP1

Note

① Underscore indicates operating voltage code required.

Operating Voltage Codes

Code	Voltage
B	240 Vac
C	480 Vac
D	600 Vac

2.3

Motor Control and Protection

Manual Motor Protectors and Controllers

Product Overview

2

Manual Motor Protectors and Controllers Selection Guide



Description	XTPB Pushbutton Manual Motor Protectors	XTPR Rotary Manual Motor Protectors	XTSC Manual Motor Controllers	XTFC Combination Motor Controllers
	Page V9-T2-35	Page V9-T2-35	Page V9-T2-39	Page V9-T2-39
Operator style	Pushbutton	Rotary	Rotary	Rotary
Components	Manual motor protector	Manual motor protector	Manual motor protector contactor connector kit	Manual motor protector contactor connector kit line side adapter
UL 508 Type E	—	Yes, with line side adapter	—	—
UL 508 Type F	—	—	—	Yes
Branch motor circuit functions	Disconnect	Disconnect	Disconnect	Disconnect
	Controller (manual)	Controller (manual)	Controller (manual and remote)	Controller (manual and remote)
	Short circuit protection	Short circuit protection	Short circuit protection	Short circuit protection
	Motor overload protection	Motor overload protection	Motor overload protection	Motor overload protection
FLA range	0.1–25A	0.1–65A	0.1–65A	0.1–65A

XTIEC Manual Motor Protectors



Features

- ON/OFF rotary handle with lockout provision
- Class 10 overload protection
- Motor applications from 0.1–63A
- Built-in heater and magnetic trip elements to protect the motor
- Adjustment dial for setting motor FLA
- XTPR Rotary MMP with a lineside adapter is rated for UL 508 Type E

Catalog Number Selection

XTIEC Manual Motor Protectors

Manual Motor Protectors

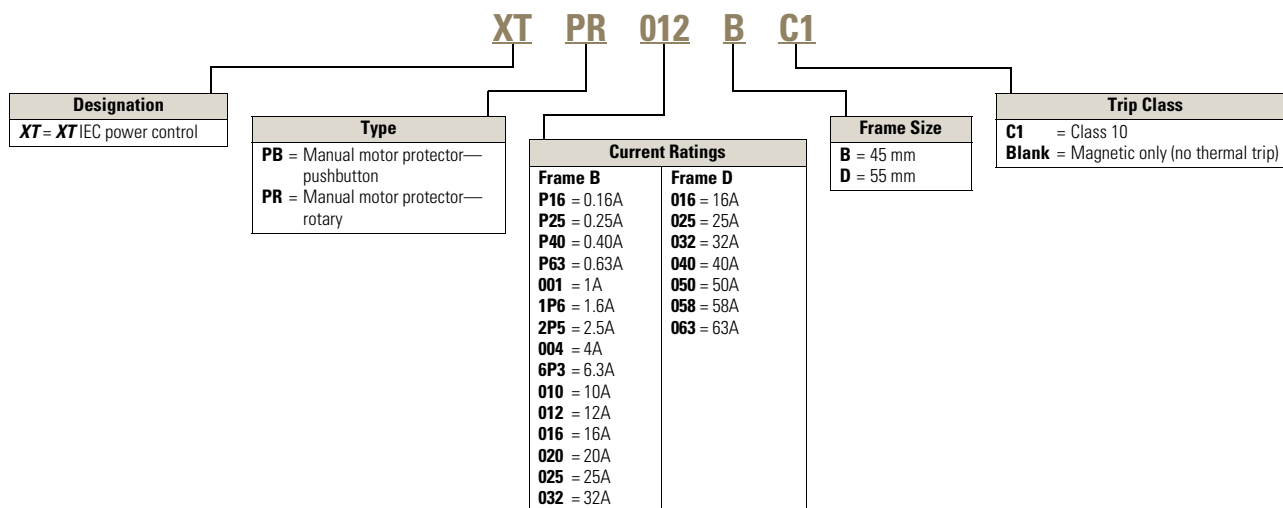

Product Selection

2

XTPB Pushbutton Manual Motor Protectors—Global and North American Ratings

Motor Protective Device with Thermal and Magnetic Trip

Note: Service Factor (SF)—Setting I_r of current scale in dependence of load factor:

SF = 1.15 → $I_r = 1 \times I_n \text{ mot}$

SF = 1 → $I_r = 0.9 \times I_n \text{ mot}$

Rated Uninterrupted Current— $I_u = I_e$ (Amps)	FLA Adjustment Range/Overload Release— I_r (A)	Short Circuit Release— I_{rm} (A)	Maximum Motor Ratings ①						Maximum hp Rating—P (hp) UL 508/CSA C 22.2 No. 14 Three-Phase				Screw Terminals— Catalog Number
			Maximum kW Rating AC-3—P (kW) Three-Phase			Maximum hp Rating—P (hp) UL 508/CSA C 22.2 No. 14 Three-Phase			200V	240V	480V	600V	
Frame B													
0.16	0.1–0.16	2.2	—	—	—	—	0.06	②	②	②	②		XTPBP16BC1
0.25	0.16–0.25	3.5	—	0.06	0.06	0.06	0.12	②	②	②	②		XTPBP25BC1
0.4	0.25–0.4	5.6	0.06	0.09	0.12	0.12	0.18	②	②	②	②		XTPBP40BC1
0.63	0.4–0.63	8.8	0.09	0.12	0.18	0.25	0.25	②	②	②	②		XTPBP63BC1
1	0.63–1	14	0.12	0.25	0.25	0.37	0.55	②	②	1/2	1/2		XTPB001BC1
1.6	1–1.6	22	0.25	0.55	0.55	0.75	1.1	②	②	3/4	1		XTPB1P6BC1
2.5	1.6–2.5	35	0.37	0.75	1.1	1.1	1.5	1/2	1/2	1	1-1/2		XTPB2P5BC1
4	2.5–4	56	0.75	1.5	1.5	2.2	3	1	1	2	3		XTPB004BC1
6.3	4–6.3	88	1.1	2.2	3	3	4	1-1/2	1-1/2	3	5		XTPB6P3BC1
10	6.3–10	140	2.2	4	4	4	7.5	3	3	7-1/2	10		XTPB010BC1
12	8–12	168	3	5.5	5.5	5.5	11	3	3	7-1/2	10		XTPB012BC1
16	10–16	224	4	7.5	9	9	12.5	3	5	10	10		XTPB016BC1
20	16–20	280	5.5	9	11	12.5	15	5	5	10	15		XTPB020BC1
25	20–25	350	5.5	12.5	12.5	15	22	5	7-1/2	15	20		XTPB025BC1

Notes

① Select manual motor protectors by full load amperes. Maximum motor ratings (kW, hp) are for reference only.

② In this range, calculate motor rating according to rated current. Specified values to NEC® 430.6(A)(1).

XTPR Rotary Manual Motor Protectors with Screw Terminals—Global Ratings and North American Ratings

Motor Protective Device with Thermal and Magnetic Trip

Note: Service Factor (SF)—Setting I_r of current scale in dependence of load factor:

$$SF = 1.15 \rightarrow I_r = 1 \times I_n \text{ mot}$$

$$SF = 1 \rightarrow I_r = 0.9 \times I_n \text{ mot}$$

Rated Uninterrupted Current— $I_u = I_e$ (Amps)	FLA Adjustment Range/Overload Release— I_r (A)	Short Circuit Release— I_{rm} (A)	Maximum Motor Ratings ①					Maximum hp Rating—P (hp) UL 508/CSA C 22.2 No. 14 Three-Phase				Screw Terminals— Catalog Number ③
			Maximum kW Rating AC-3—P (kW) Three-Phase	220–240V	380–415V	440V	500V	660–690V	200V	240V	480V	
Frame B												
0.16	0.1–0.16	2.2	—	—	—	—	0.06	②	②	②	②	XTPRP16BC1
0.25	0.16–0.25	3.5	—	0.06	0.06	0.06	0.12	②	②	②	②	XTPRP25BC1
0.4	0.25–0.4	5.6	0.06	0.09	0.12	0.12	0.18	②	②	②	②	XTPRP40BC1
0.63	0.4–0.63	8.8	0.09	0.12	0.18	0.25	0.25	②	②	②	②	XTPRP63BC1
1	0.63–1	14	0.12	0.25	0.25	0.37	0.55	②	②	1/2	1/2	XTPR001BC1
1.6	1–1.6	22	0.25	0.55	0.55	0.75	1.1	②	②	3/4	1	XTPR1P6BC1
2.5	1.6–2.5	35	0.37	0.75	1.1	1.1	1.5	1/2	1/2	1	1-1/2	XTPR2P5BC1
4	2.5–4	56	0.75	1.5	1.5	2.2	3	1	1	2	3	XTPR004BC1
6.3	4–6.3	88	1.1	2.2	3	3	4	1-1/2	1-1/2	3	5	XTPR6P3BC1
10	6.3–10	140	2.2	4	4	4	7.5	3	3	7-1/2	10	XTPR010BC1
12	8–12	168	3	5.5	5.5	5.5	11	3	3	7-1/2	10	XTPR012BC1
16	10–16	224	4	7.5	9	9	12.5	3	5	10	10	XTPR016BC1
20	16–20	280	5.5	9	11	12.5	15	5	5	10	15	XTPR020BC1
25	20–25	350	5.5	12.5	12.5	15	22	5	7-1/2	15	20	XTPR025BC1
32	25–32	448	7.5	15	15	22	30	7-1/2	10	25	30	XTPR032BC1
Frame D												
16	10–16	224	4	7.5	9	9	12.5	3	5	10	15	XTPR016DC1
25	16–25	350	5.5	12.5	12.5	15	22	7-1/2	7-1/2	20	25	XTPR025DC1
32	25–32	448	7.5	15	17.5	22	22	10	10	25	30	XTPR032DC1
40	32–40	560	11	20	22	24	30	10	15	30	40	XTPR040DC1
50	40–50	700	14	25	30	30	45	10	15	30	40	XTPR050DC1
58	50–58	812	17	30	37	37	55	—	—	40	—	XTPR058DC1
65	55–65	882	18.5	34	37	45	55	—	—	—	—	XTPR063DC1

Notes

- ① Select manual motor protectors by full load amperes. Maximum motor ratings (kW, hp) are for reference only.
- ② In this range, calculate motor rating according to rated current. Specified values to NEC 430.6(A)(1).
- ③ Catalog number shown comes with screw terminals. For Frame B devices up to 16A, spring cage terminals are available. For spring cage terminals on line and load sides, insert a "C" into the catalog number in the 5th position—Example: XTPRC _BC1. For spring cage terminals on the load side only, insert an "SC" into the catalog number in the 5th and 6th positions—Example: XTPRSC _BC1.

2.3

Motor Control and Protection

Manual Motor Protectors and Controllers

2

XTPR Manual Self-Protected Motor Starters—North American Ratings, UL 508 Type E ②

Motor Protective Device with Thermal and Magnetic Trip

Note: A UL 508 Type E self-protected manual combination starter (XTPR) consists of a manual motor protector (XTPR) and a UL listed line side adapter (e.g., XTPAXLSA). The Type E self-protected manual combination starter alone is a legitimate short-circuit protective device and disconnect means for the downstream motor, while the contactor has been added to provide remote operation of the motor circuit.

Rated Uninterrupted Current— $I_u = I_e$ (Amps)	FLA Adjustment Range/Overload Release— I_r (A)	Short Circuit Release— I_{rm} (A)	Maximum Motor Ratings ①				Rated Short Circuit Breaking Capacity (kA)			Line Side Adapter— Catalog Number ②	Manual Motor Protector Screw Terminals— Catalog Number
			Maximum hp Rating—P (hp) Three-Phase				240V	480–277V	600–247V		
			220V	240V	480–277V	600–247V	240V	480–277V	600–247V		
Frame B											
0.16	0.1–0.16	2.2	③	③	1/2	1/2	50	50	50	XTPAXLSA	XTPRP16BC1
0.25	0.16–0.25	3.4	③	③	1/2	1/2	50	50	50	XTPAXLSA	XTPRP25BC1
0.4	0.25–0.4	5.6	③	③	1/2	1/2	50	50	50	XTPAXLSA	XTPRP40BC1
0.63	0.4–0.63	8.8	③	③	1/2	1/2	50	50	50	XTPAXLSA	XTPRP63BC1
1	0.63–1	14	③	③	1/2	1/2	50	50	50	XTPAXLSA	XTPR001BC1
1.6	1–1.6	22	③	③	3/4	3/4	50	50	50	XTPAXLSA	XTPR1P6BC1
2.5	1.6–2.5	35	1/2	1/2	1	1-1/2	50	50	50	XTPAXLSA	XTPR2P5BC1
4	2.5–4	56	3/4	1	2	3	50	50	50	XTPAXLSA	XTPR004BC1
6.3	4–6.3	88	1	1-1/2	3	5	50	50	50	XTPAXLSA	XTPR6P3BC1
10	6.3–11	140	3	3	7-1/2	10	50	50	50	XTPAXLSA	XTPR010BC1
12	8–12	168	3	3	7-1/2	—	42	42	—	XTPAXLSA	—
16	10–16	224	3	5	10	—	42	42	—	XTPAXLSA	XTPR016BC1
20	16–20	280	5	5	—	—	42	42	—	XTPAXLSA	XTPR020BC1
25	20–25	350	5	7-1/2	15	—	18	18	—	XTPAXLSA	XTPR025BC1
32	25–32	448	7-1/2	10	25	—	18	18	—	XTPAXLSA	XTPR032BC1
Frame D											
16	10–16	224	3	5	10	10	50	50	50	XTPAXLSAD	XTPR016DC1
25	16–25	350	7-1/2	7-1/2	20	25	50	50	50	XTPAXLSAD	XTPR025DC1
32	25–32	448	10	10	25	30	50	50	50	XTPAXLSAD	XTPR032DC1
40	32–40	560	10	10	30	40	50	50	50	XTPAXLSAD	XTPR040DC1
50	40–50	700	10	15	30	—	65	65	—	XTPAXLSAD	XTPR050DC1
58	50–58	812	15	15	40	—	65	65	—	XTPAXLSAD	XTPR058DC1
65	55–65	882	15	15	40	—	65	65	—	XTPAXLSAD	XTPR063DC1

Notes

- ① Select manual motor protectors by full load amperes. Maximum motor ratings (kW, hp) are for reference only.
- ② UL 508 Type E starters are assembled from a standard XTPR and a special incoming terminal line side adapter (XTPAXLSA or XTPAXLSAD).
- ③ In this range, calculate motor rating according to rated current. Specified values to NEC 430.6(A)(1).

XT IEC Manual and Combination Motor Controllers



Features

- ON/OFF rotary handle with lockout provision
- Class 10 overload protection
- Adjustment dial for setting motor FLA
- Built-in surge suppression on DC coils as standard
- Assembled manual motor controllers consist of manual motor protector, contactor, connector kit and 1NO-1NC auxiliary contact for MMP
- Assembled combination motor controllers consist of manual motor protector, contactor, connector kit, 1NO-1NC auxiliary contact for MMP and line side adapter
- Combination motor controllers are UL 508 Type F rated, and provide the following functions in a single device
 - Disconnect, short circuit protection, motor overload protection, motor controller

Catalog Number Selection

XT IEC Manual and Combination Motor Controllers

Manual and Combination Motor Controllers

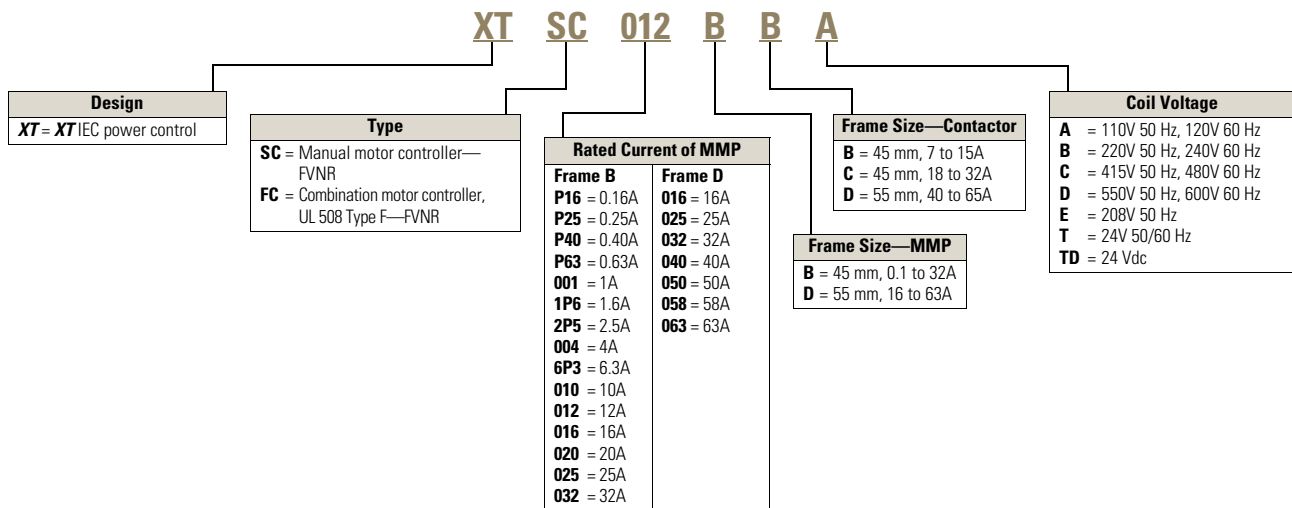

Product Selection

2 XTSC Manual Motor Controllers (MMC)/Starter Combinations

Factory Assembled Motor Protective Device with Thermal and Magnetic Trip + Contactor

Note: The assembled Manual Motor Controller (MMC) consists of an XTPR Manual Motor Protector (MMP) and an XTCE contactor. For Frame B MMP + Frame B Contactor assemblies, the XTSC can be mounted directly on DIN rail without an adapter. The contactors are supported mechanically with a mechanical connection element (included in XTPAXTPCB). For 16A and above, the assembly is mounted via a DIN rail adapter plate (XTPAXTPCPC, XTPAXTPCPD) and the electrical connection is made with electrical contact modules (XTPAXECMC, XTPAXECMD), both included in XTPAXTPCC and XTPAXTPCD.

Service Factor (SF)—Setting I_r of current scale in dependence of load factor:

SF = 1.15 → $I_r = 1 \times I_n \text{ mot}$

SF = 1 → $I_r = 0.9 \times I_n \text{ mot}$

FLA Adjustment Range (A) ①	Short Circuit Release— I_{rm} (A)	Maximum Motor Ratings—P ②								Assembled Manual Motor Controller ③ Non-Reversing—Catalog Number
		Maximum kW Rating AC-3—P (kW) Three-Phase			Maximum hp Rating—P (hp) Three-Phase					
		220–240V	380–415V	500V	660–690V	200V	240V	480V	600V	
Frame B MMP + Frame B Contactor										
0.1–0.16	3.2	—	—	—	0.06	④	④	1/2	1/2	XTSCP16BB_
0.16–0.25	3.5	—	0.06	0.06	0.12	④	④	1/2	1/2	XTSCP25BB_
0.25–0.4	5.6	0.06	0.09	0.12	0.18	④	④	1/2	1/2	XTSCP40BB_
0.4–0.63	8.82	0.09	0.18	0.25	0.25	④	④	1/2	1/2	XTSCP63BB_
0.63–1	14	0.12	0.25	0.37	0.55	④	④	1/2	1/2	XTSC001BB_
1–1.6	22.4	0.25	0.55	0.75	1.1	④	④	3/4	1	XTSC1P6BB_
1.6–2.5	35	0.37	0.75	1.1	1.5	1/2	1/2	1	1-1/2	XTSC2P5BB_
2.5–4	56	0.75	1.5	2.2	3	1	1	2	3	XTSC004BB_
4–6.3	88.2	1.1	2.2	3	4	1-1/2	1-1/2	3	5	XTSC6P3BB_
6.3–10	140	2.2	4	4	7.5	3	3	7-1/2	10	XTSC010BB_
8–12	168	3	5.5	5.5	11	3	3	7-1/2	10	XTSC012BB_
10–16	224	4	7.5	9	12.5	3	3	10	10	XTSC016BB_
Frame B MMP + Frame C Contactor										
10–16	224	4	7.5	9	12.5	3	3	10	10	XTSC016BC_
16–20	280	5.5	9	12.5	15	5	5	10	15	XTSC020BC_
20–25	350	5.5	11	15	22	5	7-1/2	15	20	XTSC025BC_
25–32	448	7.5	15	22	30	7-1/2	10	20	25	XTSC032BC_
Frame D MMP + Frame C Contactor										
10–16	224	4	7.5	9	12.5	3	5	10	15	XTSC016DC_
16–25	350	5.5	12.5	12.5	22	7-1/2	7-1/2	20	25	XTSC025DC_
25–32	448	7.5	15	17.5	22	10	10	25	30	XTSC032DC_
Frame D MMP + Frame D Contactor										
32–40	560	11	20	22	30	10	—	30	30	XTSC040DD_
40–50	700	14	25	30	45	15	15	30	40	XTSC050DD_
50–58	812	17	30	37	55	—	—	40	—	XTSC058DD_
55–65	882	18.5	34	37	55	—	—	40	—	XTSC063DD_

Notes

- ① Overload release— I_r .
- ② Select manual motor protectors by full load amperes. Maximum motor ratings (kW, hp) are for reference only.
- ③ Underscore (_) indicates magnet coil suffix required. See **Page V9-T2-41**.
- ④ In this range, calculate motor rating according to rated current. Specified values to NEC 430.6(A)(1).

XTFC Combination Motor Controllers (CMC), UL 508 Type F

Factory Assembled Motor Protective Device with Thermal and Magnetic Trip + Contactor + Required Line Side Adapter

Note: The assembled Combination Motor Controller (CMC) consists of an XTPR Manual Motor Protector (MMP) and an XTCE contactor and a required Line Side Adapter. For Frame B MMP + Frame B Contactor assemblies, the XTFC and XTFR can be mounted directly on DIN rail without an adapter. The contactors are supported mechanically with a mechanical connection element (included in XTPAXTPCB, XTPAXRPCRB). For 16A and above, the assembly is mounted via a DIN rail adapter plate (XTPAXTPCPC, XTPAXTPCPD) and the electrical connection is made with electrical contact modules (XTPAXECMC, XTPAXECMD), both included in XTPAXTPCC and XTPAXTPCD.

Service Factor (SF)—Setting I_r of current scale in dependence of load factor:

SF = 1.15 → $I_r = 1 \times I_n \text{ mot}$

SF = 1 → $I_r = 0.9 \times I_n \text{ mot}$

FLA Adjustment Range (A) ^①	Short Circuit Release— I_m (A)	Maximum Motor Ratings—P ^②								Assembled Manual Motor Controller ^③ Non-Reversing— Catalog Number
		Maximum kW Rating AC-3—P (kW) Three-Phase			Maximum hp Rating—P (hp) Three-Phase					
		220–240V	380–415V	500V	660–690V	200V	240V	480V	600V	
Frame B MMP + Frame B Contactor										
0.1–0.16	2.2	—	—	—	0.06	④	④	1/2	1/2	XTFCP16BB_
0.16–0.25	3.5	—	0.06	0.06	0.12	④	④	1/2	1/2	XTFCP25BB_
0.25–0.4	5.6	0.06	0.09	0.12	0.18	④	④	1/2	1/2	XTFCP40BB_
0.4–0.63	8.82	0.09	0.18	0.25	0.25	④	④	1/2	1/2	XTFCP63BB_
0.63–1	14	0.12	0.25	0.37	0.55	④	④	1/2	1/2	XTFC001BB_
1–1.6	22.4	0.25	0.55	0.75	1.1	④	④	3/4	1	XTFC1P6BB_
1.6–2.5	35	0.37	0.75	1.1	1.5	1/2	1/2	1	1-1/2	XTFC2P5BB_
2.5–4	56	0.75	1.5	2.2	3	1	1	2	3	XTFC004BB_
4–6.3	88.2	1.1	2.2	3	4	1-1/2	1-1/2	3	5	XTFC6P3BB_
6.3–10	140	2.2	4	4	7.5	3	3	7-1/2	10	XTFC010BB_
8–12	168	3	5.5	5.5	11	3	3	7-1/2	—	XTFC012BB_
10–16	224	4	7.5	9	12.5	3	5	10	—	XTFC016BB_
Frame B MMP + Frame C Contactor										
10–16	224	4	7.5	9	12.5	3	5	10	—	XTFC016BC_
16–20	280	5.5	9	12.5	15	5	5	—	—	XTFC020BC_
20–25	350	5.5	11	15	22	5	7-1/2	15	—	XTFC025BC_
25–32	448	7.5	15	22	30	7-1/2	10	20	—	XTFC032BC_
Frame D MMP + Frame C Contactor										
10–16	224	4	7.5	9	12.5	3	5	10	10	XTFC016DC_
16–25	350	5.5	12.5	12.5	22	7-1/2	7-1/2	20	25	XTFC025DC_
25–32	448	7.5	15	17.5	22	10	10	25	30	XTFC032DC_
Frame D MMP + Frame D Contactor										
32–40	560	11	20	22	30	10	10	30	40	XTFC040DD_
40–50	700	14	25	30	45	10	15	30	—	XTFC050DD_
50–58	812	17	30	37	55	15	15	40	—	XTFC058DD_
55–65	882	18.5	34	37	55	15	15	40	—	XTFC063DD_

Magnet Coil Suffix

Coil Voltage	Suffix Code
110V 50 Hz, 120V 60 Hz	A
220V 50 Hz, 240V 60 Hz	B
24V 50/60 Hz	T
24 Vdc	TD ^⑤
415V 50 Hz, 480V 60 Hz	C
550V 50 Hz, 600V 60 Hz	D
208V 60 Hz	E

Notes

① Overload release— I_r .

② Select combination motor controllers by full load amperes. Maximum motor ratings (kW, hp) are for reference only.

③ Underscore (_) indicates magnet coil suffix required. See table at left.

④ In this range, calculate motor rating according to rated current. Specified values to NEC 430.6(A)(1).

⑤ With DC operation: Integrated diode-resistor combination, coil rating 2.6W.

Accessories

2

Auxiliary Contacts

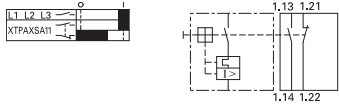
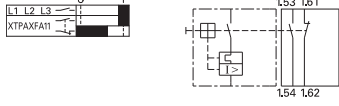
Contact Configuration	Contact Sequence	Screw Terminals Pkg. Qty.	Catalog Number
Side-Mount			
1NO-1NC		5	XTPAXSA11
Front-Mount			
1NO-1NC		5	XTPAXFA11

Rotary Handle Mechanism



IP65 Rotary Handle Mechanism ①②③

Description	Pkg. Qty.	Catalog Number
Complete Kits—Includes Handle, Shaft and Required Hardware		
Rotary handle mechanism IP65 black—for use on main switches to IEC/EN 60204.	1	XTPAXRHMB
Rotary handle mechanism IP65 red/yellow—for use on main switch with emergency-stop function to IEC/EN 60204.	1	XTPAXRHMR
Rotary handle mechanism IP65 black—for use on main switches to IEC/EN 60204 where XTPR is mounted 90° from vertical.	1	XTPAXRHM90B
Rotary handle mechanism IP65 red/yellow—for use on main switch with emergency-stop function to IEC/EN 60204 where XTPR is mounted 90° from vertical.	1	XTPAXRHM90R

Shunt Release



Shunt Release

Pkg. Qty.	Screw Terminals— Catalog Number
2	XTPAXSR120V60H
2	XTPAXSR240V60H
2	XTPAXSR480V60H
2	XTPAXSR24VDC

Undervoltage Release



Undervoltage Release

Pkg. Qty.	Screw Terminals— Catalog Number
2	XTPAXUVR120V60H
2	XTPAXUVR240V60H
2	XTPAXUVR480V60H

Notes

- ① With ON/OFF switch position and “+” (tripped), lockable with three padlocks, 4–8 mm hasp. Can be locked in the OFF position, if required.
- ② Rotary handle mechanisms ship with door interlock disabled. See instruction publication with product for how to enable door interlock.
- ③ Not for use with XTPAXFAEM20 early-make front-mount auxiliary contact.

Three-Phase Commoning Links ^①

MMP—Frame B

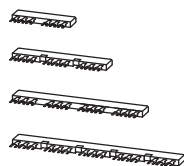

For Use With...	Qty MMP	Length of Link (mm)	Unit Width (mm)	Pkg. Qty.	Catalog Number
Frame B					
MMP with no side-mounted auxiliaries or voltage releases	2	90	45	10	XTPAXCLKA2
	3	135	45	10	XTPAXCLKA3
	4	180	45	10	XTPAXCLKA4
	5	225	45	10	XTPAXCLKA5

MMP—Frame D

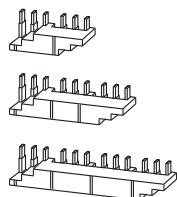

For Use With...	Qty MMP	Length of Link (mm)	Unit Width (mm)	Pkg. Qty.	Catalog Number
Frame D					
MMP with no side-mounted auxiliaries or voltage releases	2	110	55	1	XTPAXCLKA2D
	3	165	55	1	XTPAXCLKA3D
	4	220	55	1	XTPAXCLKA4D

Incoming Terminal



Incoming Terminal for Three-Phase Commoning Link ^②

For Use With...	Pkg. Qty.	Catalog Number
B Frame XTPR, XTPB	5	XTPAXIT

Line-Side Adapter



Line-Side Adapter ^③

For Use With...	Pkg. Qty.	Catalog Number
B Frame XTPR to create a UL 508 type E/F manual combination starter	5	XTPAXLSA
D Frame XTPR to create a UL 508 type E/F manual combination starter	1	XTPAXLSAD ^④

Notes

- ① Protected against accidental contact. B Frame short circuit proof Ue = 690V, Iu = 63A; D Frame short circuit proof Ue = 690V, Iu = 128A. Frame B links can be combined by rotating mounting. Frame D links cannot be combined.
- ② For three-phase commoning link, protected against accidental contact, Ue = 690V, Iu = 63A; for conductor cross-sections: 2.5–25 mm² stranded; 2.5–16 mm² flexible with ferrules, AWG 14-6.
- ③ XTPAXLSA is for three-phase commoning link, finger- and back-of-hand proof, Ue = 690V, Iu = 60A; for conductor cross sections: 2.5–25 mm² stranded, 2.5–16 mm² flexible with ferrule, AWG 14-6.
- ④ XTPAXLSAD cannot be combined with three-phase commoning links.

Non-Reversing Starters

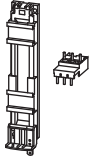
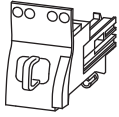

Combination Connection Kits for Connection of XTPR MMP with XTCE Contactor

For Use With...	Description	Std. Pack	Catalog Number
Non-Reversing Starters			
XTPR...B + XTCE...B	Comprised of: Mechanical connection element for XTPR...B and contactor Main current wiring between XTPR...B and contactor in tool-less plug connection Cable guidance Use contactor auxiliary switch XTCEXFAT_ Control cable guidance: max. six cables up to 2.5 mm ² external diameter or four cables up to 3.5 mm ² external diameter.	1	XTPAXTPCB
XTPR...B + XTCE...C XTPR...D + XTCE...D	Comprised of: DIN rail adapter plate Main current wiring between XTPR and contactor	1	XTPAXTPCC XTPAXTPCD

Insulated Enclosures

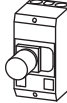
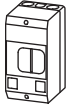

Insulated Enclosures for Surface Mounting

Degree of Protection	For Use With...	Description	Catalog Number
XTPB Pushbutton Manual Motor Protectors—North American Usage ^{①②}			
IP65 NEMA 3R, 4X, 12, 13	XTPB MMP only or with: XTPAXFA_, XTPBXFAEM20, XTPAXSA_, XTPAXUVR_, XTPAXSR_, XTPAXCL	With actuating diaphragm	XTPBXENAS65
IP65 NEMA 3R, 4X, 12, 13	XTPB MMP only or with: XTPAXFA_, XTPBXFAEM20, XTPAXUVR_, XTPAXSR_, XTPAXCL	With emergency-stop (E-stop) pushbutton actuator, red/yellow	XTPBXENASES65
B Frame (0.1–32A) XTPR Rotary Manual Motor Protectors—North American Usage ^③			
IP55 NEMA 1, 12, 3R	B Frame XTPR Only or with: XTPAXSA_ and XTPAXFA_, XTPAXUVR_ and XTPAXFA_, XTPAXSR_ and XTPAXFA_, XTPAXCL	With red/yellow rotary handle for use as emergency-stop switch to VDE 0113	XTPAXENAS55RY
D Frame (10–65A) XTPR Rotary Manual Motor Protectors ^{④⑤}			
IP65 NEMA 1, 12, 3R, 4X	D Frame XTPR only or with: XTPAXFA_, XTPAXFAEM20, XTPAXSA_, XTPAXSATR_, XTPAXUVR_, XTPAXSR_, XTPAXCL	With red/yellow rotary handle for use as emergency-stop switches to IEC/EN 60204	XTPAXENCSD65RY

Notes

- ① Built-in terminal for PE(N).
- ② North American enclosures come with conduit adapters for use with 1/2 NPT.
- ③ Built-in N and PE terminal, lower part without knockouts.
- ④ Integrated terminal for PE(N) connection.
- ⑤ % Metric knockouts:
Top ÷ bottom: M25/M32
In backplate: M25/M32
Control cable entry: M20

Product Overview

Soft Starters Selection Guide



Description	S701 Page V9-T2-46	DS6 Page V9-T2-48	S801 Page V9-T2-49	S811 Page V9-T2-55
Power				
Current range (A)	Up to 25 and up to 30 with bypass	41–200	37–1000	37–1000
Phases	Two-phase control	Two-phase control	3	3
Input voltage (line voltage)	Up to 600V	Up to 460V	0–600V; 690V on V and T Frame	0–600V; 690V on V and T Frame
Horsepower range	Up to 25 hp	230V: 10–60 hp; 460V: 30–150 hp	230V: 10–400 hp; 20–800 hp 460V: 575V:30–1000 hp	230V: 10–400 hp; 20–800 hp 460V: 575V:30–1000 hp
Internal run-bypass	Can have bypass with auxiliary contact	Yes	Yes	Yes
Inside-the-delta control	—	—	Yes	Yes
Control				
User interface	Non-digital interface	Rotary dials	DIP switches and rotary dials	LCD and keypad
Control voltage	24–300 AC/DC	24 Vdc	24 Vdc	24 Vdc
Communications	—	—	—	EtherNet/IP; Ethernet Modbus; Serial Modbus; PROFIBUS DP
Program relays	—	—	—	Yes
Soft Start				
Voltage ramp initial current	5–85% LRT	5–85% LRT	5–85% LRT	5–85% LRT
Voltage ramp time	0.5–20 sec.	1–30 sec.	0.5–180 sec.	0.5–180 sec.
Current limit	—	—	5–85% LRT	5–85% LRT
Current limit time	—	—	0.5–180 sec.	0.5–180 sec.
Kick start current	0–85% LRT	—	5–85% LRT	5–85% LRT
Kick start time	0–200 ms	—	0–2 sec.	0–2 sec.
Jog	—	—	Yes	Yes
Soft Stop				
Stop ramp time	0–20 sec.	0–30 sec.	0–60 sec.	0–60 sec.
Electronic DC injection braking	Yes	—	—	—
Preset slow speed	—	—	—	—
Pump control	—	—	Optional	Optional
Environmental				
Operating temperature	–30° to 40°C	0° to 40°C	–30° to 50°C	–30° to 50°C
Humidity	0–95% non-condensing	0–95% non-condensing	0–95% non-condensing	0–95% non-condensing
Altitude	<2000M	<2000M	<2000M	<2000M

2.4

Motor Control and Protection

Soft Starters

2

S701 Soft Start Controller



Features

- Rated operational voltage up to 600 Vac
- Control voltage range from 24–480 Vac/Vdc, 24–300 Vac/Vdc with auxiliary contact or brake
- Adjustable ramp times
- Adjustable initial torque control (0–85%)
- Kick start feature

Catalog Number Selection

S701 Soft Start Controller

Soft Start Controller

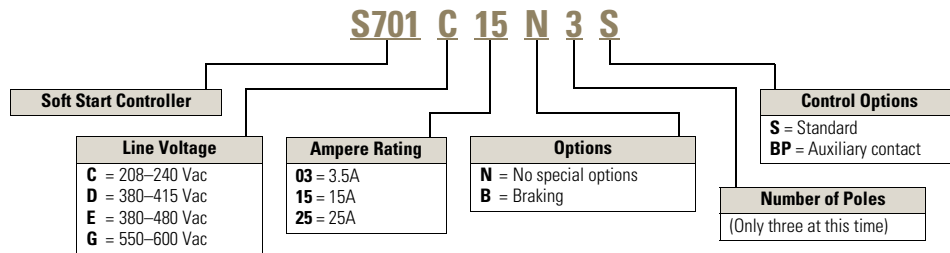

Product Selection

Soft Start Controllers

Maximum Current	Line Voltage	Control Voltage (Vac/Vdc)	Three-Phase Motor kW Rating (50 Hertz)			Horsepower Rating (60 Hertz)								Catalog Number
			230V	380–400V	440V	200V		230V		460V		575V		
						1.0 SF	1.15 SF	1.0 SF	1.15 SF	1.0 SF	1.15 SF	1.0 SF	1.15 SF	
3.5	208–240	24–240	7.5	N/A	N/A	1	1	1	1	N/A	N/A	N/A	N/A	S701C03N3S
3.5	380–415	24–300	N/A	1.1	N/A	N/A	N/A	N/A	N/A	1-1/2	1-1/2	N/A	N/A	S701D03N3S
3.5	440–480	24–300	N/A	N/A	1.5	N/A	N/A	N/A	N/A	2	2	N/A	N/A	S701E03N3S
3.5	500–600	24–300	N/A	N/A	N/A	N/A	N/A	N/A	N/A	N/A	N/A	2	2	S701G03N3S
15	208–240	24–240	4	N/A	N/A	3	3	3	3	N/A	N/A	N/A	N/A	S701C15N3S
15	380–480	24–300	N/A	5.5	7.5	N/A	N/A	N/A	N/A	10	7-1/2	N/A	N/A	S701E15N3S
15	500–600	24–300	N/A	N/A	N/A	N/A	N/A	N/A	N/A	N/A	N/A	10	10	S701G15N3S
25	208–240	24–240	7.5	N/A	N/A	5	5	7-1/2	5	N/A	N/A	N/A	N/A	S701C25N3S
25	380–480	24–300	N/A	11	12.5	N/A	N/A	N/A	N/A	15	15	N/A	N/A	S701E25N3S
25	500–600	24–300	N/A	N/A	N/A	N/A	N/A	N/A	N/A	N/A	N/A	20	20	S701G25N3S

S701—Soft Start Controller with Auxiliary Contact

Maximum Current	Line Voltage	Control Voltage (Vac/Vdc)	Three-Phase Motor kW Rating (50 Hertz)			Horsepower Rating						Catalog Number		
			230V	380–400V	440V	200V 1.0 SF	1.15 SF	230V 1.0 SF	1.15 SF	460V 1.0 SF	1.15 SF		575V 1.0 SF	1.15 SF
Ratings without Bypass														
25	208–240	24–240	5.5	N/A	N/A	5	5	7-1/2	5	N/A	N/A	N/A	N/A	S701C25N3BP
25	380–480	24–300	N/A	12.5	12.5	N/A	N/A	N/A	N/A	15	15	N/A	N/A	S701E25N3BP
25	500–600	24–300	N/A	N/A	N/A	N/A	N/A	N/A	N/A	N/A	N/A	20	20	S701G25N3BP
Ratings with Bypass														
30	208–240	24–240	7.5	N/A	N/A	7-1/2	7-1/2	10	7-1/2	N/A	N/A	N/A	N/A	S701C25N3BP
30	380–480	24–300	N/A	15	15	N/A	N/A	N/A	N/A	20	15	N/A	N/A	S701E25N3BP
30	500–600	24–300	N/A	N/A	N/A	N/A	N/A	N/A	N/A	N/A	N/A	25	20	S701G25N3BP

S701—Soft Start Controller with Brake

Maximum Current	Line Voltage	Control Voltage (Vac/Vdc)	Three-Phase Motor kW Rating (50 Hertz)			Horsepower Rating						Catalog Number		
			230V	380–400V	440V	200V 1.0 SF	1.15 SF	230V 1.0 SF	1.15 SF	460V 1.0 SF	1.15 SF		575V 1.0 SF	1.15 SF
25	208–240	24–240	5.5	N/A	N/A	5	5	7-1/2	5	N/A	N/A	N/A	N/A	S701C25B3S
25	380–480	24–300	N/A	12.5	12.5	N/A	N/A	N/A	N/A	15	15	N/A	N/A	S701E25B3S

DS6 Soft Start Controller



Features

- Run bypass mode greatly reduces internal heating created by the power dissipation across the SCRs. The bypass contactor directly connects the motor to the line and improves system efficiency by reducing internal power losses
- Less heat minimizes enclosure size and cooling requirements, and maximizes the life of all devices in the enclosure
- LED displays device status and provides fault indication
- Variable ramp times and voltage control (torque control) settings provide unlimited starting configurations, allowing for maximum application flexibility
- Minimizes the peak inrush current's stress on the power system
- Minimizes peak starting torque to diminish mechanical system wear and damage

Product Selection

DS6 Soft Start Controller

For 400% ramp, see Volume 6—Solid-State Motor Control, CA08100007E, Tab 35.

DS6 Soft Start Controller—Horsepower Rating, 10-Second Ramp, One Start per Hour, 300% Current Limit at 40°C

Rated Current (A)	Motor Power (hp)			Maximum Allowable Breaker Size a	Maximum Allowable Fuse Size ①	Recommended XT0B Overload	Recommended C396 Overload	Catalog Number
	200V	230V	460V					
40	10	10	30	HFD3150L	150A Class RK5	XT0B040DC1 ②	C396A2A045SELAX	DS6-34DSX041N0-N
52	15	20	40	HFD3200L	200A Class RK5	XT0B057DC1 ②	C396B2A075SELAX	DS6-34DSX055N0-N
65	20	25	50	HJD3250	200A Class RK5	XT0B065DC1 ②	C396B2A075SELAX	DS6-34DSX068N0-N
77	25	30	60	HKD3300	300A Class RK5	XT0B100GC1S	C396B2A110SELAX	DS6-34DSX081N0-N
96	30	30	75	HKD3350	350A Class RK5	XT0B100GC1S	C396B2A110SELAX	DS6-34DSX099N0-N
124	40	50	100	HKD3400	500A Class RK5	XT0B125GC1S	C396C2A150SELAX	DS6-34DSX134N0-N
156	50	60	125	HLD3450	500A Class RK5	XT0B160LC1 ③	C396A2A005SELAX ④	DS6-34DSX161N0-N
180	60	75	150	HLD3500	500A Class RK5	XT0B220LC1 ③	C396A2A005SELAX ④	DS6-34DSX196N0-N

Power Supply Selection

Description	Catalog Number
85–264V input and 24V output	ELC-PS01
380–480V input and 24V output	PSS25F
100–240 Vac input and 24 Vdc output	PSG60E
380–480 Vac input and 24 Vdc output	PSG60F

Notes

- ① Maximum values may be higher than allowed per NEC 430.52 and UL 508A 31.1.
- ② XT0BXDIND panel mounting adaptor must be used with this overload.
- ③ XT0BXTLL line and load lugs must be used with this overload.
- ④ C396CTK300 current transformer must be used with this overload.

S801 Soft Starter



Features

- Built-in overload protection
- Built-in run bypass contactor
- Adjustable torque control
- Physically fits in place of most NEMA and IEC starters
- Optional pump control

Catalog Number Selection

S801 Soft Starter

Soft Starter

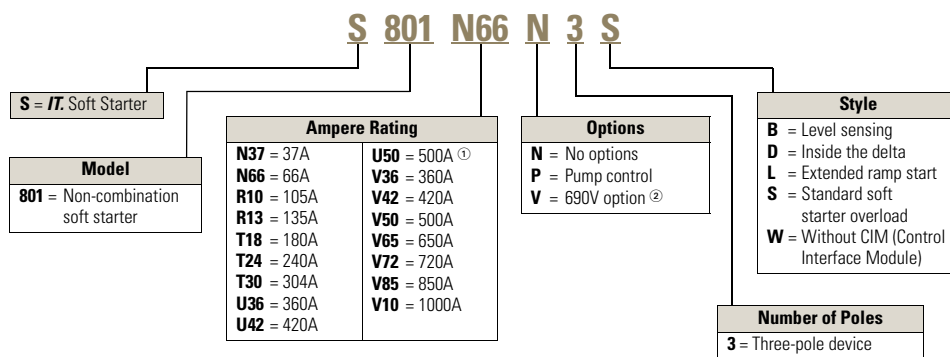

Notes

- ① U Frame 500A unit does not have IEC certification.
- ② Not available on U Frames.

Product Selection

Standard Duty Ratings

2

Note: Motor applications and customer needs come in many different varieties. With the standard and severe duty rating tables, we have attempted to provide guidelines on what the **IT** Soft Starter is capable of. If the application falls under these categories, you can use these charts.

Starting Method	Ramp Current % of FLA	Ramp Time Seconds	Starts per Hour	Ambient Temperature
vs. Soft Start	300%	30 sec.	3	50°C
vs. Full Voltage	500%	10 sec.	3	50°C
vs. Wye-Delta	350%	20 sec.	3	50°C
vs. 80% RVAT	480%	20 sec.	2	50°C
vs. 65% RVAT	390%	20 sec.	3	50°C
vs. 50% RVAT	300%	20 sec.	4	50°C

Standard Duty Rated Open Soft Starters

Maximum Current	Three-Phase Motor kW Rating (50 Hertz)			hp Rating (60 Hertz)						Catalog Number ①		
	230V	380–400V	440V	200V 1.0SF	1.15SF	230V 1.0SF	1.15SF	460V 1.0SF	1.15SF		575V 1.0SF	1.15SF
Frame Size N												
37	10	18.5	18.5	10	10	10	10	25	20	30	30	S801N37N3S
66	18.5	30	37	20	15	20	20	50	40	60	50	S801N66N3S
Frame Size R												
105	30	55	59	30	25	40	30	75	60	100	75	S801R10N3S
135	40	63	80	40	30	50	40	100	75	125	100	S801R13N3S
Frame Size T												
180	51	90	110	60	50	60	60	150	125	150	150	S801T18N3S
240	75	110	147	75	60	75	75	200	150	200	200	S801T24N3S
304	90	160	185	100	75	100	100	250	200	300	250	S801T30N3S
Frame Size U												
360	110	185	220	125	100	150	125	300	250	350	300	S801U36N3S
420	129	220	257	150	125	175	150	350	300	450	350	S801U42N3S
500	150	257	300	150	150	200	150	400	350	500	450	S801U50N3S ②③
Frame Size V												
360	110	185	220	125	100	150	125	300	250	350	300	S801V36N3S
420	129	220	257	150	125	175	150	350	300	450	350	S801V42N3S
500	150	257	300	150	150	200	150	400	350	500	450	S801V50N3S
650	200	355	425	250	200	250	200	500	450	600	500	S801V65N3S
720	220	400	450	—	—	300	250	600	500	700	600	S801V72N3S
850	257	475	500	—	—	350	300	700	600	900	700	S801V85N3S
1000	315	560	600	—	—	400	350	800	700	1000	800	S801V10N3S ④

Notes

- ① For two-wire (level sensing) control, change the last digit from S to 2.
- ② 15 sec. start, 300% inrush, 40°C, one start every 15 minutes. If these start parameters are exceeded, please refer to 290 mm V Frame, 500A starter.
- ③ U Frame 500A does not have IEC certification.
- ④ For more information on optimum performance of the 1000A Frame Size V S801, see Appendix C of MN03902008E.

Severe Duty Ratings

Note: Severe duty ratings are defined as any combination of parameters that exceed the standard duty ratings where the ramp time is over 30 seconds, the number of starts per hour exceeds four, or the current limit set is over 300%. Example: 35-second ramp, five starts per hour, 350% current limit at 40°C ambient.

Starting Method	Ramp Current % of FLA	Ramp Time Seconds	Starts per Hour	Ambient Temperature
vs. Soft Start	450%	30 sec.	4	50°C
vs. Full Voltage	500%	10 sec.	10	50°C
vs. Wye-Delta	350%	65 sec.	3	50°C
vs. 80% RVAT	480%	25 sec.	4	50°C
vs. 65% RVAT	390%	40 sec.	4	50°C
vs. 50% RVAT	300%	60 sec.	4	50°C

Severe Duty Rated Open Soft Starters

Maximum Current	Three-Phase Motor kW Rating (50 Hertz)			hp Rating (60 Hertz)		230V 1.0SF	1.15SF	460V 1.0SF	1.15SF	575V 1.0SF	1.15SF	Catalog Number ①
	230V	380-400V	440V	200V 1.0SF	1.15SF							
Frame Size N												
22	5.5	10	11	5	5	7-1/2	5	15	10	20	15	S801N37N3S
42	11	18.5	22	10	10	15	10	30	25	40	30	S801N66N3S
Frame Size R												
65	15	30	33	15	15	20	15	50	40	50	50	S801R10N3S
80	22	40	45	25	20	30	25	60	50	75	60	S801R13N3S
Frame Size T												
115	33	59	63	30	30	40	30	75	75	100	100	S801T18N3S
150	45	80	90	50	40	50	50	100	100	150	125	S801T24N3S
192	55	100	110	60	50	75	60	150	125	200	150	S801T30N3S
Frame Size U												
240	75	110	147	75	60	75	75	200	150	200	200	S801U36N3S
305	90	160	185	100	75	100	100	250	200	300	250	S801U42N3S
365	110	185	220	125	100	150	125	300	250	350	300	S801U50N3S ②
Frame Size V												
240	75	110	147	75	60	75	75	200	150	200	200	S801V36N3S
305	90	160	185	100	75	100	100	250	200	300	250	S801V42N3S
365	110	185	220	125	100	150	125	300	250	350	300	S801V50N3S
420	129	220	257	150	125	150	150	350	300	450	350	S801V65N3S
480	147	257	295	150	150	200	150	400	350	500	450	S801V72N3S
525	160	280	335	150	150	200	150	450	350	500	450	S801V85N3S
600	185	315	375	200	150	250	200	500	450	600	500	S801V10N3S ③

Notes

- ① For two-wire (level sensing) control, change the last digit from S to 2.
- ② U Frame 500A unit does not have IEC certification.
- ③ For more information on optimum performance of the 1000A Frame Size V S801, see Appendix C of MN03902008E.

2.4

Motor Control and Protection

Soft Starters

2

15-Second Ramp, Four Starts per Hour, 300% Current Limit at 40°C Ambient, Inside-the-Delta Ratings

Maximum Continuous Motor Line Current	Three-Phase Motor kW Rating (50 Hertz)			hp Rating (60 Hertz)								Catalog Number
	230V	380–400V	440V	200V 1.0SF	1.15SF	230V 1.0SF	1.15SF	460V 1.0SF	1.15SF	575V 1.0SF	1.15SF	
Frame Size N												
65	10	18.5	18.5	15	15	15	15	40	30	50	50	S801N37N3D
114	18.5	30	37	30	25	30	30	75	60	100	75	S801N66N3D
Frame Size R												
182	30	55	59	50	40	60	50	125	100	150	125	S801R10N3D
234	40	63	80	60	50	75	60	150	125	200	150	S801R13N3D
Frame Size T												
311	51	90	110	100	75	100	100	250	200	250	250	S801T18N3D
415	75	110	147	125	100	125	125	300	250	300	300	S801T24N3D
526	90	160	185	150	125	150	150	400	300	400	400	S801T30N3D
Frame Size U												
623	110	185	220	200	150	250	200	450	400	550	450	S801U36N3D
727	129	220	257	250	200	300	250	550	450	700	550	S801U42N3D
865	150	257	300	250	250	300	250	600	550	750	700	S801U50N3D ^{①②}
Frame Size V												
623	110	185	220	200	150	250	200	450	400	550	450	S801V36N3D
727	129	220	257	250	200	300	250	550	450	700	550	S801V42N3D
865	150	257	300	250	250	300	250	600	550	750	700	S801V50N3D
1125	200	355	425	400	300	400	300	750	700	900	750	S801V65N3D
1246	—	—	—	—	—	—	—	—	—	—	—	S801V72N3D
1471	—	—	—	—	—	—	—	—	—	—	—	S801V85N3D
—	—	—	—	—	—	—	—	—	—	—	—	S801V10N3D ^③

Notes

- ① 15-sec. start, 300% inrush, 40°C, one start every 15 minutes. If these start parameters are exceeded, please refer to 290 mm V Frame, 865A inside-the-delta starter.
- ② U Frame 500A unit does not have IEC certification.
- ③ For more information on optimum performance of the 1000A Frame Size V inside-the-delta S801, see Appendix C of MN03902009E.

Severe Duty Inside-the-Delta Ratings

Maximum Continuous Motor Line Current	Three-Phase Motor kW Rating (50 Hertz)			hp Rating (60 Hertz)		230V		460V		575V		Catalog Number
	230V	380-400V	440V	200V 1.0SF	1.15SF	1.0SF	1.15SF	1.0SF	1.15SF	1.0SF	1.15SF	
Frame Size N												
39	5.5	10	11	7-1/2	7-1/2	10	7-1/2	25	15	30	25	S801N37N3D
73	11	18.5	22	15	15	25	15	50	40	60	50	S801N66N3D
Frame Size R												
111	15	30	33	25	25	30	25	75	60	75	75	S801R10N3D
138	22	40	45	40	30	50	40	100	75	120	100	S801R13N3D
Frame Size T												
199	33	59	63	50	50	60	50	125	125	150	150	S801T18N3D
257	45	80	90	75	60	75	75	150	150	250	200	S801T24N3D
324	55	100	110	100	75	100	100	250	200	300	250	S801T30N3D
Frame Size U												
415	75	110	147	125	100	125	125	300	250	300	300	S801U36N3D
526	90	160	185	150	120	150	150	400	300	450	400	S801U42N3D
623	110	185	220	200	150	250	200	450	400	550	450	S801U50N3D ^①
Frame Size V												
415	75	110	147	125	100	125	125	300	250	300	300	S801V36N3D
526	90	160	185	150	120	150	150	400	300	450	400	S801V42N3D
623	110	185	220	200	150	250	200	450	400	550	450	S801V50N3D
727	129	220	257	250	200	250	250	550	450	700	550	S801V65N3D
816	147	257	295	250	250	300	250	600	550	750	700	S801V72N3D
908	160	280	335	250	250	300	250	700	550	750	700	S801V85N3D
—	—	—	—	—	—	—	—	—	—	—	—	S801V10N3D ^②

Notes

- ① U Frame 500A unit does not have IEC certification.
- ② For more information on optimum performance of the 1000A Frame Size V inside-the-delta S801, see Appendix C of MN03902009E.

Accessories

S801 Soft Starter

2

Pump Control Option

Frame Size	Maximum Current	Catalog Number	Frame Size	Maximum Current	Catalog Number	Frame Size	Maximum Current	Catalog Number
N	37	S801N37P3S	T	180	S801T18P3S	V	360	S801V36P3S
	66	S801N66P3S		240	S801T24P3S		420	S801V42P3S
R	105	S801R10P3S		304	S801T30P3S		500	S801V50P3S
	135	S801R13P3S	U	360	S801U36P3S		650	S801V65P3S
		420		S801U42P3S	720		S801V72P3S	
		500		S801U50P3S ^①	850	S801V85P3S		
					1000	S801V10P3S		

Surge Suppressor

Surge Suppressors ^②

Description	Catalog Number
600V MOV for 65 mm and 110 mm units	EMS38
600V MOV for 200 mm and 290 mm units	EMS39
690V MOV for 200 mm and 290 mm units ^③	EMS41

Lug Kit

Lug Kits ^④

Frame Size	Frame Designation	Description	Catalog Number
200 mm, SSRV	T, U	Two cable connections, 4 AWG to 1/0 cable	EML22
		One cable connection, 4/0 to 500 MCM cable	EML23
		Two cable connections, 4/0 to 500 MCM cable	EML24
		One cable connection, 2/0 to 300 MCM cable	EML25
		Two cable connections, 2/0 to 300 MCM cable	EML26
		290 mm, SSRV	V
Four cable connections, 4/0 to 500 MCM cable	EML30		
Six cable connections, 4/0 to 500 MCM cable	EML32		
Four cable connections, 2/0 to 300 MCM cable	EML33 ^⑤		

Power Supplies

Description	Catalog Number
115 Vac input; 24 Vdc output	PSS55A
230 Vac input; 24 Vdc output	PSS55B
380–480 Vac input; 24 Vdc output	PSS55C

Notes

- ① U Frame 500A unit does not have IEC certification.
- ② The surge suppressor can mount on either the line or load side of the *IT* Soft Starter. It is designed to clip the line voltage (or load side induced voltage).
- ③ T Frame only.
- ④ The 200 mm and 290 mm soft starters each have different lug options based on your wiring needs. Each lug kit contains three lugs which can be mounted on either the load or line side.
- ⑤ The EML33 does not have a CSA Listing.

S811 Communicating Soft Starter



Features

- Door or device mounted digital interface module enables users to safely configure, commission, monitor and troubleshoot the system without opening the enclosure door, eliminating the possibility of an arc flash incident
- System operating parameters can be monitored enterprise-wide through a communications network
- Run bypass mode greatly reduces internal heating created by the greater power dissipation in the SCRs
- Internal solid-state overload protection provides accurate current measurement and trip settings
- Advanced selectable protective features safeguard the motor and system against a variety of system faults
- Pump control option maximizes the life of the pump
- Smallest in industry, minimizing panel/enclosure size

Catalog Number Selection

S811 Communicating Soft Starter

Communicating Soft Starter

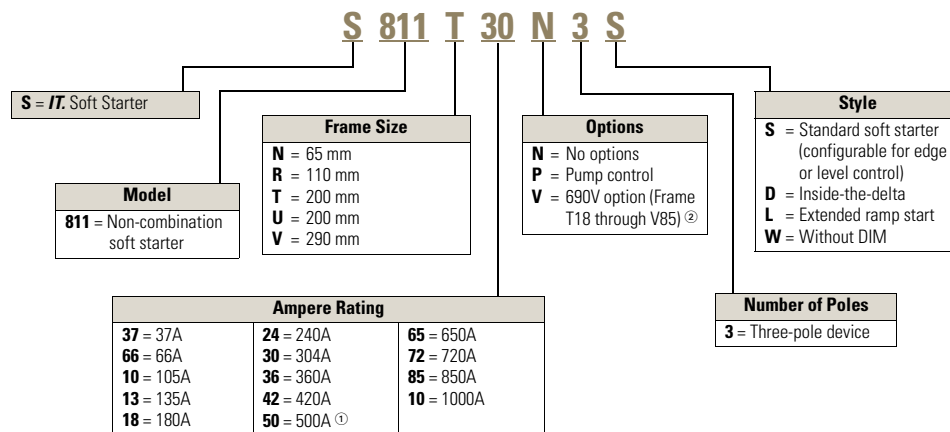

Notes

- ① U Frame 500A unit does not have IEC certification.
- ② Not available in U Frame.

Product Selection

Standard Duty Ratings

2

Note: Motor applications and customer needs come in many different varieties. With the standard and severe duty rating tables, we have attempted to provide guidelines on what the **IT** Soft Starter is capable of. If the application falls under these categories, you can use these charts.

Starting Method	Ramp Current % of FLA	Ramp Time Seconds	Starts per Hour	Ambient Temperature
vs. Soft Start	300%	30 sec.	3	50°C
vs. Full Voltage	500%	10 sec.	3	50°C
vs. Wye-Delta	350%	20 sec.	3	50°C
vs. 80% RVAT	480%	20 sec.	2	50°C
vs. 65% RVAT	390%	20 sec.	3	50°C
vs. 50% RVAT	300%	20 sec.	4	50°C

15-Second Ramp, Four Starts per Hour, 300% Current Limit at 40°C

Maximum Current	Three-Phase Motor kW Rating (50 Hertz)			hp Rating (60 Hertz)						Catalog Number		
	230V	380-400V	440V	200V 1.0SF	1.15SF	230V 1.0SF	1.15SF	460V 1.0SF	1.15SF		575V 1.0SF	1.15SF
Frame Size N												
37	10	18.5	18.5	10	10	10	10	25	20	30	30	S811N37N3S
66	18.5	30	37	20	15	20	20	50	40	60	50	S811N66N3S
Frame Size R												
105	30	55	59	30	25	40	30	75	60	100	75	S811R10N3S
135	40	63	80	40	30	50	40	100	75	125	100	S811R13N3S
Frame Size T												
180	51	90	110	60	50	60	60	150	125	150	150	S811T18N3S
240	75	110	147	75	60	75	75	200	150	200	200	S811T24N3S
304	90	160	185	100	75	100	100	250	200	300	250	S811T30N3S
Frame Size U												
360	110	185	220	125	100	150	125	300	250	350	300	S811U36N3S
420	129	220	257	150	125	175	150	350	300	450	350	S811U42N3S
500	150	257	300	150	150	200	150	400	350	500	450	S811U50N3S ^①
Frame Size V												
360	110	185	220	125	100	150	125	300	250	350	300	S811V36N3S
420	129	220	257	150	125	175	150	350	300	450	350	S811V42N3S
500	150	257	300	150	150	200	150	400	350	500	450	S811V50N3S
650	200	355	425	250	200	250	200	500	450	600	500	S811V65N3S
720	220	400	450	—	—	300	250	600	500	700	600	S811V72N3S
850	257	475	500	—	—	350	300	700	600	900	700	S811V85N3S
1000	277	525	500	—	—	400	350	800	700	900	800	S811V10N3S ^②

Notes

- ① 500A rating does not have IEC certification.
- ② For more information on optimum performance of the 1000A Frame Size V S811, see Appendix E of MN03902002E.

Severe Duty Ratings

Note: Severe duty ratings are defined as any combination of parameters that exceed the standard duty ratings where the ramp time is over 30 seconds, the number of starts per hour exceeds four, or the current limit set is over 300%. Example: 35-second ramp, five starts per hour, 350% current limit at 40°C ambient.

Starting Method	Ramp Current % of FLA	Ramp Time Seconds	Starts per Hour	Ambient Temperature
vs. Soft Start	450%	30 sec.	4	50°C
vs. Full Voltage	500%	10 sec.	10	50°C
vs. Wye-Delta	350%	65 sec.	3	50°C
vs. 80% RVAT	480%	25 sec.	4	50°C
vs. 65% RVAT	390%	40 sec.	4	50°C
vs. 50% RVAT	300%	60 sec.	4	50°C

>30-Second Ramp, >Four Starts per Hour or >300% Current Limit ^①

Maximum Current	Three-Phase Motor kW Rating (50 Hertz)			hp Rating (60 Hertz)		230V		460V		575V		Catalog Number
	230V	380-400V	440V	200V 1.0SF	1.15SF	1.0SF	1.15SF	1.0SF	1.15SF	1.0SF	1.15SF	
Frame Size N												
22	5.5	10	11	5	5	7-1/2	5	15	10	20	15	S811N37N3S
42	11	18.5	22	10	10	15	10	30	25	40	30	S811N66N3S
Frame Size R												
65	15	30	33	15	15	20	15	50	40	50	50	S811R10N3S
80	22	40	45	25	20	30	25	60	50	75	60	S811R13N3S
Frame Size T												
115	33	59	63	30	30	40	30	75	75	100	100	S811T18N3S
150	45	80	90	50	40	50	50	100	100	150	125	S811T24N3S
192	55	100	110	60	50	75	60	150	125	200	150	S811T30N3S
Frame Size U												
240	75	110	147	75	60	75	75	200	150	200	200	S811U36N3S
305	90	160	185	100	75	100	100	250	200	300	250	S811U42N3S
Frame Size V												
240	75	110	147	75	60	75	75	200	150	200	200	S811V36N3S
305	90	160	185	100	75	100	100	250	200	300	250	S811V42N3S
365	110	185	220	125	100	150	125	300	250	350	300	S811V50N3S
420	129	220	257	150	125	150	150	350	300	450	350	S811V65N3S
480	147	257	295	150	150	200	150	400	350	500	450	S811V72N3S
525	160	280	335	150	150	200	150	450	350	500	450	S811V85N3S
575	172	303	370	200	150	250	200	500	450	600	500	S811V10N3S

Note

^① For more information on optimum performance of the 1000A Frame Size V S811, see Appendix E of MN03902002E.

2.4

Motor Control and Protection

Soft Starters

2

15-Second Ramp, Four Starts per Hour, 300% Current Limit at 40°C Ambient, Inside-the-Delta Ratings

Maximum Continuous Motor Line Current	Three-Phase Motor kW Rating (50 Hertz)			hp Rating (60 Hertz)				230V		460V		575V		Catalog Number
	230V	380–400V	440V	200V 1.0SF	1.15SF	230V 1.0SF	1.15SF	1.0SF	1.15SF	1.0SF	1.15SF	1.0SF	1.15SF	
Frame Size N														
65	10	18.5	18.5	15	15	15	15	40	30	50	50	S811N37N3D		
114	18.5	30	37	30	25	30	30	75	60	100	75	S811N66N3D		
Frame Size R														
182	30	55	59	50	40	60	50	125	100	150	125	S811R10N3D		
234	40	63	80	60	50	75	60	150	125	200	150	S811R13N3D		
Frame Size T														
311	51	90	110	100	75	100	100	250	200	250	250	S811T18N3D		
415	75	110	147	125	100	125	125	300	250	300	300	S811T24N3D		
526	90	160	185	150	125	150	150	400	300	400	400	S811T30N3D		
Frame Size U														
623	110	185	220	200	150	250	200	450	400	550	450	S811U36N3D		
727	129	220	257	250	200	300	250	550	450	700	550	S811U42N3D		
865	150	257	300	250	250	300	250	600	550	750	700	S811U50N3D ^{①②}		
Frame Size V														
623	110	185	220	200	150	250	200	450	400	550	450	S811V36N3D		
727	129	220	257	250	200	300	250	550	450	700	550	S811V42N3D		
865	150	257	300	250	250	300	250	600	550	750	700	S811V50N3D		
1125	200	355	425	400	300	400	300	750	700	900	750	S811V65N3D		
1246	—	—	—	—	—	—	—	—	—	—	—	S811V72N3D		
1471	—	—	—	—	—	—	—	—	—	—	—	S811V85N3D		
—	—	—	—	—	—	—	—	—	—	—	—	S811V10N3D ^③		

Notes

- ① 15 sec. start, 300% inrush, 40°C, one start every 15 minutes. If these start parameters are exceeded, please refer to 290 mm V Frame, 865A inside-the-delta starter.
- ② U Frame 500A unit does not have IEC certification.
- ③ For more information on optimum performance of the 1000A Frame Size V S811, see Appendix E of MN03902002E.

Inside-the-Delta Severe Duty Ratings

Maximum Continuous Motor Line Current	Three-Phase Motor kW Rating (50 Hertz)			hp Rating (60 Hertz)		230V		460V		575V		Catalog Number
	230V	380-400V	440V	200V 1.0SF	1.15SF	1.0SF	1.15SF	1.0SF	1.15SF	1.0SF	1.15SF	
Frame Size N												
39	5.5	10	11	7-1/2	7-1/2	10	7-1/2	25	15	30	25	S811N37N3D
73	11	18.5	22	15	15	25	15	50	40	60	50	S811N66N3D
Frame Size R												
111	15	30	33	25	25	30	25	75	60	75	75	S811R10N3D
138	22	40	45	40	30	50	40	100	75	120	100	S811R13N3D
Frame Size T												
199	33	59	63	50	50	60	50	125	125	150	150	S811T18N3D
257	45	80	90	75	60	75	75	150	150	250	200	S811T24N3D
324	55	100	110	100	75	100	100	250	200	300	250	S811T30N3D
Frame Size U												
415	75	110	147	125	100	125	125	300	250	300	300	S811U36N3D
526	90	160	185	150	120	150	150	400	300	450	400	S811U42N3D
623	110	185	220	200	150	250	200	450	400	550	450	S811U50N3D ①
Frame Size V												
415	75	110	147	125	100	125	125	300	250	300	300	S811V36N3D
526	90	160	185	150	120	150	150	400	300	450	400	S811V42N3D
623	110	185	220	200	150	250	200	450	400	550	450	S811V50N3D
727	129	220	257	250	200	250	250	550	450	700	550	S811V65N3D
816	147	257	295	250	250	300	250	600	550	750	700	S811V72N3D
908	160	280	335	250	250	300	250	700	550	750	700	S811V85N3D
—	—	—	—	—	—	—	—	—	—	—	—	S811V10N3D ②

Notes

- ① U Frame 500A unit does not have IEC certification.
- ② For more information on optimum performance of the 1000A Frame Size V S811, see Appendix E of MN03902002E.

Accessories

S811 Communicating Soft Starter

2

Pump Control Option

Frame Size	Maximum Current	Catalog Number	Frame Size	Maximum Current	Catalog Number	Frame Size	Maximum Current	Catalog Number
N	37	S811N37P3S	T	180	S811T18P3S	V	360	S811V36P3S
	66	S811N66P3S		240	S811T24P3S		420	S811V42P3S
R	105	S811R10P3S	U	304	S811T30P3S		500	S811V50P3S
	135	S811R13P3S		360	S811U36P3S		650	S811V65P3S
				420	S811U42P3S		720	S811V72P3S
				180	S811T18P3S		850	S811V85P3S
				500	S811U50P3S ①		1000	S811V10P3S

Surge Suppressor

Surge Suppressors ②



Description	Catalog Number
600V MOV for 200 mm and 290 mm units	EMS39
690V MOV for 200 mm ③	EMS41

Lug Kit

Lug Kits ④



Frame Size	Frame Designation	Description	Catalog Number
200 mm, SSRV	T, U	Two cable connections, 4 AWG to 1/0 cable	EML22
		One cable connection, 4/0 to 500 MCM cable	EML23
		Two cable connections, 4/0 to 500 MCM cable	EML24
		One cable connection, 2/0 to 300 MCM cable	EML25
		Two cable connections, 2/0 to 300 MCM cable	EML26
		290 mm, SSRV	V
Four cable connections, 4/0 to 500 MCM cable	EML30		
Six cable connections, 4/0 to 500 MCM cable	EML32		
Four cable connections, 2/0 to 300 MCM cable	EML33 ⑤		

Power Supplies

Description	Catalog Number
115 Vac input; 24 Vdc output	PSS55A
230 Vac input; 24 Vdc output	PSS55B
380–480 Vac input; 24 Vdc output	PSS55C

Digital Interface Module ⑥

Description	Catalog Number
Blank cover (filler)	EMA68
DIM	EMA91
Panel mounting kit—	
3 ft cable	EMA69A
5 ft cable	EMA69B
8 ft cable	EMA69C
10 ft cable	EMA69D

Notes

- ① U Frame 500A unit does not have IEC certification.
- ② The surge suppressor can mount on either the line or load side of the **IT** Soft Starter. It is designed to clip the line voltage (or load side induced voltage).
- ③ T Frame only.
- ④ The 200 mm and 290 mm soft starters do not include lugs. The 200 mm and 290 mm soft starters each have different lug options based on your wiring needs. Each lug kit contains three lugs which can be mounted on either the load or line side.
- ⑤ The EML33 does not have a CSA Listing.
- ⑥ The Digital Interface Module (DIM) is available as a replacement part. 24 Vdc power supply can be used with the S811 SSRV or as a standalone device.

Product Overview

Drives Selection Guide



Description	M-Max Machinery Drives			SVX9000 Drives					
	Page V9-T2-62			Page V9-T2-64					
Frame	FS1	FS2	FS3	FR4	FR5	FR6	FR7	FR8	FR9
Dimensions (in Inches)									
Height	6.16	7.68	10.33	12.9	16.5	2.2	24.8	30.1	45.3
Width	2.58	3.54	3.94	5	5.6	7.6	9.3	11.5	18.9
Depth	4.02	4.13	4.41	7.5	8.4	9.3	10.1	13.5	13.4
I/O	Six digital inputs Two analog inputs (V and mA) One analog output One digital output Two relay outputs RS-485 interface (Modbus RTU)			Six digital inputs Two analog inputs (V and mA) Two digital outputs, form C relays One digital output, open collector One analog output Varied communication options					

M-Max Machinery Drive



Features

- Ease of use—plug and play, start-up wizard, advanced diagnostic capability, copy/paste parameters without powering drive
- Compact, space-saving design
- Availability—short lead-times, stocked at multiple locations
- Aftermarket support organization with industry-leading drive specialists for pre- and post-sale support
- Rugged and reliable—50°C rating, 150% overload for one min., 200% starting current for two secs. in every 20 sec. period, conformal coated boards, two year warranty
- RoHS compliance

Catalog Number Selection

M-Max™ Machinery Drive

Machinery Drive

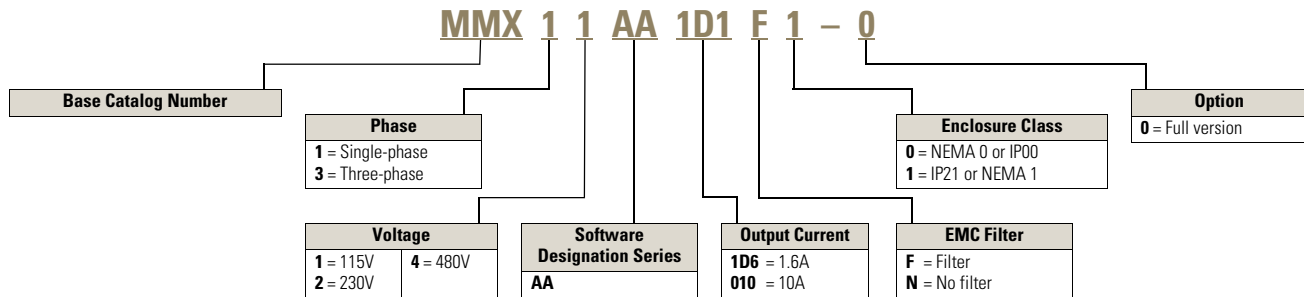

Product Selection

M-Max Machinery Drive

P (kW)	P (hp)	I _N (A)	Catalog Number
Input 115V Single-Phase		Out 230V Three-Phase	
0.25	0.33	1.7	MMX11AA1D7N0-0
0.37	0.5	2.4	MMX11AA2D4N0-0
0.55	0.75	2.8	MMX11AA2D8N0-0
0.75	1	3.7	MMX11AA3D7N0-0
1.1	1.5	4.8	MMX11AA4D8F0-0
Input 230V Single-Phase		Out 230V Three-Phase	
0.25	0.33	1.7	MMX12AA1D7F0-0
0.37	0.5	2.4	MMX12AA2D4F0-0
0.55	0.75	2.8	MMX12AA2D8F0-0
0.75	1	3.7	MMX12AA3D7F0-0
1.1	1.5	4.8	MMX12AA4D8F0-0
1.5	2	7	MMX12AA7D0F0-0
2.2	3	9.6	MMX12AA9D6F0-0
Input 230V Three-Phase		Out 230V Three-Phase	
0.25	0.33	1.7	MMX32AA1D7N0-0
0.37	0.5	2.4	MMX32AA2D4N0-0
0.55	0.75	2.8	MMX32AA2D8N0-0
0.75	1	3.7	MMX32AA3D7N0-0
1.1	1.5	4.8	MMX32AA4D8F0-0
1.5	2	7	MMX32AA7D0F0-0
2.2	3	11	MMX32AA011F0-0

P (kW)	P (hp)	I _N (A)	Catalog Number
Input 480V Three-Phase		Out 480V Three-Phase	
0.37	0.5	1.3	MMX34AA1D3F0-0
0.55	0.75	1.9	MMX34AA1D9F0-0
0.75	1	2.4	MMX34AA2D4F0-0
1.1	1.5	3.3	MMX34AA3D3F0-0
1.5	2	4.3	MMX34AA4D3F0-0
2.2	3	5.6	MMX34AA5D6F0-0
3	4	7.6	MMX34AA7D6F0-0
4	5.5	9	MMX34AA009F0-0
5.5	7.5	12	MMX34AA012F0-0
7.5	10	14	MMX34AA014F0-0
Input 575V Three-Phase		Out 575V Three-Phase	
1	1.7	2	MMX35AA1D7N0-0
2	2.7	3.6	MMX35AA2D7N0-0
3	3.9	5	MMX35AA3D9N0-0
5	6.1	7.6	MMX35AA6D1N0-0
7.5	9	10.4	MMX35AA9D0N0-0

Accessories

Kits

Description	Catalog Number
Drive to PC communication module	MMX-COM-PC
Type 1 and IP21 kit for Frame 1	MMX-IP21-FS1
Type 1 and IP21 kit for Frame 2	MMX-IP21-FS2
Type 1 and IP21 kit for Frame 3	MMX-IP21-FS3

Optional Communication Modules

Description	Catalog Number
Communication adapter kit	MMX-NET-XA
CANopen network card	XXM-NET-CO-A
PROFIBUS DP network card with serial connection	XXM-NET-PS-A
PROFIBUS DP network card with sub-D connection	XXM-NET-PD-A
DeviceNet network card	XXM-NET-DN-A

SVX9000 Drives



Features

- Integrated 3% line reactors standard on drives from FR4 through FR9
- EMI/RFI filters standard up to 200 hp I_H 480V, 100 hp I_H 230V
- Quick start wizard built into the programming of the drive ensures a smooth start-up
- LOCAL/REMOTE operation from keypad
- Copy/paste function allows transfer of parameter settings from one drive to the next
- Standard Type 12 keypad on all drives
- Hand-held auxiliary 240V power supply allows programming/monitoring of control module without applying full power to the drive

Catalog Number Selection

SVX9000 Drives

SVX9000

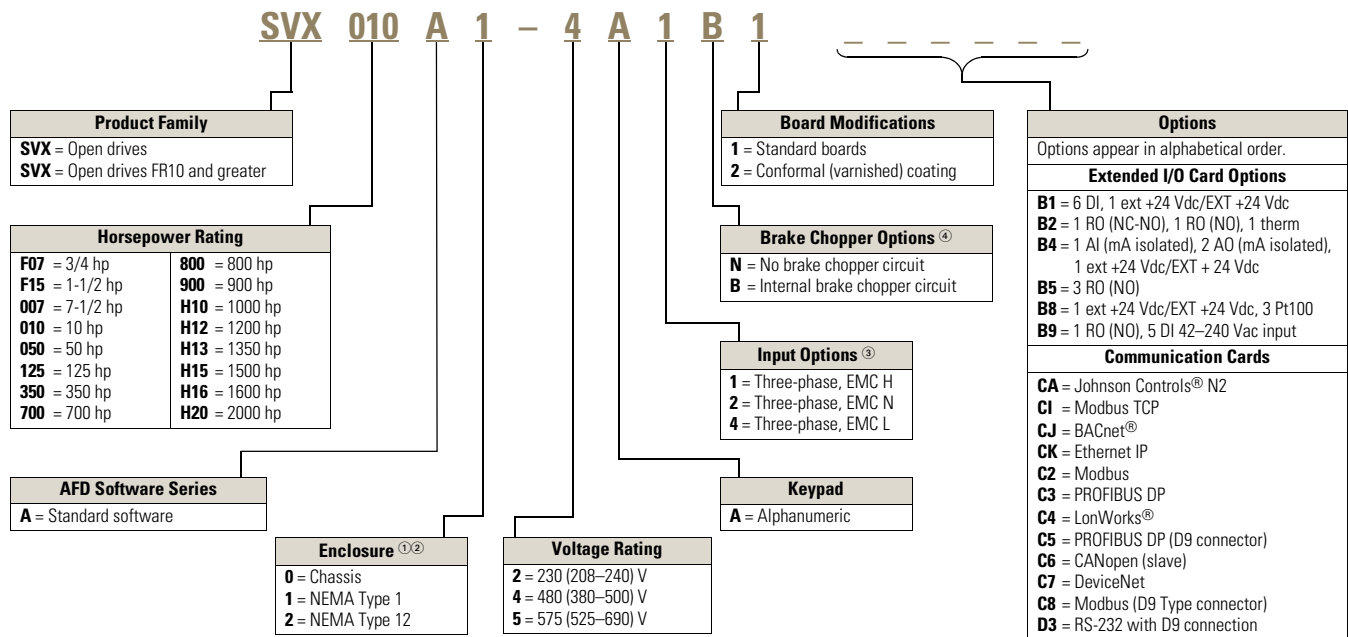

Notes

- ① 480V drives 250 hp (IH) and larger are available with enclosure style **0** (chassis); 690V drives 200 hp (IH) and larger are available with enclosure style **0** (chassis).
- ② 480V and 690V FR10 freestanding drives are available with enclosure style **1** (NEMA Type 1) and enclosure style **2** (NEMA Type 12). FR11 freestanding drives only available with enclosure style **1** (NEMA Type 1).
- ③ All 230V drives and 480V drives up to 200 hp (IH) are only available with input option **1** (EMC level H). 480V drives 250 hp (IH) or larger are available with input option **2** (EMC level N). 480V drives are available with input option **4** (EMC level L). 575V drives 200 hp (IH) or larger are only available with input option **2**. 575V drives up to 150 hp (IH) are only available with input option **4** (EMC level L).
- ④ 480V drives up to 30 hp (IH) are only available with brake chopper option **B**. 480V drives 40 hp (IH) or larger come standard with brake chopper option **N**. 230V drives up to 15 hp (IH) are only available with brake chopper option **B**. 230V drives 20 hp or larger come standard with brake chopper option **N**. All 575V drives come standard without brake chopper option (**N**). **N** = No brake chopper.

Product Selection

208–240V, Type 1 Drive

Frame Size	Delivery Code	hp (I _H)	Current (I _H)	hp (I _L)	Current (I _L)	Catalog Number
FR4	W	3/4	3.7	1	4.8	SVXF07A1-2A1B1
		1	4.8	1-1/2	6.6	SVX001A1-2A1B1
		1-1/2	6.6	2	7.8	SVXF15A1-2A1B1
		2	7.8	3	11	SVX002A1-2A1B1
		3	11	—	12.5	SVX003A1-2A1B1
FR5	W	—	12.5	5	17.5	SVX004A1-2A1B1
		5	17.5	7-1/2	25	SVX005A1-2A1B1
		7-1/2	25	10	31	SVX007A1-2A1B1
FR6	W	10	31	15	48	SVX010A1-2A1B1
		15	48	20	61	SVX015A1-2A1B1
FR7	W	20	61	25	75	SVX020A1-2A1N1
		25	75	30	88	SVX025A1-2A1N1
		30	88	40	114	SVX030A1-2A1N1
FR8	W	40	114	50	140	SVX040A1-2A1N1
		50	140	60	170	SVX050A1-2A1N1
		60	170	75	205	SVX060A1-2A1N1
FR9	W	75	205	100	261	SVX075A1-2A1N1
		100	261	—	—	SVX100A1-2A1N1

525–690V, Type 1 Drive

Frame Size	Delivery Code	hp (I _H)	Current (I _H)	hp (I _L)	Current (I _L)	Catalog Number
FR6	W	2	3.33	3	4.5	SVX002A1-5A4N1
		3	4.5	—	5.5	SVX003A1-5A4N1
		—	5.5	5	7.5	SVX004A1-5A4N1
		5	7.5	7-1/2	10	SVX005A1-5A4N1
		7-1/2	10	10	13.5	SVX007A1-5A4N1
		10	13.5	15	18	SVX010A1-5A4N1
		15	18	20	22	SVX015A1-5A4N1
		20	22	25	27	SVX020A1-5A4N1
		25	27	30	34	SVX025A1-5A4N1
		FR7	W	30	34	40
40	41			50	52	SVX040A1-5A4N1
FR8	W	50	52	60	62	SVX050A1-5A4N1
		60	62	75	80	SVX060A1-5A4N1
		75	80	100	100	SVX075A1-5A4N1
FR9	W	100	100	125	125	SVX100A1-5A4N1
		125	125	150	144	SVX125A1-5A4N1
		150	144	—	170	SVX150A1-5A4N1
		—	170	200	208	SVX175A1-5A4N1

380–500V, Type 1 Drive

Frame Size	Delivery Code	hp (I _H)	Current (I _H)	hp (I _L)	Current (I _L)	Catalog Number
FR4	W	1	2.2	1-1/2	3.3	SVX001A1-4A1B1
		1-1/2	3.3	2	4.3	SVXF15A1-4A1B1
		2	4.3	3	5.6	SVX002A1-4A1B1
		3	5.6	5	7.6	SVX003A1-4A1B1
		5	7.6	—	9	SVX005A1-4A1B1
		—	9	7-1/2	12	SVX006A1-4A1B1
FR5	W	7-1/2	12	10	16	SVX007A1-4A1B1
		10	16	15	23	SVX010A1-4A1B1
		15	23	20	31	SVX015A1-4A1B1
FR6	W	20	31	25	38	SVX020A1-4A1B1
		25	38	30	46	SVX025A1-4A1B1
		30	46	40	61	SVX030A1-4A1B1
FR7	W	40	61	50	72	SVX040A1-4A1N1
		50	72	60	87	SVX050A1-4A1N1
		60	87	75	105	SVX060A1-4A1N1
FR8	W	75	105	100	140	SVX075A1-4A1N1
		100	140	125	170	SVX100A1-4A1N1
		125	170	150	205	SVX125A1-4A1N1
FR9	W	150	205	200	261	SVX150A1-4A1N1
		200	245	250	300	SVX200A1-4A1N1

Accessories

Option Board Kits

2

Option Kit Description ^①	Allowed Slot Locations ^②	Field Installed Catalog Number	Factory Installed Option Designator	SVX Ready Programs Basic
Standard I/O Cards				
2 RO (NC/NO)	B	OPTA2	—	X
6 DI, 1 DO, 2 AI, 1AO, 1 +10 Vdc Ref, 2 Ext +24 Vdc/Ext +24 Vdc	A	OPTA9	—	X
Extended I/O Card Options				
2 RO, therm—SPX only	B	OPTA3	A3	—
Encoder low volt +5V/15V/24V—SPX only	C	OPTA4	A4	—
Encoder high volt +15V/24V—SPX only	C	OPTA5	A5	—
Double encoder—SPX only	C	OPTA7	A7	X
6 DI, 1 DO, 2 AI, 1 AO—SPX only	A	OPTA8	A8	—
3 DI (encoder 10–24V), out +15V/+24V, 2 DO (pulse+direction)—SPX only	C	OPTAE	AE	X
6 DI, 1 ext +24 Vdc/Ext +24 Vdc	B, C, D , E	OPTB1	B1	—
1 RO (NC/NO), 1 RO (NO), 1 therm	B, C, D , E	OPTB2	B2	—
1 AI (mA isolated), 2 AO (mA isolated), 1 Ext +24 Vdc/Ext +24 Vdc	B, C, D , E	OPTB4	B4	X
3 RO (NO)	B, C, D , E	OPTB5	B5	—
1 Ext +24 Vdc/Ext +24 Vdc, 3 Pt100	B, C, D , E	OPTB8	B8	—
1 RO (NO), 5 DI 42–240 Vac input	B, C, D , E	OPTB9	B9	—
Communication Cards				
Modbus	D, E	OPTC2	C2	X
Johnson Controls N2 ^③	D, E	OPTC2	CA	—
Modbus TCP	D, E	OPTCI	CI	X
BACnet	D, E	OPTCJ	CJ	X
Ethernet IP	D, E	OPTCK	CK	X
PROFIBUS DP	D, E	OPTC3	C3	X
LonWorks	D, E	OPTC4	C4	X
PROFIBUS DP (D9 connector)	D, E	OPTC5	C5	X
DeviceNet	D, E	OPTC7	C7	X
Modbus (D9 type connector)	D, E	OPTC8	C8	X
Adapter—SPX only	D, E	OPTD1	D1	X
Adapter—SPX only	D, E	OPTD2	D2	X
RS-232 with D9 connection	D, E	OPTD3	D3	X
Keypad				
9000X series local/remote keypad (replacement keypad)	—	KEYPAD-LOC/REM	—	—
9000X series remote mount keypad unit (keypad not included, includes 10 ft cable, keypad holder, mounting hardware)	—	OPTRMT-KIT-9000X	—	—
9000X Series RS-232 cable, 13 ft	—	PP00104	—	—

Notes

^① AI = Analog Input; AO = Analog Output, DI = Digital Input, DO = Digital Output, RO = Relay Output.

^② Option card must be installed in one of the slots listed for that card. Slot indicated in bold is the preferred location.

^③ OPTC2 is a multi-protocol option card.

Miscellaneous Options

Description	Catalog Number
9000XDrive A PC-based tool for controlling and monitoring of the SVX9000. Features include: loading parameters that can be saved to a file or printed, setting references, starting and stopping the motor, monitoring signals in graphical or text form, and real-time display. To avoid damage to the drive or computer, SVDriveable must be used.	9000XDRIVE
SVDriveable 6 ft (1.8m) RS-232 cable (22 gauge) with a 7-pin connector on each end. Should be used in conjunction with the 9000XDrive option to avoid damage to the SVX9000 or computer. The same cable can be used for downloading specialized applications to the drive.	SVDRIVECABLE

NEMA Type 12 Conversion Kit

Note: The NEMA Type 12 kit option is used to convert a NEMA Type 1 to a NEMA Type 12 drive. The NEMA Type 12 kit consists of a metal drive shroud, fan kit for some frames, adapter plate and plugs.

Frame Size	Delivery Code	Approximate Dimensions in Inches (mm)			Approximate Weight in lb (kg)	Catalog Number
		Length	Width	Height		
FR4	W	13 (330)	7 (178)	4 (102)	4 (1.8)	OPTN12FR4
FR5	W	16 (406)	8 (203)	7 (178)	5 (2.3)	OPTN12FR5
FR6	W	21 (533)	10 (254)	5 (127)	7 (3.2)	OPTN12FR6

2.5

Motor Control and Protection

Drives

2

X-ON Electronics

Largest Supplier of Electrical and Electronic Components

Click to view similar products for [eaton](#) manufacturer:

Other Similar products are found below :

[BK-MDL-3-R](#) [BK1-S506-500-R](#) [BK1-S506-6-3-R](#) [BK1-S506-2-R](#) [MPI4040R4-1R5-R](#) [TDC600-10A](#) [89096-015](#) [8946K153](#) [8961K155](#)
[M22-DL-W-X0](#) [M22-D-R-GB0/K11](#) [M22-L-R/R](#) [M22S-ST-GB12](#) [630NHG3B](#) [63ET](#) [6422](#) [6580](#) [CTX20-16-52LP-R](#) [CWL530FI](#)
[CXM/CO/GP/R/BB](#) [6HD36](#) [714125](#) [MBO-2](#) [ESR5-NO-41-24VAC-DC](#) [7314K36](#) [7321K2](#) [F02A-1-1/2A](#) [F02A-1-1/2AS](#) [F02A-1AS](#) [F02A-2AS](#) [F02A-3/4A](#) [F03A250V12A](#) [F03B125V4A](#) [MCR-4](#) [MDA-2-8/10-R](#) [MDA-30A](#) [MDA-V-1/16](#) [F60C500V10AS](#) [F60C500V15AS](#)
[7563K84](#) [7634K36](#) [MDQ-3/16](#) [MDQ-7/10](#) [MDQ-V-1/10](#) [MDQ-V-1-1/4](#) [MDQ-V-1/16](#) [MDQ-V-1/2](#) [MDQ-V-1/4](#) [MDQ-V-3/16](#) [MDQ-V-3/8](#)