

CANNON

# KPT / KPSE / KPTC Connectors

In Accordance with VG95328



**ITT**

ENGINEERED FOR LIFE



# ITT Corporation

ITT is a diversified leading manufacturer of highly engineered critical components and customized technology solutions for the energy, transportation and industrial markets. Building on its heritage of innovation, ITT partners with its customers to deliver enduring solutions to the key industries that underpin our modern way of life. Founded in 1920, ITT is headquartered in White Plains, N.Y., with employees in more than 35 countries and sales in a total of approximately 125 countries. The company generated 2012 revenues of \$ 2.2 billion. For more information, visit [www.itt.com](http://www.itt.com).

Our connector portfolio remains the most extensive in the industry, offering a reliable and cost effective range of interconnect solutions with the brands of Cannon, VEAM and BIW Connector Systems. Continuous investment in technology and research & development have enabled ITT to provide new, innovative products and solutions to markets including:



Transportation



Industrial / Instrumentation



Oil & Gas



Defense Vehicles



Commercial & Military Aerospace



Automotive



Computer, Telecom & Consumer Electronics

Our connector portfolio remains the most extensive in the industry, offering a reliable and cost effective range of interconnect solutions

# Introduction to KPSE/KPT/KPTC

ITT Cannon's miniature circular connector series KPT, KPSE and KPTC conform to meet the performance specification to MIL-C-26482 with a positive three point bayonet coupling, five-keyway polarization and high insert arrangement contact density.

## Purpose

- General purpose solder connectors (KPT)
  - Our solution for small/prototype quantities using solder type contacts
- High versatility general purpose versions using crimp or solder contacts (KPTC)
  - Our commercial version for higher volume production with option for solder contacts
- High performance crimp connectors (KPSE)
  - Our solution for volume production optimized for fast assembly featuring “clip-in” contact & insulator design
- Military approved versions according to VG95328 or MIL-C-26482

The broad product range provides the most complete family of connectors conforming to VG95328 and MIL-C-26482 specifications.

## Highlights

- All connectors conforming to the above mentioned standards are fully intermateable and accept a wide range of interchangeable accessories.
- Design modifications can be achieved easily and a lower cost using Cannons KPSE/KPT or KPTC versions
- VG95328 versions are based on MIL-C-26482 but comply to ECC directives and offer additional shielded versions
- KPTC is based on MIL-C-26482 but offers a greater versatility in contacts, backshells and plating options
- “Blue Generation” RoHS compliant, 500 hours salt spray and conductive plating is offered next to the standard Nickel, Zinc Cobalt or Cadmium platings.

**Contact us for detail or your request for a customized solution.**

# Product overview

|  | KPT  | KPSE   | KPTC                                   |                   |      |
|--|--|--|--|-------------------|------|
| <b>Material and Finishes</b>   |  |  |  |                   |      |
| Shell  | Aluminum alloy<br>Various RoHS compliant plating options are available like Zinc cobalt, Zinc Nickel and Nickel plus none compliant Cadmium  | Aluminum alloy                                       | Aluminum alloy                         |                   |      |
| Insulator  | Polychloroprene  | Polychloroprene                                      | Polychloroprene                        |                   |      |
| Grommet and seal   | Polychloroprene  | Polychloroprene                                      | Polychloroprene                        |                   |      |
| Contacts   | Copper alloy, gold and tin plated  | Copper alloy, gold and tin plated                    | Copper alloy, hard gold and tin plated |                   |      |
| <b>Mechanical Data</b>   |  |  |  |                   |      |
| Shell styles   | 00 – Wall mounting receptacle  | 07 – Jam nut receptacle                              |  |                   |      |
|  | 01 – Cable connecting plug   | 08 – Plug with 90° termination assemblies            |  |                   |      |
|  | 02 – Box mounting receptacle   | B – Thru-bulkhead receptacle (KPT only)              |  |                   |      |
|  | 06 – Straight plug   |  |  |                   |      |
| Shell size   |  | 8 through 24   |  |                   |      |
| Polarization/Coupling  |  | Five keyways/3-point bayonet                         |  |                   |      |
| Service classes  |  | A – General duty                                     |  |                   |      |
|  |  | E – Grommet seal                                     |  |                   |      |
|  |  | F – Grommet seal with strain relief                  |  |                   |      |
|  |  | PG – PG gland adapters<br>ME – metric gland adapters |  |                   |      |
| Environmental sealing  | According to VG95319 Part 2, Test No. 5.9.2   For styles A to E and Z1, Z2 and Z3 and gaskets style A only, test pressure 0,2 bar overpressure, test duration 48 h, test temperature 25 ± 3°C, connector shall be free of moisture |  |  |                   |      |
| Operating temperature  | -55/ + 125°C   |  |  |                   |      |
| Durability   | 500 mating cycles  |  |  |                   |      |
| Vibration  | 200 m/s <sup>2</sup> at 10 to 2000 Hz  |  |  |                   |      |
| <b>Electrical Data</b>   |  |  |  |                   |      |
| Number of contacts   | 2 through 61   | 3 through 61   | 2 through 61                           |                   |      |
| Wire size AWG  | 16 through 24  | 12 through 24  | 0,4 – 2,0 mm <sup>2</sup>              |                   |      |
| Contact termination  | Solder   | Crimp  | Crimp, solder                          |                   |      |
| <b>KPT/KPSE/KPTC</b>   |  |  |  |                   |      |
| <b>Contact rating</b>  | Size   | Rated current A                                      | Test current A                         | Millivolt drop mV |      |
|  | 20   | 7,5  | 7,5                                    | Less than 55      |      |
|  | 16   | 13,0   | 13,0                                   | Less than 50      |      |
| <b>Insulation resistance</b>   | ~ 5000 MΩ  |  |  |                   |      |
| <b>Exceptions</b><br>Service rating between the central contact and the housing of the coaxial contact           | Test voltage   | Service class  |  | Vrms              | VDC  |
|  | Seal Level   | 1  |  | 1500              | 2100 |
|  |  | 2  |  | 2300              | 3200 |
|  | 21336 m/70 000 ft.   | 1  |  | 375               | 535  |
|  |  | 2  |  | 550               | 770  |
| Operating voltage (with scoop proof connectors operating voltages acc. to MIL-C-26482 and VG95328 are permitted) |  |  |  |                   |      |
| <b>Operating voltage</b>   | Service class  | VG95328  | MIL-C-26482                            |                   |      |
|  | 1  | 140 VDC/100 VAC                                      | 850 VDC/600 VAC                        |                   |      |
|  | 2  | 165 VDC/115 VAC                                      | 1400 VDC/1000 VAC                      |                   |      |

**Operating voltage**

When the connectors in this catalogue are used for voltages greater than 50 Volts and have touchable conductive shell parts they must be used in accordance with the safety regulations DIN VDE Part 140; IEC 60364-4-41. This regulation basically dictates that the power source should be turned off before any mating and unmating of the connector. This regulation does not provide protection against electrical shock when mating and unmating the connectors in the live condition.

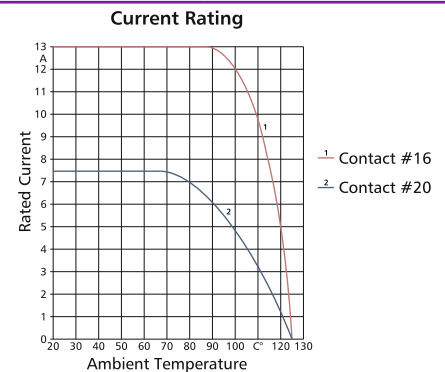

---

# Table of contents

---

|                                 |    |
|---------------------------------|----|
| Product overview .....          | 5  |
| How to use this catalogue.....  | 7  |
| Part number creation .....      | 8  |
| Ordering reference .....        | 10 |
| Contact arrangements.....       | 12 |
| Alternate insert positions..... | 15 |
| Wall mounting receptacles ..... | 16 |
| Cable connecting plugs .....    | 17 |
| Box mounting receptacles .....  | 18 |
| Thru-bulkhead receptacles.....  | 18 |
| Straight plugs .....            | 19 |
| Jam nut receptacles.....        | 21 |
| Right angle plugs .....         | 22 |

## **Special versions**

|   |    |
|---|----|
| Connectors with grounding continuity.....   | 23 |
| Receptacles with straight solder pins ..... | 26 |

## **Accessories and tooling**

|  |    |
|--|----|
| Panel cutouts .....                      | 27 |
| Protective caps .....                    | 28 |
| Dummy receptacle .....                   | 30 |
| Cross reference lists .....              | 31 |
| Tools and accessories .....              | 32 |
| KPSE contact and sealing principle ..... | 33 |
| Product safety information .....         | 34 |

---

# How to use

This catalog is split in several sections that help you to

- get a general overview of all product lines (product overview)
- create a product part number step by step (part number creation OR ordering reference)
- get all required detail information (dimensions, product details)
- get all required support products (accessories, tooling)

The fastest way to find your product of choice is to follow these steps

---

**1** **Select your product** using either the “part number creation” or “ordering reference” option

---

---

**3** **Add accessories and tooling** as required on the related pages

---

---

**2** **Use the detail pages** to better understand the available options and choose the best solution for your needs

---

---

**4** **Use the contact information** on the back cover to contact us for further questions or to get advise on where you can purchase our products

---



# Part number creation plug

Follow these steps to design your connector part number.

## STEP 1 Select shell style (plug)

| Shell Style   | Plug  | Shell Style   | Plug   | Shell Style   | Plug  |
|---|---|---|--|---|---|
| <b>Plug straight</b>  | Solder<br>KPT06<br>KPTC6<br>Crimp<br>KPSE06 | <b>Plug straight shielded</b>   | Solder<br>KPT6-DZ<br>KPTC6-DZ<br>Crimp<br>KPSE6-DZ | <b>Plug 90°</b>   | Solder<br>KPT08<br>KPTC8<br>Crimp<br>KPSE08 |
|  |   |  |  |  |   |

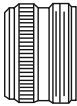
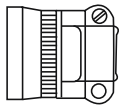
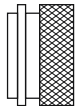
## STEP 2 Choose backshell

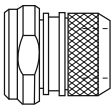
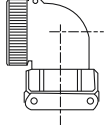
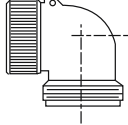
|  |  |  |  |   |  |  |
|--|--|--|--|---|--|--|
| <b>Class A</b><br>General duty with thread   | <b>Class F</b><br>Grommet seal with strain relief                                  | <b>Class E add mod. code DN</b><br>Environmental, grommet seal, heat shrink boot adapter | <b>Class PG; ME KPTC only</b><br>Environmental                                     | <b>Class E add Mod. code DZ</b><br>Environmental, grommet seal, shielded heat shrink boot adapter | <b>Class F, 90°</b><br>Grommet seal with thread and cable clamp                      | <b>Class A, 90°</b><br>General duty with thread<br><br><b>Class E, 90°</b><br>Grommet seal with thread |
|  |  |        |  |                 |  |                    |

## STEP 3 Choose layout

see page 12–14 for layouts

## STEP 4 Choose gender

P=pin S=socket

## STEP 5 Choose rotation

see page 15 for rotation (omit for normal position)

## STEP 6 Choose modification\*

see page 11 for modifications (omit if no modification is required)

\* If a modification is used the initial ,0' in the shell style description is omitted e.g. KPT01 is changed to KPT1. KPTC series does never use the initial ,0' e.g. KPTC6

Design your part number as per above steps

| KPSE/KPT Examples        | STEP 1 Shell style | STEP 2 Class/Backshell | STEP 3 Contact arrangement | STEP 4 Contact gender | STEP 5 Insulation rotation | STEP 6 Mod code (max. 3 codes) |
|--------------------------|--------------------|------------------------|----------------------------|-----------------------|----------------------------|--------------------------------|
| <b>Solder Industrial</b> | KPT6               | E                      | 20–41                      | P                     |                            | – DZ                           |
| <b>Crimp Industrial</b>  | KPSE6              | E                      | 14–12                      | S                     | – W                        | – F42 – A240 – F0              |







| KPTC Examples            | STEP 1 Shell style | STEP 2 Class/Backshell | STEP 3 Contact arrangement | STEP 4 Contact gender | STEP 6 Plating | STEP 5 Insulation rotation | STEP 6 Mod code (max. 3 codes) |
|--------------------------|--------------------|------------------------|----------------------------|-----------------------|----------------|----------------------------|--------------------------------|
| <b>Solder Industrial</b> | KPTC6              | E                      | 20–41                      | P                     | C              |                            | – MA                           |
| <b>Crimp Industrial</b>  | KPTC6              | PG                     | 14–12                      | S                     | – D            | W                          | – P13,5 – MB                   |



# Part number creation receptacle

Follow these steps to design your connector part number.

## STEP 1 Select shell style (receptacle)

| Wall Mount  |   | Cable connecting  |   | Jam Nut*  |   | Box Mount*  |   | Thru-Bulkhead                    |
|---|---|---|---|---|---|---|---|----------------------------------|
| Solder<br>KPT00<br>KPTC0  | Crimp<br>KPSE00<br>KPTC0  | Solder<br>KPT01<br>KPTC1  | Crimp<br>KPSE01   | Solder<br>KPT07<br>KPTC7  | Crimp<br>KPSE07<br>KPTC7  | Solder<br>KPT02<br>KPTC2  | Crimp<br>KPSE02<br>KPTC2  | KPTB<br>(contacts pre-installed) |
|  |  |  |  |  |  |  |  |                                  |

## STEP 2 Choose backshell

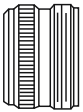
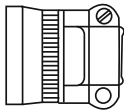
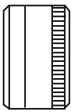
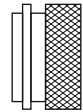
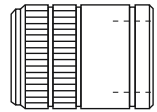
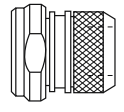
| Class A<br>General duty with thread  | Class F<br>Grommet seal with strain relief   | Class E<br>Environmental, grommet seal, no clamp                                   | Class E<br>add Mod. code DN<br>Environmental, grommet seal, heat shrink boot adapter | Class PG or ME<br>Environmental, KPTC only   | Class E<br>add Mod. code DZ<br>Environmental, grommet seal shielded heat shrink boot adapter |
|--|--|--|--|--|--|
|  |  |  |    |  |          |

**STEP 3** Choose layout see page 12–14 for layouts

**STEP 4** Choose gender P=pin S=socket

**STEP 5** Choose rotation see page 15 for rotation (omit for normal position)

**STEP 6** Choose modification\*\* see page 11 for modifications (omit if no modification is required)

\* Shell style 02 (box mount) and 07A (jam nut) doesn't accept a backshell  
 \*\* If a modification is used the initial ,0' in the shell style description is omitted e.g. KPT01 is changed to KPT1. KPTC series does never use the initial ,0' e.g. KPTC6

Design your part number as per above steps

| KPSE/KPT<br>Examples     | STEP 1<br>Shell style | STEP 2<br>Class/Backshell | STEP 3<br>Contact arrangement | STEP 4<br>Contact gender | STEP 5<br>Insulation rotation | STEP 6<br>Mod code (max. 3 codes) |
|--------------------------|-----------------------|---------------------------|-------------------------------|--------------------------|-------------------------------|-----------------------------------|
| <b>Solder Industrial</b> | KPT02                 | E                         | 20–41                         | P                        |                               |                                   |
| <b>Crimp Industrial</b>  | KPSE1                 | E                         | 14–12                         | S                        | – W                           | – F42 – A240 – F0                 |

| KPTC<br>Examples         | STEP 1<br>Shell style | STEP 2<br>Class/Backshell | STEP 3<br>Contact arrangement | STEP 4<br>Contact gender | STEP 6<br>Plating | STEP 5<br>Insulation rotation | STEP 6<br>Mod code (max. 3 codes) |
|--------------------------|-----------------------|---------------------------|-------------------------------|--------------------------|-------------------|-------------------------------|-----------------------------------|
| <b>Solder Industrial</b> | KPTC2                 | E                         | 20–41                         | P                        | C                 |                               | – MA                              |
| <b>Crimp Industrial</b>  | KPTC0                 | PG                        | 14–12                         | S                        | – D               | W                             | – P13,5 – MB                      |

# Ordering reference

## KPT / KPSE / KPTC

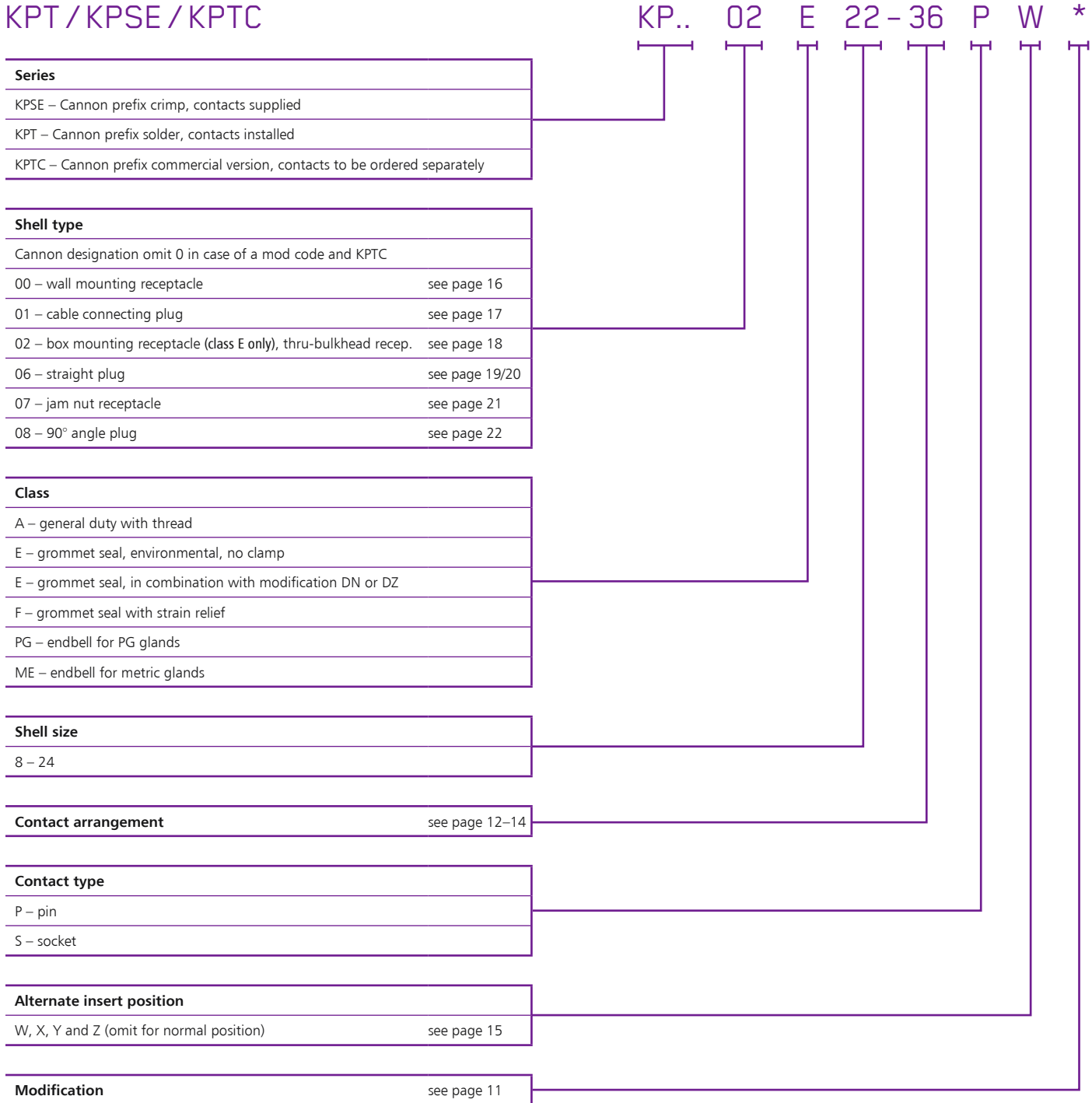

\* If a modification is used the initial ,0' in the shell style description is omitted e.g. KPT01 is changed to KPT1. KPTC series does never use the initial ,0' e.g. KPTC6

## KPSE/KPT-Modification codes

| Multiple codes can be used in order of listing below  | KPSE | KPT  |
|---|------|------|
| <b>Endbell</b>  |      |      |
| DN – heat shrink boot adapter, grommet seal   | DN   | DN   |
| DZ – shielded, heat shrink boot adapter, grommet seal   | DZ   | DZ   |
| F42 – without endbell, grommet and ferrule  | F42  | F42  |
| <b>Plating</b> (Cadmium with olive drab chromate plating is standard; Alternative platings below) |      |      |
| A232 – Zinc Cobalt, black plating (RoHS compliant)  | A232 | A232 |
| A240 – Zinc Nickel plating (RoHS compliant) (not for code DZ)                                     | A240 | A240 |
| A233 – Zinc Cobalt, green plating   | A233 | A233 |
| A34 – Nickel plating (RoHS compliant)   | A34  | A34  |
| <b>Contact</b>  |      |      |
| F0 – connector without contacts   | F0   | F0   |
| EX – PCB solder pin 0,76x7mm (style 02 and 07 only)   | –    | EX   |
| EW – PCB solder pin 0,6x7mm (style 02 and 07 only)  | –    | EW   |

## KPTC-Modification codes

| Multiple codes can be used in order of listing below   | KPTC  |
|--|-------|
| <b>Plating</b>   |       |
| Nickel plating (RoHS compliant)                        | C     |
| Zinc Cobalt black plating (RoHS compliant)             | R     |
| Zinc Cobalt green plating (RoHS compliant)             | F     |
| Zinc Nickel plating (RoHS compliant) (not for code DZ) | H     |
| Cadmium with olive drab chromate                       | D     |
| <b>Endbell</b>   |       |
| DN – heat shrink boot adapter, grommet seal            | DN    |
| DZ – shielded, heat shrink boot adapter, grommet seal  | DZ    |
| F42 – without endbell, grommet and ferrule             | F42   |
| <b>Endbell for PG glands (KPTC and KPT)</b>            |       |
| PG09 - thread for shell size 10                        | P9    |
| PG11 – thread for shell size 12                        | P11   |
| PG13,5 – thread for shell size 14                      | P13,5 |
| PG16 – thread for shell size 16                        | P16   |
| PG21 – thread for shell size 18, 20, 22                | P21   |
| PG29 – thread for shell size 24                        | P29   |
| <b>Endbell for metric glands (KPTC and KPT)</b>        |       |
| M12 – thread for shell size 10                         | M12   |
| M16 – thread for shell size 12                         | M16   |
| M20 – thread for shell size 14                         | M20   |
| M25 – thread for shell size 16, 18, 20                 | M25   |
| M32 – thread for shell size 22, 24                     | M32   |
| <b>Contact</b>   |       |
| Connector supplied with solder pot contacts installed  | MA    |
| Connector supplied with crimp contacts                 | MB    |

## Military approved version

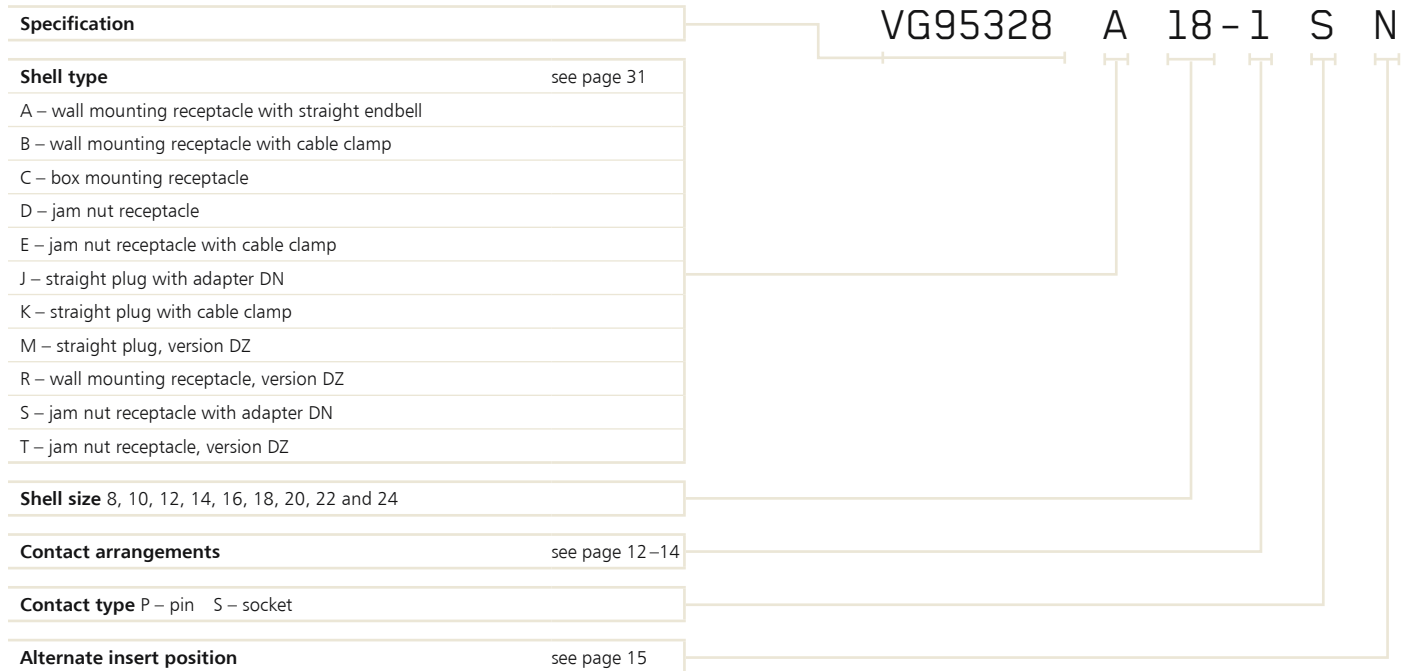

## CONTACT ARRANGEMENTS

|   | No. of contacts | Contact arrangements<br>Contact size<br>AWG | Service rating | Insulator position |     |     |     |
|---|-----------------|---|----------------|--------------------|-----|-----|-----|
|   |                 |   |                | W                  | X   | Y   | Z   |
|    | 2               | 8-2 ▲▲<br>20                                | 1              | 58                 | 122 | -   | -   |
|    | 3               | 8-3 ▲▲<br>20                                | 1              | 60                 | 210 | -   | -   |
|    | 3               | 8-3A ▲●◇<br>20                              | 1              | 60                 | -   | -   | -   |
|    | 3               | 8-33 ▲◇△<br>20                              | 1              | 90                 | -   | -   | -   |
|    | 4               | 8-4 ▲▲<br>20                                | 1              | 45                 | -   | -   | -   |
|    | 6               | 10-6 ▲●△◇<br>20                             | 1              | 90                 | -   | -   | -   |
|   | 7               | 10-7 ▲<br>20                                | 1              | 90                 | -   | -   | -   |
|  | 6               | 10-98 ▲<br>20                               | 1              | 90                 | 180 | 240 | 270 |
|  | 3               | 12-3 ▲●△◇<br>16                             | 2              | -                  | -   | 180 | -   |
|  | 8               | 12-8 ▲<br>20                                | 1              | 90                 | 112 | 203 | 292 |
|  | 10              | 12-10 ▲●△◇<br>20                            | 1              | 60                 | 155 | 270 | 295 |
|  | 14              | 12-14 ▲<br>20                               | 1              | 60                 | 155 | 270 | 295 |
|  | 5               | 14-5 ▲●△◇<br>16                             | 2              | 40                 | 92  | 184 | 273 |
|  | 12              | 14-12 ▲●△◇<br>20(8)<br>16(4)                | 1              | 43                 | 90  | -   | -   |

Legend ▲KPT ◇KPSE △ authorized per MIL-C-26482 ● authorized per VG95328

## CONTACT ARRANGEMENTS

|   | No. of contacts | Contact arrangements  | Service rating | Insulator position |     |     |     |
|---|-----------------|---|----------------|--------------------|-----|-----|-----|
|   |                 |   |                | W                  | X   | Y   | Z   |
|    | 15              | 14-15 ▲•△◇<br>20 (14)<br>16(1)                                    | 1              | 17                 | 110 | 155 | 234 |
|    | 18              | 14-18 ▲<br>20   | 1              | 15                 | 90  | 180 | 270 |
|    | 19              | 14-19 ▲•△◇<br>20  | 1              | 30                 | 165 | 315 | –   |
|    | 5               | 14-22 ◇<br>12 (4)<br>20(1)  | 1              | –                  | –   | –   | –   |
|    | 4               | 14A4 ▲<br>Coax RG 188 U<br>(not for receptacle<br>shell style 02) | 1              | –                  | –   | –   | –   |
|    | 8               | 16-8 ▲•△◇<br>16   | 2              | 54                 | 152 | 180 | 331 |
|   | 23              | 16-23 ▲•◇<br>20 (22)<br>16(1)                                     | 1              | 158                | 270 | –   | –   |
|  | 26              | 16-26 ▲•△◇<br>20  | 1              | 60                 | –   | 275 | 338 |
|  | 11              | 18-11 ▲•△◇<br>16  | 2              | 62                 | 119 | 241 | 340 |
|  | 32              | 18-32 ▲•△◇<br>20  | 2              | 85                 | 138 | 222 | 265 |

Legend ▲KPT ◇KPSE △ authorized per MIL-C-26482 • authorized per VG95328

## CONTACT ARRANGEMENTS

|  | No. of contacts | Contact arrangements  | Service rating | Insulator position |     |     |     |
|--|-----------------|---|----------------|--------------------|-----|-----|-----|
|  |                 |   |                | W                  | X   | Y   | Z   |
|  | 5               | <b>20A6</b> ◇<br>12<br>Note: contacts are 1 grounding pin and 4 standard size 12 pins | 2              | 90                 | 180 | 270 | –   |
|  | 16              | <b>20-16</b> ▲•△◇<br>16   | 2              | 238                | 316 | 333 | 347 |
|  | 24              | <b>20-24</b> ▲<br>20  | 1              | 70                 | 145 | 215 | 290 |
|  | 39              | <b>20-39</b> ▲•△◇<br>20(37)<br>16(2)  | 1              | 63                 | 114 | 252 | 333 |
|  | 41              | <b>20-41</b> ▲•△◇<br>20   | 1              | 45                 | 126 | 225 | –   |
|  | 21              | <b>22-21</b> ▲•△◇<br>16   | 2              | 16                 | 135 | 175 | 349 |
|  | 36              | <b>22-36</b> ▲•<br>20   | 1              | 72                 | 144 | 216 | 288 |
|  | 41              | <b>22-41</b> ▲△<br>20(27)<br>16(14)   | 1<br>2         | 39                 | 135 | 264 | –   |
|  | 55              | <b>22-55</b> ▲•△◇<br>20   | 1              | 30                 | 142 | 226 | 314 |
|  | 61              | <b>24-61</b> ▲•△◇<br>20   | 1              | 90                 | 180 | 270 | 324 |

Legend ▲KPT ◇KPSE △ authorized per MIL-C-26482 • authorized per VG95328

## ALTERNATE INSERT POSITION

The diagram indicates alternate insert positions.

The six positions N, V, W, Y, Z differ in degree of rotation for various sizes and arrangements. For the exact degree of rotation, for the list of contact arrangements and for alternate positions available, refer to the table at the right.

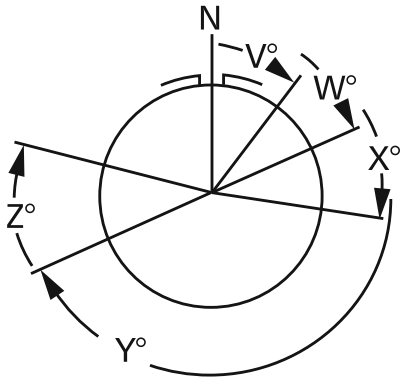

| Shell size | No. of contacts | Contact arrangements | Degree of Rotation |     |     |     |     |
|------------|-----------------|----------------------|--------------------|-----|-----|-----|-----|
|            |                 |                      | V                  | W   | X   | Y   | Z   |
| 8          | 2               | 8-2                  | -                  | 58  | 122 | -   | -   |
|            | 3               | 8-3                  | -                  | 60  | 210 | -   | -   |
|            | 3               | 8-3A                 | -                  | 60  | -   | -   | -   |
|            | 3               | 8-33                 | -                  | 90  | -   | -   | -   |
|            | 4               | 8-4                  | -                  | 45  | -   | -   | -   |
| 10         | 6               | 10-6                 | -                  | 90  | -   | -   | -   |
|            | 7               | 10-7                 | -                  | 90  | -   | -   | -   |
|            | 6               | 10-98                | -                  | 90  | 180 | 240 | 270 |
| 12         | 3               | 12-3                 | -                  | -   | -   | 180 | -   |
|            | 8               | 12-8                 | -                  | 90  | 112 | 203 | 292 |
|            | 10              | 12-10                | -                  | 60  | 155 | 270 | 295 |
|            | 14              | 12-14                | -                  | 60  | 155 | 270 | 295 |
| 14         | 4               | 14A4                 | -                  | -   | -   | -   | -   |
|            | 5               | 14-5                 | -                  | 40  | 92  | 184 | 273 |
|            | 12              | 14-12                | -                  | 43  | 90  | -   | -   |
|            | 15              | 14-15                | -                  | 17  | 110 | 155 | 234 |
|            | 18              | 14-18                | -                  | 15  | 90  | 180 | 270 |
|            | 19              | 14-19                | -                  | 30  | 165 | 315 | -   |
|            | 5               | 14-22                | -                  | -   | -   | -   | -   |
| 16         | 8               | 16-8                 | -                  | 54  | 52  | 180 | 331 |
|            | 23              | 16-23                | -                  | 158 | 270 | -   | -   |
|            | 26              | 16-26                | -                  | 60  | -   | 275 | 338 |
| 18         | 11              | 18-11                | -                  | 62  | 119 | 241 | 340 |
|            | 32              | 18-32                | -                  | 85  | 138 | 222 | 265 |
| 20         | 5               | 20A6*                | -                  | 90  | 180 | 270 | -   |
|            | 16              | 20-16                | -                  | 238 | 318 | 333 | 347 |
|            | 24              | 20-24                | -                  | 70  | 145 | 215 | 290 |
|            | 39              | 20-39                | -                  | 63  | 114 | 252 | 333 |
|            | 41              | 20-41                | -                  | 45  | 126 | 225 | -   |
| 22         | 21              | 22-21                | -                  | 16  | 135 | 175 | 349 |
|            | 36              | 22-36                | -                  | 72  | 144 | 216 | 288 |
|            | 41              | 22-41                | -                  | 39  | 135 | 264 | -   |
|            | 55              | 22-55                | -                  | 30  | 142 | 226 | 314 |
| 24         | 61              | 24-61                | -                  | 90  | 180 | 270 | 324 |

\* This contact arrangement features five contacts size 12. Four standard contacts and one is a first-to-mate contact.

## WALL MOUNTING RECEPTACLES KPT00/KPSE00/KPTC0

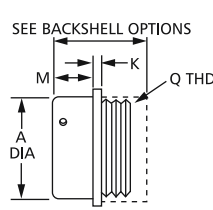

**SOLDER**  
KPT01 (MS3111)

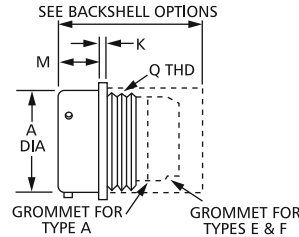

**CRIMP**  
KPSE01 (MS3121)

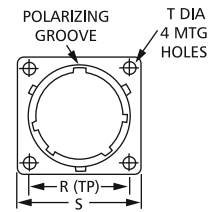

**RECEPTACLE**  
**ASSEMBLY**

| Shell size | Ø A         | Q              | K    | M     | R     | S    | Ø T   |
|------------|-------------|----------------|------|-------|-------|------|-------|
|            | +0,03 -0,13 | Thread Type 2A | ±0,1 | ±0,15 | ±0,15 | max. | ±0,15 |
| 8          | 12,00       | 7/16-28UNEF    | 1,9  | 11,6  | 15,1  | 21,0 | 3,05  |
| 10         | 15,00       | 9/16-24UNEF    | 1,9  | 11,6  | 18,3  | 24,2 | 3,05  |
| 12         | 19,05       | 11/16-24UNEF   | 1,9  | 11,6  | 20,6  | 26,6 | 3,05  |
| 14         | 22,23       | 13/16-20UNEF   | 1,9  | 11,6  | 23,0  | 29,0 | 3,05  |
| 16         | 25,40       | 15/16-20UNEF   | 1,9  | 11,6  | 24,6  | 31,3 | 3,05  |
| 18         | 28,58       | 1-1/16-18UNEF  | 1,9  | 11,6  | 27,0  | 33,7 | 3,05  |
| 20         | 31,75       | 1-3/16-18UNEF  | 2,2  | 14,25 | 29,4  | 36,9 | 3,05  |
| 22         | 34,93       | 1-5/16-18UNEF  | 2,2  | 14,25 | 31,8  | 40,1 | 3,05  |
| 24         | 38,10       | 1-7/16-18UNEF  | 2,2  | 15,1  | 34,9  | 43,3 | 3,75  |

### Backshell options

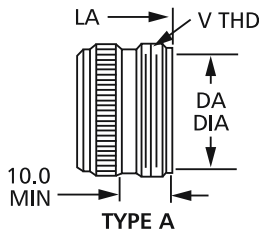

**TYPE A**

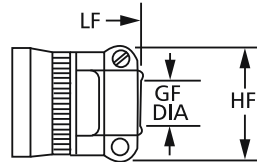

**TYPE F**

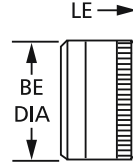

**TYPE E**

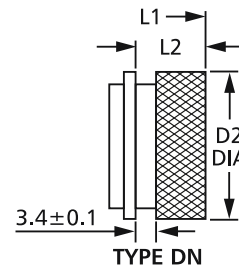

**TYPE DN**

| Shell size | Type A       |            |                                    | Type F                   |                        |                        | Type E                   |                        |
|------------|--------------|------------|------------------------------------|--------------------------|------------------------|------------------------|--------------------------|------------------------|
|            | Ø Da<br>min. | LA<br>max. | V <sub>THD</sub><br>Thread Type 2A | Ø G <sub>F</sub><br>min. | H <sub>F</sub><br>max. | L <sub>F</sub><br>max. | Ø B <sub>E</sub><br>max. | L <sub>E</sub><br>max. |
| 8          | 8,5          | 38,0       | 1/2-28UNEF                         | 2,9                      | 19,3                   | 56,0                   | 14,2                     | 32,5                   |
| 10         | 11,8         | 38,0       | 5/8-24UNEF                         | 4,5                      | 20,8                   | 56,0                   | 17,2                     | 32,5                   |
| 12         | 15,0         | 38,0       | 3/4-20UNEF                         | 7,7                      | 24,4                   | 56,0                   | 20,4                     | 32,5                   |
| 14         | 17,9         | 38,0       | 7/8-20UNEF                         | 9,3                      | 27,2                   | 56,0                   | 23,4                     | 32,5                   |
| 16         | 21,1         | 38,0       | 1-20UNEF                           | 12,4                     | 28,7                   | 56,0                   | 26,6                     | 32,5                   |
| 18         | 24,1         | 38,0       | 1-3/16-18UNEF                      | 15,6                     | 35,3                   | 56,0                   | 29,6                     | 32,5                   |
| 20         | 26,5         | 43,1       | 1-3/16-18UNEF                      | 15,6                     | 35,3                   | 61,0                   | 32,8                     | 34,5                   |
| 22         | 30,4         | 43,1       | 1-7/16-18UNEF                      | 18,8                     | 39,9                   | 61,0                   | 36,0                     | 34,5                   |
| 24         | 32,8         | 43,1       | 1-7/16-18UNEF                      | 20,1                     | 43,2                   | 61,0                   | 39,2                     | 34,5                   |

### Mod. DN

| Shell size | Ø D2 | L1   | L2   |
|------------|------|------|------|
|            | -0,5 | max. | ±0,5 |
| 8          | 15,6 | 35,0 | 12,2 |
| 10         | 18,4 | 35,0 | 12,2 |
| 12         | 23,7 | 35,0 | 12,2 |
| 14         | 24,5 | 35,0 | 12,2 |
| 16         | 29,8 | 37,0 | 14,5 |
| 18         | 32,0 | 37,0 | 14,5 |
| 20         | 36,1 | 42,0 | 15,8 |
| 22         | 38,5 | 42,0 | 15,8 |
| 24         | 41,6 | 42,0 | 14,9 |



## CABLE CONNECTING PLUGS KPT01/KPSE01/KPTC1

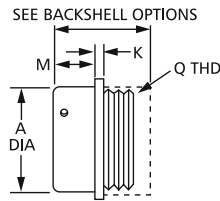

**SOLDER**  
KPT01 (MS3111)

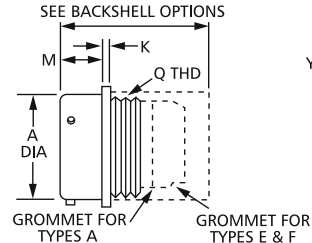

**CRIMP**  
KPSE01 (MS3121)

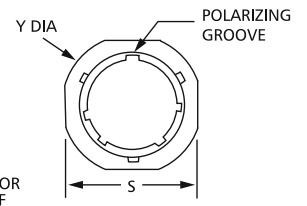

**RECEPTACLE**  
ASSEMBLY

| Shell size | Ø A          | K    | M     | Q THD          | S     | Ø Y  |
|------------|--------------|------|-------|----------------|-------|------|
|            | +0,03 - 0,13 | ±0,1 | ±0,15 | Thread Type 2A | max.  | max. |
| 8          | 12,00        | 1,9  | 11,6  | 7/16-28UNEF    | 20,6  | 23,8 |
| 10         | 15,00        | 1,9  | 11,6  | 9/16-24UNEF    | 23,8  | 26,9 |
| 12         | 19,05        | 1,9  | 11,6  | 11/16-24UNEF   | 26,15 | 29,3 |
| 14         | 22,23        | 1,9  | 11,6  | 13/16-20UNEF   | 28,5  | 31,7 |
| 16         | 25,40        | 1,9  | 11,6  | 15/16-20UNEF   | 30,7  | 34,1 |
| 18         | 28,58        | 1,9  | 11,6  | 1-1/16-18UNEF  | 33,3  | 36,5 |
| 20         | 31,75        | 2,2  | 14,25 | 1-3/16-18UNEF  | 36,5  | 39,6 |
| 22         | 34,93        | 2,2  | 14,25 | 1-5/16-18UNEF  | 39,5  | 42,8 |
| 24         | 38,10        | 2,2  | 15,1  | 1-7/16-18UNEF  | 42,8  | 46,0 |

### Backshell options

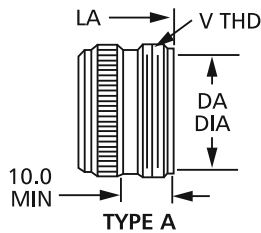

**TYPE A**

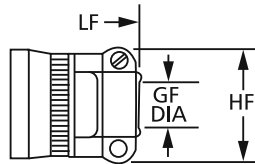

**TYPE F**

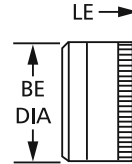

**TYPE E**

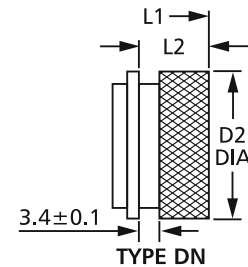

**TYPE DN**

| Shell size | Type A                   |                        |                                    | Type F                   |                        |                        | Type E                   |                        |
|------------|--------------------------|------------------------|------------------------------------|--------------------------|------------------------|------------------------|--------------------------|------------------------|
|            | Ø D <sub>A</sub><br>min. | L <sub>A</sub><br>max. | V <sub>THD</sub><br>Thread Type 2A | Ø G <sub>F</sub><br>min. | H <sub>F</sub><br>max. | L <sub>F</sub><br>max. | Ø B <sub>E</sub><br>max. | L <sub>E</sub><br>max. |
| 8          | 8,5                      | 38,0                   | 1/2-28UNEF                         | 2,9                      | 19,3                   | 56,0                   | 14,2                     | 32,5                   |
| 10         | 11,8                     | 38,0                   | 5/8-24UNEF                         | 4,5                      | 20,8                   | 56,0                   | 17,2                     | 32,5                   |
| 12         | 15,0                     | 38,0                   | 3/4-20UNEF                         | 7,7                      | 24,4                   | 56,0                   | 20,4                     | 32,5                   |
| 14         | 17,9                     | 38,0                   | 7/8-20UNEF                         | 9,3                      | 27,2                   | 56,0                   | 23,4                     | 32,5                   |
| 16         | 21,1                     | 38,0                   | 1-20UNEF                           | 12,4                     | 28,7                   | 56,0                   | 26,6                     | 32,5                   |
| 18         | 24,1                     | 38,0                   | 1-3/16-18UNEF                      | 15,6                     | 35,3                   | 56,0                   | 29,6                     | 32,5                   |
| 20         | 26,5                     | 43,1                   | 1-3/16-18UNEF                      | 15,6                     | 35,3                   | 61,0                   | 32,8                     | 34,5                   |
| 22         | 30,4                     | 43,1                   | 1-7/16-18UNEF                      | 18,8                     | 39,9                   | 61,0                   | 36,0                     | 34,5                   |
| 24         | 32,8                     | 43,1                   | 1-7/16-18UNEF                      | 20,1                     | 43,2                   | 61,0                   | 39,2                     | 34,5                   |

### Mod. DN

| Shell size | Ø D <sub>2</sub> | L <sub>1</sub> | L <sub>2</sub> |
|------------|------------------|----------------|----------------|
|            | -0,5             | max.           | ±0,5           |
| 8          | 15,6             | 35,0           | 12,2           |
| 10         | 18,4             | 35,0           | 12,2           |
| 12         | 23,7             | 35,0           | 12,2           |
| 14         | 24,5             | 35,0           | 12,2           |
| 16         | 29,8             | 37,0           | 14,5           |
| 18         | 32,0             | 37,0           | 14,5           |
| 20         | 36,1             | 42,0           | 15,8           |
| 22         | 38,5             | 42,0           | 15,8           |
| 24         | 41,6             | 42,0           | 14,9           |

## BOX MOUNTING RECEPTACLE KPT02/KPSE02/KPTC2

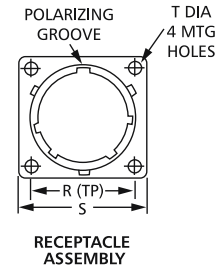
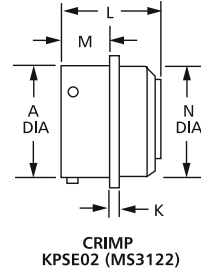
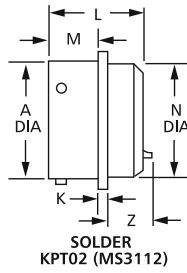

| Shell size | KPT/KPSE/KPTC     |           |             |           |            |            |           |              | KPT/KPTC  |
|------------|-------------------|-----------|-------------|-----------|------------|------------|-----------|--------------|-----------|
|            | Ø A<br>+0,03-0,13 | L<br>max. | Ø N<br>max. | K<br>±0,1 | M<br>±0,15 | R<br>±0,15 | S<br>max. | Ø T<br>±0,15 | Z<br>max. |
| 8          | 12,00             | 21,1      | 11,1        | 1,9       | 11,6       | 15,1       | 21,0      | 3,05         | 12,3      |
| 10         | 15,00             | 21,1      | 14,3        | 1,9       | 11,6       | 18,3       | 24,2      | 3,05         | 12,3      |
| 12         | 19,05             | 21,1      | 17,5        | 1,9       | 11,6       | 20,6       | 26,6      | 3,05         | 12,3      |
| 14         | 22,23             | 21,1      | 20,6        | 1,9       | 11,6       | 23,0       | 29,0      | 3,05         | 12,3      |
| 16         | 25,40             | 21,1      | 23,8        | 1,9       | 11,6       | 24,6       | 31,3      | 3,05         | 12,3      |
| 18         | 28,58             | 21,1      | 27,0        | 1,9       | 11,6       | 27,0       | 33,7      | 3,05         | 12,3      |
| 20         | 31,75             | 22,7      | 30,2        | 2,2       | 14,25      | 29,4       | 36,9      | 3,05         | 10,8      |
| 22         | 34,93             | 22,7      | 33,4        | 2,2       | 14,25      | 31,8       | 40,1      | 3,05         | 10,8      |
| 24         | 38,10             | 22,7      | 36,5        | 2,2       | 15,1       | 34,9       | 43,3      | 3,75         | 10,0      |

## THRU-BULKHEAD RECEPTACLES KPTB

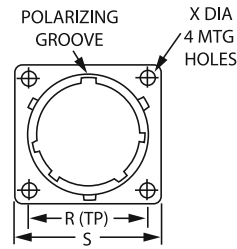
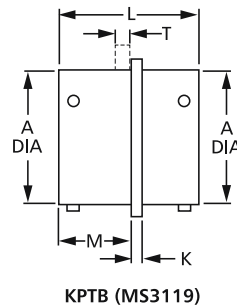

| Shell size | Ø A<br>+0,03-0,13 | K<br>±0,1 | L<br>max. | M<br>±0,25 | T<br>max. | R<br>±0,15 | S<br>max. | Ø X<br>±0,15 |
|------------|-------------------|-----------|-----------|------------|-----------|------------|-----------|--------------|
| 8          | 12,00             | 1,8       | 28,6      | 14,5       | 6,0       | 15,1       | 21,0      | 3,05         |
| 10         | 15,00             | 1,8       | 28,6      | 14,5       | 6,0       | 18,3       | 24,2      | 3,05         |
| 12         | 19,05             | 1,8       | 28,6      | 14,5       | 6,0       | 20,6       | 26,6      | 3,05         |
| 14         | 22,23             | 1,8       | 28,6      | 14,5       | 6,0       | 23,0       | 29,0      | 3,05         |
| 16         | 25,40             | 1,8       | 28,6      | 14,5       | 6,0       | 24,6       | 31,3      | 3,05         |
| 18         | 28,58             | 1,8       | 28,6      | 14,5       | 6,0       | 27,0       | 33,7      | 3,05         |
| 20         | 31,75             | 2,5       | 31,9      | 17,7       | 9,2       | 29,4       | 36,9      | 3,05         |
| 22         | 34,93             | 2,5       | 31,9      | 17,7       | 9,2       | 31,8       | 40,1      | 3,05         |
| 24         | 38,10             | 2,5       | 31,9      | 17,7       | 8,0       | 34,9       | 43,3      | 3,75         |

## STRAIGHT PLUGS KPT06/KPSE06/KPTC6

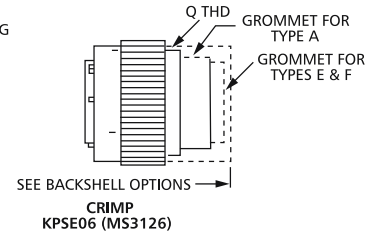
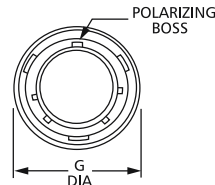
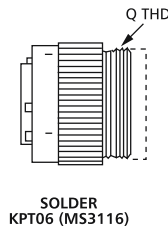

| Shell size | Ø G  | Q THD          |
|------------|------|----------------|
|            | max. | Thread Type 2A |
| 8          | 19,8 | 7/16-28UNEF    |
| 10         | 23,6 | 9/16-24UNEF    |
| 12         | 26,5 | 11/16-24UNEF   |
| 14         | 30,1 | 13/16-20UNEF   |
| 16         | 33,2 | 15/16-20UNEF   |
| 18         | 35,4 | 1-1/16-18UNEF  |
| 20         | 39,0 | 1-3/16-18UNEF  |
| 22         | 42,1 | 1-5/16-18UNEF  |
| 24         | 45,2 | 1-7/16-18UNEF  |

### Backshell options

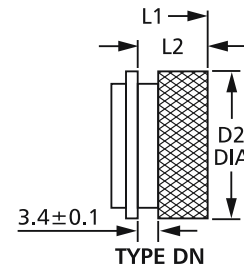
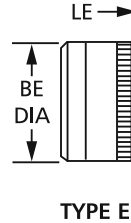
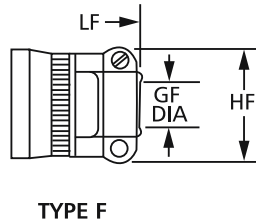
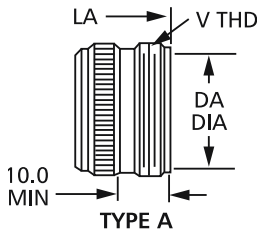

| Shell size | Type A                   |                        |                                    | Type F                   |                        |                        | Type E                   |                        |
|------------|--------------------------|------------------------|------------------------------------|--------------------------|------------------------|------------------------|--------------------------|------------------------|
|            | Ø D <sub>A</sub><br>min. | L <sub>A</sub><br>max. | V <sub>THD</sub><br>Thread Type 2A | Ø G <sub>F</sub><br>min. | L <sub>F</sub><br>max. | H <sub>F</sub><br>max. | Ø B <sub>E</sub><br>max. | L <sub>E</sub><br>max. |
| 8          | 8,5                      | 42,0                   | 1/2-28UNEF                         | 2,9                      | 56,0                   | 19,3                   | 14,2                     | 32,5                   |
| 10         | 11,8                     | 42,0                   | 5/8-24UNEF                         | 4,5                      | 56,0                   | 20,8                   | 17,2                     | 32,5                   |
| 12         | 15,0                     | 42,0                   | 3/4-20UNEF                         | 7,7                      | 56,0                   | 24,4                   | 20,4                     | 32,5                   |
| 14         | 17,9                     | 42,0                   | 7/8-20UNEF                         | 9,3                      | 56,0                   | 27,2                   | 23,4                     | 32,5                   |
| 16         | 21,1                     | 42,0                   | 1-20UNEF                           | 12,4                     | 59,0                   | 28,7                   | 26,6                     | 32,5                   |
| 18         | 24,1                     | 42,0                   | 1-3/16-18UNEF                      | 15,6                     | 59,0                   | 35,3                   | 29,6                     | 32,5                   |
| 20         | 26,5                     | 45,0                   | 1-3/16-18UNEF                      | 15,6                     | 59,0                   | 35,3                   | 32,8                     | 34,5                   |
| 22         | 30,4                     | 45,0                   | 1-7/16-18UNEF                      | 18,8                     | 59,0                   | 39,9                   | 36,0                     | 34,5                   |
| 24         | 32,8                     | 45,0                   | 1-7/16-18UNEF                      | 20,1                     | 59,0                   | 43,2                   | 39,2                     | 34,5                   |

| Mod. DN    |                  |                |                |
|------------|------------------|----------------|----------------|
| Shell size | Ø D <sub>2</sub> | L <sub>1</sub> | L <sub>2</sub> |
|            | -0,5             | max.           | ±0,5           |
| 8          | 15,6             | 35,0           | 12,2           |
| 10         | 18,4             | 35,0           | 12,2           |
| 12         | 23,7             | 35,0           | 12,2           |
| 14         | 24,5             | 35,0           | 12,2           |
| 16         | 29,8             | 37,0           | 14,5           |
| 18         | 32,0             | 37,0           | 14,5           |
| 20         | 36,1             | 42,0           | 15,8           |
| 22         | 38,5             | 42,0           | 15,8           |
| 24         | 41,6             | 42,0           | 14,9           |

## STRAIGHT PLUG KPT6PG/KPTC6PG

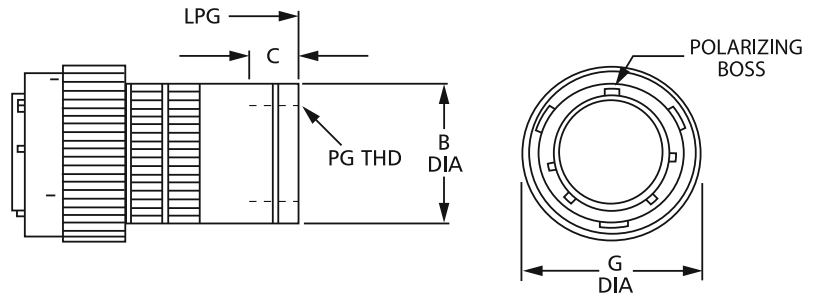

| Shell size | Ø G<br>max. | Ø B<br>max. | C<br>min. | LPG<br>max. | PG THD  |
|------------|-------------|-------------|-----------|-------------|---------|
| 10         | 23,6        | 19,0        | 10,5      | 58,5        | PG 09   |
| 12         | 26,5        | 22,5        | 10,5      | 58,5        | PG 11   |
| 14         | 30,1        | 25,0        | 10,5      | 58,5        | PG 13,5 |
| 16         | 33,2        | 28,0        | 10,5      | 73,0        | PG 16   |
| 18         | 35,4        | 32,5        | 11,5      | 73,0        | PG 21   |
| 20         | 39,0        | 34,5        | 11,5      | 76,0        | PG 21   |
| 22         | 42,1        | 38,0        | 11,5      | 82,0        | PG 21   |
| 24         | 45,2        | 40,5        | 11,5      | 82,0        | PG 29   |

## STRAIGHT PLUG KPT6ME/KPTC6ME

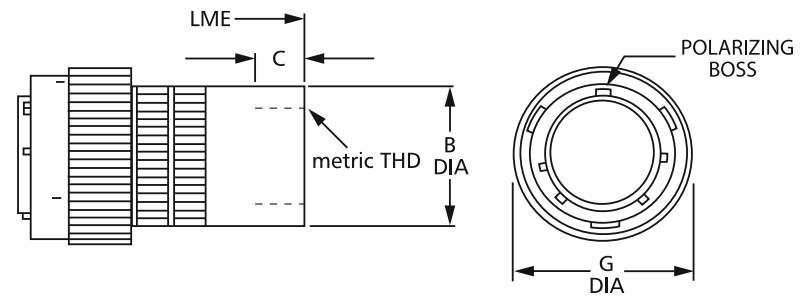

| Shell size | Ø G<br>max. | Ø B<br>max. | C<br>min. | LME<br>max. | Metric Thread |
|------------|-------------|-------------|-----------|-------------|---------------|
| 10         | 23,6        | 19,0        | 10,5      | 58,5        | M12x1,5       |
| 12         | 26,5        | 22,5        | 10,5      | 58,5        | M16x1,5       |
| 14         | 30,1        | 25,0        | 10,5      | 58,5        | M20x1,5       |
| 16         | 33,2        | 28,0        | 10,5      | 73,0        | M25x1,5       |
| 18         | 35,4        | 32,5        | 11,5      | 73,0        | M25x1,5       |
| 20         | 39,0        | 34,5        | 11,5      | 76,0        | M25x1,5       |
| 22         | 42,1        | 38,0        | 11,5      | 82,0        | M32x1,5       |
| 24         | 45,2        | 40,5        | 11,5      | 82,0        | M32x1,5       |

# JAM NUT RECEPTACLES KPT07/KPSE07/KPTC7

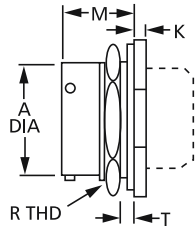

**SOLDER  
KPT07 (MS3114)**

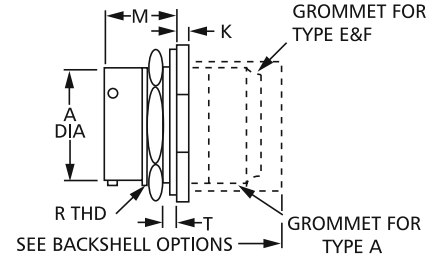
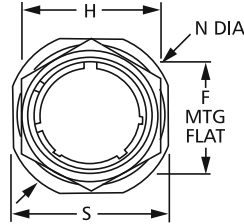

**CRIMP  
KPSE07 (MS3124)**

| Shell size | Ø A         | F     | H     | K     | M     | R THD          | S    | T Panel thickness |      | Ø N  |
|------------|-------------|-------|-------|-------|-------|----------------|------|-------------------|------|------|
|            | +0,03 -0,13 | ±0,15 | ±0,15 | ±0,25 | ±0,15 | Thread Type 2A | ±0,5 | min.              | max. | max. |
| 8          | 12,00       | 13,3  | 19,0  | 3,2   | 17,7  | 9/16-24UNEF    | 24,0 | 1,6               | 3,5  | 28,0 |
| 10         | 15,00       | 16,5  | 22,2  | 3,2   | 17,7  | 11/16-24UNEF   | 27,0 | 1,6               | 3,5  | 31,0 |
| 12         | 19,05       | 20,6  | 27,0  | 3,2   | 17,7  | 7/8-20UNEF     | 32,0 | 1,6               | 3,5  | 36,0 |
| 14         | 22,23       | 23,8  | 30,2  | 3,2   | 17,7  | 1-20UNEF       | 35,0 | 1,6               | 3,5  | 39,0 |
| 16         | 25,40       | 26,9  | 33,3  | 3,2   | 17,7  | 1-1/8-18UNEF   | 38,5 | 1,6               | 3,5  | 42,0 |
| 18         | 28,58       | 30,1  | 36,5  | 3,2   | 17,7  | 1-1/4-18UNEF   | 41,5 | 1,6               | 3,5  | 45,0 |
| 20         | 31,75       | 33,3  | 39,7  | 4,0   | 22,5  | 1-3/8-18UNEF   | 46,0 | 1,6               | 6,5  | 50,0 |
| 22         | 34,93       | 36,5  | 42,9  | 4,0   | 22,5  | 1-1/2-18UNEF   | 49,5 | 1,6               | 6,5  | 55,0 |
| 24         | 38,10       | 39,6  | 46,0  | 4,0   | 23,3  | 1-5/8-18UNEF   | 52,5 | 1,6               | 6,5  | 57,0 |

## Backshell options

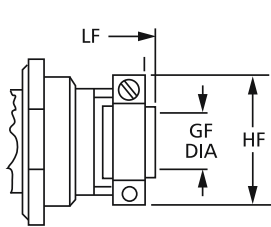

**TYPE F**

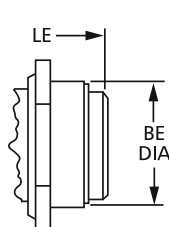

**TYPE E**

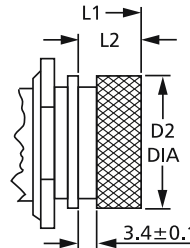

**TYPE DN**

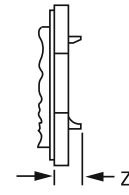

**TYPE A**

| Shell size | Type F                 |                          |                        | Type E                   |                        | Type DN                |                        |                          | Type A KPT/KPTC |
|------------|------------------------|--------------------------|------------------------|--------------------------|------------------------|------------------------|------------------------|--------------------------|-----------------|
|            | L <sub>F</sub><br>max. | Ø G <sub>F</sub><br>max. | H <sub>F</sub><br>max. | Ø B <sub>E</sub><br>max. | L <sub>E</sub><br>max. | L <sub>1</sub><br>max. | L <sub>2</sub><br>±0,5 | Ø D <sub>2</sub><br>max. | Z<br>max.       |
| 8          | 44,9                   | 2,9                      | 19,3                   | 18,2                     | 33,5                   | 43,0                   | 12,2                   | 15,6                     | 7,9             |
| 10         | 44,9                   | 4,5                      | 20,8                   | 21,5                     | 33,5                   | 43,0                   | 12,2                   | 18,4                     | 7,9             |
| 12         | 44,9                   | 7,7                      | 24,4                   | 24,6                     | 33,5                   | 43,0                   | 12,2                   | 23,7                     | 7,9             |
| 14         | 44,9                   | 9,3                      | 27,2                   | 27,8                     | 33,5                   | 43,0                   | 12,2                   | 24,7                     | 7,9             |
| 16         | 48,4                   | 12,4                     | 28,7                   | 31,0                     | 33,5                   | 45,5                   | 14,5                   | 29,8                     | 7,9             |
| 18         | 48,4                   | 15,6                     | 35,3                   | 34,1                     | 33,5                   | 45,5                   | 14,5                   | 32,0                     | 7,9             |
| 20         | 50,3                   | 15,6                     | 35,3                   | 38,1                     | 39,0                   | 52,6                   | 15,8                   | 36,1                     | 4,7             |
| 22         | 50,3                   | 18,8                     | 39,9                   | 41,3                     | 39,0                   | 52,6                   | 15,8                   | 28,5                     | 4,7             |
| 24         | 50,3                   | 20,1                     | 43,2                   | 44,5                     | 39,0                   | 51,6                   | 14,9                   | 41,6                     | 3,8             |

## RIGHT ANGLE PLUG, 90° KPT08/KPSE08/KPTC8

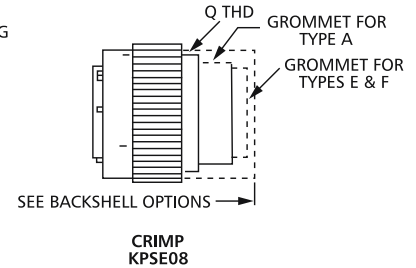
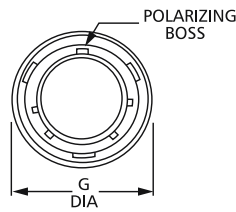
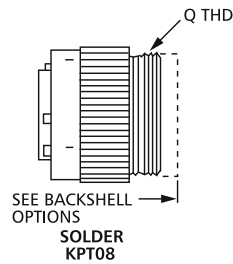

| Shell size | Ø G  | Q              |
|------------|------|----------------|
|            | max. | Thread Type 2A |
| 8          | 19,8 | 7/16-28UNEF    |
| 10         | 23,6 | 9/16-24UNEF    |
| 12         | 26,5 | 11/16-24UNEF   |
| 14         | 30,1 | 13/16-20UNEF   |
| 16         | 33,2 | 15/16-20UNEF   |
| 18         | 35,4 | 1-1/16-18UNEF  |
| 20         | 39,0 | 1-3/16-18UNEF  |
| 22         | 42,1 | 1-5/16-18UNEF  |
| 24         | 45,2 | 1-7/16-18UNEF  |

### Backshell options

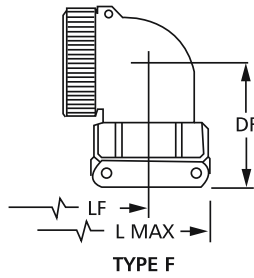
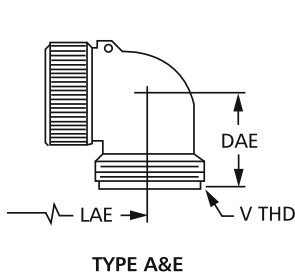

| Shell size | Type A and E    |                 |                  | Type F |                |                |
|------------|-----------------|-----------------|------------------|--------|----------------|----------------|
|            | L <sub>AE</sub> | D <sub>AE</sub> | V <sub>THD</sub> | L      | D <sub>F</sub> | L <sub>F</sub> |
|            | max.            | max.            | Thread Type 2A   | max.   | max.           | max.           |
| 8          | 36,1            | 20,9            | 1/2-28UNEF       | 47,0   | 31,4           | 36,1           |
| 10         | 38,3            | 21,7            | 5/8-24UNEF       | 49,5   | 32,2           | 38,3           |
| 12         | 40,9            | 23,3            | 3/4-20UNEF       | 53,5   | 35,4           | 40,9           |
| 14         | 41,6            | 24,9            | 7/8-20UNEF       | 55,5   | 38,6           | 41,6           |
| 16         | 42,5            | 26,5            | 1-20UNEF         | 57,0   | 40,2           | 42,5           |
| 18         | 44,7            | 28,1            | 1-3/16-18UNEF    | 62,5   | 41,8           | 44,7           |
| 20         | 48,3            | 29,6            | 1-3/16-18UNEF    | 67,0   | 43,4           | 48,3           |
| 22         | 52,1            | 31,7            | 1-7/16-18UNEF    | 71,5   | 47,9           | 52,1           |
| 24         | 52,1            | 33,6            | 1-7/16-18UNEF    | 74,0   | 49,9           | 52,1           |

## VERSIONS WITH GROUNDING CONTINUITY KPT/KPSE/KPTC

These connectors are designed to ensure electrical continuity

- at the cable shielding level to protect it against radio frequency interferences
- at the grounding level (if it is connected to the shielding)

The plugs are manufactured with grounding fingers fixed to the front face of the shell. They make contact with the inner side of the receptacle shell. Plug and receptacle feature a special backshell which supports the cable shielding. The connectors are in accordance with the VG95328 specification.

## RECEPTACLE WITH GROUNDING CONTINUITY (for shielded cable) KPT0E/KPSE0E/KPTC0E... DZ

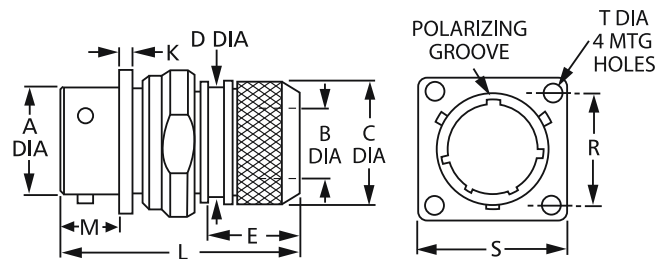

| Shell size | Ø A<br>+0,03-0,13 | Ø B<br>min. | Ø C<br>±0,5 | Ø D<br>max. | E<br>±1,0 | K<br>±0,1 | L<br>max. | M<br>±0,15 | R<br>±0,15 | S<br>max. | Ø T<br>±0,15 |
|------------|-------------------|-------------|-------------|-------------|-----------|-----------|-----------|------------|------------|-----------|--------------|
| 8          | 12,00             | 6,6         | 16,0        | 13,3        | 15,0      | 1,9       | 52,0      | 11,6       | 15,1       | 21,0      | 3,05         |
| 10         | 15,00             | 9,2         | 18,0        | 16,1        | 15,0      | 1,9       | 52,0      | 11,6       | 18,3       | 24,2      | 3,05         |
| 12         | 19,05             | 12,2        | 22,0        | 20,0        | 17,0      | 1,9       | 52,0      | 11,6       | 20,6       | 26,6      | 3,05         |
| 14         | 22,23             | 15,2        | 25,0        | 22,2        | 18,0      | 1,9       | 53,0      | 11,6       | 23,0       | 29,0      | 3,05         |
| 16         | 25,40             | 18,3        | 28,0        | 26,2        | 18,0      | 1,9       | 53,0      | 11,6       | 24,6       | 31,3      | 3,05         |
| 18         | 28,58             | 20,0        | 32,0        | 28,5        | 18,0      | 1,9       | 53,0      | 11,6       | 27,0       | 33,7      | 3,05         |
| 20         | 31,75             | 23,0        | 34,0        | 32,5        | 18,0      | 2,2       | 58,0      | 14,25      | 29,4       | 36,9      | 3,05         |
| 22         | 34,93             | 26,0        | 38,0        | 34,8        | 18,0      | 2,2       | 58,0      | 14,25      | 31,7       | 40,1      | 3,05         |
| 24         | 38,10             | 28,8        | 41,0        | 37,9        | 18,0      | 2,2       | 58,0      | 15,1       | 34,9       | 43,3      | 3,75         |

## CABLE CONNECTING PLUG WITH GROUNDING CONTINUITY (for shielded cable) KPT1E/KPSE1E/KPTC1E... DZ

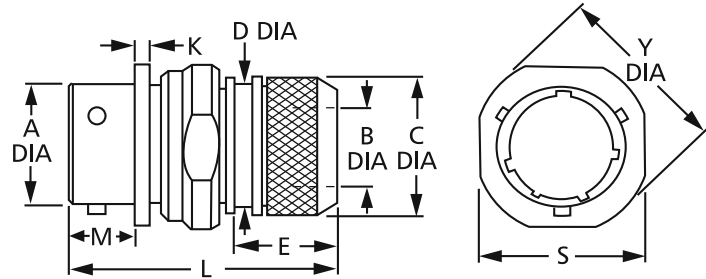

| Shell size | Ø A<br>+0,03-0,13 | M<br>±0,15 | Ø B<br>min. | Ø C<br>±0,5 | Ø D<br>max. | E<br>±1,0 | K<br>±0,1 | L<br>max. | S<br>max. | Ø Y<br>max. |
|------------|-------------------|------------|-------------|-------------|-------------|-----------|-----------|-----------|-----------|-------------|
| 8          | 12,00             | 11,6       | 6,6         | 16,0        | 13,3        | 15,0      | 1,9       | 52,0      | 18,5      | 21,0        |
| 10         | 15,00             | 11,6       | 9,2         | 18,0        | 16,1        | 15,0      | 1,9       | 52,0      | 23,0      | 24,2        |
| 12         | 19,05             | 11,6       | 12,2        | 22,0        | 20,0        | 17,0      | 1,9       | 52,0      | 29,0      | 26,6        |
| 14         | 22,23             | 11,6       | 15,2        | 25,0        | 22,2        | 18,0      | 1,9       | 53,0      | 29,5      | 29,0        |
| 16         | 25,40             | 11,6       | 18,3        | 28,0        | 26,2        | 18,0      | 1,9       | 53,0      | 32,0      | 31,3        |
| 18         | 28,58             | 11,6       | 20,0        | 32,0        | 28,5        | 18,0      | 1,9       | 53,0      | 35,0      | 33,7        |
| 20         | 31,75             | 14,25      | 23,0        | 34,0        | 32,5        | 18,0      | 2,2       | 58,0      | 38,5      | 36,9        |
| 22         | 34,93             | 14,25      | 26,0        | 38,0        | 34,8        | 18,0      | 2,2       | 58,0      | 42,0      | 40,1        |
| 24         | 38,10             | 14,25      | 28,8        | 41,0        | 37,9        | 18,0      | 2,2       | 58,0      | 46,0      | 43,3        |

## STRAIGHT PLUG WITH GROUNDING CONTINUITY KPT6E/KPSE6E/KPTC6E... DZ

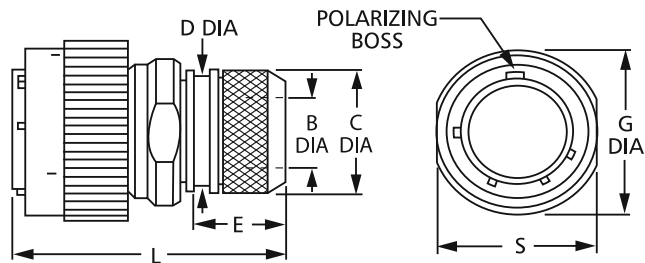

| Shell size | Ø B<br>min. | Ø C<br>+0,5 | Ø G<br>max. | Ø D<br>max. | E<br>1,0 | L<br>max. | S<br>+0,2 |
|------------|-------------|-------------|-------------|-------------|----------|-----------|-----------|
| 8          | 6,6         | 16,0        | 19,1        | 13,3        | 15,0     | 48,0      | 17,00     |
| 10         | 9,2         | 18,0        | 22,0        | 16,1        | 15,0     | 48,0      | 19,00     |
| 12         | 12,2        | 22,0        | 26,2        | 20,0        | 17,0     | 48,0      | 23,00     |
| 14         | 15,2        | 25,0        | 29,4        | 22,2        | 18,0     | 49,0      | 26,00     |
| 16         | 18,3        | 28,0        | 32,8        | 26,2        | 18,0     | 49,0      | 29,00     |
| 18         | 20,0        | 32,0        | 35,4        | 28,5        | 18,0     | 49,0      | 33,00     |
| 20         | 23,0        | 34,0        | 39,0        | 32,5        | 18,0     | 53,0      | 35,00     |
| 22         | 26,0        | 38,0        | 42,1        | 34,8        | 18,0     | 53,0      | 39,00     |
| 24         | 28,8        | 41,0        | 45,2        | 37,9        | 18,0     | 53,0      | 42,00     |



## JAM NUT RECEPTACLE WITH GROUNDING CONTINUITY (for shielded cable) KPT7E/KPSE7E/KPTC... DZ

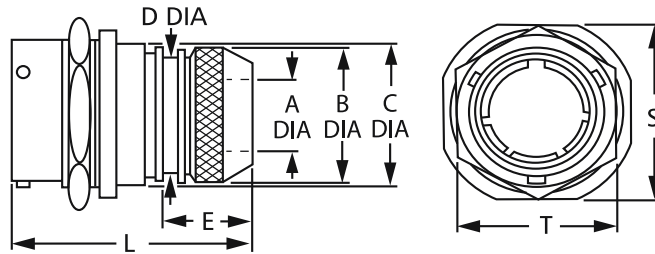

| Shell size | Ø A  | Ø B  | Ø C  | Ø D  | E    | L    | S     | T     |
|------------|------|------|------|------|------|------|-------|-------|
|            | min. | +0,5 | max. | max. | ±1,0 | max. | ±0,25 | ±0,25 |
| 8          | 6,6  | 16,0 | 18,2 | 13,3 | 15,0 | 47,0 | 23,0  | 19,0  |
| 10         | 9,2  | 18,0 | 21,4 | 16,1 | 15,0 | 47,0 | 27,0  | 22,2  |
| 12         | 12,2 | 22,0 | 24,6 | 20,0 | 17,0 | 49,0 | 31,7  | 27,0  |
| 14         | 15,2 | 25,0 | 27,8 | 22,2 | 18,0 | 50,0 | 34,9  | 30,2  |
| 16         | 18,3 | 28,0 | 30,9 | 26,2 | 18,0 | 50,0 | 38,1  | 33,3  |
| 18         | 20,0 | 32,0 | 34,1 | 28,5 | 18,0 | 50,0 | 41,3  | 36,5  |
| 20         | 23,0 | 34,0 | 38,1 | 32,5 | 18,0 | 55,0 | 46,0  | 39,7  |
| 22         | 26,0 | 38,0 | 41,3 | 34,8 | 18,0 | 55,0 | 49,2  | 42,9  |
| 24         | 28,8 | 41,0 | 44,4 | 37,9 | 18,0 | 55,0 | 52,3  | 46,0  |

## ASSEMBLY OF A CONNECTOR WITH A GROUND CONTINUITY BACKSHELL KPT/KPSE/KPTC... DZ

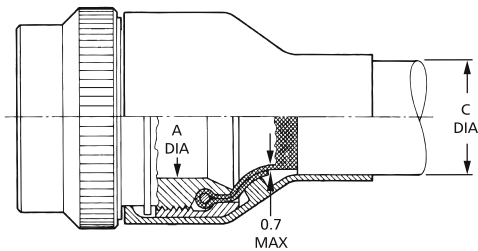

| Shell size | ØC   |
|------------|------|
|            | max. |
| 8          | 6,6  |
| 10         | 9,2  |
| 12         | 12,2 |
| 14         | 15,2 |
| 16         | 18,3 |
| 18         | 20,0 |
| 20         | 23,0 |
| 22         | 26,0 |
| 24         | 28,8 |

## BOX MOUNTING RECEPTACLE KPT2/KPTC2...EX OR EW

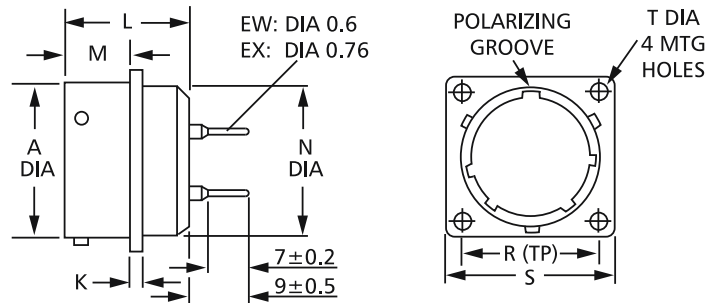

| Shell size | Ø A<br>+0,03-0,13 | K<br>±0,1 | L<br>max. | M<br>±0,15 | Ø N<br>max. | R<br>±0,15 | S<br>max. | Ø T<br>±0,15 |
|------------|-------------------|-----------|-----------|------------|-------------|------------|-----------|--------------|
| 8          | 12,00             | 1,9       | 21,1      | 11,60      | 11,1        | 15,1       | 21,0      | 3,05         |
| 10         | 15,00             | 1,9       | 21,1      | 11,60      | 14,3        | 18,3       | 24,2      | 3,05         |
| 12         | 19,05             | 1,9       | 21,1      | 11,60      | 17,5        | 20,6       | 26,6      | 3,05         |
| 14         | 22,23             | 1,9       | 21,1      | 11,60      | 20,6        | 23,0       | 29,0      | 3,05         |
| 16         | 25,40             | 1,9       | 21,1      | 11,60      | 23,8        | 24,6       | 31,3      | 3,05         |
| 18         | 28,58             | 1,9       | 21,1      | 11,60      | 27,0        | 27,0       | 33,7      | 3,05         |
| 20         | 31,75             | 2,2       | 22,7      | 14,25      | 30,2        | 29,4       | 36,9      | 3,05         |
| 22         | 34,93             | 2,2       | 22,7      | 14,25      | 33,4        | 31,7       | 40,1      | 3,05         |
| 24         | 38,10             | 2,2       | 22,7      | 15,10      | 36,5        | 34,9       | 43,3      | 3,75         |

## JAM NUT RECEPTACLES KPT7/KPTC7...EX OR EW

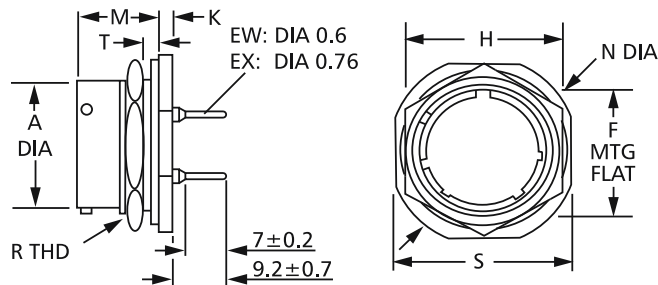

| Shell size | Ø A<br>+0,03-0,13 | F<br>±0,15 | H<br>±0,15 | K<br>±0,25 | M<br>±0,15 | R <sub>THD</sub><br>Thread Type 2A | S<br>±0,5 | T (Panel Thickness) |      | Ø N<br>max. |
|------------|-------------------|------------|------------|------------|------------|------------------------------------|-----------|---------------------|------|-------------|
|            |                   |            |            |            |            |                                    |           | min.                | max. |             |
| 8          | 12,0              | 13,3       | 19,0       | 3,2        | 17,7       | 9/16-24UNEF                        | 24,0      | 1,6                 | 3,5  | 28,0        |
| 10         | 15,0              | 16,5       | 22,2       | 3,2        | 17,7       | 11/16-24UNEF                       | 27,0      | 1,6                 | 3,5  | 31,0        |
| 12         | 19,1              | 20,6       | 27,0       | 3,2        | 17,7       | 7/8-20UNEF                         | 32,0      | 1,6                 | 3,5  | 36,0        |
| 14         | 22,2              | 23,8       | 30,2       | 3,2        | 17,7       | 1-20UNEF                           | 35,0      | 1,6                 | 3,5  | 39,0        |
| 16         | 25,4              | 26,9       | 33,3       | 3,2        | 17,7       | 1-1/8-18UNEF                       | 38,5      | 1,6                 | 3,5  | 42,0        |
| 18         | 28,6              | 30,1       | 36,5       | 3,2        | 17,7       | 1-1/4-18UNEF                       | 41,5      | 1,6                 | 3,5  | 45,0        |
| 20         | 31,8              | 33,3       | 39,7       | 4,0        | 22,5       | 1-3/8-18UNEF                       | 46,0      | 1,6                 | 6,5  | 50,0        |
| 22         | 34,9              | 36,5       | 42,9       | 4,0        | 22,5       | 1-1/2-18UNEF                       | 49,5      | 1,6                 | 6,5  | 55,0        |
| 24         | 38,1              | 39,6       | 46,0       | 4,0        | 23,3       | 1-5/8-18UNEF                       | 52,5      | 1,6                 | 6,5  | 57,0        |

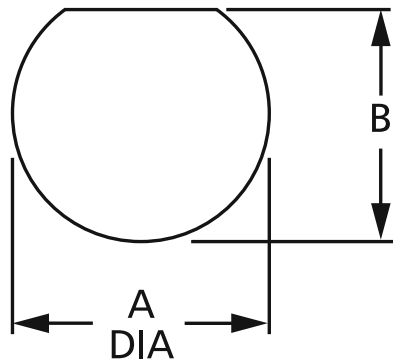
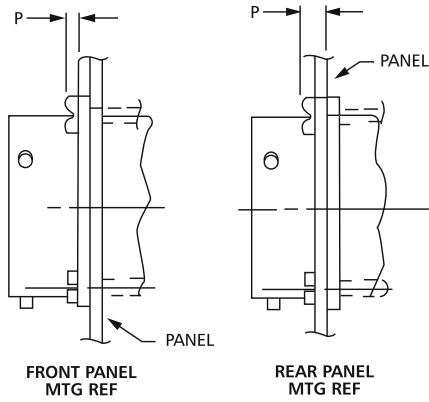
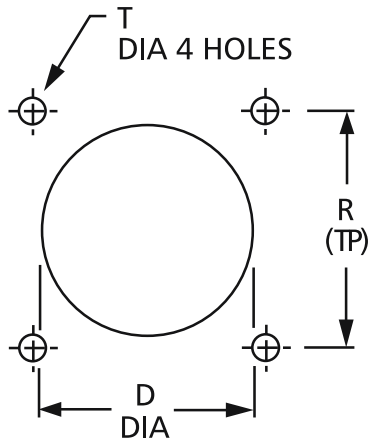

### BOX MOUNTING RECEPTACLE

| Shell size | For rear mounting       | For front mounting      |              |                      |
|------------|-------------------------|-------------------------|--------------|----------------------|
|            | $\varnothing D +0,25/0$ | $\varnothing D +0,25/0$ | $R \pm 0,15$ | $\varnothing T +0,3$ |
| 8          | 14,0                    | 12,7                    | 15,1         | 3,1                  |
| 10         | 17,0                    | 16,0                    | 18,3         | 3,1                  |
| 12         | 22,0                    | 19,0                    | 20,6         | 3,1                  |
| 14         | 25,0                    | 22,2                    | 23,0         | 3,1                  |
| 16         | 28,0                    | 25,5                    | 24,6         | 3,1                  |
| 18         | 31,0                    | 28,5                    | 27,0         | 3,1                  |
| 20         | 34,5                    | 31,7                    | 29,4         | 3,1                  |
| 22         | 37,5                    | 35,0                    | 31,8         | 3,1                  |
| 24         | 41,0                    | 38,0                    | 34,9         | 3,6                  |

### PANEL THICKNESS

| Shell size | P – Panel thickness           |
|------------|-------------------------------|
|            | Height of screw head included |
| 8          | 2,2                           |
| 10         | 2,2                           |
| 12         | 2,2                           |
| 14         | 2,2                           |
| 16         | 2,2                           |
| 18         | 2,2                           |
| 20         | 5,4                           |
| 22         | 5,4                           |
| 24         | 5,4                           |

### JAM NUT RECEPTACLE

| Shell size | KPT/KPSE                 | KPT/KPSE     |
|------------|--------------------------|--------------|
|            | $\varnothing A +0,25/-0$ | $B +0/-0,12$ |
| 8          | 14,5                     | 13,6         |
| 10         | 17,7                     | 16,8         |
| 12         | 22,7                     | 20,9         |
| 14         | 25,7                     | 24,1         |
| 16         | 28,8                     | 27,2         |
| 18         | 32,0                     | 30,4         |
| 20         | 35,1                     | 33,6         |
| 22         | 38,4                     | 36,8         |
| 24         | 41,5                     | 40,0         |

## PROTECTIVE CAPS KPT/KPSE/KPTC

| Material       |                             | Finishes       |                                  |
|----------------|-----------------------------|----------------|----------------------------------|
| Protective cap | Aluminum alloy              | A34            | Nickel                           |
| Sash chain     | Stainless steel             | A232           | Zinc cobalt, black               |
| Cord           | Polyamide                   | A233           | Zinc cobalt, green               |
| Ring           | Stainless steel             | A240           | Zinc Nickel plating              |
| Clip           | Aluminum alloy              | Standard (A66) | Olive drab chromate over cadmium |
| Gasket         | Fluor Silicone              |                |                                  |
| End link/rivet | Stainless steel, passivated |                |                                  |
| Bayonet pin    | Stainless steel, passivated |                |                                  |

## HOW TO ORDER

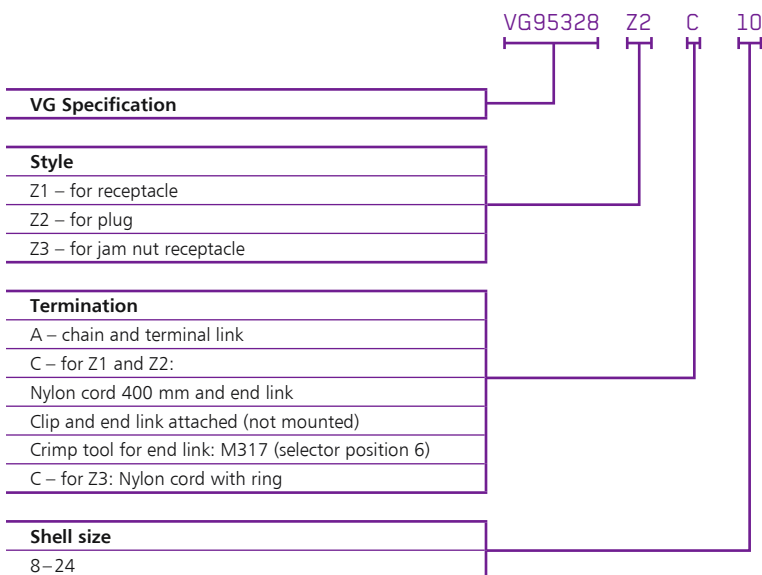
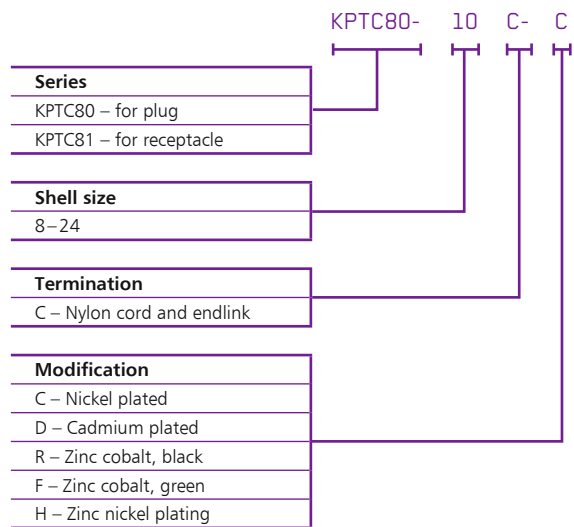
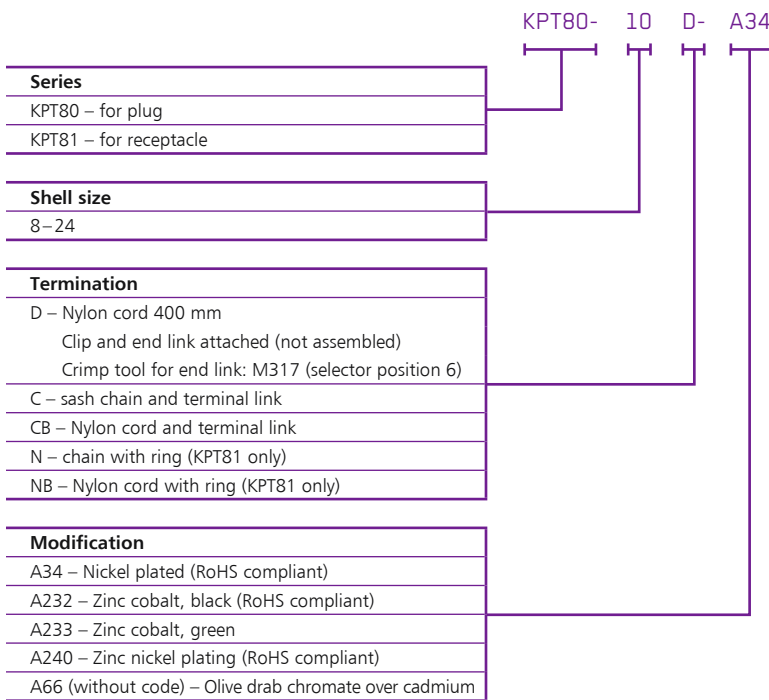

## PROTECTIVE CAPS KPT/KPSE/KPTC

### Cap with nylon cord

**For receptacle**  
KPT81 termination D  
VG95328 Z1 termination C

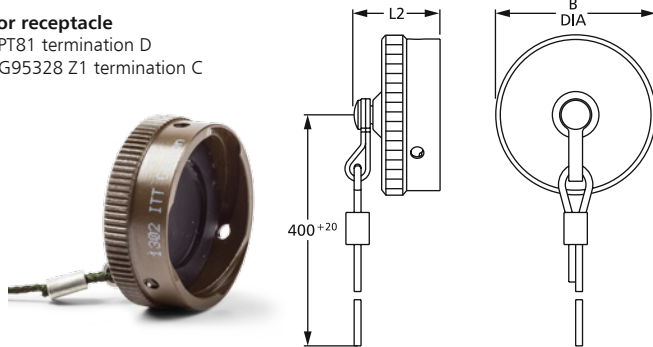

**For plug**  
KPT80 termination D  
VG95328 Z2 termination C

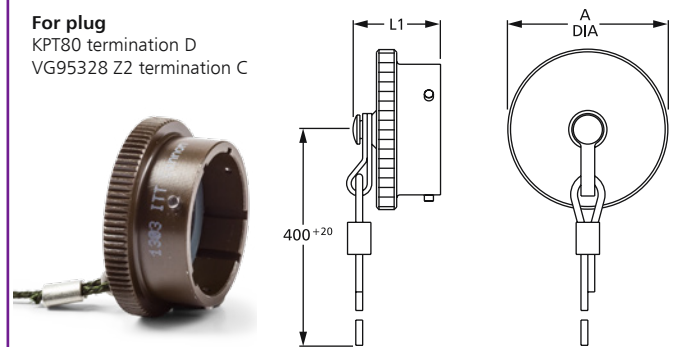

### Cap with nylon cord and terminal link

**For receptacle**  
KPT81 termination C and CB  
VG95328 Z1 termination A

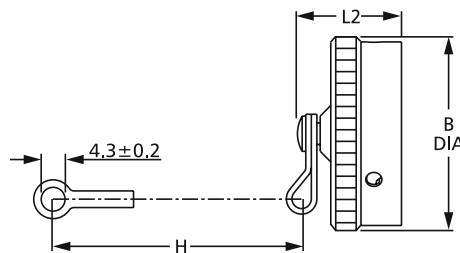

**For plug**  
KPT80 termination C and CB  
VG95328 Z2 termination A

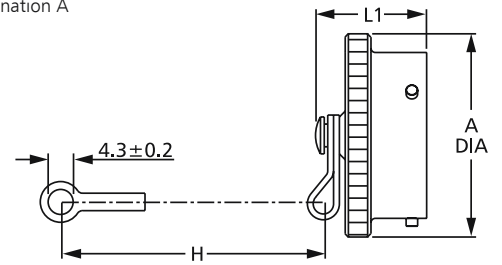

### Cap with nylon cord and ring

**For receptacle**  
KPT81 termination N and NB  
VG95328 Z3 termination C

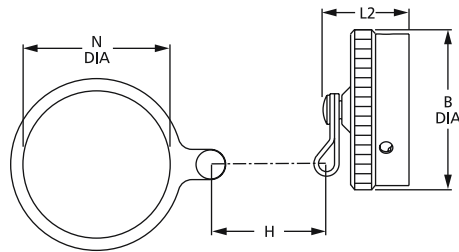

| Shell size | Ø A   | L <sub>1</sub> | Ø B  | L <sub>2</sub> | H    | Ø N  |
|------------|-------|----------------|------|----------------|------|------|
|            | max.  | max.           | max. | max.           | max. | ±0,5 |
| 8          | 18,26 | 19,84          | 18,0 | 21,44          | 76   | 14,7 |
| 10         | 21,44 | 19,84          | 20,3 | 21,44          | 76   | 17,9 |
| 12         | 25,40 | 19,84          | 25,1 | 21,44          | 89   | 22,6 |
| 14         | 28,58 | 19,84          | 28,2 | 21,44          | 89   | 25,8 |
| 16         | 31,75 | 19,84          | 31,5 | 21,44          | 89   | 29,0 |
| 18         | 34,92 | 19,84          | 34,5 | 21,44          | 89   | 32,2 |
| 20         | 38,10 | 21,44          | 37,8 | 21,44          | 101  | 35,3 |
| 22         | 41,28 | 21,44          | 40,9 | 21,44          | 101  | 38,5 |
| 24         | 44,45 | 22,22          | 44,2 | 22,22          | 101  | 41,7 |

**HOW TO ORDER**

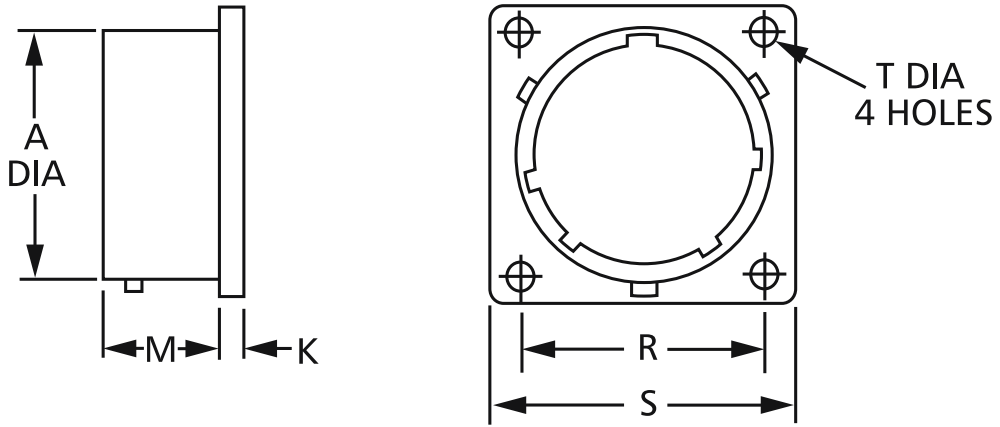
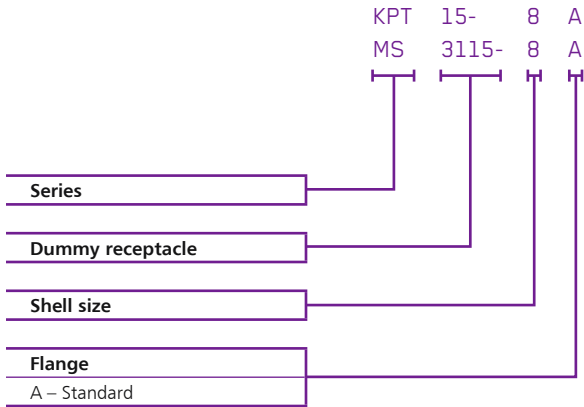

| Shell size | Ø A        | K    | M     | R     | S    | Ø T   |
|------------|------------|------|-------|-------|------|-------|
|            | +0,03-0,13 | ±0,4 | ±0,15 | ±0,15 | max. | ±0,15 |
| *8A        | 12,00      | 1,6  | 12,1  | 15,1  | 21,0 | 3,05  |
| *10A       | 15,00      | 1,6  | 12,1  | 18,3  | 24,2 | 3,05  |
| *12A       | 19,05      | 1,6  | 12,1  | 20,6  | 26,6 | 3,05  |
| *14A       | 22,23      | 1,6  | 12,1  | 23,0  | 29,0 | 3,05  |
| *16A       | 25,40      | 1,6  | 12,1  | 24,6  | 31,3 | 3,05  |
| *18A       | 28,58      | 1,6  | 12,1  | 27,0  | 33,7 | 3,05  |
| *20A       | 31,75      | 2,4  | 14,5  | 29,4  | 36,9 | 3,05  |
| *22A       | 34,93      | 2,4  | 14,5  | 31,8  | 40,1 | 3,05  |
| *24A       | 38,10      | 2,4  | 15,4  | 34,9  | 43,3 | 3,75  |

\* Add "KPT 15 -" or "MS 3115-" prefixes

## CROSS REFERENCE LIST KPT/KPSE/VG95328/MIL-C-26482

| Solder     |             |          | Crimp      |             |          |
|------------|-------------|----------|------------|-------------|----------|
| ITT Cannon | MIL-C-26482 | VG95328  | ITT Cannon | MIL-C-26482 | VG95328  |
| KPT00E     | MS3110E     |          | KPSE00E    | MS3120E     | VG95328A |
| KPT00F     | MS3110F     |          | KPSE00F    | MS3120F     | VG95328B |
| KPT0E-DN   |             |          | KPSE0E-DN  |             |          |
| KPT0E-DZ   |             |          | KPSE0E-DZ  |             | VG95328R |
| KPT01A     |             |          | KPSE01A    |             |          |
| KPT01E     | MS3111E     |          | KPSE01E    | MS3121E     |          |
| KPT01F     | MS3111F     |          | KPSE01F    | MS3121F     |          |
| KPT1E-DN   |             |          | KPSE1E-DN  |             |          |
| KPT1E-DZ   |             |          | KPSE1E-DZ  |             |          |
| KPT02E     | MS3112E     | VG95328H | KPSE02E    | MS3122E     | VG95328C |
| KPT06A     |             |          | KPSE06A    |             |          |
| KPT06E     | MS3116E     |          | KPSE06E    | MS3126E     |          |
| KPT06F     | MS3116F     |          | KPSE06F    | MS3126F     | VG95328K |
| KPT6E-DN   |             |          | KPSE6E-DN  |             | VG95328J |
| KPT6E-DZ   |             |          | KPSE6E-DZ  |             | VG95328M |
| KPT07A     |             |          | KPSE07A    |             |          |
| KPT07E     | MS3114E     |          | KPSE07E    | MS3124E     | VG95328D |
| KPT07F     | MS3114F     |          | KPSE07F    | MS3124F     | VG95328E |
| KPT7E-DN   |             |          | KPSE7E-DN  |             | VG95328S |
| KPT7E-DZ   |             |          | KPSE7E-DZ  |             | VG95328T |
| KPT08E     |             |          | KPSE08E    |             |          |
| KPT08F     |             |          | KPSE08F    |             |          |
| KPTB       | MS3119      | VG95328P |            |             |          |

## CROSS REFERENCE LIST PROTECTIVE CAPS KPT/VG95328/MIL-C-26482

| Part No.<br>ITT Cannon | Part No.<br>MIL-C-26482 | Part No.<br>VG95328 |
|------------------------|-------------------------|---------------------|
| KPT80                  | MS3180                  |                     |
| KPT80..C               |                         | Z2...VG95328        |
| KPT81                  | MS3181                  |                     |
| KPT81..C               |                         | Z1...VG95328        |
| KPT81..N               | MS3181..N               |                     |

## TOOLS AND ACCESSORIES KPT/KPSE/KPTC

### TOOLS



### KPSE/KPTC

| Tool            | Designation | Order reference | Locator*    | Order reference | Test gage  | Order reference |
|-----------------|-------------|-----------------|-------------|-----------------|------------|-----------------|
| Hand crimp tool | M22520/1-01 | 995-0001-585    | M22520/1-02 | 995-0001-736    | M22520/3-1 | 995-0001-684    |
| Crimp machine   | WA27F-CE    | 121586-5067     | M22520/1-02 | 995-0001-736    | M22520/3-1 | 995-0001-684    |
| Crimp machine   | HACS        | HACS            | -           | -               | -          | -               |

\* for contact sizes 20, 16, 12

### KPSE

| Contact size | Insertion tool | Order reference | Old designation | Extraction tool | Order reference | Extraction TIP |
|--------------|----------------|-----------------|-----------------|-----------------|-----------------|----------------|
| 20*          | -              | 038894-0018     | CIT-20-16       | MS2425R20       | 995-0001-965    | 317-7130-000   |
| 20**         | M24256A20      | 995-0001-950    | CIT-20-5A       | MS2425R20       | 995-0001-965    | 317-7130-000   |
| 16           | M24256A16      | 995-0001-951    | CIT-16-1        | MS2425R16       | 995-0001-964    | 317-7129-000   |
| 12           | M24256A12      | 995-0001-913    | -               | MS2425R12       | 995-0001-966    | 317-7131-000   |

\* without insulation support \*\* with insulation support

### KPTC

| Contact size | Insertion tool | Order ref.  | Insertion pliers | Order ref.  | Extraction tool | Extraction TIP  |
|--------------|----------------|-------------|------------------|-------------|-----------------|-----------------|
| 20           | CITG-20A       | 12086-3104  | CIT-KPTC-20      | 121086-3101 | CET-KPTC-20     | CET-KPTC-20-TIP |
| 16           | CIT-16         | 121086-3008 | CIT-F80-16       | 121086-0097 | CET-KPTC-16     | CET-KPTC-16-TIP |

### KPT14A4

| Contact type | Insertion tool | Order reference | Old designation | Extraction tool | Order reference | LN |
|--------------|----------------|-----------------|-----------------|-----------------|-----------------|----|
| Coaxial      | -              | -               | -               | CET-C6B         | 070064-0000     | -  |

## CONTACTS KPT/KPSE/KPTC/ VG95328

### KPSE/VG95328

| Contact size | Contact type                   | Contact order reference |                 |
|--------------|--------------------------------|-------------------------|-----------------|
|              |                                | KPSE version            | VG95328 version |
| 20           | Socket with insulation support | 031-8704-203            | 031-8704-203    |
|              | Pin with insulation support    | 430-8560-006            | 430-8560-006    |
| 16           | Socket                         | 031-8704-000            | 031-8704-000    |
|              | Pin                            | 430-8560-004            | 430-8560-004    |
| 12           | Socket                         | 031-8704-012            |                 |
|              | Pin                            | 430-8560-016            |                 |
|              | Grounding pin                  | 430-8560-020            |                 |

### KPTC

| Contact size | Order reference (hard gold plated) |
|--------------|------------------------------------|
| 20 Socket    | 031-8704-508                       |
| Pin          | 430-8560-404                       |
| 16 Socket    | 031-8704-502                       |
| Pin          | 430-8560-406                       |

### For shell size 8 and contact arrangements 12-14 only:

| Contact size | Order reference  |                    |
|--------------|------------------|--------------------|
|              | hard gold plated | hard silver plated |
| 20 Socket    | 031-8704-509     | 031-8704-506       |
| 20 Pin       | 430-8560-411     | 430-8560-410       |

### KPT14A4

|         |        |               |
|---------|--------|---------------|
| Coaxial | Pin    | DM 53740-5001 |
|         | Socket | DM 53742-5001 |

## WIRE HOLE FILLERS

### KPSE/KPTC

### KPSE/KPTC

| Contact size  | Colour code | MS         | Cannon       |
|---------------|-------------|------------|--------------|
| 20            | Red         | MS3187A20  | 225-1012-000 |
| 16            | Blue        | MS3187-16A | 225-1011-000 |
| 12*           | Yellow      | MS3187-12  | 225-0072-000 |
| Coaxial 14A4* | Yellow      | -          | 225-0018-000 |

\* KPSE only

## GASKETS KPT/KPSE/KPTC

### KPT/KPSE/KPTC

| Shell size | Alu-Flex     |                            | Shell size | Alu-Flex     |                            |
|------------|--------------|----------------------------|------------|--------------|----------------------------|
|            | conductive   | Chloroprene non conductive |            | conductive   | Chloroprene non conductive |
| 8          | 075-8543-000 | 075-8543-010               | 18         | 075-8543-005 | 075-8543-015               |
| 10         | 075-8543-001 | 075-8543-011               | 20         | 075-8543-006 | 075-8543-016               |
| 12         | 075-8543-002 | 075-8543-012               | 22         | 075-8543-007 | 075-8543-017               |
| 14         | 075-8543-003 | 075-8543-013               | 24         | 075-8543-008 | 075-8543-018               |
| 16         | 075-8543-004 | 075-8543-014               |            |              |                            |



## KPSE CONTACT AND SEALING PRINCIPLE

- High performance
- Crimp termination
- Closed entry socket contacts

Series KPSE environmental, miniature circular, quick disconnect connectors are designed for the extracting requirements of today's electronic industry.

They are intermateable, intermountable and interchangeable with all connectors manufactured according to MIL-C-26482, VG95328 and HE 301.

Connectors of Cannon series KPSE have obtained the VDE Expertise No. 63761.

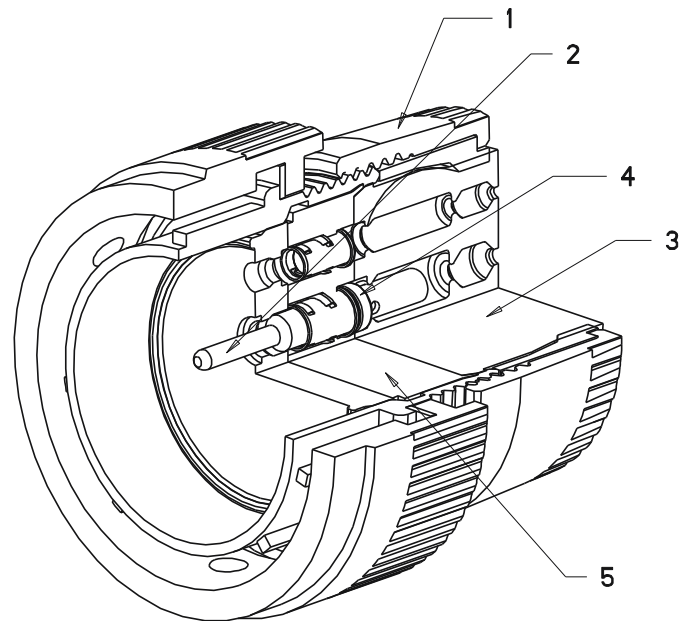

**1 Standard MIL-C-26482 or Hardware** mates with any connector designed to MIL-C-26482 and VG95328 model

**2 Crimp, snap-in contacts** are designed to SAE-AS-39029 and can be crimped with the standard M22520/1 crimp tool.

CLOSED-ENTRY SOCKET CONTACTS eliminate damage from abuse by test probes and help to correct any misaligned pins during engagement.

CONTACT INSERTION is accomplished from the rear of the connector. When the contact is fully inserted, the clip tines snap securely behind the contact shoulder.

CONTACT EXTRACTION is accomplished with a front-inserted extraction tool. Pressing the tool plunger pushes the contact out through the rear of the connector.

**3 Monobloc insulator** does not leave any access to moisture and avoids interfacial empty space.

**4 Contact retention**  
RETAINING CLIP: completely encased in a tough plastic wafer to protect the clip from damage  
PLASTIC WAFER: latest version for easier and faster assembly and disassembly of contacts (used on selected layouts)

**Complete moisture sealing** is achieved by combining four seals: shell, peripheral, interfacial and wire seals.

SHELL SEAL is effected when the plug shell pushes against the sealing ring in the receptacle when the connectors are mated.

PERIPHERAL SEAL around the edge of the pin insulator is designed so that mating the connector puts tension on the seal and greatly reduces compression set.

INTERFACIAL SEAL is achieved by the insulator faces meeting when the plug and receptacle are mated.

WIRE SEAL is accomplished by a multiple ripple design, exceeding the wire sealing requirements of MIL-C-26482.

**5 Positive insert-to-shell mechanical retention** with hard plastic wafer firmly locked into a groove in the shell, in addition to a strong adhesive bond between the insert and shell.

## PRODUCT SAFETY INFORMATION

### 1. MATERIAL CONTENT AND PHYSICAL FORM

Electrical connectors do not usually contain hazardous materials. They contain conducting and non-conducting materials and can be divided into two groups.

a) Printed circuit types and low cost audio types which employ all plastic insulators and casings.

b) Rugged, Fire Barrier and High Reliability types with metal casings and either natural rubber, synthetic rubber, plastic or glass insulating materials. Contact materials vary with type of connector and also application and are usually manufactured from either: Copper, copper alloys, nickel, alumel, chromel or steel. In special applications, other alloys may be specified.

## CAUTION

### 2. FIRE CHARACTERISTICS AND ELECTRIC SHOCK HAZARD

There is no fire hazard when the connector is correctly wired and used within the specified parameters.

Incorrect wiring or assembly of the connector or careless use of metal tools or conductive fluids, or transit damage to any of the component parts may cause electric shock or burns. Live circuits must not be broken by separating mated connectors as this may cause arcing, ionization and burning. Heat dissipation is greater at maximum resistance in a circuit. Hot spots may occur when resistance is raised locally by damage, e.g. cracked or deformed contacts, broken strands of wire. Local overheating may also result from the use of the incorrect application tools or from poor quality soldering or slack screw terminals. Overheating may occur if the ratings in the product Data Sheet/Catalog are exceeded and can cause breakdown of insulation and hence electric shock. If heating is allowed to continue it intensifies by further increasing the local resistance through loss of temper of spring contacts, formation of oxide film on contacts and wires and leakage currents through carbonization of insulation and tracking paths. Fire can then result in the presence of combustible materials and this may release noxious fumes. Overheating may not be visually apparent. Burns may result from touching overheated components.

### 3. HANDLING

Care must be taken to avoid damage to any component parts of electrical connectors during installation and use. Although there are normally no sharp edges, care must be taken when handling certain components to avoid injury to fingers.

Electrical connectors may be damaged in transit to the customers, and damage may result in creation of hazards. Products should therefore be examined prior to installation/use and rejected if found to be damaged.

### 4. DISPOSAL

Incineration of certain materials may release noxious or even toxic fumes.

### 5. APPLICATION

Connectors with exposed contacts should not be selected for use on the current supply side of an electrical circuit, because an electric shock could result from touching exposed contacts on an unmated connector. Voltages in excess of 30V ac or 42.5V DC are potentially hazardous and care should be taken to ensure that such voltages cannot be transmitted in any way to exposed metal parts of the connector body. The connector and wiring should be checked, before making live, to have no damage to metal parts or insulators, no solder blobs, loose strands, conducting lubricants, swarf, or any other undesired conducting particles. Circuit resistance and continuity check should be made to make certain that there are no high resistance joints or spurious conducting paths. Always use the correct application tools as specified in the Data Sheet/Catalog. Do not permit untrained personnel to wire, assemble or tamper with connectors. For operation voltage please see appropriate national regulations.

### IMPORTANT GENERAL INFORMATION

(i) **Air and creepage paths/Operating voltage.** The admissible operating voltages depend on the individual applications and the valid national and other applicable safety regulations. For this reason the air and creepage path data are only reference values. Observe reduction of air and creepage paths due to PC board and/or harnessing.

#### (ii) Temperature

All information given are temperature limits. The operation temperature depends on the individual application.

#### (iii) Other important information

Cannon continuously endeavors to improve their products. Therefore, Cannon products may deviate from the description, technical data and shape as shown in this catalog and data sheets.

ITT's Interconnect Solutions, is a division of ITT Corporation who manufactures the highest quality products available in the marketplace; however these products are

intended to be used in accordance with the specifications in this publication. Any use or application that deviates from the stated operating specifications is not recommended and may be unsafe. No information and data contained in this publication shall be construed to create any liability on the part of Cannon. Any new issue of this publication shall automatically invalidate and supersede any and all previous issues.

### Product Warranty

A limited warranty applies to Cannon products. In general, except for obligations assumed by Cannon under this warranty, Cannon shall not be liable for any loss, damage, cost of repairs, incidental or consequential damages of any kind, whether or not based on express or implied warranty, contract, negligence or strict liability arising in connection with the design, manufacture, sale, use or repair of the products. Product availability, prices and delivery dates are exclusively subject to our respective order confirmation form; the same applies to orders based on development samples delivered. Please refer to [www.ittcannon.com](http://www.ittcannon.com) (General Terms of Sale) for the complete text of Cannon's applicable Terms and Conditions, including Warranty.

This publication is not to be construed as an offer. It is intended merely as an invitation to make an offer. By this publication, Cannon does not assume responsibility or any liability for any patent infringements or other rights of third parties which may result from its use.

Reprinting this publication is generally permitted, indicating the source. However, Cannon's prior consent must be obtained in all cases. "Engineered for life" is a registered trademark of ITT Corporation ©2012. All other trademarks or registered trademarks are property of their respective owners. All data subject to change without notice.

This document does not contain technical data whose export is restricted by the Arms Export Control Act (Title 22, U.S.C., App 2401 et. Seq.)



## Circular/Filter/Hermetic/Fiber Optic Connectors

As a world leader in circular, filter, and hermetic connectors, ITT can leverage its design and manufacturing expertise to fit virtually any application. Our expertise includes fast positive mating for a wide range of military applications, as well as numerous sizes and contact configurations for various harsh environments. Our wide variety of fiber optic products include hybrid contacts, multi-channel, rack and panel, and hi-rel assemblies, including MIL and ARINC standard solutions that meet numerous specifications, including NATO and MIL standards.



## D-Subminiature Connectors

Cannon invented D-sub connectors in 1952. Our family of D-Subs now includes combinations of signal, power and RF, as well as severe service sealed connectors. Cannon D-Subs are available with an extensive line of backshells and accessories and are one of the most economical shielded connector solutions available. ITT D-Sub connectors are qualified to the MIL-DTL-24308 specification.



## Microminiature Connectors

Developed first by Cannon in the 1960's, ITT's Interconnect Solutions microminiature connectors offer high performance and reliability with exceptional versatility. Available in rectangular, circular, and strip configurations for countless applications, many of our connectors meet or exceed applicable requirements of the MIL-DTL-83513 specification.



## Rack and Panel Connectors

Initially pioneered by Cannon during the 1930s, ITT's Interconnect Solutions is the world leader in rack and panel connectors, offering unmatched variety of shell configurations and insert arrangements, materials, plating, and contact options. Many of our standard and custom designs meet the stringent requirements of ARINC 600, ARINC 404 (MIL-C-81659), and MIL-DTL-83733 standards.



## Trident

Cannon's Trident Connector System is a versatile range of electrical connectors based on a standard contact design. These contacts are fully interchangeable throughout the Trident Connector System. The connector options include low cost rectangular, rack and panel, industrial grade circulars, harsh environment circulars and shielded circulars.



## Transportation

The ITT's Interconnect Solutions includes sealed circular and rectangular connectors in metal or plastic shells. These configurations include board to cable or cable to cable/bulkhead applications. Both signal and power contacts can be combined in various layouts. All product lines within the Transportation segment offer very low contact resistance providing maximum signal integrity.



ITT's Interconnect Solutions is an international manufacturer and supplier of connectors including circular, rectangular, fiber optic, RF, power and high voltage, audio, PMCIA, Compact Flash Card, enclosures, cable assemblies, and application specific custom solutions. The Interconnect Solutions portfolio includes the brands Cannon, VEAM, and BIW Connector Systems. As a worldwide leader in connector technology for nearly a century, ITT offers one of the broadest product offerings, six sigma manufacturing capability, Value Based Product Development with exceptional engineering capability, and an extensive sales, distribution, and customer support network.



**ITT Interconnect Solutions**  
Cannon, VEAM,  
BIW Connector Systems

Visit our website at  
[www.ittcannon.com](http://www.ittcannon.com)



**Global Design & Manufacturing**

**Customer Support**

**North America**

**MEXICO – Cannon, VEAM**  
Av. Libre Comercio s/n-  
entre Calzada Industrial  
Nuevo Nogales y Calzada del Raquet Club,  
Parque Industrial Nuevo Nogales  
phone: +52.631.3110050  
fax: +52.631.3110060

**USA – Cannon**  
666 East Dyer Road  
Santa Ana, CA 92705  
toll free: +1.800.854.3028  
phone: +1.714.557.4700  
fax: +1.714.628.2142

**USA – BIW Connector Systems**  
500 Tesconi Circle  
Santa Rosa, CA 95401  
phone: +1.707.523.2300  
fax: +1.707.523.3567

**USA - VEAM**  
100 New Wood Road  
Watertown, CT 06795  
phone: +1.860.274.9681  
fax: +1.860.274.4963

**Europe & Middle East**

**FRANCE – Cannon, VEAM**  
15, Boulevard Robert Thiboust  
Serris, France 77700  
phone: +33.1.60.04.93.93  
fax: +33.1.60.04.93.90

**GERMANY – Cannon, VEAM**  
Cannonstrasse 1  
71384 Weinstadt  
phone: +49.7151.699.0  
fax: +49.7151.699.217

**ITALY – VEAM**  
Corso Europa 41/43  
Lainate (MI), Italy 20020  
phone: +39.02938721  
fax: +39.0293872300

**LEBANON – BIW Connector Systems**  
P.O. Box 199  
Jounieh  
Lebanon  
phone: +961.9.911.560  
fax: +961.9.912.126

**UK – Cannon, VEAM**  
Jays Close, Viabes Estate  
Basingstoke, RG22 4BA  
phone: +44.1256.311200  
fax: +44.1256.323356

**Asia**

**CHINA – Cannon, VEAM**  
Tuopandun Industrial Area,  
Jinda Cheng, Xiner Village, Shajing Town,  
Boan District, Shenzhen City,  
Guangdong Province, China 518125  
phone: +86.755.2726.7238  
fax: +86.755.2726.7515

**HONG KONG – Cannon, VEAM**  
Units 2405-6, 24/F, ING Tower  
308 Des Voeux Road Central  
Hong Kong  
phone: +852.2732.2720  
fax: +852.2732.2919

**INDIA – Cannon, VEAM**  
ITT Corporation India Pvt Ltd  
Money Chamber, Unit No. 202  
#6, KH Road, Bangalore  
560027  
phone: +91 22 67843000  
fax: +91 22 26783033

**JAPAN – Cannon, VEAM**  
5-11-3, Hibarigaoka,  
Zama-shi, Kanagawa, Japan 252-0003  
phone: +81.462.57.2010  
fax: +81.462.57.1680

**SINGAPORE – Cannon, VEAM**  
10 Jalan Kilang #06-01  
Singapore 159410  
phone: +65.62763693 ext 232  
fax: +65.62763685



**ITT**

**ENGINEERED FOR LIFE**

© 2013 ITT Corporation "Engineered for life" and "Cannon" are registered trademarks of ITT Corporation. Specification and other data are based on information available at the time of printing, and are subject to change without notice.

## X-ON Electronics

Largest Supplier of Electrical and Electronic Components

*Click to view similar products for ITT manufacturer:*

Other Similar products are found below :

[BKAF3-68102-25](#) [CA02COME22-22SBF80](#) [BKAD2-234-30001](#) [CB0-24-10SSA232](#) [MDM-31PSF](#) [110238-0195](#) [DAMN-7H2SN-A197](#)  
[MDM21SH003M7](#) [MS3100F24-11PW](#) [MS3100E2410SZ](#) [MS3100F24-10SZ](#) [MS3100F24-11P](#) [BKAC2-313-32201](#) [MS3100E2411P](#)  
[MS3100E2411PW](#) [MS3100E2411PX](#) [MS3100E2411PY](#) [MS3100E2411PZ](#) [MS3100F2411PX](#) [MS3100F2411PY](#) [MS3100F2411PZ](#)  
[MS3106F2422SY](#) [MS3106E24-22SY](#) [MS3100F2422PW](#) [MS3100F2422PX](#) [MS3106E24-22SX](#) [MS3106E24-10S](#) [MS3100F2422SW](#)  
[MS3100F2422SY](#) [MS3100F2422SX](#) [MS3100E2422PW](#) [MS3100E2422PX](#) [MS3100E2422PY](#) [MS3100F2422PY](#) [CA3102R32-15PK10](#)  
[MS3100F2428SX](#) [MS3100F2428SY](#) [MS3100F24-28SZ](#) [MS3100F24-28PW](#) [MS3106E2428PZ](#) [MS3106F24-28SZ](#) [MS3106E2428PW](#)  
[MS3100F24-28SW](#) [MS3106E2428SX](#) [BKAD3-A713-30001](#) [BKAD3-626-30001](#) [BKAC3-626-30001](#) [BKAD3-A713-30017](#) [BKAD3-537-](#)  
[30001](#) [MDM51PH001BA174](#)