

STRAIGHT PLUG FULL CRIMP

R142.079.77_

CABLE 1/4.8

Series : **BNC 75 HDTV**

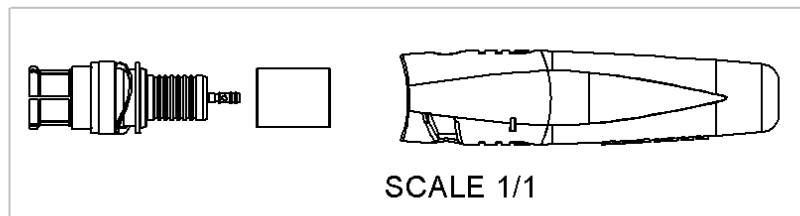
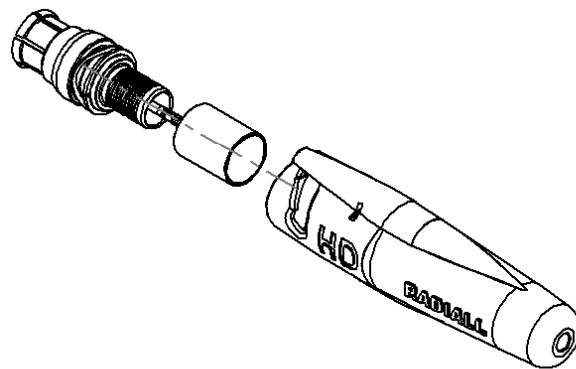
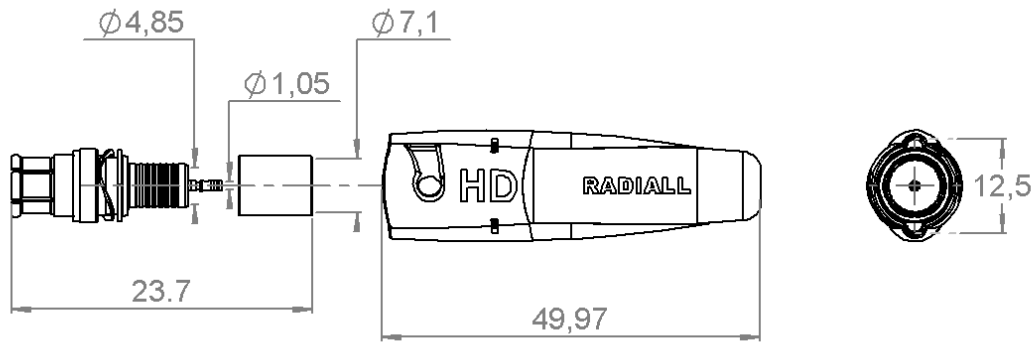

All dimensions are in mm.

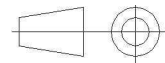

COMPONENTS	MATERIALS	PLATING (µm)
BODY	BRASS	BBR2
CENTER CONTACT	BRASS	NPGR
OUTER CONTACT	BRASS	NPGR
INSULATOR	POLYPROPYLENE	
GASKET	SILICONE RUBBER	
OTHERS PARTS	COMPOSITE MATERIAL	
-	-	-
-	-	-

Issue : 1306 E

In the effort to improve our products, we reserve the right to make changes judged to be necessary.



STRAIGHT PLUG FULL CRIMP

R142.079.77_

CABLE 1/4.8

Series : **BNC 75 HDTV**

PACKAGING

Standard	Unit	Other
100	'W' option	Contact us

SPECIFICATION

ELECTRICAL CHARACTERISTICS

Impedance		75 Ω
Frequency		DC-6 GHz
VSWR	1.05 +	0,0350 x F(GHz) Maxi
Insertion loss		0.1 √F(GHz) dB Maxi
RF leakage	- (NA - F(GHz)) dB Maxi
Voltage rating		1000 Veff Maxi
Dielectric withstanding voltage		1500 Veff mini
Insulation resistance		5000 MΩ mini

CABLE ASSEMBLY

Stripping	a	b	c	d	e	f
mm	2,30	10,0	18,3	0,00	15,9	0,00

Assembly instruction : **Specifique**

Recommended cable(s)
BELDEN 1694A
CAE 10460

Characteristics indicated on this data sheet are those that can be achieved with the highest performance cable. Intrinsic limitations of the cable may diminish the performance of the assembly

Cable retention

- pull off **220** N mini
 - torque **N.A** N.cm

MECHANICAL CHARACTERISTICS

Center contact retention		
Axial force – Mating end	10	N mini
Axial force – Opposite end	10	N mini
Torque	N.A	N.cm mini

TOOLING

Retention		
Mated	200	N max
Boot Nut on the body	40	N max

Part Number	Description	Hexagon
.	.	.
R282.232.000	CRIMPING TOOL	Hex 6.7 / Sq 1.1

OTHER CHARACTERISTICS

Mating life	1000	Cycles mini
Weight	7,3200	g

ENVIRONMENTAL

Operating temperature	-40+85	° C
Hermetic seal		Atm.cm3/s
Panel leakage		

Issue : **1306** E

In the effort to improve our products, we reserve the right to make changes judged to be necessary.



STRAIGHT PLUG FULL CRIMP

CABLE 1/4.8

R142.079.77_

Series : **BNC 75 HDTV**

CODING OPTION SLEEVE-NUT

Choice for sleeve Colors :

Colours name	RAL	RVB (octet)	TLS	REF
Black	9005	0/0/0	0/0/0	R142.079.770
Red	3020	252/10/28	356/131/249	R142.079.771
Yellow	1018	255/255/79	60/167/255	R142.079.774
Blue	5012	41/115/184	209/113/162	R142.079.773
Green	6032	41/138/64	134/90/138	R142.079.772
Grey	7037	122/125/128	210/125/6	R142.079.775
White	9003	255/255/255	0/255/0	R142.079.776
Brown	8002	110/59/58	1/84/79	R142.079.777
Orange	2007	255/117/33	23/144/255	R142.079.778
Violet	4008	125/31/122	302/78/154	R142.079.779



Issue : 1306 E

In the effort to improve our products, we reserve the right to make changes judged to be necessary.



STRAIGHT PLUG FULL CRIMP

R142.079.77_

CABLE 1/4.8

Series : BNC 75 HDTV

ASSEMBLING PROCESS

STRIPPING DIMENSIONS

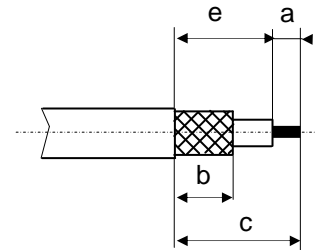
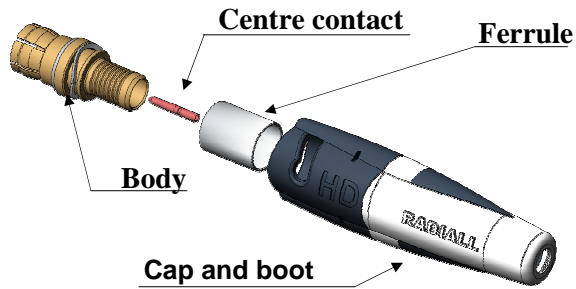

1

Slide the cap and boot onto the cable
Strip the cable.
Slide the ferrule onto the cable.

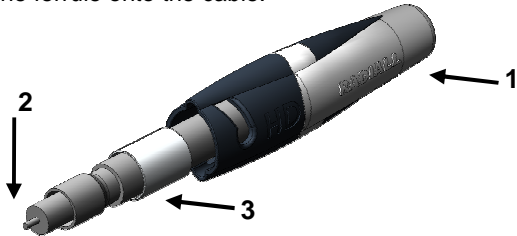

4

Slide the body onto the cable until it bottoms against insulator.

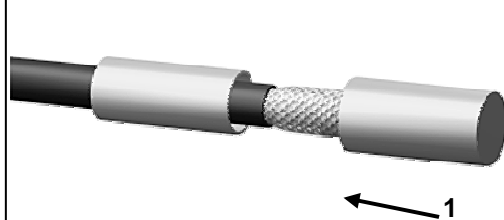

2

Slide the centre contact on until it bottoms against the cable dielectric.
Crimp the centre contact with crimping tool (Sq. : 1.1)

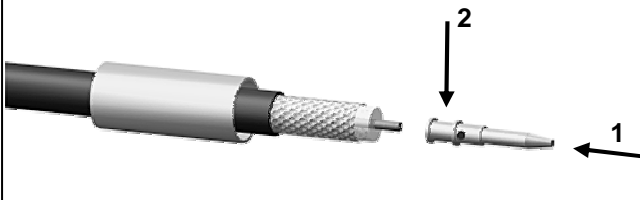

5

Slide the ferrule over the braid.
Crimp the ferrule with crimping tool. (Hex. : 6.70)
Cut the excess of braid if necessary

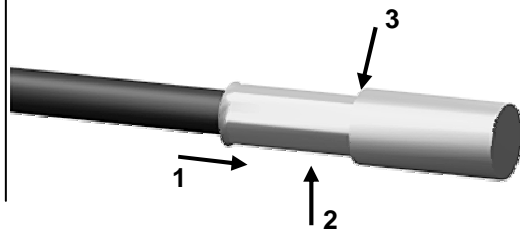

3

Fan the braid and foil.

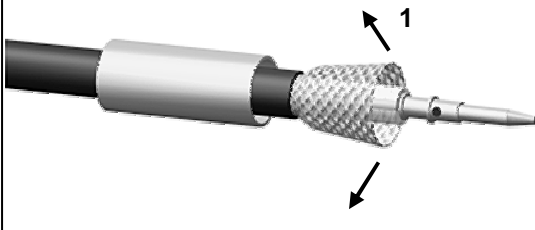

6

Twist , slide and lock the Sleeve-nut over the sub assembly

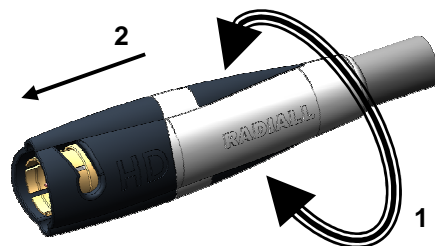

Issue : 1306

E

In the effort to improve our products, we reserve the right to make changes judged to be necessary.



X-ON Electronics

Largest Supplier of Electrical and Electronic Components

Click to view similar products for [RF Connectors / Coaxial Connectors](#) category:

Click to view products by [Radiall](#) manufacturer:

Other Similar products are found below :

[R125315120](#) [8915-1511-000](#) [89674-0827](#) [5916-1103-603](#) [0106-001-000](#) [6-0001-3](#) [6001-7071-019](#) [6002-7051-003](#) [6002-7551-202](#) [6059674-1](#) [619550-1](#) [630059-000](#) [M39012/25-0021](#) [M39012/79-3008](#) [M39030/3-01N](#) [M39030/3-03N](#) [M3933/25-36N](#) [6500-7071-046](#) [6501-1071-002](#) [M83723/72W2457N](#) [6769](#) [CX050L2AQ](#) [7002-1541-010](#) [7002-1572-002](#) [7003-1572-002](#) [7004-1512-000](#) [7009-1511-004](#) [7010-1511-000](#) [7029-1511-060](#) [7101-1541-010](#) [7101-1571-002](#) [7105-1521-002](#) [7145-1521-002](#) [7209-1511-011](#) [7210-1511-012](#) [7210-1511-015](#) [7210-1511-019](#) [7210-1511-040](#) [7225-1512-050](#) [7242-1511-000](#) [73137-5015](#) [73251-0111](#) [73251-0672](#) [73276-1501](#) [73366-0013](#) [73404-2300](#) [73413-6080](#) [734151610](#) [73415-5721](#) [7405-1521-005](#)