



selos / fasis

**DIN Rail Terminal Blocks with
Screw, Tension Spring and
Push-In Connection Technologies
Catalog 2013**





▲ Sales and Marketing Center in Bamberg



▲ Company headquarters in Bamberg



▲ STOCKO main plant in Wuppertal

wieland group

ACTIVE WORLDWIDE

The Wieland Group employs more than 2,000 people all around the globe. With some 15 locations and subsidiaries, and sales partners in more than 70 countries, Wieland Holding is present in nearly all important key markets worldwide.

Always with a clear commitment to the German location where most of the products are still manufactured.



- **automation**
- **building**
- **electronics**

The group makes us strong

Wieland Holding is based in Bamberg, Bavaria, and comprises two independently acting subsidiaries: Wieland Electric and STOCKO Contact.

Groundbreaking innovations made Wieland Electric one of the leading suppliers of electrical connection technology. This company, founded in Bamberg in 1910, is the largest subsidiary of Wieland Holding.

STOCKO Contact is based in Wuppertal and joined the Wieland Group in 2001. Stocko has also more than 100 years of company history to its credit and is one of the largest manufacturers of connector systems and crimp contacts.



Established in industries

Control cabinet engineering, industrial automation, building system technology – our large product portfolio provides solutions for all kinds of applications.

From innovative interface and network technology to terminal blocks to "safety first" – with modular system solutions and safety components. With Wieland products in your control cabinet, you are always on the safe side.

Energy bus systems for distributed automation or indoor and outdoor field

bus components – Wieland technology can be found everywhere, and in all kinds of applications.

In building system technology, Wieland Electric is the world market leader in pluggable electrical installation.

There are good reasons why our system solutions can be found in the most spectacular building projects worldwide. When it comes to electronic networking, Wieland leads the way to the "smart home".

Welcome Future

Wieland Electric is 100 years young, and full of innovative energy. And our commitment for the future is not only to find constantly new system solutions for our customers but also social responsibility.

Environmentally friendly high-tech products, manufactured to the latest production standards, an audited environmental management system and substantial investments in our locations are all part to this concept.

Global commitment and sustainable regional action – Wieland Electric is fit for the future: Contacts are green.



Wieland DIN Rail Terminal Blocks – Overview

DIN rail terminal blocks with screw connection



Feed-through blocks
starting at page 12



Ground blocks
starting at page 16



Duo feed-through blocks
starting at page 20

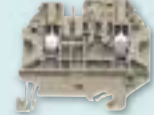

Knife edge
disconnect blocks
starting at page 20+31

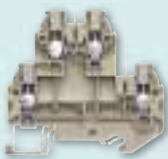

Multi-tier blocks
starting at page 22



Initiator blocks
starting at page 26



Fuse blocks
starting at page 28



DIN rail terminal blocks
with plug-in connection
starting at page 34



Function blocks
starting at page 24 + 38



Instrument isolating
terminals
starting at page 40



DIN rail terminal blocks
with ring lug connection
starting at page 45



High current terminal blocks
starting at page 46

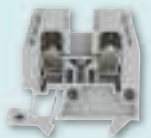

Mini blocks
starting at page 50



selos CLASSIC
starting at page 52

DIN rail terminal blocks with push-in connection

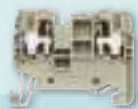

Feed-through blocks
starting at page 114

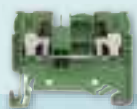

Ground blocks
starting at page 116

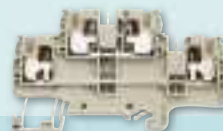

Duo feed-through blocks
starting at page 118

DIN rail terminal blocks with tension spring connection



Feed-through blocks
starting at page 62



Ground blocks
starting at page 72



Duo feed-through blocks
starting at page 78

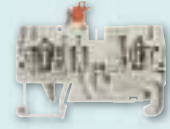

Knife edge disconnect blocks
starting at page 88

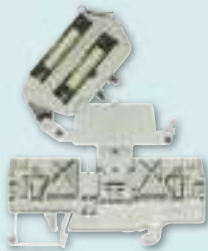

Fuse blocks
starting at page 90



DIN rail terminal blocks with plug-in connection
starting at page 94



Initiator blocks
starting at page 100

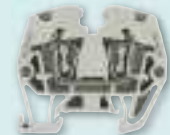

Mini blocks
starting at page 104

Accessories, software and service



Accessories
starting at page 120



Software
starting at page 138



Service, Facts & Data
starting at page 139



Wieland DIN Rail Terminal Blocks – One System

3 product families, 3 connection technologies – our DIN rail terminal block program is the right choice for every installation, wherever the control cabinet is found-in machinery or plant engineering, energy technology or building installation, or with screw, tension spring or push-in connection.

The ultimately flexible DIN rail terminal block systems **selos** and **fasis** offer optimum handling and harmonized accessories. This guarantees not only fast wiring time, but also reduces cost of inventory at your facility and in the supply chain.

Customized assembly service, customer-specific solutions and a comprehensive service portfolio match our products individually with the requirements of our customers.

DIN rail terminal blocks with screw connection – **selos**

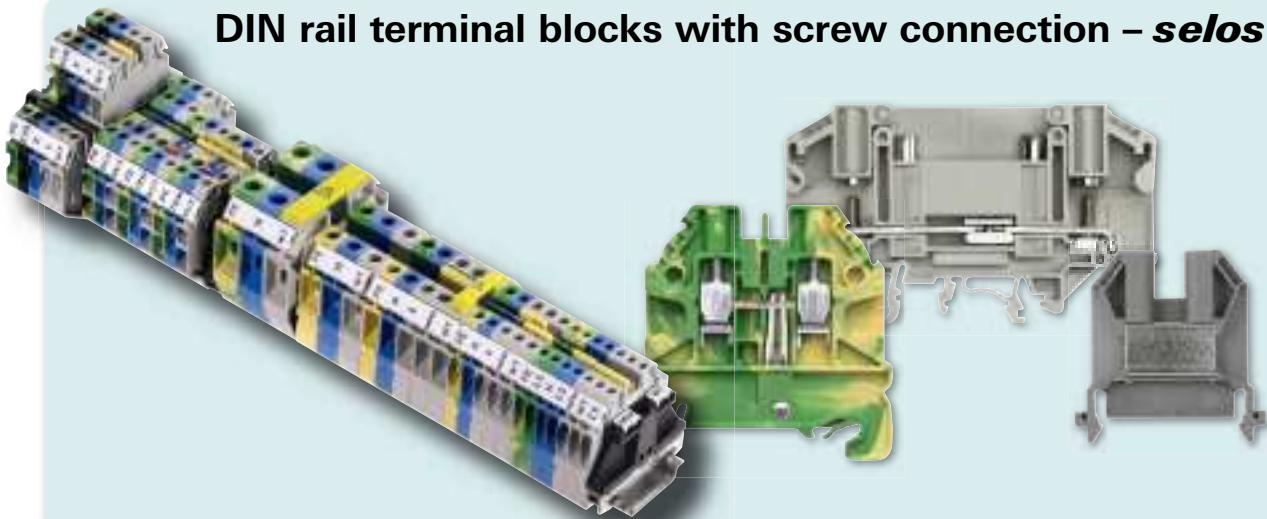

DIN rail terminal blocks with push-in connection – **fasis** WTP



- Many Possibilities

DIN rail terminal blocks with tension spring connection
- **fasis** WKFN

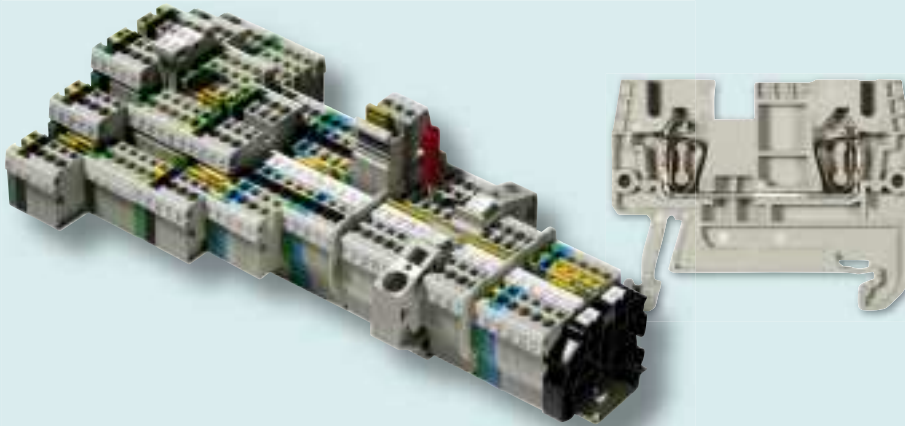

Accessories, software and service



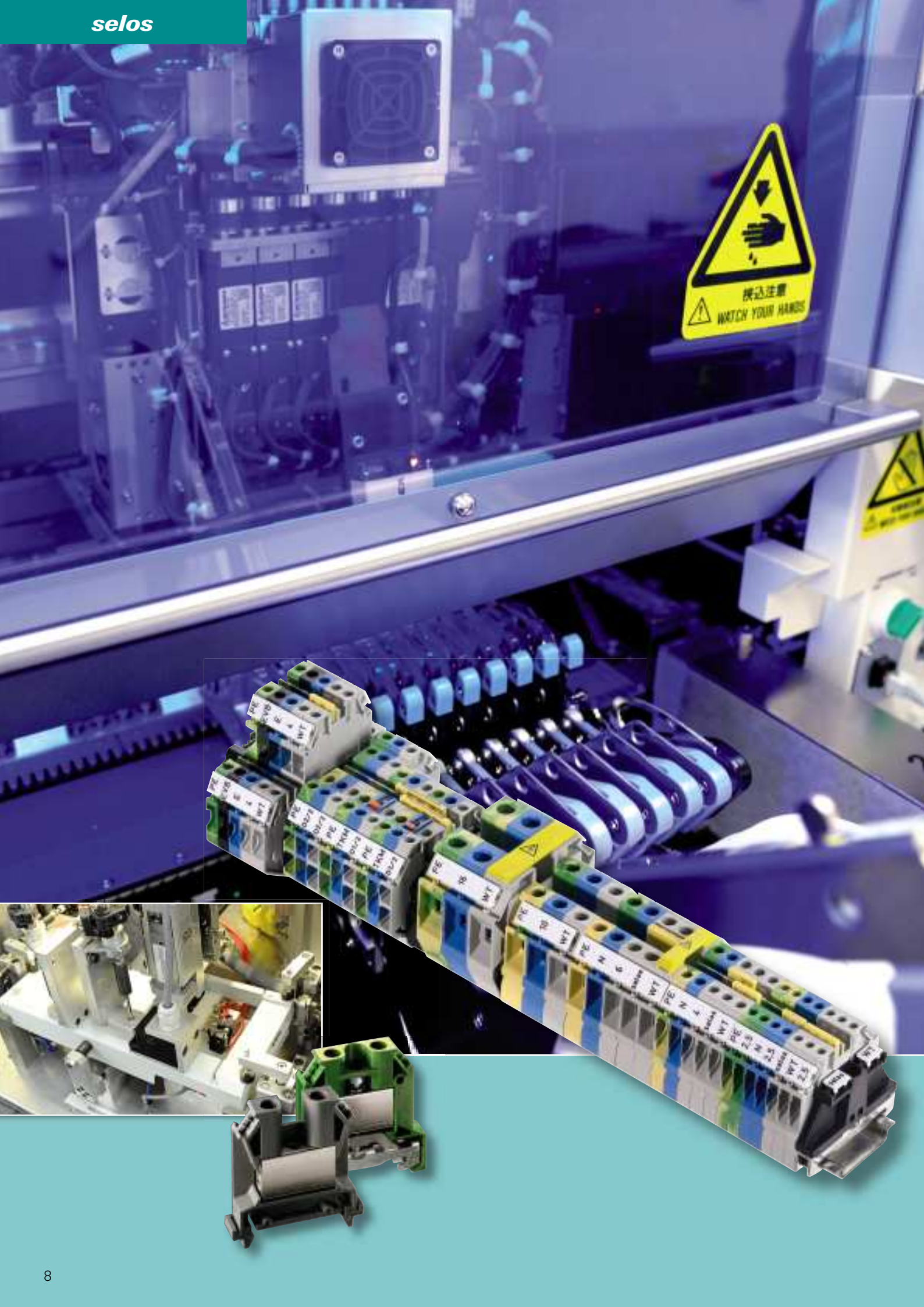

selos – DIN Rail Terminal Blocks with **Screw Connection**

Reliable connection, proven concept! **selos** is our DIN rail terminal block with screw connection, solid and functional, known worldwide, and in use millions of times over.

The **selos** series combines the classic screw connection with modern connection technology, with the focus on customer benefits and increased efficiency in wiring and the supply chain.

The **selos** CLASSIC series offers the highest-quality connecting technology. Thanks to its unique clamping body design, aluminum or copper wire connections are long-lasting and maintenance-free.

The **selos** product line includes feed-through and ground blocks with 2, 3 or 4 termination points, multi-tier blocks in two- and three-tier designs, knife-edge disconnect blocks and fuse blocks. In addition, specialty function blocks are available with a wide variety of diode circuits and diverse application-specific terminals, such as transformer disconnect terminals.

selos has been designed for use in machinery and plant construction as well as hazardous locations subject to explosion.

Connection cross-section up to 240 mm²

Rated current up to 415 A

Rated voltage up to 1000 V

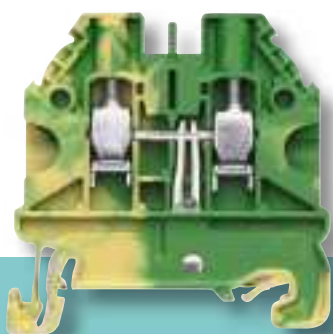

DIN Rail Terminal Blocks with Screw Connection

Simply connect

- Multi-wire connection
- Connect with or without ferrules

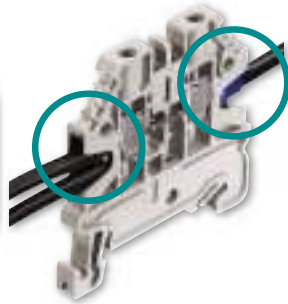

Reliable and maintenance-free

- Rugged clamping body design
- One-piece threaded collar
- Stress-free connecting and reconnecting

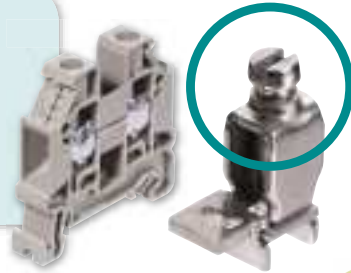

Smaller size

Uniform design

Fewer accessories



Time-saving assembly

- Snap-on screwless ground blocks

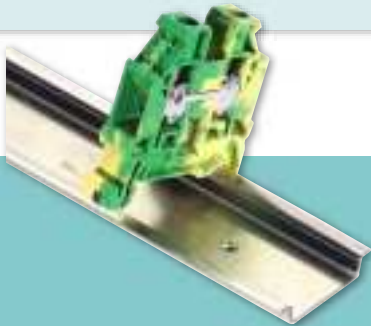

Plug & Play

- Dual jumpering channels
- Plug-in jumper bars
- Plug-in test adapter



Wieland jumpering system – Perfect technology

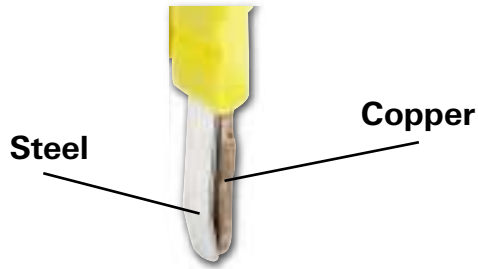

Perfect technology

- Copper current bar guarantees low contact resistance
- Steel spring guarantees strength, durability, and long-term stability

Extremely rugged!

- Indestructible steel spring
- Vibration-proof connection



Simple customization

- Individual poles easy to remove
- Circuits easy to identify



Wieland marking system – Reliable identification

Marking strips – Dependable

- Maximum hold to the terminal
- Solidify integrity of rail assembly



Endless strip – Effective

- Mounting facility for endless strips permits single step marking of entire assembly
- Continuous labeling
- Uses commercially available labeling systems



Marking tags – Individual

- Individual labeling with minimum effort
- Ideal for service and maintenance

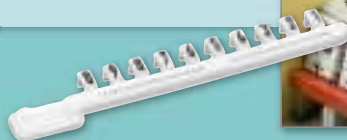

Feed-through blocks with screw connection

WT 2,5

- Feed-through block with screw connection for mounting on TS 35
- Nominal cross section 2.5 mm²
- Max. electrical data: 32 A/4 mm²
- Connection capacity: 2 wires, equal size 0.14 – 1.5 mm²

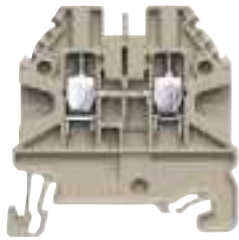

Description	Type	Part No.	Std. Pack
Feed-through block, gray	WT 2,5	58.503.0055.0	100
Feed-through block, blue	WT 2,5 BL	58.503.0055.6	100
General data			
Width / length / height, incl. TS 7.5	5 mm / 48 mm / 48 mm		
Wire strip length	9 mm		
Approvals			
Technical data	IEC	UL	CSA
	EN 60 947-7-1		
Cross section fine-stranded	0.14–4 mm ²		pending
Cross section solid/stranded	0.14–4 mm ²		
Cross section, AWG		26–12	26–12
Rated current	24 A	20 A	20 A
Rated voltage	1000 V	600 V	600 V
Rated impulse voltage	8 kV		
Pollution degree	3		
Accessories			
	Type	Part No.	Std. Pack
End plate	AP WT 2,5-10	07.313.2555.0	10
Cross connector	2 pole IVB WKF 2,5-2	Z7.280.6227.0	10
	3 pole IVB WKF 2,5-3	Z7.280.6327.0	10
	4 pole IVB WKF 2,5-4	Z7.280.6427.0	10
	5 pole IVB WKF 2,5-5	Z7.280.6527.0	10
	10 pole IVB WKF 2,5-10	Z7.280.7027.0	20
	20 pole IVB WKF 2,5-20	Z7.280.8027.0	20

WT 4

- Feed-through block with screw connection for mounting on TS 35
- Nominal cross section 4 mm²
- Max. electrical data: 41 A/6 mm²
- Connection capacity: 2 wires, equal size 0.14 – 2.5 mm²

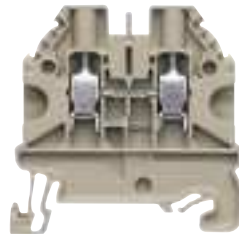

Description	Type	Part No.	Std. Pack
Feed-through block, gray	WT 4	58.504.0055.0	100
Feed-through block, blue	WT 4 BL	58.504.0055.6	100
General data			
Width / length / height, incl. TS 7.5	6 mm / 48 mm / 48 mm		
Wire strip length	9 mm		
Approvals			
Technical data	IEC	UL	CSA
	EN 60 947-7-1		
Cross section fine-stranded	0.14–6 mm ²		pending
Cross section solid/stranded	0.14–6 mm ²		
Cross section, AWG		26–10	26–10
Rated current	32 A	30 A	30 A
Rated voltage	1000 V	600 V	600 V
Rated impulse voltage	8 kV		
Pollution degree	3		
Accessories			
	Type	Part No.	Std. Pack
End plate	AP WT 2,5-10	07.313.2555.0	10
Cross connector	2 pole IVB WKF 4-2	Z7.261.1227.0	10
	3 pole IVB WKF 4-3	Z7.261.1327.0	10
	4 pole IVB WKF 4-4	Z7.261.1427.0	10
	5 pole IVB WKF 4-5	Z7.261.1527.0	10
	10 pole IVB WKF 4-10	Z7.261.2027.0	20

WT 6

- Feed-through block with screw connection for mounting on TS 35
- Nominal cross section 6 mm²
- Max. electrical data: 57 A/10 mm²
- Connection capacity: 2 wires, equal size 0.2 – 4 mm²

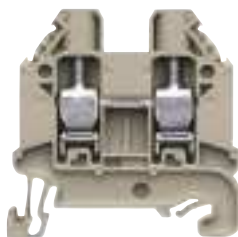

Description	Type	Part No.	Std. Pack
Feed-through block, gray	WT 6	58.506.0055.0	100
Feed-through block, blue	WT 6 BL	58.506.0055.6	100
General data			
Width / length / height, incl. TS 7.5	8 mm / 48 mm / 48 mm		
Wire strip length	11 mm		
Approvals			
Technical data	IEC	UL	CSA
	EN 60 947-7-1		
Cross section fine-stranded	0.2–10 mm ²		pending
Cross section solid/stranded	0.2–10 mm ²		
Cross section, AWG		24–8	24–8
Rated current	41 A	50 A	50 A
Rated voltage	1000 V	600 V	600 V
Rated impulse voltage	8 kV		
Pollution degree	3		
Accessories			
	Type	Part No.	Std. Pack
End plate	AP WT 2,5-10	07.313.2555.0	10
Cross connector	2 pole IVB WKF 6-2	Z7.282.5227.0	10
	3 pole IVB WKF 6-3	Z7.282.5327.0	10
	4 pole IVB WKF 6-4	Z7.282.5427.0	10
	5 pole IVB WKF 6-5	Z7.282.5527.0	10
	10 pole IVB WKF 6-10	Z7.282.6027.0	10

WT 10

- Feed-through block with screw connection for mounting on TS 35
- Nominal cross section 10 mm²
- Max. electrical data: 76 A/16 mm²
- Connection capacity: 2 wires, equal size 0.5 – 6 mm²

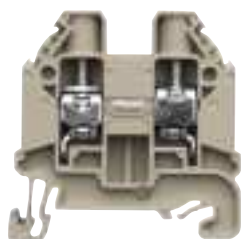

Description	Type	Part No.	Std. Pack
Feed-through block, gray	WT 10	58.510.0055.0	50
Feed-through block, blue	WT 10 BL	58.510.0055.6	50
General data			
Width / length / height, incl. TS 7.5	10 mm / 48 mm / 48 mm		
Wire strip length	13 mm		
Approvals			
Technical data	IEC	UL	CSA
	EN 60 947-7-1		
Cross section fine-stranded	0.5–16 mm ²		pending
Cross section solid/stranded	0.5–16 mm ²		
Cross section, AWG		20–6	20–6
Rated current	57 A	65 A	65 A
Rated voltage	1000 V	600 V	600 V
Rated impulse voltage	8 kV		
Pollution degree	3		
Accessories			
	Type	Part No.	Std. Pack
End plate	AP WT 2,5-10	07.313.2555.0	10
Cross connector	2 pole IVB WKF 10-2	Z7.283.8227.0	10

WT 16

- Feed-through block with screw connection for mounting on TS 35
- Nominal cross section 16 mm²
- Max. electrical data: 101 A/25 mm²
- Connection capacity: 2 wires, equal size 2.5 – 10 mm²

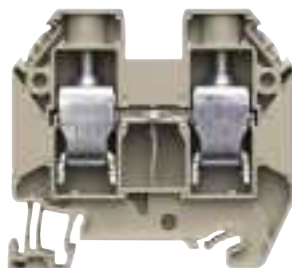

Description	Type	Part No.	Std. Pack
Feed-through block, gray	WT 16	58.516.0055.0	50
Feed-through block, blue	WT 16 BLAU	58.516.0055.6	50
General data			
Width / length / height, incl. TS 7.5	12 mm / 58 mm / 54mm		
Wire strip length	15 mm		
Approvals			
Technical data	IEC	UL	CSA
	EN 60 947-7-1		
Cross section fine-stranded	4–25 mm ²		pending
Cross section solid/stranded	1.5–25 mm ²		
Cross section, AWG		16–4	16–4
Rated current	76 A	85 A	85 A
Rated voltage	1000 V	600 V	600 V
Rated impulse voltage	8 kV		
Pollution degree	3		
Accessories			
	Type	Part No.	Std. Pack
End plate	AP WT 16	07.313.2755.0	10
Cross connector	2 pole IVB WKF 16-2	Z7.284.4227.0	10

Accessories for *selos* WT 2,5 – WT 16



Accessories	Type	Part No.	Std. Pack
Cover with warning symbol	for WT 2,5	AD WT 2,5	04.344.1455.8
	for WT 4	AD WT 4	04.344.1655.8
	for WT 6	AD WT 6/10	04.344.1855.8
	for WT 10	AD WT 6/10	04.344.1855.8
	for WT 16	AD WT 16	04.344.2255.8
Partition for WT 2,5 – WT 10	TW WT 2,5-10	07.313.2655.0	10
Partition for WT 16	TW WT 4E	07.313.2855.0	10
Test adapter modular for WT 2,5 and 4	PS WKC/F	Z1.299.9753.0	10
End plate for test adapter *	ZP/AP PS	07.312.6053.0	10





* for WT4 an end cover plate must be snapped in after each test connector

Feed-through blocks with screw connection

WKN 35/U

- Feed-through block with screw connection for mounting on TS 35 and TS 32
- Nominal cross section 35 mm²
- Ex e I/II  II 2GD IM2
Follow the EX installation instructions on page 143
- Enclosed design







Description	Type	Part No.	Std. Pack
Feed-through block, gray	WKN 35/U	57.535.0155.0	20
Feed-through block Exi, blue	WKN 35/U BLAU	57.535.0155.6	20
General data			
Width / length / height, incl. TS 7.5	16 mm / 71 mm / 68 mm		
Wire strip length	18 mm		
Approvals	EPM      KEMA 02 ATEX 2114 U		
Technical data	IEC	UL	CSA
	EN 60 947-7-1		EN 60 079-0/-7
Cross section fine-stranded	10–35 mm ²	10–2 AWG	10–35 mm ²
Cross section solid/stranded	10–50 mm ²		10–50 mm ²
Rated current	125 A	150 A	86/124 A
Rated voltage	1000 V	600 V	600 V
Rated impulse voltage	8 kV		690 V ¹⁾
Pollution degree	3		
Accessories			
Partition, gray	TWN 35	07.311.7855.0	10
Cross connector with screws, insulated	2 pole 3 pole	IVB WKN 35 - 2 IVB WKN 35 - 3	5 5
	up to 6 pole	IVB WKN 35 - 6	5
	up to 12 pole	IVB WKN 35 - 12	5
Single cover with marking facility	AD VB 35 GELB	04.326.2553.8	10
Cover with warning symbol over 4 blocks	AD VB 16/4 GELB	04.343.5256.8	10

WKN 70/U

- Feed-through block with screw connection for mounting on TS 35 and TS 32
- Nominal cross section 70 mm²
- Ex e I/II  II 2GD IM2
Follow the EX installation instructions on page 143
- Enclosed design







Description	Type	Part No.	Std. Pack
Feed-through block, gray	WKN 70/U	57.570.0155.0	20
Feed-through block Exi, blue	WKN 70/U BLAU	57.570.0155.6	20
General data			
Width / length / height, incl. TS 7.5	24 mm / 77 mm / 81 mm		
Wire strip length	24 mm		
Approvals	ATEX LR     KEMA 02 ATEX 2114 U		
Technical data	IEC	UL	CSA
	EN 60 947-7-1		EN 60 079-0/-7
Cross section fine-stranded	10–70 mm ²	6–2/0 AWG	6–2/0 AWG
Cross section solid/stranded	16–95 mm ²		16–95 mm ²
Rated current	192 A	175/175 A	170 A
Rated voltage	1000 V	600 V	600 V
Rated impulse voltage	8 kV		690 V
Pollution degree	3		
Accessories			
Partition, gray	TWN 70	07.311.7955.0	10
Cross connector with screws, insulated	2 pole 3 pole	VB WKN 70 - 2 VB WKN 70 - 3	10 10
	up to 6 pole	VB WKN 70 - 6	10
Single cover with marking facility	AD VB 70 GELB	04.326.2653.8	10
Cover with warning symbol over 4 blocks	AD VB 24/4 GELB	04.343.5356.8	10

WKN 150/U

- Feed-through block with screw connection for mounting on TS 35 and TS 32
- Nominal cross section 150 mm²
- Ex e I/II  II GD IM2
Follow the EX installation instructions on page 143
- Enclosed design



Description	Type	Part No.	Std. Pack
Feed-through block, gray	WKN 150/U	57.597.0155.0	10
Feed-through block Exi, blue	WKN 150/U BLAU	57.597.0155.6	10
General data			
Width / length / height, incl. TS 7.5	28 mm / 96 mm / 99 mm		
Wire strip length	30 mm		
Approvals	ATEX LR     KEMA 02 ATEX 2114 U		
Technical data	IEC	UL	CSA
	EN 60 947-7-1		EN 60 079-0/-7
Cross section fine-stranded	35–150 mm ²	2/0 AWG-350 kcmil	2/0 AWG-350 kcmil
Cross section solid/stranded	35–185 mm ²		35–185 mm ²
Rated current	309 A	335/335 A	365 A
Rated voltage	1000 V	600 V	600 V
Rated impulse voltage	8 kV		690 V
Pollution degree	3		
Accessories			
Partition, gray			
Cross connector with screws, insulated	2 pole 3 pole	VB WKN 150 - 2 VB WKN 150 - 3	5 5
	up to 6 pole	VB WKN 150 - 6	5
Cover with warning symbol over 4 blocks	AD VB 28/4 GELB	04.343.5456.8	10

Supply set

Description	Type	Part No.	Std. Pack
Supply set	WKN 70 3D/N/SL/U	57.570.9855.0	1
Supply set	WKN 70 3D/2N/SL/U	57.570.9955.0	1
Supply set	WKN 150/70 3D/N/SL/U	57.597.9855.0	1
Supply set	WKN 150/3D/N/U	57.597.9955.0	1

Ground blocks with screw connection

WT 2,5 PE

- Ground block with screw connection for mounting on TS 35
- Nominal cross section 2.5 mm²
- Connection capacity: 2 wires, equal size 0.14 – 1.5 mm²



Description	Type	Part No.	Std. Pack
Ground block, green/yellow	WT 2,5 PE	58.503.9055.0	100
General data			
Width / length / height, incl. TS 7.5	5 mm / 48 mm / 48 mm		
Wire strip length	9 mm		
Approvals			
Technical data	IEC	UL	CSA
	EN 60 94-7-2		
Cross section fine-stranded	0.14–4 mm ²		pending
Cross section solid/stranded	0.14–4 mm ²		
Cross section, AWG		26–12	26–12
Rated current			
Rated voltage	1000 V	600 V	600 V
Rated impulse voltage	8 kV		
Pollution degree	3		
Accessories			
	Type	Part No.	Std. Pack
End plate	AP WT 2,5 - 10	07.313.2555.0	10

WT 4 PE

- Ground block with screw connection for mounting on TS 35
- Nominal cross section 4 mm²
- Connection capacity: 2 wires, equal size 0.14 – 2.5 mm²





Description	Type	Part No.	Std. Pack
Ground block, green/yellow	WT 4 PE	58.504.9055.0	100
General data			
Width / length / height, incl. TS 7.5	6 mm / 48 mm / 48 mm		
Wire strip length	9 mm		
Approvals			
Technical data	IEC	UL	CSA
	EN 60 94-7-2		
Cross section fine-stranded	0.14–6 mm ²		pending
Cross section solid/stranded	0.14–6 mm ²		
Cross section, AWG		26–10	26–10
Rated current			
Rated voltage	1000 V	600 V	600 V
Rated impulse voltage	8 kV		
Pollution degree	3		
Accessories			
	Type	Part No.	Std. Pack
End plate	AP WT 2,5 - 10	07.313.2555.0	10



WT 6 PE

- Ground block with screw connection for mounting on TS 35
- Nominal cross section 6 mm²
- Connection capacity: 2 wires, equal size 0.2 – 4 mm²



Description	Type	Part No.	Std. Pack
Ground block, green/yellow	WT 6 PE	58.506.9055.0	100
General data			
Width / length / height, incl. TS 7.5	8 mm / 48 mm / 48 mm		
Wire strip length	11 mm		
Approvals			
Technical data	IEC	UL	CSA
	EN 60 94-7-2		
Cross section fine-stranded	0.2–10 mm ²		pending
Cross section solid/stranded	0.2–10 mm ²		
Cross section, AWG		24–8	24–8
Rated current			
Rated voltage	1000 V	600 V	600 V
Rated impulse voltage	8 kV		
Pollution degree	3		
Accessories			
	Type	Part No.	Std. Pack
End plate	AP WT 2,5 - 10	07.313.2555.0	10

WT 10 PE		Description	Type	Part No.	Std. Pack	
<ul style="list-style-type: none"> • Ground block with screw connection for mounting on TS 35 • Nominal cross section 10 mm² • Connection capacity: 2 wires, equal size 0.5 – 6 mm² 		Ground block, green/yellow	WT 10 PE	58.510.9055.0	50	
		General data				
		Width / length / height, incl. TS 7.5	10 mm / 48 mm / 48 mm			
		Wire strip length	13 mm			
		Approvals				
		Technical data	IEC	UL	CSA	Ex
			EN 60 94-7-2			
		Cross section fine-stranded	0.5–16 mm ²			
		Cross section solid/stranded	0.5–16 mm ²			
		Cross section, AWG	20–6		20–6	
		Rated current	pending			
		Rated voltage	1000 V	600 V	600 V	
		Rated impulse voltage	8 kV			
Pollution degree	3					
Accessories		Type	Part No.	Std. Pack		
End plate		AP WT 2,5 - 10	07.313.2555.0	10		





WT 16 PE		Description	Type	Part No.	Std. Pack	
<ul style="list-style-type: none"> • Ground block with screw connection for mounting on TS 35 • Nominal cross section 16 mm² • Connection capacity: 2 wires, equal size 2.5 – 10 mm² 		Ground block, green/yellow	WT 16 PE	58.516.9055.0	100	
		General data				
		Width / length / height, incl. TS 7.5	12 mm / 58 mm / 54 mm			
		Wire strip length	15 mm			
		Approvals				
		Technical data	IEC	UL	CSA	Ex
			EN 60 94-7-2			
		Cross section fine-stranded	4–25 mm ²			
		Cross section solid/stranded	1.5–25 mm ²			
		Cross section, AWG	16–4		16–4	
		Rated current	pending			
		Rated voltage	1000 V	600 V	600 V	
		Rated impulse voltage	8 kV			
Pollution degree	3					
Accessories		Type	Part No.	Std. Pack		
End plate		AP WT 16	07.313.2755.0	10		

Ground blocks with screw connection

WKN 35 SL/U

- Ground block with screw connection for mounting on TS 35 and TS 32
- Nominal cross section 35 mm²
- Ex e I/II  II 2GD IM2
Follow the EX installation instructions on page 143
- Enclosed design





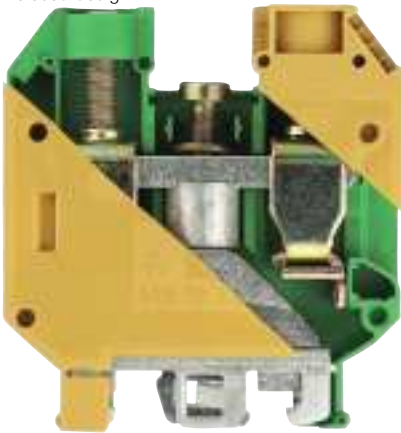

Description	Type	Part No.	Std. Pack
Ground block, green/yellow	WKN 35 SL/U	57.535.9055.0	20
General data			
Width / length / height, incl. TS 7.5	16 mm / 63 mm / 68 mm		
Wire strip length	20 mm		
Approvals	EPM      KEMA 02 ATEX 2114 U		
Technical data			
	IEC	UL	CSA
	EN 60 947-7-2		EN 60 079-0/-7
Cross section fine-stranded	10–35 mm ²		10–35 mm ²
Cross section solid/stranded	10–50 mm ²		10–50 mm ²
Cross section, AWG		10–2	10–2
Rated current			
Rated voltage	800 V	600 V	600 V
Rated impulse voltage	8 kV		
Pollution degree	3		

WKN 70 SL/U

- Ground block with screw connection for mounting on TS 35 and TS 32
- Nominal cross section 70 mm²
- Ex e I/II  II 2GD IM2
Follow the EX installation instructions on page 143
- Enclosed design







Description	Type	Part No.	Std. Pack
Ground block, green/yellow	WKN 70 SL/U	57.570.9055.0	20
General data			
Width / length / height, incl. TS 7.5	24 mm / 75 mm / 81 mm		
Wire strip length	24 mm		
Approvals	    KEMA 02 ATEX 2114 U		
Technical data			
	IEC	UL	CSA
	EN 60 947-7-2		EN 60 079-0/-7
Cross section fine-stranded	10–70 mm ²		10–70 mm ²
Cross section solid/stranded	16–95 mm ²		16–95 mm ²
Cross section, AWG		6–2/0	6–2/0
Rated current			
Rated voltage	800 V	600 V	600 V
Rated impulse voltage	8 kV		
Pollution degree	3		

9700 A/35 E S 35

- Ground block with screw connection for mounting on TS 35
- Nominal cross section 35 mm²
- Ex e I/II  II 2GD IM2
Follow the EX installation instructions on page 143







Description	Type	Part No.	Std. Pack
Ground block, green/yellow	9700 A/35 E S 35	Z2.302.0621.0	25
General data			
Width / length / height, incl. TS 7.5	17 mm / 56 mm / 35 mm		
Wire strip length			
Approvals	    KEMA 02 ATEX 2114 U		
Technical data	IEC	UL	CSA
	EN 60 947-7-2		 EN 60 079-0/-7
Cross section fine-stranded	35 mm ²		
Cross section solid/stranded	50 mm ²		
Cross section, AWG		8-2	
Rated current			
Rated voltage		600 V	
Rated impulse voltage			
Pollution degree			

9700 A/70 E S 35

- Ground block with screw connection for mounting on TS 35
- Nominal cross section 70 mm²
- Ex e I/II  II 2GD IM2
Follow the EX installation instructions on page 143



Description	Type	Part No.	Std. Pack
Ground block, green/yellow	9700 A/70 E S 35	Z2.302.0421.0	10
General data			
Width / length / height, incl. TS 7.5	25 mm / 57 mm / 57 mm		
Wire strip length			
Approvals	    KEMA 02 ATEX 2114 U		
Technical data	IEC	UL	CSA
	EN 60 947-7-2		 EN 60 079-0/-7
Cross section fine-stranded	70 mm ²		
Cross section solid/stranded	120 mm ²		
Cross section, AWG		6-2/0	6-2/0
Rated current			
Rated voltage		600 V	
Rated impulse voltage			
Pollution degree			

Duo feed-through and knife edge disconnect block with screw connection

WT 4 D1/2

- Duo feed-through block with screw connection for mounting on TS 35
- Nominal cross section 4 mm²
- Max. electrical data: 41 A/6 mm²
- Connection capacity: 2 wires, equal size 0.14 – 2.5 mm²



Description	Type	Part No.	Std. Pack
Duo feed-through block, gray	WT 4 D1/2	58.504.5055.0	100
Duo feed-through block, blue	WT 4 D1/2 BL	58.504.5055.6	100
General data			
Width / length / height, incl. TS 7.5	6 mm / 56 mm / 50 mm		
Wire strip length	9 mm		
Approvals			
Technical data		IEC	UL CSA
	EN 60 947-7-1		
Cross section fine-stranded	0.14–6 mm ²		
Cross section solid/stranded	0.14–6 mm ²		
Cross section, AWG	26–10 26–10		
Rated current	32 A 30 A 30 A		
Rated voltage	500 V 300 V 300 V		
Rated impulse voltage	6 kV		
Pollution degree	3		
Accessories			
	Type	Part No.	Std. Pack
End plate	AP WT 4 D1/2	07.313.2955.0	10
Partition	TW WT 4 E	07.313.2855.0	10
Cross connector	2 pole IVB WKF 4-2	Z7.261.1227.0	10
	5 pole IVB WKF 4-5	Z7.261.1527.0	10
	10 pole IVB WKF 4-10	Z7.261.2027.0	10

WT 4 D2/2

- Duo feed-through block with screw connection for mounting on TS 35
- Nominal cross section 4 mm²
- Max. electrical data: 41 A/6 mm²
- Connection capacity: 2 wires, equal size 0.14 – 2.5 mm²



Description	Type	Part No.	Std. Pack
Duo feed-through block, gray	WT 4 D2/2	58.504.5155.0	100
Duo feed-through block, blue	WT 4 D2/2 BLAU	58.504.5155.6	100
General data			
Width / length / height, incl. TS 7.5	6 mm / 68 mm / 50 mm		
Wire strip length	9 mm		
Approvals			
Technical data		IEC	UL CSA
	EN 60 947-7-1		
Cross section fine-stranded	0.14–6 mm ²		
Cross section solid/stranded	0.14–6 mm ²		
Cross section, AWG	26–10 26–10		
Rated current	32 A 30 A 30 A		
Rated voltage	500 V 300 V 300 V		
Rated impulse voltage	6 kV		
Pollution degree	3		
Accessories			
	Type	Part No.	Std. Pack
End plate	AP WT 4 D2/2	07.313.3155.0	10
Partition	TW WT 4 E	07.313.2855.0	10
Cross connector	2 pole IVB WKF 4-2	Z7.261.1227.0	10
	5 pole IVB WKF 4-5	Z7.261.1527.0	10
	10 pole IVB WKF 4-10	Z7.261.2027.0	10



WT 4 TKM...



- Knife edge disconnect block for mounting on TS 35
- Nominal cross section 4 mm²
- Connection capacity: 2 wires, equal size 0.14 – 2.5 mm²







Description	Type	Part No.	Std. Pack
Knife edge disconnect block, gray	WT 4 TKM	58.504.2055.0	100
Knife edge disconnect block, blue	WT 4 TKM BL	58.504.2055.6	100
with 2 test bolts, gray	WT 4 TKM P	58.504.2355.0	100
General data			
Width / length / height, incl. TS 7.5	6 mm / 56 mm / 50 mm		
Wire strip length	9 mm		
Approvals			
Technical data		IEC	UL CSA
	EN 60 947-7-1		
Cross section fine-stranded	0.14–6 mm ²		
Cross section solid/stranded	0.14–6 mm ²		
Cross section, AWG	26–10 26–10		
Rated current	24 A 16 A 16 A		
Rated voltage	500 V 300 V 300 V		
Rated impulse voltage	6 kV		
Pollution degree	3		
Accessories			
	Type	Part No.	Std. Pack
End plate	AP WT 4 D1/2	07.313.2955.0	10
Partition	TW WT 4 E	07.313.2855.0	10
Cross connector	2 pole IVB WKF 4-2	Z7.261.1227.0	10
	5 pole IVB WKF 4-5	Z7.261.1527.0	10
	10 pole IVB WKF 4-10	Z7.261.2027.0	10





Duo-ground blocks with screw connection

WT 4 D 1/2 PE		Description	Type	Part No.	Std. Pack
<ul style="list-style-type: none"> Duo-ground block with screw connection for mounting on TS 35 Nominal cross section 4 mm² Connection capacity: 2 wires, equal size 0.14 – 2.5 mm² 		Duo-ground block	WT 4 D1/2 PE	58.504.9355.0	100
General data					
Width / length / height, incl. TS 7.5		6 mm / 56 mm / 50 mm			
Wire strip length		9 mm			
Approvals					
Technical data		IEC	UL	CSA	Ex
		EN 60 947-7-2			
Cross section fine-stranded		0.14–6 mm ²			
Cross section solid/stranded		0.14–6 mm ²			
Cross section, AWG		26–10		26–10	
Rated current					
Rated voltage		500 V	300 V	300 V	
Rated impulse voltage		6 kV			
Pollution degree		3			
		pending			
Accessories					
		Type	Part No.	Std. Pack	
End plate		AP WT 4 D1/2	07.313.2955.0	100	

WT 4 D2/2 PE		Description	Type	Part No.	Std. Pack
<ul style="list-style-type: none"> Duo-ground block with screw connection for mounting on TS 35 Nominal cross section 4 mm² Connection capacity: 2 wires, equal size 0.14 – 2.5 mm² 		Duo-ground block	WT 4 D2/2 PE	58.504.9155.0	100
General data					
Width / length / height, incl. TS 7.5		6 mm / 68 mm / 50 mm			
Wire strip length		9 mm			
Approvals					
Technical data		IEC	UL	CSA	Ex
		EN 60 947-7-2			
Cross section fine-stranded		0.14–6 mm ²			
Cross section solid/stranded		0.14–6 mm ²			
Cross section, AWG		26–10		26–10	
Rated current					
Rated voltage		500 V	300 V	300 V	
Rated impulse voltage		6 kV			
Pollution degree		3			
		pending			
Accessories					
		Type	Part No.	Std. Pack	
End plate		AP WT 4 D2/2	07.313.3155.0	10	

Multi-tier blocks with screw connection

<p>WKN 2,5 E/U</p> <ul style="list-style-type: none"> Multi-tier block for mounting on TS 35 and TS 32 Nominal cross section 2.5 mm² 	Description	Type	Part No.	Std. Pack	
	Multi-tier block, gray	WKN 2,5 E/U	57.403.7055.0	100	
	General data				
	Width / length / height, incl. TS 7.5	5 mm / 66 mm / 64 mm			
	Wire strip length	8 mm			
	Approvals	 			
	Technical data				
		IEC	UL	CSA	
		EN 60 947-7-1			
	Cross section fine-stranded	0.5–2.5 mm ²			
	Cross section solid/stranded	0.5–4 mm ²			
	Cross section, AWG	22–12			
	Rated current	24 A	20/25 A	25 V	
Rated voltage	500 V	600 V	600 V		
Rated impulse voltage	6 A				
Pollution degree	3				

<p>WKN 2,5 E/U/VB</p> <ul style="list-style-type: none"> Multi-tier block, vertically jumpered, with screw connection for mounting on TS 35 and TS 32 Nominal cross section 2.5 mm² 	Description	Type	Part No.	Std. Pack	
	Multi-tier block, black	WKN 2,5 E/U/VB	57.403.6955.1	100	
	General data				
	Width / length / height, incl. TS 7.5	5 mm / 66 mm / 64 mm			
	Wire strip length	8 mm			
	Approvals	 			
	Technical data				
		IEC	UL	CSA	
		EN 60 947-7-1			
	Cross section fine-stranded	0.5–2.5 mm ²			
	Cross section solid/stranded	0.5–4 mm ²			
	Cross section, AWG	22–12			
	Rated current	24 A	20/25 A	25 A	
Rated voltage	500 V	600 V	600 V		
Rated impulse voltage	6 A				
Pollution degree	3				

Accessories for *selos* WKN 2,5 E/U...

	Accessories		Type	Part No.	Std. Pack
	End plate	gray	APN 2,5 E	07.312.1755.0	10
	Partition	gray	TWN 2,5 E	07.312.1855.0	10
	Cross connector with screws, insulated	2 pole	IVB WK 2,5 - 2	Z7.280.2227.0	10
		3 pole	IVB WK 2,5 - 3	Z7.280.2327.0	10
		up to 12 pole	IVB WK 2,5 - 12	Z7.280.3227.0	10
	Partition plate with marking facility	yellow	TS 2,5 GELB	07.311.2053.8	10
	Single cover with marking facility	yellow	AD VB 2,5 GELB	04.326.2053.8	10
	Cover with warning symbol over 4 blocks			04.343.4756.8	10

WT 4 E

- Multi-tier block for mounting on TS 35
- Nominal cross section 4 mm²
- Connection capacity: 2 wires, equal size 0.14 – 2.5 mm²



Description	Type	Part No.	Std. Pack
Multi-tier block, gray	WT 4 E	58.504.7055.0	100
Multi-tier block, blue	WT 4 E BL	58.504.7055.6	100
General data			
Width / length / height, incl. TS 7.5	6 mm / 72 mm / 67 mm		
Wire strip length	9 mm		
Approvals			
Technical data	IEC	UL	CSA
	EN 60 947-7-1		
Cross section fine-stranded	0.14–6 mm ²		pending
Cross section solid/stranded	0.14–6 mm ²		
Cross section, AWG	26–10	26–10	
Rated current	32 A	30 A	30 A
Rated voltage	800 V	300 V	300 V
Rated impulse voltage	8 kV		
Pollution degree	3		
Accessories			
	Type	Part No.	Std. Pack
End plate	AP WT 4 E	07.313.3355.0	10
Partition	TW WT 4 E	07.313.2855.0	10
Cross connector	2 pole IVB WKF 4-2	Z7.261.1227.0	10
	5 pole IVB WKF 4-5	Z7.261.1527.0	10
	10 pole IVB WKF 4-10	Z7.261.2027.0	10

WT 4 E VB

- Multi-tier block, vertically jumpered, with screw connection for mounting on TS 35
- Nominal cross section 4 mm²
- Connection capacity: 2 wires, equal size 0.14 – 2.5 mm²



Description	Type	Part No.	Std. Pack
Multi-tier block, black	WT 4 E VB	58.504.6955.1	100
General data			
Width / length / height, incl. TS 7.5	6 mm / 72 mm / 67 mm		
Wire strip length	9 mm		
Approvals			
Technical data	IEC	UL	CSA
	EN 60 947-7-1		
Cross section fine-stranded	0.14–6 mm ²		pending
Cross section solid/stranded	0.14–6 mm ²		
Cross section, AWG	26–10	26–10	
Rated current	32 A	30 A	30 A
Rated voltage	800 V	300 V	300 V
Rated impulse voltage	8 kV		
Pollution degree	3		
Accessories			
	Type	Part No.	Std. Pack
End plate	AP WT 4 E	07.313.3355.0	10
Partition	TW WT 4 E	07.313.2855.0	10
Cross connector	2 pole IVB WKF 4-2	Z7.261.1227.0	10
	5 pole IVB WKF 4-5	Z7.261.1527.0	10
	10 pole IVB WKF 4-10	Z7.261.2027.0	10

WT 4 E PE

- Multi-tier ground block with screw connection for mounting on TS 35
- Nominal cross section 4 mm²
- Connection capacity: 2 wires, equal size 0.14 – 2.5 mm²



Description	Type	Part No.	Std. Pack
Multi-tier ground block, green/yellow	WT 4 E PE	58.504.9255.0	100
General data			
Width / length / height, incl. TS 7.5	6 mm / 72 mm / 67 mm		
Wire strip length	9 mm		
Approvals			
Technical data	IEC	UL	CSA
	EN 60 947-7-2		
Cross section fine-stranded	0.14–6 mm ²		pending
Cross section solid/stranded	0.14–6 mm ²		
Cross section, AWG	26–10	26–10	
Rated current			
Rated voltage	800 V	300 V	300 V
Rated impulse voltage	8 kV		
Pollution degree	3		
Accessories			
	Type	Part No.	Std. Pack
End plate	AP WT 4 E	07.313.3355.0	10

Specialty function blocks with screw connection

WT 4 E...

- Function block with screw connection for mounting on TS 35
- Nominal cross section 4 mm²
- Connection capacity: 2 wires, equal size 0.14 – 2.5 mm²

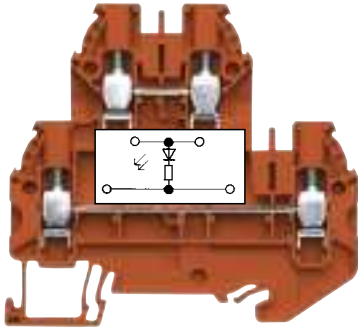

Description	Type	Part No.	Std. Pack
Function block, orange	WT 4 E...	58.504.XX55.9	100
General data			
Width / length / height, incl. TS 7.5	6 mm / 72 mm / 67 mm		
Wire strip length	9 mm		
Approvals			
Technical data			
	IEC	UL	CSA
	EN 60 947-7-1/-2		
Cross section fine-stranded	0.14–6 mm ²		
Cross section solid/stranded	0.14–6 mm ²		
Cross section, AWG	26–10		
Rated current	26–10		
Rated voltage			
Rated impulse voltage			
Pollution degree			
Accessories			
	Type	Part No.	Std. Pack
End plate, gray	AP WT 4 E	07.313.3355.0	10

Examples of functions

The multi-tier block is available on request as a function block for a wide variety of switching tasks.

58.504.8355.9

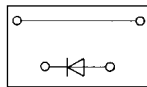

58.504.8055.9
with inverted diode

400 V
1 A/1000 V

58.504.7455.9 LED red

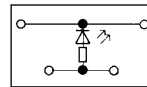

24 V DC
R = 4,7 K
0,4 W

58.504.8255.9

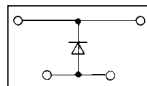

58.504.8155.9
with inverted diode

400 V
1 A/1000 V

58.504.7955.9

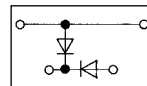

58.504.8855.9
with inverted diodes

1 A/400 V

58.504.7255.9 LED red

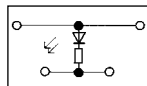

24 V DC
R = 4,7 K
0,4 W

58.504.8755.9 LED green

58.504.7355.9

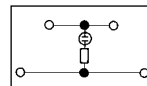

U = 100-500 V

Three-tier-/Initiator blocks with screw connection

WK 2,5-3 D/U

- Multi-tier block for mounting on TS 35 and TS 32
- Nominal cross section 2.5 mm²

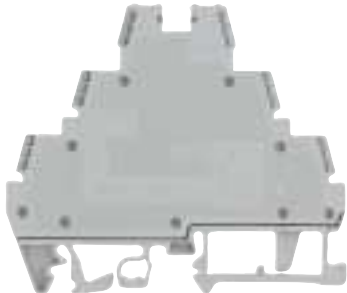

WK 2,5 - 3 D/U-NGN

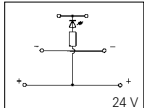

WK 2,5 - 3 D/U-PGN

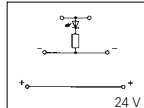

Description	Type	Part No.	Std. Pack
Multi-tier block, gray	WK 2,5 - 3 D/U	57.503.8855.0	50
Multi-tier bl., LED (green) betw. signal and +	WK 2,5 - 3 D/U-NGN	57.503.8955.0	50
Multi-tier bl., LED (green) betw. signal and -	WK 2,5 - 3 D/U-PGN	57.503.9055.0	50

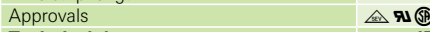
General data				
Width / length / height, incl. TS 7.5	6 mm / 79 mm / 69 mm			
Wire strip length	7 mm			
Approvals				
Technical data	IEC	UL	CSA	Ex
	EN 60 947-7-1			
Cross section fine-stranded	0.5–2.5 mm ²			
Cross section solid/stranded	0.5–4 mm ²			
Cross section, AWG		22–12	22–12	
Rated current	24 A	25 A	25 A	
Rated voltage	400 V*	300 V*	300 V*	
Rated impulse voltage	6 kV			
Pollution degree	3			

Accessories		Type	Part No.	Std. Pack
Partition, gray		TW 2,5 - 3 D/U	07.312.1255.0	50

WK 2,5-3 D/SL

- Multi-tier block for mounting on TS 35
- Nominal cross section 2,5 mm²

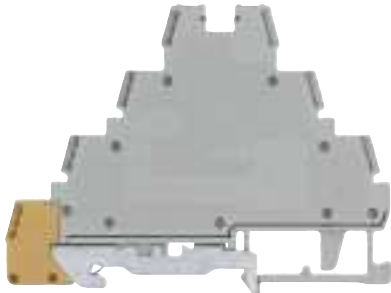

WK 2,5 - 3 D SL-NGN

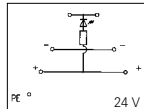

WK 2,5 - 3 D SL-PGN

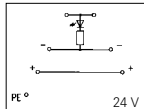

Description	Type	Part No.	Std. Pack
Multi-tier block, gray	WK 2,5 - 3 D SL	56.503.8355.0	50
Multi-tier bl., LED (green) betw. signal and +	WK 2,5 - 3 D SL-NGN	56.503.8455.0	50
Multi-tier bl., LED (green) betw. signal and -	WK 2,5 - 3 D SL-PGN	56.503.8555.0	50

General data				
Width / length / height, incl. TS 7.5	6 mm / 79 mm / 69 mm			
Wire strip length	7 mm			
Approvals				
Technical data	IEC	UL	CSA	Ex
	EN 60 947-7-1			
Cross section fine-stranded	0.5–2.5 mm ²			
Cross section solid/stranded	0.5–4 mm ²			
Cross section, AWG		22–12	22–12	
Rated current	24 A	25 A	25 A	
Rated voltage	400 V*	300 V*	300 V*	
Rated impulse voltage	6 kV			
Pollution degree	3			

Accessories		Type	Part No.	Std. Pack
Partition, gray		TW 2,5 - 3 D/U	07.312.1255.0	50



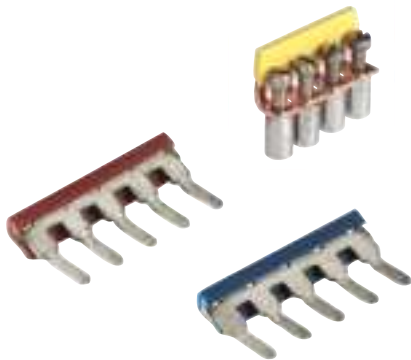

Accessories for selos WK 2,5-3 D/...

- The use of cross connectors (jumper combs), requires partitions in order to maintain the air and creepage distances.
- * 24 V~ with LED



Accessories	Type	Part No.	Std. Pack	
Cross connector with screws, insulated, for upper level	2 pole	IVB WK/3D-02	Z7.270.0227.0	10
	3 pole	IVB WK/3D-03	Z7.270.0327.0	10
	up to 12 pole	IVB WK/3D-12	Z7.270.1227.0	10
Jumper comb, angled, insulated (red), for lower level	2 pole	IVB WK 2,5-K-2 ROT	Z7.267.0227.5	10
	3 pole	IVB WK 2,5-K-3 ROT	Z7.267.0327.5	10
	up to 12 pole	IVB WK 2,5-K-12 ROT	Z7.267.1227.5	10
Jumper comb, angled, insulated (blue), for lower level	2 pole	IVB WK 2,5-K-2 BLAU	Z7.267.0227.6	10
	3 pole	IVB WK 2,5-K-3 BLAU	Z7.267.0327.6	10
	up to 12 pole	IVB WK 2,5-K-12 BLAU	Z7.267.1227.6	10





Initiator blocks with screw connection

WK 2,5-4 KI/U		Description	Type	Part No.	Std. Pack
<ul style="list-style-type: none"> Initiator block with screw connection for mounting on TS 35 and TS 32 Nominal cross section 2.5 mm² 		Initiator block, gray	WK 2,5 - 4 KI/U	57.503.7855.0	100
		Multi-tier bl., LED (green) betw. signal and +	WK 2,5 - 4 KI/U-NGN	57.503.7955.0	100
		Multi-tier bl., LED (green) betw. signal and -	WK 2,5 - 4 KI/U-PGN	57.503.8055.0	100
General data					
Width / length / height, incl. TS 7.5		6 mm / 53 mm / 69 mm			
Wire strip length		7 mm			
Approvals		EPM   			
Technical data					
		IEC	UL	CSA	
		EN 60 947-7-1			
		DIN VDE 0611 T1			
Cross section fine-stranded		0.5–2.5 mm ²			
Cross section solid/stranded		0.5–4 mm ²			
Cross section, AWG		22–12			
Rated current		24 A	25 A	25 A	
Rated voltage		250 V*	300 V*	300 V*	
Rated impulse voltage		4 kV			
Pollution degree		3			
Accessories					
		Partition, gray	TW 2,5 - 4 K/U	07.312.0555.0	10

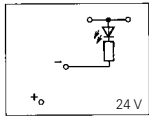
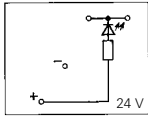
WK 2,5 - 4 KI/U-NGN

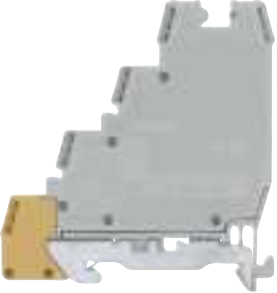
WK 2,5 - 4 KI/U-PGN



WK 2,5-4 KI/SL		Description	Type	Part No.	Std. Pack
<ul style="list-style-type: none"> Initiator block with screw connection for mounting on TS 35 Nominal cross section 2.5 mm² 		Initiator block, gray	WK 2,5 - 4 KI SL	56.503.7355.0	100
		Multi-tier bl., LED (green) betw. signal and +	WK 2,5 - 4 KI SL-NGN	56.503.7455.0	100
		Multi-tier bl., LED (green) betw. signal and -	WK 2,5 - 4 KI SL-PGN	56.503.7555.0	100
		Multi-tier bl., LED (red) betw. signal and -	WK 2,5 - 4 KI SL-PRT	56.503.7655.0	100
General data					
Width / length / height, incl. TS 7.5		6 mm / 64 mm / 69 mm			
Wire strip length		7 mm			
Approvals		EPM   			
Technical data					
		IEC	UL	CSA	
		EN 60 947-7-1			
		DIN VDE 0611 T1			
Cross section fine-stranded		0.5–2.5 mm ²			
Cross section solid/stranded		0.5–4 mm ²			
Cross section, AWG		22–12			
Rated current		24 A	25 A	25 A	
Rated voltage		250 V*	300 V*	300 V*	
Rated impulse voltage		4 kV			
Pollution degree		3			
Accessories					
		Partition, gray	TW 2,5 - 4 K/U	07.312.0555.0	10

WK 2,5 - 4 KI SL-NGN

WK 2,5 - 4 KI SL-PGN
WK 2,5 - 4 KI SL-PRT

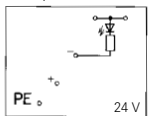
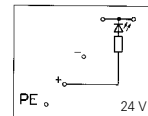

Accessories for selos WK 2,5-4 KI/...

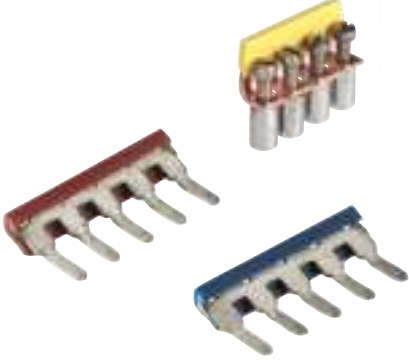
<ul style="list-style-type: none"> The use of cross connectors (jumper combs), requires partitions in order to maintain the air and creepage distances. * 24 V- with LED 	Accessories		Type	Part No.	Std. Pack
	Cross connector with screws, insulated, for upper level	2 pole	IVB WK/3D-02	Z7.270.0227.0	10
		3 pole	IVB WK/3D-03	Z7.270.0327.0	10
		up to 12 pole	IVB WK/3D-12	Z7.270.1227.0	10
	Jumper comb, angled, insulated (red), for lower level	2 pole	IVB WK 2,5-K-2 ROT	Z7.267.0227.5	10
		3 pole	IVB WK 2,5-K-3 ROT	Z7.267.0327.5	10
		up to 12 pole	IVB WK 2,5-K-12 ROT	Z7.267.1227.5	10
	Jumper comb, angled, insulated (blue), for lower level	2 pole	IVB WK 2,5-K-2 BLAU	Z7.267.0227.6	10
		3 pole	IVB WK 2,5-K-3 BLAU	Z7.267.0327.6	10
		up to 12 pole	IVB WK 2,5-K-12 BLAU	Z7.267.1227.6	10

Initiator blocks with screw connection

Description		Type	Part No.	Std. Pack
Initiator block, gray		WK 2,5-4 KOI/U	57.503.7055.0	50
General data				
Width / length / height, incl. TS 7.5		5 mm / 92 mm / 45 mm		
Wire strip length		10 mm		
Approvals				
Technical data		IEC	UL	CSA
		EN 60 947-7-1		
Cross section fine-stranded		0.5–2.5 mm ²		
Cross section solid/stranded		0.5–4 mm ²		
Cross section, AWG		22–12	22–12	
Rated current, feed-through		16 A	20/30 A	25 A
Rated voltage		400 V	300 V	300 V
Rated impulse voltage		6 kV		
Pollution degree		3		
Accessories		Type	Part No.	Std. Pack
Cross connector with screws, 2 pole		VB WK 2,5-2	Z7.280.0227.0	10
for signal feed through 3 pole		VB WK 2,5-3	Z7.280.0327.0	10
up to 6 pole		VB WK 2,5-6	Z7.280.0627.0	10

WK 2,5-4 KOI/U

- Initiator block with screw connection for mounting on TS 35 and TS 32
- Nominal cross section 2.5 mm²



Description		Type	Part No.	Std. Pack
Initiator block, gray		WK 2,5-4 KOI/U-NGN	57.503.7155.0	50
Initiator block, gray		WK 2,5-4 KOI/U-PGN	57.503.7255.0	50
General data				
Width / length / height, incl. TS 7.5		5 mm / 92 mm / 45 mm		
Wire strip length		10 mm		
Approvals				
Technical data		IEC	UL	CSA
		EN 60 947-7-1		
Cross section fine-stranded		0.5–2.5 mm ²		
Cross section solid/stranded		0.5–4 mm ²		
Cross section, AWG		22–12	22–12	
Rated current, feed-through		16 A	20/30 A	25 A
Rated voltage		24 DC	24 V	24 V
Rated impulse voltage				
Pollution degree				

NGN: Indicator: R = 2.2 K 0,35W
Lamp color: green

PGN: Indicator: R = 2.2 K 0,35W
Lamp color: green

WK 2,5-4 KOI/U-NGN WK 2,5-4 KOI/U-PGN

- Initiator block with screw connection for mounting on TS 35 and TS 32
- **NGN:** With LED (green) between signal and plus
- **PGN:** With LED (green) between signal and minus
- Nominal cross section 2.5 mm²

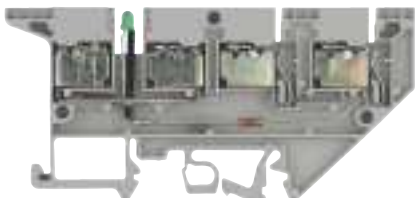

Accessories for selos WK 2,5-4 KOI/U...

Accessories		Type	Part No.	Std. Pack
End plate		gray AP 2,5-4 KO	07.310.9355.0	50
Partition		gray TW 2,5-4 KO	07.310.9455.0	50
Cross connector for voltage supply 2 pole		VB WK 2,5 KO-2	07.257.0227.0	100
3 pole		VB WK 2,5 KO-3	07.257.0327.0	100
up to 20 pole		VB WK 2,5 KO-20	07.257.2027.0	50
Partition plate with marking facility		yellow TS 2,5 GELB	07.311.2053.8	10
Single cover with marking facility		yellow AD VB 2,5 GELB	04.326.2053.8	10
Cover strip for cross connectors over 10 blocks		AD VB 5/10	04.342.0556.0	10
Tear-off marking strip, red, marked "+"		red 9705 A/5/10 B + ROT	04.855.0253.5	25
Tear-off marking strip, blue, marked "-"		blue 9705 A/5/10 B - BLAU	04.855.0353.6	25



Fuse blocks with screw connection

WK 4 TKG... with THSi 5x20

- Disconnect base block with screw connection for mounting on TS 35 and TS 32
- Nominal cross section 4 mm²

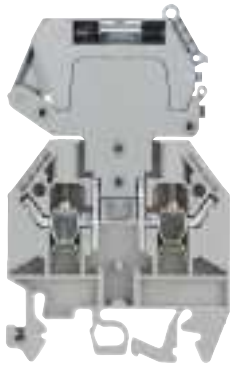

Description	Type	Part No.	Std. Pack
Disconnect base block, gray	WK 4 TKG/U	57.504.4055.0	100
Fuse disconnect lever, gray	THSi 5x20	Z1.298.1053.0	10
Fuse disconnect lever with LED 12-24V ²⁾	THSi 5x20 LED24	Z1.298.1153.0	10
Fuse disconnect lever with LED 24-60V ²⁾	THSi 5x20 LED60	Z1.298.1253.0	10
Fuse disconnect lever with GL 110-250V ²⁾	THSi 5x20 GL250	Z1.298.1353.0	10

General data				
Width / length / height, incl. TS 7.5	6 mm / 48 mm / 81 mm			
Wire strip length	9 mm			
Approvals				
Technical data		IEC	UL	CSA
		EN 60947-7-1, EN 60127-6		
Cross section fine-stranded	0.5–4 mm ²			
Cross section solid/stranded	0.5–6 mm ²			
Cross section, AWG		22–10	20–10	
Rated current	1)	10 A ¹⁾	6.3 A ¹⁾	
Rated voltage	800 V ²⁾	300 V ²⁾	250 V ²⁾	
Rated impulse voltage	8 kV			
Pollution degree	3			

WK 4 TKG... with THSi 6,3x32

- Disconnect base block with screw connection for mounting on TS 35 and TS 32
- Nominal cross section 4 mm²



Description	Type	Part No.	Std. Pack
Disconnect base block, gray	WK 4 TKG/U	57.504.4055.0	100
Fuse disconnect lever, gray	THSi 6,3x32	Z1.298.1653.0	10
Fuse disconnect lever with LED 12-24V ²⁾	THSi 6,3x32 LED24	Z1.298.1753.0	10
Fuse disconnect lever with LED 24-60V ²⁾	THSi 6,3x32 LED60	Z1.298.1853.0	10
Fuse disconnect lever with GL 110-250V ²⁾	THSi 6,3x32 GL250	Z1.298.1953.0	10

General data				
Width / length / height, incl. TS 7.5	6 mm / 48 mm / 81 mm			
Width disconnect lever THSi 6.3x32	8 mm	use end plate 07.311.6155.0 to maintain pitch		
Wire strip length	9 mm			
Approvals				
Technical data		IEC	UL	CSA
		EN 60947-7-1, EN 60127-6		
Cross section fine-stranded	0.5–4 mm ²			
Cross section solid/stranded	0.5–6 mm ²			
Cross section, AWG		22–10	20–10	
Rated current	1)	10 A ¹⁾	6.3 A ¹⁾	
Rated voltage	800 V ²⁾	300 V ²⁾	250 V ²⁾	
Rated impulse voltage	8 kV			
Pollution degree	3			

¹⁾ When selecting G fuse inserts, make sure that the specified maximum power loss is not exceeded. The current is determined by the inserted fuse.

²⁾ The voltage range is determined by the built-in LED display.

Maximum power loss at 23°C ambient temperature (according to DIN EN 60947-7-3)

Type	Rated Voltage	Overload protection		Exclusive short-circuit protection	
		Single arrangement	Group arrangement	Single arrangement	Group arrangement
THSi 5x20	250V	1.6W	1.6W	4.0W	2.5W
THSi 6,3x32	500V	2.5W	1.6W	4.0W	4.0W
SIST	250V	1.6W	1.6W	2.5W	1.6W

Depending on the application and the installation method, the possibility of increased temperature must be checked in the closed fuse holders.

Higher ambient temperatures mean additional stress for the fuse inserts. Therefore, the reduction of the rated current must be considered accordingly in these applications.

Indicator (24V): Lamp color: red
Power consumption: 10.3mA

Indicator (220V): Lamp color: red
Power consumption: 0.3mA

Description	Type	Part No.	Std. Pack
Fuse holder for 5x20 fuse	Si ST	Z1.299.4055.0	10
Fuse holder with LED 24-60V	Si ST LED	Z1.299.4155.0	10
Fuse holder with GL 220V	Si ST GL	Z1.299.4255.0	10

General data			
Width / length / height, incl. TS 7.5	6 mm / 48 mm / 68 mm		
Wire strip length	9 mm		
Approvals			
Technical data	IEC	UL	CSA
	EN 60947-7-1, EN 60127-6		
Cross section fine-stranded	0.5–4 mm ²		
Cross section solid/stranded	0.5–6 mm ²		
Cross section, AWG	22–10		
Rated current	1) ¹⁾	10 A	6.3 A ¹⁾
Rated voltage	800 V ²⁾	300 V	250 V
Rated impulse voltage	8 kV		
Pollution degree	3		

WK 4 TKG... SIST

- Disconnect base block with screw connection for mounting on TS 35 and TS 32
- Nominal cross section 4 mm²

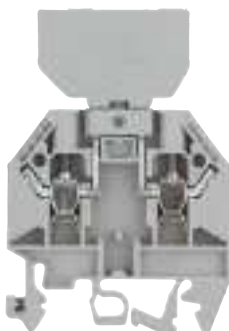

WK 4 TKG... DIST

- Disconnect base block with screw connection for mounting on TS 35 and TS 32
- Nominal cross section 4 mm²



Description	Type	Part No.	Std. Pack
Disconnect base block, gray	WK 4 TKG/U	57.504.4055.0	100
Diode plug - without contacts	DIST ...	Z1.299.3055.0	10
Diode plug - diode $I_{max} = 1\text{ A}$	DIST-1 N 4007-1 ³⁾	Z1.299.3155.0	10
Diode plug - diode $I_{max} = 1\text{ A}$	DIST-1 N 4007-2 ⁴⁾	Z1.299.3355.0	10
Diode plug with jumper $I_{max} = 10\text{ A}$	DIST-D	Z1.299.3255.0	10

General data			
Width / length / height, incl. TS 7.5	6 mm / 48 mm / 68 mm		
Wire strip length	9 mm		
Approvals			
Technical data	IEC	UL	CSA
	EN 60947-7-1, EN 60127-6		
Cross section fine-stranded	0.5–4 mm ²		
Cross section solid/stranded	0.5–6 mm ²		
Cross section, AWG	22–10		
Rated current		10 A	6.3 A ¹⁾
Rated voltage	800 V ²⁾	300 V	250 V
Rated impulse voltage	8 kV		
Pollution degree	3		



The current carrying load depends on the component used.
 Temporary peak voltage 1000 V.
 Pole assignment of the diode: Anode Cathode³⁾ / Cathode Anode⁴⁾



Accessories for *selos* WK 4 TKG... with THSi..., SIST and ...DIST

Accessories	Type	Part No.	Std. Pack
End plate	gray AP 4 TK	07.311.6155.0	10
Partition	gray TW 4 TK	07.311.8155.0	10
Jumper comb, insulated	2 pole	IVB 1 WK 4..2	10
	3 pole	IVB 1 WK 4..3	10
	up to 6 pole	IVB 1 WK 4..6	10

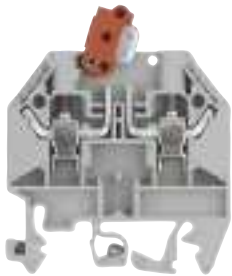

Fuse- and knife edge disconnect blocks with screw connection

WK 4/Si-D/U 5x25	Description			
	Type	Part No.	Std. Pack	
<ul style="list-style-type: none"> • Fuse block with screw connection for mounting on TS 35 and TS 32 • Nominal cross section 4 mm² 	Fuse block, gray			
	w. G-screw cap B DIN 41674, 5x25 mm	WK 4/Si-D/U 5 x 25	57.504.1655.0	50
	w. G-SG-screw cap A DIN 41674, 5x20 mm	WK 4/Si-D/U 5 x 20	57.504.1755.0	50
General data				
Width / length / height, incl. TS 7.5	12 mm / 48 mm / 49 mm			
Wire strip length	9 mm			
Approvals				
Technical data	IEC	UL	CSA	
	EN 60947-7-1, EN 60127-6			
Cross section fine-stranded	0.5–4 mm ²			
Cross section solid/stranded	0.5–6 mm ²			
Cross section, AWG				
Rated current	6.3 A			
Rated voltage	800 V			
Rated impulse voltage	8 kV			
Pollution degree	3			

WK 4/TKM	Description			
	Type	Part No.	Std. Pack	
<ul style="list-style-type: none"> • Knife edge disconnect block with screw connection for mounting on TS 35 and TS 32 • Nominal cross section 4 mm² * Version with test bolt: CSA: 300V EN 60947-7-1 – 690V/6kV/3 Test bolt can be loaded with 1A 	Knife edge disconnect block, gray	WK 4/TKM/U	57.504.2055.0	100
	Knife edge disconnect block, blue	WK 4/TKM/U BLAU	57.504.2055.6	100
	with 2 test bolts, gray	WK 4/TKM/P3/U	57.504.2355.0	100
General data				
Width / length / height, incl. TS 7.5	6 mm / 48 mm / 49 mm			
Wire strip length	9 mm			
Approvals				
Technical data	IEC	UL	CSA	
	EN 60947-7-1, EN 60127-6			
Cross section fine-stranded	0.5–4 mm ²			
Cross section solid/stranded	0.5–6 mm ²			
Cross section, AWG				
Rated current	20 A			
Rated voltage	800 V			
Rated impulse voltage	8 kV			
Pollution degree	3 ²⁾			

WK 4 TKG-TRST/U

- Invertible plug disconnect block with screw connection for mounting on TS 35 and 42
- Nominal cross section 4 mm²
- * **Version with test bolt:** CSA: 300V
EN 60 947-7-1 – 690V/6 kV/3
Test bolt can be loaded with 1 A



Description	Type	Part No.	Std. Pack
Invertible plug disconnect block, gray	WK 4 TKG-TRST/U	57.504.4555.0	100
with 2 test bolts, gray	WK 4 TKG-TRST P3/U	57.504.4855.0	100
General data			
Width / length / height, incl. TS 7.5	6 mm / 48 mm / 78 mm		
Wire strip length	9 mm		
Approvals			
Technical data	IEC	UL	CSA
	EN 60947-7-1, EN 60127-6		
Cross section fine-stranded	0.5–4 mm ²		
Cross section solid/stranded	0.5–6 mm ²		
Cross section, AWG		22–10	22–10
Rated current	20 A	10 A	20 A
Rated voltage	800 V	300 V	600 V
Rated impulse voltage	8 kV		
Pollution degree	3 ²		

WK 4 TKS D/U

- Feed-through block with screw connection for mounting on TS 35 and TS 32
- Nominal cross section 4 mm²
- Same dimensions as types WK 4 TKG/U and types WK 4/TKM/U

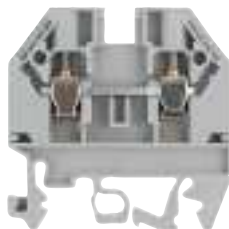

Description	Type	Part No.	Std. Pack
Feed-through block, gray	WK 4 TKS D/U	57.504.4455.0	100
General data			
Width / length / height, incl. TS 7.5	6 mm / 48 mm / 49 mm		
Wire strip length	9 mm		
Approvals			
Technical data	IEC	UL	CSA
	EN 60947-7-1, EN 60127-6		
Cross section fine-stranded	0.5–4 mm ²		
Cross section solid/stranded	0.5–6 mm ²		
Cross section, AWG		22–10	20–10
Rated current	32 A	25 A	20 A
Rated voltage	800 V	300 V	600 V
Rated impulse voltage	8 kV		
Pollution degree	3		

Accessories for *selos* WK 4...



Accessories	Type	Part No.	Std. Pack
End plate	gray AP 4 TK	07.311.6155.0	10
Partition	gray TW 4 TK	07.311.8155.0	10
Jumper comb, insulated	2 pole	IVB 1 WK 4..2	Z7.255.4227.0
	3 pole	IVB 1 WK 4..3	Z7.255.4327.0
	up to 6 pole	IVB 1 WK 4..6	Z7.255.4627.0

Fuse blocks with screw connection

WK 4 THSi 5.../U

- Integrated lever-action fuse block with screw connection for mounting on TS 35 and TS 32
- Nominal cross section 4 mm²
- For 5 mm miniature fuses
- The standard block has a storage location for a replacement fuse.

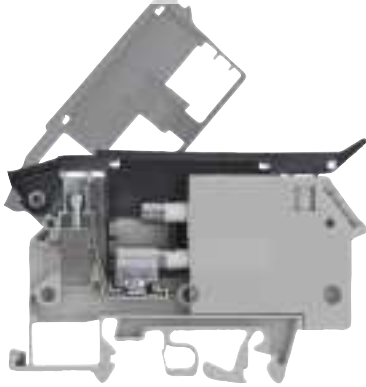

Description	Type	Part No.	Std. Pack
Fuse block, gray	WK 4/THSi 5 ... U	57.904.5355.0	50
- with LED 5-12V~/= current consumed. 2.3-7 mA	WK 4/THSi 5 LED 12 U	57.904.5455.0	50
- with LED 12-24V~/= current con. 2.8-6.2 mA	WK 4/THSi 5 LED 24 U	57.904.5555.0	50
- with LED 24-60V~/= current con. 1.5-4 mA	WK 4/THSi 5 LED 60 U	57.904.5655.0	50
- with GL 110-250V~/= current con. 0.13-0.55 mA	WK 4/THSi 5 GL 250 U	57.904.5755.0	50
- with GL 380-500V~/= current con. 0.2-0.3 mA	WK 4/THSi 5 GL 500 U	57.904.5855.0	50

General data				
Width / length / height, incl. TS 7.5	8 mm / 77 mm / 54 mm			
Wire strip length	8 mm			
Approvals				
Technical data		IEC	UL	CSA
		EN 60947-7-1, EN 60127-6		
Cross section fine-stranded	0,5-4 mm ²			
Cross section solid/stranded	0,5-6 mm ²			
Cross section, AWG		22-10	22-10	
Rated current	6.3 A ¹⁾	15 A	6.3 A	
Rated voltage	800 V ²⁾	600 V ²⁾	600 V ²⁾	
Rated impulse voltage	8 kV			
Pollution degree	3			

WK 4 THSi 6,3.../U

- Integrated lever-action fuse block with screw connection for mounting on TS 35 and TS32
- Nominal cross section 4 mm²
- For 6.3 mm miniature fuses
- The standard block has a storage location for a replacement fuse.

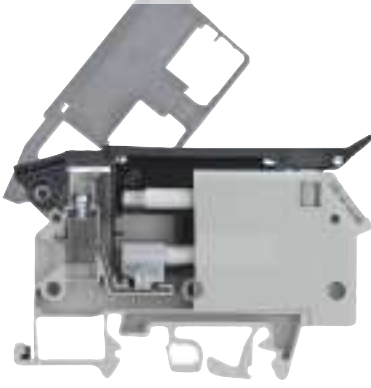

Description	Type	Part No.	Std. Pack
Fuse block, gray	WK 4/THSi 6,3 ... U	57.904.5355.0	50
- with LED 5-12V~/= current consumed. 2.3-7 mA	WK 4/THSi 6,3 LED 12 U	57.904.6455.0	50
- with LED 12-24V~/= current con. 2.8-6.2 mA	WK 4/THSi 6,3 LED 24 U	57.904.6555.0	50
- with LED 24-60V~/= current con. 1.5-4 mA	WK 4/THSi 6,3 LED 60 U	57.904.6655.0	50
- with GL 110-250V~/= current con. 0.13-0.55 mA	WK 4/THSi 6,3 GL 250 U	57.904.6755.0	50
- with GL 380-500V~/= current con. 0.2-0.3 mA	WK 4/THSi 6,3 GL 500 U	57.904.6855.0	50

General data				
Width / length / height, incl. TS 7.5	10 mm / 77 mm / 54 mm			
Wire strip length	8 mm			
Approvals				
Technical data		IEC	UL	CSA
		EN 60947-7-1, EN 60127-6		
Cross section fine-stranded	0,5-4 mm ²			
Cross section solid/stranded	0,5-6 mm ²			
Cross section, AWG		22-10	22-10	
Rated current	10 A ¹⁾	15 A	10 A	
Rated voltage	800 V ²⁾	600 V ²⁾	600 V ²⁾	
Rated impulse voltage	8 kV			
Pollution degree	3			

Info for selos WK 4 THSi...

The fuse blocks of this type have a flip top disconnect lever. It accepts miniature fuses of 5x20, 5x25 and 5x30 mm (terminal width: 8 mm) or 6.3x32 mm (terminal width: 10 mm). The hinged lever has latch points both in the open and in the closed position, and can be sealed.

All terminal blocks are available in two different versions, i.e. with or without red LEDs functioning as indicators.

¹⁾ When selecting G fuse inserts, make sure that the specified maximum power loss is not exceeded. The current is determined by the inserted fuse.

²⁾ The voltage range is determined by the built-in LED display. Depending on the application and the installation method, the circumstances for increased temperature must be checked in the closed fuse holders. Higher ambient temperatures are an additional load for the fuse inserts. Therefore, the reduction of the rated current must be considered accordingly in these applications.

¹⁾ Maximum power loss at 23°C ambient temperature (according to DIN EN 60947-7-3)

Type	Rated voltage	Overload protection		Exclusive short-circuit protection	
		Single arrangement	Group arrangement	Single arrangement	Group arrangement
THSi 5x20/25	250 V	1.6 W	1.6 W	4.0 W	2.5 W
THSi 6,3x32	500 V	2.5 W	2.5 W	4.0 W	2.5 W
THSi 5x30	500 V	1.6 W	1.6 W	4.0 W	2.5 W

Accessories and info for selos WK 10/Si...

Accessories	Type	Part No.	Std. Pack
End plate, gray	AP 10/Si	07.311.4155.0	10
Cross connector with screws	2 pole	VB WK 10/Si-2	27.287.0227.0
	3 pole	VB WK 10/Si-3	27.287.0327.0
	up to 6 pole	VB WK 10/Si-6	27.287.0627.0
Transparent block cover (for 1 block)		04.312.2056.0	100

¹⁾ Maximum power loss at 23°C ambient temperature (according to DIN EN 60947-7-3)

Type	Overload protection		Exclusive short-circuit protection	
	Single arrangement	Group arrangement	Single arrangement	Group arrangement
WK 10 Si U 5x20	4.0W/6.3A	2.5W/6.3A	4.0W/6.3A	4.0W/6.3A
WK 10 Si U 6.3x32	4.0W/10A	2.5W/2.5A	4.0W/10A	2.5W/2.5A
WK 10 Si U 5x25	4.0W/6.3A	2.5W/6.3A	4.0W/6.3A	4.0W/6.3A
WK 10 Si U 5x30	4.0W/6.3A	2.5W/6.3A	4.0W/6.3A	4.0W/6.3A

WK 10/SI .../U

- Fuse block with screw cap for mounting on TS 35
- Nominal cross section 10 mm²
- * Voltage and current are determined by the built-in LED and the inserted G-fuse.



Description	Type	Part No.	Std. Pack
Fuse block, gray, with screw cap			
– A DIN 41674 for G-fuses DIN 41571	WK 10/Si U 5 x 20	57.910.5055.0	50
– B DIN 41674 for G-fuses DIN 41576	WK 10/Si U 5 x 25	57.910.5155.0	50
– A DIN 41674 for G-fuses	WK 10/Si U 5 x 30	57.910.5255.0	50
– with screw cap for G-fuses	WK 10/Si U 6,3 x 32	57.910.5355.0	50
General data			
Width / length / height, incl. TS 7.5	12 mm / 65 mm / 58 mm		
Wire strip length	13 mm		
Approvals			
Technical data	IEC	UL	CSA
	EN 60947-7-1, EN 60127-6		
Cross section fine-stranded	1.0–10 mm ²		
Cross section solid/stranded	1.0–16 mm ²		
Cross section, AWG		22–6	16–6
Rated current	max. 10 A ¹⁾	15 A	max. 15 A
Rated voltage	500 V*	600 V*	600 V*
	* 57.910.5055.0 250 V~	600 V	600 V
	* 57.910.5155.0 250 V~	600 V	600 V
	* 57.910.5255.0 500 V~	600 V	600 V
	* 57.910.5355.0 500 V~	600 V	600 V
Rated impulse voltage	6 kV		
Pollution degree	3		

WK 10/SI .../U with indicator

- Fuse block with screw cap for mounting on TS 35 and TS 32
- Nominal cross section 10 mm²
- With indicator
- * Voltage and current are determined by the built-in indicator and the inserted G-fuse.



Description	Type	Part No.	Std. Pack
Fuse block, gray, with screw cap			
– A DIN 41674 for G-fuses DIN 41571	WK 10/Si U 5 x 20M, NGL	57.910.5455.0	50
– B DIN 41674 for G-fuses DIN 41576	WK 10/Si U 5 x 20M, GLB	57.910.5855.0	50
– A DIN 41674 for G-fuses	WK 10/Si U 6,3 x 32M, NGL	57.910.5755.0	50
– with screw cap for G-fuses	WK 10/Si U 6,3 x 32M, GLB	57.910.6155.0	50
General data			
Width / length / height, incl. TS 7.5	12 mm / 65 mm / 58 mm		
Wire strip length	13 mm		
Approvals			
Technical data	IEC	UL	CSA
	EN 60947-7-1, EN 60127-6		
Cross section fine-stranded	1.0–10 mm ²		
Cross section solid/stranded	1.0–16 mm ²		
Cross section, AWG		22–6	16–6
Rated current	max. 10 A ¹⁾	15 A	max. 15 A
Rated voltage	500 V*	600 V*	600 V*
Indicator – Current consumed			
red – 0.16–0.8 mA * 57.910.5455.0	110–250 V~	150 V	500 V
yellow – 24 mA * 57.910.5855.0	28 V~	28 V	28 V
red – 0.16–0.8 mA * 57.910.5755.0	110–500 V~	150 V	500 V
yellow – 24 mA * 57.910.6155.0	28 V~	28 V	28 V
Rated impulse voltage	6 kV		
Pollution degree	3		

WK 10/SI U D



- Feed-through block with screw connection for mounting on TS 35
- Nominal cross section 10 mm²
- Same dimensions as fuse block





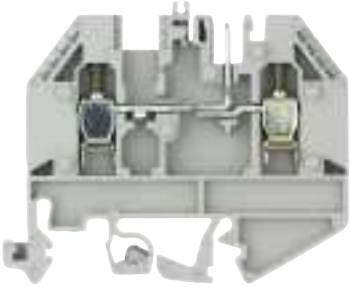

Description	Type	Part No.	Std. Pack
Feed-through block, gray	WK 10/Si U D	57.910.4955.0	50
General data			
Width / length / height, incl. TS 7.5	12 mm / 65 mm / 58 mm		
Wire strip length	13 mm		
Approvals			
Technical data	IEC	UL	CSA
	EN 60947-7-1		
Cross section fine-stranded	0.5–4 mm ²		
Cross section solid/stranded	0.5–6 mm ²		
Cross section, AWG		22–6	16–6
Rated current	57 A	50 A	65 A
Rated voltage	500 V	600 V	600 V
Rated impulse voltage	6 kV		
Pollution degree	3		

Feed-through blocks with *wiecon* pluggable connection

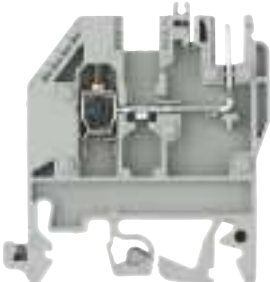
for PC board terminal type 8113 B, type 8313 B, type 8113 B/VL, type 8113 B/VR, type 8113 B/Top

WK 2,5 U/D/8113 S/V		Description	Type	Part No.	Std. Pack	
<ul style="list-style-type: none"> • Feed-through block with screw connection for mounting on TS 35 and TS 32 • Nominal cross section 2,5 mm² 		Feed-through block, gray	WK 2,5 U/D/8113 S/V...	57.503.2155.0	50	
		Power block, blue	WK 2,5 U/D/8113 S/V/VK	57.503.2555.6	50	
		Feed-through block, with LED 25 V, gray	WK 2,5 U/D/8113 S/V/LED 25	57.503.2255.0	50	
		Feed-through block, with LED 50 V, gray	WK 2,5 U/D/8113 S/V/LED 50	57.503.2355.0	50	
	General data					
		Width / length / height, incl. TS 7.5	5 mm / 61 mm / 51 mm			
		Wire strip length	9 mm			
		Approvals				
		Technical data	IEC	UL	CSA	
			EN 60947-7-1			
	Cross section fine-stranded	0.5–2,5 mm ²				
	Cross section solid/stranded	0.5–4 mm ²				
	Cross section, AWG		22–12	24–12		
	Rated current	12 A	15 A	15 A		
	Rated voltage	250 V	300 V	300 V		
	Rated impulse voltage	4 kV				
	Pollution degree	3				
Accessories						
	End plate, gray	Type	AP 2,5 U/D/8113 S/V	Part No.	07.311.9055.0	
	Spacer* 2.5 mm thick	Type	ZP 2,5 U/D/8113 S/V	Part No.	07.311.9155.0	
	Cover strip for LED, transparent 10 pole	Type	AD VB 5/10 P	Part No.	04.342.3556.8	
	Coding strip	Type		Part No.	05.561.0053.0	
	* for <i>wiecon</i> PC board connector with 7.5 mm pitch					

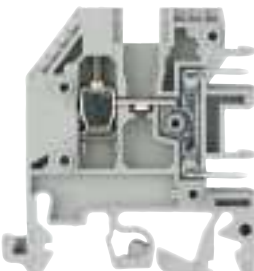
WK 2,5 U/8113 S/V		Description	Type	Part No.	Std. Pack	
<ul style="list-style-type: none"> • Feed-through block with screw connection for mounting on TS 35 and TS 32 • Nominal cross section 2,5 mm² 		Feed-through block, gray	WK 2,5 U/8113 S/V...	57.503.2655.0	50	
		Power block, blue	WK 2,5 U/8113 S/V/VK	57.503.3055.6	50	
		Feed-through block, with LED 25 V, gray	WK 2,5 U/8113 S/V/LED 25	57.503.2755.0	50	
		Feed-through block, with LED 50 V, gray	WK 2,5 U/8113 S/V/LED 50	57.503.2855.0	50	
	General data					
		Width / length / height, incl. TS 7.5	5 mm / 44 mm / 51 mm			
		Wire strip length	9 mm			
		Approvals				
		Technical data	IEC	UL	CSA	
			EN 60947-7-1			
	Cross section fine-stranded	0.5–2,5 mm ²				
	Cross section solid/stranded	0.5–4 mm ²				
	Cross section, AWG		22–12	24–12		
	Rated current	12 A	15 A	15 A		
	Rated voltage	250 V	300 V	300 V		
	Rated impulse voltage	4 kV				
	Pollution degree	3				
Accessories						
	End plate, gray	Type	AP 2,5 U/8113 S/V	Part No.	07.312.1555.0	
	Spacer* 2.5 mm thick	Type	ZP 2,5 U/8113 S/V	Part No.	07.312.1655.0	
	Coding strip	Type		Part No.	05.561.0053.0	
	* for <i>wiecon</i> PC board connector with 7.5 mm pitch					

WK 2,5 U/D/8113 S/H		Description	Type	Part No.	Std. Pack	
<ul style="list-style-type: none"> • Feed-through block with screw connection for mounting on TS 35 and TS 32 • Nominal cross section 2,5 mm² 		Feed-through block, gray	WK 2,5 U/8113 S/H	57.503.2055.0	100	
	General data					
		Width / length / height, incl. TS 7.5	5 mm / 44 mm / 48 mm			
		Wire strip length	9 mm			
		Approvals				
		Technical data	IEC	UL	CSA	
			EN 60947-7-1			
		Cross section fine-stranded	0.5–2,5 mm ²			
		Cross section solid/stranded	0.5–4 mm ²			
		Cross section, AWG		22–12	24–12	
	Rated current	12 A	20 A	15 A		
	Rated voltage	250 V	300 V	300 V		
	Rated impulse voltage	4 kV				
	Pollution degree	3				
Accessories						
	End plate, gray	Type	AP 2,5 U/8113 S/H	Part No.	07.311.9855.0	
	Coding strip	Type		Part No.	05.584.0053.0	
	Locking piece 10 pole	Type		Part No.	05.576.5853.0	

Type 8113 B/..., 8313 B/...

- Mating orientation parallel to wire entry
- For additional pluggable blocks, see **wiecon** product family



Description	Type	Part No.	Std. Pack
Spacing 5.00 mm, Rated voltage 250 V			
unmarked, starting at 2	8113 B/2 OB	25.320.3253.0	100
up to 16	8113 B/16 OB	25.320.4653.0	50
marked with 1- x, starting at 2	8113 B/2	25.320.0253.0	100
up to 16	8113 B/16	25.320.1653.0	50
Spacing 7.50 mm, Rated voltage 400 V			
unmarked, starting at 2	8313 B/2 OB	25.360.3253.0	100
up to 12	8313 B/12 OB	25.360.4253.0	50
marked with 1- x, starting at 2	8313 B/2	25.360.0253.0	100
up to 12	8313 B/12	25.360.1253.0	50
General data			
Approvals			
Technical data	IEC	UL	CSA
	EN 60947-7-1		
Cross section fine-stranded	0.5–2.5 mm ²		
Cross section solid/stranded	0.5–4 mm ²		
Cross section, AWG	22–12		24–12
Rated current	12 A	15 A	15 A
Rated voltage	250 V	300 V	300 V
Rated impulse voltage	400 V		
Pollution degree			
Accessories			
Coding strip	Type	Part No.	Std. Pack
		05.561.9153.0	100

Type 8113 B/... VR

- Mating orientation 90° towards the wire
- For additional pluggable blocks, see **wiecon** product family

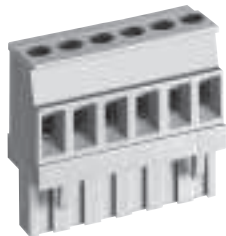

Description	Type	Part No.	Std. Pack
Spacing 5.00 mm, Rated voltage 250 V			
unmarked, starting at 2	8113 B/2 VR OB	25.325.3253.0	100
up to 16	8113 B/16 VR OB	25.325.4653.0	50
marked with 1- x, starting at 2	8113 B/2	25.325.0253.0	100
up to 16	8113 B/16	25.325.1653.0	50
General data			
Approvals			
Technical data	IEC	UL	CSA
	EN 60947-7-1		
Cross section fine-stranded	0.5–2.5 mm ²		
Cross section solid/stranded	0.5–4 mm ²		
Cross section, AWG	22–12		24–12
Rated current	12 A	15 A	15 A
Rated voltage	250 V	300 V	300 V
Rated impulse voltage	400 V		
Pollution degree			
Accessories			
Coding strip	Type	Part No.	Std. Pack
		05.561.9153.0	100

Accessories for **selos** WK 2,5 U/...



Accessories	Type	Part No.	Std. Pack	
Cross connector with screws, insulated	2 pole	VB WK 2,5-2	Z7.280.2227.0	10
	3 pole	IVB WK 2,5-3	Z7.280.2327.0	10
	12 pole	IVB WK 2,5-12	Z7.280.3227.0	10
Partition plate with marking facility	yellow	TS 2,5 GELB	07.311.2053.8	10
Single cover with marking facility	yellow	AD VB 2,5 GELB	04.326.2053.8	10
Cover strip for PCB terminal	24 pole		04.343.9056.8	10
with warning symbol	24 pole		04.343.9156.8	10
Connection rail	L = 0,4 m		05.561.4115.0	1
for connection to power block (blue) and indicator				

Distribution blocks with screw/push-on connection

WK/4-8 S/IW/U

- Feed-through block with push-on connection for mounting on TS 35
- Push-on connectors 2.8 x 0.8 acc. to DIN 46247
Push-on connectors 6.3 x 0.8 acc. to DIN 46247
- Current carrying capability according to DIN 46249
Tab connector 2.8 10A
 6.3 20A



Description	Type	Part No.	Std. Pack
Feed-through block, gray	WK/4-8 S/IW/U	57.504.6355.0	100
General data			
Width / length / height, incl. TS 7.5	6 mm / 67 mm / 50 mm		
Wire strip length			
Approvals			
Technical data	IEC	UL	CSA
	EN 60947-7-1, EN 61210		
Cross section fine-stranded			
Cross section solid/stranded			
Cross section, AWG	22-12		
Rated current	20 A	10 A	10 A
Rated voltage	800 V ⁽¹⁾	600 V ⁽¹⁾	300 V ⁽¹⁾
Rated impulse voltage	8 kV		
Pollution degree	3		
Accessories			
End plate, gray	Type AP 3 S/IW	Part No. 07.311.4355.0	Std. Pack 50
Cross connector with screws	2 pole VB WK/...S/IW/U-2	Z7.281.3227.0	10
	3 pole VB WK/...S/IW/U-3	Z7.281.3327.0	10
	up to 6 pole VB WK/...S/IW/U-6	Z7.281.3627.0	10

WK/4-8 S/U

- Feed-through block with push-on connection for mounting on TS 35
- Push-on connectors 2.8 x 0.8 acc. to DIN 46247
Push-on connectors 6.3 x 0.8 acc. to DIN 46247
- Current carrying capability according to DIN 46249
Tab connector 2.8 10A
 6.3 20A



Description	Type	Part No.	Std. Pack
Feed-through block, gray	WK/4-8 S/U	57.504.6255.0	100
General data			
Width / length / height, incl. TS 7.5	6 mm / 67 mm / 40 mm		
Wire strip length			
Approvals			
Technical data	IEC	UL	CSA
	EN 60947-7-1, EN 61210		
Cross section fine-stranded			
Cross section solid/stranded			
Cross section, AWG	22-12		
Rated current	20 A	10 A	10 A
Rated voltage	800 V ⁽¹⁾	300 V ⁽¹⁾	300 V ⁽¹⁾
Rated impulse voltage	8 kV		
Pollution degree	3		
Accessories			
End plate, gray	Type AP 4 S	Part No. 07.311.4255.0	Std. Pack 10
Cross connector with screws	2 pole 9703/6-2	Z7.211.0227.0	50
	3 pole 9703/6-3	Z7.211.0327.0	50
	up to 6 pole 9703/6-6	Z7.211.0627.0	50

WK/3-6 S KO/U

- Feed-through block with push-on connection for mounting on TS 35
- Nominal cross section 4,0 mm²
- Push-on connectors 2.8 x 0.8 acc. to DIN 46247
Push-on connectors 6.3 x 0.8 acc. to DIN 46247
- Current carrying capability according to DIN 46249
Tab connector 2.8 10A
 6.3 20A

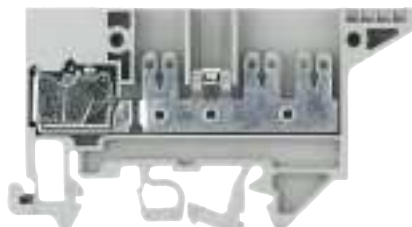

Description	Type	Part No.	Std. Pack
Feed-through block, gray	WK/3-6 S KO/U	57.504.7355.0	100
General data			
Width / length / height, incl. TS 7.5	6 mm / 72 mm / 40 mm		
Wire strip length	9 mm		
Approvals			
Technical data	IEC	UL	CSA
For use with insulating sleeves	EN 60947-7-1, EN 61210		
Cross section fine-stranded	0.5-4 mm ²		
Cross section solid/stranded	0.5-4 mm ²		
Cross section, AWG	22-12		
Rated current	20 A	10 A	10 A
Rated voltage	690 V ⁽¹⁾	300 V ⁽¹⁾	300 V ⁽¹⁾
Rated impulse voltage	8 kV		
Pollution degree	3		
Accessories			
End plate, gray	Type 9701 A/6 1 S KO TP 2	Part No. 07.310.5855.0	Std. Pack 10
Cross connector with screws	2 pole 2072/2	Z7.220.0227.0	50
	3 pole 2072/2	Z7.220.0227.0	50
	up to 6 pole 2072/6	Z7.220.0627.0	50

WK 4 3-6 S 1 K/U

- Feed-through block with push-on connection for mounting on TS 35
- Nominal cross section 4 mm²
- Push-on connectors 2.8 x 0.8 acc. to DIN 46247
- Push-on connectors 6.3 x 0.8 acc. to DIN 46247
- Current carrying capability according to DIN 46249

Tab connector	2.8	10A
	6.3	20A

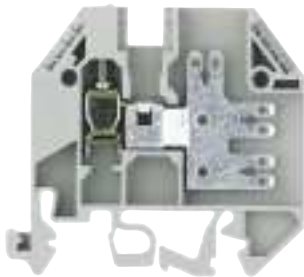

Description	Type	Part No.	Std. Pack
Feed-through block, gray	WK 4 3-6 S 1 K/U	57.504.3755.0	100
General data			
Width / length / height, incl. TS 7.5	6 mm / 52 mm / 48 mm		
Wire strip length	9 mm		
Approvals			
Technical data	IEC	UL	CSA
	EN 60947-7-1, EN 61 210		
Cross section fine-stranded	0.5–4 mm ²		
Cross section solid/stranded	0.5–6 mm ²		
Cross section, AWG		22–12	22–12
Rated current	20 A	10 A	10 A
Rated voltage	800 V ¹⁾	300 V ¹⁾	300 V ¹⁾
Rated impulse voltage	8 kV		
Pollution degree	3		
Accessories			
End plate, gray	AP4 3 S 1 K	07.311.3855.0	10
Cross connector with screws	2 pole	IVB WK 4-2	Z7.281.1227.0
	3 pole	IVB WK 4-3	Z7.281.1327.0
	up to 12 pole	IVB WK 4-12	Z7.281.2227.0

WK/5-10 S/U

- Feed-through block with push-on connection for mounting on TS 35
- Push-on connectors 2.8 x 0.8 acc. to DIN 46247
- Push-on connectors 6.3 x 0.8 acc. to DIN 46247
- Current carrying capability according to DIN 46249

Tab connector	2.8	10A
	6.3	20A



Description	Type	Part No.	Std. Pack
Feed-through block, gray	WK/5-10 S/U	57.504.3655.0	100
General data			
Width / length / height, incl. TS 7.5	6 mm / 52 mm / 48 mm		
Wire strip length	9 mm		
Approvals			
Technical data	IEC	UL	CSA
	EN 60947-7-1, EN 61 210		
Cross section fine-stranded	0.5–4 mm ²		
Cross section solid/stranded	0.5–6 mm ²		
Cross section, AWG		22–12	22–12
Rated current	20 A	10 A	10 A
Rated voltage	800 V ¹⁾	300 V ¹⁾	300 V ¹⁾
Rated impulse voltage	8 kV		
Pollution degree	3		
Accessories			
End plate, gray	AP 5 S	07.311.4655.0	10
Cross connector with screws	2 pole	IVB WKI 4-2	Z7.271.4227.0
	3 pole	IVB WKI 4-3	Z7.271.4327.0
	up to 12 pole	IVB WKI 4-12	Z7.271.5227.0

Accessories for *selos* WK/...

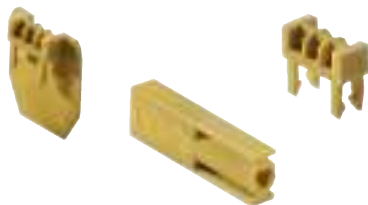

Accessories	Type	Part No.	Std. Pack
Partition plate with marking facility	yellow TS 4 GELB	07.311.2153.8	10
Single cover with marking facility	yellow AD VB 4 GELB	04.326.2153.8	10
Insulating sleeve for tab connector for H0. V-K 1.5 mm ²	yellow	05.592.7553.0	2000
for H0. V-K 2.5 mm ²	yellow	05.592.7653.0	2000

¹⁾ Rating for use with insulating sleeves

Function blocks with screw connection

9786 U/12

- Function block with screw connection for mounting on TS 35 and TS 32
- Nominal cross section 2.5 mm²



Description	Type	Part No.	Std. Pack
Function block empty	9786 U/12	57.904.2055.0	50
with bridge rectifier B380 C1500	9786 U/12 G4	57.904.2555.0	50
with optocoupler CNY 17/3	9786 U/12 OPK	57.904.2855.0	50

General data

Width / length / height, incl. TS 7.5	12 mm / 52 mm / 58 mm
Wire strip length	9 mm
Approvals	

Technical data

	IEC	UL	CSA
	EN 60947-7-1		
Cross section fine-stranded	0.5–2.5 mm ²		
Cross section solid/stranded	0.5–2.5 mm ²		
Cross section, AWG			22–14
Rated current	24 A		6 A
Rated voltage	800 V		300 V
Rated impulse voltage	8 kV		
Pollution degree	3		

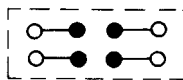

9785 U/... - SPT

- Compensating terminal with screw connection for mounting on TS 35 and TS 32
- Nominal cross section 2.5 mm²

Resistor range: 0.25Ω up to 100Ω
 Resistor tolerance: ± 10%
 Resistor range: 100Ω up to 50kΩ
 Resistor tolerance: ± 20%
 Limite continuous resistance value: 0.75W up to 70°C
 Max. load: 100mA
 Temperature coefficient: 0 up to +500ppm/°C
 Max. operating voltage: 300V



Description	Type	Part No.	Std. Pack	
Compensating terminal, gray with potentiometer	10 Ω	9785 U/10 Ω	57.904.0055.0	50
	20 Ω	9785 U/20 Ω	57.904.0155.0	50
	50 Ω	9785 U/50 Ω	57.904.0255.0	50
	100 Ω	9785 U/100 Ω	57.904.0355.0	50
	200 Ω	9785 U/200 Ω	57.904.0455.0	50
	510 Ω	9785 U/500 Ω	57.904.0555.0	50
	1 kΩ	9785 U/1 kΩ	57.904.0655.0	50
	2 kΩ	9785 U/2 kΩ	57.904.0755.0	50
	5 kΩ	9785 U/5 kΩ	57.904.0855.0	50
	10 kΩ	9785 U/10 kΩ	57.904.0955.0	50
Compensating terminal, gray with potentiometer as voltage divider	20 kΩ	9785 U/20 kΩ	57.904.1055.0	50
	50 kΩ	9785 U/50 kΩ	57.904.1155.0	50
	10 Ω	9785 U/10 Ω-SPT	57.904.3955.0	50
	20 Ω	9785 U/20 Ω-SPT	57.904.4155.0	50
	50 Ω	9785 U/50 Ω-SPT	57.904.4255.0	50
	100 Ω	9785 U/100 Ω-SPT	57.904.4355.0	50
	200 Ω	9785 U/200 Ω-SPT	57.904.4455.0	50
	510 Ω	9785 U/500 Ω-SPT	57.904.4555.0	50
	1 kΩ	9785 U/1 kΩ-SPT	57.904.4655.0	50
	2 kΩ	9785 U/2 kΩ-SPT	57.904.4755.0	50
	5 kΩ	9785 U/5 kΩ-SPT	57.904.4855.0	50
	10 kΩ	9785 U/10 kΩ-SPT	57.904.4955.0	50
	20 kΩ	9785 U/20 kΩ-SPT	57.904.5055.0	50
	50 kΩ	9785 U/50 kΩ-SPT	57.904.5155.0	50

General/Technical data

Width / length / height, incl. TS 7.5	12 mm / 49 mm / 58 mm
Wire strip length	9 mm
Approvals	EN 60947-7-1
Cross section fine-stranded	0.5–2.5 mm ²
Cross section solid/stranded	0.5–2.5 mm ²

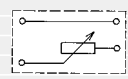
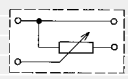
9786 U/TSK...

- Thermocouple terminal with screw connection for mounting on TS 35 and TS 32
- Nominal cross section 2,5 mm²



Description	Type	Part No.	Std. Pack
Thermocouple terminal type T-Cu/CuNi 44	9786 U/TSK Cu-CuNi	57.904.7355.0	50
Thermocouple terminal type E-NiCr/CuNi 44	9786 U/TSK NiCr-CuNi	57.904.7055.0	50
Thermocouple terminal type J-Fe/CuNi 44	9786 U/TSK Fe-CuNi	57.904.7155.0	50
Thermocouple terminal type K-NiCr/Ni	9786 U/TSK NiCr-Ni	57.904.7255.0	50
Thermocouple terminal type R-PtRh 13/Pt	9786 U/TSK E-Cu-A-Cu	57.904.7455.0	50

General data

Width / length / height, incl. TS 7.5	12 mm / 52 mm / 58 mm
Wire strip length	9 mm
Approvals	

Technical data

	IEC	UL	CSA
	EN 60947-7-1		
Cross section fine-stranded	0.5–2.5 mm ²		
Cross section solid/stranded	0.5–2.5 mm ²		
Rated voltage	800 V		
Rated impulse voltage	8 kV		
Pollution degree	3		

Example:
 Fe/constantan Fe/CuNi 44
 fully enclosed design

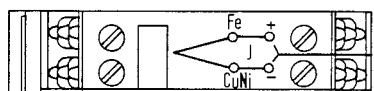

9786 U/12

- Ground disconnect with screw connection for mounting on TS 35 and TS 32
- Nominal cross section 6 mm²



Description	Type	Part No.	Std. Pack
Ground disconnect 24-48V≅ with LED	9760 U/8 TKE 48	57.110.1655.0	25
110-220V≅ with indicator lamp	9760 U/8 TKE 220	57.110.1555.0	25
General data			
Width / length / height, incl. TS 7.5	17,5 mm / 71 mm / 52 mm		
Wire strip length	9 mm		
Approvals			
Technical data	IEC	UL	CSA
	EN 60947-7-1		
Cross section fine-stranded	1.0-10 mm ²		
Cross section solid/stranded	1.0-10 mm ²		
Cross section, AWG		18-8	18-8
Rated current	30 A	25 A	25 A
Rated voltage	24-48 V / 110-220 V	48 V / 220 V	48 V / 220 V
Rated impulse voltage			
Pollution degree			

EN 60204 part 1/DIN VDE 0113 part 1 "Fitting industrial machines with electrical equipment"

9.4.3.1. Ground faults.

Ground faults in any control circuits must not result in unintentional startup, potentially hazardous motions or shutdown of the machine.

During normal operation the auxiliary circuit is connected to the functional ground and the green (24-48V) or yellow (110-220V) status display is illuminated.

If a low resistance ground fault occurs, the line fuse will blow.

Once the contact separator is open, you can replace the fuse.

The illumination of the red lamp alone indicates an ground fault.

After the fault had been rectified, the green (24-48V) or yellow (110-220V) display will also light up. The contacts should now be moved to the "on" position as a result of which the red lamp will go out.

The illumination of the yellow or green lamp and external display indicates that the auxiliary circuit has been reconnected to the functional ground.

Ground Disconnect terminal with LED 24-48V≅

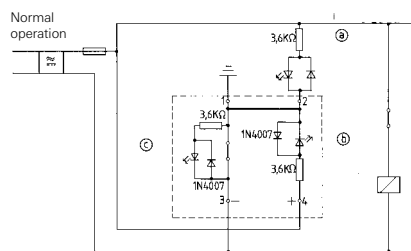

- (a) external status display lights up
- (b) green status display lights up
- (c) red ground-fault indicator lights up

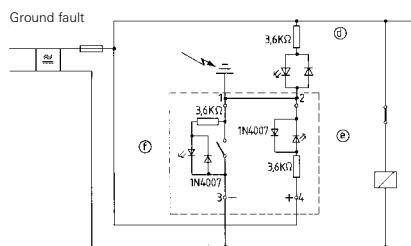

- (d) external status display lights up
- (e) green status display lights up
- (f) red ground-fault indicator lights up

Ground Disconnect terminal with Neon Lamp 110-220 V≅

Normal operation

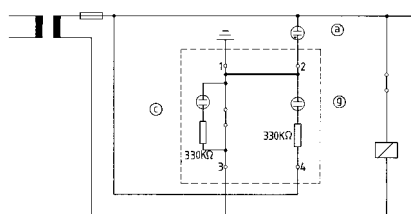

- (g) yellow status display lights up

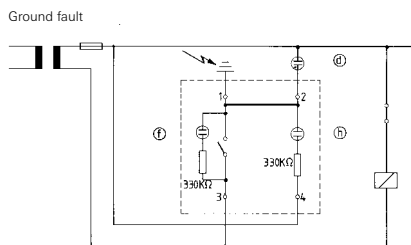

- (h) yellow indicator light not flashing

Instrument isolating terminal with screw connection

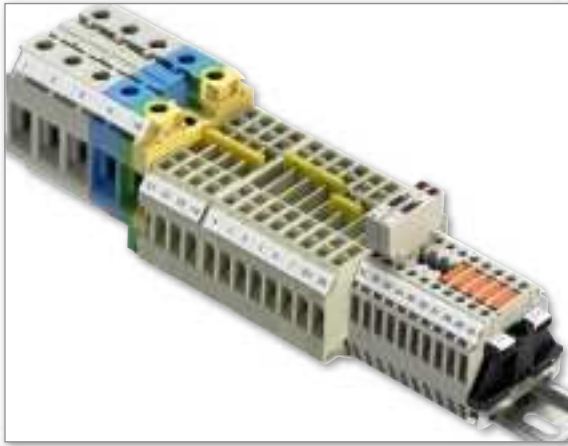

Wieland Electric's **selos** WKN 6 TK block offers a simple and effective DIN rail block solution for use in measuring circuits for current, voltage or energy. All circuits in everyday practice can be neatly implemented with the instrument isolating terminal and a few accessory parts. Only two blocks are needed for simple transformer circuits.

The main focus during the development of this block was clear and simple handling as well as universal application. All switching states of the block and the converter circuit are clearly recognizable and the extensive accessory program is easy to use.

The block and the accessories meet the requirements of protection against accidental finger touch as per BGV A2.

Technical data as per EN 60947-7:

Rated cross section:	6 mm ²	Rated current:	57 A
Rated voltage:	400 V	Connection capacity:	0.5 - 10 mm ²

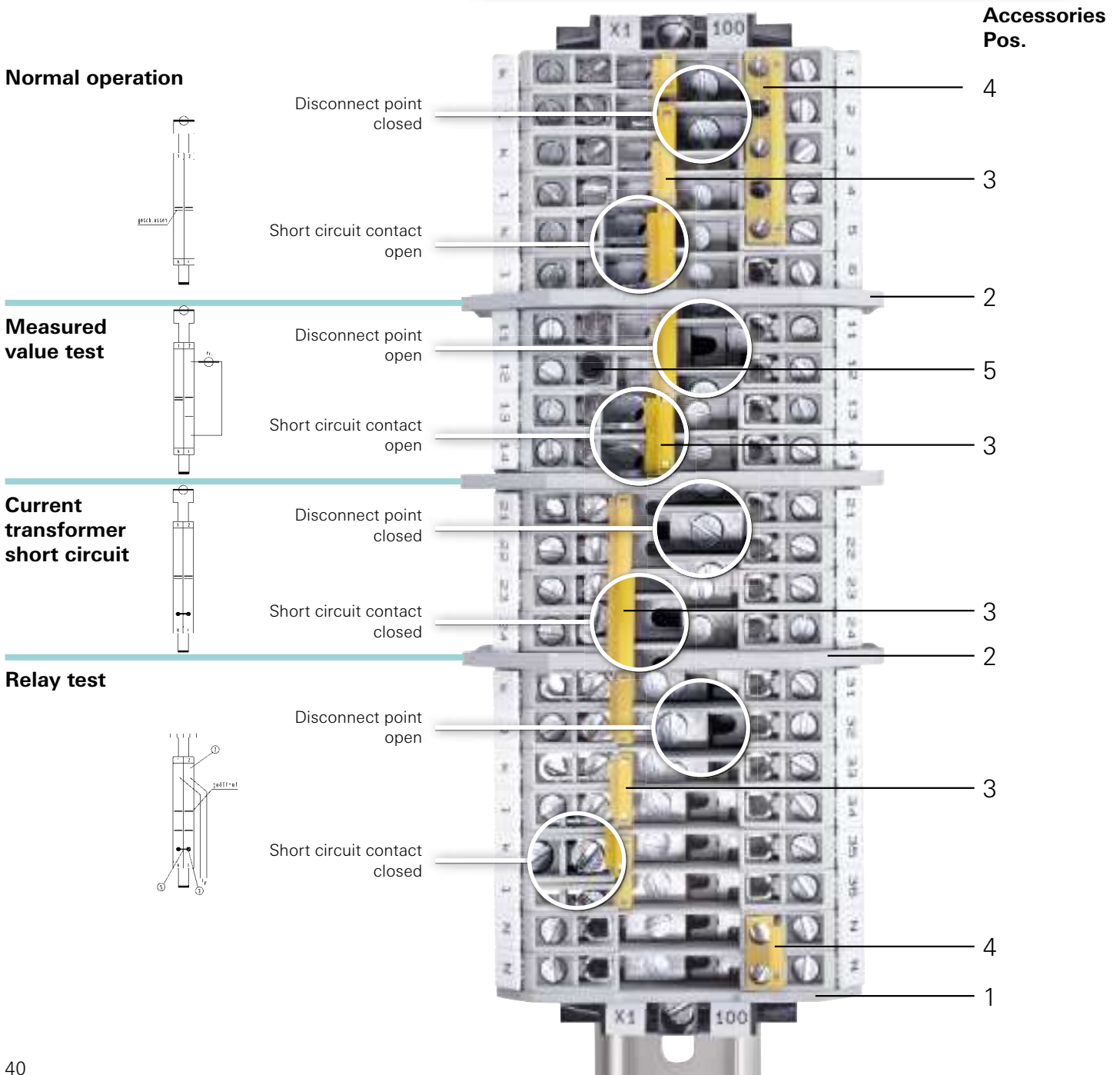

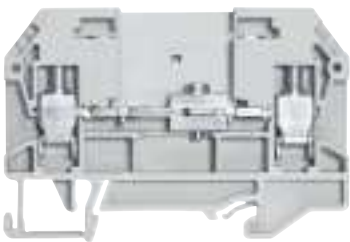
<p>WKN 6 TK</p> <ul style="list-style-type: none"> • Instrument isolating terminal for mounting on TS 35 • Nominal cross section 6 mm² 	Description		Type	Part No.	Std. Pack	
	Instrument isolating terminal		WKN6 TK	56.106.0055.0	50	
	Feed-through block		WKN6 TK D	56.106.0155.0	50	
	General data					
	Width / length / height, incl. TS 7.5		8 mm / 73 mm / 58 mm			
	Wire strip length		12 mm			
	Approvals					
	Technical data		IEC	UL	CSA	
			EN 60947-7-1			
	Cross section fine-stranded		0.5–6 mm ²			
	Cross section solid/stranded		0.5–10 mm ²			
	Cross section, AWG					
	Rated current		57 A			
	Rated voltage		500 V			
Rated impulse voltage		6 kV				
Pollution degree		3				

<p>WKN 6 TK SF</p> <ul style="list-style-type: none"> • Instrument isolating terminal with spring support for mounting on TS 35 • Nominal cross section 6 mm² 	Description		Type	Part No.	Std. Pack	
	Instrument isolating terminal		WKN6 TK SF	56.106.0755.0	50	
	Feed-through block		WKN6 TK SFD	56.106.0855.0	50	
	General data					
	Width / length / height, incl. TS 7.5		8 mm / 73 mm / 58 mm			
	Wire strip length		12 mm			
	Approvals					
	Technical data		IEC	EA TS 50-18		
			EN 60947-7-1			
	Cross section fine-stranded		0.5–6 mm ²			
	Cross section solid/stranded		0.5–10 mm ²			
	Cross section, AWG					
	Rated current		57 A	25 A		
	Rated voltage		500 V	500 V		
Rated impulse voltage		6 kV				
Pollution degree		3				

Accessories for *selos* WKN 6 TK...

Accessories		Type	Part No.	Std. Pack
1. End plate	2 mm	APN 6 TK	07.313.1755.0	10
2. Partition		TW 6 TK	07.312.0453.0	10
3. Sliding short-circuit slide, insulated	2 pole	IVS WKN6 TK-2	Z7.282.7229.0	10
	3 pole	IVS WKN6 TK-3	Z7.282.7329.0	10
	4 pole	IVS WKN6 TK-4	Z7.282.7429.0	10
	5 pole	IVS WKN6 TK-5	Z7.282.7529.0	10
4. Cross connector with screws, insulated	2 pole	IVB WKN6 TK-2	Z7.282.6229.0	10
	3 pole	IVB WKN6 TK-3	Z7.282.6329.0	10
	4 pole	IVB WKN6 TK-4	Z7.282.6429.0	10
	5 pole	IVB WKN6 TK-5	Z7.282.6529.0	10
	6 pole	IVB WKN6 TK-6	Z7.282.6629.0	10
	5. Test socket	gray	SBN 4 GRAU	Z5.511.3553.0
	violet	SBN 4 VIOLETT	Z5.511.3553.9	10
	green	SBN 4 GRÜN	Z5.511.3553.7	10
	yellow	SBN 4 GELB	Z5.511.3553.8	10
	blue	SBN 4 BLAU	Z5.511.3553.6	10
6. Disconnect locking device		SP WKN 6 TK	05.566.6855.9	50
Jumper comb for WKN 6 TK	2 pole	IVK WKN 6TK-2	Z7.255.8227.0	10
	3 pole	IVK WKN 6TK-3	Z7.255.8327.0	10
	4 pole	IVK WKN 6TK-4	Z7.255.8427.0	10
	5 pole	IVK WKN 6TK-5	Z7.255.8527.0	10
	6 pole	IVK WKN 6TK-6	Z7.255.8627.0	10

Instrument isolating terminal with screw connection WK6 TK



Wieland Electric's **selos** WK 6 TK block offers an optimal DIN rail block solution for all types of measuring circuits of current, voltage or energy. All circuits occurring during everyday practice can be implemented with the Instrument isolating terminal and a few accessories.

Complete insulated selectable connecting links are available as standard, as are insulated test sockets in all conventional signal colors. Two additional jumpering facilities permit the installation of fixed cross connections (e.g., for internal distribution of the k point of converter circuits). Standard cross connectors in a wide variety of numbers of pins are available for this purpose. The jumpers are easy to disconnect so that you can skip over blocks.

Technical data as per EN 60947-7:

Rated cross section:	6 mm ²	Rated current:	32A
Rated voltage:	400V	Connection capacity:	0.5-10mm ²

Normal operation

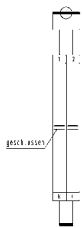

Disconnect point closed

Short circuit contact open

Measured value test

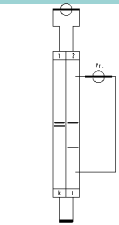

Disconnect point open

Short circuit contact open

Current transformer short circuit



Disconnect point closed

Short circuit contact closed

Relay test

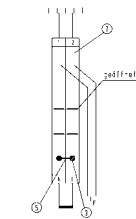

Disconnect point open

Short circuit contact closed

Accessories Pos.

4 (yellow)

4 (green)

5

4 (violet)

2

1

4 (gray)

2

4 (blue)

3

Description	Type	Part No.	Std. Pack
General data			
Width / length / height, incl. TS 7.5	8 mm / 87 mm / 49 mm		
Wire strip length	12 mm		
Approvals			
Technical data			
For use with insulating sleeves	EN 60947-7-1		
Cross section fine-stranded	0.5–6 mm ²		
Cross section solid/stranded	0.5–10 mm ²		
Cross section, AWG		20–8	20–8
Rated current	32 A	45 A	45 A
Rated voltage	400 V	600 V	300 V
Rated impulse voltage	6 kV		
Pollution degree	3		

WK6 TK/35

- Instrument isolating terminal for mounting on TS 35
- Nominal cross section 6 mm²



Description	Type	Part No.	Std. Pack
General data			
Width / length / height, incl. TS 7.5	8 mm / 87 mm / 62 mm		
Wire strip length	12 mm		
Approvals			
Technical data			
For use with insulating sleeves	EN 60947-7-1		
Cross section fine-stranded	0.5–6 mm ²		
Cross section solid/stranded	0.5–10 mm ²		
Cross section, AWG		20–8	20–8
Rated current	32 A	45 A	45 A
Rated voltage	400 V	600 V	300 V
Rated impulse voltage	6 kV		
Pollution degree	3		

WK6 TK P3/35

- Instrument isolating terminal with mounted test sockets for mounting on TS 35
- Nominal cross section 6 mm²

**Accessories for selos WK6 TK.../35**

Accessories	Type	Part No.	Std. Pack
1. Partition	TW 6 TK	07.312.0453.0	10
2. Sliding short-circuit slide, insulated	2 pole	IVS WK6 TK-2	Z7.212.2227.0
	3 pole	IVS WK6 TK-3	Z7.212.2327.0
	4 pole	IVS WK6 TK-4	Z7.212.2427.0
3. Cross connector with screws, insulated	2 pole	IVB WK6 TK-2	Z7.212.1227.0
	3 pole	IVB WK6 TK-3	Z7.212.1327.0
	4 pole	IVB WK6 TK-4	Z7.212.1427.0
	5 pole	IVB WK6 TK-5	Z7.212.1527.0
	10 pole	IVB WK6 TK-10	Z7.212.2027.0
4. Test socket	gray	SB 4 GRAU	05.511.2953.0
	violet	SB 4 VIOLETT	05.511.2953.9
	green	SB 4 GRÜN	05.511.2953.7
	yellow	SB 4 GELB	05.511.2953.8
	blue	SB 4 BLAU	05.511.2953.6
5. Disconnect locking device	SP WK6 TK	05.563.5453.0	50

Screw type terminal blocks with spring support

WKN 6 SF

- Feed-through block with spring support for mounting on TS 35 and TS 32
- Nominal cross section 6 mm²



Description	Type	Part No.	Std. Pack
Feed-through block, gray	WKN 6 SF	57.506.0555.0	100
General data			
Width / length / height, incl. TS 7.5	8 mm / 54 mm / 57 mm		
Wire strip length	11 mm		
Approvals			
Technical data		IEC	EA TS 50-18
	EN 60947-7-1		
Cross section fine-stranded	0.5–6 mm ²		
Cross section solid/stranded	0.5–10 mm ²		
Cross section, AWG			
Rated current	41 A	30 A	
Rated voltage	800 V	500 V	
Rated impulse voltage	8 kV		
Pollution degree	3		
Accessories			
End plate, gray	APN 6 SF	07.313.2355.0	10
Partition, gray	TW 6 TK	07.312.0453.0	10
Cross connector with screws	2 pole	IVB WK 6 - 2	10
insulated	3 pole	IVB WK 6 - 3	10
	up to 12 pole	IVB WK 6 - 12	10
Single cover f. cross conn. with marking facility		AD VB 6 GELB	10
Cover with warning symbol	yellow	AD VB 8/4 GELB	10

WKN 10 SF

- Feed-through block with spring support for mounting on TS 35 and TS 32
- Nominal cross section 10 mm²



Description	Type	Part No.	Std. Pack
Feed-through block, gray	WKN 10 SF	57.510.0555.0	100
General data			
Width / length / height, incl. TS 7.5	10 mm / 55 mm / 64 mm		
Wire strip length	13 mm		
Approvals			
Technical data		IEC	EA TS 50-18
	EN 60947-7-1		
Cross section fine-stranded	2.5–10 mm ²		
Cross section solid/stranded	1.5–16 mm ²		
Cross section, AWG			
Rated current	57 A	30 A	
Rated voltage	800 V	500 V	
Rated impulse voltage	8 kV		
Pollution degree	3		
Accessories			
End plate, gray	APN 10 SF	07.313.2455.0	10
Partition, gray	TW 6 TK	07.312.0453.0	10
Cross connector with screws	2 pole	IVB WK 10 - 2	10
insulated	3 pole	IVB WK 10 - 3	10
	up to 12 pole	IVB WK 10 - 12	10
Single cover f. cross conn. with marking facility		AD VB 10 GELB	10
Cover with warning symbol	yellow	AD VB 10/4 GELB	10

DIN rail terminal blocks with ring lug connection

Description		Type	Part No.	Std. Pack
Feed-through block, gray		WRT 6	57.106.1155.0	100
General data				
Width / length / height, incl. TS 7.5		11 mm / 49 mm / 51 mm		
Wire strip length		10 mm		
Approvals				
Technical data		IEC	UL	CSA
		EN 60947-7-1		
Cross section fine-stranded		1.5–6 mm ²		
Cross section solid/stranded		1.5–6 mm ²		
Cross section, AWG		22–8		
Rated current		41 A	50 A	50 A
Rated voltage		1000 V	600 V	600 V
Rated impulse voltage		8 kV		
Pollution degree		3		
Accessories				
		Type	Part No.	Std. Pack
End plate, gray		APRT 6	07.300.6955.0	10
Partition, gray		TW 6 TK	07.312.0453.0	10
Cross connector, insulated		2 pole	IVB WRT 6 TK - 2	10
		3 pole	IVB WRT 6 TK - 3	10
		4 pole	IVB WRT 6 TK - 4	10

WRT 6

- Feed-through block with ring lug connection for mounting on TS 35
- Nominal cross section 6 mm²



Description		Type	Part No.	Std. Pack
Instrument isolating terminal, gray		WRT 6 TK	57.106.1055.0	100
General data				
Width / length / height, incl. TS 7.5		11 mm / 86 mm / 51 mm		
Wire strip length		10 mm		
Approvals				
Technical data		IEC	UL	CSA
		EN 60947-7-1		
Cross section fine-stranded		1.5–6 mm ²		
Cross section solid/stranded		1.5–6 mm ²		
Cross section, AWG		22–8		
Rated current		41 A	35 A	35 A
Rated voltage		1000 V	600 V	600 V
Rated impulse voltage		8 kV		
Pollution degree		3		
Accessories				
		Type	Part No.	Std. Pack
End plate, gray		APRT 6	07.300.6955.0	10
Partition, gray		TW 6 TK	07.312.0453.0	10
Cross connector, insulated		2 pole	IVB WRT 6 TK - 2	10
		3 pole	IVB WRT 6 TK - 3	10
		4 pole	IVB WRT 6 TK - 4	10

WRT 6 TK

- Instrument isolating terminal with ring lug connection for mounting on TS 35
- Nominal cross section 6 mm²



High current terminal blocks with screw connection



selos POWER LINE is designed for use in mechanical and plant engineering, railway, and battery applications.

Wieland offers a program which was especially developed for high current applications. The portfolio includes feed through blocks and ring lug terminals. The RFK type feed through blocks include four different cross sections between 95 and 240 mm² with different types of connection (e.g., rising cage or ring lug connection).

Ring lug terminals augment the **selos** POWER LINE product line. Blocks with ring lug sizes from M 6 to M 12 are available for the connection of wires with crimped cable lugs.

Extensive accessories optimize the **selos** POWER LINE for a wide variety of applications.

Technical data as per EN 60947-7:

Rated cross section:	95 mm ² -240 mm ²	Rated current: up to 415A
Rated voltage:	1000V	



High current blocks, type RFK

- Up to 240 mm² rated cross section
- Cable connection via ring lug connection technology, direct connection with rising cage or hybrid solutions
- Current carrying and cross connectors made of E-Cu
- Screws maintain torque via clamping body design, as well as lock washers



Lug ring connection blocks

- For the connection of cable lugs in versions from M 6 to M 12
- Screws maintain torque via lock washers
- Approved for international rail transportation standards



Accessories for **selos** POWER

- Covers for provision of protection against accidental touch
- Cross connectors made of E-Cu; 2, 3 and 4-pole
- Partition plates for visual and electrical separation
- All components can be marked with the standard Wieland marking system



Mounting notice

- When tightening the block screws, we recommend countering by holding the wire to avoid deformation of the mounting rail and to keep the foot of the block free of torsional forces.

BK M .../35

- Ring lug terminal for mounting on TS 35



Type	Width	Height	Rated current
BK M 6	19mm	56mm	125A
BK M 8	24mm	65mm	150A
BK M 10	35mm	72mm	265A
BK M 12	35mm	74mm	265A

Detailed drawing data on request.

Description	Type	Part No.	Std. Pack
Ring lug terminal	BK M 6/35	32.530.0053.0	25
	BK M 8/35	32.540.0053.0	25
	BK M 10/35	32.550.0053.0	25
	BK M 12/35	32.560.0053.0	25
General data			
Width / length / height, incl. TS 7.5			
Wire strip length			
Approvals			
Technical data	IEC	UL	CSA
Cross section fine-stranded			
Cross section solid/stranded			
Cross section, AWG			
Rated current			
Rated voltage	1000 V		
Rated impulse voltage	8 kV		
Pollution degree	3 ¹⁾		
Note	¹⁾ with partition TW BK		
Accessories			
Partition	Type	Part No.	Std. Pack
	for BK M 6	TW BK M 6/35	07.340.3553.0
	for BK M 8	TW BK M 8/35	07.340.3653.0
	for BK M 10	TW BK M 10-12/35	07.340.3753.0
	for BK M 12	TW BK M 10-12/35	07.340.3753.0
Cross connector for tab connection blocks, from E-Cu	Type	Part No.	Std. Pack
	for 2 blocks BK M 6	VB BK M 6/35-2	07.205.5227.0
	for 3 blocks BK M 6	VB BK M 6/35-3	07.205.5327.0
	for 2 blocks BK M 8	VB BK M 8/35-2	07.205.7227.0
	for 3 blocks BK M 8	VB BK M 8/35-3	07.205.7327.0
	for 2 blocks BK M 10	VB BK M 10/35-2	07.205.8227.0
	for 3 blocks BK M 10	VB BK M 10/35-3	07.205.8327.0
	for 2 blocks BK M 12	VB BK M 12/35-2	07.205.9227.0
	for 3 blocks BK M 12	VB BK M 12/35-3	07.205.9327.0
Cover	Type	Part No.	Std. Pack
	for BK M 6	AD BK M 6-8/35	04.304.0181.0
	for BK M 8	AD BK M 6-8/35	04.304.0181.0
	for BK M 10	AD BK M 10-12/35	04.304.0281.0
	for BK M 12	AD BK M 10-12/35	04.304.0281.0
Installation clip for cover		05.564.0753.0	10

High current blocks with screw connection

RFK 1/95... S35

- High current block for mounting on TS 35
- Nominal cross section 95 mm²



Description	Type	Part No.	Std. Pack
Configuration, gray	F RFK 1/95 F S 35	56.395.0055.0	10
	K RFK 1/95 K S 35	56.395.0155.0	10
	FK RFK 1/95 FK S 35	56.395.0255.0	10
	FM RFK 1/95 FM S 35	56.395.1055.0	10
	FMK RFK 1/95 FMK S 35	56.395.1255.0	10
General data			
Width / length / height, incl. TS 7.5	see list		
Wire strip length	27 mm		
Approvals			
Technical data	IEC	UL	CSA
	EN 60947-7-1		
Cross section fine-stranded	16–95 mm ²		
Cross section solid/stranded	16–95 mm ²		
Cross section, AWG		6-3/0	6-3/0
Rated current	250 A	200 A	200 A
Rated voltage	1000 V	600 V	600 V
Rated impulse voltage	8 kV		
Pollution degree	3		
Accessories			
Cover for RFK 1/..., yellow	Type	Part No.	Std. Pack
Partition/end plate	2.8mm thick TE/RFK 1/95	07.340.0353.0	50
Cross connector, from E-Cu	for 2 blocks VB RFK 1/95/2/32	07.205.1227.0	20
	for 3 blocks VB RFK 1/95/3/32	07.205.1327.0	10
	for 4 blocks VB RFK 1/95/4/32	07.205.1427.0	10

RFK 1/150... S35

- High current block for mounting on TS 35
- Nominal cross section 150 mm²



Description	Type	Part No.	Std. Pack
Configuration, gray	F RFK 1/150 F S35	56.397.0055.0	10
	K RFK 1/150 K S35	56.397.0155.0	10
	FK RFK 1/150 FK S35	56.397.0255.0	10
	FMK RFK 1/150 FMK S35	56.397.1255.0	10
General data			
Width / length / height, incl. TS 7.5	see list		
Wire strip length	27 mm		
Approvals			
Technical data	IEC	UL	CSA
	EN 60947-7-1		
Cross section fine-stranded	70–150 mm ²		
Cross section solid/stranded	70–150 mm ²		
Cross section, AWG		0 - 300 MCM	0 - 300 MCM
Rated current	335 A	275 A	300 A
Rated voltage	1000 V	600 V	600 V
Rated impulse voltage	8 kV		
Pollution degree	3		
Accessories			
Cover for RFK 1/..., yellow	Type	Part No.	Std. Pack
Partition/end plate	2.8mm thick TE/RFK 1/150 - 240 PA	07.340.1053.0	50
Cross connector, from E-Cu	for 2 blocks VB RFK 1/185/2	07.201.4227.0	10
	for 3 blocks VB RFK 1/185/3	07.201.4327.0	10
	for 4 blocks VB RFK 1/185/4	07.201.4427.0	10

RFK 1/185... S35

- High current block for mounting on TS 35
- Nominal cross section 185 mm²



Description	Type	Part No.	Std. Pack
Configuration, gray	F RFK 1/185 F S 35	56.398.0055.0	10
	FM RFK 1/185 FM S 35	56.398.1055.0	10
General data			
Width / length / height, incl. TS 7.5	see list		
Wire strip length	27 mm		
Approvals			
Technical data			
For use with insulating sleeves	EN 60947-7-1		
Cross section fine-stranded			
Cross section solid/stranded			
Cross section, AWG		0 - 400 kcmil	0 - 400 kcmil
Rated current	353 A	375 A	375 A
Rated voltage	1000 V	600 V	600 V
Rated impulse voltage	8 kV		
Pollution degree	3		
Accessories			
Cover for RFK 1/..., yellow		Z7.409.5853.0	10
Partition/end plate	2.8 mm thick TE/RFK 1/150 - 240 PA	07.340.1053.0	50
Cross connector, from E-Cu	for 2 blocks VB RFK 1/185/2	07.201.4227.0	10
	for 3 blocks VB RFK 1/185/3	07.201.4327.0	10
	for 4 blocks VB RFK 1/185/4	07.201.4427.0	10

RFK 1/240... S35

- High current block for mounting on TS 35
- Nominal cross section 240 mm²
- *) Use only cable lugs type DIN 46234



Description	Type	Part No.	Std. Pack
Configuration, gray	F RFK 1/240 F S 35*)	56.399.0055.0	10
	K RFK 1/240 K S 35	56.399.0155.0	10
	FK RFK 1/240 FK S 35*)	56.399.0255.0	10
	FM RFK 1/240 FM S 35*)	56.399.1055.0	10
	FMK RFK 1/240 FMK S 35*)	56.399.1255.0	10
General data			
Width / length / height, incl. TS 7.5	see list		
Wire strip length	27 mm		
Approvals			
Technical data			
For use with insulating sleeves	EN 60947-7-1		
Cross section fine-stranded	70 - 240 mm ²		
Cross section solid/stranded	70 - 240 mm ²		
Cross section, AWG		0 - 500 kcmil	3/0 - 500 kcmil
Rated current	415 A	375 A	425 A
Rated voltage	1000 V	600 V	600 V
Rated impulse voltage	8 kV		
Pollution degree	3		
Accessories			
Cover for RFK 1/..., yellow		Z7.409.5853.0	10
Partition/end plate	2.8 mm thick TE/RFK 1/150 - 240 PA	07.340.1053.0	50
Cross connector, from E-Cu	for 2 blocks VB RFK 1/240/2	07.201.8227.0	10
	for 3 blocks VB RFK 1/240/3	07.201.8327.0	10
	for 4 blocks VB RFK 1/240/4	07.201.8427.0	10

Configurations

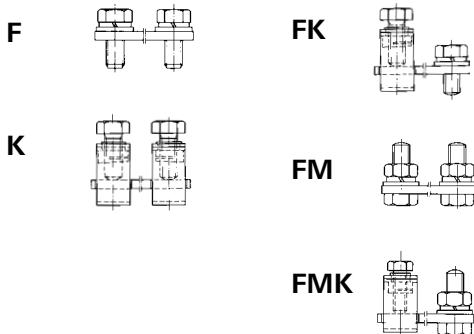





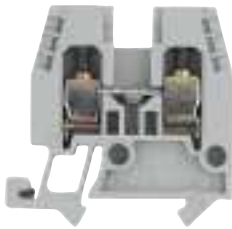

mm ²	Type	Screw	Width mm	Length mm	Height, incl. TS 7,5 mm
95	F	M10	32	92	55
	FM	M10	32	92	65
	K, FK, FMK	M10	32	92	78
150	F	M12	42	92	55
	K, FK, FMK	M12	42	92	78
185	F	M12	42	92	55
	FM	M12	42	92	70
240	F	M12	42	92	55
	FM	M12	42	92	77
	K, FK, FMK	M12	42	92	93

Mini blocks with screw connection for TS 15

WKM 2,5/15

- Feed-through block for mounting on TS 15
- Nominal cross section 2.5 mm²
- Ex e I/II  II 2GD IM2
Follow the EX installation instructions on page 143









Description	Type	Part No.	Std. Pack
Feed-through block, gray	WKM 2,5/15	55.503.1053.0	100
Feed-through block, blue	WKM 2,5/15 BLAU	55.503.1053.6	100
General data			
Width / length / height, incl. TS 7.5	5 mm / 32 mm / 32 mm		
Wire strip length	9 mm		
Approvals	      KEMA 02 ATEX 2114 U		
Technical data			
	IEC	UL	CSA
	EN 60 947-7-1		EN 60 079-0/-7
Cross section fine-stranded	0.5–2.5 mm ²		
Cross section solid/stranded	0.5–4 mm ²		
Cross section, AWG			
Rated current	25 A	10 A	20 A
Rated voltage	500 V	300 V	275 V
Rated impulse voltage	6 kV		
Pollution degree	3		
Accessories			
	Type	Part No.	Std. Pack
End plate	gray	APM 2,5 - 4/15	07.311.0853.0
	blue	APM 2,5 - 4/15 BLAU	07.311.0853.6
Partition	gray	TWM 2,5 - 4/15	07.311.1853.0
Cross connector with screws, E-Cu	2 pole	VB WKM 2,5/15-2	Z7.215.4227.0
	3 pole	VB WKM 2,5/15-3	Z7.215.4327.0
	up to 6 pole	VB WKM 2,5/15-6	Z7.215.4627.0
	60 pole	VB WKM 2,5/15 M60	Z7.215.4027.0
Single cover f. cross conn. with marking facility		AD VB 2,5/15 GELB	04.326.3053.8
Partition plate with marking facility		TSM 2,5/15	07.311.2853.8

WKM 4/15

- Feed-through block for mounting on TS 15
- Nominal cross section 4 mm²
- Ex e I/II  II 2GD IM2
Follow the EX installation instructions on page 143
- ²⁾ with/without jumper









Description	Type	Part No.	Std. Pack
Feed-through block, gray	WKM 4/15	55.504.1053.0	100
Feed-through block, blue	WKM 4/15 BLAU	55.504.1053.6	100
General data			
Width / length / height, incl. TS 7.5	6 mm / 32 mm / 32 mm		
Wire strip length	9 mm		
Approvals	      KEMA 02 ATEX 2114 U		
Technical data			
	IEC	UL	CSA
	EN 60 947-7-1		EN 60 079-0/-7
Cross section fine-stranded	0.5–4 mm ²		
Cross section solid/stranded	0.5–6 mm ²		
Cross section, AWG			
Rated current	28 A	30 A	21/27 A ²⁾
Rated voltage	500 V	600 V	275 V
Rated impulse voltage	6 kV		
Pollution degree	3		
Accessories			
	Type	Part No.	Std. Pack
End plate	gray	APM 2,5 - 4/15	07.311.0853.0
	blue	APM 2,5 - 4/15 BLAU	07.311.0853.6
Partition	gray	TWM 2,5 - 4/15	07.311.1853.0
Cross connector with screws, E-Cu	2 pole	IVB WK 4 E/U-2	Z7.271.2227.0
	3 pole	IVB WK 4 E/U-3	Z7.271.2327.0
	up to 12 pole	IVB WK 4 E/U-12	Z7.271.3227.0
Single cover f. cross conn. with marking facility		AD VB 4/15 GELB	04.326.2953.8
Partition plate with marking facility		TSM 4/15	07.311.2953.8

WKM 4 SL/15

- Ground block for mounting on TS 15
- Nominal cross section 4 mm²
- Ex e I/II  II 2GD IM2
Follow the EX installation instructions on page 143



Description	Type	Part No.	Std. Pack
Ground block, green/yellow	WKM 4 SL/15	55.504.9153.0	100
General data			
Width / length / height, incl. TS 7.5	6 mm / 32 mm / 32 mm		
Wire strip length	9 mm		
Approvals	      KEMA 02 ATEX 2114 U		
Technical data			
	IEC	UL	CSA
	EN 60 947-7-2		EN 60 079-0/-7
Cross section fine-stranded	0.5–4 mm ²		
Cross section solid/stranded	0.5–6 mm ²		
Cross section, AWG			
Rated current		30 A	
Rated voltage	500 V	300 V	
Rated impulse voltage	6 kV		
Pollution degree	3		
Accessories			
	Type	Part No.	Std. Pack
End plate	APM 4 SL/15	07.311.0753.0	10

WKM 2,5 F1/15

- Feed-through block with solder connection for mounting on TS 15
- Nominal cross section 2.5 mm²
- The terminal blocks of series WKM 2,5 F1/15 and WKM 2,5 F2/15 must be mounted alternately in order to maintain the required air and creepage distances for the indicated rated voltage.



Description	Type	Part No.	Std. Pack
Feed-through block, gray	WKM 2,5 F1/15	55.503.1253.0	100
General data			
Width / length / height, incl. TS 7.5	5 mm / 32 mm / 32 mm		
Wire strip length	9 mm		
Approvals	Ⓓ		
Technical data	IEC	UL	CSA
	EN 60 947-7-1		Ⓔ
Cross section fine-stranded	0.5–2.5 mm ²		
Cross section solid/stranded	0.5–4 mm ²		
Cross section, AWG			
Rated current	24 A		
Rated voltage	500 V		
Rated impulse voltage	6 kV		
Pollution degree	3		
Accessories			
End plate	gray	APM 2,5 F./15	07.311.0653.0
Cross connector with screws,	2 pole	VB WKM 2,5/15-2	Z7.215.4227.0
E-Cu	3 pole	VB WKM 2,5/15-3	Z7.215.4327.0
	up to 6 pole	VB WKM 2,5/15-6	Z7.215.4627.0
	60 pole	VB WKM 2,5/15 M60	Z7.215.4027.0
Single cover f. cross conn. with marking facility		AD VB 2,5/15 GELB	04.326.3053.8
Partition plate with marking facility	yellow	TSM 2,5/15	07.311.2853.8

WKM 2,5 F2/15

- Feed-through block solder connection for mounting on TS 15
- Nominal cross section 2.5 mm²
- The terminal blocks of series WKM 2,5 F1/15 and WKM 2,5 F2/15 must be mounted alternately in order to maintain the required air and creepage distances for the indicated rated voltage.



Description	Type	Part No.	Std. Pack
Feed-through block, gray	WKM 2,5 F2/15	55.503.1353.0	100
General data			
Width / length / height, incl. TS 7.5	5 mm / 32 mm / 32 mm		
Wire strip length	9 mm		
Approvals	Ⓓ		
Technical data	IEC	UL	CSA
	EN 60 947-7-1		Ⓔ
Cross section fine-stranded	0.5–2.5 mm ²		
Cross section solid/stranded	0.5–4 mm ²		
Cross section, AWG			
Rated current	24 A		
Rated voltage	500 V		
Rated impulse voltage	6 kV		
Pollution degree	3		
Accessories			
End plate	gray	APM 2,5 F./15	07.311.0653.0
Cross connector with screws,	2 pole	VB WKM 2,5/15-2	Z7.215.4227.0
E-Cu	3 pole	VB WKM 2,5/15-3	Z7.215.4327.0
	up to 6 pole	VB WKM 2,5/15-6	Z7.215.4627.0
	60 pole	VB WKM 2,5/15 M60	Z7.215.4027.0
Single cover f. cross conn. with marking facility		AD VB 2,5/15 GELB	04.326.3053.8
Partition plate with marking facility	yellow	TSM 2,5/15	07.311.2853.8

DIN rail terminal blocks with screw connection, type 9700 A.. S35

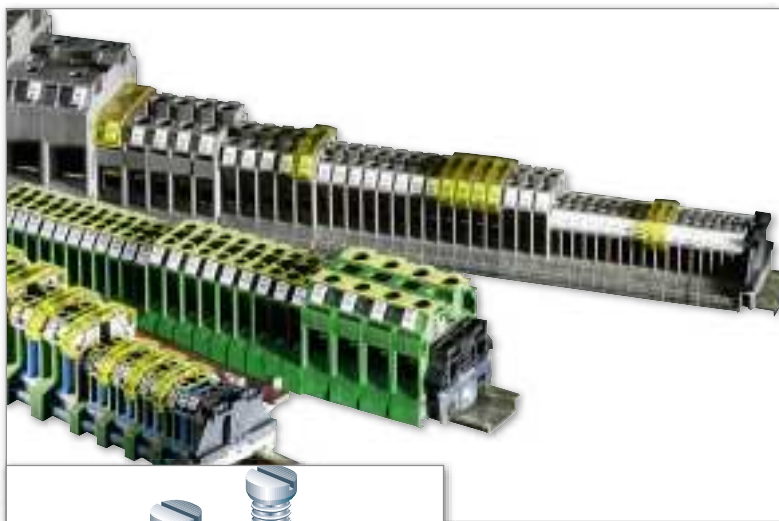

DIN rail terminal blocks with screw connection – **selos** CLASSIC

The **selos** CLASSIC series offers the highest-quality connecting technology. Thanks to its unique clamping body design, aluminum or copper wire connections are long lasting and maintenance-free.

The product line includes feed-through and ground blocks for wires up to 50 mm².

High-quality screw connection technology

- Steel free clamping body
 - Increased corrosion resistance
 - Extruded clamping body, nickel-plated brass
- Low contact resistance
 - Clamping body has similar physical and chemical characteristics as the conductor
 - One piece clamping body/current bar

Connection of aluminum wires possible

The following always applies when connecting aluminium wires in the **selos** CLASSIC LINE:

- After being stripped, the ends of the wires must be cleaned with a brush and then coated with acid-free grease to prevent further oxidation.
- The terminal should be tightened to approx. 20% higher torque than what is stated for the clamping screw.

With this type of terminal, it is not necessary to retighten the clamping screws.

Wide connection range

- Connection range 0.5 – 50 mm²
Solid, fine-stranded and stranded wires can be connected to the terminal blocks of **selos** CLASSIC LINE without ferrules, as all block sizes have wire protection.

Compact design

- **Save space on the rail**
– **selos** CLASSIC LINE offers higher density due to the wire size and terminal block pitch:

Connection range	Pitch
2,5 mm ²	5 mm
4 mm ²	6 mm
10 mm ²	8 mm
16 mm ²	10 mm
25 mm ²	12 mm
35 mm ²	16 mm

Feed-through blocks with screw connection, type 9700 A.. S35

9700 A/5 S35

- Feed-through block for mounting on TS 35
- Nominal cross section 2.5 mm²



Description	Type	Part No.	Std. Pack
Feed-through block, gray	9700 A/5 S35	54.003.7553.0	100
Feed-through block, (Ex)i, blue	9700 A/5 S35 BLAU	54.003.7553.6	100
General data			
Width / length / height, incl. TS 7.5	5 mm / 47 mm / 38 mm		
Wire strip length	9 mm		
Approvals			
Technical data		IEC	UL
Ratings for use of insulating sleeves	EN 60 947-7-1		
Cross section fine-stranded	0.5 – 2.5 mm ²		
Cross section solid/stranded	0.5 – 4 mm ²		
Cross section, AWG		18 – 12	22 – 12
Rated current	24 A	20/30 A	25 A
Rated voltage	800 V	600 V	600 V
Rated impulse voltage	8 kV		
Pollution degree	3		
Accessories		Type	Part No.
End plate, gray		9701/6	07.310.3153.0
Partition, gray		9702/6	07.310.3453.0
Cross connector with screws,	2 pole	9703/5-2	Z7.215.0227.0
E-Cu, uninsulated	3 pole	9703/5-3	Z7.215.0327.0
	4 pole	9703/5-4	Z7.215.0427.0
	5 pole	9703/5-5	Z7.215.0527.0
	6 pole	9703/5-6	Z7.215.0627.0
	Cut-to-order strip 0,6 m long	9703/5-M	Z7.215.0027.0
2-pole switchable jumper			Z7.269.3523.0
Adapter for test plug		9011 D	05.508.8921.0
Cover with warn. symbol for 1 block	yellow		04.325.1656.0

9700 A/6 S35

- Feed-through block for mounting on TS 35
- Nominal cross section 4 mm²



Description	Type	Part No.	Std. Pack
Feed-through block, gray	9700 A/6 S35	54.004.7553.0	100
Feed-through block, (Ex)i, blue	9700 A/6 S35 BLAU	54.004.7553.6	100
General data			
Width / length / height, incl. TS 7.5	6 mm / 47 mm / 38 mm		
Wire strip length	9 mm		
Approvals			
Technical data		IEC	UL
Ratings for use of insulating sleeves	EN 60 947-7-1		
Cross section fine-stranded	0.5 – 4 mm ²		
Cross section solid/stranded	0.5 – 6 mm ²		
Cross section, AWG		18 – 10	22 – 10
Rated current	32 A	30/30 A	35 A
Rated voltage	800 V	600 V	600 V
Rated impulse voltage	8 kV		
Pollution degree	3		
Accessories		Type	Part No.
End plate, gray		9701/6	07.310.3153.0
Partition, gray		9702/6	07.310.3453.0
Cross connector with screws,	2 pole	9703/6-2	Z7.211.0227.0
E-Cu, uninsulated	3 pole	9703/6-3	Z7.211.0327.0
	4 pole	9703/6-4	Z7.211.0427.0
	5 pole	9703/6-5	Z7.211.0527.0
	6 pole	9703/6-6	Z7.211.0627.0
	Cut-to-order strip 0,6 m long	9703/6-M	Z7.211.0027.0
2-pole switchable jumper			Z7.269.2923.0
Adapter for test plug		9011 C	05.508.8821.0
Cover with warn. symbol for 1 block	yellow		04.325.1056.0

Feed-through blocks with screw connection, type 9700 A.. S35

9700 A/8 S35

- Feed-through block for mounting on TS 35
- Nominal cross section 16 mm²



Description	Type	Part No.	Std. Pack
Feed-through block, gray	9700 A/8 S 35	54.010.7553.0	100
Feed-through block, (Ex)i, blue	9700 A/8 S 35 BLAU	54.010.7553.6	100
General data			
Width / length / height, incl. TS 7.5	8 mm / 47 mm / 48 mm		
Wire strip length	12 mm		
Approvals			
Technical data	IEC	UL	CSA
	EN 60 947-7-1		
Cross section fine-stranded	1 – 10 mm ²		
Cross section solid/stranded	1 – 10 mm ²		
Cross section, AWG		18–8	18–8
Rated current	57 A	50/50 A	55 A
Rated voltage	800 V	600 V	600 V
Rated impulse voltage	8 kV		
Pollution degree	3		
Accessories			
End plate	gray 9701/8	07.310.3253.0	10
Partition	gray 9702/8	07.310.3553.0	10
Cross connector with screws, E-Cu, uninsulated	2 pole 9703/8-2	Z7.212.0227.0	50
	3 pole 9703/8-3	Z7.212.0327.0	50
	4 pole 9703/8-4	Z7.212.0427.0	50
	5 pole 9703/8-5	Z7.212.0527.0	50
	6 pole 9703/8-6	Z7.212.0627.0	50
2-pole switchable jumper		Z7.269.3023.0	50
Adapter for test plug	9011 B	05.508.3221.0	10
Cover with warn. symbol for 1 block	yellow	04.325.1156.0	10
Rapid mounting tool		05.593.5953.0	10

9700 A/10 S35

- Feed-through block for mounting on TS 35
- Nominal cross section 16 mm²



Description	Type	Part No.	Std. Pack
Feed-through block, gray	9700 A/10 S 35	54.016.7553.0	100
Feed-through block, (Ex)i, blue	9700 A/10 S 35 BLAU	54.016.7553.6	100
General data			
Width / length / height, incl. TS 7.5	10 mm / 49 mm / 51 mm		
Wire strip length	15 mm		
Approvals			
Technical data	IEC	UL	CSA
	EN 60 947-7-1		
Cross section fine-stranded	1.5 – 16 mm ²		
Cross section solid/stranded	1.5 – 16 mm ²		
Cross section, AWG		18–6	18–6
Rated current	76 A	65/70 A	70 A
Rated voltage	800 V	600 V	600 V
Rated impulse voltage	8 kV		
Pollution degree	3		
Accessories			
End plate	gray 9701/10	07.310.3953.0	10
Partition	gray 9702/10	07.310.4053.0	10
Cross connector with screws, E-Cu, uninsulated	2 pole 9703/10-2	Z7.214.0227.0	50
	3 pole 9703/10-3	Z7.214.0327.0	50
	4 pole 9703/10-4	Z7.214.0427.0	50
	5 pole 9703/10-5	Z7.214.0527.0	50
	6 pole 9703/10-6	Z7.214.0627.0	50
2-pole switchable jumper		Z7.269.3123.0	50
Adapter for test plug	9011 A	05.508.3121.0	10
Cover with warn. symbol for 1 block	yellow	04.325.1256.0	10

9700 A/12 S35

- Feed-through block for mounting on TS 35
- Nominal cross section 25 mm²



Description	Type	Part No.	Std. Pack
Feed-through block, gray	9700 A/12 S 35	54.025.7553.0	50
Feed-through block, (Ex)i, blue	9700 A/12 S 35 BLAU	54.025.7553.6	50
General data			
Width / length / height, incl. TS 7.5	12 mm / 59 mm / 58 mm		
Wire strip length	20 mm		
Approvals			
Technical data	IEC	UL	CSA
	EN 60 947-7-1		
Cross section fine-stranded	2.5 – 25 mm ²		
Cross section solid/stranded	2.5 – 35 mm ²		
Cross section, AWG		14–4	14–4
Rated current	101 A	85/100 A	100 A
Rated voltage	800 V	600 V	600 V
Rated impulse voltage	8 kV		
Pollution degree	3		
Accessories			
End plate	gray 9701/12	07.310.3353.0	10
Partition	gray 9702/12	07.310.3653.0	10
Cross connector with screws, E-Cu, uninsulated	2 pole 9703/12-2	Z7.213.0227.0	50
	3 pole 9703/12-3	Z7.213.0327.0	50
	4 pole 9703/12-4	Z7.213.0427.0	50
	5 pole 9703/12-5	Z7.213.0527.0	50
	6 pole 9703/12-6	Z7.213.0627.0	50
2-pole switchable jumper		Z7.269.3223.0	50
Adapter for test plug		05.508.6521.0	10
Cover with warn. symbol for 1 block	yellow	04.325.1356.0	10

9700 A/16 S35

- Feed-through block for mounting on TS 35
- Nominal cross section 35 mm²



Description	Type	Part No.	Std. Pack
Feed-through block, gray	9700 A/16 S 35	54.035.7553.0	50
Feed-through block, (Ex)i, blue	9700 A/16 S 35 BLAU	54.035.7553.6	50
General data			
Width / length / height, incl. TS 7.5	16 mm / 59 mm / 58 mm		
Wire strip length	20 mm		
Approvals			
Technical data	IEC	UL	CSA
	EN 60 947-7-1		
Cross section fine-stranded	2,5 – 35 mm ²		
Cross section solid/stranded	2,5 – 50 mm ²		
Cross section, AWG		6–2	12–2
Rated current	125 A	115/130 A	125 A
Rated voltage	800 V	600 V	600 V
Rated impulse voltage	8 kV		
Pollution degree	3		
Accessories			
End plate	gray 9701/12	07.310.3353.0	10
Partition	gray 9702/12	07.310.3653.0	10
Cross connector with screws, E-Cu, uninsulated	2 pole 9703/16-2	Z7.216.0227.0	50
	3 pole 9703/16-3	Z7.216.0327.0	50
	4 pole 9703/16-4	Z7.216.0427.0	50
	5 pole 9703/16-5	Z7.216.0527.0	50
	6 pole 9703/16-6	Z7.216.0627.0	50
2-pole switchable jumper		Z7.269.3423.0	50
Adapter for test plug		05.508.6521.0	10
Cover with warn. symbol for 1 block	yellow	04.325.1456.0	10

Ground blocks with screw connection, Typ 9700 A.. S35

9700 A/6 SL2 S35

- Ground block for mounting on TS 35
- Nominal cross section 4 mm²



Description	Type	Part No.	Std. Pack
Ground block, green-yellow	9700 A/6 SL 2 S 35	56.004.9053.0	100
General data			
Width / length / height, incl. TS 7.5	6 mm / 48 mm / 38 mm		
Wire strip length	9 mm		
Approvals			
Technical data	IEC	UL	CSA
	EN 60 947-7-2		
Cross section fine-stranded	0.5 – 4 mm ²		
Cross section solid/stranded	0.5 – 6 mm ²		
Cross section, AWG		18–10	22–10
Rated current			
Rated voltage	800 V	600 V	600 V
Rated impulse voltage	8 kV		
Pollution degree	3		
Accessories			
End plate, green	Type 9701/6 SL	Part No. 07.312.0053.0	Std. Pack 10

9700 A/8 SL2 S35

- Ground block for mounting on TS 35
- Nominal cross section 10 mm²



Description	Type	Part No.	Std. Pack
Ground block, green-yellow	9700 A/8 SL 2 S 35	56.010.9053.0	100
General data			
Width / length / height, incl. TS 7.5	8 mm / 53 mm / 48 mm		
Wire strip length	11 mm		
Approvals			
Technical data	IEC	UL	CSA
	EN 60 947-7-2		
Cross section fine-stranded	0.5 – 10 mm ²		
Cross section solid/stranded	0.5 – 10 mm ²		
Cross section, AWG		18–8	18–8
Rated current			
Rated voltage	800 V	600 V	600 V
Rated impulse voltage	8 kV		
Pollution degree	3		
Accessories			
End plate, green	Type 9701/8 SL	Part No. 07.312.0153.0	Std. Pack 10

9700 A/10 SL2 S35

- Ground block for mounting on TS 35
- Nominal cross section 16 mm²



Description	Type	Part No.	Std. Pack
Ground block, green-yellow	9700 A/10 SL 2 S 35	56.016.9053.0	50
General data			
Width / length / height, incl. TS 7.5	10 mm / 53 mm / 51 mm		
Wire strip length	16 mm		
Approvals			
Technical data	IEC	UL	CSA
	EN 60 947-7-2		
Cross section fine-stranded	1.5 – 16 mm ²		
Cross section solid/stranded	1.5 – 16 mm ²		
Cross section, AWG		18–6	16–6
Rated current			
Rated voltage	800 V	600 V	600 V
Rated impulse voltage	8 kV		
Pollution degree	3		
Accessories			
End plate, green	Type 9701/10 SL	Part No. 07.312.0253.0	Std. Pack 10

9700 A/16 SL2 S35

- Ground block for mounting on TS 35
- Nominal cross section 35 mm²



Description	Type	Part No.	Std. Pack
Ground block, green-yellow	9700 A/16 SL 2 S 35	56.035.9053.0	50
General data			
Width / length / height, incl. TS 7.5	16 mm / 53 mm / 58 mm		
Wire strip length	18 mm		
Approvals			
Technical data	IEC	UL	CSA
	EN 60 947-7-2		
Cross section fine-stranded	2.5 – 35 mm ²		
Cross section solid/stranded	2.5 – 50 mm ²		
Cross section, AWG		12–2	12–2
Rated current			
Rated voltage	800 V	600 V	600 V
Rated impulse voltage	8 kV		
Pollution degree	3		
Accessories			
	Type	Part No.	Std. Pack
End plate, green	9701/16 SL	07.312.0353.0	10



fasis WKFN – DIN Rail Terminal Blocks with **Tension Spring Connection**

The DIN rail terminal block with tension spring technology: **fasis** WKFN is easy to operate, saves time and costs during wiring and reduces inventory costs, and guarantees vibration-proof and maintenance-free connections with high contact forces.

The product line includes feed-through and ground blocks with 2, 3 or 4 termination point as well as multi-tier blocks in two- and three-tier designs, knife-edge disconnect blocks in one- and two-tier designs and fuse blocks. In addition, specialty function blocks are available with application-specific diode circuits.

fasis WKFN has been designed for use in machinery and plant construction as well as hazardous locations subject to explosion.

Connection cross-sections up to 35 mm²

Rated current of up to 125 A

Rated voltage of up to 1000 V



DIN rail terminal blocks with tension spring connection

The terminals

- Secure and maintenance-free tension spring connection
- High quality, dynamic contact technology with steel spring and copper current carrying bar
- Easy to wire front connection
- Connection of fine-stranded wires with and without wire ferrules
- Simple operation with a standard screwdriver
- Screwdriver is held securely in the terminal for optimal handling while connecting wires



The system

- Compact design for wiring in confined spaces (to 35 mm²)
- Plug-in system provides a Plug & Play solution in the control cabinet – **fasis** CON
- Plug-in jumper bars
- Screwless, snap-on ground terminal
- Function check via modular test adapter through test point in the jumpering channel
- Integrated test jacks in all blocks
- Many labeling options

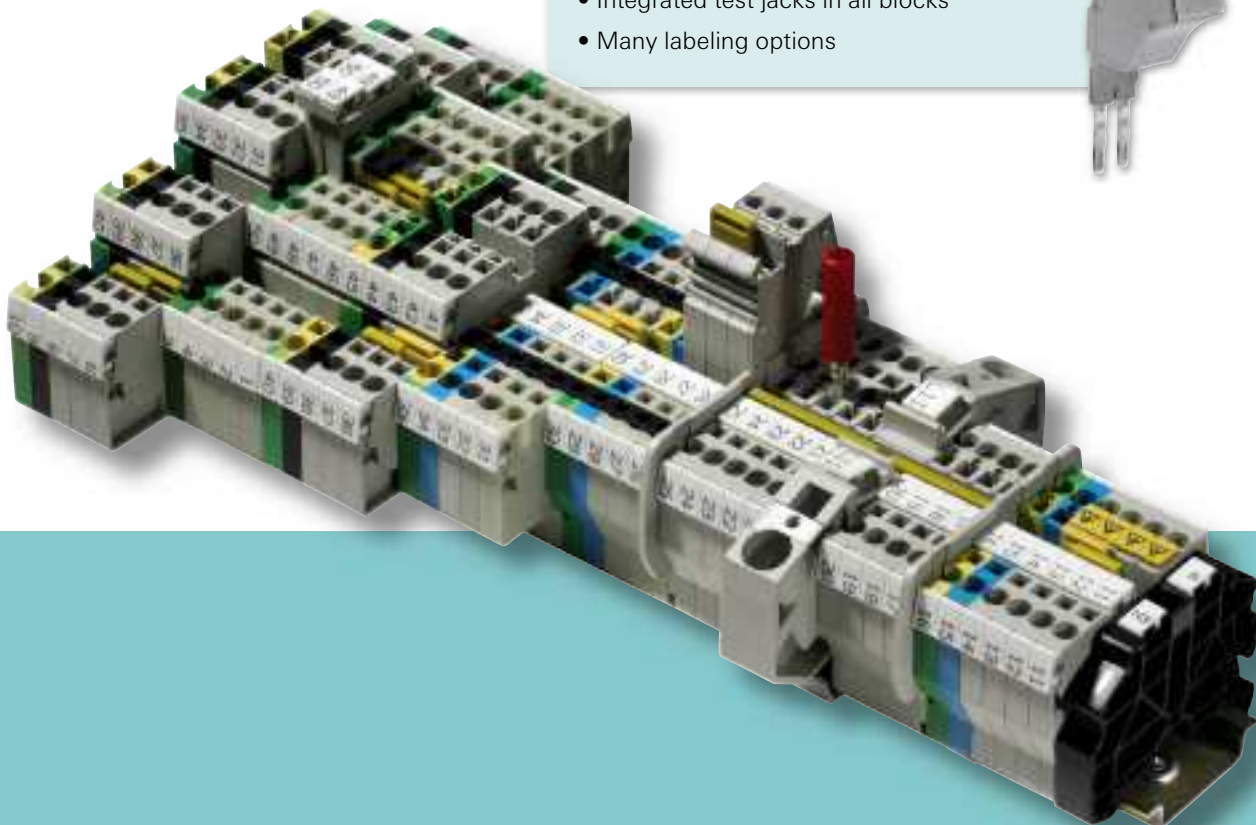

Wieland jumpering system – Perfect technology

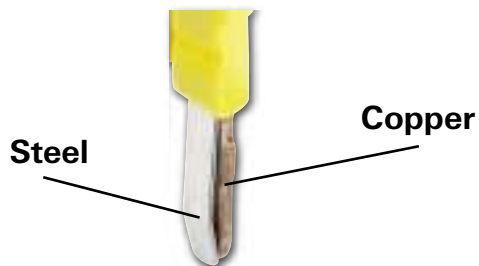
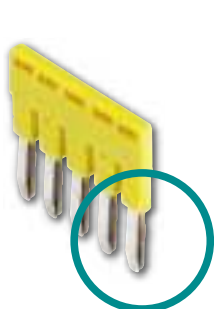

Perfect technology

- Copper current bar guarantees low contact resistance
- Steel spring guarantees strength, durability, and long-term stability

Extremely rugged!

- Indestructible steel spring
- Vibration-proof connection



Simple customization

- Individual poles easy to remove
- Circuits easy to identify

Wieland marking system – Reliable identification

Marking strips – Dependable

- Maximum hold to the terminal
- Solidify integrity of the assembly



Marking tags – Individual

- Individual labeling with minimum effort
- Ideal for service and maintenance





The accessories







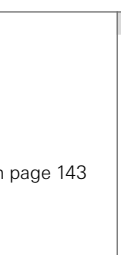

- Wire entry guide strips for secure connection of wires smaller than 1 mm²
- Snap-on covers with warning symbols
- Wieland screwdriver for optimal operation of spring tension terminals

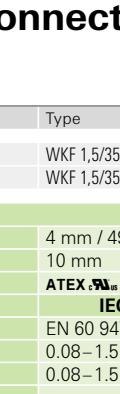

Feed-through blocks with tension spring connection

WKF 1,5/35	Description				
	Type	Part No.	Std. Pack		
<ul style="list-style-type: none"> • Feed-through block with tension spring connection for mounting on TS 35 • Nominal cross section 1.5 mm² • Ex e II  II 2GD <p>Follow the EX installation instructions on page 143</p> 	Feed-through block, gray	WKF 1,5/35	56.702.0053.0	50	
	Feed-through block, blue	WKF 1,5/35 BLAU	56.702.0053.6	50	
	General data				
	Width / length / height, incl. TS 7.5	4 mm / 49 mm / 37 mm			
	Wire strip length	10 mm			
	Approvals	ATEX  KEMA 03 ATEX 2056 U			
	Technical data	IEC	UL	CSA	
		EN 60 947-7-1			EN 60 079-0/-7
	Cross section fine-stranded	0.08–1.5 mm ²			0.14–1.5 mm ²
	Cross section solid/stranded	0.08–1.5 mm ²			0.14–1.5 mm ²
	Cross section, AWG		26–14	26–14	
	Rated current	17.5 A	15 A	15 A	17.5/16.5 A ³⁾
	Rated voltage	500 V	300 V	300 V	440 V ^{*)}
	Rated impulse voltage	6 kV			
	Pollution degree	3			
Accessories					
	Type	Part No.	Std. Pack		
End plate, gray	APF 1,5	07.312.8153.0	10		
Partition, gray	TWF 1,5	07.312.8253.0	10		

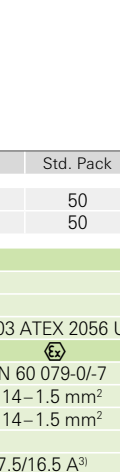
WKF 1,5 D1/2/35	Description				
	Type	Part No.	Std. Pack		
<ul style="list-style-type: none"> • Duo feed-through block with tension spring connection for mounting on TS 35 • Nominal cross section 1.5 mm² • Ex e II  II 2GD <p>Follow the EX installation instructions on page 143</p> 	Feed-through block, gray	WKF 1,5 D1/2/35	56.702.5053.0	50	
	Feed-through block, blue	WKF 1,5 D1/2/35 BLAU	56.702.5053.6	50	
	General data				
	Width / length / height, incl. TS 7.5	4 mm / 60 mm / 37 mm			
	Wire strip length	10 mm			
	Approvals	ATEX  KEMA 03 ATEX 2056 U			
	Technical data	IEC	UL	CSA	
		EN 60 947-7-1			EN 60 079-0/-7
	Cross section fine-stranded	0.08–1.5 mm ²			0.14–1.5 mm ²
	Cross section solid/stranded	0.08–1.5 mm ²			0.14–1.5 mm ²
	Cross section, AWG		26–14	26–14	
	Rated current	17.5 A	15 A	15 A	17.5/16.5 A ³⁾
	Rated voltage	500 V	300 V	300 V	440 V ^{*)}
	Rated impulse voltage	6 kV			
	Pollution degree	3			
Accessories					
	Type	Part No.	Std. Pack		
End plate, gray	APF 1,5 D1/2	07.312.8353.0	10		
Segment end plate, gray	SAPF 1,5	07.312.8953.0	10		
Partition, gray	TWF 1,5 D1/2	07.312.8453.0	10		







WKF 1,5 D2/2/35	Description				
	Type	Part No.	Std. Pack		
<ul style="list-style-type: none"> • Duo feed-through block with tension spring connection for mounting on TS 35 • Nominal cross section 1.5 mm² • Ex e II  II 2GD <p>Follow the EX installation instructions on page 143</p> 	Feed-through block, gray	WKF 1,5 D2/2/35	56.702.5153.0	50	
	Feed-through block, blue	WKF 1,5 D2/2/35 BLAU	56.702.5153.6	50	
	General data				
	Width / length / height, incl. TS 7.5	4 mm / 72 mm / 37 mm			
	Wire strip length	10 mm			
	Approvals	ATEX  KEMA 03 ATEX 2056 U			
	Technical data	IEC	UL	CSA	
		EN 60 947-7-1			EN 60 079-0/-7
	Cross section fine-stranded	0.08–1.5 mm ²			0.14–1.5 mm ²
	Cross section solid/stranded	0.08–1.5 mm ²			0.14–1.5 mm ²
	Cross section, AWG		26–14	26–14	
	Rated current	17.5 A	15 A	15 A	17.5/16.5 A ³⁾
	Rated voltage	500 V	300 V	300 V	440 V ^{*)}
	Rated impulse voltage	6 kV			
	Pollution degree	3			
Accessories					
	Type	Part No.	Std. Pack		
End plate, gray	APF 1,5 D2/2	07.312.8553.0	10		
Segment end plate, gray	SAPF 1,5	07.312.8953.0	10		
Partition, gray	TWF 1,5 D2/2	07.312.8653.0	10		

Accessories for *fasis* WKF 1,5...

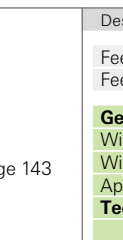
Accessories		Type	Part No.	Std. Pack
	Cross connector, insulated	2 pole IVB WKF 1,5-2	Z7.268.0227.0	10
		3 pole IVB WKF 1,5-3	Z7.268.0327.0	10
		4 pole IVB WKF 1,5-4	Z7.268.0427.0	10
		5 pole IVB WKF 1,5-5	Z7.268.0527.0	10
		10 pole IVB WKF 1,5-10	Z7.268.1027.0	10
		20 pole IVB WKF 1,5-20	Z7.268.2027.0	10
	Wire entry guide	0.13-0.2 mm ² LEL 1,5/1 WEISS	05.564.4253.0	10
	0.25-0.5 mm ² LEL 1,5/2 GRAU	05.564.4353.0	10	
Cover with warning symbol over 5 blocks	ADF 1,5/5 GELB	04.343.6953.8	10	
Screwdriver, uninsulated	DIN 5264 B 0,4x2,5	06.502.4300.0	5	

*¹ For maintaining the proper isolation distances, the open side of a feed-through terminal block as well as both sides of a jumper are to be covered by partitions.
² Rated current when using cross connectors

Feed-through blocks with tension spring connection

<p>WKFN 2,5/35</p> <ul style="list-style-type: none"> • Feed-through block with tension spring connection for mounting on TS 35 • Nominal cross section 2.5 mm² • Ex e I/II  II 2GD IM2 Follow the EX installation instructions on page 143 	<table border="1"> <thead> <tr> <th>Description</th> <th>Type</th> <th>Part No.</th> <th>Std. Pack</th> </tr> </thead> <tbody> <tr> <td>Feed-through block, gray</td> <td>WKFN 2,5/35</td> <td>56.703.0055.0</td> <td>100</td> </tr> <tr> <td>Feed-through block, blue</td> <td>WKFN 2,5/35 BLAU</td> <td>56.703.0055.6</td> <td>100</td> </tr> </tbody> </table>	Description	Type	Part No.	Std. Pack	Feed-through block, gray	WKFN 2,5/35	56.703.0055.0	100	Feed-through block, blue	WKFN 2,5/35 BLAU	56.703.0055.6	100
	Description	Type	Part No.	Std. Pack									
	Feed-through block, gray	WKFN 2,5/35	56.703.0055.0	100									
	Feed-through block, blue	WKFN 2,5/35 BLAU	56.703.0055.6	100									
	<p>General data</p>												
	Width / length / height, incl. TS 7.5	5 mm / 47 mm / 38 mm											
	Wire strip length	11 mm											
	Approvals	PTB      PTB 04 ATEX 1051 U											
	Technical data	IEC	UL	CSA 									
		EN 60 947-1-1		EN 60 079-0/-7									
Cross section fine-stranded	0.13–2.5 mm ²		0.2–2.5 mm ²										
Cross section solid/stranded	0.13–4 mm ²		0.13–4 mm ²										
Cross section, AWG	22–12	24–12											
Rated current	24 A	20 A	24 A										
Rated voltage	800 V	600 V	600 V										
Rated impulse voltage	8 kV		550 V										
Pollution degree	3												
Note	¹⁾ for 40 K and 45 K												
<p>Accessories</p>													
End plate, gray	APFN 2,5	07.312.6755.0	10										
End plate, blue	APFN 2,5 BLAU	07.312.6755.6	10										
Partition, gray	TWFN 2,5	07.312.6855.0	10										

WKFN 2,5 D1/2/35 - Duo feed-through block with tension spring connection for mounting on TS 35 - Nominal cross section 2.5 mm² - Ex e I/II II 2GD IM2 Follow the EX installation instructions on page 143		Description	Type	Part No.	Std. Pack		--------------------------	-----------------------	---------------	-----------		Feed-through block, gray	WKFN 2,5 D1/2/35	56.703.5055.0	100		Feed-through block, blue	WKFN 2,5 D1/2/35 BLAU	56.703.5055.6	100	
General data																					
Width / length / height, incl. TS 7.5	5 mm / 60 mm / 38 mm																				
Wire strip length	11 mm																				
Approvals	PTB PTB 04 ATEX 1051 U																				
Technical data	**IEC**	**UL**	**CSA**																		
	EN 60 947-1-1		EN 60 079-0/-7																		
Cross section fine-stranded	0.13–2.5 mm²		0.2–2.5 mm²																		
Cross section solid/stranded	0.13–4 mm²		0.13–4 mm²																		
Cross section, AWG	22–12	24–12																			
Rated current	24 A	20 A	24 A																		
Rated voltage	800 V	600 V	600 V																		
Rated impulse voltage	8 kV		550 V																		
Pollution degree	3																				
Note	¹⁾ for 40 K and 45 K																				
Accessories																					
End plate, gray	APFN 2,5 D1/2	07.312.6955.0	10																		
End plate, blue	APFN 2,5 D1/2 BLAU	07.312.6955.6	10																		
Partition, gray	TWFN 2,5 D1/2	07.312.7055.0	10																		
WKFN 2,5 D2/2/35 - Duo feed-through block with tension spring connection for mounting on TS 35 - Nominal cross section 2.5 mm² - Ex e I/II II 2GD IM2 Follow the EX installation instructions on page 143		Description	Type	Part No.	Std. Pack		--------------------------	-----------------------	---------------	-----------		Feed-through block, gray	WKFN 2,5 D2/2/35	56.703.5155.0	100		Feed-through block, blue	WKFN 2,5 D2/2/35 BLAU	56.703.5155.6	100	
General data																					
Width / length / height, incl. TS 7.5	5 mm / 72 mm / 38 mm																				
Wire strip length	11 mm																				
Approvals	PTB PTB 04 ATEX 1051 U																				
Technical data	**IEC**	**UL**	**CSA**																		
	EN 60 947-1-1		EN 60 079-0/-7																		
Cross section fine-stranded	0.13–2.5 mm²		0.2–2.5 mm²																		
Cross section solid/stranded	0.13–4 mm²		0.13–4 mm²																		
Cross section, AWG	22–12	24–12																			
Rated current	24 A	20 A	24 A																		
Rated voltage	800 V	600 V	600 V																		
Rated impulse voltage	8 kV		550 V																		
Pollution degree	3																				
Note	¹⁾ for 40 K and 45 K																				
Accessories																					
End plate, gray	APFN 2,5 D2/2	07.312.7155.0	10																		
End plate, blue	APFN 2,5 D2/2 BLAU	07.312.7155.6	10																		
Partition, gray	TWFN 2,5 D2/2	07.312.7255.0	10																		

Supply block

WKF 16/35 PV/WKFN

- Supply block for mounting on TS 35
- Nominal cross section 2.5 mm²
- Ex e I/II $\text{\textcircled{E}}$ II 2GD IM2
Follow the EX installation instructions on page 143

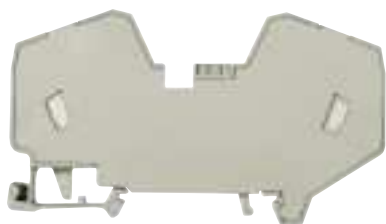

Description	Type	Part No.	Std. Pack
Power feed-in block, gray	WKF 16/35 PV/WKFN	56.716.0353.0	20
General data			
Width / length / height, incl. TS 7.5	12 mm / 82 mm / 48 mm		
Wire strip length	15 mm		
Approvals	KEMA 01 ATEX 2087 U		
Technical data	IEC	UL	CSA
	EN 60 947-7-1		EN 60 079-0/-7
Cross section fine-stranded	4–16 mm ²		4–16 mm ²
Cross section solid/stranded	4–16 mm ²		4–16 mm ²
Cross section, AWG		24–4	12–4
Rated current	76 A	75 A	64 A*)
Rated voltage	800 V	600 V	600 V
Rated impulse voltage	8 kV		690 V
Pollution degree	3		
Note	* Type-specific output currents upon request		

Accessories	Type	Part No.	Std. Pack
Cover with warning symbol over 4 blocks	ADF 16/4 GELB	04.343.6653.8	10
Screwdriver, uninsulated	DIN 5264 B 1,0x5,5	06.502.4200.0	5

- Potential distribution with standard cross connector IVB WKF 2.5...
- Parallel connection of two cross connectors → double jumpering
- Potential distributions are possible on one or both sides

Potential-distribution	one side		both sides	
	single	double	single	double
I_{max}	48	68	72	76



$$I_{max} = \sum I_n \leq \sum I_{Nblock}$$



Accessories for fasis WKFN 2,5...



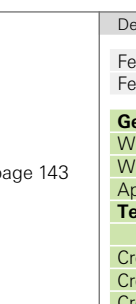

Accessories	Type	Part No.	Std. Pack
Cross connector, insulated	2 pole	IVB WKF 2,5–2	Z7.280.6227.0
	3 pole	IVB WKF 2,5–3	Z7.280.6327.0
	4 pole	IVB WKF 2,5–4	Z7.280.6427.0
	5 pole	IVB WKF 2,5–5	Z7.280.6527.0
	6 pole	IVB WKF 2,5–6	Z7.280.6627.0
	7 pole	IVB WKF 2,5–7	Z7.280.6727.0
	8 pole	IVB WKF 2,5–8	Z7.280.6827.0
	9 pole	IVB WKF 2,5–9	Z7.280.6927.0
	10 pole	IVB WKF 2,5–10	Z7.280.7027.0
	20 pole	IVB WKF 2,5–20	Z7.280.8027.0
Wire entry guide	0.13–0.2 mm ²	LELN 2,5/1 WEISS	05.564.3755.0
	0.25–0.5 mm ²	LELN 2,5/2 GRAU	05.564.3855.0
	0.75–1.0 mm ²	LELN 2,5/3 SCHWARZ	05.564.3955.0
Cover with warning symbol over 4 blocks	yellow	ADFN 2,5/4 GELB	04.343.8353.8
Test adapter, modular		PS WKC/F	Z1.299.9753.0
Test plug		ST 2/2,3	Z5.553.2921.0
Screwdriver, uninsulated		DIN 5264 B 0,6x3,5	06.502.4000.0
Screwdriver, uninsulated, MINI		DIN 5264 B 0,6x3,5 M	06.502.5000.0

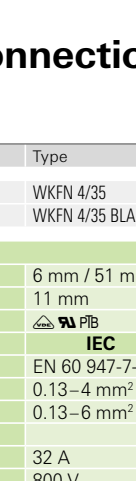
Feed-through blocks with tension spring connection

WKFN 4/35	Description	Type	Part No.	Std. Pack
	<ul style="list-style-type: none"> Feed-through block with tension spring connection for mounting on TS 35 Nominal cross section 4 mm² Ex e I/II  II 2GD IM2 <p>Follow the EX installation instructions on page 143</p> 	Feed-through block, gray	WKFN 4/35	56.704.0055.0
	Feed-through block, blue	WKFN 4/35 BLAU	56.704.0055.6	100
General data				
	Width / length / height, incl. TS 7.5	6 mm / 51 mm / 38 mm		
	Wire strip length	11 mm		
	Approvals	 PTB 05 ATEX 1104 U		
	Technical data	IEC	UL	CSA 
		EN 60 947-7-1		EN 60 079-0/-7
	Cross section fine-stranded	0.13–4 mm ²		
	Cross section solid/stranded	0.13–6 mm ²		
	Cross section, AWG	24–10	24–10	
	Rated current	32 A	30 A	28/30 A ¹⁾
	Rated voltage	800 V	600 V	690 V
	Rated impulse voltage	8 kV		
	Pollution degree	3		
	Note	¹⁾ 1. value at 40 K/ 2. value at 45 K		
Accessories				
	End plate, gray	APFN 4	07.312.9255.0	10
	End plate, blue	APFN 4 BLAU	07.312.9255.6	10
	Partition, gray	TWFN 4	07.312.9355.0	10

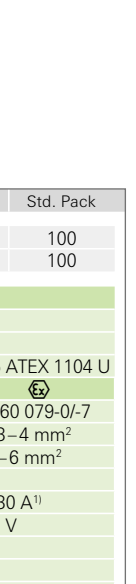
WKFN 4 D1/2/35	Description	Type	Part No.	Std. Pack
	<ul style="list-style-type: none"> Duo feed-through block with tension spring connection for mounting on TS 35 Nominal cross section 4 mm² Ex e I/II  II 2GD IM2 <p>Follow the EX installation instructions on page 143</p> 	Feed-through block, gray	WKFN 4 D1/2/35	56.704.5055.0
	Feed-through block, blue	WKFN 4 D1/2/35 BLAU	56.704.5055.6	100
General data				
	Width / length / height, incl. TS 7.5	6 mm / 67 mm / 38 mm		
	Wire strip length	11 mm		
	Approvals	 PTB 05 ATEX 1104 U		
	Technical data	IEC	UL	CSA 
		EN 60 947-7-1		EN 60 079-0/-7
	Cross section fine-stranded	0.13–4 mm ²		
	Cross section solid/stranded	0.13–6 mm ²		
	Cross section, AWG	24–10	24–10	
	Rated current	32 A	30 A	28/30 A ¹⁾
	Rated voltage	800 V	600 V	550 V
	Rated impulse voltage	8 kV		
	Pollution degree	3		
	Note	¹⁾ 1. value at 40 K/ 2. value at 45 K		
Accessories				
	End plate, gray	APFN 4 D1/2	07.312.9455.0	10
	End plate, blue	APFN 4 D1/2 BLAU	07.312.9455.6	10
	Partition, gray	TWFN 4 D1/2	07.312.9555.0	10

WKFN 4 D2/2/35	Description	Type	Part No.	Std. Pack
	<ul style="list-style-type: none"> Duo feed-through block with tension spring connection for mounting on TS 35 Nominal cross section 4 mm² Ex e I/II  II 2GD IM2 <p>Follow the EX installation instructions on page 143</p> 	Feed-through block, gray	WKFN 4 D2/2/35	56.704.5155.0
	Feed-through block, blue	WKFN 4 D2/2/35 BLAU	56.704.5155.6	100
General data				
	Width / length / height, incl. TS 7.5	6 mm / 82 mm / 38 mm		
	Wire strip length	11 mm		
	Approvals	 PTB 05 ATEX 1104 U		
	Technical data	IEC	UL	CSA 
		EN 60 947-7-1		EN 60 079-0/-7
	Cross section fine-stranded	0.13–4 mm ²		
	Cross section solid/stranded	0.13–6 mm ²		
	Cross section, AWG	24–10	24–10	
	Rated current	32 A	30 A	28/30 A ¹⁾
	Rated voltage	800 V	600 V	550 V
	Rated impulse voltage	8 kV		
	Pollution degree	3		
	Note	¹⁾ 1. value at 40 K/ 2. value at 45 K		
Accessories				
	End plate, gray	APFN 4 D2/2	07.312.9055.0	10
	End plate, blue	APFN 4 D2/2 BLAU	07.312.9055.6	10
	Partition, gray	TWFN 4 D2/2	07.312.9155.0	10

WKF 16/35 PV/WKFN

- Supply block for mounting on TS 35
- Nominal cross section 2.5 mm²
- Ex e I/II Ⓜ II 2GD IM2
Follow the EX installation instructions on page 143



Description	Type	Part No.	Std. Pack			
Power feed-in block, gray	WKF 16/35 PV/WKFN	56.716.0353.0	20			
General data						
Width / length / height, incl. TS 7.5	12 mm / 82 mm / 48 mm					
Wire strip length	15 mm					
Approvals	KEMA 01 ATEX 2087 U					
Technical data		IEC	UL	CSA	Ⓜ	
	EN 60 947-7-1				EN 60 079-0/-7	
Cross section fine-stranded	4–16 mm ²				4–16 mm ²	
Cross section solid/stranded	4–16 mm ²				4–16 mm ²	
Cross section, AWG		24–4	12–4			
Rated current	76 A	75 A	78 A		64 A*	
Rated voltage	800 V	600 V	600 V		690 V	
Rated impulse voltage	8 kV					
Pollution degree	3					
Note	* Type-specific output currents upon request					
Accessories				Type	Part No.	Std. Pack
Cover with warning symbol over 4 blocks	ADF 16/4 GELB	04.343.6653.8	10			
Screwdriver, uninsulated	DIN 5264 B 1,0x5,5	06.502.4200.0	5			

- Potential distribution with standard cross connector IVB WKF 4...
- Parallel connection of two cross connectors → double jumpering
- Potential distributions are possible on one or both sides

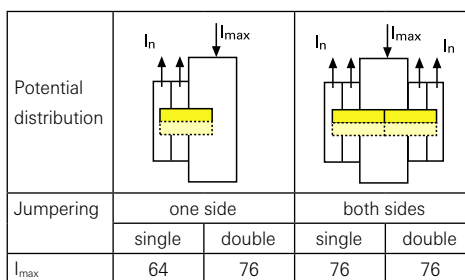

$$I_{max} = \sum I_n \leq \sum I_{Nblock}$$

Accessories for fasis WKFN 4...



Accessories	Type	Part No.	Std. Pack	
Cross connector, insulated	2 pole	VB WKF 4–2	Z7.261.1227.0	10
	3 pole	IVB WKF 4–3	Z7.261.1327.0	10
	4 pole	IVB WKF 4–4	Z7.261.1427.0	10
	5 pole	IVB WKF 4–5	Z7.261.1527.0	10
	6 pole	IVB WKF 4–6	Z7.261.1627.0	10
	7 pole	IVB WKF 4–7	Z7.261.1727.0	20
	8 pole	IVB WKF 4–8	Z7.261.1827.0	20
	9 pole	IVB WKF 4–9	Z7.261.1927.0	20
	10 pole	IVB WKF 4–10	Z7.261.2027.0	20
	Wire entry guide	0.13–0.2 mm ²	LEL 4/1 WEISS	05.561.8553.0
0.25–0.5 mm ²		LEL 4/2 GRAU	05.561.8653.0	100
0.75–1.0 mm ²		LEL 4/3 SCHWARZ	05.561.8753.0	100
Cover with warning symbol over 4 blocks	yellow	ADF 4/4 GELB	04.343.6153.8	10
Test adapter, modular		PS WKC/F	Z1.299.9753.0	10
Test plug		ST 2/2,3	Z5.553.2921.0	10
Screwdriver, uninsulated		DIN 5264 B 0,6x3,5	06.502.4000.0	5
Screwdriver, uninsulated, MINI		DIN 5264 B 0,6x3,5 M	06.502.5000.0	10

Feed-through blocks with tension spring connection

Description	Type	Part No.	Std. Pack
Feed-through block, blue	WKFN 6/35 BLAU	56.706.0055.6	100
General data			
Width / length / height, incl. TS 7.5	8 mm / 66 mm / 45 mm		
Wire strip length	12 mm		
Approvals	 PTB 06 ATEX 1075 U		
Technical data	IEC	UL	CSA
	EN 60 947-7-1		EN 60 079-0/-7
Cross section fine-stranded	0.2–6 mm ²		0.2–6 mm ²
Cross section solid/stranded	1.5–10 mm ²		1.5–10 mm ²
Cross section, AWG	24–8		24–8
Rated current	41 A	50 A	39/41 A*
Rated voltage	800 V	600 V	550 V
Rated impulse voltage	8 kV		
Pollution degree	3		
Note	* 1. value at 40K/ 2. value at 45K		
Accessories			
End plate, gray	APFN 6	07.313.0455.0	10
End plate, blue	APFN 6 BLAU	07.313.0455.6	10
Partition, gray	TWFN 6	07.313.0555.0	10

WKFN 6/35

- Feed-through block with tension spring connection for mounting on TS 35
- Nominal cross section 6 mm²
- Ex e I/II  II 2GD IM2
Follow the EX installation instructions on page 143



Description	Type	Part No.	Std. Pack
Feed-through block, blue	WKFN 6 D1/2/35 BLAU	56.706.5055.6	100
General data			
Width / length / height, incl. TS 7.5	8 mm / 90 mm / 45 mm		
Wire strip length	12 mm		
Approvals	 PTB 06 ATEX 1075 U		
Technical data	IEC	UL	CSA
	EN 60 947-7-1		EN 60 079-0/-7
Cross section fine-stranded	0.2–6 mm ²		0.2–6 mm ²
Cross section solid/stranded	1.5–10 mm ²		1.5–10 mm ²
Cross section, AWG	24–8		24–8
Rated current	41 A	50 A	39/41 A*
Rated voltage	800 V	600 V	550 V
Rated impulse voltage	8 kV		
Pollution degree	3		
Note	* 1. value at 40K/ 2. value at 45K		
Accessories			
End plate, gray	APFN 6 D1/2	07.313.0655.0	10
End plate, blue	APFN 6 D1/2 BLAU	07.313.0655.6	10
Partition, gray	TWFN 6 D1/2	07.313.0755.0	10

WKFN 6 D1/2/35

- Duo-feed-through block with tension spring connection for mounting on TS 35
- Nominal cross section 6 mm²
- Ex e I/II  II 2GD IM2
Follow the EX installation instructions on page 143



Accessories for fasis WKFN 6...

Accessories	Type	Part No.	Std. Pack
Cross connector, insulated**	2 pole	IVB WKFN 6–2	Z7.282.5227.0
	3 pole	IVB WKFN 6–3	Z7.282.5327.0
	4 pole	IVB WKFN 6–4	Z7.282.5427.0
	5 pole	IVB WKFN 6–5	Z7.282.5527.0
	yellow	ADF 6/4 GELB	04.343.6253.8
Cover with warning symbol over 4 blocks			10
Test plug	ST 2/2,3	Z5.553.2921.0	10
Screwdriver, uninsulated	DIN 5264 B 0,8x4	06.502.4100.0	5

** When cross connectors are used according to EN 60079-0 and EN 60079-7, the current must be reduced to max. 3.5 A.



Description		Type	Part No.	Std. Pack
Feed-through block, gray		WKFN 10/35	56.710.0055.0	50
Feed-through block, blue		WKFN 10/35 BLAU	56.710.0055.6	50
General data				
Width / length / height, incl. TS 7.5		10 mm / 72 mm / 50 mm		
Wire strip length		15 mm		
Approvals		IEC UL CSA PTB 06 ATEX 1075 U		
Technical data				
		IEC	UL	CSA
		EN 60 947-7-1		
Cross section fine-stranded		0.2–10 mm ²		
Cross section solid/stranded		1.5–16 mm ²		
Cross section, AWG		16–6	16–6	
Rated current		57 A	60 A	52/57 A*
Rated voltage		800 V	600 V	600 V
Rated impulse voltage		8 kV		550 V
Pollution degree		3		
Note		* 1. value at 40 K / 2. value at 45 K		
Accessories				
		Type	Part No.	Std. Pack
End plate, gray		APFN 10	07.313.0855.0	10
End plate, blue		APFN 10 BLAU	07.313.0855.6	10
Partition, gray		TWFN 10	07.313.0955.0	10

WKFN 10/35

- Feed-through block with tension spring connection for mounting on TS 35
- Nominal cross section 10 mm²
- Ex e I/II II 2GD IM2
Follow the EX installation instructions on page 143

³⁾ Pls. note that the current must be reduced for EX applications.

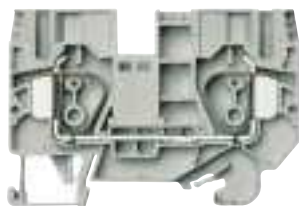

Description		Type	Part No.	Std. Pack
Feed-through block, gray		WKFN 10 D1/2/35	56.710.5055.0	50
Feed-through block, blue		WKFN 10 D1/2/35 BLAU	56.710.5055.6	50
General data				
Width / length / height, incl. TS 7.5		10 mm / 98 mm / 50 mm		
Wire strip length		15 mm		
Approvals		IEC UL CSA PTB 06 ATEX 1075 U		
Technical data				
		IEC	UL	CSA
		EN 60 947-7-1		
Cross section fine-stranded		0.2–10 mm ²		
Cross section solid/stranded		1.5–16 mm ²		
Cross section, AWG		16–6	16–6	
Rated current		57 A	60 A	52/57 A*
Rated voltage		1000 V	600 V	600 V
Rated impulse voltage		8 kV		550 V
Pollution degree		3		
Note		* 1. value at 40 K / 2. value at 45 K		
Accessories				
		Type	Part No.	Std. Pack
End plate, gray		APFN 10 D1/2	07.313.1055.0	10
End plate, blue		APFN 10 D1/2 BLAU	07.313.1055.6	10
Partition, gray		TWFN 10 D1/2	07.313.1155.0	10

WKFN 10 D1/2/35

- Duo-feed-through block with tension spring connection for mounting on TS 35
- Nominal cross section 10 mm²
- Ex e I/II II 2GD IM2
Follow the EX installation instructions on page 143

³⁾ Pls. note that the current must be reduced for EX applications.

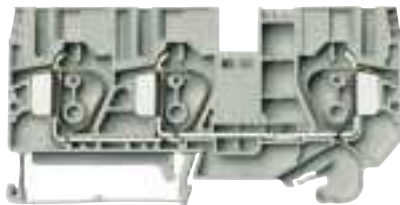

Accessories for fasis WKFN 10...

Accessories		Type	Part No.	Std. Pack
Cross connector, insulated**		2 pole	IVB WKFN 10–2	Z7.283.8227.0
Reducing jumper, WKF 35 to WKFN 10 ³⁾			IVB WKFN 35R10	Z7.285.6427.0
Cover with warning symbol over 4 blocks		yellow	ADF 10/4 GELB	04.343.6453.8
Test plug			ST 2/2,3	Z5.553.2921.0
Screwdriver, uninsulated			DIN 5264 B 1x5,5	06.502.4200.0

** When cross connectors are used acc. to EN 60079-0 and EN 60079-7 the current must be reduced to 4 A/40 K or 5 A/45 K for type WKFN 10/35.





Feed-through blocks with tension spring connection

WKFN 16/35

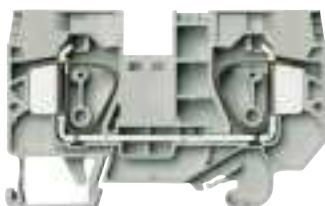
- Feed-through block with tension spring connection for mounting on TS 35
- Nominal cross section 16 mm²
- Ex e I/II  II 2GD IM2
Follow the EX installation instructions on page 143





Description	Type	Part No.	Std. Pack
Feed-through block, gray	WKFN 16/35	56.716.0055.0	50
Feed-through block, blue	WKFN 16/35 BLAU	56.716.0055.6	100
General data			
Width / length / height, incl. TS 7.5	12 mm / 79 mm / 50 mm		
Wire strip length	16 mm		
Approvals	 PTB 06 ATEX 1075 U		
Technical data	IEC	UL	CSA 
	EN 60 947-7-1		EN 60 079-0/-7
Cross section fine-stranded	0.2–16 mm ²		0.2–16 mm ²
Cross section solid/stranded	1.5–25 mm ²		1.5–25 mm ²
Cross section, AWG		16–4	16–4
Rated current	76 A	85 A	85 A
Rated voltage	1000 V	600 V	600 V
Rated impulse voltage	8 kV		550 V
Pollution degree	3		
Note			* 1. value at 40K/ 2. value at 45K
Accessories			
End plate, gray	APFN 16	07.313.1255.0	10
End plate, blue	APFN 16 BLAU	07.313.1255.6	10
Partition, gray	TWFN 16	07.313.1355.0	10
Cross connector, insulated** 2 pole	IVB WKF 16–2	Z7.284.4227.0	10
Cover with warning symbol for 4 blocks	ADF 16/4 GELB	04.343.6653.8	10

WKFN 16 D1/2/35

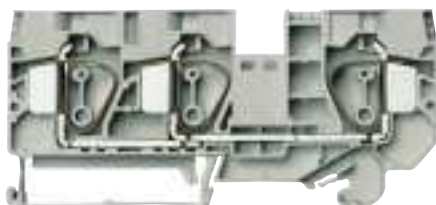
- Duo-feed-through block with tension spring connection for mounting on TS 35
- Nominal cross section 16 mm²
- Ex e I/II  II 2GD IM2
Follow the EX installation instructions on page 143





Description	Type	Part No.	Std. Pack
Feed-through block, gray	WKFN 16 D1/2/35	56.716.5055.0	50
Feed-through block, blue	WKFN 16 D1/2/35 BLAU	56.716.5055.6	100
General data			
Width / length / height, incl. TS 7.5	12 mm / 107 mm / 50 mm		
Wire strip length	16 mm		
Approvals	 PTB 06 ATEX 1075 U		
Technical data	IEC	UL	CSA 
	EN 60 947-7-1		EN 60 079-0/-7
Cross section fine-stranded	0.2–16 mm ²		0.2–16 mm ²
Cross section solid/stranded	1.5–25 mm ²		1.5–25 mm ²
Cross section, AWG		16–4	16–4
Rated current	76 A	85 A	85 A
Rated voltage	1000 V	600 V	600 V
Rated impulse voltage	8 kV		550 V
Pollution degree	3		
Note			* 1. value at 40K/ 2. value at 45K
Accessories			
End plate, gray	APFN 16 D1/2	07.313.1455.0	10
End plate, blue	APFN 16 D1/2 BLAU	07.313.1455.6	10
Partition, gray	TWFN 16 D1/2	07.313.1555.0	10
Cross connector, insulated** 2 pole	IVB WKF 16–2	Z7.284.4227.0	10
Cover with warning symbol for 4 blocks	ADF 16/4 GELB	04.343.6653.8	10

WKF 35/35

- Feed-through block with tension spring connection for mounting on TS 35
- Nominal cross section 35 mm²
- Ex e II  II 2GD
Follow the EX installation instructions on page 143



Description	Type	Part No.	Std. Pack
Feed-through block, gray	WKF 35/35	56.735.0053.0	10
Feed-through block, blue	WKF 35/35 BLAU	56.735.0053.6	10
General data			
Width / length / height, incl. TS 7.5	16 mm / 100 mm / 59 mm		
Wire strip length	18 mm		
Approvals	 KEMA 03 ATEX 2057 U		
Technical data	IEC	UL	CSA 
	EN 60 947-7-1		EN 60 079-0/-7
Cross section fine-stranded	2.5–35 mm ²		2.5–35 mm ²
Cross section solid/stranded	2.5–35 mm ²		2.5–35 mm ²
Cross section, AWG		12–2	12–2
Rated current	125 A	115 A	115 A
Rated voltage	800 V	600 V	600 V
Rated impulse voltage	8 kV		690 V
Pollution degree	3		
Note			¹⁾ with/without jumper
Accessories			
Cross connector, insulated 2 pole	IVB WKF 35-2	Z7.285.6227.0	10

Potential supply with feed-through blocks up to 35 mm²

$I_{max E}$: $I_{max. supply}$
 $I_{max R}$: $I_{reducing cross connector}$
 I_{N-A} : I_N output terminal blocks

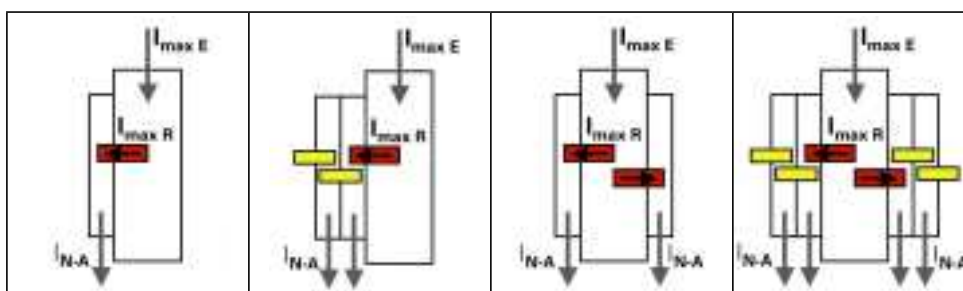



Potential distribution	Distribution on one side		Distribution on both sides	
	2 poles	several poles	2 poles	several poles
35-R-10 $I_{max. supply}$	125 A	125 A	125 A	125 A
$I_{reducing cross connector}$	57 A	105 A	57 A	105 A
I_N output terminal blocks	57 A	57 A	57 A	57 A





Potential distribution 35 R 10 <ul style="list-style-type: none"> • Potential supply 35 mm² • Reducing cross connector 35R10 • Potential output 10 mm² 	Function	Type	Part No.	Std. Pack
	Supply block, gray	WKF 35 /35	56.735.0053.0	10
	Supply block, gray	WKF 35 /35 BLAU	56.735.0053.6	10
	Reducing cross connector ²⁾	IVB WKFN 35R10	Z7.285.6427.0	10
	Output block, gray	WKFN 10 /35	56.710.0055.0	10
	Output block, blue	WKFN 10 /35 BLAU	56.710.0055.6	10
	Output block, gray	WKFN 10 D1/2/35	56.710.5055.0	10
	Output block, blue	WKFN 10 D1/2/35 BLAU	56.710.5055.6	10
²⁾ When cross connectors are used acc. to EN 60079-0 and EN 60079-7 the current must be reduced (values to be requested)				

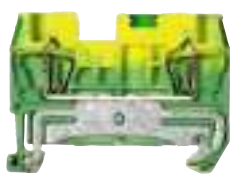



Accessories for *fasis* WKFN 16... and WKF 35

	Accessories	Type	Part No.	Std. Pack
	Test plug	ST 2/2,3	Z5.553.2921.0	10
	Screwdriver, uninsulated	DIN 5264 B 1x5,5	06.502.4200.0	5
** When cross connectors are used according to EN 60079-0 and EN 60079-7, the current must be reduced to max. 3.5 A.				

Ground blocks with tension spring connection

<p>WKF 1,5 SL/35</p> <ul style="list-style-type: none"> • Ground block with tension spring connection for mounting on TS 35 • Nominal cross section 1.5 mm² • Ex e I/II  II 2GD IM2 Follow the EX installation instructions on page 143 	Description	Type	Part No.	Std. Pack	
	Ground block, green/yellow	WKF 1,5 SL/35	56.702.9053.0	50	
	General data				
	Width / length / height, incl. TS 7.5	4 mm / 49 mm / 37 mm			
	Wire strip length	10 mm			
	Approvals	ATEX  KEMA 03 ATEX 2056 U			
	Technical data				
		IEC	UL	CSA	
		EN 60 947-7-2			EN 60 079-0/-7
	Cross section fine-stranded	0.08–1.5 mm ²		0.14–1.5 mm ²	
	Cross section solid/stranded	0.08–1.5 mm ²		0.14–1.5 mm ²	
	Cross section, AWG	24–14		24–14	
	Rated current				
	Rated voltage	500 V	300 V	300 V	440 V*
	Rated impulse voltage	6 kV			
Pollution degree	3				
Accessories					
End plate, gray	APF 1,5		07.312.8153.0	10	
Partition, gray	TWF 1,5		07.312.8253.0	10	

<p>WKF 1,5 D1/2/SL/35</p> <ul style="list-style-type: none"> • Duo ground block with tension spring connection for mounting on TS 35 • Nominal cross section 1.5 mm² • Ex e I/II  II 2GD IM2 Follow the EX installation instructions on page 143 	Description	Type	Part No.	Std. Pack	
	Ground block, green/yellow	WKF 1,5 D1/2/SL/35	56.702.9353.0	50	
	General data				
	Width / length / height, incl. TS 7.5	4 mm / 60 mm / 37 mm			
	Wire strip length	10 mm			
	Approvals	ATEX  KEMA 03 ATEX 2056 U			
	Technical data				
		IEC	UL	CSA	
		EN 60 947-7-2			EN 60 079-0/-7
	Cross section fine-stranded	0.08–1.5 mm ²		0.14–1.5 mm ²	
	Cross section solid/stranded	0.08–1.5 mm ²		0.14–1.5 mm ²	
	Cross section, AWG	24–14		24–14	
	Rated current				
	Rated voltage	500 V	300 V	300 V	440 V*
	Rated impulse voltage	6 kV			
Pollution degree	3				
Accessories					
End plate, gray	APF 1,5 D1/2		07.312.8353.0	10	
Segment end plate	SAPF 1,5		07.312.8953.0	10	
Partition, gray	TWF 1,5 D1/2		07.312.8453.0	10	

<p>WKF 1,5 D2/2/SL/35</p> <ul style="list-style-type: none"> • Duo ground block with tension spring connection for mounting on TS 35 • Nominal cross section 1.5 mm² • Ex e I/II  II 2GD IM2 Follow the EX installation instructions on page 143 	Description	Type	Part No.	Std. Pack	
	Ground block, green/yellow	WKF 1,5 D2/2/SL/35	56.702.9153.0	50	
	General data				
	Width / length / height, incl. TS 7.5	4 mm / 72 mm / 37 mm			
	Wire strip length	10 mm			
	Approvals	ATEX  KEMA 03 ATEX 2056 U			
	Technical data				
		IEC	UL	CSA	
		EN 60 947-7-2			EN 60 079-0/-7
	Cross section fine-stranded	0.08–1.5 mm ²		0.14–1.5 mm ²	
	Cross section solid/stranded	0.08–1.5 mm ²		0.14–1.5 mm ²	
	Cross section, AWG	24–14		24–14	
	Rated current				
	Rated voltage	500 V	300 V	300 V	440 V*
	Rated impulse voltage	6 kV			
Pollution degree	3				
Accessories					
End plate, gray	APF 1,5 D2/2		07.312.8553.0	10	
Segment end plate	SAPF 1,5		07.312.8953.0	10	
Partition, gray	TWF 1,5 D2/2		07.312.8653.0	10	

Accessories for *fasis* WKF 1.5...

	Accessories				
	Wire entry guide	0.13–0.2 mm ²	LEL 1,5/1 WEISS	05.564.4253.0	100
		0.25–0.5 mm ²	LEL 1,5/2 GRAU	05.564.4353.0	100
	Cover with warning symbol over 5 blocks	yellow	ADF 1,5/5 GELB	04.343.6953.8	10
	Screwdriver, uninsulated		DIN 5264 B 0,4x2,5	06.502.4300.0	5
* In order to maintain the proper isolation distances, the open side of a ground block is to be covered by an end plate.					

Description		Type	Part No.	Std. Pack
Ground block, green/yellow		WKFN 2,5 SL/35	56.703.9055.0	100
General data				
Width / length / height, incl. TS 7.5		5 mm / 47 mm / 38 mm		
Wire strip length		11 mm		
Approvals		PTB PTB 04 ATEX 1051 U		
Technical data		IEC	UL	CSA
		EN 60 947-7-2		EN 60 079-0/-7
Cross section fine-stranded		0.13–2.5 mm ²		0.2–2.5 mm ²
Cross section solid/stranded		0.13–4 mm ²		0.13–4 mm ²
Cross section, AWG		22–12	24–12	
Rated current				
Rated voltage		800 V	600 V	600 V
Rated impulse voltage		8 kV		
Pollution degree		3		
Accessories				
End plate, gray		Type	Part No.	Std. Pack
		APFN 2,5	07.312.6755.0	10

WKFN 2,5 SL/35

- Ground block with tension spring connection for mounting on TS 35
- Nominal cross section 2.5 mm²
- Ex e I/II II 2GD IM2
Follow the EX installation instructions on page 143



Description		Type	Part No.	Std. Pack
Ground block, green/yellow		WKFN 2,5 D1/2/SL/35	56.703.9355.0	100
General data				
Width / length / height, incl. TS 7.5		5 mm / 60 mm / 38 mm		
Wire strip length		11 mm		
Approvals		PTB PTB 04 ATEX 1051 U		
Technical data		IEC	UL	CSA
		EN 60 947-7-2		EN 60 079-0/-7
Cross section fine-stranded		0.13–2.5 mm ²		0.2–2.5 mm ²
Cross section solid/stranded		0.13–4 mm ²		0.13–4 mm ²
Cross section, AWG		22–12	24–12	
Rated current				
Rated voltage		800 V	600 V	600 V
Rated impulse voltage		8 kV		
Pollution degree		3		
Accessories				
End plate, gray		Type	Part No.	Std. Pack
		APFN 2,5 D1/2	07.312.6955.0	10

WKFN 2,5 D1/2/SL/35

- Duo-Ground block with tension spring connection for mounting on TS 35
- Nominal cross section 2.5 mm²
- Ex e I/II II 2GD IM2
Follow the EX installation instructions on page 143



Description		Type	Part No.	Std. Pack
Ground block, green/yellow		WKFN 2,5 D2/2/SL/35	56.703.9155.0	100
General data				
Width / length / height, incl. TS 7.5		5 mm / 72 mm / 38 mm		
Wire strip length		11 mm		
Approvals		PTB PTB 04 ATEX 1051 U		
Technical data		IEC	UL	CSA
		EN 60 947-7-2		EN 60 079-0/-7
Cross section fine-stranded		0.13–2.5 mm ²		0.2–2.5 mm ²
Cross section solid/stranded		0.13–4 mm ²		0.13–4 mm ²
Cross section, AWG		22–12	24–12	
Rated current				
Rated voltage		800 V	600 V	600 V
Rated impulse voltage		8 kV		
Pollution degree		3		
Accessories				
End plate, gray		Type	Part No.	Std. Pack
		APFN 2,5 D2/2	07.312.7155.0	10

WKFN 2,5 D2/2/SL/35

- Duo ground block with tension spring connection for mounting on TS 35
- Nominal cross section 2.5 mm²
- Ex e I/II II 2GD IM2
Follow the EX installation instructions on page 143



Accessories for fasis WKFN 2,5...

Accessories		Type	Part No.	Std. Pack
Wire entry guide	0.13–0.2 mm ²	LELN 2,5/1 WEISS	05.564.3755.0	100
	0.25–0.5 mm ²	LELN 2,5/2 GRAU	05.564.3855.0	100
	0.75–1.0 mm ²	LELN 2,5/3 SCHWARZ	05.564.3955.0	100
Cover with warning symbol over 4 blocks	yellow	ADFN 2,5/4 GELB	04.343.8353.8	10
Screwdriver, uninsulated		DIN 5264 B 0,6x3,5	06.502.4000.0	5
Screwdriver, uninsulated, MINI		DIN 5264 B 0,6x3,5 M	06.502.5000.0	10

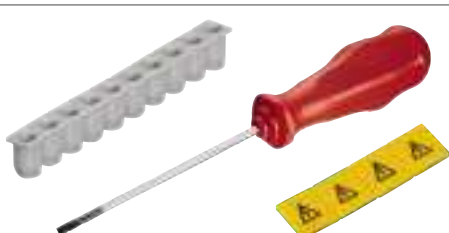





Ground blocks with tension spring connection

WKFN 4 SL/35

- Ground block with tension spring connection for mounting on TS 35
- Nominal cross section 4 mm²
- Ex e I/II  II 2GD IM2
Follow the EX installation instructions on page 143







Description	Type	Part No.	Std. Pack
Ground block, green/yellow	WKFN 4 SL/35	56.704.9055.0	100
General data			
Width / length / height, incl. TS 7.5	6 mm / 51 mm / 38 mm		
Wire strip length	11 mm		
Approvals	   PTB 05 ATEX 1104 U		
Technical data	IEC	UL	CSA 
	EN 60 947-7-2		EN 60 079-0/-7
Cross section fine-stranded	0.13–4 mm ²		0.13–4 mm ²
Cross section solid/stranded	0.13–6 mm ²		0.2–6 mm ²
Cross section, AWG		24–10	24–10
Rated current			
Rated voltage	800 V	600 V	600 V
Rated impulse voltage	8 kV		
Pollution degree	3		
Accessories			
End plate, gray	APFN 4	07.312.9255.0	10

WKFN 4 D1/2/SL/35

- Duo ground block with tension spring connection for mounting on TS 35
- Nominal cross section 4 mm²
- Ex e I/II  II 2GD IM2
Follow the EX installation instructions on page 143







Description	Type	Part No.	Std. Pack
Ground block, green/yellow	WKFN 4 D1/2/SL/35	56.704.9355.0	100
General data			
Width / length / height, incl. TS 7.5	6 mm / 67 mm / 38 mm		
Wire strip length	11 mm		
Approvals	   PTB 05 ATEX 1104 U		
Technical data	IEC	UL	CSA 
	EN 60 947-7-2		EN 60 079-0/-7
Cross section fine-stranded	0.13–4 mm ²		0.13–4 mm ²
Cross section solid/stranded	0.13–6 mm ²		0.2–6 mm ²
Cross section, AWG		24–10	24–10
Rated current			
Rated voltage	800 V	600 V	600 V
Rated impulse voltage	8 kV		
Pollution degree	3		
Accessories			
End plate, gray	APFN 4 D1/2	07.312.9455.0	10

WKFN 4 D2/2/SL/35

- Duo ground block with tension spring connection for mounting on TS 35
- Nominal cross section 4 mm²
- Ex e I/II  II 2GD IM2
Follow the EX installation instructions on page 143



Description	Type	Part No.	Std. Pack
Ground block, green/yellow	WKFN 4 D2/2/SL/35	56.704.9155.0	100
General data			
Width / length / height, incl. TS 7.5	6 mm / 82 mm / 38 mm		
Wire strip length	11 mm		
Approvals	   PTB 05 ATEX 1104 U		
Technical data	IEC	UL	CSA 
	EN 60 947-7-2		EN 60 079-0/-7
Cross section fine-stranded	0.13–4 mm ²		0.13–4 mm ²
Cross section solid/stranded	0.13–6 mm ²		0.2–6 mm ²
Cross section, AWG		24–10	24–10
Rated current			
Rated voltage	800 V	600 V	600 V
Rated impulse voltage	8 kV		
Pollution degree	3		
Accessories			
End plate, gray	APFN 4 D2/2	07.312.9055.0	10

Accessories for *fasis* WKFN 4...





Accessories	Type	Part No.	Std. Pack
Wire entry guide	0.13–0.2 mm ²	LEL 4/1 WEISS	05.561.8553.0
	0.25–0.5 mm ²	LEL 4/2 GRAU	05.561.8653.0
	0.75–1.0 mm ²	LEL 4/3 SCHWARZ	05.561.8753.0
Cover with warning symbol over 4 blocks	yellow	ADF 4/4 GELB	04.343.6153.8
Test plug		ST 2/2,3	Z5.553.2921.0
Screwdriver, uninsulated		DIN 5264 B 0,6x3,5	06.502.4000.0
Screwdriver, uninsulated, MINI		DIN 5264 B 0,6x3,5 M	06.502.5000.0

WKFN 6 SL/35

- Ground block with tension spring connection for mounting on TS 35
- Nominal cross section 6 mm²
- Ex e I/II  II 2GD IM2
Follow the EX installation instructions on page 143





Description	Type	Part No.	Std. Pack
Ground block, green/yellow	WKFN 6 SL/35	56.706.9055.0	100
General data			
Width / length / height, incl. TS 7.5	8 mm / 66 mm / 45 mm		
Wire strip length	12 mm		
Approvals	 PTB 06 ATEX 1075 U		
Technical data	IEC	UL	CSA 
	EN 60 947-7-2		EN 60 079-0/-7
Cross section fine-stranded	0.2–6 mm ²		0.2–6 mm ²
Cross section solid/stranded	1.5–10 mm ²		1.5–10 mm ²
Cross section, AWG	24–8	24–8	
Rated current			
Rated voltage	800 V	600 V	600 V
Rated impulse voltage	8 kV		
Pollution degree	3		
Accessories			
End plate, gray	APFN 6	07.313.0455.0	10

WKFN 6 D1/2/SL/35

- Duo ground block with tension spring connection for mounting on TS 35
- Nominal cross section 6 mm²
- Ex e I/II  II 2GD IM2
Follow the EX installation instructions on page 143



Description	Type	Part No.	Std. Pack
Ground block, green/yellow	WKFN 6 D1/2/SL/35	56.706.9355.0	100
General data			
Width / length / height, incl. TS 7.5	8 mm / 90 mm / 45 mm		
Wire strip length	12 mm		
Approvals	 PTB 06 ATEX 1075 U		
Technical data	IEC	UL	CSA 
	EN 60 947-7-2		EN 60 079-0/-7
Cross section fine-stranded	0.2–6 mm ²		0.2–6 mm ²
Cross section solid/stranded	1.5–10 mm ²		1.5–10 mm ²
Cross section, AWG	24–8	24–8	
Rated current	50 A		
Rated voltage	800 V	600 V	600 V
Rated impulse voltage	8 kV		
Pollution degree	3		
Accessories			
End plate, gray	APFN 6 D1/2	07.313.0655.0	10

Accessories for *fasis* WKFN 6...

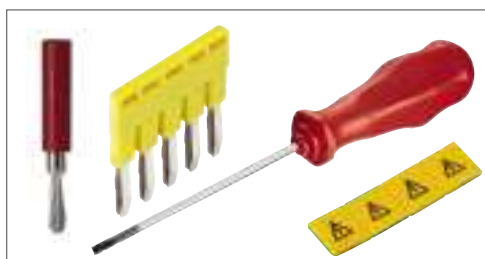

Accessories	Type	Part No.	Std. Pack
Cross connector, insulated*	2 pole	IVB WKFN 6–2	Z7.282.5227.0
	3 pole	IVB WKFN 6–3	Z7.282.5327.0
	4 pole	IVB WKFN 6–4	Z7.282.5427.0
	5 pole	IVB WKFN 6–5	Z7.282.5527.0
	Cover with warning symbol over 4 blocks	yellow	ADF 6/4 GELB
Test plug	ST 2/2,3	Z5.553.2921.0	10
Screwdriver, uninsulated	DIN 5264 B 0,8x4	06.502.4100.0	5



* When cross connectors are used according to EN 60079-0 and EN 60079-7, the current must be reduced to max. 3.5 A.

Ground blocks with tension spring connection

WKFN 10 SL/35

- Ground block with tension spring connection for mounting on TS 35
- Nominal cross section 10 mm²
- Ex e I/II  II 2GD IM2
Follow the EX installation instructions on page 143





Description	Type	Part No.	Std. Pack
Ground block, green/yellow	WKFN 10 SL/35	56.710.9055.0	50
General data			
Width / length / height, incl. TS 7.5	10 mm / 72 mm / 50 mm		
Wire strip length	15 mm		
Approvals			PTB 06 ATEX 1075 U
Technical data	IEC	UL	CSA 
	EN 60 947-7-2		EN 60 079-0/-7
Cross section fine-stranded	0.2–10 mm ²		0.2–10 mm ²
Cross section solid/stranded	1.5–16 mm ²		1.5–16 mm ²
Cross section, AWG	16–6		16–6
Rated current			
Rated voltage	1000 V	600 V	600 V
Rated impulse voltage	8 kV		
Pollution degree	3		
Accessories			
End plate, gray	Type	Part No.	Std. Pack
	WKFN 10 SL/35	56.710.9055.0	10

WKFN 10 D1/2/SL/35

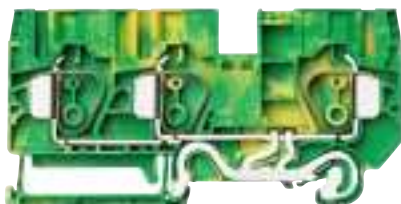
- Duo ground block with tension spring connection for mounting on TS 35
- Nominal cross section 10 mm²
- Ex e I/II  II 2GD IM2
Follow the EX installation instructions on page 143





Description	Type	Part No.	Std. Pack
Ground block, green/yellow	WKFN 10 D1/2/SL/35	56.710.9355.0	50
General data			
Width / length / height, incl. TS 7.5	10 mm / 98 mm / 50 mm		
Wire strip length	15 mm		
Approvals			PTB 06 ATEX 1075 U
Technical data	IEC	UL	CSA 
	EN 60 947-7-2		EN 60 079-0/-7
Cross section fine-stranded	0.2–10 mm ²		0.2–10 mm ²
Cross section solid/stranded	1.5–16 mm ²		1.5–16 mm ²
Cross section, AWG	16–6		
Rated current			
Rated voltage	1000 V	600 V	
Rated impulse voltage	8 kV		
Pollution degree	3		
Accessories			
End plate, gray	Type	Part No.	Std. Pack
	APFN 10 D1/2	07.313.1055.0	10

WKFN 16 SL/35

- Ground block with tension spring connection for mounting on TS 35
- Nominal cross section 16 mm²
- Ex e I/II  II 2GD IM2
Follow the EX installation instructions on page 143





Description	Type	Part No.	Std. Pack
Ground block, green/yellow	WKFN 16 SL/35	56.716.9055.0	50
General data			
Width / length / height, incl. TS 7.5	12 mm / 79 mm / 50 mm		
Wire strip length	16 mm		
Approvals			PTB 06 ATEX 1075 U
Technical data	IEC	UL	CSA 
	EN 60 947-7-2		EN 60 079-0/-7
Cross section fine-stranded	0.2–16 mm ²		0.2–16 mm ²
Cross section solid/stranded	1.5–25 mm ²		1.5–25 mm ²
Cross section, AWG	16–4		16–4
Rated current			
Rated voltage	1000 V	600 V	600 V
Rated impulse voltage	8 kV		
Pollution degree	3		
Accessories			
End plate, gray	Type	Part No.	Std. Pack
	APFN 16	07.313.1255.0	10

WKFN 16 D1/2/SL/35

- Duo ground block with tension spring connection for mounting on TS 35
- Nominal cross section 16 mm²
- Ex e I/II  II 2GD IM2
Follow the EX installation instructions on page 143

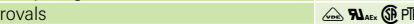



Description	Type	Part No.	Std. Pack
Ground block, green/yellow	WKFN 16 D1/2/SL/35	56.716.9355.0	50
General data			
Width / length / height, incl. TS 7.5	12 mm / 107 mm / 50 mm		
Wire strip length	16 mm		
Approvals	 PTB 06 ATEX 1075 U		
Technical data	IEC	UL	CSA
	EN 60 947-7-2		 EN 60 079-0/-7
Cross section fine-stranded	0.2–16 mm ²		0.2–16 mm ²
Cross section solid/stranded	1.5–25 mm ²		1.5–25 mm ²
Cross section, AWG		16–4	
Rated current			
Rated voltage	1000 V		600 V
Rated impulse voltage	8 kV		
Pollution degree	3		
Accessories			
End plate, gray	APFN 16 D1/2	07.313.1455.	10

WKF 35 SL/35

- Ground block with tension spring connection for mounting on TS 35
- Nominal cross section 35 mm²
- Ex e II  II 2GD
Follow the EX installation instructions on page 143



Description	Type	Part No.	Std. Pack
Ground block, green/yellow	WKF 35 SL/35	56.735.9053.0	10
General data			
Width / length / height, incl. TS 7.5	16 mm / 100 mm / 59 mm		
Wire strip length	18 mm		
Approvals	 KEMA 03 ATEX 2057 U		
Technical data	IEC	UL	CSA
	EN 60 947-7-1		 EN 60 079-0/-7
Cross section fine-stranded	2.5–35 mm ²		2.5–35 mm ²
Cross section solid/stranded	2.5–35 mm ²		2.5–35 mm ²
Cross section, AWG		12–2	12–2
Rated current			
Rated voltage	800 V	600 V	600 V
Rated impulse voltage	8 kV		690 V
Pollution degree	3		
Accessories			
Cross connector, insulated	2 pole	IVB WKF 35–2	Z7.285.6227.0
Cover with warning symbol over 4 blocks		ADF 35/5 GELB	04.343.9253.8
Test plug		ST 2/2,3	Z5.553.2921.0

Accessories for *fasis* WKFN 10 SL/... and WKFN 16 SL/...

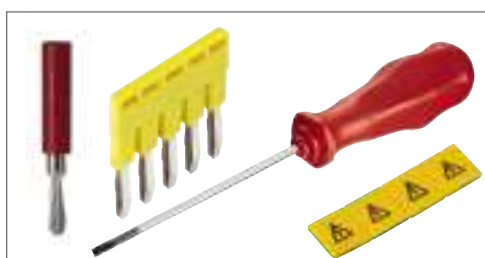

Accessories	Type	Part No.	Std. Pack
Test plug	ST 2/2,3	Z5.553.2921.0	10
Screwdriver, uninsulated	DIN 5264 B 1x5,5	06.502.4200.0	5
for WKFN 10 ...			
Cross connector, insulated**	2 pole	IVB WKF 10–2	Z7.283.8227.0
Cover with warning symbol over 4 blocks	yellow	ADF 10/4 GELB	04.343.6453.8
for WKFN 16 ...			
Cross connector, insulated*	2 pole	IVB WKF 16–2	Z7.284.4227.0
Cover with warning symbol over 4 blocks	yellow	ADF 16/4 GELB	04.343.6653.8



** When cross connectors are used acc. to EN 60079-0 and EN 60079-7 the current must be reduced to 4 A/40 K or 5 A/45 K for type WKFN 10/35.

Multi-tier terminal blocks with tension spring connection

WKF 1,5 E2/35

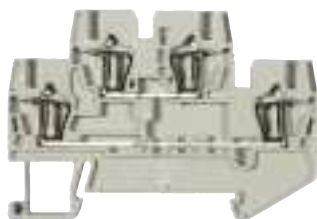
- Multi-tier block with tension spring connection for mounting on TS 35
- Nominal cross section 1.5 mm²
- Ex e II  II 2GD
Follow the EX installation instructions on page 143





Description	Type	Part No.	Std. Pack
Multi-tier block, gray	WKF 1,5 E2/35	56.702.7653.0	50
General data			
Width / length / height, incl. TS 7.5	4 mm / 68 mm / 47 mm		
Wire strip length	10 mm		
Approvals	ATEX  KEMA 03 ATEX 2056 U		
Technical data	IEC	UL	CSA 
	EN 60 947-7-1		EN 60 079-0/-7
Cross section fine-stranded	0.08–1.5 mm ²		0.14–1.5 mm ²
Cross section solid/stranded	0.08–1.5 mm ²		0.14–1.5 mm ²
Cross section, AWG	26–14		26–14
Rated current	17,5 A	15 A	15 A
Rated voltage	500 V	300 V	300 V
Rated impulse voltage	6 kV		440 V ²⁾
Pollution degree	3		
Note	¹⁾ Rated current when using cross connectors ²⁾ For maintaining the proper isolation distances, the open side of a feed-through terminal block as well as both sides of a jumper are to be covered by partitions.		

WKF 1,5 E2/VB/35

- Multi-tier block, vertically connected, with tension spring connection for mounting on TS 35
- Nominal cross section 1.5 mm²
- Ex e II  II 2GD
Follow the EX installation instructions on page 143





Description	Type	Part No.	Std. Pack
Multi-tier block, black	WKF 1,5 E2/VB/35	56.702.6953.1	50
General data			
Width / length / height, incl. TS 7.5	4 mm / 68 mm / 47 mm		
Wire strip length	10 mm		
Approvals	ATEX  KEMA 03 ATEX 2056 U		
Technical data	IEC	UL	CSA 
	EN 60 947-7-1		EN 60 079-0/-7
Cross section fine-stranded	0.08–1.5 mm ²		0.14–1.5 mm ²
Cross section solid/stranded	0.08–1.5 mm ²		0.14–1.5 mm ²
Cross section, AWG	26–14		26–14
Rated current	17,5 A	15 A	15 A
Rated voltage	500 V	300 V	300 V
Rated impulse voltage	6 kV		440 V ²⁾
Pollution degree	3		
Note	¹⁾ Rated current when using cross connectors ²⁾ For maintaining the proper isolation distances, the open side of a feed-through terminal block as well as both sides of a jumper are to be covered by partitions.		



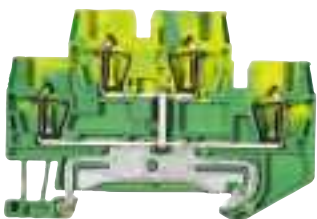

WKF 1,5 E2/SL/35

- Multi-tier ground block with tension spring connection for mounting on TS 35
- Nominal cross section 1.5 mm²
- Ex e II  II 2GD
Follow the EX installation instructions on page 143

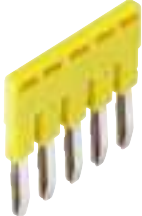

Description	Type	Part No.	Std. Pack
Multi-tier ground block, green/yellow	WKF 1,5 E2/SL/35	56.702.9253.0	50
General data			
Width / length / height, incl. TS 7.5	4 mm / 68 mm / 47 mm		
Wire strip length	10 mm		
Approvals	ATEX  KEMA 03 ATEX 2056 U		
Technical data	IEC	UL	CSA 
	EN 60 947-7-2		EN 60 079-0/-7
Cross section fine-stranded	0.08–1.5 mm ²		0.14–1.5 mm ²
Cross section solid/stranded	0.08–1.5 mm ²		0.14–1.5 mm ²
Cross section, AWG	26–14		26–14
Rated current			¹⁾
Rated voltage	500 V	300 V	300 V
Rated impulse voltage	6 kV		
Pollution degree	3		
Note	¹⁾ For maintaining the proper isolation distances, the open side of a feed-through terminal block as well as both sides of a jumper are to be covered by partitions.		

Accessories for *fasis* WKF 1,5...

Accessories		Type	Part No.	Std. Pack
	End plate	gray APF 1,5 E2	07.312.8753.0	10
	Partition	gray TWF 1,5 E2	07.312.8853.0	10
	Cross connector, insulated	2 pole IVB WKF 1,5-2	Z7.268.0227.0	10
		3 pole IVB WKF 1,5-3	Z7.268.0327.0	10
		4 pole IVB WKF 1,5-4	Z7.268.0427.0	10
		5 pole IVB WKF 1,5-5	Z7.268.0527.0	10
		10 pole IVB WKF 1,5-10	Z7.268.1027.0	10
		20 pole IVB WKF 1,5-20	Z7.268.2027.0	10
	Wire entry guide	0.13-0.2 mm ² LEL 1,5/1 WEISS	05.564.4253.0	10
		0.25-0.5 mm ² LEL 1,5/2 GRAU	05.564.4353.0	10
	Cover with warning symbol over 5 blocks	yellow ADF 1,5/5 GELB	04.343.6953.8	10
	Marking tag carrier, 2-fold	BT 4/2	04.243.0953.0	100
	Screwdriver, uninsulated	DIN 5264 B 0,4x2,5	06.502.4300.0	5

Multi-tier blocks with tension spring connection





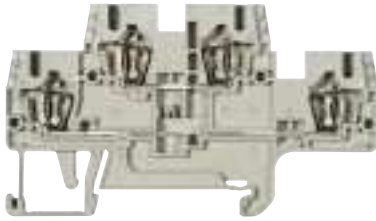

WKFN 2,5 E/35

WKFN 2,5 E/N/D/35

- Multi-tier block with tension spring connection for mounting on TS 35
- Nominal cross section 2.5 mm²
- Ex e I/II  II 2GD IM2
Follow the EX installation instructions on page 143



Description	Type	Part No.	Std. Pack
Multi-tier block, gray	WKFN 2,5 E/35	56.703.7055.0	100
Multi-tier block, combined, gray	WKFN 2,5 E/N/D/35	56.703.7655.0	100

General data				
Width / length / height, incl. TS 7.5	5 mm / 82 mm / 48 mm			
Wire strip length	11 mm			
Approvals	PTB     		PTB 04 ATEX 1051 U	
Technical data	IEC	UL	CSA	
	EN 60 947-7-1			EN 60 079-0/-7
Cross section fine-stranded	0.13–2.5 mm ²			0.2–2.5 mm ²
Cross section solid/stranded	0.13–4 mm ²			0.13–4 mm ²
Cross section, AWG		22–12	24–12	
Rated current	24 A	20 A	24 A	20/21,5 A ¹⁾
Rated voltage	500 V	300 V	300 V	440/275 V ²⁾
Rated impulse voltage	6 kV			
Pollution degree	3			
Note	¹⁾ 1. value at 40 K / 2. value at 45 K ²⁾ When using cross connectors on the upper tier			

WKFN 2,5 E/N/D/35





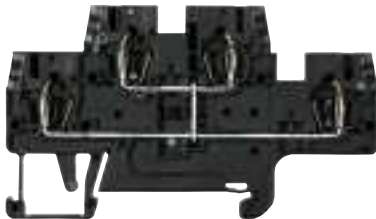

	Function	Color ID
Upper tier	Feed-through	blue
Lower tier	Feed-through	gray

WKFN 2,5 E/VB/35

- Multi-tier block, vertically connected, with tension spring connection for mounting on TS 35
- Nominal cross section 2.5 mm²
- Ex e I/II  II 2GD IM2
Follow the EX installation instructions on page 143



Description	Type	Part No.	Std. Pack
Multi-tier block, black	WKFN 2,5 E/VB/35	56.703.6955.1	100





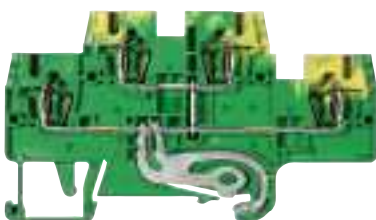

General data				
Width / length / height, incl. TS 7.5	5 mm / 82 mm / 48 mm			
Wire strip length	11 mm			
Approvals	PTB     		PTB 04 ATEX 1051 U	
Technical data	IEC	UL	CSA	
	EN 60 947-7-1			EN 60 079-0/-7
Cross section fine-stranded	0.13–2.5 mm ²			0.2–2.5 mm ²
Cross section solid/stranded	0.13–4 mm ²			0.13–4 mm ²
Cross section, AWG		22–12	24–12	
Rated current	24 A	20 A	24 A	20/21,5 A ¹⁾
Rated voltage	500 V	600 V	600 V	440 V
Rated impulse voltage	6 kV			
Pollution degree	3			
Note	¹⁾ 1. value at 40 K / 2. value at 45 K			

WKFN 2,5 E/SL/35

- Ground block with tension spring connection for mounting on TS 35
- Nominal cross section 2.5 mm²
- Ex e I/II  II 2GD IM2
Follow the EX installation instructions on page 143



Description	Type	Part No.	Std. Pack
Ground block, green/yellow	WKFN 2,5 E/SL/35	56.703.8955.0	100



General data				
Width / length / height, incl. TS 7.5	5 mm / 82 mm / 48 mm			
Wire strip length	11 mm			
Approvals	PTB     		PTB 04 ATEX 1051 U	
Technical data	IEC	UL	CSA	
	EN 60 947-7-2			EN 60 079-0/-7
Cross section fine-stranded	0.13–2.5 mm ²			0.2–2.5 mm ²
Cross section solid/stranded	0.13–4 mm ²			0.13–4 mm ²
Cross section, AWG		22–12	24–12	
Rated current				
Rated voltage	500 V	600 V	600 V	
Rated impulse voltage	6 kV			
Pollution degree	3			

WKFN 2,5 E/D/SL/35 WKFN 2,5 E/N/SL/35

- Multi-tier block, combined, with tension spring connection for mounting on TS 35
- Nominal cross section 2.5 mm²
- Ex e I/II  II 2GD IM2
Follow the EX installation instructions on page 143

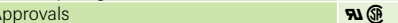

Description	Type	Part No.	Std. Pack
Multi-tier block, combined, gray	WKFN 2,5 E/D/SL/35	56.703.7855.0	100
Multi-tier block, combined, gray	WKFN 2,5 E/N/SL/35	56.703.7755.0	100

General data				
Width / length / height, incl. TS 7.5	5 mm / 82 mm / 48 mm			
Wire strip length	11 mm			
Approvals	 PTB 04 ATEX 1051 U			
Technical data		IEC	UL	CSA
				
	EN 60 947-7-1			EN 60 079-0/-7
Cross section fine-stranded	0.13–2.5 mm ²			
Cross section solid/stranded	0.13–4 mm ²			
Cross section, AWG		22–12	24–12	
Rated current	24 A	20 A	24 A	
Rated voltage	500 V	300 V	300 V	
Rated impulse voltage	6 kV			
Pollution degree	3			

WKFN 2,5 E/D/SL/35

	Function	Color ID
Upper tier	Feed-through	gray
Lower tier	Ground conductor	green/yellow

WKFN 2,5 E/N/SL/35

	Function	Color ID
Upper tier	Feed-through	blue
Lower tier	Ground conductor	green/yellow

WKFN 2,5 E...G

- Multi-tier function block with tension spring connection for mounting on TS 35
- Nominal cross section 2.5 mm²

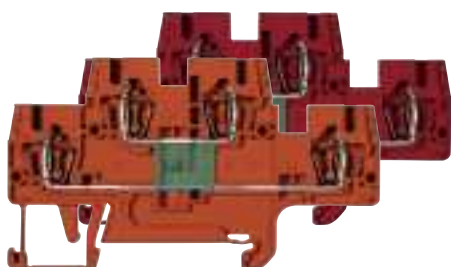

Description	Type	Part No.	Std. Pack
Multi-tier function block, red	WKFN 2,5 E.../35	56.703.XX55.5	100
Multi-tier function block, orange	WKFN 2,5 E.../35	56.703.XX55.9	100

General data				
Width / length / height, incl. TS 7.5	5 mm / 82 mm / 48 mm			
Wire strip length	11 mm			
Approvals				
Technical data		IEC	UL	CSA
	EN 60 947-7-1			
Cross section fine-stranded	0.13–2.5 mm ²			
Cross section solid/stranded	0.13–4 mm ²			
Cross section, AWG		22–12	24–12	

Function diagram for fasis WKFN 2,5 E...

The multi-tier block is available on request as a function block for a wide variety of switching tasks.

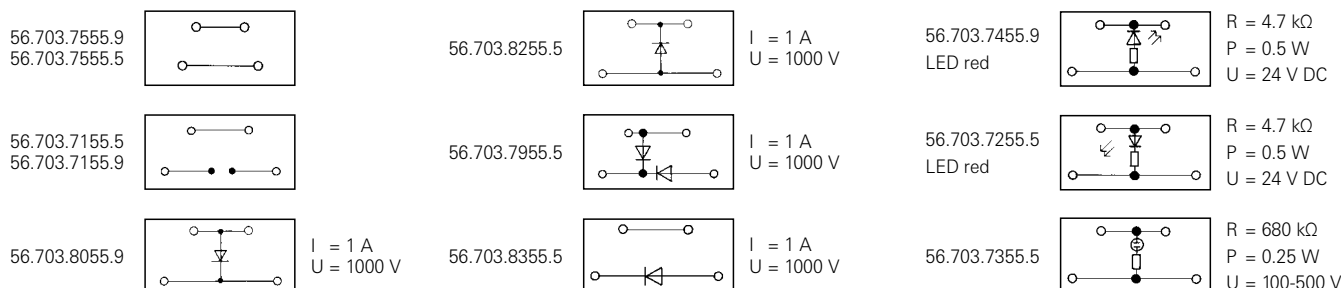

Accessories for fasis WKFN 2,5 E/...



Accessories	Type	Part No.	Std. Pack
End plate	gray APFN 2,5 E	07.312.7355.0	10
Partition	gray WFN 2,5 E	07.312.7455.0	10
Cross connector, insulated	2 pole IVB WKF 2,5–2	Z7.280.6227.0	10
	3 pole IVB WKF 2,5–3	Z7.280.6327.0	10
	4 pole IVB WKF 2,5–4	Z7.280.6427.0	10
	5 pole IVB WKF 2,5–5	Z7.280.6527.0	10
	10 pole IVB WKF 2,5–10	Z7.280.7027.0	20
	20 pole IVB WKF 2,5–20	Z7.280.8027.0	20
Vertical cross connector	1 pole IVB WKF-V	Z7.261.1127.0	10
Wire entry guide	0.13–0.2 mm ² LELN 2,5/1 WEISS	05.564.3755.0	100
	0.25–0.5 mm ² LELN 2,5/2 GRAU	05.564.3855.0	100
	0.75–1.0 mm ² LELN 2,5/3 SCHWARZ	05.564.3955.0	100
Cover with warning symbol over 4 blocks	yellow ADFN 2,5/4 GELB	04.343.8353.8	10
Marking tag carrier, 2-fold	BT 5/2	04.243.0855.0	100





Duo multi-tier terminal blocks with tension spring connection

WKFN 2,5 E1/2/35

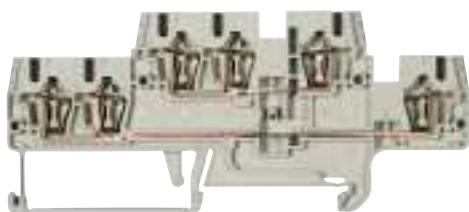
WKFN 2,5 E1/2/N/D/35

- Duo multi-tier block with tension spring connection for mounting on TS 35
- Nominal cross section 2.5 mm²
- Ex e I/II  II 2GD IM2
Follow the EX installation instructions on page 143





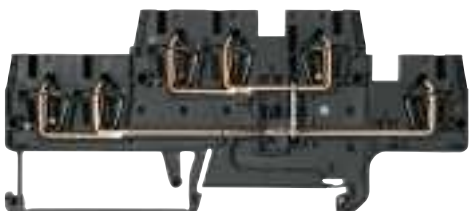

Description	Type	Part No.	Std. Pack
Multi-tier block, gray	WKFN 2,5 E1/2/35	56.703.6055.0	50
Multi-tier block, combined, gray	WKFN 2,5 E1/2/N/D/35	56.703.6355.0	50
General data			
Width / length / height, incl. TS 7.5	5 mm / 107 mm / 48 mm		
Wire strip length	11 mm		
Approvals	PTB     PTB 04 ATEX 1051 U		
Technical data	IEC	UL	CSA
	EN 60 947-7-1		EN 60 079-0/-7
Cross section fine-stranded	0.13–2.5 mm ²		0.2–2.5 mm ²
Cross section solid/stranded	0.13–4 mm ²		0.13–4 mm ²
Cross section, AWG		22–12	24–12
Rated current	22 A	20 A	24 A
Rated voltage	500 V	300 V	300 V
Rated impulse voltage	6 kV		440/275 V ¹⁾
Pollution degree	3		
Note	¹⁾ 1. value at 40 K / 2. value at 45 K ²⁾ When using cross connectors on the upper tier		

WKFN 2,5 E1/2/VB/35

- Duo multi-tier block, vertically connected, with tension spring connection for mounting on TS 35
- Nominal cross section 2.5 mm²
- Ex e I/II  II 2GD IM2
Follow the EX installation instructions on page 143





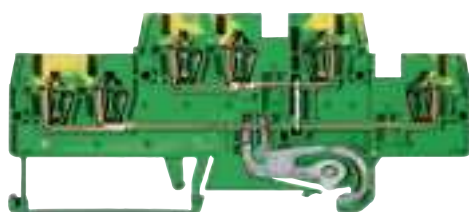

Description	Type	Part No.	Std. Pack
Multi-tier block, black	WKFN 2,5 E1/2/VB/35	56.703.5955.1	50
General data			
Width / length / height, incl. TS 7.5	5 mm / 107 mm / 48 mm		
Wire strip length	11 mm		
Approvals	PTB     PTB 04 ATEX 1051 U		
Technical data	IEC	UL	CSA
	EN 60 947-7-1		EN 60 079-0/-7
Cross section fine-stranded	0.13–2.5 mm ²		0.2–2.5 mm ²
Cross section solid/stranded	0.13–4 mm ²		0.13–4 mm ²
Cross section, AWG		22–12	24–12
Rated current	22 A	20 A	24 A
Rated voltage	500 V	300 V	300 V
Rated impulse voltage	6 kV		440 V
Pollution degree	3		
Note	¹⁾ 1. value at 40 K / 2. value at 45 K		
Accessories	Type	Part No.	Std. Pack
Partition, gray	TWFN 2,5 E1/2	07.312.7855.0	10

WKFN 2,5 E1/2/SL/35

- Duo multi-tier ground block with tension spring connection for mounting on TS 35
- Nominal cross section 2.5 mm²
- Ex e I/II  II 2GD IM2
Follow the EX installation instructions on page 143





Description	Type	Part No.	Std. Pack
Ground block, green/yellow	WKFN 2,5 E1/2/SL/35	56.703.6255.0	50
General data			
Width / length / height, incl. TS 7.5	5 mm / 107 mm / 48 mm		
Wire strip length	11 mm		
Approvals	PTB     PTB 04 ATEX 1051 U		
Technical data	IEC	UL	CSA
	EN 60 947-7-2		EN 60 079-0/-7
Cross section fine-stranded	0.13–2.5 mm ²		0.2–2.5 mm ²
Cross section solid/stranded	0.13–4 mm ²		0.13–4 mm ²
Cross section, AWG		22–12	24–12
Rated current			
Rated voltage	500 V	600 V	600 V
Rated impulse voltage	6 kV		
Pollution degree	3		

WKFN 2,5 E1/2/D/SL/35
WKFN 2,5 E1/2/N/SL/35

- Duo multi-tier block, combined, with tension spring connection for mounting on TS 35
- Nominal cross section 2.5 mm²
- Ex e I/II  II 2GD IM2
 Follow the EX installation instructions on page 143



Description	Type	Part No.	Std. Pack
Multi-tier block, combined, gray	WKFN 2,5 E1/2/D/SL/35	56.703.6155.0	50
Multi-tier block, combined, gray	WKFN 2,5 E1/2/N/SL/35	56.703.6455.0	50
General data			
Width / length / height, incl. TS 7.5	5 mm / 107 mm / 48 mm		
Wire strip length	11 mm		
Approvals	  PTB 04 ATEX 1051 U		
Technical data	IEC	UL	CSA
	EN 60 947-7-1		EN 60 079-0/-7
Cross section fine-stranded	0.13–2.5 mm ²		
Cross section solid/stranded	0.13–4 mm ²		
Cross section, AWG		22–12	24–12
Rated current	22 A	20 A	24 A
Rated voltage	500 V	300 V	300 V
Rated impulse voltage	6 kV		
Pollution degree	3		

WKFN 2,5 E1/2/35 Block color: gray

	Function	Color ID
Upper tier	Feed-through	gray
Lower tier	Feed-through	gray

WKFN 2,5 E1/2/D/SL/35 Block color: gray

	Function	Color ID
Upper tier	Feed-through	gray
Lower tier	Ground conductor	green/yellow

WKFN 2,5 E1/2/N/D/35 Block color: gray

	Function	Color ID
Upper tier	Feed-through	blue
Lower tier	Feed-through	gray

WKFN 2,5 E1/2/N/SL/35 Block color: gray

	Function	Color ID
Upper tier	Feed-through	blue
Lower tier	Ground conductor	green/yellow

WKFN 2,5 E1/2/VB/35 Block color: black

	Function	Color ID
Upper tier	Feed-through	black
Lower tier	vert. jumpered	black

WKFN 2,5 E1/2/SL/35 Block color: green/yellow

	Function	Color ID
Upper tier	Ground conductor	green/yellow
Lower tier	vert. jumpered	green/yellow

Accessories for fasis WKFN 2,5 E1/2/...



Accessories	Type	Part No.	Std. Pack
End plate	gray APFN 2,5 E1/2	07.312.7755.0	10
Partition	gray TWFN 2,5 E1/2	07.312.7855.0	10
Cross connector, insulated	2 pole IVB WKF 2,5–2	Z7.280.6227.0	10
	3 pole IVB WKF 2,5–3	Z7.280.6327.0	10
	4 pole IVB WKF 2,5–4	Z7.280.6427.0	10
	5 pole IVB WKF 2,5–5	Z7.280.6527.0	10
	10 pole IVB WKF 2,5–10	Z7.280.7027.0	20
	20 pole IVB WKF 2,5–20	Z7.280.8027.0	20
Vertical cross connector	1 pole IVB WKF–V	Z7.261.1127.0	10
Wire entry guide	0.13–0.2 mm ² LELN 2,5/1 WEISS	05.564.3755.0	100
	0.25–0.5 mm ² LELN 2,5/2 GRAU	05.564.3855.0	100
	0.75–1.0 mm ² LELN 2,5/3 SCHWARZ	05.564.3955.0	100
Cover with warning symbol over 4 blocks	yellow ADFN 2,5/4 GELB	04.343.8353.8	10
Marking tag carrier, 2-fold	BT 5/2	04.243.0855.0	100
Test adapter, modular	PS WKC/F	Z1.299.9753.0	10
Test plug	ST 2/2,3	Z5.553.2921.0	10
Screwdriver, uninsulated	DIN 5264 B 0,6x3,5	06.502.4000.0	5
Screwdriver, uninsulated, MINI	DIN 5264 B 0,6x3,5 M	06.502.5000.0	10

Multi-tier/Motor connection block with tension spring connection

WKFN 2,5 E3/D/D/SL/35
WKFN 2,5 E3/N/D/SL/35

- Multi-tier block, combined, with tension spring connection for mounting on TS 35
- Nominal cross section 2.5 mm²
- Ex e I/II II 2GD IM2
Follow the EX installation instructions on page 143

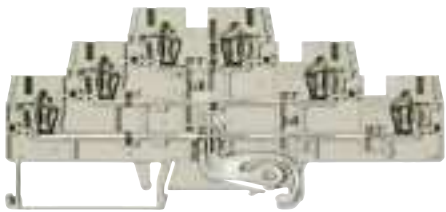

Description	Type	Part No.	Std. Pack
Multi-tier block, gray	WKFN 2,5 E3/D/D/SL/35	56.703.3355.0	50
Multi-tier block, gray	WKFN 2,5 E3/N/D/SL/35	56.703.3255.0	50

General data				
Width / length / height, incl. TS 7.5	5 mm / 123 mm / 59 mm			
Wire strip length	11 mm			
Approvals	PTB		PTB 04 ATEX 1051 U	
Technical data	IEC	UL	CSA	
	EN 60 947-7-1			EN 60 079-0/-7
Cross section fine-stranded	0.13–2.5 mm ²			
Cross section solid/stranded	0.13–4 mm ²			
Cross section, AWG		22–12	24–12	
Rated current	20 A	20 A	24 A	
Rated voltage	500 V	300 V	300 V	
Rated impulse voltage	6 kV			
Pollution degree	3			

WKFN 2,5 E3/N/D/SL/35 Block color: gray

	Function	Color ID
Upper tier	Feed-through	blue
Center tier	Feed-through	gray
Lower tier	Ground conductor	green/yellow

WKFN 2,5 E3/D/D/SL/35 Block color: gray

	Function	Color ID
Upper tier	Feed-through	gray
Center tier	Feed-through	gray
Lower tier	Ground conductor	green/yellow

WKF 4 3D/SL

- Motor connection block with tension spring connection for mounting on TS 35
- Nominal cross section 4 mm²



Description	Type	Part No.	Std. Pack
Motor connection block, gray	WKF 4 3D/SL	56.704.8453.0	50

General data			
Width / length / height, incl. TS 7.5	6 mm / 100 mm / 84 mm		
Wire strip length	10 mm		
Approvals			
Technical data	IEC	UL	CSA
	EN 60947-7-1/DIN VDE 0611 T1		
Cross section fine-stranded	0.13 – 4 mm ²		
Cross section solid/stranded	0.13 – 4 mm ²		
Cross section, AWG		28–10	
Rated current	28 A	30 A	
Rated voltage	800 V	600 V	
Rated impulse voltage	8 kV		
Pollution degree	3		

Accessories for fasis WKFN 2,5 E3/...

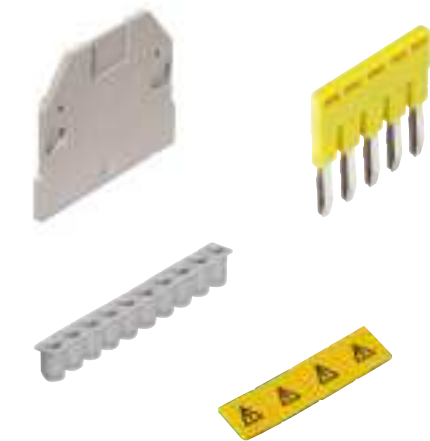

Accessories	Type	Part No.	Std. Pack
End plate	gray APFN 2,5 E3	07.312.7555.0	10
Partition	gray TWFN 2,5 E3	07.312.7655.0	10
Cross connector, insulated	2 pole	IVB WKF 2,5–2	Z7.280.6227.0
	3 pole	IVB WKF 2,5–3	Z7.280.6327.0
	4 pole	IVB WKF 2,5–4	Z7.280.6427.0
	5 pole	IVB WKF 2,5–5	Z7.280.6527.0
	10 pole	IVB WKF 2,5–10	Z7.280.7027.0
	20 pole	IVB WKF 2,5–20	Z7.280.8027.0
Vertical cross connector	1 pole	IVB WKF–V	Z7.261.1127.0
Wire entry guide	0.13–0.2 mm ²	LELN 2,5/1 WEISS	05.564.3755.0
	0.25–0.5 mm ²	LELN 2,5/2 GRAU	05.564.3855.0
	0.75–1.0 mm ²	LELN 2,5/3 SCHWARZ	05.564.3955.0
Cover with warning symbol over 4 blocks	yellow	ADFN 2,5/4 GELB	04.343.8353.8
Marking tag carrier, 2-fold		BT 5/2	04.243.0855.0

Multi-tier terminal blocks with tension spring connection



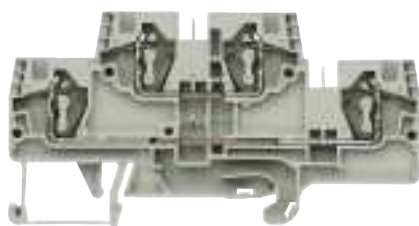

WKFN 4 E/35

WKFN 4 E/N/D/35

- Multi-tier block with tension spring connection for mounting on TS 35
- Nominal cross section 4 mm²
- Ex e I/II  II 2GD IM2
Follow the EX installation instructions on page 143



Description	Type	Part No.	Std. Pack
Multi-tier block, gray	WKFN 4 E/35	56.704.7055.0	100
Multi-tier block, combined, gray	WKFN 4 E/N/D/35	56.704.7655.0	100

General data				
Width / length / height, incl. TS 7.5	6 mm / 90 mm / 48 mm			
Wire strip length	11 mm			
Approvals	PTB    PTB 05 ATEX 1104 U			
Technical data	IEC	UL	CSA	
	EN 60 947-7-1			EN 60 079-0/-7
Cross section fine-stranded	0.13–4 mm ²			0.13–4 mm ²
Cross section solid/stranded	0.13–6 mm ²			0.2–6 mm ²
Cross section, AWG		24–10	24–10	
Rated current	32 A	30 A	32 A	27/29 A ¹⁾²⁾
Rated voltage	500 V	300 V	300 V	440/352 V ³⁾
Rated impulse voltage	6 kV			
Pollution degree	3			
Note	¹⁾ 1. value at 40 K / 2. value at 45 K ²⁾ When cross connectors are used acc. to EN 60079-0 and EN60079-7 the current must be reduced to 2 A at 45 K. ³⁾ When using cross connectors on the upper tier			

WKFN 4 E/N/D/35 Block color: gray





	Function	Color ID
Upper tier	Feed-through	blue
Lower tier	Feed-through	gray

WKFN 4 E/VB/35

- Multi-tier block, vertically connected, with tension spring connection for mounting on TS 35
- Nominal cross section 4 mm²
- Ex e I/II  II 2GD IM2
Follow the EX installation instructions on page 143



Description	Type	Part No.	Std. Pack
Multi-tier block, black	WKFN 4 E/VB/35	56.704.6955.1	100



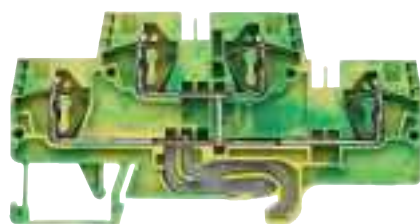

General data				
Width / length / height, incl. TS 7.5	6 mm / 90 mm / 48 mm			
Wire strip length	11 mm			
Approvals	PTB    PTB 05 ATEX 1104 U			
Technical data	IEC	UL	CSA	
	EN 60 947-7-1			EN 60 079-0/-7
Cross section fine-stranded	0.13–4 mm ²			0.13–4 mm ²
Cross section solid/stranded	0.13–6 mm ²			0.2–6 mm ²
Cross section, AWG		24–10	24–10	
Rated current	32 A	30 A	32 A	30/31 A ¹⁾
Rated voltage	500 V	600 V	300 V	440 V
Rated impulse voltage	6 kV			
Pollution degree	3			
Note	¹⁾ 1. value at 40 K / 2. value at 45 K			

WKFN 4 E/SL/35

- Multi-tier ground block with tension spring connection for mounting on TS 35
- Nominal cross section 4 mm²
- Ex e I/II  II 2GD IM2
Follow the EX installation instructions on page 143



Description	Type	Part No.	Std. Pack
Multi-tier ground block, green/yellow	WKFN 4 E SL/35	56.704.9255.0	100

General data				
Width / length / height, incl. TS 7.5	6 mm / 90 mm / 48 mm			
Wire strip length	11 mm			
Approvals	PTB    PTB 05 ATEX 1104 U			
Technical data	IEC	UL	CSA	
	EN 60 947-7-2			EN 60 079-0/-7
Cross section fine-stranded	0.13–4 mm ²			0.13–4 mm ²
Cross section solid/stranded	0.13–6 mm ²			0.2–6 mm ²
Cross section, AWG		24–10	24–10	
Rated current				
Rated voltage	500 V	600 V	600 V	
Rated impulse voltage	6 kV			
Pollution degree	3			

Multi-tier terminal blocks with tension spring connection

WKFN 4 E/D/SL/35

WKFN 4 E/N/SL/35

- Multi-tier block, combined, with tension spring connection for mounting on TS 35
- Nominal cross section 4 mm²
- Ex e I/II II 2GD IM2

Follow the EX installation instructions on page 143

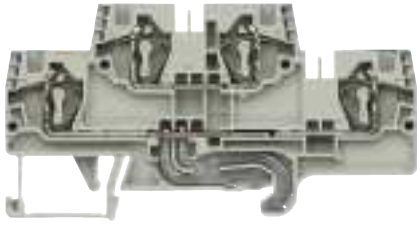

Description	Type	Part No.	Std. Pack
Multi-tier block, combined, gray	WKFN 4 E/D/SL/35	56.704.7855.0	100
Multi-tier block, combined, gray	WKFN 4 E/N/SL/35	56.704.7755.0	100

General data				
Width / length / height, incl. TS 7.5	6 mm / 90 mm / 48 mm			
Wire strip length	11 mm			
Approvals	PTB PTB 05 ATEX 1104 U			
Technical data				
	IEC	UL	CSA	
	EN 60 947-7-1			EN 60 079-0/-7
Cross section fine-stranded	0.13–4 mm ²			
Cross section solid/stranded	0.13–6 mm ²			
Cross section, AWG		24–10	24–10	
Rated current	32 A	30 A	32 A	
Rated voltage	500 V	300 V	300 V	
Rated impulse voltage	6 kV			
Pollution degree	3			

WKFN 4 E/D/SL/35

Block color: gray

	Function	Color ID
Upper tier	Feed-through	gray
Lower tier	Ground conductor	green/yellow

WKFN 4 E/N/SL/35

Block color: gray

	Function	Color ID
Upper tier	Feed-through	blue
Lower tier	Ground conductor	green/yellow

WKFN 4 E /35...

- Multi-tier function block with tension spring connection for mounting on TS 35
- Nominal cross section 4 mm²

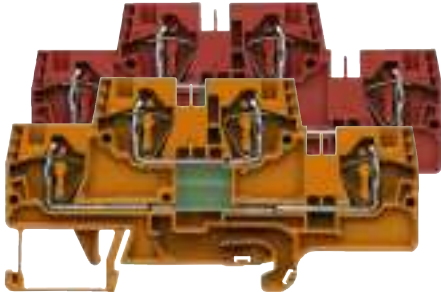

Description	Type	Part No.	Std. Pack
Multi-tier function block, red	WKFN 4 E /35...	56.704.XX55.5	100
Multi-tier function block, orange	WKFN 4 E /35...	56.704.XX55.9	100

General data				
Width / length / height, incl. TS 7.5	6 mm / 90 mm / 48 mm			
Wire strip length	11 mm			
Approvals				
Technical data				
	IEC	UL	CSA	
	EN 60947-7-1			
Cross section fine-stranded	0.13 – 4 mm ²			
Cross section solid/stranded	0.13 – 6 mm ²			
Cross section, AWG		24–10	24–10	

Function diagram for *fasis* WKFN 4 E/...

The multi-tier block is available on request as a function block for a wide variety of switching tasks.

56.704.7555.9
56.704.7555.5

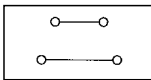

56.704.8255.5

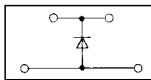

I = 1 A
U = 1000 V

56.704.7455.9

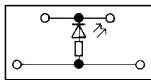

R = 4.7 kΩ
P = 0.5 W
U = 24 V DC

56.704.7155.5
56.704.7155.9

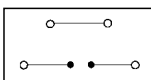

56.704.7955.5

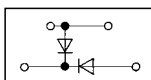

I = 1 A
U = 1000 V

56.704.7255.5

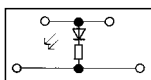

R = 4.7 kΩ
P = 0.5 W
U = 24 V DC

56.704.8055.9

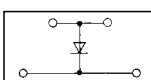

I = 1 A
U = 1000 V

56.704.8355.5

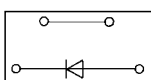

I = 1 A
U = 1000 V

56.704.7355.5

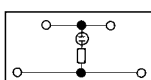



R = 680 kΩ
P = 0.25 W
U = 100-500 V

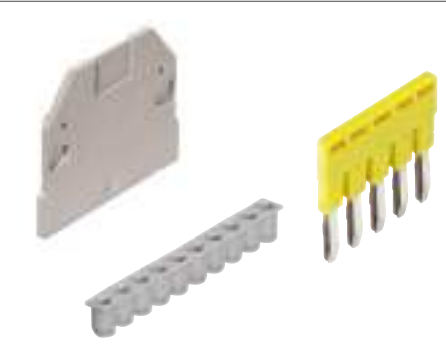

Accessories for *fasis* WKFN 4 E/...



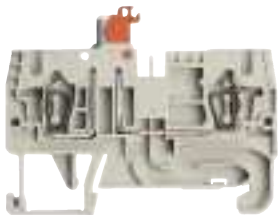

Accessories	Type	Part No.	Std. Pack
End plate	gray APFN 4 E...	07.312.9655.0	10
Partition	gray TWFN 4 E...	07.312.9755.0	10
Cross connector, insulated	2 pole IVB WKF 4–2	Z7.261.1227.0	10
	3 pole IVB WKF 4–3	Z7.261.1327.0	10
	4 pole IVB WKF 4–4	Z7.261.1427.0	10
	5 pole IVB WKF 4–5	Z7.261.1527.0	10
	6 pole IVB WKF 4–6	Z7.261.1627.0	10
	7 pole IVB WKF 4–7	Z7.261.1727.0	20
	8 pole IVB WKF 4–8	Z7.261.1827.0	20
	9 pole IVB WKF 4–9	Z7.261.1927.0	20
	10 pole IVB WKF 4–10	Z7.261.2027.0	20
Vertical cross connector, insulated	1 pole IVB WKF-V	Z7.261.1127.0	10
Wire entry guide	0.13–0.2 mm ² LEL 4/1 WEISS	05.561.8553.0	100
	0.25–0.5 mm ² LEL 4/2 GRAU	05.561.8653.0	100
	0.75–1.0 mm ² LEL 4/3 SCHWARZ	05.561.8753.0	100

Disconnect terminal blocks with tension spring connection

<p>WKFN 2,5 TKM/35</p> <ul style="list-style-type: none"> • Disconnect terminal block with tension spring connection for mounting on TS 35 • Nominal cross section 2.5 mm² 	Description	Type	Part No.	Std. Pack	
	Disconnect terminal block, gray	WKFN 2,5 TKM/35	56.703.5355.0	100	
	General data				
	Width / length / height, incl. TS 7.5	5 mm / 60 mm / 38 mm			
	Wire strip length	11 mm			
	Approvals				
	Technical data		IEC	UL	CSA
		EN 60947-7-1			
	Cross section fine-stranded	0.14 – 2.5 mm ²			
	Cross section solid/stranded	0.2 – 4 mm ²			
	Cross section, AWG		24–12	24–12	
	Rated current	20 A	19 A	20 A	
	Rated voltage	630 V	300 V	300 V	
	Rated impulse voltage	6 kV			
	Pollution degree	3			
Accessories		Type	Part No.	Std. Pack	
End plate, gray	APFN 2,5 D1/2	07.312.6955.0	10		
Partition, gray	TWFN 2,5 D1/2	07.312.7055.0	10		

<p>WKFN 2,5 TKM 1/2/35</p> <ul style="list-style-type: none"> • Duo disconnect terminal block with tension spring connection for mounting on TS 35 • Nominal cross section 2.5 mm² 	Description	Type	Part No.	Std. Pack	
	Disconnect terminal block, gray	WKFN 2,5 TKM 1/2/35	56.703.5455.0	100	
	General data				
	Width / length / height, incl. TS 7.5	5 mm / 72 mm / 38 mm			
	Wire strip length	11 mm			
	Approvals				
	Technical data		IEC	UL	CSA
		EN 60947-7-1			
	Cross section fine-stranded	0.14 – 2.5 mm ²			
	Cross section solid/stranded	0.2 – 4 mm ²			
	Cross section, AWG		24–12	24–12	
	Rated current	20 A	19 A	20 A	
	Rated voltage	630 V	300 V	300 V	
	Rated impulse voltage	6 kV			
	Pollution degree	3			
Accessories		Type	Part No.	Std. Pack	
End plate, gray	APFN 2,5 D2/2	07.312.7155.0	10		
Partition, gray	TWFN 2,5 D2/2	07.312.7255.0	10		

<p>WKFN 2,5 TKM 2/2/35</p> <ul style="list-style-type: none"> • Duo disconnect terminal block with tension spring connection for mounting on TS 35 • Nominal cross section 2.5 mm² 	Description	Type	Part No.	Std. Pack	
	Disconnect terminal block, gray	WKFN 2,5 TKM 2/2/35	56.703.5555.0	50	
	General data				
	Width / length / height, incl. TS 7.5	5 mm / 85 mm / 38 mm			
	Wire strip length	11 mm			
	Approvals				
	Technical data		IEC	UL	CSA
		EN 60947-7-1			
	Cross section fine-stranded	0.14 – 2.5 mm ²			
	Cross section solid/stranded	0.2 – 4 mm ²			
	Cross section, AWG		24–12	24–12	
	Rated current	20 A	19 A	20 A	
	Rated voltage	630 V	300 V	300 V	
	Rated impulse voltage	6 kV			
	Pollution degree	3			
Accessories		Type	Part No.	Std. Pack	
End plate, gray	APFN 2,5 TKM D2/2	07.313.0055.0	10		
Partition, gray	TWFN 2,5 TKM D2/2	07.313.0155.0	10		

Multi-tier disconnect terminal block with tension spring connection

Description		Type	Part No.	Std. Pack
Disconnect terminal block, gray		WKFN 2,5 TKM E1/35	56.703.6555.0	50
General data				
Width / length / height, incl. TS 7.5		5 mm / 107 mm / 48 mm		
Wire strip length		11 mm		
Approvals				
Technical data		IEC	UL	CSA
		EN 60947-7-1		
Cross section fine-stranded		0.14 – 2.5 mm ²		
Cross section solid/stranded		0.2 – 4 mm ²		
Cross section, AWG		24 – 12		
Rated current		20 A	19 A	20 A
Rated voltage		500 V	300 V	300 V
Rated impulse voltage		6 kV		
Pollution degree		3		
Accessories				
End plate, gray		APFN 2,5 E1/2	07.312.7755.0	10
Partition, gray		TWFN 2,5 E1/2	07.312.7855.0	10

WKFN 2,5 TKM E1/35

- Multi-tier disconnect terminal block with tension spring connection for mounting on TS 35
- Nominal cross section 2.5 mm²

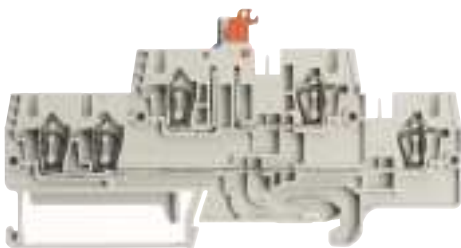

Description		Type	Part No.	Std. Pack
Disconnect terminal block, gray		WKFN 2,5 TKM E2/35	56.703.6555.0	50
General data				
Width / length / height, incl. TS 7.5		5 mm / 107 mm / 48 mm		
Wire strip length		11 mm		
Approvals				
Technical data		IEC	UL	CSA
		EN 60947-7-1		
Cross section fine-stranded		0.14 – 2.5 mm ²		
Cross section solid/stranded		0.2 – 4 mm ²		
Cross section, AWG		24 – 12		
Rated current		19 A	19 A	19 A
Rated voltage		500 V	300 V	300 V
Rated impulse voltage		6 kV		
Pollution degree		3		
Accessories				
End plate, gray		APFN 2,5 E1/2	07.312.7755.0	10
Partition, gray		TWFN 2,5 E1/2	07.312.7855.0	10

WKFN 2,5 TKM E2/35

- Multi-tier disconnect terminal block with tension spring connection for mounting on TS 35
- Nominal cross section 2.5 mm²

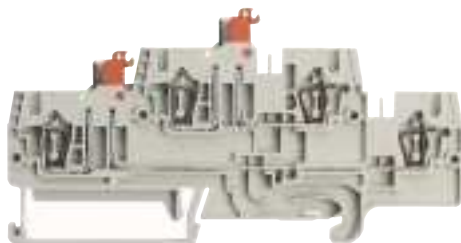

Accessories for *fasis* WKFN 2,5 TKM...

Accessories		Type	Part No.	Std. Pack
Cross connector, insulated	2 pole	IVB WKF 2,5–2	Z7.280.6227.0	10
	3 pole	IVB WKF 2,5–3	Z7.280.6327.0	10
	4 pole	IVB WKF 2,5–4	Z7.280.6427.0	10
	5 pole	IVB WKF 2,5–5	Z7.280.6527.0	10
	6 pole	IVB WKF 2,5–6	Z7.280.6627.0	10
	7 pole	IVB WKF 2,5–7	Z7.280.6727.0	20
	8 pole	IVB WKF 2,5–8	Z7.280.6827.0	20
	9 pole	IVB WKF 2,5–9	Z7.280.6927.0	20
	10 pole	IVB WKF 2,5–10	Z7.280.7027.0	20
	20 pole	IVB WKF 2,5–20	Z7.280.8027.0	20
Wire entry guide	0.13–0.2 mm ²	LELN 2,5/1 WEISS	05.564.3755.0	100
	0.25–0.5 mm ²	LELN 2,5/2 GRAU	05.564.3855.0	100
	0.75–1.0 mm ²	LELN 2,5/3 SCHWARZ	05.564.3955.0	100
Cover with warning symbol over 4 blocks	yellow	ADFN 2,5/4 GELB	04.343.8353.8	10
Test adapter, modular		PS WKC/F	Z1.299.9753.0	10
Test plug		ST 2/2,3	Z5.553.2921.0	10
Screwdriver, uninsulated		DIN 5264 B 0,6x3,5	06.502.4000.0	5
Screwdriver, uninsulated, MINI		DIN 5264 B 0,6x3,5 M	06.502.5000.0	10



Fuse blocks with tension spring connection

WKFN 4 TKG with THSi 5 x 20

- Disconnect ground block with tension spring connection for mounting on TS 35
- Nominal cross section 4 mm²



Description	Type	Part No.	Std. Pack
Disconnect ground block, gray	WKFN 4 TKG/35	56.704.4055.0	100
Fuse disconnect lever	THSi 5x20	Z1.298.1053.0	10
Fuse disconnect lever with LED 12–24 V ²⁾	THSi 5x20 LED24	Z1.298.1153.0	10
Fuse disconnect lever with LED 24–60 V ²⁾	THSi 5x20 LED60	Z1.298.1253.0	10
Fuse disconnect lever with GL 110–250 V ²⁾	THSi 5x20 GL250	Z1.298.1353.0	10

General data				
Width / length / height, incl. TS 7.5	6 mm / 82 mm / 38 mm			
Wire strip length	11 mm			
Approvals	KEMA 01 ATEX 2087 U			
Technical data				
	IEC	UL	CSA	
	EN 60 947-7-3			EN 60 079-0/-7
Cross section fine-stranded	0.13–4 mm ²			
Cross section solid/stranded	0.13–6 mm ²			
Cross section, AWG	24–10		22–10	
Rated current	1)	1)	10 A ¹⁾	
Rated voltage	500 V ²⁾	600 V ²⁾	300 V ²⁾	
Rated impulse voltage	8 kV			
Pollution degree	3			
Accessories				
	Type	Part No.	Std. Pack	
End plate, gray	APFN 4 D2/2	07.312.9055.0	10	
Partition, gray	TWFN 4 D2/2	07.312.9155.0	10	

WKFN 4 TKG with THSi 6,3 x 32

- Disconnect ground block with tension spring connection for mounting on TS 35
- Nominal cross section 4 mm²



Description	Type	Part No.	Std. Pack
Disconnect ground block, gray	WKFN 4 TKG/35	56.704.4055.0	100
Fuse disconnect lever	THSi 6,3x32	Z1.298.1653.0	10
Fuse disconnect lever with LED 12–24 V ²⁾	THSi 6,3x32 LED24	Z1.298.1753.0	10
Fuse disconnect lever with LED 24–60 V ²⁾	THSi 6,3x32 LED60	Z1.298.1853.0	10
Fuse disconnect lever with GL 110–250 V ²⁾	THSi 6,3x32 GL250	Z1.298.1953.0	10
Fuse disconnect lever with GL 500 V ²⁾	THSi 6,3x32 GL500	Z1.298.2053.0	10

General data				
Width / length / height, incl. TS 7.5	6 mm / 82 mm / 38 mm			
Wire strip length	11 mm			
Approvals	KEMA 01 ATEX 2087 U			
Technical data				
	IEC	UL	CSA	
	EN 60 947-7-3			EN 60 079-0/-7
Cross section fine-stranded	0.13–4 mm ²			
Cross section solid/stranded	0.13–6 mm ²			
Cross section, AWG	24–10		22–10	
Rated current	1)	1)	10 A ¹⁾	
Rated voltage	500 V ²⁾	600 V ²⁾	300 V ²⁾	
Rated impulse voltage	8 kV			
Pollution degree	3			
Accessories				
	Type	Part No.	Std. Pack	
End plate, gray	APFN 4 D2/2	07.312.9055.0	10	
Intermediate plate, 4 mm, blue	ZP/WKFN 4 TKG	07.313.1655.0	10	
Partition, gray	TWFN 4 D2/2	07.312.9155.0	10	

Info and accessories for fasis WKFN 4 TKG with THSi...

¹⁾ The current is determined by the inserted fuse.

²⁾ The voltage range is determined by the built-in LED display. Depending on the application and the installation method, the circumstances for increased temperature must be checked in the closed fuse holders.

Higher ambient temperatures are an additional load for the fuse inserts. Therefore, the reduction of the rated current must be considered accordingly in these applications.

Indicator (24 V): LED, red
current consumption: 10.3 mA

Indicator (220 V): LED, red
current consumption: 0.3 mA

When selecting G fuse inserts, make sure that the specified maximum power is not exceeded. Maximum power loss at 23°C ambient temperature (according to DIN EN 60947-7-3)

Type	Rated voltage	Overload protection		Exclusive short-circuit protection	
		Single arrangement	Group arrangement	Single arrangement	Group arrangement
THSi 5x20	250 V	1.6 W	1.6 W	4.0 W	2.5 W
THSi 6,3x32	500 V	2.5 W	1.6 W	4.0 W	2.5 W

Accessories					
	Type	Part No.	Std. Pack		
Cross connector, insulated	2 pole IVB WKF 4-2	Z7.261.1227.0	10		
for WKFN 4 TKG with THSi 5x20	3 pole IVB WKF 4-3	Z7.261.1327.0	10		
	4 pole IVB WKF 4-4	Z7.261.1427.0	10		
	5 pole IVB WKF 4-5	Z7.261.1527.0	10		
	6 pole IVB WKF 4-6	Z7.261.1627.0	10		
	7 pole IVB WKF 4-7	Z7.261.1727.0	20		
	8 pole IVB WKF 4-8	Z7.261.1827.0	20		
	9 pole IVB WKF 4-9	Z7.261.1927.0	20		
	10 pole IVB WKF 4-10	Z7.261.2027.0	20		
	Wire entry guide	0.13–0.2 mm ²	LEL 4/1 WEISS	05.561.8553.0 100	
		0.25–0.5 mm ²	LEL 4/2 GRAU	05.561.8653.0 100	
0.75–1.0 mm ²		LEL 4/3 SCHWARZ	05.561.8753.0 100		
Cover with warning symbol over 4 blocks	yellow ADF 4/4 GELB	04.343.6153.8	10		
Test adapter, modular	ST 2/2,3	Z5.553.2921.0	10		
Screwdriver, uninsulated	DIN 5264 B 0,6x3,5	06.502.4000.0	5		
Screwdriver, uninsulated, MINI	DIN 5264 B 0,6x3,5 M	06.502.5000.0	10		

For WKFN 4 TKG with THSi 6.3x32 and intermediate plate cross connector IVB WKF 2,5-x must be used.

WKFN 4 TKG with SiST

- Disconnect ground block with tension spring connection for mounting on TS 35
- Nominal cross section 4 mm²



Description	Type	Part No.	Std. Pack
Disconnect ground block, gray	WKFN 4 TKG/35	56.704.4055.0	100
Fuse holder for fuse 5 x 20	Si ST	Z1.299.4055.0	10
Fuse holder with indicator (24V) ²⁾	Si ST LED	Z1.299.4155.0	10
Fuse holder with indicator (220V) ²⁾	Si ST GL	Z1.299.4255.0	10

General data				
Width / length / height, incl. TS 7.5	6 mm / 82 mm / 38 mm			
Wire strip length	11 mm			
Approvals	KEMA 01 ATEX 2087 U			
Technical data	IEC	UL	CSA	EN 60 079-0/-7
	EN 60 947-7-3			
Cross section fine-stranded	0.13–4 mm ²			
Cross section solid/stranded	0.13–6 mm ²			
Cross section, AWG				
Rated current	1) ¹⁾	24–10	22–10	
Rated voltage	500 V ²⁾	600 V ²⁾	300 V ²⁾	
Rated impulse voltage	8 kV			
Pollution degree	3			

Accessories	Type	Part No.	Std. Pack
End plate, gray	APFN 4 D2/2	07.312.9055.0	10
Partition, gray	TWFN 4 D2/2	07.312.9155.0	10

WKFN 4 TKG with DiST

- Disconnect ground block with tension spring connection for mounting on TS 35
- Nominal cross section 4 mm²

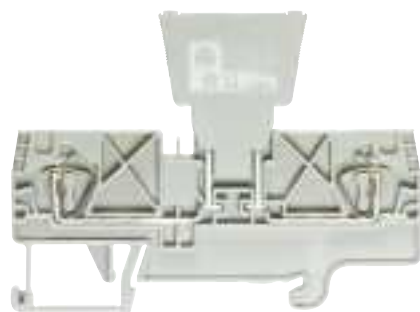

Description	Type	Part No.	Std. Pack
Disconnect ground block, gray	WKFN 4 TKG/35	56.704.4055.0	100
Diode plug–empty	J _{max} = 10 A ¹⁾ DIST ...	Z1.299.3055.0	10
Diode plug–diode	J _{max} = 1 A ¹⁾ DIST-1 N 4007-1 ³⁾	Z1.299.3155.0	10
Diode plug–diode	J _{max} = 1 A ¹⁾ DIST-1 N 4007-2 ⁴⁾	Z1.299.3355.0	10
Diode plug with jumper	J _{max} = 10 A ¹⁾ DIST-D	Z1.299.3255.0	10

General data				
Width / length / height, incl. TS 7.5	6 mm / 82 mm / 38 mm			
Wire strip length	11 mm			
Approvals	KEMA 01 ATEX 2087 U			
Technical data	IEC	UL	CSA	EN 60 079-0/-7
	EN 60 947-7-3			
Cross section fine-stranded	0.13–4 mm ²			
Cross section solid/stranded	0.13–6 mm ²			
Cross section, AWG				
Rated current	1) ¹⁾	24–10	22–10	
Rated voltage	500 V ²⁾	600 V ²⁾	300 V ²⁾	
Rated impulse voltage	8 kV			
Pollution degree	3			

Accessories	Type	Part No.	Std. Pack
End plate, gray	APFN 4 D2/2	07.312.9055.0	10
Partition, gray	TWFN 4 D2/2	07.312.9155.0	10

Info and Accessories for fasis WKFN 4 TKG with SiST and DiST

¹⁾ The current is determined by the inserted fuse.
²⁾ The voltage range is determined by the built-in LED display. Depending on the application and the installation method, the circumstances for increased temperature must be checked in the closed fuse holders.
 Higher ambient temperatures are an additional load for the fuse inserts. Therefore, the reduction of the rated current must be considered accordingly in these applications.
 Indicator (24 V): LED, red
 current consumption: 10.3 mA
 Indicator (220 V): LED, red
 current consumption: 0.3 mA
^{3)/4)} Periodic peak voltage 1000 V
 Direction of the diode: Anode Cathode³⁾
 Cathode Anode⁴⁾

Accessories	Type	Part No.	Std. Pack	
Cross connector, insulated	2 pole	IVB WKF 4-2	Z7.261.1227.0	10
	3 pole	IVB WKF 4-3	Z7.261.1327.0	10
	4 pole	IVB WKF 4-4	Z7.261.1427.0	10
	5 pole	IVB WKF 4-5	Z7.261.1527.0	10
	6 pole	IVB WKF 4-6	Z7.261.1627.0	10
	7 pole	IVB WKF 4-7	Z7.261.1727.0	20
	8 pole	IVB WKF 4-8	Z7.261.1827.0	20
	9 pole	IVB WKF 4-9	Z7.261.1927.0	20
	10 pole	IVB WKF 4-10	Z7.261.2027.0	20
	Wire entry guide	0.13–0.2 mm ²	LEL 4/1 WEISS	05.561.8553.0
0.25–0.5 mm ²		LEL 4/2 GRAU	05.561.8653.0	100
0.75–1.0 mm ²		LEL 4/3 SCHWARZ	05.561.8753.0	100
Cover with warning symbol over 4 blocks	yellow	ADF 4/4 GELB	04.343.6153.8	10
Test adapter, modular	ST 2/2,3	Z5.553.2921.0	10	
Screwdriver, uninsulated	DIN 5264 B 0,6x3,5	06.502.4000.0	5	
Screwdriver, uninsulated, MINI	DIN 5264 B 0,6x3,5 M	06.502.5000.0	10	

Type	Rated voltage	Overload protection		Exclusive short-circuit protection	
		Single arrangement	Group arrangement	Single arrangement	Group arrangement
SiST	250 V	1.6 W	1.6 W	2.5 W	1.6 W

When selecting G fuse inserts, make sure that the specified maximum power is not exceeded.
 Maximum power loss at 23°C ambient temperature (according to DIN EN 60947-7-3)

Fuse blocks with tension spring connection

<p>WKFN 4 FSI</p> <ul style="list-style-type: none"> • Fuse block for automobile fuses for mounting on TS 35 • Nominal cross section 4 mm² 	Description		Type	Part No.	Std. Pack	
	Fuse block, gray		WKFN 4 FSI	56.704.4155.0	100	
	General data					
	Width / length / height, incl. TS 7.5		6 mm / 82 mm / 39 mm			
	Wire strip length		12 mm			
	Approvals					
	Technical data		IEC	UL	CSA	
			EN 60947-7-3			
	Cross section fine-stranded		0.13 – 4 mm ²			
	Cross section solid/stranded		0.13 – 6 mm ²			
Cross section, AWG						
Rated current		*				
Rated voltage		800 V				
Rated impulse voltage		8 kV				
Pollution degree		3				
Note		* Observe the derating curve, available in our e-catalog at https://eshop.wieland-electric.com				
Accessories		Type	Part No.	Std. Pack		
End plate, gray		APFN 4 D2/2	07.312.9055.0	10		
Partition, 4 mm for TCP, gray		ZP/WKFN 4 TKG	07.313.1655.0	10		
Partition, gray		TWFN 4 D2/2	07.312.9155.0	10		

<p>WKFN 4 FSI</p> <ul style="list-style-type: none"> • Fuse block with indicator for mounting on TS 35 • Nominal cross section 4 mm² 	Description		Type	Part No.	Std. Pack	
	Fuse block, gray		WKFN 4 FSI LED12	56.704.4255.0	100	
	Fuse block, gray		WKFN 4 FSI LED24	56.704.5355.0	100	
	General data					
	Width / length / height, incl. TS 7.5		6 mm / 82 mm / 39 mm			
	Wire strip length		12 mm			
	Approvals					
	Technical data		IEC	UL	CSA	
			EN 60947-7-3			
	Cross section fine-stranded		0.13 – 4 mm ²			
Cross section solid/stranded		0.13 – 6 mm ²				
Cross section, AWG						
Rated current		*				
Rated voltage		800 V				
Rated impulse voltage		8 kV				
Pollution degree		3				
Note		* Observe the derating curve, available in our e-catalog at https://eshop.wieland-electric.com				
Accessories		Type	Part No.	Std. Pack		
End plate, gray		APFN 4 D2/2	07.312.9055.0	10		
Partition, 4 mm for TCP, gray		ZP/WKFN 4 TKG	07.313.1655.0	10		
Partition, gray		TWFN 4 D2/2	07.312.9155.0	10		

<p>Automotive fuses</p> <p>The WKFN 4 FSI .. type fuse blocks take blade-type fuses according to ISO 8820 (DIN 72581-3). Automotive fuses are not offered for sale by Wieland Electric!</p> <p>We recommend the following:</p> 	Description		Color	
	Blade-type automobile fuse, DC 32 V			
	Electrotechnical specialized trade		black	1 A
	Motor vehicle accessory market		gray	2 A
			violet	3 A
			pink	4 A
			beige	5 A
			brown	7,5 A
			red	10 A
			blue	15 A
		yellow	20 A	
Thermal circuit breaker, DC 32 V			5 A	
ETA*, type 1610-21 or			6 A	
ETA*, type 1610-H2 with manual release			10 A	
			15 A	
			20 A	
Thermal circuit breaker, AC 250 V; DC 65 V			0,1 A	
ETA*, type 1180 ..			0,2 A	
			0,5 A	
			1 A	
			2 A	
			3 A	
			4 A	
			6 A	
			8 A	
			10 A	

Supply terminal

WKF 16/35 PV/WKFN

- Supply terminal for mounting on TS 35
- Nominal cross section 2.5 mm²
- Ex e I/II Ⓜ II 2GD IM2
Follow the EX installation instructions on page 143



Description	Type	Part No.	Std. Pack
Supply terminal, gray	WKF 16/35 PV/WKFN	56.716.0353.0	20
General data			
Width / length / height, incl. TS 7.5	12 mm / 82 mm / 48 mm		
Wire strip length	15 mm		
Approvals	IEC ATEX KEMA 01 ATEX 2087 U		
Technical data			
	IEC	UL	CSA
	EN 60 947-7-3		EN 60 079-0/-7
Cross section fine-stranded	4–16 mm ²		4–16 mm ²
Cross section solid/stranded	4–16 mm ²		4–16 mm ²
Cross section, AWG	24–4		12–4
Rated current	76 A	75 A	64 A ¹⁾
Rated voltage	800 V	600 V	600 V
Rated impulse voltage	8 kV		690 V
Pollution degree	3		
Note			
	¹⁾ Derating curves available on request		

Accessories	Type	Part No.	Std. Pack
Cover with warning symbol over 4 blocks	ADF 16/4 GELB	04.343.6653.8	10
Screwdriver, uninsulated	DIN 5264 B 1,0x5,5	06.502.4200.0	5

Potential distribution	one side		both sides	
	single	double	single	double
Jumpering				
IVB WKF 4...				
I _{max}	64	76	76	76
I _{Nblock}	32	32	32	32

$$I_{\max} = \sum I_n \leq \sum I_{Nblock}$$

Accessories for fasis WKFN 4 FSI...



Accessories	Type	Part No.	Std. Pack	
Cross connector, insulated, for	2 blocks	IVB WKF 4–2	Z7.261.1227.0	10
	3 blocks	IVB WKF 4–3	Z7.261.1327.0	10
	4 blocks	IVB WKF 4–4	Z7.261.1427.0	10
	5 blocks	IVB WKF 4–5	Z7.261.1527.0	10
	6 blocks	IVB WKF 4–6	Z7.261.1627.0	10
	7 blocks	IVB WKF 4–7	Z7.261.1727.0	20
	8 blocks	IVB WKF 4–8	Z7.261.1827.0	20
	9 blocks	IVB WKF 4–9	Z7.261.1927.0	20
	10 blocks	IVB WKF 4–10	Z7.261.1027.0	20
	Wire entry guide	0.13–0.2 mm ²	LEL 4/1 WEISS	05.561.8553.0
0.25–0.5 mm ²		LEL 4/2 GRAU	05.561.8653.0	100
0.75–1.0 mm ²		LEL 4/1 SCHWARZ	05.561.8753.0	100
Cover with warning symbol over 4 blocks	yellow	ADF 4/4 GELB	04.343.6153.8	10
Screwdriver, uninsulated		DIN 5264 B 0,6x3,5	06.502.4000.0	5
Screwdriver, uninsulated, MINI		DIN 5264 B 0,6x3,5 M	06.502.5000.0	10

DIN rail terminal blocks with plug-in connection

The system

- Rated current up to 32 A
- Connection cross-section 4 mm²
- Width 5 mm

The terminals

Modular DIN rail mount terminals for universal use with pluggable connectors, all with tension spring connection technology.

In addition to the pluggable connection, a tension spring connection also is available to use the block as a standard feed-through terminal.

The connectors

For application specific wire harness assemblies, or single pole test plug.

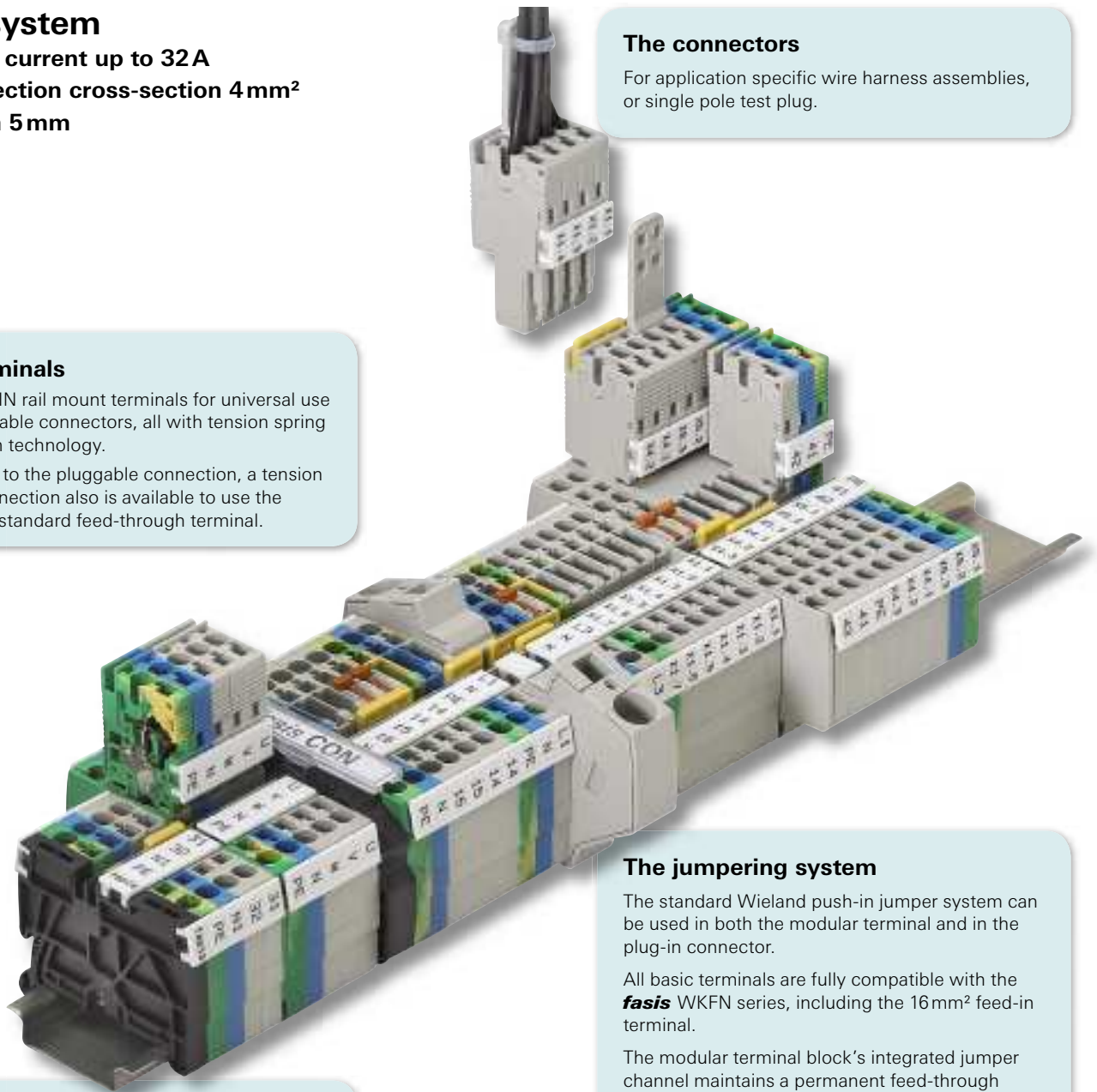

The labeling system

All termination points can be clearly labeled using the standard Wieland labeling system.

The jumpering system

The standard Wieland push-in jumper system can be used in both the modular terminal and in the plug-in connector.

All basic terminals are fully compatible with the **fasis** WKFN series, including the 16 mm² feed-in terminal.

The modular terminal block's integrated jumper channel maintains a permanent feed-through connection even when the plug is not installed.

Integrated safety

Touch protection of all components, even when not connected, IP 20 when connected.

All plug connectors have a built-in latching mechanism and coding option – no further accessories required.

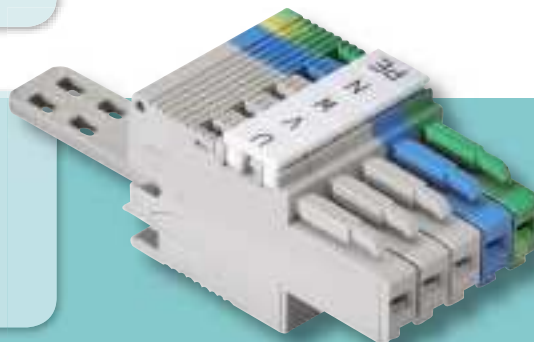



Plug & Play in the control cabinet – with **fasis CON**

fasis CON is a DIN rail terminal block system with a pluggable outgoing feeder, which offers modular, cost-saving solutions with advantages in every phase of the service life of an electrical system.

fasis CON is a fully compatible part of the established **fasis WKFN** system. Both the terminal and the plug connector possess the high-performance features of **fasis WKFN**.

fasis CON consists of feed-through and ground DIN rail terminal blocks with a wide variety of both wiring termination points and sockets for the **fasis CON** pluggable connectors.

fasis CON is a cost-effective, high-performance and pluggable system solution.

Cost-effective

- Cost-optimized installation and maintenance times
- Small numbers of components
- Can be assembled individually
- Pre-assembled modules

High-performance

- Range of terminals up to 4 mm²
- Rated current up to 32 A*
- Rated voltage 500 V
- Total width only 5 mm

Pluggable



- Complex systems can be brought on-line quickly and cost-effectively with pluggable technology
- Functional units can be tested easily
- Field components can be more quickly replaced when faults occur
- Systems can be expanded with pluggable technology



Complete system

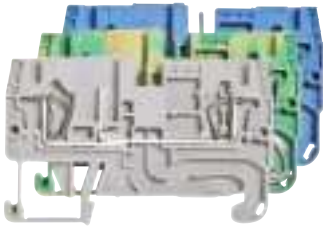

- Uniform accessories
- Coded to prevent mismatching
- All components can be jumpered
- Comprehensive and clear labeling
- Can be combined with **fasis WKFN**

* Observe the derating curve, available in our e-catalog at <https://eshop.wieland-electric.com>

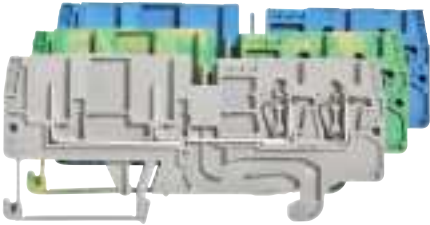
DIN rail terminal blocks with plug-in connection

WKFN 2,5 F/P/F		Description	Type	Part No.	Std. Pack
<ul style="list-style-type: none"> DIN rail terminal blocks with plug-in connection for mounting on TS 35 Nominal cross section 2.5 mm² 		Feed-through block F/P/F, gray	WKFN 2,5 F/P/F	56.703.2355.0	100
		Feed-through block F/P/F, blue	WKFN 2,5 F/P/F	56.703.2355.6	100
		Ground block, green/yellow	WKFN 2,5 F/P/F-SL	56.703.2455.0	100
General data					
Width / length / height, incl. TS 7.5		5 mm / 60 mm / 39 mm			
Wire strip length		11 mm			
Approvals					
Technical data		IEC	UL	CSA	
		EN 60947-7-1/-2			
Cross section fine-stranded		0.13 – 4 mm ²			
Cross section solid/stranded		0.13 – 4 mm ²			
Cross section, AWG		24 – 12			
Rated current		32 A*		20 A	
Rated voltage		500 V		300 V	
Rated impulse voltage		8 kV			
Pollution degree		3			
Note		* Observe the derating curve, available in our e-catalog at https://eshop.wieland-electric.com			
Accessories		Type	Part No.	Std. Pack	
End plate, gray		APFN 2,5 D1/2	07.312.6955.0	10	
End plate, blue		APFN 2,5 D1/2 BLAU	07.312.6955.6	10	
Partition, gray		TWFN 2,5 D1/2	07.312.7055.0	10	

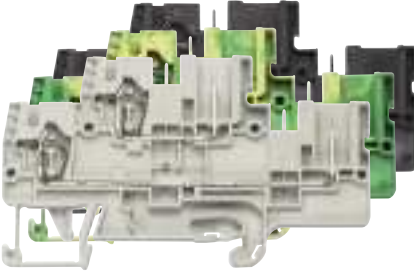
WKFN 2,5 2P/2F		Description	Type	Part No.	Std. Pack
<ul style="list-style-type: none"> DIN rail terminal blocks with plug-in connection for mounting on TS 35 Nominal cross section 2.5 mm² 		Feed-through block 2P/2F, gray	WKFN 2,5 2P/2F	56.703.2155.0	100
		Feed-through block 2P/2F, blue	WKFN 2,5 2P/2F	56.703.2155.6	100
		Ground block, green/yellow	WKFN 2,5 2P/2F-SL	56.703.2255.0	100
General data					
Width / length / height, incl. TS 7.5		5 mm / 85 mm / 39 mm			
Wire strip length		11 mm			
Approvals					
Technical data		IEC	UL	CSA	
		EN 60947-7-1/-2			
Cross section fine-stranded		0.13 – 4 mm ²			
Cross section solid/stranded		0.13 – 4 mm ²			
Cross section, AWG		24 – 12			
Rated current		32 A*		20 A	
Rated voltage		500 V		300 V	
Rated impulse voltage		8 kV			
Pollution degree		3			
Note		* Observe the derating curve, available in our e-catalog at https://eshop.wieland-electric.com			
Accessories		Type	Part No.	Std. Pack	
End plate, gray		APFN 2,5 TKM D2/2	07.313.0055.0	10	
Partition, gray		TWFN 2,5 TKM D2/2	07.313.0155.0	10	

WKFN 2,5 E/./././.		Description	Type	Part No.	Std. Pack
<ul style="list-style-type: none"> Multi-tier blocks with plug-in connection for mounting on TS 35 Nominal cross section 2.5 mm² 		Multi-tier block E/F/P, gray	WKFN 2,5 E/F/P	56.703.3455.0	100
		Multi-tier block, vertically connected, black	WKFN 2,5 E/VB/F/P	56.703.3555.1	100
		Multi-tier ground block, green/yellow	WKFN 2,5 E/F/P/SL	56.703.3655.0	100
General data					
Width / length / height, incl. TS 7.5		5 mm / 82 mm / 49 mm			
Wire strip length		11 mm			
Approvals					
Technical data		IEC	UL	CSA	
		EN 60947-7-1/-2			
Cross section fine-stranded		0.13 – 4 mm ²			
Cross section solid/stranded		0.13 – 4 mm ²			
Cross section, AWG		24 – 12			
Rated current		22 A*		20 A	
Rated voltage		500 V		300 V	
Rated impulse voltage		8 kV			
Pollution degree		3			
Note		* Observe the derating curve, available in our e-catalog at https://eshop.wieland-electric.com			
Accessories		Type	Part No.	Std. Pack	
End plate, gray		APFN 2,5 E	07.312.7355.0	10	
Partition, gray		TWFN 2,5 E	07.312.7455.0	10	

Connectors

WBF 2,5/.../..

- Connectors for DIN rail terminal blocks with plug-in connection

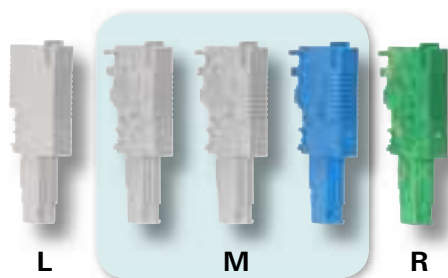

Description	Type	Part No.	Std. Pack
Connectors LEFT			
gray	WBF 2,5 1/L/GR	Z1.110.8955.0	50
blue	WBF 2,5 1/L/BL	Z1.110.8955.6	50
green/yellow	WBF 2,5 1/L/SL	Z1.110.8955.7	50
Connectors MIDDLE			
gray	WBF 2,5 1/M/GR	Z1.110.8855.0	50
blue	WBF 2,5 1/M/BL	Z1.110.8855.6	50
green/yellow	WBF 2,5 1/M/SL	Z1.110.8855.7	50
Connectors RIGHT			
gray	WBF 2,5 1/R/GR	Z1.110.9055.0	50
blue	WBF 2,5 1/R/BL	Z1.110.9055.6	50
green/yellow	WBF 2,5 1/R/SL	Z1.110.9055.7	50
Connectors preassembled, gray			
1 pole	WBF 2,5-1	59.903.0155.0	50
2 pole	WBF 2,5-2	59.903.0255.0	50
3 pole	WBF 2,5-3	59.903.0355.0	50
4 pole	WBF 2,5-4	59.903.0455.0	50
5 pole	WBF 2,5-5	59.903.0555.0	50
6 pole	WBF 2,5-6	59.903.0655.0	25
7 pole	WBF 2,5-7	59.903.0755.0	25
8 pole	WBF 2,5-8	59.903.0855.0	25
9 pole	WBF 2,5-9	59.903.0955.0	25
10 pole	WBF 2,5-10	59.903.1055.0	25
General data			
Width / length / height, incl. TS 7.5	5 mm		
Wire strip length	11 mm		
Approvals			
Technical data	IEC	UL	CSA
	EN 60947-7-1/-2		
Cross section fine-stranded	0.13 – 4 mm ²		
Cross section solid/stranded	0.13 – 4 mm ²		
Cross section, AWG	24 – 12		
Rated current	32 A*		
Rated voltage	500 V		
Rated impulse voltage	8 kV		
Pollution degree	3		
Note	* Observe the derating curve, available in our e-catalog at https://eshop.wieland-electric.com		
Accessories			
Strain relief	Z-WBF	05.567.9155.0	10
Screwdriver, uninsulated	DIN 5264 B 0,6x3,5	06.502.4000.0	10
Screwdriver, MINI	DIN 5264 B 0,6x3,5 M	06.502.5000.0	10

Accessories for *fasis* WKFN 2,5...



Accessories	Type	Part No.	Std. Pack	
Cross connector, insulated, for	2 blocks	IVB WKFN 2,5-2	Z7.280.6227.0	10
	3 blocks	IVB WKFN 2,5-3	Z7.280.6327.0	10
	4 blocks	IVB WKFN 2,5-4	Z7.280.6427.0	10
	5 blocks	IVB WKFN 2,5-5	Z7.280.6527.0	10
	6 blocks	IVB WKFN 2,5-6	Z7.280.6627.0	10
	7 blocks	IVB WKFN 2,5-7	Z7.280.6727.0	20
	8 blocks	IVB WKFN 2,5-8	Z7.280.6827.0	20
	9 blocks	IVB WKFN 2,5-9	Z7.280.6927.0	20
	10 blocks	IVB WKFN 2,5-10	Z7.280.7027.0	20
	20 blocks	IVB WKFN 2,5-20	Z7.280.8027.0	20
Wire entry guide	0.13–0.2 mm ²	LELN 2,5/1 WEISS	05.564.3755.0	100
	0.25–0.5 mm ²	LELN 2,5/1 GRAU	05.564.3855.0	100
	0.75–1.0 mm ²	LELN 2,5/1 SCHWARZ	05.564.3955.0	100
Cover with warning symbol over 4 blocks	yellow	ADFN 2,5/4 GELB	04.343.8353.8	10
Test adapter, modular	PS WKC/F	Z1.299.9753.0	10	
Screwdriver, uninsulated	DIN 5264 B 0,6x3,5	06.502.4000.0	5	
Screwdriver, uninsulated, MINI	DIN 5264 B 0,6x3,5 M	06.502.5000.0	10	

DIN rail terminal blocks with tension spring and pluggable connections

<p>WKF 2,5 D2/8113/35</p> <ul style="list-style-type: none"> • Duo feed-through block for mounting on TS 35 • Nominal cross section 2.5 mm² 	Description	Type	Part No.	Std. Pack	
	Du feed-through block, gray	WKF 2,5 D2/8113/35	56.703.2053.0	100	
	Duo feed-through block, blue	WKF 2,5 D2/8113/35 BLAU	56.703.2053.6	100	
	General data				
	Width / length / height, incl. TS 7.5	5 mm / 76 mm / 42 mm			
	Wire strip length	11 mm			
	Approvals				
	Technical data		IEC	UL	CSA
		EN 60947-7-1			
	Cross section fine-stranded	0.13 – 2.5 mm ²			
Cross section solid/stranded	0.13 – 4 mm ²				
Cross section, AWG		22 – 12	24 – 12		
Rated current	16 A	15 A	15 A		
Rated voltage	250 V	300 V	300 V		
Rated impulse voltage	4 kV				
Pollution degree	3				
Accessories		Type	Part No.	Std. Pack	
End plate, gray		APF 2,5/D2/8113	07.312.4153.0	10	
End plate, blue		APF 2,5/D2/8113	07.312.4153.6	10	
Wire entry guide	0.13–0.2 mm ²	LEL 2,5/1 WEISS	05.561.6553.0	100	
	0.25–0.5 mm ²	LEL 2,5/2 GRAU	05.561.6653.0	100	
	0.75–1.0 mm ²	LEL 2,5/3 SCHWARZ	05.561.6753.0	100	
Cover with warning symbol over 4 blocks		ADF 2,5/4 GELB	04.343.6053.8	10	
<p>WKF 2,5 D2/8113/SL/35</p> <ul style="list-style-type: none"> • Duo-Ground block for mounting on TS 35 • Nominal cross section 2.5 mm² 	Description	Type	Part No.	Std. Pack	
	Duo-Ground block, green/yellow	WKF 2,5 D2/8113 SL/35	56.703.9253.0	100	
	General data				
	Width / length / height, incl. TS 7.5	5 mm / 76 mm / 42 mm			
	Wire strip length	11 mm			
	Approvals				
	Technical data		IEC	UL	CSA
		EN 60947-7-1			
	Cross section fine-stranded	0.13 – 2.5 mm ²			
	Cross section solid/stranded	0.13 – 4 mm ²			
Cross section, AWG		22 – 12	24 – 12		
Rated current	16 A				
Rated voltage	250 V	300 V	300 V		
Rated impulse voltage	4 kV				
Pollution degree	3				
Accessories		Type	Part No.	Std. Pack	
End plate, gray		APF 2,5/D2/8113	07.312.4153.0	10	
Wire entry guide	0.13–0.2 mm ²	LEL 2,5/1 WEISS	05.561.6553.0	100	
	0.25–0.5 mm ²	LEL 2,5/2 GRAU	05.561.6653.0	100	
	0.75–1.0 mm ²	LEL 2,5/3 SCHWARZ	05.561.6753.0	100	
Cover with warning symbol over 4 blocks		ADF 2,5/4 GELB	04.343.6053.8	10	
<p>WKF 1,5 E/8113/35</p> <ul style="list-style-type: none"> • Multi-tier block for mounting on TS 35 • Nominal cross section 1.5 mm² 	Description	Type	Part No.	Std. Pack	
	Multi-tier block, gray	WKF 1,5 E/8113/35	56.702.2053.0	100	
	General data				
	Width / length / height, incl. TS 7.5	5 mm / 83 mm / 51 mm			
	Wire strip length	8 mm			
	Approvals				
	Technical data		IEC	UL	CSA
		EN 60947-7-1			
	Cross section fine-stranded	0.13 – 1.5 mm ²			
	Cross section solid/stranded	0.13 – 2.5 mm ²			
Cross section, AWG		22 – 12	24 – 12		
Rated current	16 A				
Rated voltage	250 V				
Rated impulse voltage	4 kV				
Pollution degree	3				
Accessories		Type	Part No.	Std. Pack	
End plate, gray		APF 1,5/E/8113	07.312.4753.0	10	
Wire entry guide	0.13–0.2 mm ²	LEL 1,5/1 WEISS	05.562.2453.0	100	
	0.25–0.5 mm ²	LEL 1,5/2 GRAU	05.562.2553.0	100	
	0.75–1.0 mm ²	LEL 1,5/3 SCHWARZ	05.562.2653.0	100	
Cover with warning symbol over 4 blocks		ADF 1,5/4 GELB	04.343.8353.8	10	

WKF 1,5 E/35

- Multi-tier block for mounting on TS 35
- Nominal cross section 1.5 mm²





Description	Type	Part No.	Std. Pack
Multi-tier block, gray	WKF 1,5 E/35	56.702.7053.0	100
General data			
Width / length / height, incl. TS 7.5	5 mm / 83 mm / 51 mm		
Wire strip length	8 mm		
Approvals			
Technical data		IEC	UL
	EN 60947-7-1		
Cross section fine-stranded	0.13 – 1.5 mm ²		
Cross section solid/stranded	0.13 – 2.5 mm ²		
Cross section, AWG			
Rated current	17,5 A	30 – 14	30 – 14
Rated voltage	400 V	300 V	600 V
Rated impulse voltage	6 kV		
Pollution degree	3		
Accessories			
End plate, gray	APF 1,5 E	07.312.3553.0	10
Partition, gray	TWF 1,5 E	07.312.3653.0	10
Wire entry guide	0.13 – 0.2 mm ²	LEL 1,5/1 WEISS	05.562.2453.0
	0.25 – 0.5 mm ²	LEL 1,5/2 GRAU	05.562.2553.0
	0.75 – 1.0 mm ²	LEL 1,5/3 SCHWARZ	05.562.2653.0
Cover with warning symbol over 4 blocks	ADF 1,5/4 GELB	04.343.8353.8	10

wiecon PC board connector

Type 8113 BFK

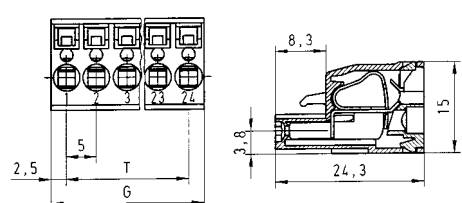
- Spring clamp/tension spring system
- 5 mm spacing, nominal cross section 2,5 mm²
- Accessories: coding pice 05.561.9153.0
- Rated voltages: VDE 0110/01.89
250 V/4 kV/3 – Overvoltage category III
400 V/4 kV/2 – Overvoltage category II
1000 V/4 kV/1 – Overvoltage category I

G	T	Pole	Part No.	Part No.	Std. Pack
5 mm spacing			unmarked	marked	
10.00	5.00	2	25.920.3253.0	25.920.0253.0	100
15.00	10.00	3	25.920.3353.0	25.920.0353.0	100
20.00	15.00	4	25.920.3453.0	25.920.0453.0	50
25.00	20.00	5	25.920.3553.0	25.920.0553.0	50
30.00	25.00	6	25.920.3653.0	25.920.0653.0	50
35.00	30.00	7	25.920.3753.0	25.920.0753.0	50
40.00	35.00	8	25.920.3853.0	25.920.0853.0	50
45.00	40.00	9	25.920.3953.0	25.920.0953.0	50
50.00	45.00	10	25.920.4053.0	25.920.1053.0	50
55.00	50.00	11	25.920.4153.0	25.920.1153.0	50
60.00	55.00	12	25.920.4253.0	25.920.1253.0	50
65.00	60.00	13	25.920.4353.0	25.920.1353.0	50
70.00	65.00	14	25.920.4453.0	25.920.1453.0	50
75.00	70.00	15	25.920.4553.0	25.920.1553.0	50
80.00	75.00	16	25.920.4653.0	25.920.1653.0	50
17- to 24- pole configurations upon request					
General data					
Wire strip length	9 mm				
Approvals					
Technical data		IEC	UL	CSA	
	EN 60947-7-1				
Cross section fine-stranded	0.13 – 2.5 mm ²				
Cross section solid/stranded	0.13 – 4 mm ²				
Cross section, AWG					
Rated current	12 A	22 – 12	22 – 12	22 – 12	
Rated voltage		300 V	300 V	300 V	
Rated impulse voltage					
Pollution degree					

Accessories for *fasis* WKF 2,5 D... and WKF 1,5 E...



Accessories	Type	Part No.	Std. Pack
Cross connector, insulated	2 pole	IVB WKF 2,5–2	Z7.280.6227.0
	3 pole	IVB WKF 2,5–3	Z7.280.6327.0
	4 pole	IVB WKF 2,5–4	Z7.280.6427.0
	5 pole	IVB WKF 2,5–5	Z7.280.6527.0
	6 pole	IVB WKF 2,5–6	Z7.280.6627.0
	7 pole	IVB WKF 2,5–7	Z7.280.6727.0
	8 pole	IVB WKF 2,5–8	Z7.280.6827.0
	9 pole	IVB WKF 2,5–9	Z7.280.6927.0
	10 pole	IVB WKF 2,5–10	Z7.280.7027.0
	20 pole	IVB WKF 2,5–20	Z7.280.8027.0
Cover with warning symbol over 4 poles	yellow	AD 8113/4 GELB	04.343.6853.8
Screwdriver, uninsulated		DIN 5264 B 0,6x3,5	06.502.4000.0
Coding strip			05.561.0053.0

Initiator and actuator blocks with tension spring connection



For machine and system control wiring, practice-oriented solutions are preferred that are primarily economical and reliable and thus contribute to the system's operational and functional safety.

fasis KOI was designed to connect the great variety of initiators and actuators to central and remote control systems. The initiator and actuator blocks of type WKF 1,5 KOI have, in particular, been conceived for the requirements in machine and system engineering. They facilitate the wiring task through clearly arranged termination points and an easily accessible and operable tension spring technology.

fasis KOI is a compact and efficient wiring system for connection purposes, potential distribution and transmission of signals from initiators and actuators.



System features and benefits

- Control-compatible system solutions through accurate matching of the connection modules' number of poles to the input and output modules of the PLC.
- Flexible connection module mounting options with either snap-on TS 35 DIN rail mount, or direct mounting to a backplane with screws.
- Application-specific individual terminal block as a link between initiators, actuators and the PLC.



Economically designed

- Low space requirements due to compact dimensioning of the individual terminal blocks and integration of the potential distribution inside the connection module.
- Efficient installation and start-up of the wiring system by simply fitting the connection module with components, making further accessories unnecessary.
- Reduction of the warehousing costs due to a low variety of parts without having to forego flexibility in the application.



Service-friendly operation

- Short maintenance times for modifications of the terminal block assembly by replacing or extending individual blocks without interrupting the power supply of the other initiator and actuator blocks.
- Immediate visual monitoring of the switching states due to integrated light-emitting diodes.
- No maintenance required due to a permanently secure and dynamic tension spring clamp connection system.

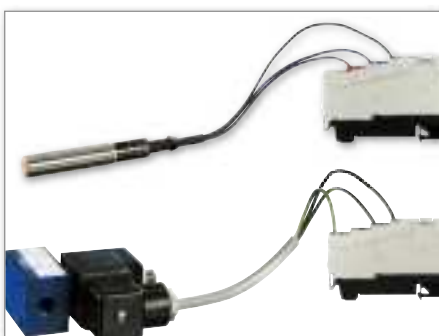

Application specific options

- Power supply to the connection modules through supply blocks, with optional LEDs.
- Potential distribution through connection modules in designs for 9 (1+8) or 18 (2x(1+8)) terminal blocks.
- Initiator blocks, for example for the connection of 3-wire or 4-wire proximity or position switches, with optional LEDs.
- Actuator terminals, for example for the connection of magnetic valves.



Connection module

Collect and distribute potentials

- Potential distribution is achieved quickly and safely as soon as the terminal blocks are snapped on.
- Cross connectors for the plus, minus and ground or screen potential are each integrated in the connection modules.
- The system does not require any additional cross connectors.



Wire entry guides

Connect small cross sections safely

- Wire entry guides prevent the wires from being inserted too deeply (smaller than 1 mm²) and enable an easy, professional and quick installation.
- Ensure the connection of solid and fine-stranded wires smaller than 1 mm².
- Also see the accessories for DIN rail terminal blocks starting at page 120!



Marking system

All clamping points marked clearly

- Marking tags easily readable even with the wires connected.
- Clear assignment of wire to the termination point while wiring.
- Simplified troubleshooting for servicing.
- Customized marking with the **wiemark** and **wieplot** marking systems.

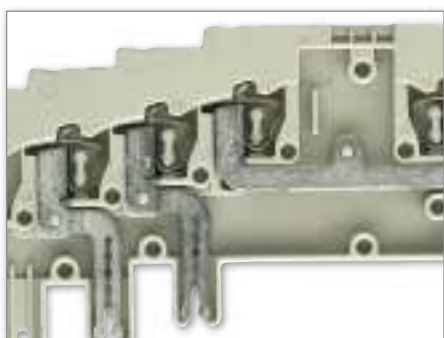

Materials

High-quality materials

- Special alloys enable low feed-through resistance and provide a gas-tight contact area:
 - clamping spring: stainless CrNi steel
 - current-carrying bar: tin-plated copper
- Polyamide has excellent electrical, chemical and mechanical characteristics:
 - temperature resistance: up to 120°C
 - creepage resistance: CTI 600
 - flammability class: self-extinguishing, UL94-V2



Initiator and actuator blocks with tension spring connection

WKF 1,5 KOI 3L...

- Initiator block with tension spring connection for mounting on TS 35
- Nominal cross section 1.5 mm²



37.702.7453.0
* 65 V/1.5 kV/3

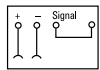

37.702.8453.0
* DC 24 V
same as picture,
but with LED



Description	Type	Part No.	Std. Pack
Initiator block, gray	WKF 1,5 KOI 3L	37.702.7453.0	50
Initiator block with LED, gray	WKF 1,5 KOI 3L-PGE	37.702.8453.0	50
General data			
Width / length / height, incl. TS 7.5	5 mm / 71 mm / 48 mm		
Wire strip length	10 mm		
Approvals			
Technical data	IEC	UL	CSA
	EN 60947-7-1		
Cross section fine-stranded	0.13 – 1.5 mm ²		
Cross section solid/stranded	0.13 – 1.5 mm ²		
Cross section, AWG	28 – 16		
Rated current	10 A		
Rated voltage	*		
Rated impulse voltage	65 V		
Pollution degree			
Accessories			
Wire entry guide	Type	Part No.	Std. Pack
0.13–0.2 mm ²	LEL 1,5/1 WEISS	05.562.2453.0	100
0.25–0.5 mm ²	LEL 1,5/2 GRAU	05.562.2553.0	100
0.75–1.0 mm ²	LEL 1,5/3 SCHWARZ	05.562.2653.0	100
Screwdriver, uninsulated	DIN 5264 B 0,6x3,5	06.502.4000.0	5

WKF 1,5 KOI 3L/SL...

- Initiator block with tension spring connection for mounting on TS 35
- Nominal cross section 1.5 mm²



37.702.7553.0
* 65 V/1.5 kV/3

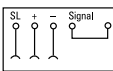

37.702.8553.0
* DC 24 V
same as picture,
but with LED



Description	Type	Part No.	Std. Pack
Initiator block, gray	WKF 1,5 KOI 3L/SL	37.702.7553.0	50
Initiator block with LED, gray	WKF 1,5 KOI 3L/SL-PGE	37.702.8553.0	50
General data			
Width / length / height, incl. TS 7.5	5 mm / 71 mm / 48 mm		
Wire strip length	10 mm		
Approvals			
Technical data	IEC	UL	CSA
	EN 60947-7-1		
Cross section fine-stranded	0.13 – 1.5 mm ²		
Cross section solid/stranded	0.13 – 1.5 mm ²		
Cross section, AWG	28 – 16		
Rated current	10 A		
Rated voltage	*		
Rated impulse voltage	65 V		
Pollution degree			
Accessories			
Wire entry guide	Type	Part No.	Std. Pack
0.13–0.2 mm ²	LEL 1,5/1 WEISS	05.562.2453.0	100
0.25–0.5 mm ²	LEL 1,5/2 GRAU	05.562.2553.0	100
0.75–1.0 mm ²	LEL 1,5/3 SCHWARZ	05.562.2653.0	100
Screwdriver, uninsulated	DIN 5264 B 0,6x3,5	06.502.4000.0	5

WKF 1,5 KOE...

- Supply block with tension spring connection for mounting on TS 35
- Nominal cross section 1.5 mm²



37.702.7753.0
* 65 V/1.5 kV/3

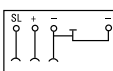

37.702.8753.0
* DC 24 V
same as picture,
but with LED



Description	Type	Part No.	Std. Pack
Supply block, black	WKF 1,5 KOE	37.702.7753.0	50
Supply block with LED, black	WKF 1,5 KOE-PGN	37.702.8753.0	50
General data			
Width / length / height, incl. TS 7.5	5 mm / 71 mm / 48 mm		
Wire strip length	10 mm		
Approvals			
Technical data	IEC	UL	CSA
	EN 60947-7-1		
Cross section fine-stranded	0.13 – 1.5 mm ²		
Cross section solid/stranded	0.13 – 1.5 mm ²		
Cross section, AWG	28 – 16		
Rated current	10 A		
Rated voltage	*		
Rated impulse voltage	65 V		
Pollution degree			
Accessories			
Wire entry guide	Type	Part No.	Std. Pack
0.13–0.2 mm ²	LEL 1,5/1 WEISS	05.562.2453.0	100
0.25–0.5 mm ²	LEL 1,5/2 GRAU	05.562.2553.0	100
0.75–1.0 mm ²	LEL 1,5/3 SCHWARZ	05.562.2653.0	100
Screwdriver, uninsulated	DIN 5264 B 0,6x3,5	06.502.4000.0	5

WKF 1,5 KOA 2L...

- Actuator block with tension spring connection for mounting on TS 35
- Nominal cross section 1.5 mm²



37.702.7653.0
* 65 V/1.5 kV/3



37.702.8653.0
* DC 24 V
same as picture,
but with LED



Description	Type	Part No.	Std. Pack
Actuator block, gray	WKF 1,5 KOA 2L	37.702.7653.0	50
Actuator block with LED, gray	WKF 1,5 KOA 2L/SL-PGE	37.702.8653.0	50
General data			
Width / length / height, incl. TS 7.5	5 mm / 71 mm / 48 mm		
Wire strip length	10 mm		
Approvals			
Technical data	IEC	UL	CSA
	EN 60947-7-1		
Cross section fine-stranded	0.13 – 1.5 mm ²		
Cross section solid/stranded	0.13 – 1.5 mm ²		
Cross section, AWG	28 – 16		
Rated current	10 A	10 A	
Rated voltage	*	65 V	
Rated impulse voltage			
Pollution degree			
Accessories			
Wire entry guide	Type	Part No.	Std. Pack
0.13 – 0.2 mm ²	LEL 1,5/1 WEISS	05.562.2453.0	100
0.25 – 0.5 mm ²	LEL 1,5/2 GRAU	05.562.2553.0	100
0.75 – 1.0 mm ²	LEL 1,5/3 SCHWARZ	05.562.2653.0	100
Screwdriver, uninsulated	DIN 5264 B 0,6x3,5	06.502.4000.0	5

VM WKF ...

- Connection module for 9 or 18 blocks



Description	Type	Part No.	Std. Pack
Connection module for 9 blocks, black	VM WKF KO..9	69.700.0953.0	10
Connection module for 18 blocks, black	VM WKF KO..18	69.700.1853.0	5
General data			
Length: 9 pole module	L = 9 x 5 mm + 1.5 mm		
Length: 18 pole module	L = 18 x 5 mm + 1.5 mm		
Approvals			
Technical data	IEC	UL	CSA
	EN 60947-7-1		
Cross section fine-stranded	0.13 – 1.5 mm ²		
Cross section solid/stranded	0.13 – 1.5 mm ²		
Cross section, AWG			
Rated current	10 A	10 A	
Rated voltage	*	65 V	
Rated impulse voltage			
Pollution degree			

DIN rail terminal blocks with tension spring connection



With our DIN rail terminal block system **fasis** MINI we focus on the application's size and flexibility. **fasis** MINI is a range of DIN rail terminal blocks in tension spring technology designed for installation in confined spaces.

The portfolio comprises ground blocks and feed-through blocks in various colors with 2 or 4 connections per potential.

The potential in the WKFM 2,5 terminal block series can be distributed, modified and extended quickly, flexibly and without problem by using cross connectors.

Designed to be mounted in various ways, including TS 35 and TS 15 DIN rails, backpanels, or inside distribution boxes, we provide different solutions including snap-on mounting feet, pins, and screw flanges.



Solutions for confined spaces

- Space-saving miniature terminal blocks in many designs for installation inside distribution boxes, motors and applications with confined space requirements.
- Easy wiring with user-friendly screwdriver entry guides at the top of the block.
- Marking tags easily readable even with the wires connected.
- Customized assembly design and marking using **wieplan** and **wiemarc**.



Application specific options

- Miniature terminal blocks with push-in mounting pin for installation directly onto the panel.
- Miniature terminal blocks with screw flange for installation directly onto the panel.
- Miniature terminal blocks for installation on TS 15 or TS 35 mounting rails.







Customized assembly



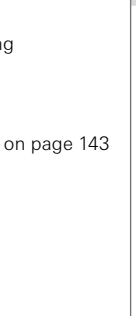

- DIN rail terminal blocks of the **fasis** MINI series are available in 2 and 4 pole configurations.
- **fasis** MINI blocks can be snapped together with the integrated latching pins, with or without a mounting rail.
- The various potentials and terminal blocks are visually distinguished by several color variations.
- Individual marking using marking tags or customized printing of the terminal blocks.

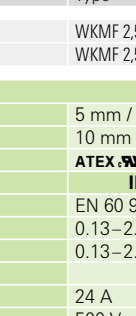

Permanent electrical connection

- The tension spring system provides a dynamic clamping connection. Load-controlled and thermal cold flow properties of the connected wires are balanced.
- Maintenance-free and gas-tight electrical connection as specified by the approvals. Customized layouts can be created individually.
- Separation of electrical and mechanical functions.







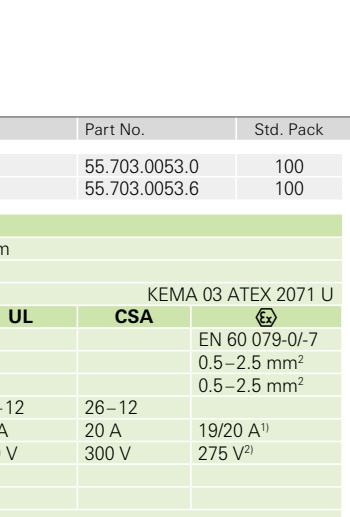





<p>WKMF 2,5/15</p> <ul style="list-style-type: none"> • Feed-through block with tension spring connection for mounting on TS 15 • Nominal cross section 2.5 mm² • Ex e II  II 2GD • Follow the EX installation instructions on page 143 	Description		Type	Part No.	Std. Pack	
	Feed-through block, gray		WKMF 2,5/15	55.703.0053.0	100	
	Feed-through block, blue		WKMF 2,5/15	55.703.0053.6	100	
	General data					
	Width / length / height, incl. TS 5.5		5 mm / 36 mm / 30 mm			
	Wire strip length		10 mm			
	Approvals		ATEX   KEMA 03 ATEX 2071 U			
	Technical data		IEC	UL	CSA	
			EN 60 947-7-1			EN 60 079-0/-7
	Cross section fine-stranded		0.13–2.5 mm ²		0.5–2.5 mm ²	
Cross section solid/stranded		0.13–2.5 mm ²		0.5–2.5 mm ²		
Cross section, AWG		26–12		26–12		
Rated current		24 A		20 A		
Rated voltage		500 V		600 V		
Rated impulse voltage		6 kV		300 V		
Pollution degree		3				
Note		¹⁾ with/without jumper ²⁾ For maintaining the proper isolation distances, the open side of feed-through or ground blocks as well as both sides of a jumper are to be covered by partitions.				













<p>WKMF 2,5 SL/15</p> <ul style="list-style-type: none"> • Ground block with tension spring connection for mounting on TS 15 • Nominal cross section 2.5 mm² • Ex e II  II 2GD • Follow the EX installation instructions on page 143 	Description		Type	Part No.	Std. Pack	
	Ground block, green/yellow		WKMF 2,5 SL/15	55.703.9053.0	100	
	General data					
	Width / length / height, incl. TS 5.5		5 mm / 36 mm / 30 mm			
	Wire strip length		10 mm			
	Approvals		ATEX   KEMA 03 ATEX 2071 U			
	Technical data		IEC	UL	CSA	
			EN 60 947-7-2			EN 60 079-0/-7
	Cross section fine-stranded		0.13–2.5 mm ²		0.5–2.5 mm ²	
	Cross section solid/stranded		0.13–2.5 mm ²		0.5–2.5 mm ²	
Cross section, AWG		26–12		26–12		
Rated current		500 V		600 V		
Rated voltage		6 kV		300 V		
Rated impulse voltage		3				
Pollution degree		3				
Note		¹⁾ For maintaining the proper isolation distances, the open side of feed-through or ground blocks as well as both sides of a jumper are to be covered by partitions.				

Accessories for *fasis* WKMF 2,5...

	Accessories		Type	Part No.	Std. Pack	
	End plate, 1.5 mm wide		gray	APMF 2,5 /15	07.312.5953.0	10
	Cross connector, insulated		2 pole	IVB WKMF 2,5–2	Z7.260.0229.0	10
			3 pole	IVB WKMF 2,5–3	Z7.260.0329.0	10
			4 pole	IVB WKMF 2,5–4	Z7.260.0429.0	10
			5 pole	IVB WKMF 2,5–5	Z7.260.0529.0	10
			10 pole	IVB WKMF 2,5–10	Z7.260.1029.0	10
			50 pole	IVB WKMF 2,5 M50	Z7.260.0029.0	10
	Screwdriver, uninsulated			DIN 5264 B 0,6x3,5	06.502.4000.0	5
	Screwdriver, uninsulated, MINI			DIN 5264 B 0,6x3,5 M	06.502.5000.0	10

Mini terminal blocks with tension spring connection

Description	Type	Part No.	Std. Pack																																																																		
WKF 2,5/M with flange																																																																					
<ul style="list-style-type: none"> • Feed-through block with tension spring connection with or without flange • Nominal cross section 2.5 mm² 																																																																					
  WKF 2,5/M/F  WKF 2,5/M																																																																					
<table border="1"> <thead> <tr> <th>Description</th> <th>Type</th> <th>Part No.</th> <th colspan="2">Std. Pack</th> </tr> </thead> <tbody> <tr> <td>Feed-through block unmarked, gray</td> <td>WKF 2,5/M</td> <td>37.703.0553.0</td> <td colspan="2">100</td> </tr> <tr> <td>Feed-through block unmarked, blue</td> <td>WKF 2,5/M BLAU</td> <td>37.703.0553.6</td> <td colspan="2">100</td> </tr> <tr> <td>Feed-through block unmarked, orange</td> <td>WKF 2,5/M ORANGE</td> <td>37.703.0553.9</td> <td colspan="2">100</td> </tr> <tr> <td>Feed-through block with flange, gray</td> <td>WKF 2,5/M/F</td> <td>39.703.0153.0</td> <td colspan="2">100</td> </tr> <tr> <td>Feed-through block with flange, blue</td> <td>WKF 2,5/M/F BLAU</td> <td>39.703.0153.6</td> <td colspan="2">100</td> </tr> <tr> <td>Feed-through block with flange, orange</td> <td>WKF 2,5/M/F ORANGE</td> <td>39.703.0153.9</td> <td colspan="2">100</td> </tr> </tbody> </table>					Description	Type	Part No.	Std. Pack		Feed-through block unmarked, gray	WKF 2,5/M	37.703.0553.0	100		Feed-through block unmarked, blue	WKF 2,5/M BLAU	37.703.0553.6	100		Feed-through block unmarked, orange	WKF 2,5/M ORANGE	37.703.0553.9	100		Feed-through block with flange, gray	WKF 2,5/M/F	39.703.0153.0	100		Feed-through block with flange, blue	WKF 2,5/M/F BLAU	39.703.0153.6	100		Feed-through block with flange, orange	WKF 2,5/M/F ORANGE	39.703.0153.9	100																															
Description	Type	Part No.	Std. Pack																																																																		
Feed-through block unmarked, gray	WKF 2,5/M	37.703.0553.0	100																																																																		
Feed-through block unmarked, blue	WKF 2,5/M BLAU	37.703.0553.6	100																																																																		
Feed-through block unmarked, orange	WKF 2,5/M ORANGE	37.703.0553.9	100																																																																		
Feed-through block with flange, gray	WKF 2,5/M/F	39.703.0153.0	100																																																																		
Feed-through block with flange, blue	WKF 2,5/M/F BLAU	39.703.0153.6	100																																																																		
Feed-through block with flange, orange	WKF 2,5/M/F ORANGE	39.703.0153.9	100																																																																		
<table border="1"> <thead> <tr> <th colspan="5">General data</th> </tr> </thead> <tbody> <tr> <td>Width / length / height</td> <td colspan="4">5 mm / 36 mm / 23 mm</td> </tr> <tr> <td>Wire strip length</td> <td colspan="4">11 mm</td> </tr> <tr> <td>Approvals</td> <td colspan="4">    </td> </tr> <tr> <th colspan="2">Technical data</th> <th>IEC</th> <th>UL</th> <th>CSA</th> </tr> <tr> <td colspan="2"></td> <td>EN 60947-7-1</td> <td></td> <td></td> </tr> <tr> <td>Cross section fine-stranded</td> <td colspan="4">0.13 – 2.5 mm²</td> </tr> <tr> <td>Cross section solid/stranded</td> <td colspan="4">0.13 – 4 mm²</td> </tr> <tr> <td>Cross section, AWG</td> <td colspan="2"></td> <td>22 – 12</td> <td>24 – 12</td> </tr> <tr> <td>Rated current</td> <td>24 A</td> <td colspan="2">20 A</td> <td>25 A</td> </tr> <tr> <td>Rated voltage</td> <td>800 V</td> <td colspan="2">600 V</td> <td>600 V</td> </tr> <tr> <td>Rated impulse voltage</td> <td colspan="4">8 kV</td> </tr> <tr> <td>Pollution degree</td> <td colspan="4">3</td> </tr> </tbody> </table>					General data					Width / length / height	5 mm / 36 mm / 23 mm				Wire strip length	11 mm				Approvals	  				Technical data		IEC	UL	CSA			EN 60947-7-1			Cross section fine-stranded	0.13 – 2.5 mm ²				Cross section solid/stranded	0.13 – 4 mm ²				Cross section, AWG			22 – 12	24 – 12	Rated current	24 A	20 A		25 A	Rated voltage	800 V	600 V		600 V	Rated impulse voltage	8 kV				Pollution degree	3			
General data																																																																					
Width / length / height	5 mm / 36 mm / 23 mm																																																																				
Wire strip length	11 mm																																																																				
Approvals	  																																																																				
Technical data		IEC	UL	CSA																																																																	
		EN 60947-7-1																																																																			
Cross section fine-stranded	0.13 – 2.5 mm ²																																																																				
Cross section solid/stranded	0.13 – 4 mm ²																																																																				
Cross section, AWG			22 – 12	24 – 12																																																																	
Rated current	24 A	20 A		25 A																																																																	
Rated voltage	800 V	600 V		600 V																																																																	
Rated impulse voltage	8 kV																																																																				
Pollution degree	3																																																																				

Description	Type	Part No.	Std. Pack																																																																		
WKF 2,5/MD with flange																																																																					
<ul style="list-style-type: none"> • Duo feed-through block with tension spring connection with or without flange • Nominal cross section 2.5 mm² 																																																																					
  WKF 2,5/MD/F  WKF 2,5/MD																																																																					
<table border="1"> <thead> <tr> <th>Description</th> <th>Type</th> <th>Part No.</th> <th colspan="2">Std. Pack</th> </tr> </thead> <tbody> <tr> <td>Duo feed-through block unmarked, gray</td> <td>WKF 2,5/MD</td> <td>37.703.1053.0</td> <td colspan="2">100</td> </tr> <tr> <td>Duo feed-through block unmarked, blue</td> <td>WKF 2,5/MD BLAU</td> <td>37.703.1053.6</td> <td colspan="2">100</td> </tr> <tr> <td>Duo feed-through block unmarked, orange</td> <td>WKF 2,5/MD ORANGE</td> <td>37.703.1053.9</td> <td colspan="2">100</td> </tr> <tr> <td>Duo feed-through block with flange, gray</td> <td>WKF 2,5/MD/F</td> <td>39.703.0253.0</td> <td colspan="2">100</td> </tr> <tr> <td>Duo feed-through block with flange, blue</td> <td>WKF 2,5/MD/F BLAU</td> <td>39.703.0253.6</td> <td colspan="2">100</td> </tr> <tr> <td>Duo feed-through block with flange, orange</td> <td>WKF 2,5/MD/F ORANGE</td> <td>39.703.0253.9</td> <td colspan="2">100</td> </tr> </tbody> </table>					Description	Type	Part No.	Std. Pack		Duo feed-through block unmarked, gray	WKF 2,5/MD	37.703.1053.0	100		Duo feed-through block unmarked, blue	WKF 2,5/MD BLAU	37.703.1053.6	100		Duo feed-through block unmarked, orange	WKF 2,5/MD ORANGE	37.703.1053.9	100		Duo feed-through block with flange, gray	WKF 2,5/MD/F	39.703.0253.0	100		Duo feed-through block with flange, blue	WKF 2,5/MD/F BLAU	39.703.0253.6	100		Duo feed-through block with flange, orange	WKF 2,5/MD/F ORANGE	39.703.0253.9	100																															
Description	Type	Part No.	Std. Pack																																																																		
Duo feed-through block unmarked, gray	WKF 2,5/MD	37.703.1053.0	100																																																																		
Duo feed-through block unmarked, blue	WKF 2,5/MD BLAU	37.703.1053.6	100																																																																		
Duo feed-through block unmarked, orange	WKF 2,5/MD ORANGE	37.703.1053.9	100																																																																		
Duo feed-through block with flange, gray	WKF 2,5/MD/F	39.703.0253.0	100																																																																		
Duo feed-through block with flange, blue	WKF 2,5/MD/F BLAU	39.703.0253.6	100																																																																		
Duo feed-through block with flange, orange	WKF 2,5/MD/F ORANGE	39.703.0253.9	100																																																																		
<table border="1"> <thead> <tr> <th colspan="5">General data</th> </tr> </thead> <tbody> <tr> <td>Width / length / height</td> <td colspan="4">10 mm / 36 mm / 23 mm</td> </tr> <tr> <td>Wire strip length</td> <td colspan="4">11 mm</td> </tr> <tr> <td>Approvals</td> <td colspan="4">    </td> </tr> <tr> <th colspan="2">Technical data</th> <th>IEC</th> <th>UL</th> <th>CSA</th> </tr> <tr> <td colspan="2"></td> <td>EN 60947-7-1</td> <td></td> <td></td> </tr> <tr> <td>Cross section fine-stranded</td> <td colspan="4">0.13 – 2.5 mm²</td> </tr> <tr> <td>Cross section solid/stranded</td> <td colspan="4">0.13 – 4 mm²</td> </tr> <tr> <td>Cross section, AWG</td> <td colspan="2"></td> <td>22 – 12</td> <td>24 – 12</td> </tr> <tr> <td>Rated current</td> <td>24 A</td> <td colspan="2">20 A</td> <td>25 A</td> </tr> <tr> <td>Rated voltage</td> <td>800 V</td> <td colspan="2">600 V</td> <td>600 V</td> </tr> <tr> <td>Rated impulse voltage</td> <td colspan="4">8 kV</td> </tr> <tr> <td>Pollution degree</td> <td colspan="4">3</td> </tr> </tbody> </table>					General data					Width / length / height	10 mm / 36 mm / 23 mm				Wire strip length	11 mm				Approvals	  				Technical data		IEC	UL	CSA			EN 60947-7-1			Cross section fine-stranded	0.13 – 2.5 mm ²				Cross section solid/stranded	0.13 – 4 mm ²				Cross section, AWG			22 – 12	24 – 12	Rated current	24 A	20 A		25 A	Rated voltage	800 V	600 V		600 V	Rated impulse voltage	8 kV				Pollution degree	3			
General data																																																																					
Width / length / height	10 mm / 36 mm / 23 mm																																																																				
Wire strip length	11 mm																																																																				
Approvals	  																																																																				
Technical data		IEC	UL	CSA																																																																	
		EN 60947-7-1																																																																			
Cross section fine-stranded	0.13 – 2.5 mm ²																																																																				
Cross section solid/stranded	0.13 – 4 mm ²																																																																				
Cross section, AWG			22 – 12	24 – 12																																																																	
Rated current	24 A	20 A		25 A																																																																	
Rated voltage	800 V	600 V		600 V																																																																	
Rated impulse voltage	8 kV																																																																				
Pollution degree	3																																																																				

Accessories for *fasis* WKF 2,5/M...

Accessories	Type	Part No.	Std. Pack
End plate with flange on the right	gray	APF 2,5/M.../F/R	07.312.3153.0
End plate with flange on the right	blue	APF 2,5/M.../F/R BLAU	07.312.3153.6
End plate with flange on the right	orange	APF 2,5/M.../F/R ORANGE	07.312.3153.9
Wire entry guide	0.13 – 0.2 mm ²	LEL 2,5/1 WEISS	05.561.6553.0
Wire entry guide	0.25 – 0.5 mm ²	LEL 2,5/2 GRAU	05.561.6653.0
Wire entry guide	0.75 – 1.0 mm ²	LEL 2,5/3 SCHWARZ	05.561.6753.0
Cross connector, insulated	2 pole		05.902.3500.0
Marking strip, unmarked	(4 x 22 pcs.)		04.244.0053.0
Marking strip, marked	(1 – 11)		04.844.2053.0
Marking strip, marked	(12 – 55)		04.844.2153.0
Marking strip, marked	(56 – 99)		04.844.2253.0
Screwdriver, uninsulated	DIN 5264 B 0,6 x 3,5		06.502.4000.0

WKF 2,5/M/R with mounting foot

- Feed-through block with tension spring connection, unmarked
- Nominal cross section 2.5 mm²



Mounting hole: Ø 3,5 mm
Plate thickness: 0,6–1,2 mm

Description	Type	Part No.	Std. Pack
Feed-through block unmarked, gray	WKF 2,5/M/R	38.703.0553.0	100
Feed-through block unmarked, blue	WKF 2,5/M/R BLAU	38.703.0553.6	100
Feed-through block unmarked, orange	WKF 2,5/M/R ORANGE	38.703.0553.9	100
General data			
Width / length / height	5 mm / 36 mm / 23 mm		
Wire strip length	11 mm		
Approvals			
Technical data	IEC	UL	CSA
	EN 60947-7-1		
Cross section fine-stranded	0.13 – 2.5 mm ²		
Cross section solid/stranded	0.13 – 4 mm ²		
Cross section, AWG		22 – 12	24 – 12
Rated current	24 A	20 A	25 A
Rated voltage	800 V	600 V	600 V
Rated impulse voltage	8 kV		
Pollution degree	3		

WKF 2,5/MD/R with mounting foot

- Duo feed-through block with tension spring connection, unmarked
- Nominal cross section 2.5 mm²



Mounting hole: Ø 3,5 mm
Plate thickness: 0,6–1,2 mm

Description	Type	Part No.	Std. Pack
Duo feed-through block unmarked, gray	WKF 2,5/MD/R	38.703.1053.0	100
Duo feed-through block unmarked, blue	WKF 2,5/MD/R BLAU	38.703.1053.6	100
Duo feed-through block unmarked, orange	WKF 2,5/MD/R ORANGE	38.703.1053.9	100
General data			
Width / length / height	10 mm / 36 mm / 23 mm		
Wire strip length	11 mm		
Approvals			
Technical data	IEC	UL	CSA
	EN 60947-7-1		
Cross section fine-stranded	0.13 – 2.5 mm ²		
Cross section solid/stranded	0.13 – 4 mm ²		
Cross section, AWG		22 – 12	24 – 12
Rated current	24 A	20 A	25 A
Rated voltage	800 V	600 V	600 V
Rated impulse voltage	8 kV		
Pollution degree	3		

Accessories for *fasis* WKF 2,5/M.../R

Accessories	Type	Part No.	Std. Pack
End plate	gray	APF 2,5/M...	07.312.2953.0
End plate	blue	APF 2,5/M... BLAU	07.312.2953.6
End plate	orange	APF 2,5/M... ORANGE	07.312.2953.9
Wire entry guide	0.13–0.2 mm ²	LEL 2,5/1 WEISS	05.561.6553.0
Wire entry guide	0.25–0.5 mm ²	LEL 2,5/2 GRAU	05.561.6653.0
Wire entry guide	0.75–1.0 mm ²	LEL 2,5/3 SCHWARZ	05.561.6753.0
Cross connector, insulated	2 pole		05.902.3500.0
Marking strip, unmarked	(4 x 22 pcs.)		04.244.0053.0
	marked (1–11)		04.844.2053.0
	marked (12–55)		04.844.2153.0
	marked (56–99)		04.844.2253.0
Screwdriver, uninsulated	DIN 5264 B 0,6 x 3,5		06.502.4000.0

Mini terminal blocks with tension spring connection

Description	Type	Part No.	Std. Pack
Feed-through block unmarked, blue	WKF 2,5/M/15 BLAU	55.703.0553.6	100
Feed-through block unmarked, orange	WKF 2,5/M/15 ORANGE	55.703.0553.9	100
Feed-through block unmarked, green	WKF 2,5/M/15 GRÜN	55.703.0553.7	100

General data			
Width / length / height, incl. TS 5.5	5 mm / 36 mm / 27 mm		
Wire strip length	11 mm		
Approvals			
Technical data	IEC	UL	CSA
	EN 60947-7-1		
Cross section fine-stranded	0.13 – 2.5 mm ²		
Cross section solid/stranded	0.13 – 4 mm ²		
Cross section, AWG		22 – 12	24 – 12
Rated current	24 A	20 A	25 A
Rated voltage	800 V	600 V	600 V
Rated impulse voltage	8 kV		
Pollution degree	3		

WKF 2,5/M/15

- Feed-through block with tension spring connection, unmarked, for mounting on TS 15
- Nominal cross section 2.5 mm²



WKF 2,5/MD/15

- Duo feed-through block with tension spring connection, unmarked, for mounting on TS 15
- Nominal cross section 2.5 mm²



Description	Type	Part No.	Std. Pack
Duo feed-through block unmarked, gray	WKF 2,5/MD/15	55.703.1053.0	100
Duo feed-through block unmarked, blue	WKF 2,5/MD/15 BLAU	55.703.1053.6	100
Duo feed-through block unmarked, orange	WKF 2,5/MD/15 ORANGE	55.703.1053.9	100
Duo feed-through block unmarked, green	WKF 2,5/MD/15 GRÜN	55.703.1053.7	100

General data			
Width / length / height, incl. TS 5.5	10 mm / 36 mm / 27 mm		
Wire strip length	11 mm		
Approvals			
Technical data	IEC	UL	CSA
	EN 60947-7-1		
Cross section fine-stranded	0.13 – 2.5 mm ²		
Cross section solid/stranded	0.13 – 4 mm ²		
Cross section, AWG		22 – 12	24 – 12
Rated current	24 A	20 A	25 A
Rated voltage	800 V	600 V	600 V
Rated impulse voltage	8 kV		
Pollution degree	3		

WKF 2,5/M/35

- Feed-through block with tension spring connection, unmarked, for mounting on TS 35
- Nominal cross section 2.5 mm²



Description	Type	Part No.	Std. Pack
Feed-through block unmarked, gray	WKF 2,5/M/35	56.703.0553.0	100
Feed-through block unmarked, blue	WKF 2,5/M/35 BLAU	56.703.0553.6	100
Feed-through block unmarked, orange	WKF 2,5/M/35 ORANGE	56.703.0553.9	100
Feed-through block unmarked, green	WKF 2,5/M/35 GRÜN	56.703.0553.7	100

General data				
Width / length / height, incl. TS 7.5	5 mm / 36 mm / 32 mm			
Wire strip length	11 mm			
Approvals				
Technical data		IEC	UL	CSA
	EN 60947-7-1			
Cross section fine-stranded	0.13 – 2.5 mm ²			
Cross section solid/stranded	0.13 – 4 mm ²			
Cross section, AWG		22 – 12	24 – 12	
Rated current	24 A	20 A	25 A	
Rated voltage	800 V	600 V	600 V	
Rated impulse voltage	8 kV			
Pollution degree	3			

WKF 2,5/MD/35

- Duo-Feed-through block with tension spring connection, unmarked, for mounting on TS 35
- Nominal cross section 2.5 mm²



Description	Type	Part No.	Std. Pack
Duo-Feed-through block unmarked, gray	WKF 2,5/MD/35	56.703.1053.0	100
Duo-Feed-through block unmarked, blue	WKF 2,5/MD/35 BLAU	56.703.1053.6	100
Duo-Feed-through block unmarked, orange	WKF 2,5/MD/35 ORANGE	56.703.1053.9	100
Duo-Feed-through block unmarked, green	WKF 2,5/MD/35 GRÜN	56.703.1053.7	100

General data				
Width / length / height, incl. TS 7.5	10 mm / 36 mm / 32 mm			
Wire strip length	11 mm			
Approvals				
Technical data		IEC	UL	CSA
	EN 60947-7-1			
Cross section fine-stranded	0.13 – 2.5 mm ²			
Cross section solid/stranded	0.13 – 4 mm ²			
Cross section, AWG		22 – 12	24 – 12	
Rated current	24 A	20 A	25 A	
Rated voltage	800 V	600 V	600 V	
Rated impulse voltage	8 kV			
Pollution degree	3			

Accessories for fasis WKF 2,5/M/...

Accessories	Type	Part No.	Std. Pack	
End plate	gray	APF 2,5/M...	07.312.2953.0	10
End plate	blue	APF 2,5/M... BLAU	07.312.2953.6	10
End plate	orange	APF 2,5/M... ORANGE	07.312.2953.9	10
Wire entry guide	0.13–0.2 mm ²	LEL 2,5/1 WEISS	05.561.6553.0	100
Wire entry guide	0.25–0.5 mm ²	LEL 2,5/2 GRAU	05.561.6653.0	100
Wire entry guide	0.75–1.0 mm ²	LEL 2,5/3 SCHWARZ	05.561.6753.0	100
Cross connector, insulated	2 pole		05.902.3500.0	10
Marking strip, unmarked	(4 x 22 pcs.)		04.244.0053.0	5
	marked (1–11)		04.844.2053.0	5
	marked (12–55)		04.844.2153.0	5
	marked (56–99)		04.844.2253.0	5
	yellow, unmarked		04.244.0053.8	5
Screwdriver, uninsulated	DIN 5264 B 0,6 x 3,5		06.502.4000.0	5

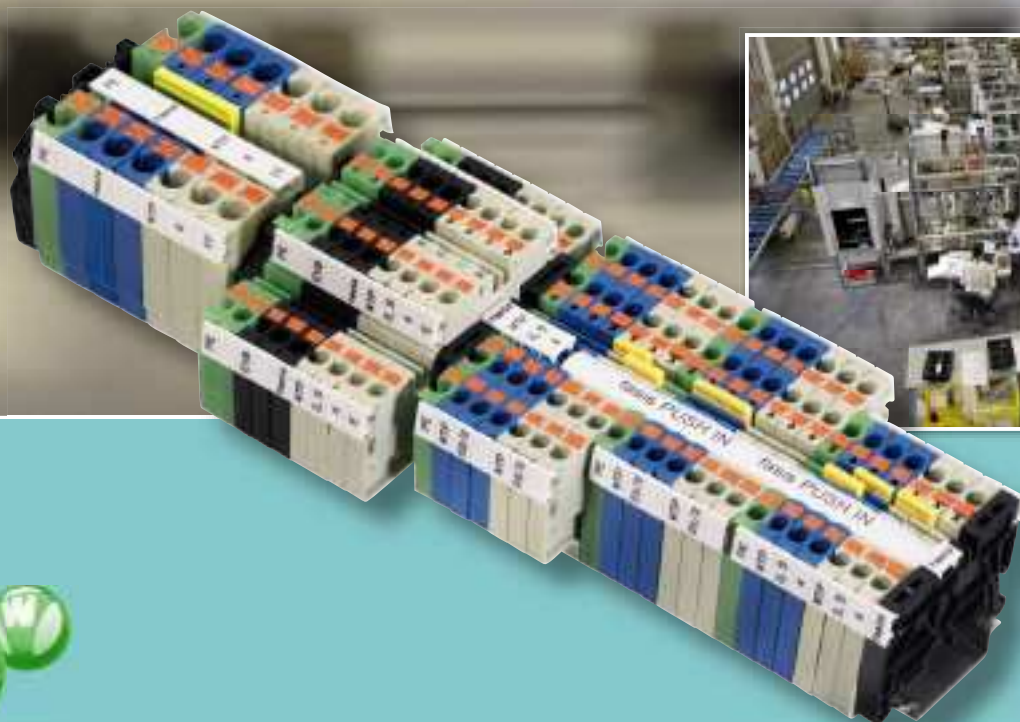

fasis WTP – DIN rail terminal blocks with **push-in connection**

Terminate wires easily, directly and without tools!

fasis WTP – DIN rail terminal blocks with push-in connection. Built according to an effective and comprehensive concept, including compact design and high-performance contact technology, **fasis** WTP reduces installation time and keeps inventory costs to a minimum.

The product line includes feed-through and ground blocks with 2, 3 or 4 termination points, as well as multi-tier blocks.

fasis WTP has been designed for use in machinery and plant engineering, as well as power distribution for buildings.

Connection cross-sections up to 10 mm²

Rated current of up to 57 A

Rated voltage of up to 1000 V

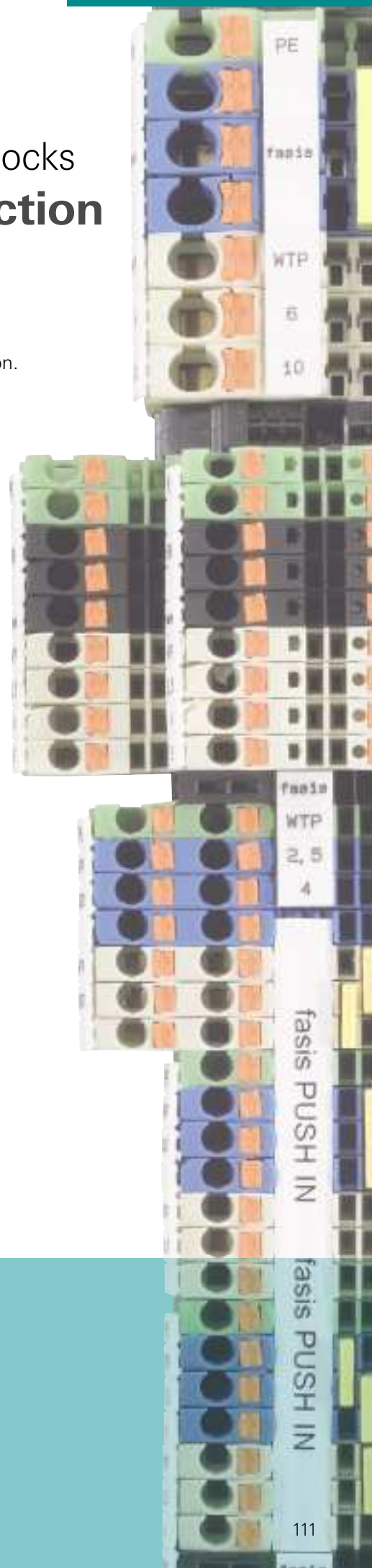
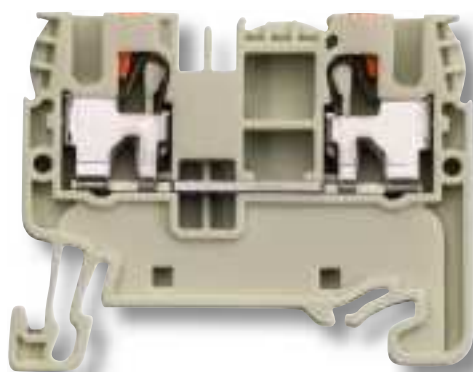

fasis WTP – wires simply push-in

Connect without tools

- Push-in connection
- Wires connect directly



The same functionality – fewer items

- 2.5 & 4 mm² and 6 & 10 mm² in one block

fasis push-in				
Nominal cross section	2.5 mm ²	4 mm ²	6 mm ²	10 mm ²
Rated current		32 A		57 A
Width	5 mm		8 mm	
	⇩		⇩	
	WTP 2,5/4		WTP 6/10	

Integrated release lever

- No mix-up of wire-entry and screwdriver entry points
- No contact with live parts
- Use of Philips head screwdriver also possible

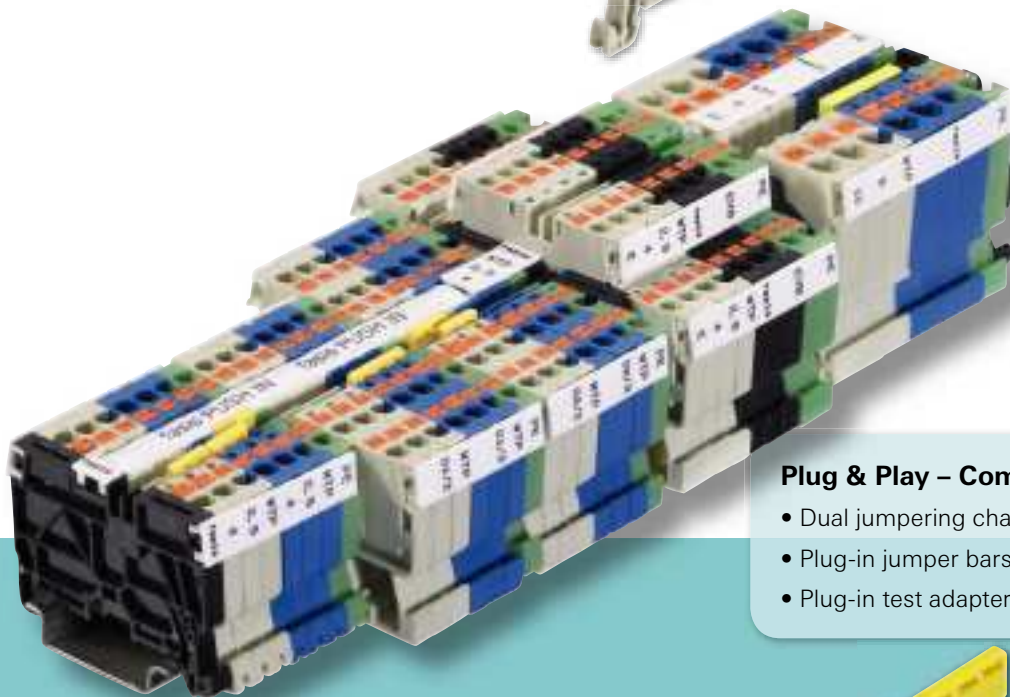
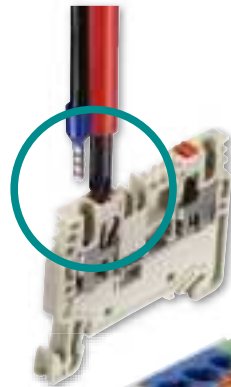

Plug & Play – Completing the Concept

- Dual jumpering channels
- Plug-in jumper bars
- Plug-in test adapter

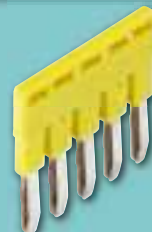

Wieland jumpering system – Perfect technology

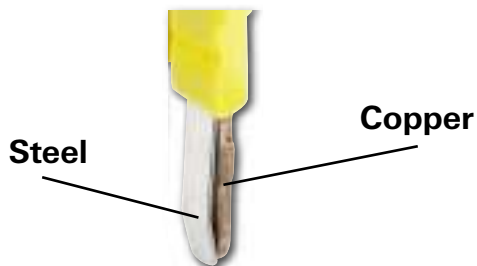
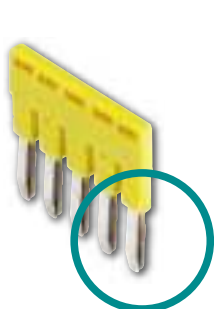

Perfect technology

- Copper current bar guarantees low contact resistance
- Steel spring guarantees strength, durability, and long-term stability

Extremely rugged!

- Indestructible steel spring
- Vibration-proof connection



Simple customization

- Individual poles easy to remove
- Circuits easy to identify

Wieland marking system – Reliable identification

Marking strips – Dependable

- Maximum hold to the terminal
- Solidify integrity of the assembly



Endless strip – Effective

- Mounting facility for endless strips permits single step marking of entire assembly
- Continuous labeling
- Uses commercially available labeling systems



Marking tags – Individual

- Individual labeling with minimum effort
- Ideal for service and maintenance



Feed-through blocks with push-in connection

WTP 2,5/4

- Feed-through block with push-in connection for mounting on TS 35
- Nominal cross section 4 mm²

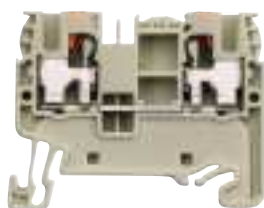

Description	Type	Part No.	Std. Pack
Feed-through block, gray	WTP 2,5/4	56.203.0055.0	100
Feed-through block, blue	WTP 2,5/4 BLAU	56.203.0055.6	100
General data			
Width / length / height, incl. TS 7.5	5 mm / 47 mm / 38 mm		
Wire strip length	11 mm		
Approvals	pending		
Technical data	IEC	UL	CSA
	EN 60 947-7-1		
Cross section fine-stranded	0.2–4 mm ²		
Cross section solid/stranded	0.2–4 mm ²		
Cross section, AWG	24–12	24–12	
Rated current	32 A	30 A	30 A
Rated voltage	1000 V	600 V	600 V
Rated impulse voltage	8 kV		
Pollution degree	3		
Accessories			
	Type	Part No.	Std. Pack
End plate, gray	APFN 2,5	07.312.6755.0	10
Partition, gray	TWFN 2,5	07.312.6855.0	10

WTP 2,5/4 D1/2

- Duo feed-through block with push-in connection for mounting on TS 35
- Nominal cross section 4 mm²

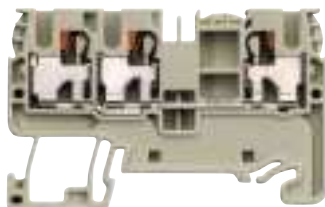

Description	Type	Part No.	Std. Pack
Feed-through block, gray	WTP 2,5/4 D1/2	56.203.5055.0	100
Feed-through block, blue	WTP 2,5/4 D1/2 BLAU	56.203.5055.6	100
General data			
Width / length / height, incl. TS 7.5	5 mm / 60 mm / 38 mm		
Wire strip length	11 mm		
Approvals	pending		
Technical data	IEC	UL	CSA
	EN 60 947-7-1		
Cross section fine-stranded	0.2–4 mm ²		
Cross section solid/stranded	0.2–4 mm ²		
Cross section, AWG	24–12	24–12	
Rated current	32 A	30 A	30 A
Rated voltage	1000 V	600 V	600 V
Rated impulse voltage	8 kV		
Pollution degree	3		
Accessories			
	Type	Part No.	Std. Pack
End plate, gray	APFN 2,5 D1/2	07.312.6955.0	10
Partition, gray	TWFN 2,5 D1/2	07.312.7055.0	10



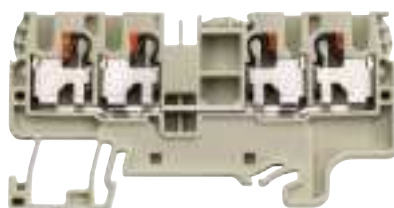

WTP 2,5/4 D2/2

- Duo feed-through block with push-in connection for mounting on TS 35
- Nominal cross section 4 mm²

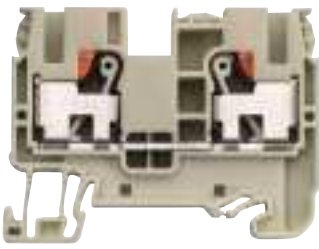

Description	Type	Part No.	Std. Pack
Feed-through block, gray	WTP 2,5/4 D2/2	56.203.5155.0	100
Feed-through block, blue	WTP 2,5/4 D2/2 BLAU	56.203.5155.6	100
General data			
Width / length / height, incl. TS 7.5	5 mm / 72 mm / 38 mm		
Wire strip length	11 mm		
Approvals	pending		
Technical data	IEC	UL	CSA
	EN 60 947-7-1		
Cross section fine-stranded	0.2–4 mm ²		
Cross section solid/stranded	0.2–4 mm ²		
Cross section, AWG	24–12	24–12	
Rated current	32 A	30 A	30 A
Rated voltage	1000 V	600 V	600 V
Rated impulse voltage	8 kV		
Pollution degree	3		
Accessories			
	Type	Part No.	Std. Pack
End plate, gray	APFN 2,5 D2/2	07.312.7155.0	10
Partition, gray	TWFN 2,5 D2/2	07.312.7255.0	10

Feed-through blocks with push-in connection

WTP 6/10		Description	Type	Part No.	Std. Pack
<ul style="list-style-type: none"> • Feed-through block with push-in connection for mounting on TS 35 • Nominal cross section 10 mm² 		Feed-through block, gray	WTP 6/10	56.206.0055.0	100
		Feed-through block, blue	WTP 6/10 BLAU	56.206.0055.6	100
General data					
Width / length / height, incl. TS 7.5		8 mm / 58 mm / 44 mm			
Wire strip length		12 mm			
Approvals		    pending			
Technical data					
		IEC	UL	CSA	
		EN 60 947-7-1			
Cross section fine-stranded		0,2–10 mm ²			
Cross section solid/stranded		0.2–10 mm ²			
Cross section, AWG		22–8		22–8	
Rated current		57 A		50 A	
Rated voltage		1000 V		600 V	
Rated impulse voltage		8 kV			
Pollution degree		3			
Accessories					
		Type		Part No.	Std. Pack
End plate, gray			AP WTP 6/10	07.313.4155.0	10
Partition, gray			TW WTP 6/10	07.313.4255.0	10

Accessories for *fasis* WTP...

Accessories for WTP 2,5/4...		Type	Part No.	Std. Pack	
	Cross connector, insulated	2 pole	IVB WKF 2,5–2	Z7.280.6227.0	10
		3 pole	IVB WKF 2,5–3	Z7.280.6327.0	10
		4 pole	IVB WKF 2,5–4	Z7.280.6427.0	10
		5 pole	IVB WKF 2,5–5	Z7.280.6527.0	10
		6 pole	IVB WKF 2,5–6	Z7.280.6627.0	10
		7 pole	IVB WKF 2,5–7	Z7.280.6727.0	20
		8 pole	IVB WKF 2,5–8	Z7.280.6827.0	20
		9 pole	IVB WKF 2,5–9	Z7.280.6927.0	20
		10 pole	IVB WKF 2,5–10	Z7.280.7027.0	20
		20 pole	IVB WKF 2,5–20	Z7.280.8027.0	20
	Wire entry guide	0.13–0.2 mm ²	LELN 2,5/1 WEISS	05.564.3755.0	100
	0.25–0.5 mm ²	LELN 2,5/2 GRAU	05.564.3855.0	100	
	0.75–1.0 mm ²	LELN 2,5/3 SCHWARZ	05.564.3955.0	100	
Test adapter, modular		PS WKC/F	Z1.299.9753.0	10	
Test plug		ST 2/2,3	Z5.553.2921.0	10	
Screwdriver, uninsulated		DIN 5264 B 0,6x3,5	06.502.4000.0	5	
Screwdriver, uninsulated, MINI		DIN 5264 B 0,6x3,5 M	06.502.5000.0	10	
Accessories for WTP 6/10...					
	Cross connector, insulated	2 pole	IVB WKFN 6–2	Z7.282.5227.0	10
		3 pole	IVB WKFN 6–3	Z7.282.5327.0	10
		4 pole	IVB WKFN 6–4	Z7.282.5427.0	10
		5 pole	IVB WKFN 6–5	Z7.282.5527.0	10
		10 pole	IVB WKFN 6–10	Z7.282.6027.0	10
	Test plug		ST 2/2,3	Z5.553.2921.0	10
Screwdriver, uninsulated		DIN 5264 B 0,8x4	06.502.4100.0	5	

Ground blocks with push-in connection

WTP 2,5/4 PE

- Ground block with push-in connection for mounting on TS 35
- Nominal cross section 4 mm²



Description	Type	Part No.	Std. Pack
Ground block, green/yellow	WTP 2,5/4 PE	56.203.9055.0	100
General data			
Width / length / height, incl. TS 7.5	5 mm / 47 mm / 38 mm		
Wire strip length	11 mm		
Approvals	pending		
Technical data	IEC	UL	CSA
	EN 60 947-7-2		
Cross section fine-stranded	0.2–4 mm ²		
Cross section solid/stranded	0.2–4 mm ²		
Cross section, AWG		24–12	24–12
Rated current			
Rated voltage	1000 V	600 V	600 V
Rated impulse voltage	8 kV		
Pollution degree	3		
Accessories			
	Type	Part No.	Std. Pack
End plate, gray	APFN 2,5	07.312.6755.0	10
Partition, gray	TWFN 2,5	07.312.6855.0	10

WTP 2,5/4 D1/2/PE

- Duo ground block with push-in connection for mounting on TS 35
- Nominal cross section 4 mm²

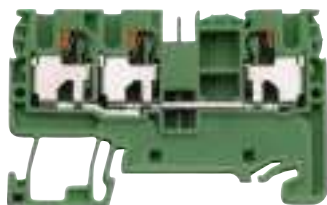

Description	Type	Part No.	Std. Pack
Ground block, green/yellow	WTP 2,5/4 D1/2/PE	56.203.9355.0	100
General data			
Width / length / height, incl. TS 7.5	5 mm / 60 mm / 38 mm		
Wire strip length	11 mm		
Approvals	pending		
Technical data	IEC	UL	CSA
	EN 60 947-7-2		
Cross section fine-stranded	0.2–4 mm ²		
Cross section solid/stranded	0.2–4 mm ²		
Cross section, AWG		24–12	24–12
Rated current			
Rated voltage	1000 V	600 V	600 V
Rated impulse voltage	8 kV		
Pollution degree	3		
Accessories			
	Type	Part No.	Std. Pack
End plate, gray	APFN 2,5 D1/2	07.312.6955.0	10
Partition, gray	TWFN 2,5 D1/2	07.312.7055.0	10

WTP 2,5/4 D2/2/PE

- Duo ground block with push-in connection for mounting on TS 35
- Nominal cross section 4 mm²

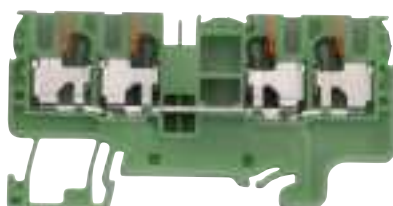

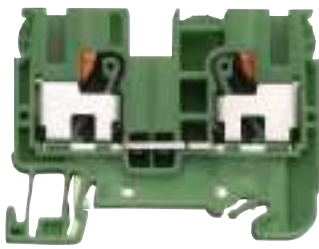
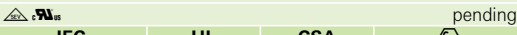

Description	Type	Part No.	Std. Pack
Ground block, green/yellow	WTP 2,5/4 D2/2/PE	56.203.9155.0	100
General data			
Width / length / height, incl. TS 7.5	5 mm / 72 mm / 38 mm		
Wire strip length	11 mm		
Approvals	pending		
Technical data	IEC	UL	CSA
	EN 60 947-7-2		
Cross section fine-stranded	0.2–4 mm ²		
Cross section solid/stranded	0.2–4 mm ²		
Cross section, AWG		24–12	24–12
Rated current			
Rated voltage	1000 V	600 V	600 V
Rated impulse voltage	8 kV		
Pollution degree	3		
Accessories			
	Type	Part No.	Std. Pack
End plate, gray	APFN 2,5 D2/2	07.312.7155.0	10
Partition, gray	TWFN 2,5 D2/2	07.312.7255.0	10

Ground blocks with push-in connection

WTP 6/10 PE		Description	Type	Part No.	Std. Pack		
<p>• Ground block with push-in connection for mounting on TS 35</p> <p>• Nominal cross section 10 mm²</p> 		Ground block, green/yellow	WTP 6/10 PE	56.206.9055.0	100		
		General data					
		Width / length / height, incl. TS 7.5	8 mm / 58 mm / 44 mm				
		Wire strip length	12 mm				
		Approvals	 pending				
		Technical data		IEC	UL	CSA	Ex
			EN 60 947-7-2				
		Cross section fine-stranded	0.2–10 mm ²				
		Cross section solid/stranded	0.2–10 mm ²				
		Cross section, AWG			22–8	22–8	
		Rated current					
		Rated voltage	1000 V	600 V	600 V		
		Rated impulse voltage	8 kV				
Pollution degree	3						
Accessories		Type	Part No.	Std. Pack			
End plate, gray		AP WTP 6/10	07.313.4155.0	10			
Partition, gray		TW WTP 6/10	07.313.4255.0	10			

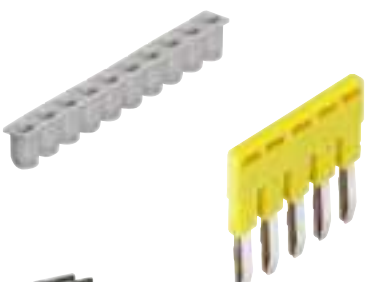
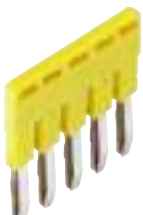
Accessories for *fasis* WTP...





Accessories for WTP 2,5/4...		Type	Part No.	Std. Pack	
	Cross connector, insulated	2 pole	IVB WKF 2,5–2	Z7.280.6227.0	10
		3 pole	IVB WKF 2,5–3	Z7.280.6327.0	10
		4 pole	IVB WKF 2,5–4	Z7.280.6427.0	10
		5 pole	IVB WKF 2,5–5	Z7.280.6527.0	10
		6 pole	IVB WKF 2,5–6	Z7.280.6627.0	10
		7 pole	IVB WKF 2,5–7	Z7.280.6727.0	20
		8 pole	IVB WKF 2,5–8	Z7.280.6827.0	20
		9 pole	IVB WKF 2,5–9	Z7.280.6927.0	20
		10 pole	IVB WKF 2,5–10	Z7.280.7027.0	20
		20 pole	IVB WKF 2,5–20	Z7.280.8027.0	20
		Wire entry guide	0.13–0.2 mm ²	LELN 2,5/1 WEISS	05.564.3755.0
		0.25–0.5 mm ²	LELN 2,5/2 GRAU	05.564.3855.0	100
		0.75–1.0 mm ²	LELN 2,5/3 SCHWARZ	05.564.3955.0	100
Test adapter, modular			PS WKC/F	Z1.299.9753.0	10
Test plug			ST 2/2,3	Z5.553.2921.0	10
Screwdriver, uninsulated			DIN 5264 B 0,6x3,5	06.502.4000.0	5
Screwdriver, uninsulated, MINI			DIN 5264 B 0,6x3,5 M	06.502.5000.0	10
Accessories for WTP 6/10...		Type	Part No.	Std. Pack	
	Cross connector, insulated	2 pole	IVB WKFN 6–2	Z7.282.5227.0	10
		3 pole	IVB WKFN 6–3	Z7.282.5327.0	10
		4 pole	IVB WKFN 6–4	Z7.282.5427.0	10
		5 pole	IVB WKFN 6–5	Z7.282.5527.0	10
		10 pole	IVB WKFN 6–10	Z7.282.6027.0	10
	Test plug			ST 2/2,3	Z5.553.2921.0
Screwdriver, uninsulated			DIN 5264 B 0,8x4	06.502.4100.0	5

Multi-tier blocks with push-in connection

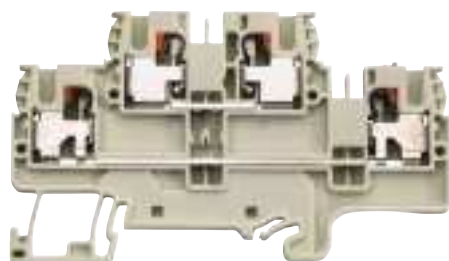
WTP 2,5/4 E

- Multi-tier block with push-in connection for mounting on TS 35
- Nominal cross section 4 mm²





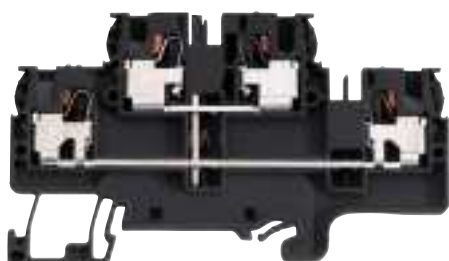

Description	Type	Part No.	Std. Pack
Multi-tier block, gray	WTP 2,5/4 E	56.203.7055.0	100
General data			
Width / length / height, incl. TS 7.5	5 mm / 82 mm / 48 mm		
Wire strip length	11 mm		
Approvals	    pending		
Technical data			
	IEC	UL	CSA
	EN 60 947-7-1		
Cross section fine-stranded	0.2–4 mm ²		
Cross section solid/stranded	0.2–4 mm ²		
Cross section, AWG		24–12	24–12
Rated current	24 A	20 A	20 A
Rated voltage	500 V	300 V	300 V
Rated impulse voltage	6 kV		
Pollution degree	3		
Accessories			
	Type	Part No.	Std. Pack
End plate, gray	APFN 2,5 E	07.312.7355.0	10
Partition, gray	TWFN 2,5 E	07.312.7455.0	10
Marking tag carrier, 2-fold	BT 5/2	04.243.0855.0	100

WTP 2,5/4 E VB

- Multi-tier block, vertically connected, with push-in connection for mounting on TS 35
- Nominal cross section 4 mm²





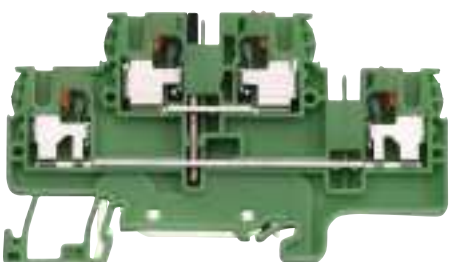

Description	Type	Part No.	Std. Pack
Multi-tier block, black	WTP 2,5/4 E VB	56.203.6955.1	100
General data			
Width / length / height, incl. TS 7.5	5 mm / 82 mm / 48 mm		
Wire strip length	11 mm		
Approvals	    pending		
Technical data			
	IEC	UL	CSA
	EN 60 947-7-2		
Cross section fine-stranded	0.2–4 mm ²		
Cross section solid/stranded	0.2–4 mm ²		
Cross section, AWG		24–12	24–12
Rated current	24 A	20 A	20 A
Rated voltage	500 V	600 V	600 V
Rated impulse voltage	6 kV		
Pollution degree	3		
Accessories			
	Type	Part No.	Std. Pack
End plate, gray	APFN 2,5 E	07.312.7355.0	10
Partition, gray	TWFN 2,5 E	07.312.7455.0	10
Marking tag carrier, 2-fold	BT 5/2	04.243.0855.0	100

WTP 2,5/4 E PE

- Multi-tier ground block with push-in connection for mounting on TS 35
- Nominal cross section 4 mm²



Description	Type	Part No.	Std. Pack
Multi-tier ground block, green/yellow	WTP 2,5/4 E PE	56.203.8955.0	100
General data			
Width / length / height, incl. TS 7.5	5 mm / 82 mm / 48 mm		
Wire strip length	11 mm		
Approvals	    pending		
Technical data			
	IEC	UL	CSA
	EN 60 947-7-2		
Cross section fine-stranded	0.2–4 mm ²		
Cross section solid/stranded	0.2–4 mm ²		
Cross section, AWG		24–12	24–12
Rated current			
Rated voltage	500 V	600 V	600 V
Rated impulse voltage	6 kV		
Pollution degree	3		
Accessories			
	Type	Part No.	Std. Pack
End plate, gray	APFN 2,5 E	07.312.7355.0	10

Accessories for *fasis* WTP 2,5/4...

Accessories		Type	Part No.	Std. Pack	
	Cross connector, insulated	2 pole	IVB WKF 2,5-2	Z7.280.6227.0	10
		3 pole	IVB WKF 2,5-3	Z7.280.6327.0	10
		4 pole	IVB WKF 2,5-4	Z7.280.6427.0	10
		5 pole	IVB WKF 2,5-5	Z7.280.6527.0	10
		6 pole	IVB WKF 2,5-6	Z7.280.6627.0	10
		7 pole	IVB WKF 2,5-7	Z7.280.6727.0	20
		8 pole	IVB WKF 2,5-8	Z7.280.6827.0	20
		9 pole	IVB WKF 2,5-9	Z7.280.6927.0	20
		10 pole	IVB WKF 2,5-10	Z7.280.7027.0	20
		20 pole	IVB WKF 2,5-20	Z7.280.8027.0	20
	Vertical cross connector, insulated		IVB WKF V	Z7.261.1127.0	20
Wire entry guide	0.13-0.2 mm ²		LELN 2,5/1 WEISS	05.564.3755.0	100
	0.25-0.5 mm ²		LELN 2,5/2 GRAU	05.564.3855.0	100
	0.75-1.0 mm ²		LELN 2,5/3 SCHWARZ	05.564.3955.0	100
Test adapter, modular			PS WKC/F	Z1.299.9753.0	10
Test plug			ST 2/2,3	Z5.553.2921.0	10
Screwdriver, uninsulated			DIN 5264 B 0,6x3,5	06.502.4000.0	5
Screwdriver, uninsulated, MINI			DIN 5264 B 0,6x3,5 M	06.502.5000.0	10

Accessories



Software



Service



Accessories and Service

To complement our products, we offer a comprehensive portfolio of accessories and services for terminal blocks.

Wieland offers a variety of product-specific accessories for its terminal blocks, for example covers and isolating plates as well as assembly materials such as mounting rails or tools for working with our products.

Marking solutions such as **wieplot** and **wiemarc** for DIN rail terminal blocks and other components in the control cabinet, the planning software **wieplan** for design of rail assemblies, and our value-add service for rail assemblies, all make working with Wieland DIN rail terminal blocks effortless, and achieve a true added value.



Shielded cable terminals, type SKN



With the SKN shielding connection clamps for our rail terminal blocks, we offer the ability to connect shielded cables and wires in the control cabinet to the grounding system in a safe and easy manner.



Application

- Mounting directly in front of the terminal blocks through use of a rail holder that attaches to the mounting rail
- Mounting on insulated rail holders independent of the DIN mounting rail, inside the control cabinet

The system

- Easy and secure contact without damaging the shield
- Stainless spring steel compression clamp ensures continuous and consistent contact
- High corrosion resistance of contact parts
- Spring clamping yoke available in various sizes
- Plastic rail holder for insulated rail mounting





SKN...

- Shielded cable terminals
- Material: nickel-plated brass

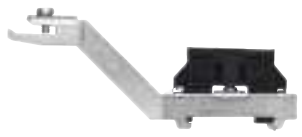

Description	Type	Part No.	Std. Pack
Shielded cable terminals	SKN1,5-6,5	Z2.803.1328.0	10
Shielded cable terminals	SKN5-11	Z2.803.1428.0	10
Shielded cable terminals	SKN10-17	Z2.803.1528.0	10
Shielded cable terminals	SKN16-24	Z2.803.1628.0	10

Type (shielded cable diameter)	Clamping	B	L	H _{max}
SKN1,5-6,5	8-13 N	10 mm	25 mm	33,5 mm
SKN5-11	22-31 N	17 mm	25 mm	41 mm
SKN10-17	32-58 N	23 mm	25 mm	57 mm
SKN16-24	37-53 N	30 mm	25 mm	71 mm

Busbar support		Accessories		Type	Part No.	Std. Pack
<ul style="list-style-type: none"> • Tin-plated steel 		WE SH 1/35	Busbar support (one-sided), tin-plated steel	WE SH 1/35	Z5.515.3310.0	20
		WE SH 2/35	Busbar support (two-sided), tin-plated steel	WE SH 2/35	Z5.515.3410.0	20
		WE SH 3/35	Busbar support (one-sided), tin-plated steel	WE SH 3/35	Z5.519.0310.0	25
		WE SH 4/35	Busbar support (two-sided), tin-plated steel	WE SH 4/35	Z5.519.0410.0	25
		SKN SH/35/F	Busbar support plastic, black	SKN SH/35/F	Z1.980.0153.0	10
<ul style="list-style-type: none"> • Plastic, black 						

Accessories		Accessories		Type	Part No.	Std. Pack
	WAK 35/4GN	Ground terminal, tin-plated steel	green-yellow	WAK 35/4GN	30.494.4210.7	10
		Busbar, Cu tin-plated ,18x3 mm	L = 1 m	18 x 3MSN	98.291.1000.0	10

Mounting rails

Mounting rail 35x7,5 according to DIN EN 60715

- Length 2 m

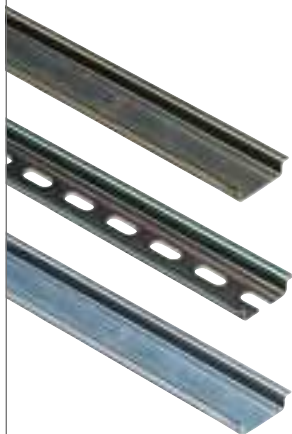

Description	Type	Part No.	Std. Pack
Steel, galv. zinc-plated and dichromated unslotted	35 x 27 x 7,5 EN 60715	98.300.0000.0	1
Steel, galv. zinc-plated and dichromated slotted	35 x 27 x 7,5 EN 60715	98.300.1000.0	1
Steel, unplated unslotted	35 x 27 x 7,5 EN 60715	98.300.0010.0	1

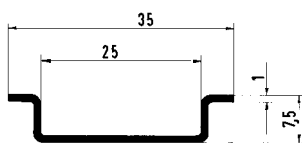

Mounting rail 35x15 according to DIN EN 60715

- Length 2 m

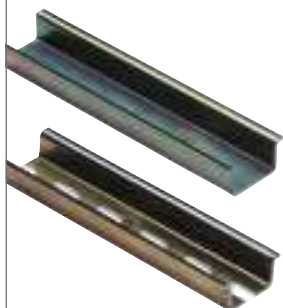

Description	Type	Part No.	Std. Pack
Steel, galv. zinc-plated and dichromated unslotted	35 x 27 x 15 EN 60715	98.370.0000.0	1
Steel, galv. zinc-plated and dichromated slotted	35 x 27 x 15 EN 60715	98.370.1000.0	1
Steel, galv. zinc-plated and dichromated slotted	35 x 27 x 15 EN 60715	98.375.1000.0	1
Steel, V2A slotted	35 x 27 x 15 EN 60715	98.370.1001.0	1

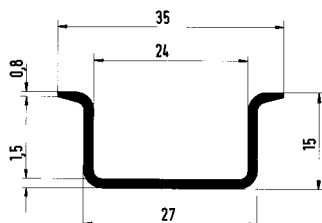

Mounting rail 35x15 according to DIN EN 60715

- Length 2 m

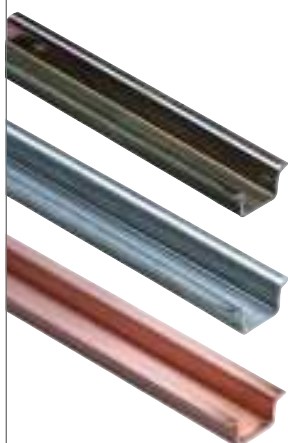

Description	Type	Part No.	Std. Pack
Steel, galv. zinc-plated and dichromated unslotted	35 x 24 x 15 EN 60715	98.360.0000.0	1
Steel, hot-galvanized unslotted	35 x 24 x 15 EN 60715 ZN	98.360.0004.0	1
E-copper unslotted	35 x 24 x 15 EN 60715 CU	98.380.0000.0	10

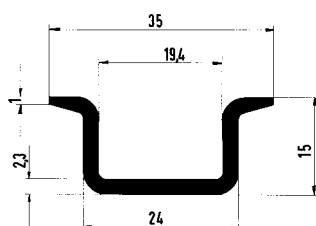

Mounting rail 15x5,5 according to DIN EN 60715

- Length 2 m



Description	Type	Part No.	Std. Pack
Steel, galv. zinc-plated and dichromated unslotted	9021 / 15 x 5,5 EN 60715	98.090.0015.0	10
Steel, galv. zinc-plated and dichromated slotted	9021 / 15 x 5,5 EN 60715	98.090.0000.0	1

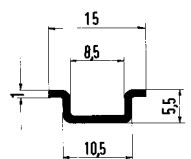

Mounting rail 15x5,5 according to DIN EN 60715

- Length 2 m

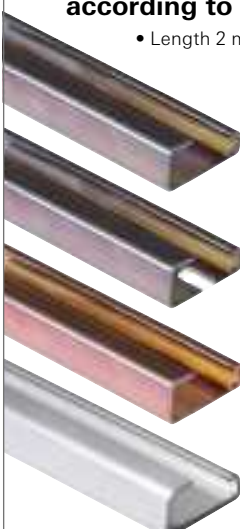

Description	Type	Part No.	Std. Pack
Steel, galv. zinc-plated and dichromated unslotted	9006 EN 60715 G-32	98.190.0000.0	1
Steel, galv. zinc-plated and dichromated slotted	9006 EN 60715 G-32	98.190.1000.0	1
E-copper unslotted	9006 E-CU	98.220.0000.0	10
Aluminium unslotted	9006 AL	98.210.0000.0	1

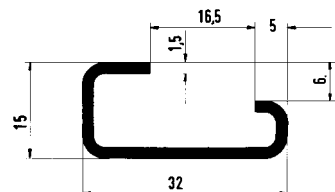

Accessories

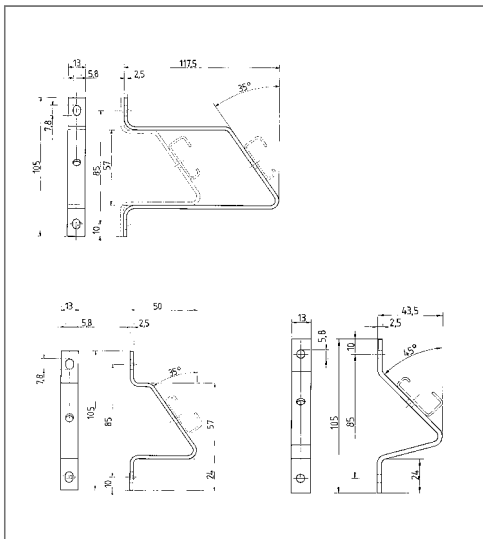

Accessories	Type	Part No.	Std. Pack
Angled support bracket with mounting material	9018 D	Z5.516.2511.0	50
Angled support bracket with mounting material	9018 H	Z5.516.2711.0	50
Angled support bracket with mounting material	9018 N	Z5.516.2811.0	50

End clamps

**End clamp for TS 35
snap-on mounting**



Description	Type	Part No.	Std. Pack
End clamp TS 35 5 mm wide	WEF 2 /35	Z5.523.9453.0	100

**End clamp for TS 35
snap-on mounting**



Description	Type	Part No.	Std. Pack
End clamp TS 35 8 mm wide	WEF 1 /35	Z5.523.9353.0	100
End clamp TS 35 17,5 mm wide	WEF 1 BS /35	69.920.1053.0	100
End clamp TS 35 8 mm wide	WEF 1 BSS /35	69.920.1253.0	100
Accessories			
Marking tag for WEF 1/35 wide	BS/R	Z4.243.8453.0	100
Marking cardboard in perforated sheets 100 tags/sh.		04.019.0289.0	10
Marking tag for WEF 1/35 small		04.243.8550.0	10
Marking cardboard in perforated sheets small		04.019.1189.0	10

**End clamp for TS 35
screw mounting**



Description	Type	Part No.	Std. Pack
End clamp TS 35 8 mm wide	9708/2 S 35	Z5.522.8553.0	100
End clamp TS 35 17,5 mm wide	9708/2 BS 35	69.920.0553.0	100
Accessories			
Marking cardboard in perforated sheets 100 tags/sh.		04.019.0289.0	10

End clamp with with U-foot screw mounting



Description	Type	Part No.	Std. Pack
End clamp with U-foot 10 mm wide	WE 1 /U	Z5.523.5753.0	100
End clamp with U-foot 17,5 mm wide with marking facilities	WE 1 BS /U	69.920.0753.0	100
End clamp with U-foot 10 mm wide	WE 2 /U	Z5.523.5653.0	100
End clamp with U-foot 17,5 mm wide with marking facilities	WE 2 BS /U	69.920.0653.0	100

Accessories		Type	Part No.	Std. Pack
Marking cardboard in perforated sheets 100tags/sh.			04.019.0289.0	10

End clamp for TS 15 screw mounting



Description	Type	Part No.	Std. Pack
End clamp, plastic 7,5 mm wide	9208 S 15	Z5.522.7553.0	100
End clamp, steel 5 mm wide	9222 S 15	Z5.522.5010.0	100

Configuration and marking systems



Individual marking of DIN rail terminal blocks means **wiemarc** and **wieplot** at Wieland Electric. The **wiemarc** software was developed to provide you with maximum flexibility in marking your terminal block assemblies. Together with the **wieplot** plotter you have a powerful marking system that enables you to work professionally from the individual marking tag to series marking of your terminal block assemblies. You feel confident with the system due to its easy handling and visual representation of your marking, even when you use it for the first time.

But **wieplot** offers even more!

In addition to the marking tags for DIN rail terminal blocks you can also print self-adhesive tags and labels or cable markings. A slight modification can even make your plotter a powerful engraving system.

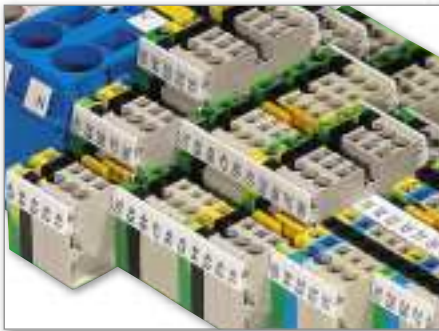

selos – fasis

Marking with a system

- Individual marking of all terminal blocks for clear wire/termination point assignment
- One single marking system for all designs
- Marking of individual tags; marking strips that correspond to the exact widths of the terminal blocks; or group markings
- Individual planning of terminal block assemblies and markings with **wieplan**



wieplot

Ready for universal use

- Marks all common marking systems available for DIN rail terminal blocks
- Different marking tags can be marked individually in one single work step
- Marking of labels, self-adhesive tags and cables is possible



wiemarc

Easy and quick

- Simple and intuitive user interface
- Direct graphical display of the marking tags including plausibility check
- Customized layouts can be created individually
- Data import from CAD, Excel, text or **wieplan** files



wieplot engraving system

Durable and safe –wieplot engraving system

- Easy modification to **wieplot** to make it an engraving system
- Engraving of multi-layer plastic boards
- Clean and dust-proof operation due to integrated vacuum device
- Create individual layouts using **wiemarc**

Plotter system *wieplot*



Description	Type	Part No.	Std. Pack
Complete package	wieplot 500	95.502.0604.0	1
Complete package	wieplot BASIC	95.502.0607.0	1

Contents: Plotter *wieplot*, data cable and manual, 4 receptacles (*wieplot*⁵⁰⁰) / 2 receptacles (*wieplot*^{BASIC}) for WSB (Wieland standard marking system), accessories kit, *wiemarc* software

Description:
With *wiemarc* you can create customized marking data on your PC. These can then be output on the *wieplot* plotter system to various marking plates.

Technical data:
 Resolution: 0.01 mm
 Accuracy: +/- 0.05 mm
 Power supply unit: 50/60 Hz, 100-240 V
 Output voltage: 24 V DC 1.4 A
 Current input: app. 0.3 A at 220 V
 Approval: UL-UL1950, CSA 950, VDEEN 60950
 Radio interf. suppr.: FCC class B, FCC sect. 15 and VDE class B
 Dim. / Weight: 660 mm x 440 mm x 125 mm / 8 kg (*wieplot*⁵⁰⁰)
 Interfaces: USB Level 1.1, parallel

Accessories for *wieplot*



Plotter pens for <i>wieplot</i>	Part No.	Type	Part No.
Plotter pen 0.18 mm	95.502.0118.0	Ink cartridge P2.0, 5x1ml	95.502.0199.0
Plotter pen 0.25 mm	95.502.0125.0	Cleaning set	95.502.0198.0
Plotter pen 0.35 mm	95.502.0135.0	Pen cleaner	95.502.0197.0
Plotter pen 0.50 mm	95.502.0150.0	Dust protection hood	95.502.0612.0
Plotter pen 0.70 mm	95.502.0170.0	Service kit – pen station	95.502.0613.0
Plotter pen 1.00 mm	95.502.0100.0	Seal inserts kit	
Dispos plotter pen 0.25 mm	95.502.0125.1		
Dispos plotter pen 0.35 mm	95.502.0135.1		
Dispos plotter pen-D ED 0.25 mm	95.502.0225.1		
Dispos plotter pen-D ED 0.35 mm	95.502.0235.1		

Receptacles for marking plates	
Type	Part No.
Receptacle for WSB	95.502.0620.0
Receptacle for BZ/WKF 15,	95.502.0627.0
Receptacle for BZ/WKF 1,5/10	95.502.0628.0

Engraving unit for *wieplot*⁵⁰⁰



Description	Type	Part No.	Std. Pack
Engraving unit	wieplot 500 E-UNIT	95.502.0700.0	1

Contents: Engraving spindle, engraving head (with fuse and counter bearing), control unit *wieplot* vec 500, vacuum cleaner *wieplot* vc 500, connection cables

Description:
The *wieplot* 500 E-UNIT engraving unit has been designed for use with the *wieplot* 500 plotter. The system is set up for engraving multi-layer plastic tags. The Plotboard A4 in a 297 x 202 mm format is the receptacle for marking paper sheets and labels and also enables engraving of plastic boards.

Accessories	Type	Part No.	Std. Pack
Graver SET, complete	SET	95.502.0710.0	1
Graver	0.2 mm	95.502.0710.2	1
Graver	0.3 mm	95.502.0710.3	1
Graver	0.4 mm	95.502.0710.4	1
Graver	0.5 mm	95.502.0710.5	1
Graver	0.7 mm	95.502.0710.7	1
Graver	1.0 mm	95.502.0711.0	1
Receptacle	Plottboard A4	95.502.0625.0	1

Marking computer *marcom 2*



Description	Type	Part No.	Std. Pack
Marking computer	marcom 2	95.502.0000.0	1

Contents: Marking computer in case, european power supply unit, power pack, data cassette with job memory, marking tag carrier, plotter pen, 0.25 mm, cleaning set

Description:
marcom 2 is a freely programmable marking computer for DIN rail terminal blocks, pluggable connectors, switching devices and cables. The computer provides of a large number of fonts, with numerical and alphanumerical characters and symbols. *marcom 2* is portable and can be used at any location; it can be operated either using the mains or batteries.

Technical data:
 Operator panel: 190 mm x 45 mm
 Resolution: 0.01 mm
 Power supply unit: 50/60 Hz, 100-230 V
 Output voltage: 9.5 V (150 mV/1.4 VA) – 14 V (450 mA/6.3 VA)
 Replaceable battery: 16.8 V (14 NiCd-Zellen)
 Dimensions: 380 mm x 190 mm x 63 mm
 Weight: 6.2 kg

Marking accessories

Marking plates

- For **marcom 2** marking computer
- For **wieplot 500** plotter system

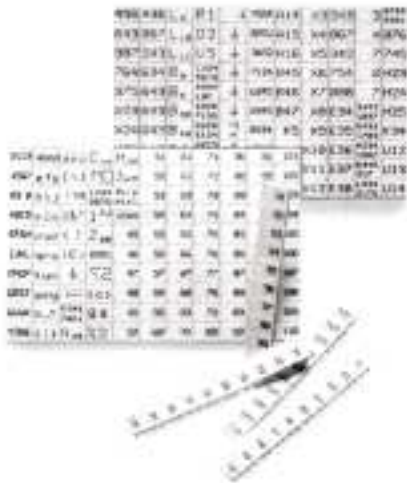

Description	Type	Part No.	Std. Pack	
Unmarked				
Width 5 x 8.3mm	110 tags per plate	9075 A/5/10/11	Z4.242.5053.0	10
Width 5 x 14mm	60 tags per plate	9705 AL/5/10/6	Z4.242.5153.0	10
Width 6 x 8.3mm	110 tags per plate	9075 A/6/10/11	Z4.242.6053.0	10
Width 6 x 14mm	60 tags per plate	9705 AL/6/10/6	Z4.242.6153.0	10
Width 8 x 8.3mm	70 tags per plate	9075 A/8/10/7	Z4.242.8053.0	10

Single marking tag All blocks/ 5 mm wide and larger

*) Custom marking upon request



Description	Type	Part No.	Std. Pack
Unmarked			
Width 5 x 8.3mm	9705 A	04.242.0850.0	500
Width 5 x 14mm	9705 AL	04.242.1553.0	500
Marked			
Width 5 x 8.3mm	9705 AB *)	04.842.0850.0	500
Width 5 x 14mm	9705 ALB *)	04.842.1553.0	500

Marking strips 2,5 mm²/5 mm wide

*) Custom marking upon request



Description	Type	Part No.	Std. Pack
Unmarked			
	9705 A/5/10	04.242.5053.0	25
Marked			
1 - 9	9705A/5/9 B 1 - 9	04.842.4953.0	25
*)	9705A/5/10 B	04.842.5053.0	25
1 - 10	9705A/5/10 B 1 - 10	04.845.0153.0	25
11 - 20	9705A/5/10 B 11 - 20	04.845.0253.0	25
21 - 30	9705A/5/10 B 21 - 30	04.845.0353.0	25
31 - 40	9705A/5/10 B 31 - 40	04.845.0453.0	25
41 - 50	9705A/5/10 B 41 - 50	04.845.0553.0	25
51 - 60	9705A/5/10 B 51 - 60	04.845.0653.0	25
61 - 70	9705A/5/10 B 61 - 70	04.845.0753.0	25
71 - 80	9705A/5/10 B 71 - 80	04.845.0853.0	25
81 - 90	9705A/5/10 B 81 - 90	04.845.0953.0	25
91 - 100	9705A/5/10 B 91 - 100	04.845.1053.0	25
⊕ (10x)	9705A/5/10B SLZ	04.855.0053.0	25
⊖ (10x)	9705A/5/10B ERDZ	04.855.0153.0	25
+	9705A/5/10 B +	04.855.0253.0	25
-	9705A/5/10 B -	04.855.0353.0	25
L1 (10x)	9705A/5/10B L1	04.855.0453.0	25
L2 (10x)	9705A/5/10B L2	04.855.0553.0	25
L3 (10x)	9705A/5/10B L3	04.855.0653.0	25
PE (10x)	9705A/5/10B PE	04.855.0753.0	25
SL (10x)	9705A/5/10B SL	04.855.3153.0	25
N (10x)	9705A/5/10B N	04.855.3253.0	25
F1 (10x)	9705A/5/10B F1	04.855.0953.0	25
F2 (10x)	9705A/5/10B F2	04.855.1053.0	25
L1,L2,L3,N,PE (10x)	9705A/5/10B L1L2L3NPE..	04.855.0853.0	25
With enlarged marking area			
	9705 AL/5/10	04.242.5153.0	25

Marking strips 4 mm²/6 mm wide

*) Custom marking upon request



Description	Type	Part No.	Std. Pack
Unmarked	9705 A/6/10	04.242.6053.0	25
Marked			
1 – 9	9705A/6/9 B 1 - 9	04.842.5953.0	25
*)	9705A/6/10 B	04.842.6053.0	25
1 – 10	9705A/6/10 B 1 - 10	04.846.0153.0	25
11 – 20	9705A/6/10 B 11 - 20	04.846.0253.0	25
21 – 30	9705A/6/10 B 21 - 30	04.846.0353.0	25
31 – 40	9705A/6/10 B 31 - 40	04.846.0453.0	25
41 – 50	9705A/6/10 B 41 - 50	04.846.0553.0	25
51 – 60	9705A/6/10 B 51 - 60	04.846.0653.0	25
61 – 70	9705A/6/10 B 61 - 70	04.846.0753.0	25
71 – 80	9705A/6/10 B 71 - 80	04.846.0853.0	25
81 – 90	9705A/6/10 B 81 - 90	04.846.0953.0	25
91 – 100	9705A/6/10 B 91 - 100	04.846.1053.0	25
⊕ (10x)	9705A/6/10 B SLZ	04.856.0053.0	25
⊖ (10x)	9705A/6/10 B ERDZ	04.856.0153.0	25
+ (10x)	9705A/6/10 B +	04.856.0253.0	25
- (10x)	9705A/6/10 B -	04.856.0353.0	25
L1 (10x)	9705A/6/10 B L1	04.856.0453.0	25
L2 (10x)	9705A/6/10 B L2	04.856.0553.0	25
L3 (10x)	9705A/6/10 B L3	04.856.0653.0	25
PE (10x)	9705A/6/10 B PE	04.856.0753.0	25
SL (10x)	9705A/6/10 B SL	04.856.3153.0	25
N (10x)	9705A/6/10 B N	04.856.3253.0	25
F1 (10x)	9705A/6/10 B F1	04.856.0953.0	25
F2 (10x)	9705A/6/10 B F2	04.856.1053.0	25
L1,L2,L3,N,PE (10x)	9705A/6/10 B L1L2L3NPE..	04.856.0853.0	25
With enlarged marking area	9705 AL/6/10	04.242.6353.0	25

Marking strips 6 mm²/8 mm wide

*) Custom marking upon request



Description	Type	Part No.	Std. Pack
Unmarked	9705 A/8/10	04.242.8053.0	25
Marked			
1 – 9	9705A/8/9 B 1 - 9	04.842.7953.0	25
*)	9705A/8/10 B	04.842.8053.0	25
1 – 10	9705A/8/10 B 1 - 10	04.848.0153.0	25
11 – 20	9705A/8/10 B 11 - 20	04.848.0253.0	25
21 – 30	9705A/8/10 B 21 - 30	04.848.0353.0	25
31 – 40	9705A/8/10 B 31 - 40	04.848.0453.0	25
41 – 50	9705A/8/10 B 41 - 50	04.848.0553.0	25
51 – 60	9705A/8/10 B 51 - 60	04.848.0653.0	25
61 – 70	9705A/8/10 B 61 - 70	04.848.0753.0	25
71 – 80	9705A/8/10 B 71 - 80	04.848.0853.0	25
81 – 90	9705A/8/10 B 81 - 90	04.848.0953.0	25
91 – 100	9705A/8/10 B 91 - 100	04.848.1053.0	25
⊕ (10x)	9705A/8/10 B SLZ	04.858.0053.0	25
⊖ (10x)	9705A/8/10 B ERDZ	04.858.0153.0	25
+ (10x)	9705A/8/10 B +	04.858.0253.0	25
- (10x)	9705A/8/10 B -	04.858.0353.0	25
L1 (10x)	9705A/8/10 B L1	04.858.0453.0	25
L2 (10x)	9705A/8/10 B L2	04.858.0553.0	25
L3 (10x)	9705A/8/10 B L3	04.858.0653.0	25
PE (10x)	9705A/8/10 B PE	04.858.0753.0	25
SL (10x)	9705A/8/10 B SL	04.858.3153.0	25
N (10x)	9705A/8/10 B N	04.858.3253.0	25
F1 (10x)	9705A/8/10 B F1	04.858.0953.0	25
F2 (10x)	9705A/8/10 B F2	04.858.1053.0	25
L1,L2,L3,N,PE (10x)	9705A/8/10 B L1L2L3NPE..	04.858.0853.0	25

Marking strips 10 mm²/10 mm wide 16 mm²/12 mm wide 35 mm²/16 mm wide 70 mm²/24 mm wide





Description	Type	Part No.	Std. Pack
10 mm²/10 mm wide for 5 blocks	9705 A/5/10/5 B	04.842.5553.0	25
16 mm²/12 mm wide for 5 blocks	9705 A/6/10/5 B	04.842.6553.0	25
35 mm²/16 mm wide for 5 blocks	9705 A/8/10/5 B	04.842.8553.0	25
70 mm²/24 mm wide for 4 blocks	9705 A/8/10/5 B	04.842.8553.0	25

Specify required marking with part no.

Marking accessories

Description	Type	Part No.	Std. Pack
Tear-off marking strips marked with numbers			
<ul style="list-style-type: none"> • With 10 marking tags • For single symbol marking 			
Unmarked	9704 A	04.241.1150.0	25
Marked with the same number			
1	9704 A/1 B	04.841.1150.0	25
2	9704 A/2 B	04.841.1250.0	25
3	9704 A/3 B	04.841.1350.0	25
4	9704 A/4 B	04.841.1450.0	25
5	9704 A/5 B	04.841.1550.0	25
6	9704 A/6 B	04.841.1650.0	25
7	9704 A/7 B	04.841.1750.0	25
8	9704 A/8 B	04.841.1850.0	25
9	9704 A/9 B	04.841.1950.0	25
0	9704 A/0 B	04.841.2050.0	25
Marked with consecutive numbers			
1-0	9704 A/1-0 B	04.841.2150.0	25
Marked with the same symbols			
+	9704 A/+	04.841.7450.0	25
-	9704 A/-	04.841.7550.0	25
/	9704 A//	04.841.7650.0	25
.	9704 A/.	04.841.7750.0	25
Set, marked with same numbers (= 10 x 25 strips = 2.500 numbers)			
111 up to 000		04.841.9050.0	1

Description	Type	Part No.	Std. Pack
Tear-off marking strips marked with upper case letters			
<ul style="list-style-type: none"> • With 10 marking tags • For single symbol marking 			
Marked with the same upper case letters			
A	9704 A /AG B	04.841.2250.0	25
B	9704 A /BG B	04.841.2350.0	25
C	9704 A /CG B	04.841.2450.0	25
D	9704 A /DG B	04.841.2550.0	25
E	9704 A /EG B	04.841.2650.0	25
F	9704 A /FG B	04.841.2750.0	25
G	9704 A /GG B	04.841.2850.0	25
H	9704 A /HG B	04.841.2950.0	25
I	9704 A /IG B	04.841.3050.0	25
J	9704 A /JG B	04.841.3150.0	25
K	9704 A /KG B	04.841.3250.0	25
L	9704 A /LG B	04.841.3350.0	25
M	9704 A /MG B	04.841.3450.0	25
N	9704 A /NG B	04.841.3550.0	25
O	9704 A /OG B	04.841.3650.0	25
P	9704 A /PG B	04.841.3750.0	25
Q	9704 A /QG B	04.841.3850.0	25
R	9704 A /RG B	04.841.3950.0	25
S	9704 A /SG B	04.841.4050.0	25
T	9704 A /TG B	04.841.4150.0	25
U	9704 A /UG B	04.841.4250.0	25
V	9704 A /VG B	04.841.4350.0	25
W	9704 A /WG B	04.841.4450.0	25
X	9704 A /XG B	04.841.4550.0	25
Y	9704 A /YG B	04.841.4650.0	25
Z	9704 A /ZG B	04.841.4750.0	25
Set, marked with same upper case letters (= 26 x 25 strips = 6.500 numbers)			
A up to Z GB		04.841.9150.0	1

Description	Type	Part No.	Std. Pack
Tear-off marking strips marked with lower case letters			
<ul style="list-style-type: none"> • With 10 marking tags • For single symbol marking 			
Marked with the same lower case letters			
a	9704 A /AK B	04.841.4850.0	25
b	9704 A /BK B	04.841.4950.0	25
c	9704 A /CK B	04.841.5050.0	25
d	9704 A /DK B	04.841.5150.0	25
e	9704 A /EK B	04.841.5250.0	25
f	9704 A /FK B	04.841.5350.0	25
g	9704 A /GK B	04.841.5450.0	25
h	9704 A /HK B	04.841.5550.0	25
i	9704 A /IK B	04.841.5650.0	25
j	9704 A /JK B	04.841.5750.0	25
k	9704 A /KK B	04.841.5850.0	25
l	9704 A /LK B	04.841.5950.0	25
m	9704 A /MK B	04.841.6050.0	25
n	9704 A /NK B	04.841.6150.0	25
o	9704 A /OK B	04.841.6250.0	25
p	9704 A /PK B	04.841.6350.0	25
q	9704 A /QK B	04.841.6450.0	25
r	9704 A /RK B	04.841.6550.0	25
s	9704 A /SK B	04.841.6650.0	25
t	9704 A /TK B	04.841.6750.0	25
u	9704 A /UK B	04.841.6850.0	25
v	9704 A /VK B	04.841.6950.0	25
w	9704 A /WK B	04.841.7050.0	25
x	9704 A /XK B	04.841.7150.0	25
y	9704 A /YK B	04.841.7250.0	25
z	9704 A /ZK B	04.841.7350.0	25
Set, Marked with the same lower case letters (= 26 x 25 strips = 6.500 numbers)			
a up to z KB		04.841.9250.0	1

Assortment box	Description				Type	Part No.	Std. Pack
	<ul style="list-style-type: none"> For marking material 	Assortment box for 5 mm width				S0 1/5	04.900.2053.0
Assortment for 5 mm width				1-100 9705 A/5/10 B	04.855.1153.0	1	
				101-200 9705 A/5/10 B	04.855.1253.0	1	
Assortment box for 6 mm width				S0 1/6	04.900.3053.0	1	
Assortment for 6 mm width				1-100 9705 A/6/10 B	04.856.1153.0	1	
				101-200 9705 A/6/10 B	04.1253.0	1	
Assortment box for 8 mm width				S0 1/8	04.900.4053.0	1	
Assortment for 8 mm width				1-100 9705 A/8/10 B	04.858.1153.0	1	
				101-200 9705 A/8/10 B	04.858.1253.0	1	
Assortment box for tear-off marking tags							
with 50 digits each				S0 1/0	04.900.1053.0	1	
Assortment box, empty				S0 1	04.900.0000.0	1	

Marking tag carrier	Description				Type	Part No.	Std. Pack
	<ul style="list-style-type: none"> For all blocks 	Marking tag carrier, 4 digits				9705 A/4	04.242.0950.0
Marking tag carrier, 6 digits				9705 A/6	04.242.1250.0	200	
Marking tag carrier, 45° angle				9705 A/4 W	04.242.2853.0	200	



Partition	Description				Type	Part No.	Std. Pack
	<ul style="list-style-type: none"> With marking facilities 	Partition with carrier for marking tags					
for TS32 and TS35					Z7.311.1755.0	10	
for TS15					Z7.311.2755.0	10	
Partition with carrier for marking cards							
for TS32 and TS35					Z7.311.7055.0	10	
Accessories							
Marking card in perforated sheets				100 tags/sheets		04.019.0289.0	10



Cross connectors and jumper bars

Cross connectors

- Cross connector poles can be individually removed.
- When cross connectors with removed poles are used, the rated voltage is reduced to 400 V.
- You can cut a 10-wire connector plug in half to form two 5-wire connector plugs, but an end cover plate or isolating plate must then be inserted.



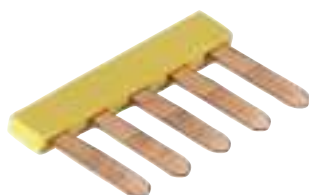

Description	Type	Part No.	Std. Pack
1.5 mm², 4 mm wide	IVB WKF 1,5-2	Z7.260.0227.0	10
	IVB WKF 1,5-3	Z7.268.0327.0	10
	IVB WKF 1,5-4	Z7.268.0427.0	10
	IVB WKF 1,5-5	Z7.268.0527.0	10
	IVB WKF 1,5-10	Z7.268.1027.0	10
	IVB WKF 1,5-20	Z7.268.2027.0	10
2.5 mm², 5 mm wide	IVB WKF 2,5-2	Z7.280.6227.0	10
	IVB WKF 2,5-3	Z7.280.6327.0	10
	IVB WKF 2,5-4	Z7.280.6427.0	10
	IVB WKF 2,5-5	Z7.280.6527.0	10
	IVB WKF 2,5-6	Z7.280.6627.0	10
	IVB WKF 2,5-7	Z7.280.6727.0	20
	IVB WKF 2,5-8	Z7.280.6827.0	20
	IVB WKF 2,5-9	Z7.280.6927.0	20
	IVB WKF 2,5-10	Z7.280.7027.0	20
	IVB WKF 2,5-20	Z7.280.8027.0	20
	IVB WKF-V	Z7.261.1127.0	10
4 mm², 6 mm wide	IVB WKF 4-2	Z7.261.1227.0	10
	IVB WKF 4-3	Z7.261.1327.0	10
	IVB WKF 4-4	Z7.261.1427.0	10
	IVB WKF 4-5	Z7.261.1527.0	10
	IVB WKF 4-6	Z7.261.1627.0	10
	IVB WKF 4-7	Z7.261.1727.0	10
	IVB WKF 4-8	Z7.261.1827.0	10
	IVB WKF 4-9	Z7.261.1927.0	10
	IVB WKF 4-10	Z7.261.2027.0	10
	6 mm², 8 mm wide	IVB WKFN 6-2	Z7.282.5227.0
IVB WKFN 6-5		Z7.282.5527.0	10
10 mm², 10 mm wide	IVB WKF 10-2	Z7.283.8227.0	10
16 mm², 12 mm wide	IVB WKF 16-2	Z7.284.4227.0	10
35 mm², 16 mm wide	IVB WKF 35-2	Z7.285.6227.0	10
	IVB WKF 35R10-2	Z7.285.6427.0	10
Jumping cross connectors for WT 2,5, WTP 2,5/4 and WKFN 2,5			
3 pole 1-3		99.013.9999.9	10
4 pole 1-4		99.014.9999.9	10
5 pole 1-5		99.015.9999.9	10
5 pole 1 to 3 to 5		99.031.9999.9	10
7 pole 1 to 3, 5 and 7		99.032.9999.9	10
9 pole 1 to 3, 5, 7 and 9		99.033.9999.9	10
11 pole 1 to 3, 5, 7, 9 and 11		99.034.9999.9	10
Additional combinations upon request			

Jumper bar, insulated Jumper comb, insulated



Description	Type	Part No.	Std. Pack
WK 4/U and WK 4 TK, 6mm wide, 0,5mm thick			
Jumper comb, insulated	IVB 0,5 WK 4-2	Z7.255.0227.0	10
	IVB 0,5 WK 4-12	Z7.255.0227.0	10
WK 4/U and WK 4 TK, 6mm wide, 1mm thick			
Jumper comb, insulated	IVB 1 WK 4-2	Z7.255.4227.0	10
	IVB 1 WK 4-12	Z7.255.4227.0	10
WK 6, WKN 6 TK, WK 4 THSi 6,3x32			
Jumper comb, insulated	IVK WKN 6 TK-2	Z7.255.8227.0	10
	IVK WKN 6 TK-3	Z7.255.8327.0	10
	IVK WKN 6 TK-4	Z7.256.8427.0	10
	IVK WKN 6 TK-5	Z7.256.8527.0	10
	IVK WKN 6 TK-6	Z7.256.8527.0	10

Cover strips and test plugs

	Description	Type	Part No.	Std. Pack
Cover strip with warning symbol <ul style="list-style-type: none"> Over 4 blocks, tension spring connection 	for tension spring connection			
	1.5 mm ² , 4 mm wide	ADF 1,5/5 GELB	04.343.6953.8	10
	2.5 mm ² , 5 mm wide	ADFN 2,5/4 GELB	04.343.8353.8	10
	4 mm ² , 6 mm wide	ADF 4/4 GELB	04.343.6153.8	10
	6 mm ² , 8 mm wide	ADF 6/4 GELB	04.343.6253.8	10
	10 mm ² , 10 mm wide	ADF 10/4 GELB	04.343.6453.8	10
	16 mm ² , 12 mm wide	ADF 16/4 GELB	04.343.6653.8	10
	35 mm ² , 16 mm wide	ADF 35/5 GELB	04.343.9253.8	10
<ul style="list-style-type: none"> Over 4 blocks, screw connection 	for screw connection			
	WKN 35/U, 16 mm wide, screw M5	AD 16/4 GELB	04.343.5256.8	10
	WKN 70/U, 24 mm wide, screw M6	AD 24/4 GELB	04.343.5356.8	10
	WKN 150/U, 28 mm wide, screw M8	ADN 28/4 GELB	04.343.5456.8	10

	Description	Type	Part No.	Std. Pack
Test plug with tension spring connection <ul style="list-style-type: none"> For WKF/WKC terminal blocks For 2.5 mm², 5 mm wide and 4 mm², 6 mm wide 	Test plug	PSWKC/F	Z1.299.9753.0	10
	Blind piece		01.299.9753.0	10
	Endplate	ZP/AP PS	07.312.6053.0	10
General data				
Width	5 mm / 6 mm*			
Wire strip length	8 mm			
Technical data	IEC	UL	CSA	
Cross section solid	0.13 – 1.5 mm ²			
Cross section fine-stranded	0.13 – 1.5 mm ²			
Rated current	13.5 A			
Rated voltage	400 V			
Note	* For 6 mm spacing a ZP/AP PS is snapped on behind each test plug or blind piece.			

	Description	Type	Part No.	Std. Pack
Test plug <ul style="list-style-type: none"> 250 V / 2 A 	Test plug 2.3 mm red	ST 2/2 RT	Z5.553.2921.0	10
	Test plug 2.3 mm black	ST 2/2 SW	Z5.553.2921.1	50
	Test plug 2.3 mm blue	ST 2/2 BL	Z5.553.2921.6	100
	Test plug 4 mm black	ST 2/4 SW	Z5.553.3121.0	10

Tools

Wire entry guides

- For conductors with cross sections smaller than 1 mm²



Description	Type	Part No.	Std. Pack
1.5 mm², 4 mm wide			
for 0.13–0.2 mm ² wires	LEL 1,5/1 WEISS	05.564.4253.0	10
for 0.25–0.5 mm ² wires	LEL 1,5/2 GRAU	05.564.4353.0	10
2.5 mm², 5 mm wide			
for 0.13–0.2 mm ² wires	LELN 2,5/1 WEISS	05.564.3755.0	100
for 0.25–0.5 mm ² wires	LELN 2,5/1 GRAU	05.564.3855.0	100
for 0.75–1.0 mm ² wires	LELN 2,5/1 SCHWARZ	05.564.3955.0	100
4 mm², 6 mm wide			
for 0.13–0.2 mm ² wires	LEL 4/1 WEISS	05.561.8553.0	100
for 0.25–0.5 mm ² wires	LEL 4/2 GRAU	05.561.8653.0	100
for 0.75–1.0 mm ² wires	LEL 4/3 SCHWARZ	05.561.8753.0	100

Notching tool for cross connectors

- For 1.5 mm², wide 4 mm wide
- For 2.5 mm², 5 mm wide
- For 4 mm², 6 mm wide



Description	Type	Part No.	Std. Pack
Notching tool	AKW /A	95.300.0500.0	1

Screwdrivers



Description	Type	Part No.	Std. Pack
1.5 mm², 4 mm wide			
Uninsulated, long and straight	DIN 5264 A 0,4x2,5	06.502.4300.0	5
2.5 mm², 5 mm wide			
Uninsulated, long and straight	DIN 5264 B 0,6x3,5	06.502.4000.0	10
Uninsulated, short and straight	DIN 5264 B 0,6x3,5 M	06.502.5000.0	10
Uninsulated, long and angled	DIN 5264 B 0,6x3,5 W	05.502.4100.0	10
Uninsulated, short and angled	DIN 5264 B 0,6x3,5 MW	05.502.4000.0	10
4 mm², 6 mm wide			
Uninsulated, long and straight	DIN 5264 B 0,6x3,5	06.502.4000.0	10
Uninsulated, short and straight	DIN 5264 B 0,6x3,5 M	06.502.5000.0	10
Uninsulated, long and angled	DIN 5264 B 0,6x3,5 W	05.502.4100.0	10
Uninsulated, short and angled	DIN 5264 B 0,6x3,5 MW	05.502.4000.0	10
6 mm², 8 mm wide	DIN 5264 B 0,6x4	06.502.4100.0	5
10 mm², 10 mm wide	DIN 5264 B 0,6x4	06.502.4100.0	5
16 mm², 12 mm wide	DIN 5264 B 1x5,5	06.502.4200.0	5
35 mm², 16 mm wide	DIN 5264 B 1x5,5	06.502.4200.0	5

Ferrules and tools

Ferrules

with insulating material sleeve

• **Materials:**

Sleeve: Polypropylene, temperature resistance 105°C, creepage resistant
 Tube: E-Cu, galvanically tin-plated

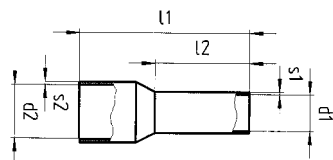

without insulating material sleeve

• **Materials:** Tube: E-Cu, galvanically tin-plated

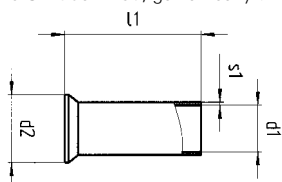

Cross section mm ²	Color	Type	Part No.	Std. Pack
Ferrules with insulating material sleeve according to DIN 46228T4				
0.50	norm.	white	06.600.2027.0	100
0.75	norm.	gray	06.600.2127.0	100
1.00	norm.	res	06.600.2227.0	100
1.50	norm.	black	06.600.2327.0	100
1.50	long	black	06.600.2427.0	100
2.50	norm.	blue	06.600.2527.0	100
2.50	long	blue	06.600.2627.0	100
4.00	norm.	gray	06.600.2727.0	100
4.00	long	gray	06.600.2827.0	100
6.00	norm.	yellow	06.600.2927.0	100
6.00	long	yellow	06.600.3027.0	100
10.00	norm.	red	06.600.3127.0	100
10.00	long	red	06.600.3227.0	100
16.00	norm.	blue	06.600.3327.0	100
16.00	long	blue	06.600.3427.0	100
25.00	mid-length	yellow	06.600.3527.0	50
Ferrules without insulating material sleeve according to DIN 46228T1				
0.50	norm.		06.600.4027.0	1000
0.75	norm.		06.600.4127.0	1000
1.00	norm.		06.600.4227.0	1000
1.50	norm.		06.600.4327.0	1000
2.50	norm.		06.600.4427.0	1000
4.00	norm.		06.600.4527.0	1000
6.00	norm.		06.600.4627.0	500
10.00	norm.		06.600.4727.0	500
16.00	norm.		06.600.4827.0	100
25.00	norm.		06.600.4927.0	100
35.00	norm.		06.600.5027.0	100

Wire strippers



Description	Type	Part No.	Std. Pack
Wire strippers	AIW/A	95.350.0100.0	1
General data			
Wire strip length	0.08 - 10mm ²		
Cross section, AWG	28 - 7		

Crimping tool

• for ferrules



Description	Type	Part No.	Std. Pack
Pressing tool A	Length: 180 mm PW/A	95.101.1300.0	1
Pressing tool B	Length: 203 mm PW/B	95.101.1100.0	1
Pressing tool C	Length: 203 mm PW/C	95.101.1200.0	1
General data			
A: Wire strip length	0.08 - 10mm ²		
A: Cross section, AWG	28 - 7		
B: Wire strip length	10 - 25mm ²		
B: Cross section, AWG	7 - 4		
C: Wire strip length	35 - 50mm ²		
C: Cross section, AWG	2 - 1/0		

wieplan – configuration software



wieplan was developed to provide you with a powerful software tool for the configuration of terminal block assemblies using Wieland DIN rail terminal blocks.

wieplan is available in 4 languages. It is user-friendly and its intuitive user interface guides you step by step through the entire configuration process. After you have completed your design, you have the option of ordering the fully-built assembly from Wieland.

Thus **wieplan** helps you to save time and money.



Managing projects

Benefits:

- To begin each configuration you automatically start from the basic project management menu.
- You create new projects and are reliably guided through the easy and practice-oriented program steps.
- You always have the choice of either opening an already existing project or of creating a new one.



Configuring terminal block assemblies without errors

Benefits:

- You work with high-quality graphics viewing the terminal blocks from the top; the accessories added are visible at all time.
- You continually use the plausibility check that reminds you of the accessories required such as end plates.
- You are provided with a product catalog with search function; you can add your own order numbers, if required; and you can create libraries to add in your own products.



Entering order data

Benefits:

- You enter your data such as invoice and delivery address in the order data screen only once and can use them for any follow-up orders.
- You may order by e-mail; in this case the terminal block assembly data are zipped automatically.



Terminal block assembly output

Benefits:

- You print out the order, the parts list and the drawing data, and, if required, your own order numbers.
- You create a DXF file and export the current terminal block assembly to a CAD program.
- You export the marking in CSV format including all marking data for further processing in **wiemarc**, for example.
- You can use a bidirectional interface available for your CAE system EPLAN.

Solution specific, value added assembly

Terminal block assemblies

For those who want to make their control cabinet work easier Wieland Electric pre-assembles completely equipped DIN rail terminal block assemblies, even with the cables connected, if required.



Cable assemblies

Individual cables tailored to your needs and combined with various components can be delivered for your project in all lengths.



Control and distribution panels

Our value-add departments will gladly assist you in selecting individual Wieland components, or in laying out complete panels, which we can also build for you.

Interface modules – solution specific connectivity

Each control cabinet requires distribution functionality. In most cases this is accomplished with standard control panel wiring (0.5mm or 1.5mm fine stranded with ferrule) to standardized interfaces (d-sub or ribbon cables). Upon the customer's request Wieland Electric can design individual and customized solutions for all applications, too.

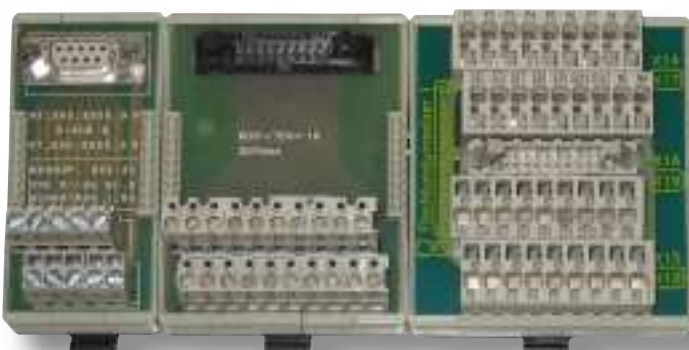

Tables, technical data

DIN rail terminal blocks

Material selection *selos* and *fasis*

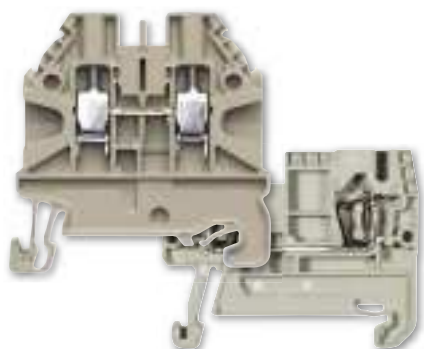

Metal parts

- Special alloys enable low feed-through resistance and provide a gas-tight contact area:
 - Current carrying bar: Copper, or brass
 - Clamping body and clamping screws: Galvanized and chromated steel
 - Clamping spring: CrNi stainless steel
 - Current carrying bar: Copper, tinned

Plastic materials

- Polyamide has excellent electrical, chemical and mechanical characteristics:
 - Temperature resistance: Up to 120°C
 - Creepage resistance: CTI 600
 - Flammability class: Self-extinguishing, UL94-V0

Electrical and thermal characteristics of plastic materials

Key figures / characteristics	Standard		Unit	Thermoplast	
				Polyamide PA 666	
Dielectric strength	VDE 0303-T21	IEC 243/1	kV / mm	tr./lf.	55 / 45
Dielectric loss tan δ at 1 MHz	VDE 0303-T4	IEC 250		tr./lf.	0.02 / 0.3
Specific feed through resistance	VDE 0303-T30	IEC 93	$\Omega \times \text{cm}$	lf.	10^{12}
Surface resistance	VDE 0303-T30	IEC 93	Ω	lf.	10^{10}
Creepage	VDE 0303-T1	IEC 112	CTI		600
Operating temperature RTI *	UL 746 B		°C at 1.5 mm		120
Temperature index TI **	VDE 0304 T.21	IEC 216-1	°C		123 / 107
Minimum operating temperature without mechanical stress			°C		-40
Flammability	UL 94		Class / material thickness		V0 / 0.4
Suitability for tropical areas					good

* electrical value

** related to 50% strain resistance drop after 5,000/20,000 hours

Standard cross sections of round copper conductors AWG/metric

Metric size ISO mm ²	Comparison between AWG/kcmil and metric sizes			Metric size ISO mm ²	Comparison between AWG/kcmil and metric sizes		
	AWG	kcmil	mm ²		AWG	kcmil	mm ²
0.1*	28		0.081	16	6		13.3
0.14*	26		0.128	25	4		21.2
0.2	24		0.205	35	2		33.6
–	22		0.324	50	(1/0) 0		53.5
0.5	20		0.519	70	(2/0) 00		67.4
0.75	18		0.82	95	(3/0) 000		85
1	–		–	–	(4/0) 0000		107.2
1.5	16		1,3	120		250	127
2.5	14		2,1	150		300	152
4	12		3,3	185		350	177
6	10		5,3	240		500	253
10	8		8,4	300		600	304

* not standardized

Mounting rails

Maximum short-time current capability assigned to mounting rails

DIN EN 60 947-7-2

Rail profile	Material	Equivalent E-Cu cross section mm ²	Short-time- current capability		Rated thermal current of a PEN busbar A
			1 s kA		
DIN rail TH 15 x 5,5 according to IEC 60 715	Steel	10	1.2		–
G rail TS 32 according to IEC 60 715	Steel	35	4.2		–
	Copper ¹⁾	120	14.4		269
	Aluminium ¹⁾	70	8.4		192
DIN rail TS 35 x 27 x 7,5 according to IEC 60 715	Steel	16	1.92		–
DIN rail TS 35 x 27 x 15 according to IEC 60 715	Steel	25	3		–
DIN rail TS 35 x 24 x 15 according to IEC 60 715 (made from 2.3 mm thick material)	Steel	50	6		–
	Copper ¹⁾	150	18		309

¹⁾ Selected copper or aluminum alloys from the manufacturer of the terminal block layout were used to achieve the values in the table.

Torques

Torque according to EN 60947-1 for selos DIN rail terminal blocks			II	III
	II applies for screws that are tightened with a screwdriver	WT 2,5, width 5 mm	M2.5 clamping body screw	Nm
III applies for screws that can be tightened with tools other than a screwdriver	WT 4 ... , width 6 mm	M3 clamping body screw	Nm	0.5
	WT 6 and WKN 6, width 8 mm	M4 clamping body screw M3.5 screw for cross connector	Nm Nm	1.2 0.8
	WT 10, width 10 mm	M4 clamping body screw	Nm	1.2
	WT 16, width 12 mm	M6 clamping body screw	Nm	2.0
	WKN 35, width 16 mm	M6 clamping body screw	Nm	2.5
		M5 screw for cross connector	Nm	2.0
	WKN 70, width 24 mm	M8 clamping body screw	Nm	3.5
		M6 screw for cross connector	Nm	2.5
	WKN 150, width 28 mm	M10 clamping body screw	Nm	4.0
		M8 screw for cross connector	Nm	3.5

SCCR Values for DIN rail terminal blocks

As a result of changes to the 2005 NEC, both the operator and manufacturer of electrical equipment must comply with increased requirements related to resistance to short-circuiting of equipment. In accordance with both the NEC 2005 Article 409.110 and UL 508A, the short circuit resistance of the complete installation must now be considered. The installation's Short Circuit Current Rating must be indicated on the equipment or control panel's legend plate.

Wieland has tested and determined individual SCCR values for their terminal blocks in connection with the widest variety of fuses. These ratings are far greater than the default values contained in UL 508A. As a result, when qualifying your installation, you have increased flexibility and accuracy when using Wieland terminal blocks.



What does SCCR marking mean?

The Short Circuit Current Rating (SCCR) of a component represents the maximum short circuit current level a device can safely withstand without compromising safety for installations and personnel. Article 409 on industrial control panels was added to the NEC in the 2005 edition. This article calls for all industrial control panels to be marked with a Short Circuit Current Rating. The Short Circuit Current Rating (SCCR) requirements for UL 508A came into force in April 2006.



How is the SCCR marking determined?

The NEC Article 409 refers to the UL 508A Supplement SB as an approved method for determining the SCCR of an industrial control panel. This specific method is outlined in Section SB4.

1. Determination of the SCCR values of individual components, for example DIN rail terminal blocks
2. Modification of the SCCR values through the use of current limiting devices per UL 508 SB 4.3
3. Selection of the lowest SCCR value from all the components



SCCR for DIN rail terminal blocks in general

The SCCR of a terminal block can be determined according to UL 508A using one of the following methods:

1. Use the tested SCCR value
2. Use the default SCCR value as specified in table 4.1 of UL 508

If the DIN rail terminal blocks do not have a tested SCCR, then the UL default value of 10kA must be used. This relatively low value would limit the SCCR of the entire system to max. 10kA.

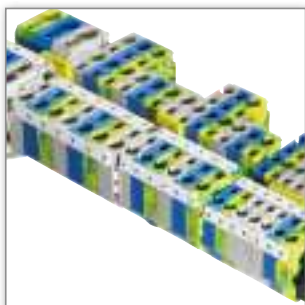

SCCR for Wieland DIN rail terminal blocks

Wieland determined SCCR values for its DIN rail terminal blocks used in conjunction with fuses and circuit breakers. The resulting SCCR values are much higher than the values specified for DIN rail terminal blocks in table SB 4.1 of UL 508A. You will find the tested SCCR values for our **selos** and **fasis** product series in our customer information 0019.3, available on www.wieland-electric.com. The SCCR values are also published on the UL website (<http://www.ul.com>) under file number E60678.

Information about EX e

Technical information

- The information regarding cross sectional area and connection types pertains to unprepared wires without ferrules! Ferrules are not necessary for secure connection. Whenever ferrules are used, make sure that the tools specified by the manufacturer are used exclusively.
- The voltage ratings apply to the terminals in their intended application. When different products are mounted adjacent to each other, the proper isolation distances must be adhered to.
- If the ground blocks are not used in block assemblies, but are mounted to the rail as single terminal blocks, end clamps have to be used.
- A detailed description of technical data, the standards requirements, and the application conditions are available in the flyer **facts & DATA**.

ATEX regulation

- For the use of DIN rail terminal blocks in Ex areas, the regulations of EN 60079-0 apply; whereas for increased safety Exe the regulations of EN 60079-7 must be followed. For an approximation of the laws of the EU member states, directive 94/9/EG was created, which is generally known as ATEX 100a and which is the basis for harmonization in this field. ATEX stands for "atmosphere explosive" while 100a refers to the corresponding article of the EC contract.
- Directive ATEX 100a applies for protection against dust and gas explosions in all industrial Ex areas and in mining. The testing and certifying institutes named in directive ATEX 100a must follow accreditation procedures which are the same throughout Europe.
- In accordance with EN 60070-0/60079-7 and ATEX 100a, these certifying institutes write out EC certificates for prototype tests. These prototype test certificates for components together with the corresponding quality system certification of the supplier are required to obtain the so-called ATEX approval.
- In combination with the  mark, the markings of the Wieland terminal blocks have the following meaning:

	Identification
II	Device group
2	Category
G D	Areas
KEMA	Name of testing institute
ATEX...	Certificate, year of testing, number

Mounting instructions for Ex e applications

- If feed-through blocks are mounted directly adjacent to other feed-through blocks of a different size, or directly adjacent to ground blocks, the open side of the block group of the same type must be covered by an end plate or partition.
- If adjacent DIN rail terminal blocks are jumpered or if jumpered DIN rail terminal blocks are positioned next to unjumpered DIN rail terminal blocks, a partition plate must be inserted between the individual terminal block groups or at the beginning and end of a laterally or longitudinally connected terminal block (group) in order to meet the specified isolation distances. Notched out and jumpering cross connectors can not be used in Ex areas.
- If the terminal blocks are combined with other certified series and sizes and when their accessories are used, the required creepage distances and clearances must be adhered to.
- The feed through terminal blocks and protective conductor terminal blocks are suitable for enclosures for use in explosive gas atmospheres or for use in the presence of combustible dust. For explosive gas atmospheres these enclosures must satisfy the requirements of EN 60079-0 and EN 60079-7. For combustible dust these enclosures must satisfy the requirements of EN 61241-0 and EN 61241-1 rather EN 50281-1-1.
- The indicated values for the current carrying capability refer to a maximum ambient temperature of 40 °C. When the terminal blocks are loaded with the maximum rated current the temperature rise will be max. 45 K.
- Operating temperature range: **selos** WK...: -40°C ... +80°C
selos WKFN: -20°C ... +80°C

DQS certification for all company sectors

- Quality standard as per DIN ISO 9001 in Development, Production and Assembly
- Continued control of the quality standard by means of regular internal and external quality audits
- Compatible with certificates of other countries:
 - BSI Certificate, Great Britain
 - SQS Certificate, Switzerland
 - Aib-Vincotte Certificate, Belgium
 - ÖQS Certificate, Austria



Spanning various industries and products.



0601.1 "gesis^{TOP} Luminaire connector concepts"



0602.1 "gesis^{LINECT} Universal Connector System for Recessed Luminaires"

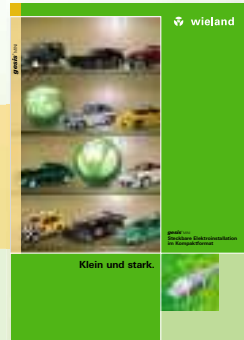

0640.1 "gesis^{MINI} the pluggable electrical installation with a compact design"



0117.0 "fasis^{BIT} / fasis^{BIT-S} / selos^{BIT} DIN rail terminal blocks for junction boxes"



0800.1 "interface Solutions for the Control Cabinet"



0860.1 "safety System Solutions for Automation Technology"



0401.1 "Electro-technical solutions for the control cabinet"



0402.1 "Components for heating, ventilation, and air conditioning"



0408.1 "smart Installation Pluggable, decentralized electrical installation for sustainable building"



0910.1 "Corporate Sustainability Environmental Statement Bamberg and Gerach locations"



0009.0 "Wieland apprenticeship Auf der Erfolgsstraße."



0902.1 "The system partner in automation technology and in building automation technology"



0600.1 "gis CON GST 18
Electrical installation of
buildings via plug & play



0700.1 "gis ELECTRONIC
Decentralized building
automation with plug & play"

Building and installation techn.

Automation technology

Further documents and
brochures can be downloaded
quickly and easily via the
Download Center on
our homepage.



0409.1 "gis RAN
Decentralized installable
electronic distributor for
building automation"



0710.1 "gis SOLAR
Electrical Installation Technology
for Photovoltaics"

Industries

Wieland connects.



Wieland 100 years in Bamberg.

Wieland is one of the most important employers in Bamberg and the surrounding area. The book portrays the life of the company's founder Friedrich H. ("Fritz") Wieland and the following generations, closely intertwined with the company's history. Available in bookshops.



Hotline – one call is all it takes

Our DIN rail terminal blocks hotline **+49 951 9324-991** our e-mail-service **AT.TS@wieland-electric.com** is available to answer all your questions on the subject of DIN rail terminal blocks.



Wieland e-Catalog

For further technical information and the latest news on DIN rail terminal blocks, go to:

<https://eshop.wieland-electric.com>

Our subsidiaries

... and the addresses of our representations worldwide are available at:

www.wieland-electric.com



USA
Wieland Electric Inc.
North American Headquarters
 2889 Brighton Road
 Oakville, Ontario L6H 6C9
 Phone +1 905 8298414
 Fax +1 905 8298413
www.wielandinc.com



CANADA
Wieland Electric Inc.
North American Headquarters
 2889 Brighton Road
 Oakville, Ontario L6H 6C9
 Phone +1 905 8298414
 Fax +1 905 8298413
www.wieland-electric.ca



GREAT BRITAIN
Wieland Electric Ltd.
 Riverside Business Centre,
 Walnut Tree Close
 GB-Guildford /Surrey GU1 4UG
 Phone +44 1483 531213
 Fax +44 1483 505029
sales@wieland.co.uk



FRANCE
Wieland Electric SARL.
 Le Céramê Hall 6
 47, avenue des Genottes
 CS 48313
 95803 Cergy-Pontoise Cedex
 Phone +33 1 30320707
 Fax +33 1 30320714
infos@wieland-electric.fr



SPAIN
Wieland Electric S.L.
 C/ Maria Auxiliadora 2 bajos
 E-08017 Barcelona
 Phone +34 93 2523820
 Fax +34 93 2523825
ventas@wieland-electric.com



ITALY
Wieland Electric S.r.l.
 Via Edison, 209
 I-20019 Settimo Milanese
 Phone +39 02 48916357
 Fax +39 02 48 920685
info@wieland-electric.it



POLAND
Wieland Electric Sp. Zo.o.
 Św. Antoniego 8
 62-080 Swadzim
 Phone +48 61 2225400
 Fax +48 61 8407166
office@wieland-electric.pl



CHINA
Wieland Electric Trading
 Unit 2703
 International Soho City
 889 Renmin Rd.,
 Huang Pu District
 PRC- Shanghai 200010
 Phone +86 21 63555833
 Fax +86 21 63550090
info-shanghai@wieland-electric.cn



DENMARK
Wieland Electric A/S
 Vallørækken 26
 DK-4600 Køge
 Phone +45 70 266635
 Fax +45 70 266637
sales@wieland-electric.dk



BELGIUM
ATEM – Wieland Electric NV
 Bedrijvenpark De Veert 4
 B-2830 Willebroek
 Phone +32 3 8661800
 Fax +32 3 8661828
info.belgium@wieland-electric.com



◀ **Informational material for ordering and for downloading from our websites**

Subject to technical modifications!

gesis®, **podis**®, **samos**® are registered trademarks of Wieland Electric GmbH



wieland

Headquarters:

Wieland Electric GmbH
Brennerstraße 10 – 14
96052 Bamberg, Germany

Sales and Marketing Center:

Wieland Electric GmbH
Benzstraße 9
96052 Bamberg, Germany

Phone +49 951 9324-0

Fax +49 951 9324-198

www.wieland-electric.com

www.gesis.com

info@wieland-electric.com

Industrial technology

Solutions for the control cabinet

- DIN rail terminal blocks
 - Screw, tension spring or push-in connection technology
 - Wire cross sections up to 240 mm²
 - Numerous special functions
 - Software solutions interfacing to CAE systems
- Safety
 - Safe signal acquisition
 - Safety switching devices
 - Modular safety modules
 - Compact safety controllers
 - Application consulting and training
- Network engineering and fieldbus systems
 - Remote maintenance via VPN industrial router and VPN service portal
 - Industrial Ethernet switches
 - PLC and I/O systems, standard and increased environmental conditions
- Interface
 - Power supply units
 - Overvoltage protection
 - Coupling relays, semiconductor switches
 - Timer relays, measuring and monitoring relays
 - Analog coupling and converter modules
 - Passive interfaces

Solutions for field applications

- Decentralized installation and automation technology
 - Electrical installation for wind tower
 - Fieldbus interfaces and motor starters
- Connectors for industrial applications
 - Rectangular and round connectors
 - Aluminum or plastic housings
 - Degree of protection up to IP68
 - Current-carrying capacity up to 100 A
 - Connectors for hazardous areas
 - Modular, application-specific technology

PC board terminals and connectors

- Screw or spring clamp connection technology
- Spacings: 3.5 mm to 10.16 mm
- Reflow or wave soldering process

Building and installation technology

- Building installation systems
 - Main power supply connectors IP20/IP65...IP68
 - Bus connectors
 - Low-voltage connectors
 - Power distribution system with flat cables
 - Distribution systems
 - Bus systems in KNX, LON and wireless technology
 - DIN rail terminal blocks for electrical installations
 - Overvoltage protection

0500.1 C 02/13

contacts
are
green.

X-ON Electronics

Largest Supplier of Electrical and Electronic Components

Click to view similar products for [wieland](#) manufacturer:

Other Similar products are found below :

[57.504.0053.7](#) [57.904.4955.0](#) [57.904.7455.0](#) [57.910.6153](#) [01.001.6553.0](#) [01.112.1453](#) [02.125.1600.0](#) [CWD012-5](#) [CWD012-L](#) [CWD02-A](#)
[CWD02-D](#) [CWD02-H](#) [CWD02-K](#) [CWD02-M](#) [CWD02-Q](#) [CWD02-R](#) [CWD02-U](#) [CWD02-W](#) [CWD02-Y](#) [CWD03+](#) [CWD03-P](#)
[70.105.1653.3](#) [70.331.1628.0](#) [70.340.1028.0](#) [70.343.2428.0](#) [70.353.4835.1](#) [70.355.2435.1](#) [70.364.4828.0](#) [70.372.1035.0](#) [70.372.4835.1](#)
[70.372.4835.3](#) [70.400.3240.0](#) [70.500.4853.0](#) [70.810.1053.0](#) [70.955.2453.3](#) [71.321.1028.0](#) [71.350.1028.0](#) [72.250.1628.2](#) [72.250.2428.2](#)
[72.250.2435.2](#) [72.301.1653.9](#) [72.325.1628.0](#) [72.353.1635.0](#) [73.352.6428](#) [73.353.4028.1](#) [73.363.6428.0](#) [77.340.1635.0](#) [78.111.0453.0](#)
[78.903.0153.0](#) [78.914.0253.0](#)