

Features

- .250" (6.35mm) Quick-Connect Terminals on Top
- Printed Circuit Terminals on Bottom
- Flange Mount (F-suffix)
- Rugged, Miniature Construction
- Single-Pole Switching
- Epoxy Sealed

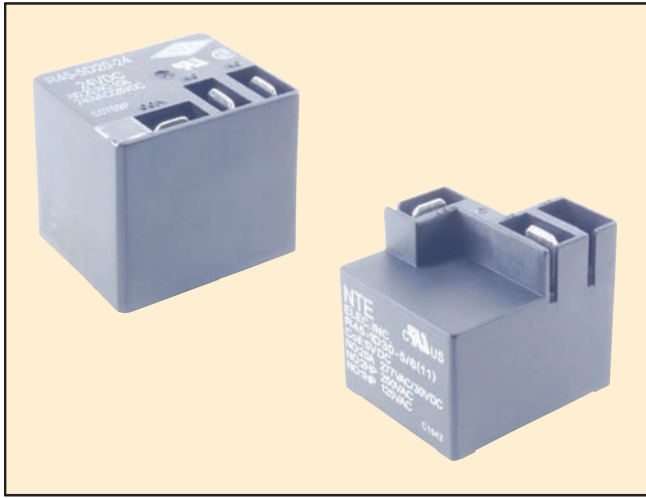

SPST-NO, 1 Form "A"

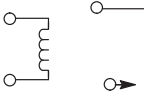

SPDT, 1 Form "C"

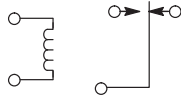

DC OPERATED						
NTE Type No.	Nom. Volt.	Contact Arr.	Coil Res. Ohms (Typ)	Nom. Power	Max. Contact Current @ 28VDC 240VAC	Diag No.
R45-1D30-5/6	5VDC	SPST-NO	28	900mW	30A	D42a
R45-1D30-5/6F	5VDC	SPST-NO	28	900mW	30A	D42b
R45-1D30-12	12VDC	SPST-NO	155	900mW	30A	D42a
R45-1D30-12F	12VDC	SPST-NO	155	900mW	30A	D42b
R45-1D30-24	24VDC	SPST-NO	660	900mW	30A	D42a
R45-1D30-24F	24VDC	SPST-NO	660	900mW	30A	D42b
R45-5D20-5/6	5VDC	SPDT	28	600mW	20A	D42a
R45-5D20-5/6F	5VDC	SPDT	28	600mW	20A	D42b
R45-5D20-12	12VDC	SPDT	155	600mW	20A	D42a
R45-5D20-12F	12VDC	SPDT	155	600mW	20A	D42b
R45-5D20-24	24VDC	SPDT	660	600mW	20A	D42a
R45-5D20-24F	24VDC	SPDT	660	600mW	20A	D42b

R45 Series



Industrial, Printed Circuit Mount, SPST and SPDT, 20 Amp and 30 Amp Relays for use in Machinery, Major Appliances, and Air Conditioning Controls.

D42a

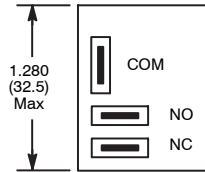

D42a (alt)

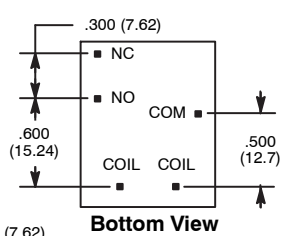
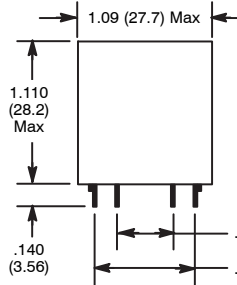
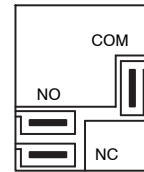

Bottom View

D42b

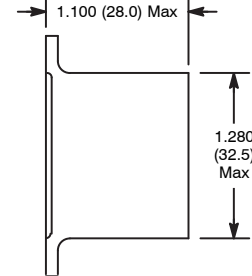
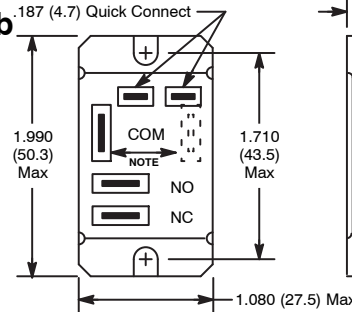

NOTE: Pin may be on one side or the other.

Electrical Specifications

Contact

Rating: 1 Form A (SPST-NO), 30 Amps at 240VAC/28VDC
1 Form C (SPDT), 20 Amps at 240VAC/28VDC

Resistance: See Chart

Coil

Coil Voltages: See Chart

Pick-up Voltage: 75% of Nom.

Drop-out Voltage: 10% of Nom.

Operational Characteristics

Timing Values **Operate Time:** 15ms
Release Time: 20ms

Insulation Characteristics

Dielectric Strength (Initial)

Contact to Contact: 1500VAC/1 minute

Coil To Contact: 1500VAC/1 minute

Environmental Characteristics

Operating: -55°C to +85°C

Storage: -55°C to +125°C

Life

Electrical: 100,000 operations min.

Mechanical: 10,000,000 operations min.

X-ON Electronics

Largest Supplier of Electrical and Electronic Components

Click to view similar products for [General Purpose Relays](#) category:

Click to view products by [NTE](#) manufacturer:

Other Similar products are found below :

[APF30318](#) [JVN1AF-4.5V-F](#) [PCN-105D3MHZ](#) [5JO-10000S-SIL](#) [5JO-1000CD-SIL](#) [5JO-400CD-SIL](#) [LY2S-AC220/240](#) [LYQ20DC12](#)
[6031007G](#) [6131406HQ](#) [6-1393099-3](#) [6-1393099-8](#) [6-1393122-4](#) [6-1393123-2](#) [6-1393767-1](#) [6-1393843-7](#) [6-1415012-1](#) [6-1419102-2](#) [6-](#)
[1423698-4](#) [6-1608051-6](#) [6-1608067-0](#) [6-1616170-6](#) [6-1616248-2](#) [6-1616282-3](#) [6-1616348-2](#) [6-1616350-1](#) [6-1616350-8](#) [6-1616358-7](#) [6-](#)
[1616359-9](#) [6-1616360-9](#) [6-1616931-6](#) [6-1617039-1](#) [6-1617052-1](#) [6-1617090-2](#) [6-1617090-5](#) [6-1617347-5](#) [6-1617353-3](#) [6-1617801-8](#) [6-](#)
[1617802-2](#) [6-1618107-9](#) [6-1618248-4](#) [M83536/1-027M](#) [CX-4014](#) [MAHC-5494](#) [MAVCD-5419-6](#) [703XCX-120A](#) [7-1393100-5](#) [7-1393111-7](#)
[7-1393144-5](#) [7-1393767-8](#)