

Panasonic
ideas for life

HIGH ELECTRICAL & MECHANICAL NOISE IMMUNITY RELAY

JQ RELAYS

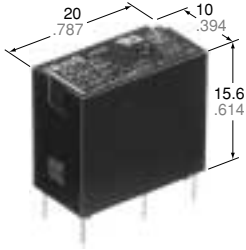

mm inch

FEATURES

- High electrical noise immunity
- High switching capacity in a compact package
- High sensitivity: 200 mW (1a), 400 mW (1c)
- High surge voltage: 8,000 V between contacts and coil
- UL, CSA, VDE, TÜV, SEMKO approved
- Class B coil insulation type available

SPECIFICATIONS

Contact

		Standard type	High capacity type		
Arrangement		1 Form A, 1 Form C			
Initial contact resistance, max. (By voltage drop 6 V DC 1 A)		100 mΩ			
Contact material		Silver alloy			
Rating (resistive)	Nominal switching capacity	1a	5 A 125 V AC 2 A 250 V AC 5 A 30 V DC	10 A 125 V AC 5 A 250 V AC 5 A 30 V DC	
		1c	N.O.	5 A 125 V AC 2 A 250 V AC 3 A 30 V AC	10 A 125 V AC 5 A 250 V AC 5 A 30 V DC
			N.C.	2 A 125 V AC 1 A 250 V AC 1 A 30 V DC	3 A 125 V AC 2 A 250 V AC 1 A 30 V DC
		Max. switching power	1a	625 VA, 150 W	1,250 VA, 150 W
	1c		N.O.	625 VA, 90 W	1,250 V AC, 150 W
			N.C.	250 VA, 30 W	500 V AC, 30 W
	Max. switching voltage		250 V AC, 110 V DC (0.3A)		
	Max. switching current		N.O.: 5 A N.C.: 2 A	N.O.: 10 A N.C.: 3 A	
Min. switching capacity ^{#1}		100 mA, 5 V DC			
Expected mechanical life (at 180 cpm)(min. operations)		10 ⁷			

Expected electrical life (min. operations)

Type		Switching capacity	No. of operations	
Standard type	1a	5 A 125 V AC	5×10 ⁴	
		3 A 125 V AC	2×10 ⁵	
	1c	2 A 250 V AC	2×10 ⁵	
		5 A 30 V DC	10 ⁵	
High capacity type	1a	10 A 125 V AC	5×10 ⁴	
		5 A 250 V AC	5×10 ⁴	
	5 A 30 V DC	10 ⁵		
	1c	N.O.	10 A 125 V AC 5 A 250 V AC 5 A 30 V DC	5×10 ⁴ 5×10 ⁴ 10 ⁵
		N.C.	3 A 125 V AC 2 A 250 V AC 1 A 30 V DC	2×10 ⁵ 2×10 ⁵ 10 ⁵

Coil (at 20°C 68°F)

Nominal operating power	1a: 200 mW	1c: 400 mW
-------------------------	------------	------------

Characteristics

Max. operating speed		20 cpm
Initial insulation resistance*1		Min. 1,000 MΩ at 500 V DC
Initial breakdown voltage*2	Between open contacts	1a: 1,000 Vrms for 1 min. 1c: 750 Vrms for 1 min.
	Between contacts and coil	4,000 Vrms for 1 min.
Surge voltage between contact and coil*3		8,000 V
Operate time*4 (at nominal voltage)		Approx. 5 ms
Release time*4 (at nominal voltage)(without diode)		Approx. 2 ms
Temperature rise*5		Max. 45°C
Shock resistance	Functional*6	Min. 294 m/s ² {30 G}
	Destructive*7	Min. 980 m/s ² {100 G}
Vibration resistance	Functional*8	98 m/s ² {10 G}, 10 to 55 Hz at double amplitude of 1.6 mm
	Destructive	117.6 m/s ² {12 G}, 10 to 55 Hz at double amplitude of 2.0 mm
Conditions for operation, transport and storage*9 (Not freezing and condensing at low temperature)		Ambient temp.*10
		Humidity
Unit weight		Approx. 7 g .25 oz

#1 This value can change due to the switching frequency, environmental conditions, and desired reliability level, therefore it is recommended to check this with the actual load.

Remarks

- * Specifications will vary with foreign standards certification ratings.
- *1 Measurement at same location as "Initial breakdown voltage" section
- *2 Detection current: 10 mA
- *3 Wave is standard shock voltage of ±1.2 × 50μs according to JEC-212-1981
- *4 Excluding contact bounce time
- *5 Measured conditions

Standard type	Resistive, nominal voltage applied to the coil. Contact carrying current: 5 A, at 70°C 158°F
High capacity type	Resistive, nominal voltage applied to the coil. Contact carrying current: 10 A, at 70°C 158°F

- *6 Half-wave pulse of sine wave: 11ms; detection time: 10μs
- *7 Half-wave pulse of sine wave: 6ms
- *8 Detection time: 10μs
- *9 Refer to 6. Conditions for operation, transport and storage mentioned in AMBIENT ENVIRONMENT
- *10 When using relays in a high ambient temperature, consider the pick-up voltage rise due to the high temperature (a rise of approx. 0.4% V for each 1°C 33.8°F with 20°C 68°F as a reference) and use a coil impressed voltage that is within the maximum allowable voltage range.

TYPICAL APPLICATIONS

- Air conditioners
- Refrigerators
- Microwave ovens
- Heaters

ORDERING INFORMATION

Ex. JQ 1a P — B — 12 V — F

Contact arrangement	Contact capacity	Coil insulation class	Coil voltage (DC)	Environmental support
1a: 1 Form A 1: 1 Form C	Nil: Standard P: High capacity	Nil: Class E coil insulation B: Class B coil insulation	5, 6, 9, 12, 18, 24, 48* V	F: RoHS Directive conforming type (AgSnO ₂ type) Nil: RoHS Directive non-conforming type (AgCdO type)

UL/CSA, VDE, SEMKO approved type is standard.

* Available only for 1 Form C type

TYPES AND COIL DATA at 20°C 68°F

	Part No.	Nominal voltage, V DC	Pick-up voltage, V DC (min.)	Drop-out voltage, V DC (min.)	Nominal operating current, mA	Nominal operating power, mW	Coil resistance, Ω (±10%)	Max. allowable voltage, V DC
1 Form A	Standard type	JQ1a-5V (-F)	5	3.75	0.25	40	200	180% of nominal voltage (at 20°C 68°F)
		JQ1a-6V (-F)	6	4.5	0.3			
		JQ1a-9V (-F)	9	6.75	0.45			
		JQ1a-12V (-F)	12	9	0.6			
		JQ1a-18V (-F)	18	13.5	0.9			
		JQ1a-24V (-F)	24	18	1.2			
	High capacity type	JQ1aP-5V (-F)	5	4	0.25	40	200	130% of nominal voltage (at 85°C 185°F)
		JQ1aP-6V (-F)	6	4.8	0.3			
		JQ1aP-9V (-F)	9	7.2	0.45			
		JQ1aP-12V (-F)	12	9.6	0.6			
		JQ1aP-18V (-F)	18	14.4	0.9			
		JQ1aP-24V (-F)	24	19.2	1.2			
1 Form C	Standard type	JQ1-5V (-F)	5	3.75	0.25	80	400	150% of nominal voltage (at 20°C 68°F)
		JQ1-6V (-F)	6	4.5	0.3			
		JQ1-9V (-F)	9	6.75	0.45			
		JQ1-12V (-F)	12	9	0.6			
		JQ1-18V (-F)	18	13.5	0.9			
		JQ1-24V (-F)	24	18	1.2			
		JQ1-48V (-F)	48	36	2.4			
	High capacity type	JQ1P-5V (-F)	5	4	0.25	80	400	110% of nominal voltage (at 85°C 185°F)
		JQ1P-6V (-F)	6	4.8	0.3			
		JQ1P-9V (-F)	9	7.2	0.45			
		JQ1P-12V (-F)	12	9.6	0.6			
		JQ1P-18V (-F)	18	14.4	0.9			
		JQ1P-24V (-F)	24	19.2	1.2			
		JQ1P-48V (-F)	48	38.4	2.4			



1 Form A

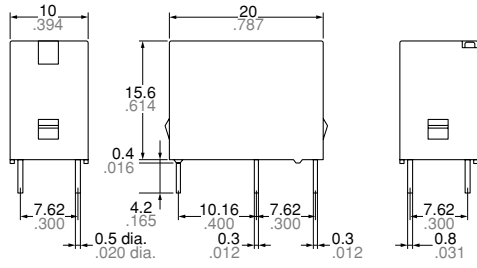

1 Form A



Schematic (Bottom view)

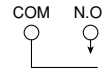

1 Form C

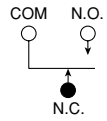

1 Form C

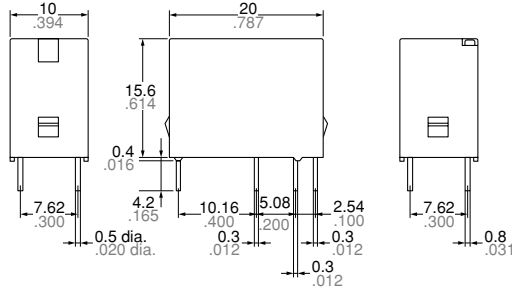

1 Form A

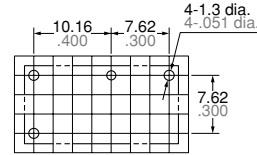

1 Form C

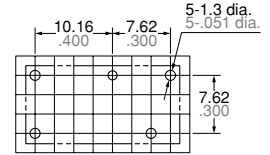

Tolerance: $\pm 0.1 \pm 0.04$

Dimension :	General tolerance
Max. 1mm .039 inch	$\pm 0.2 \pm 0.08$
1 to 5mm .039 to .118 inch	$\pm 0.3 \pm 0.12$
Min. 5mm .118 inch	$\pm 0.4 \pm 0.16$

REFERENCE DATA

Max. switching capacity (1 Form A type)

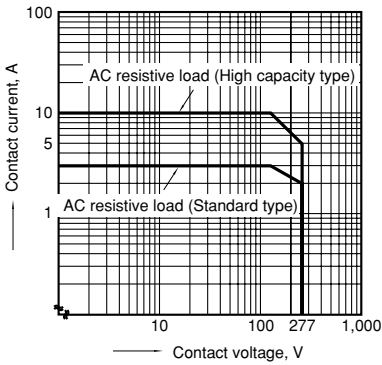

Max. switching capacity (1 Form C type)

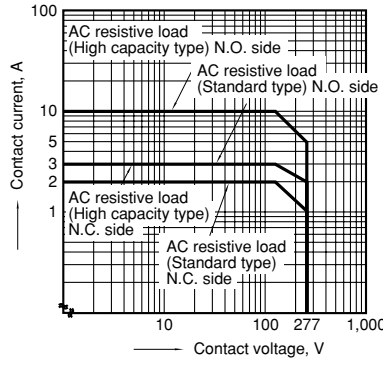

Standard type

1-(1). Operate & release time (1 Form A type)
 Tested sample: JQ1a-12V, 25 pcs.

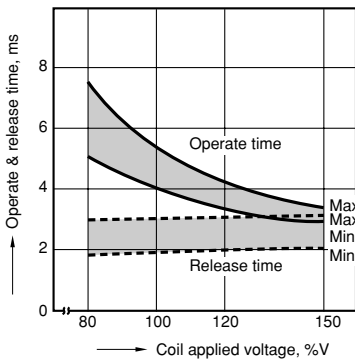

1-(2). Operate & release time (1 Form C type)
 Tested sample: JQ1-24V, 25 pcs.

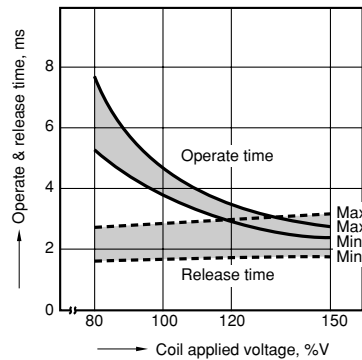

2. Life curve
 Ambient temperature: room temperature

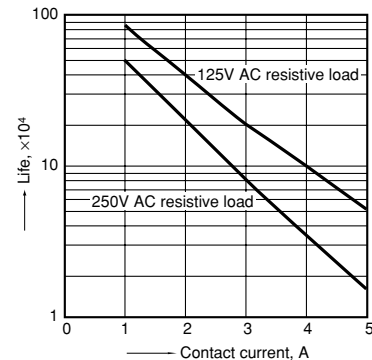

3-(1). Coil temperature rise (1 Form A type)

Contact carrying current: 3 A, 5 A
Measured portion: Inside the coil

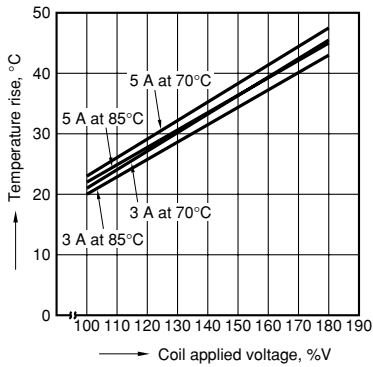

3-(2). Coil temperature rise (1 Form C type)

Contact carrying current: 3 A, 5 A
Measured portion: Inside the coil

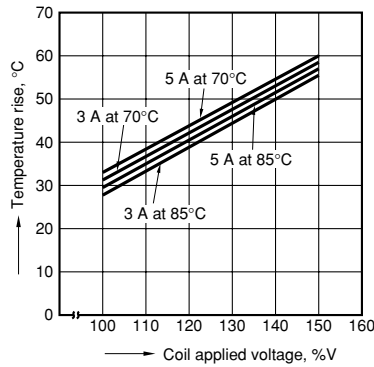

4-(1). Ambient temperature characteristics (1 Form A type)

Tested sample: JQ1a-24V
Contact carrying current: 3 A, 5 A

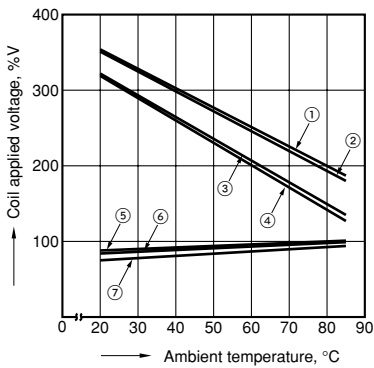

4-(2). Ambient temperature characteristics (1 Form C type)

Tested sample: JQ1-24V
Contact carrying current: 3 A, 5 A

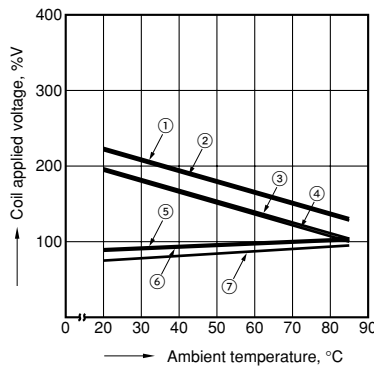

- ① Allowable ambient temperature against % coil voltage (max. inside the coil temperature set as 130°C 266°F) (Carrying current: 3 A)
- ② Allowable ambient temperature against % coil voltage (max. inside the coil temperature set as 130°C 266°F) (Carrying current: 5 A)
- ③ Allowable ambient temperature against % coil voltage (max. inside the coil temperature set as 115°C 239°F) (Carrying current: 3 A)
- ④ Allowable ambient temperature against % coil voltage (max. inside the coil temperature set as 115°C 239°F) (Carrying current: 5 A)
- ⑤ Pick-up voltage with a hot-start condition of 100%V on the coil (Carrying current: 5 A)
- ⑥ Pick-up voltage with a hot-start condition of 100%V on the coil (Carrying current: 3 A)
- ⑦ Pick-up voltage

High capacity type

1-(1). Operate & release time (1 Form A type)

Tested sample: JQ1aP-12V, 25 pcs.

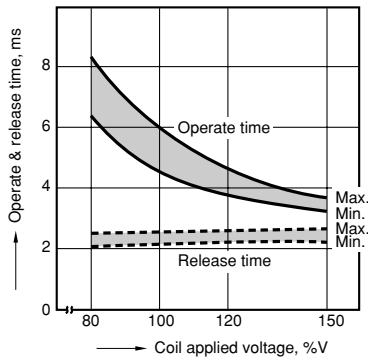

1-(2). Operate & release time (1 Form C type)

Tested sample: JQ1P-12V, 25 pcs.

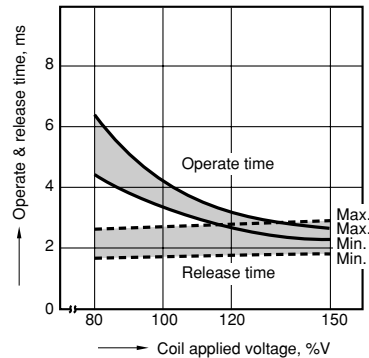

2. Life curve

Ambient temperature: room temperature

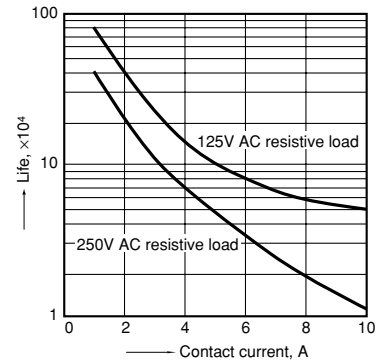

3-(1). Coil temperature rise (1 Form A type)

Contact carrying current: 5 A, 10 A
Measured portion: Inside the coil

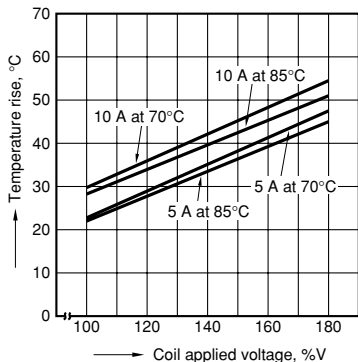

3-(2). Coil temperature rise (1 Form C type)

Contact carrying current: 5 A, 10 A
Measured portion: Inside the coil

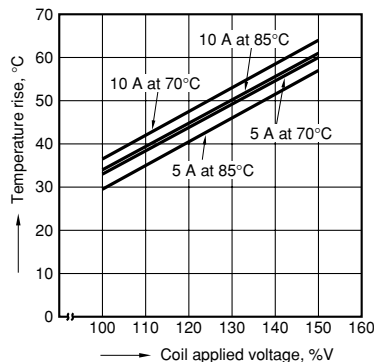

4-(1). Ambient temperature characteristics (1 Form A type)

Tested sample: JQ1aP-24V

Contact carrying current: 5 A, 10 A

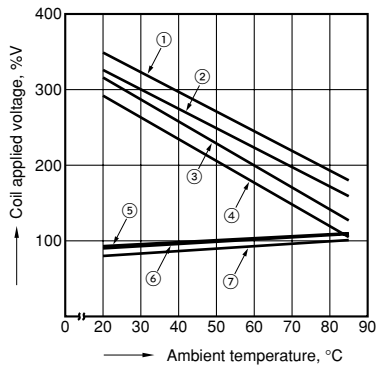

4-(2). Ambient temperature characteristics (1 Form C type)

Tested sample: JQ1P-24V

Contact carrying current: 5 A, 10 A

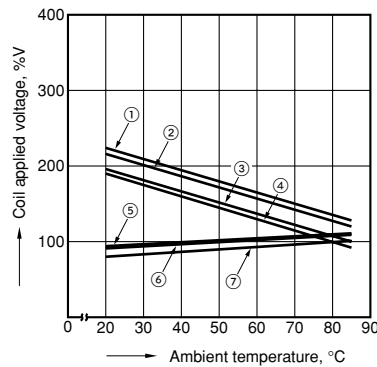

- ① Allowable ambient temperature against % coil voltage (max. inside the coil temperature set as 130°C 266°F) (Carrying current: 5 A)
- ② Allowable ambient temperature against % coil voltage (max. inside the coil temperature set as 130°C 266°F) (Carrying current: 10 A)
- ③ Allowable ambient temperature against % coil voltage (max. inside the coil temperature set as 115°C 239°F) (Carrying current: 5 A)
- ④ Allowable ambient temperature against % coil voltage (max. inside the coil temperature set as 115°C 239°F) (Carrying current: 10 A)
- ⑤ Pick-up voltage with a hot-start condition of 100%V on the coil (Carrying current: 10 A)
- ⑥ Pick-up voltage with a hot-start condition of 100%V on the coil (Carrying current: 5 A)
- ⑦ Pick-up voltage

For Cautions for Use, see Relay Technical Information

X-ON Electronics

Largest Supplier of Electrical and Electronic Components

Click to view similar products for [General Purpose Relays](#) category:

Click to view products by [Panasonic](#) manufacturer:

Other Similar products are found below :

[APF30318](#) [JVN1AF-4.5V-F](#) [PCN-105D3MHZ](#) [5JO-10000S-SIL](#) [5JO-1000CD-SIL](#) [5JO-400CD-SIL](#) [LY2S-AC220/240](#) [LYQ20DC12](#)
[6031007G](#) [6131406HQ](#) [6-1393099-3](#) [6-1393099-8](#) [6-1393122-4](#) [6-1393123-2](#) [6-1393767-1](#) [6-1393843-7](#) [6-1415012-1](#) [6-1419102-2](#) [6-](#)
[1423698-4](#) [6-1608051-6](#) [6-1608067-0](#) [6-1616170-6](#) [6-1616248-2](#) [6-1616282-3](#) [6-1616348-2](#) [6-1616350-1](#) [6-1616350-8](#) [6-1616358-7](#) [6-](#)
[1616359-9](#) [6-1616360-9](#) [6-1616931-6](#) [6-1617039-1](#) [6-1617052-1](#) [6-1617090-2](#) [6-1617090-5](#) [6-1617347-5](#) [6-1617353-3](#) [6-1617801-8](#) [6-](#)
[1617802-2](#) [6-1618107-9](#) [6-1618248-4](#) [M83536/1-027M](#) [CX-4014](#) [MAHC-5494](#) [MAVCD-5419-6](#) [703XCX-120A](#) [7-1393100-5](#) [7-1393111-7](#)
[7-1393144-5](#) [7-1393767-8](#)