

Overview of Calmark

OverviewPage 2, 3
 Product Selection GuidePage 4
 RequirementsPage 5

Conduction Cooling Products

Conduction Cooled AssembliesPage 6, 7
 Conduction Cooled KeyingPage 8, 9

Card-Lok Products

Series 223 & 224Page 10, 11
 Series 225Page 12, 13
 Series E225Page 14, 15
 Series L225Page 16, 17
 Series 226Page 18, 19
 Series 230Page 20, 21
 Series 231Page 22, 23
 Series 235Page 24, 25
 Series 236Page 26, 27
 Series 240Page 28, 29
 Series 245Page 30, 31
 Series 250Page 32, 33
 Series 255Page 34, 35
 Series 260Page 36, 37
 Series L260Page 38, 39
 Series LE260Page 40, 41
 Series 261Page 42, 43
 Series 263Page 44, 45
 Series 264Page 46, 47
 Series 265Page 48, 49
 Series 266Page 50, 51
 Series 267Page 52, 53
 Series 280Page 54, 55
 Series 281Page 56, 57

Channel-Lok Products

Series 227 & 228Page 58, 59

Retainers

Series 125/126 & 165/166Page 60
 Series NW125/NW126 & NW165/NW166.....Page 61

Card Guides

Series 115-287Page 62
 Series 120 & C120Page 63

Extractors, Plastic

Series 101 to 108Page 64, 65

Extractors, Metal

Series 107Page 66, 67
 Series 109Page 68

References

Technical ApplicationsPage 69
 Clamping Force Data - Card-LoksPage 70
 Thermal Resistance - Card-LoksPage 71
 Mounting & Installation for Card-Loks.....Page 72
 Theoretical Discussion of Card-Loks
 and Inserter ExtractorsPage 73
 Material & FinishesPage 74
 Technical Reference DataPage 75-83
 DSCC Cross ReferencePage 84
 GlossaryPage 85

Calmark, the home of the Card-Lok, designs and manufactures rugged printed circuit board guides, conduction frame assemblies and extractors for use in non-benign - airborne, shipborne, and rugged land transportation - environments.

Today, Pentair Technical Products markets the Calmark brand of products along with Birtcher® globally and Schroff® in the Americas, while complimenting these standard product brands with its own customer specific enclosure capabilities.

Pentair Technical Products, a subsidiary of Pentair, Inc., is a manufacturer of standard, modified standard and customer specific enclosure systems: capabilities range from backplane design, to NEBS enclosures, to outdoor (Telecordia compliant) aluminum enclosures, to high volume stamped chassis, and systems integration.

Pentair, Inc. (PNR-NYSE) is a highly successful, diversified corporation consisting of two core business groups.

Water Segment – a global leader in providing innovative products and systems used world wide in the movement, treatment, storage and enjoyment of water.

Technical Products Segment – is a leader in the global enclosures market, designing and manufacturing standard, modified, custom, thermal enclosures that house and protect sensitive electronics and electrical components.

Pentair Technical Products brands are market specific (see below) and are complimented by the groups thermal division which supports all markets.

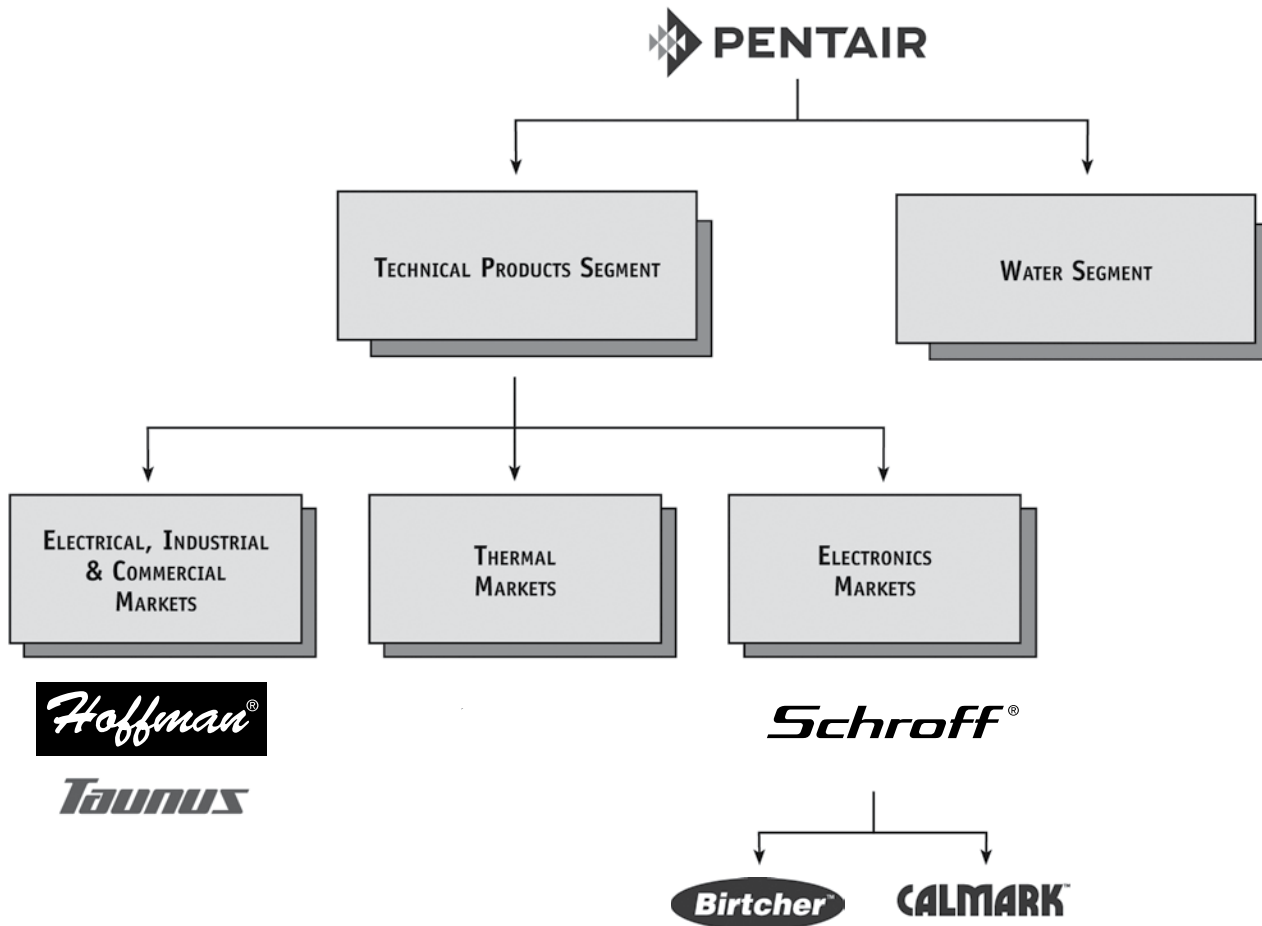



		NPI	Steel	Aluminum Outside Plant	Backplane Design	Chassis Assembly	Stamping	Testing	Finishing	System Integration	Capacity (SQ FT)
Americas	New England	✓	✓	✓	✓	✓		✓	✓	Level 1 to 4	113,000
	Illinois	✓	✓	✓		✓	✓	✓		Level 1 to 4	35,000
	Minnesota	✓	✓	✓				✓	✓	Level 1 to 2	945,000
	California		✓				✓	✓		Level 1 to 2	50,000
	Brazil	✓	✓	✓		✓		✓	✓	Level 1 to 4	170,000
	Mexico		✓	✓		✓	✓		✓	Level 1 to 2	250,000
Asia	China	✓	✓	✓		✓	✓	✓	✓	Level 1 to 3	220,000
	Japan		✓			✓	✓	✓	✓	Level 1 to 3	40,000
Europe	Germany	✓	✓		✓	✓	✓	✓	✓	Level 1 to 5	577,000
	France	✓	✓	✓		✓	✓	✓	✓	Level 1 to 3	205,000
	Poland	✓	✓	✓		✓		✓	✓	Level 1 to 3	110,000

Card-Lok									
Product Series	3 or 5 pc.	Actuation	Profile Width (nominal) x Relaxed Height (max)	Profile Height Expanded (min)	Length (min)	Approximate Clamping Force ² N(lbs)	Recommended Torque Setting N-cm (in-lbs)	DSCC	DSCC CID
223	5	Screw	5.72 (.225) x 6.86 (.270)	8.26 (.325)	121.9 (4.80)	tbd	limited		
224	5	Screw	5.33 (.210) x 7.24 (.285)	8.64 (.340)	121.9 (4.80)	tbd	limited		
225	3	Screw	5.72 (.225) x 6.86 (.270)	8.26 (.325)	54.61 (2.15)	489 (110)	68 (6)	84103	59590
E225	3	Screw	5.72 (.225) x 6.86 (.270)	8.26 (.325)	71.12 (2.80)	489 (110)	68 (6)		
L225	3	Lever	5.72 (.225) x 6.86 (.270)	8.26 (.325)	54.61 (2.15)	533 (120)	N/A		
226	5	Screw	5.72 (.225) x 6.86 (.270)	8.26 (.325)	121.92 (4.80)	800 (180)	68 (6)	89064	59789
230	3	Screw	5.59 (.220) x 5.72 (.225)	6.99 (.275)	54.61 (2.15)	489 (110)	68 (6)	84103	59590
231	5	Screw	5.59 (.220) x 5.72 (.225)	6.99 (.275)	121.92 (4.80)	800 (180)	68 (6)	89064	59789
235	3	Screw	5.84 (.230) x 7.32 (.288)	8.64 (.340)	71.12 (2.80)	445 (100)	68 (6)		
236	5	Screw	5.84 (.230) x 7.32 (.288)	8.64 (.340)	147.32 (5.80)	800 (180)	68 (6)		
240	3	Screw	6.10 (.240) x 4.57 (.180)	5.59 (.220)	54.61 (2.15)	489 (110)	68 (6)	84103	59590
245	3	Screw	6.60 (.245) x 6.86 (.270)	8.26 (.325)	54.61 (2.15)	622 (140)	113 (10)		59590
250	3	Screw	9.53 (.375) x 9.78 (.385)	11.94 (.470)	63.50 (2.50)	1111 (250)	227 (20)		59590
255	3	Screw	12.70 (.500) x 11.68 (.460)	15.24 (.600)	54.61 (2.15)	1778 (400)	351 (31)		59590
260	5	Screw	6.35 (.250) x 6.26 (.270)	8.26 (.325)	54.61 (2.15)	1778 (400)	68 (6)	89024	
261	3	Screw	6.35 (.250) x 6.26 (.270)	8.26 (.325)	54.61 (2.15)	667 (150)	68 (6)		59789
L260	5	Lever	6.35 (.250) x 6.26 (.270)	8.26 (.325)	54.61 (2.15)	556 (125)	N/A		59789
LE260	5	Lever	6.35 (.250) x 6.26 (.270)	8.26 (.325)	54.61 (2.15)	556 (125)	N/A		59789
263	5	Screw	6.35 (.250) x 7.44 (.293)	8.89 (.350)	54.61 (2.15)	1778 (400)	68 (6)		
264	3	Screw	6.35 (.250) x 7.44 (.293)	8.89 (.350)	54.61 (2.15)	667 (150)	68 (6)		59789
265	5	Screw	5.72 (.225) x 5.84 (.230)	7.37 (.290)	54.61 (2.15)	1556 (350)	68 (6)		
266	3	Screw	5.72 (.225) x 5.84 (.230)	7.37 (.290)	54.61 (2.15)	600 (135)	68 (6)		
267	5	Screw	6.35 (.250) x 5.00 (.197)	5.99 (.236)	54.61 (2.15)	1556 (350)	68 (6)		
280	5	Screw	9.27 (.365) x 9.65 (.380)	11.68 (.460)	60.96 (2.40)	3334 (750)	227 (20)		59789
281	3	Screw	9.27 (.365) x 9.65 (.380)	11.68 (.460)	60.96 (2.40)	1245 (280)	227 (20)		

Channel-Lok							
Product Series	3 or 5 pc.	Actuation	Width x Height (max)	Board Thickness	Length ¹ (min)	Approximate Clamping Force-N (lbs)	Recommended Torque Setting N-cm (in-lbs)
227	3	Screw	12.57 (.495) to 8.89 (.350)	1.14 (.045) to 2.62 (.103)	76.20 (3.00)	489 (110)	68 (6)
228	5	Screw	12.57 (.495) to 8.89 (.350)	1.14 (.045) to 2.62 (.103)	101.6 (4.00)	801 (180)	68 (6)

Retainers & Card Guides							
Product Series	Material	Conductive	Application	Board Thickness	Length ¹ (min)	UL rating	
125/126	CR	Yes	Sheet Metal	1.6 (.063) & 2.4 (.094)	31.75 (1.25) to 311.15 (12.25)	N/A	
165/166	BeCu	Yes	Sheet Metal	1.6 (.063) & 2.4 (.094)	31.75 (1.25) to 311.15 (12.25)	N/A	
NW125/NW126	CR	Yes	Cold Wall	N/A	31.75 (1.25) to 311.15 (12.25)	N/A	
NW165/NW166	BeCu	Yes	Cold Wall	N/A	31.75 (1.25) to 311.15 (12.25)	N/A	
120	Nylon	No	Sheet Metal	1.6 (.063) & 2.4 (.094)	101.60(4.00),152.40(6.00),177.8(7.00),215.90(8.50),241.30(9.50)	V-2 (V-0 available)	
C120	Polycarbonate	Yes	Sheet Metal	1.6 (.063) & 2.4 (.094)	101.60(4.00),152.40(6.00),177.8(7.00),215.90(8.50),241.30(9.50)	V-2 (V-0 available)	

Plastic Extractors & Inserter-Extractors					
Product Series	Material	Function ⁴	Mechanical Advantage	Board Thickness	UL Rating
107	Glass-filled Nylon	I & E	4.5:1	1.6 (.063) & 2.4 (.094)	V-0
107-10	Glass-filled Nylon	I & E	3.3:1	1.6 (.063) & 2.4 (.094)	V-0
107-20	Glass-filled Nylon	I, E & L	4.5:1	1.6 (.063) & 2.4 (.094)	V-2 (V-0 available)
107-30	Glass-filled Nylon	I & E	5.5:1	1.6 (.063)	V-0
107-40-3	Glass-filled Nylon	I & E	4.5:1	1.6 (.063) & 2.4 to 3.2 (.094 to .125)	V-0
107-70	Glass-filled Nylon Latch - Nylon	I, E & L	4.5:1	1.6 (.063), 2.4 (.094) & 3.2 (.125)	V-0 (Inserter-Extractor) V-2 (Latch)

Metal Extractors & Inserter-Extractors					
Product Series	Material	Function ⁴	Mechanical Advantage	Board Thickness	
107-35	Al	I & E	5.5:1	1.6 (.063), 2.4 (.094) & 3.2 (.125)	
107-50	Al	I & E	4.5:1	1.6 (.063), 2.4 (.094) & 3.2 (.125)	
107-51	Al	I & E	3.3:1	1.6 (.063), 2.4 (.094) & 3.2 (.125)	
107-55	Al	I & E	8.0:1	1.6 (.063), 2.4 (.094) & 3.2 (.125)	
107-73	Al	I, E & L	4.2:1	1.6 (.063), 2.4 (.094) & 3.2 (.125)	
107-75	Al	I, E & L	7.0:1	1.6 (.063), 2.4 (.094) & 3.2 (.125)	
109	Al or CR	E	4.5:1	1.6 (.063), 2.4 (.094) & 3.2 (.125)	

1-Other assembly lengths available upon request 2-Clamping forces based on Chemical Film Option - Other finishes and options will yield different results
3-101 available in 1.6 (.063) only 4-Function: E=Extract I=Insert L=Latch or Lock 5-Units are metric (inch)

Finish & Plating

The Calmark product line offers a wide variety of standard finishes for products. Most of the components are made of aluminum or stainless steel. The standard finishes are:

For Aluminum, standard finishes include:

- Chemical Film per Mil-DTL-5541 Type 1 (non-RoHS) Class 1A or 3, Gold
- Chemical Film per Mil-DTL-5541 Class 3, Type I, Gold for Shafted Products
- Chemical Film per Mil-DTL-5541 Class 3, Type II, Clear
- Black Anodize per Mil-A-8625 Type II, Class 2
- Hard Black Anodize per Mil-A-8625 Type III, Class 2
- Electroless Nickel per Mil-C-26074 Class 4, Grade B, Bright

For Stainless steel, standard finish is:

- Passivation per AMS 2700

For BeCu, standard finishes include:

- Tin Plate per Mil-T-10727 Type I, Bright
- Nickel Plate per QQ-N-290 Class I, Grade F
- Electroless Nickel per Mil-C-26074 Class 4, Grade B, Bright
- Zinc Plate per ASTM-B633 Type III (Clear), SC1

For Plastic card guides and extractors:

- Color coding is available for Natural/White card guides and extractors
- Standard colors are BLK and Natural; other colors available upon request.

RoHS - Restriction of Hazardous Substances

The Calmark product line offers several product configurations to meet the requirements of the European Directive 2002/95/EC for Restriction of Hazardous Substances. This European Directive affects primarily the aluminum components that are finished with a gold chemical film process. This process uses a hexavalent chromium (Cr+6). An option for clear chemical film process using a trivalent chromium (Cr+3) has been added for those needing to meet this requirement. Contact one of our applications engineers for more details regarding the RoHS requirements of specific items.

DFARS 252.225-7014 & Alt 1. Preference for Domestic Specialty Metals Clause

Calmark products can support the needs of Prime Contractors and Subcontractors supplying product to the DOD, particularly the Preference for Domestic Specialty Metals Clause. This clause is applicable to DOD Prime Contract Awards exceeding the simplified acquisition threshold, of products, components and assemblies for use in Aircraft, Missile and Space Systems, Ships, Tank and Automotive Items, Weapon Systems or Ammunition. For the Calmark product line, this affects the hardware, components and materials that are made of stainless steel. At the time of this writing, all COTS items which include all part numbers configurable in this catalog are exempt from the Preference for Domestic Specialty Metals Clause for Prime Contract Awards after October 25, 2007. Fastener DNAD waivers are also available for Prime Contract Awards between April 10, 2007, and July 26, 2008. There are many other exemptions available.

We recognize that each of our customers has a different method for handling this requirement, so we have implemented a process that we feel will handle the great majority of our customers' requirements. Because at this time, the Class Deviations are not retro-active, in order to best respond to your needs, we do require that all quotations and purchase orders note this requirement along with the Prime Contract Number. We do charge for a signed DFARS 252.225-7014 & Alt 1. Statement Sheet that must go along with your order. For those customers that can use the COTS exemption, we offer free of charge documents that you can download from our website. The Product Sheets will indicate from the Statement Sheet which statement applies for your product of interest. If these documents meet your needs, please indicate this in your quotation or P.O. Of course, for those customers that need a signed Statement Sheet, we can also accommodate this requirement at an additional fee.

DSCC - Defense Supply Center - Columbus

Calmark also provides as a standard offering products that meet many of the specifications defined by Defense Supply Center – Columbus. Calmark has incorporated the DSCC part numbers as a standard product offering to get the proper specification requirements by the addition of a "CM-" prefix to the DSCC part configuration for our internal part number system. The DSCC part number will be part of the description. All part numbers defined in the DSCC specifications are considered COTS items for Calmark.

Design Flexibility – Common Modifications

The Calmark product line offers an extremely broad range of configurations, not all of which are detailed in this catalog. Calmark is set up to handle these requests. Contact one of our Applications Engineers and a unique part number will be assigned for you for a product that meets your specification. Some of the modifications available include:

- 7 and 9 or more wedge segments
- Lengths outside of our standard catalog product offering
- Relocation or addition of mounting holes
- Tapped holes other than the standard catalog product offering
- Screw head activation different from M2.5 and 3/32 hex socket
- Specific individual wedge dimensions different from the catalog offering
- Replacement of split washers with Belleville washers
- Materials with different alloys from the catalog offering
- Different finish from those offered in the catalog
- Different lever lengths than those offered in the catalog
- Different hardware than standard offering including screw threads, thread-locking mechanism and bonded washers
- Secured wedges
- Ejection feature similar to E225 may be implemented on other Series profiles
- Modification of extractors
- Hot stamp of plastic parts to your requirements
- Silkscreen per your requirements

Our applications engineers can help you specify a cost effective design that will work for your application. The catalog offers the configurations that meet most applications, but if you don't see what you're looking for in the catalog, please call us. Odds are, we've already done something very similar.

Warranty

Pentair Technical Products' Warranty is guaranteed from defects for 1 (one) year after shipment.

Conduction Cooled Assemblies consist of a conduction cooled frame, backing plate or backing strips, extractors and wedge clamps. They are designed for circuit boards requiring cooling in severe environments where convection cooling is not practical. The assembly also provides needed structural support of the plug-in module during extremely high shock and vibration applications. Optional configuration for compliance to IEEE 1101.2 and VITA 30.1.

Calmark offers a standard design that takes the guesswork out of the perimeter of the assembly. The component area can be customized to match your board and application.

FEATURES

- Conduction frames available in 3U or 6U, VME or cPCI based designs
- Can accommodate ccPMC or XMCs
- Extractors provide ample force to disengage board connectors
- Available in Black Anodize, Chem film or Electroless Nickel plating for excellent corrosion resistance
- 6061-T6 aluminum provides high thermal conductivity as well as lightweight support
- Locking Helicoils secure board fasteners in extreme vibration environments
- High performance five piece wedge clamp provides high clamping force with even pressure distribution for low thermal resistance
- Frame and backing plate are each machined from a solid piece to assure high heat transfer and structural integrity
- Custom silkscreen available

ACCESSORY

- Code Keys prevent VME64x Conduction Cooled Assemblies from inadvertent insertion into the wrong slot



Custom Conduction Cooled Frames

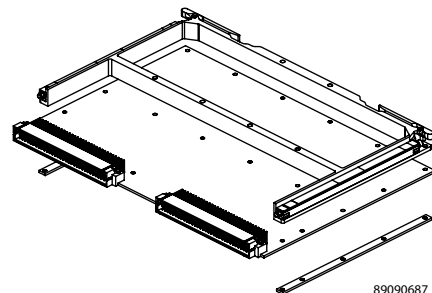
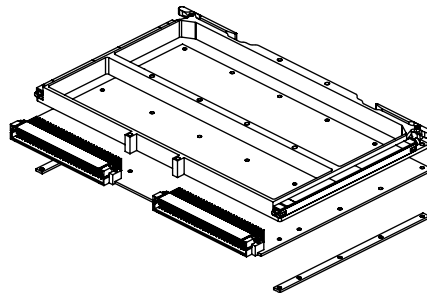
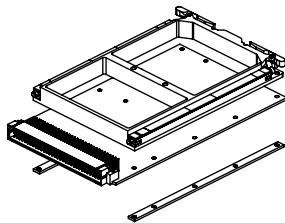
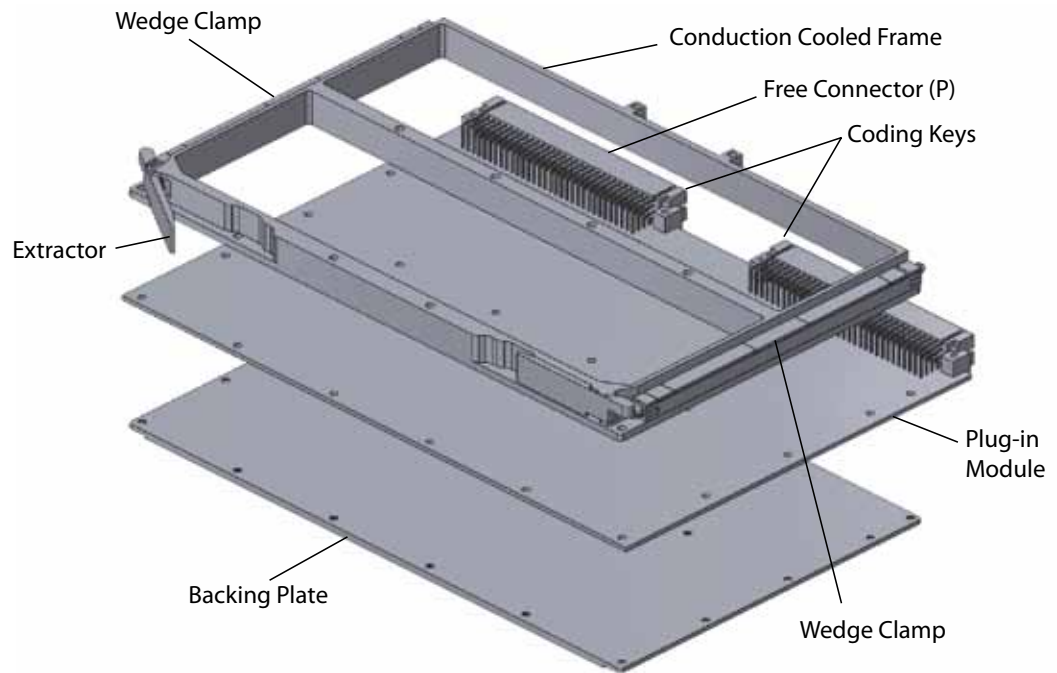

89090687

3U and 6U designs are available with compliance to IEEE 1101.2 and VITA 30.1 specifications. Conduction Cooled PMC modules can be incorporated per VITA 20.

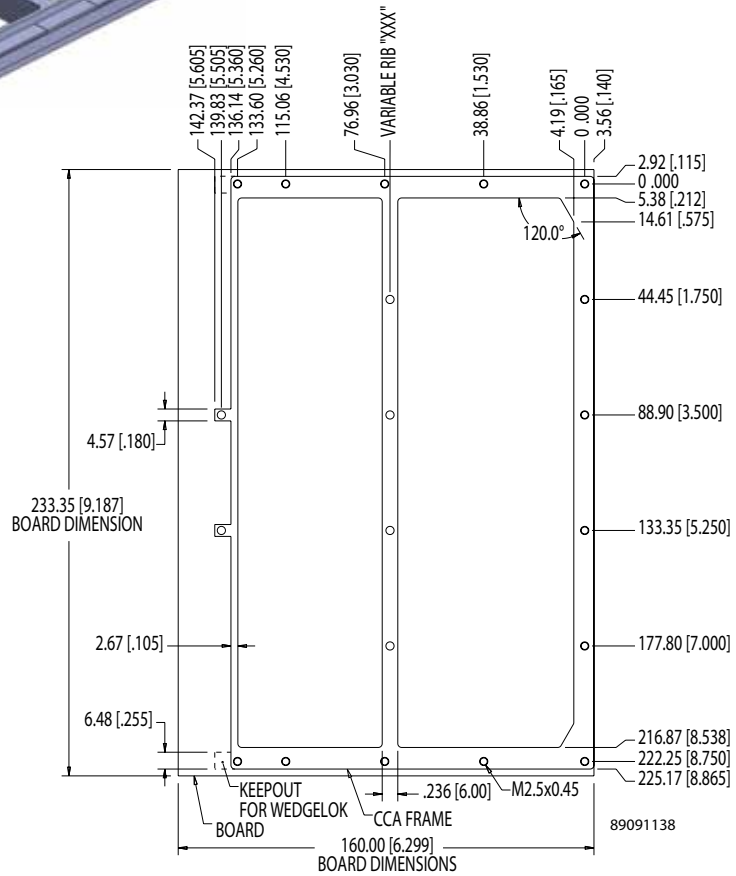

Part Number Code Conduction Cooled Assemblies

	CC	B	3	V	XXX	G	B16	L
Version _____		B						
3U _____			3					
6U _____			6					
VME (1101.2) _____				V				
cPCI (VITA 30.1) _____				C				
Center rib location (mm.m) _____					XXX			
PMC for ccPMC mounting _____					PMC			
Gold Chemical Film Finish or choose from Finish Table						G		
Backing Thermal strip 1.6mm							B16	
Backing Thermal strip 2.4mm							B24	
Backing Plate 1.6mm							P16	
Backing Plate 2.4mm							P24	
Latching Extractor handle _____								L
no latching _____								[blank]

Part Number Code Example:

CCB3VPMCBP16L

Conduction Cooled Assembly 3U VME designed with ccPMC mounting, black anodized, with 1.6mm backing plate and latching extractors

FINISH TABLE

Code Letter	Finish
"G"	Gold Chemical Film per Mil-DTL-5541 Class 1A, Type 1
"R"	Clear Chemical Film per Mil-DTL-5541 Class 3, Type II
"CC"	Clear Chemical Film per Mil-DTL-5541 Class 1A, Type II
"B"	Black Anodize per Mil-A-8625 Type II, Class 2
"N"	Electroless Nickel per Mil-C-26074 Class 4, Grade B, Bright

Calmark has the answer for those IEEE 1101.10 applications with keying requirements, but do not have front panels. IEEE 1101.10 specifications provides a method for keying slots using programming keys inserted into the front panel assembly and card guide.

Conduction Cooled Modules used in military and ruggedized systems do not use this front panel system. VITA 1.6 standard provides a method of keying for these types of systems.

FEATURES

- Complies with ANSI VITA 1.6 Standard
- Gold or Clear Chem Film aluminum bracket
- 6 configurations per coding bracket set
- 36 configurations in a 6U conduction cooled application
- Up to 1296 Keying combinations in a 6U non-conduction cooled application
- Complimentary mounting hardware included

CODEKEY BRACKETS

Material:

Aluminum Alloy
6061-T6 QQ-A-200/8

Finish:

Mil-C Class 1A, Type 1, Gold or
Mil-DTL-5541 Class 3, Type II, Clear

CODE PINS

Material:

Austenitic Stainless Steel

Finish:

None

WEIGHT

100 pcs. = 0.32 lbs.

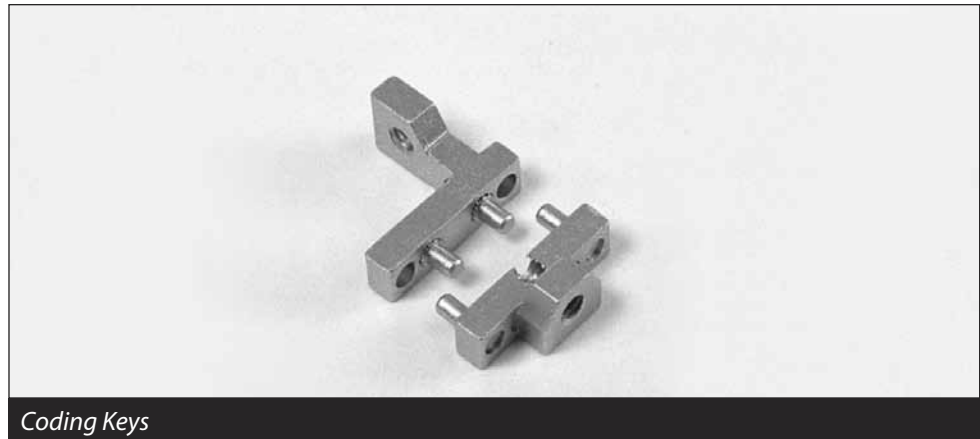

Coding Keys

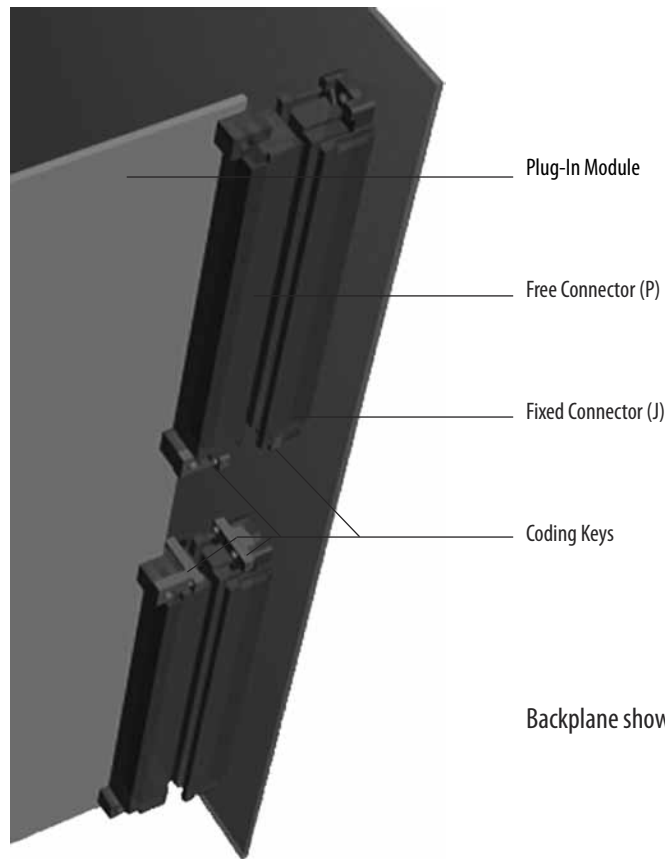

Backplane shown - without J0 for clarity

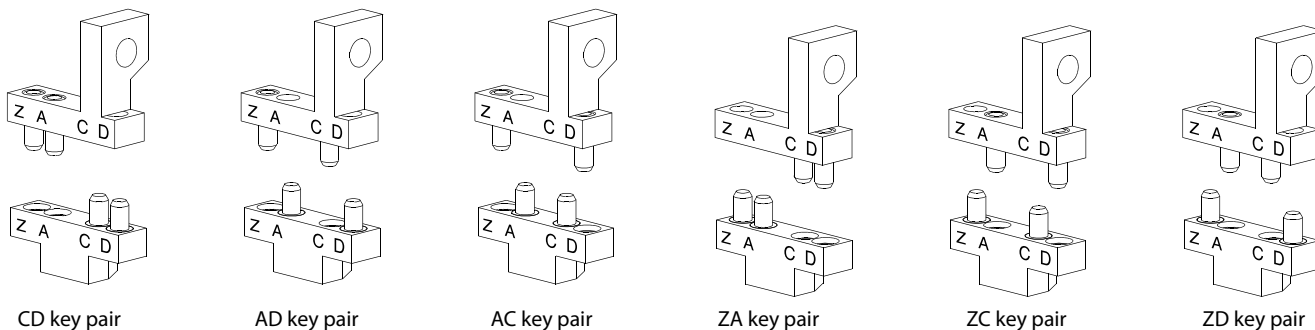

The drawings above are representative of the J32 and P32 configurations. J01 and P01 are mirror images.

Samples of coding key usage

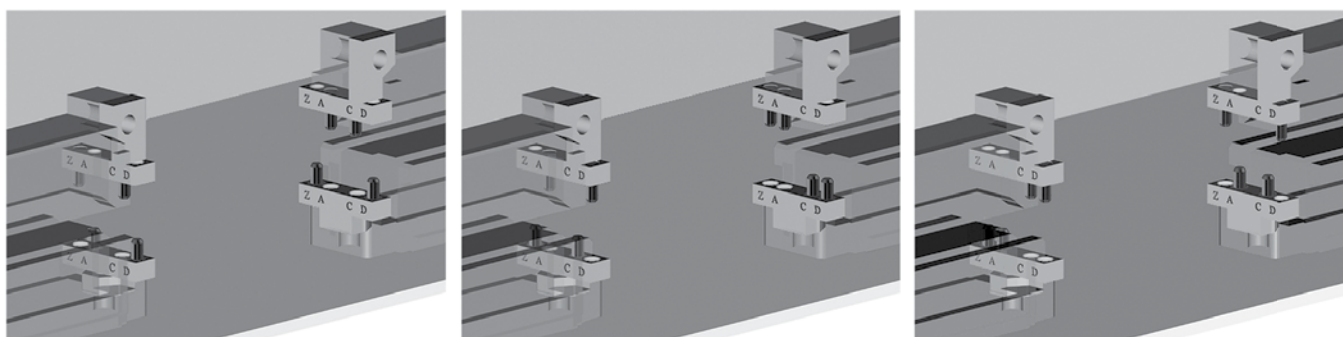

CCKP01-AD
mates with
CCKJ01-AD

CCKP32-ZD
mates with
CCKJ32-ZD

CCKP01-ZC
mates with
CCKJ01-ZC

CCKP32-CD
mates with
CCKJ32-CD

CCKP01-ZA
mates with
CCKJ01-ZA

CCKP32-AC
mates with
CCKJ32-AC

Part Number Code Conduction Cooled Keying	
CCK	X X - X - X - X
Board or Backplane	
Free Connector:	P
Fixed Connector:	J
Connector End	
01	01
32	32
Keying Configuration	
ZA	ZA
ZC	ZC
ZD	ZD
AC	AC
AD	AD
CD	CD
Thread Type	
Metric 2.5mm x .45 thread:	[blank]
Imperial 2-56 thread:	1
Imperial 2-56 locking helicoil:	2
Metric 2.5mm x .45 locking helicoil:	3
Finish Type	
Chem Film Gold	[blank]
Chem Film Clear	CC

Also available in Kit Form (see contents example below)	
CCK-KIT	-X -X
Keying Configuration	
ZA	ZA
ZC	ZC
ZD	ZD
AC	AC
AD	AD
CD	CD
Thread Type	
Metric 2.5mm x .45 thread:	[Blank]
Imperial 2-56 thread:	-1
Imperial 2-56 locking helicoil:	-2
Metric 2.5mm x .45 locking helicoil:	-3
Example of Kit Contents:	
CCK-KIT-ZA	
Qty	Item
1	CCKP01-ZA
1	CCKJ01-ZA
1	CCKP32-ZA
1	CCKJ32-ZA
4	Complimentary Mounting Screws
4	Washers

Calmark offers the New Series 223 and 224 Card-Lok retainer for cold plate – heat exchanger applications. Available in a 5.72 x 6.60 (.225 x .260, Series 223) profile and a 5.33 x 6.99 (.210 x .275, Series 224) profile, these series of Card-Loks feature a torque-limiting design to eliminate the need for a torque wrench. The torque-limiting feature will prevent the Card-Lok from damage to itself or the board module assembly due to over-tightening.

FEATURES

- **Torque-Limiting Action** – A standard hex wrench locks the board module assembly into the cold wall providing a safe clamping force without the need for a torque wrench
- **High Reliability** – Screw actuated wedge action locks board module assemblies into place
- **Maximum Thermal Transfer** – Wedge action design provides maximum contact between thermal paths on board module assembly and heat sinking surface
- **Maximum Resistance to Shock & Vibration** – Wedge action design locks board module assembly in place to provide maximum resistance to shock and vibration
- **Zero Insertion & Extraction Forces** – Screw actuation provides zero insertion and extraction force on board module
- **Alignment Spring Feature** – returns wedge bodies to relaxed position when unclamping

WEDGES

Material:

Aluminum alloy 6061-T6 per ASTM-B221 or AMS-QQ-A-200/8

Finish:

See Finish Table

TORQUE-LIMITING MECHANISM

Material:

Stainless Steel 17-4 PH

Finish:

Dry Film Lube per Mil-L-46010 Type 1

SCREW

Material:

Stainless steel per ASTM-A582

Finish:

Passivate per AMS2700



Series 223 & Series 224 Torque-Limiting "Card-Lok" Patent no. 7,883,289

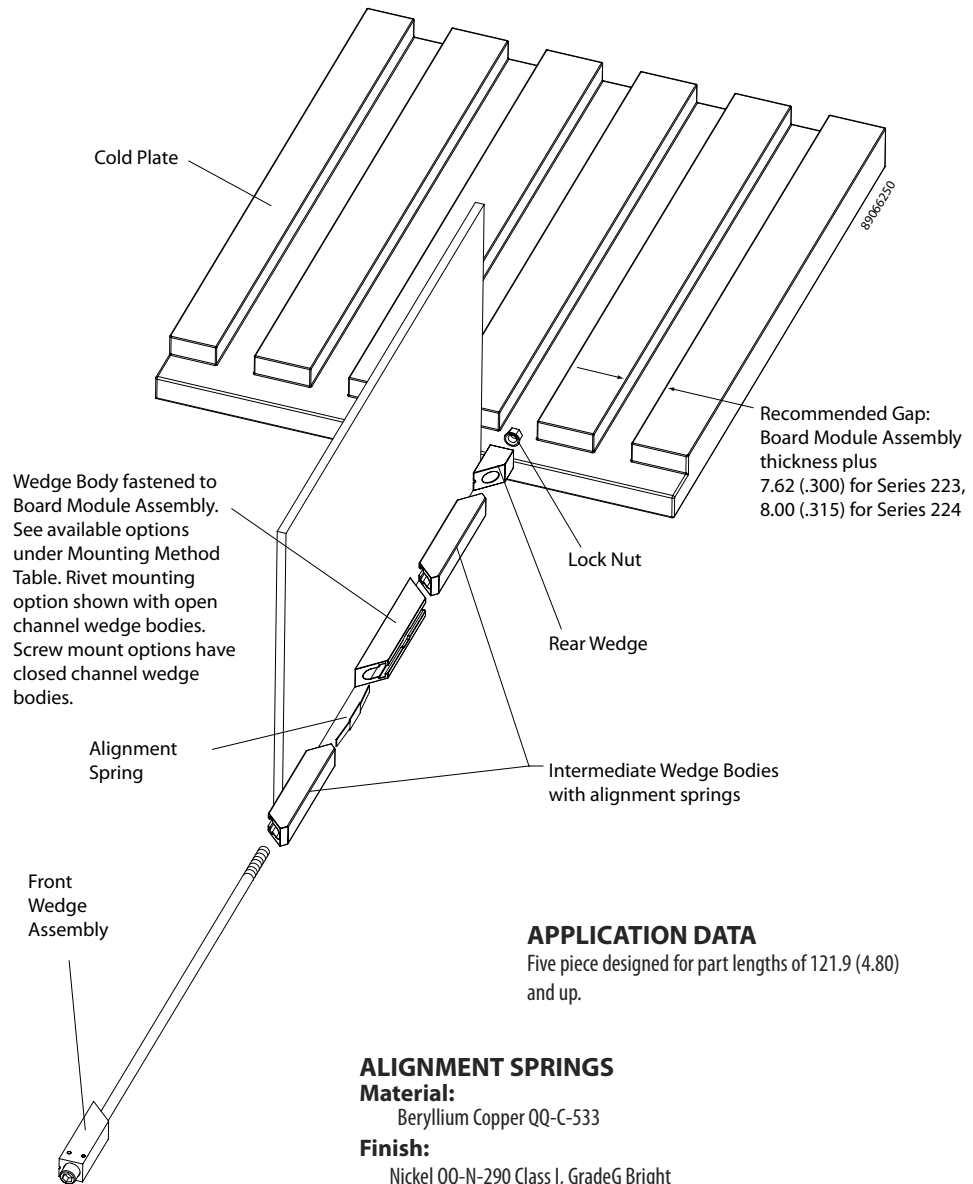

APPLICATION DATA

Five piece designed for part lengths of 121.9 (4.80) and up.

ALIGNMENT SPRINGS

Material:

Beryllium Copper QQ-C-533

Finish:

Nickel QQ-N-290 Class I, Grade G Bright

WEIGHT

1.12g/cm (.1oz/in)

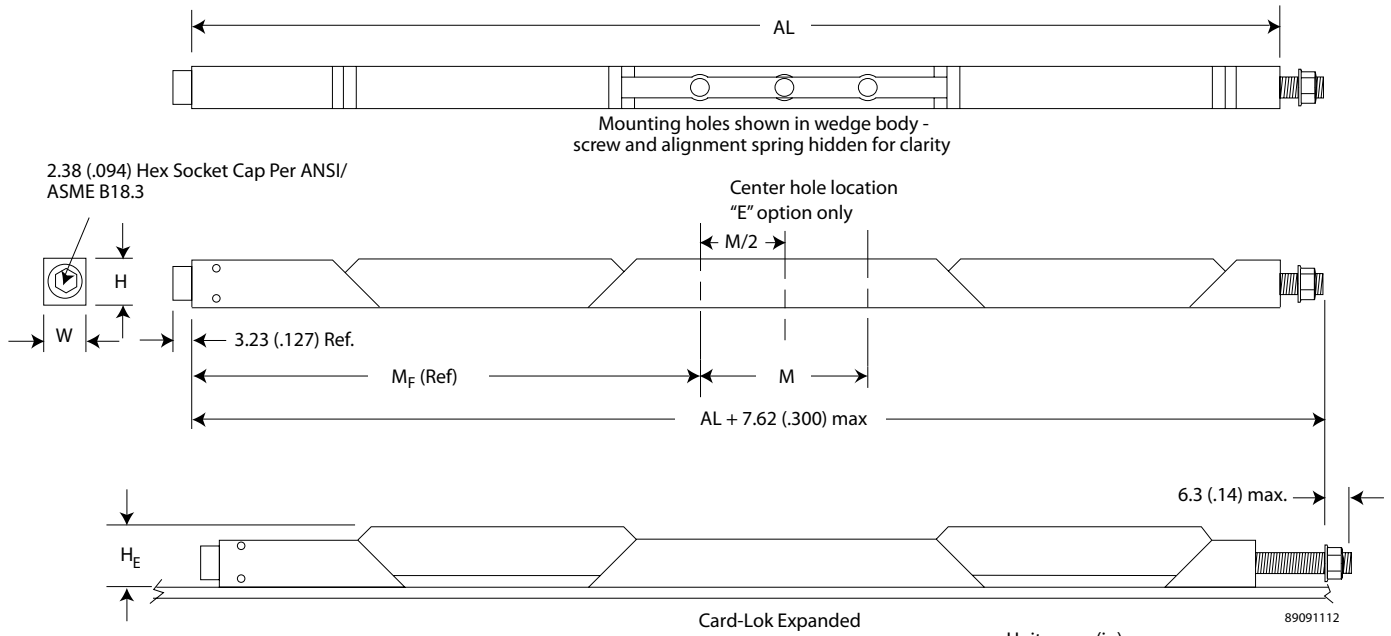

Card-Lok above shown with open channel wedge bodies for rivet mounting option. Screw mounting options have closed channel wedge bodies and will ship assembled.

Units: mm (in)
 Unless otherwise specified:
 .xx ± .25, .x ± .5 (.xxx ± .010, .xx ± .02)
 Note: Each piece has a tolerance of ± .010

Series	W	H max	H _E min.	AL range ± 1.3 (.050)	M ± .13 (.005)	M _F ± .76 (.030)
223	5.72 (.225)	6.86 (.270)	8.26 (.325)	From 121.9 (4.80) - 190.4 (7.49)	22.86 (.90)	AL ± 12.5 (.500) - M
				From 190.5 (7.50) - 215.9 (8.49)		
224	5.33 (.210)	7.24 (.285)	8.64 (.340)	From 216.0 (8.50) - 329.9 (12.99)	73.66 (2.90)	2

Part Number Code
Series 223 TL Card-Lok Five Piece
Series 224 TL Card-Lok Five Piece

Prefix options
 Black Anodize _____ A
 or choose from Finish Table

Suffix options
 Assembly length in inches. Standard lengths are 96.52 (3.80) and 121.9 (4.80).
 Other lengths available upon request. _____ length.xx

Additional Center Mounting Hole _____ E
 None _____ [blank]

Mounting options
 2-56 tapped mounting hole _____ T2
 or choose from Mounting Method Table

A 223 - 4.80 E T2 R

Part Number Code Example:

A224- 5.00T2R

Series 224 Card-Lok 5 piece 127.0 (5.0) long assembly length, black anodized with two 2-56 threaded mounting holes and lock nut

FINISH TABLE

Code Letter	Finish
[blank]	Chemical Film Finish Gold per Mil-DTL-5541, Type 1 Class 1A
"R"	Chemical Film Finish Clear per Mil-DTL-5541, Class 3 Type II
"A"	Black Anodize per Mil-A-8625, Type II, Class 2
"HA"	Hard Black Anodize per Mil-A-8625, Type III, Class 2
"EN"	Electroless Nickel per Mil-C-26074, Class 4 Grade B, Bright

MOUNTING METHOD TABLE

Code Letter	Method
"H"	Rivet Mounting Ø1.70 (.067) hole with 3.96 (.156) counterbore x 5.08 (.200) deep and 100° x 3.56 (.140) countersink "H" is available only for open channel version.
"TO"	0-80 tapped hole
"T2"	2-56 tapped hole
"TM2"	M2 x 0.40 tapped hole
"TM2.5"	M2.5 x 0.45 tapped hole

Calmark offers the Series 225 "Card-Lok" Retainer for cold plate-heat exchanger applications. This is an economical wedge clamp retainer for high efficiency heat transfer from Board Module Assembly to Cold Wall.

FEATURES

- Maximum Reliability – Screw-actuated wedge action locks Board Module Assembly in place
- Maximum Thermal Transfer – Wedge action design provides maximum contact between thermal paths on Board Module Assembly and the heat sinking surface
- Maximum Resistance to Shock & Vibration – Wedge action design locks Board Module Assembly in place to provide maximum resistance to shock and vibration
- Zero Insertion & Extraction Forces – Screw actuation provides zero insertion and extraction force on Board Module Assembly
- Design Flexibility – Special lengths, finishes or other design variations available on request

BODIES & WEDGES

Material:

Aluminum alloy 6061-T6 per ASTM-B221 or AMS-QQ-A-200/8

Finish:

See Finish Table

SCREW

.093 in or 2.5 mm hex. drive socket head cap screw

Material:

Stainless steel per ASTM-A582

Finish:

Passivate per AMS2700

WEIGHT

1.34 g/cm (.120 oz/in)

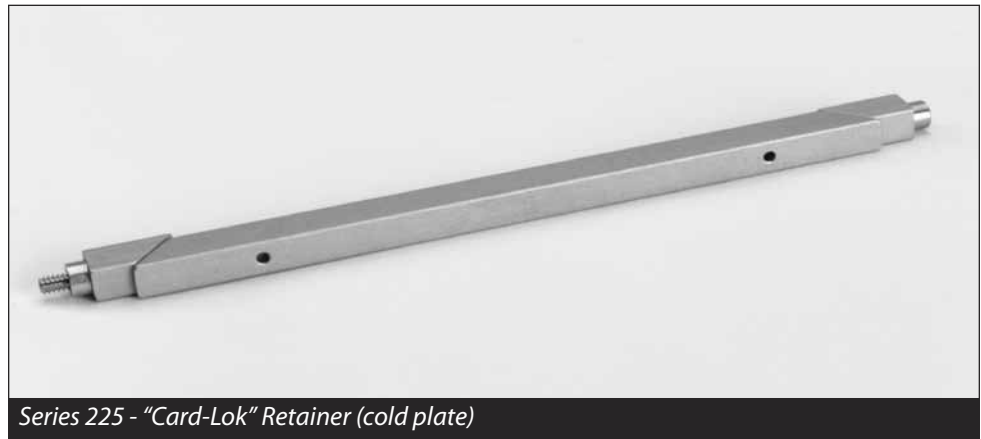

Series 225 - "Card-Lok" Retainer (cold plate)

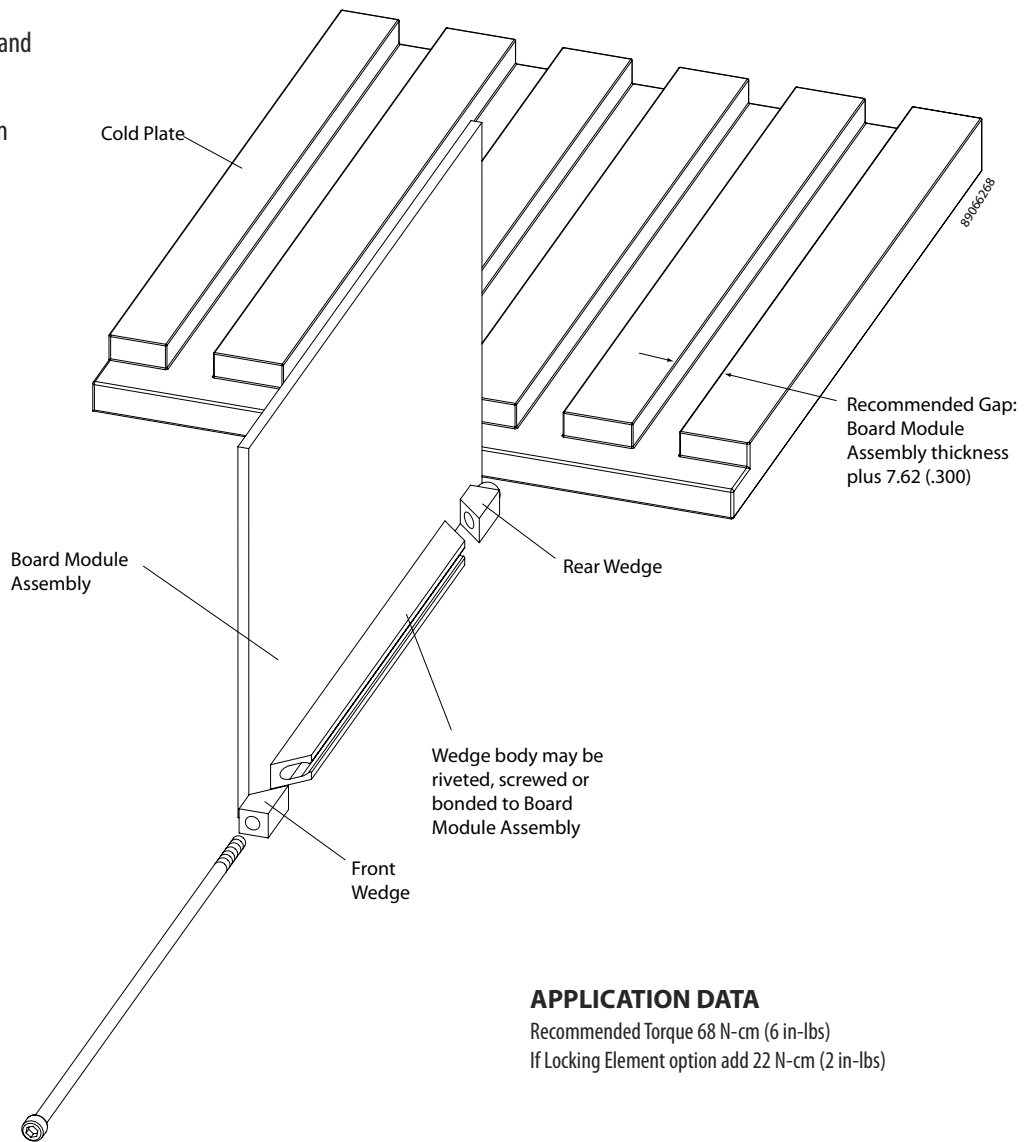

APPLICATION DATA

Recommended Torque 68 N-cm (6 in-lbs)
If Locking Element option add 22 N-cm (2 in-lbs)

OPTION PREFIX

Detail "V"

Provides visual lock indication.

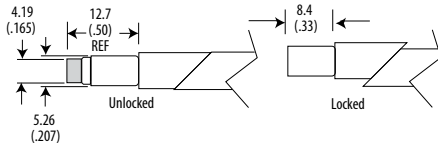

Detail "W"

Provides added resistance to loosening from shock and vibration. This option adds 2.5 (.10) to the screw length unless combined with the "R" suffix option, then adds 5.1 (.20) total.

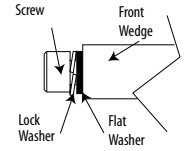

OPTION SUFFIX

Detail "L"

Provides prevailing torque for resistance to loosening from shock and vibration. Adds 22 N-cm (2 in-lbs) of torque to assembly. See application data on previous sheet.

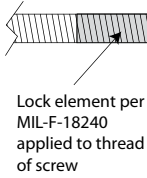

Detail "R"

Reduces the possibility of unintentional disassembly of the screw from rear wedge. This option adds 2.5 (.10) to the screw length unless combined with the "W" suffix option, then 5.1 (.20) total.

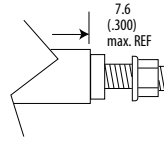

Detail "K"

Prevents the unintentional disassembly of screw from rear wedge. This option adds 5.1 (.20) to the screw length.

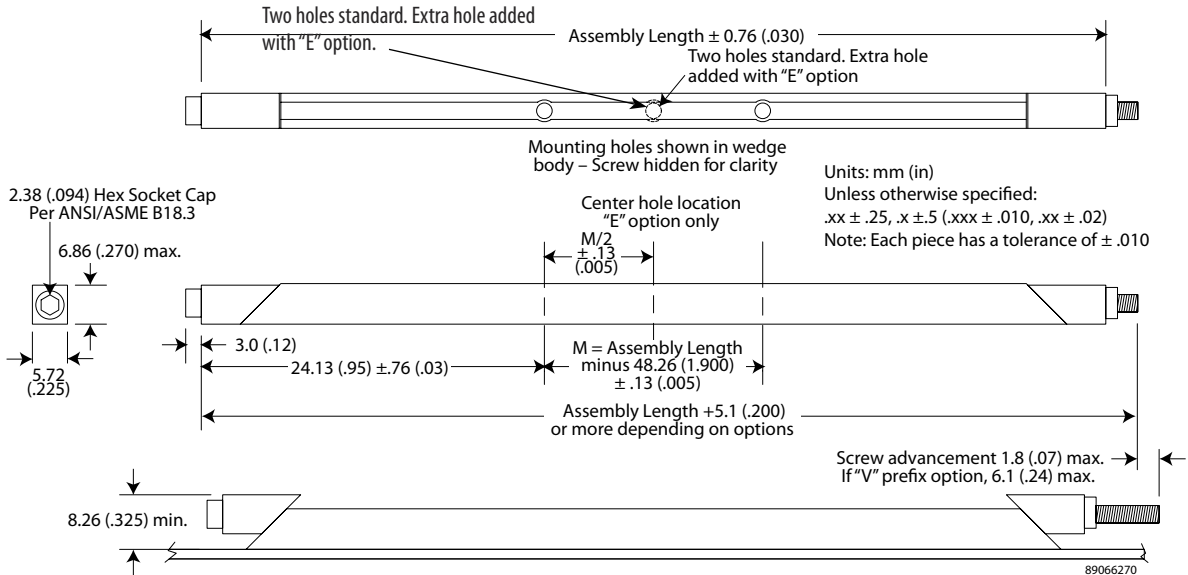
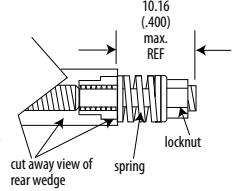

Part Number Code Series 225 Card-Lok Three Piece

None [blank] M W V A 225 - 3.80 E H L R

Prefix options

- Metric Screw Head M2.5 Hex Drive M
- Standard Screw Head 3/32 [blank]
- Lock and Flat Washer W
- None [blank]
- Visual Indicator V
- No Visual Indicator [blank]
- Black Anodize A
- or choose from Finish Table see table

Suffix options

- Stainless Steel Captive (and Lock Nut if "R" option is also selected) CR
- Standard Plated Steel "-"

Assembly length in inches. Standard lengths are 71.12 (2.80), 96.52 (3.80) and 121.9 (4.80). Other lengths available upon request. length.xx

- Additional Center Mounting Hole E
- None [blank]
- Mounting Options - holes for rivet mounting H
- or choose from Mounting Option Table see table
- Lock Element L
- None [blank]
- Lock Nut R
- Captive Screw K
- None [blank]

Part Number Code Example:

VA225CR4.80HR
Series 225 Card-Lok three piece 121.9 (4.80) long with Visual Indicator, Black Anodized Finish, standard rivet mounting hole and stainless steel captive nut and lock nut option

FINISH TABLE

Code Letter	Finish
[blank]	Chemical Film per Mil-DTL-5541 Class 1A, Type 1, Gold
"R"	Chemical Film per Mil-DTL-5541 Class 3, Type II, Clear
"A"	Black Anodize per Mil-A-8625 Type II, Class 2
"HA"	Hard Black Anodize per Mil-A-8625 Type III, Class 2
"EN"	Electroless Nickel per Mil-C-26074 Class 4, Grade B, Bright

MOUNTING METHOD TABLE

Code Letter	Method
[blank]	No mounting holes
"H"	Rivet Mounting Ø1.70 (.067) hole with 3.96 (.156) counterbore x 5.08 (.200) deep and 100° x 3.56 (.140) countersink
"T0"	0-80 tapped hole
"T2"	2-56 tapped hole
"TM2"	M2 x 0.40 tapped hole
"TM2.5"	M2.5 x 0.45 tapped hole

Calmark offers the feature of Ejection of the PC Card with its Series 225 "Card-Lok" Retainer. The Series E225 provides initial ejection of the PC card without damaging circuits, components or bending connector pins. Ejector feature E is also available on other Card-Lock Series on request.

FEATURES

- **Safe and Easy Ejection of PC Card** – Screw actuation produces a jacking force that disengages the PC card from its mating connector
- **Maximum Reliability** – Screw-actuated wedge action locks PC card in place
- **Maximum Thermal Transfer** – Wedge-action design provides maximum contact between thermal path on PC card and the heat sink surface
- **Maximum Resistance to Shock & Vibration** – Wedge action design locks PC card in place to provide maximum resistance to shock and vibration
- **Zero Insertion & Extraction Forces** – Screw actuation provides zero insertion and extraction force on PC card
- **Design Flexibility** – Special lengths, finishes or other design variations available on request

MATERIALS & FINISHES BODY & WEDGES

Aluminum alloy 6061-T6 per ASTM-B221 or AMS-QQ-A-200/8

Finish:

See Finish Table

SCREW

Stainless Steel per ASTM-A582 or

Finish:

Passivate per MIL-S-5002

RETAINER RING

Stainless Steel per ASTM-A582

Finish:

Passivate per MIL-S-5002

THREADED INSERT

MS122116, MS21209-C0210 (locking), 50253-1064

TOLERANCES

.xxx +/- .010 .xx +/- .02
(.xx +/- 0.25 .x +/- 0.5)

NOTES

Clamping characteristics are the same as standard Series 225.

"E" feature available on other Card-Lok series on request.



Series E225 - "Card-Lok" Retainer (ejector)

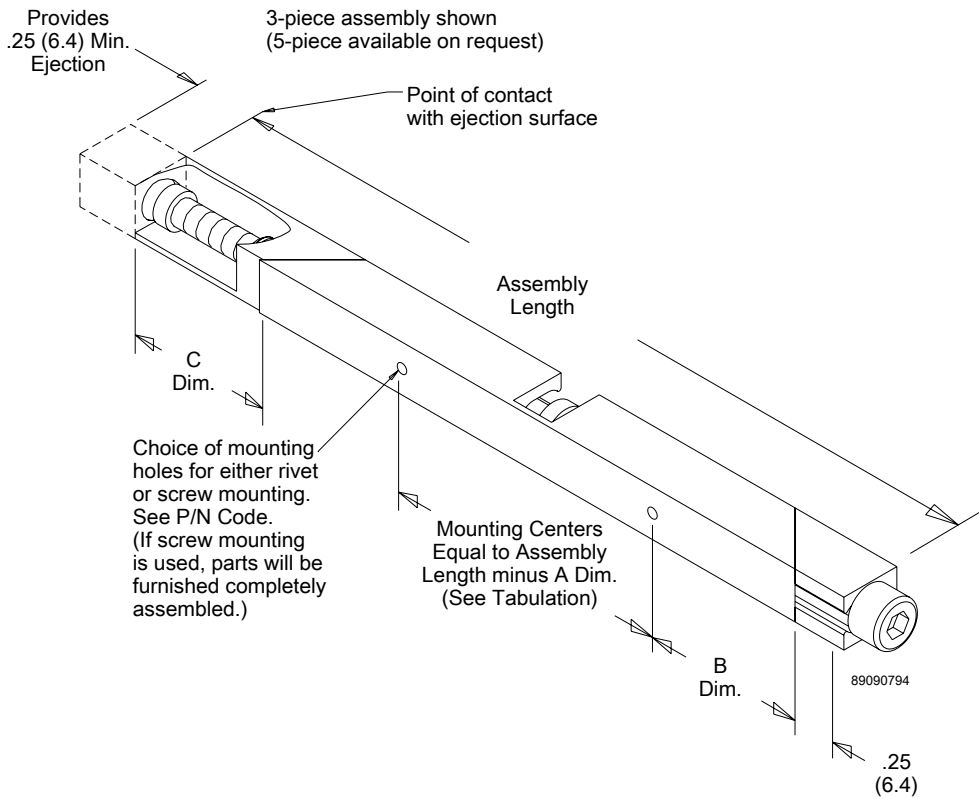

APPLICATION DATA

All mounting options except for "H" (rivet mouting), parts are completely assembled for shipping.

For "H" (rivet) Mounting Option, the screw assembly and wedge body are shipped unassembled.

Assemble parts as follows:

1. Rivet Wedge Body to Printed Circuit Board.
2. Insert Screw Assembly into Wedge Body.
3. Collapse Wedge Body to captivate screw assembly.

Calmark offers Series L225 Lever-Lok ("Card-Lok") Retainer which provides tool free, lever action locking on the Series 225 configuration "Card-Lok."

FEATURES

- High Reliability – Lever-actuated wedge action locks Board Module Assembly in place
- High Thermal Transfer – Wedge action design provides maximum contact between thermal path on Board Module Assembly and heat sink
- High Resistance to Shock & Vibration – Wedge action design locks Board Module Assembly in place to provide excellent protection against severe shock and vibration
- Zero Insertion & Extraction Forces – Lever actuation provides zero insertion and extraction force on Board Module Assembly
- Design Flexibility – Special lengths, finishes or other design variations available on request

MATERIALS & FINISHES

BODY & WEDGES

Aluminum alloy 6061-T6 per ASTM-B221 or AMS-QQ-A-200/8

Finish:

Black Anodize per MIL-A-8625, Type II, Class 2

SCREW

Stainless steel per QQ-S-763

Finish:

Passivate per MIL-S-5002

LEVER ARM

Aluminum alloy 6061-T6 per ASTM-B221 or AMS-QQ-A-200/8

Finish:

Hard Black Anodize per MIL-A-8625, Type III, Class 2

FLATWASHER & SPRING WASHERS

Stainless Steel. QQ-S-763.
Passivate per MIL-S-5002.

WEIGHT

1.65g/cm (.15oz/in)



Series L225 - "Card-Lok" Retainer (lever-lok)

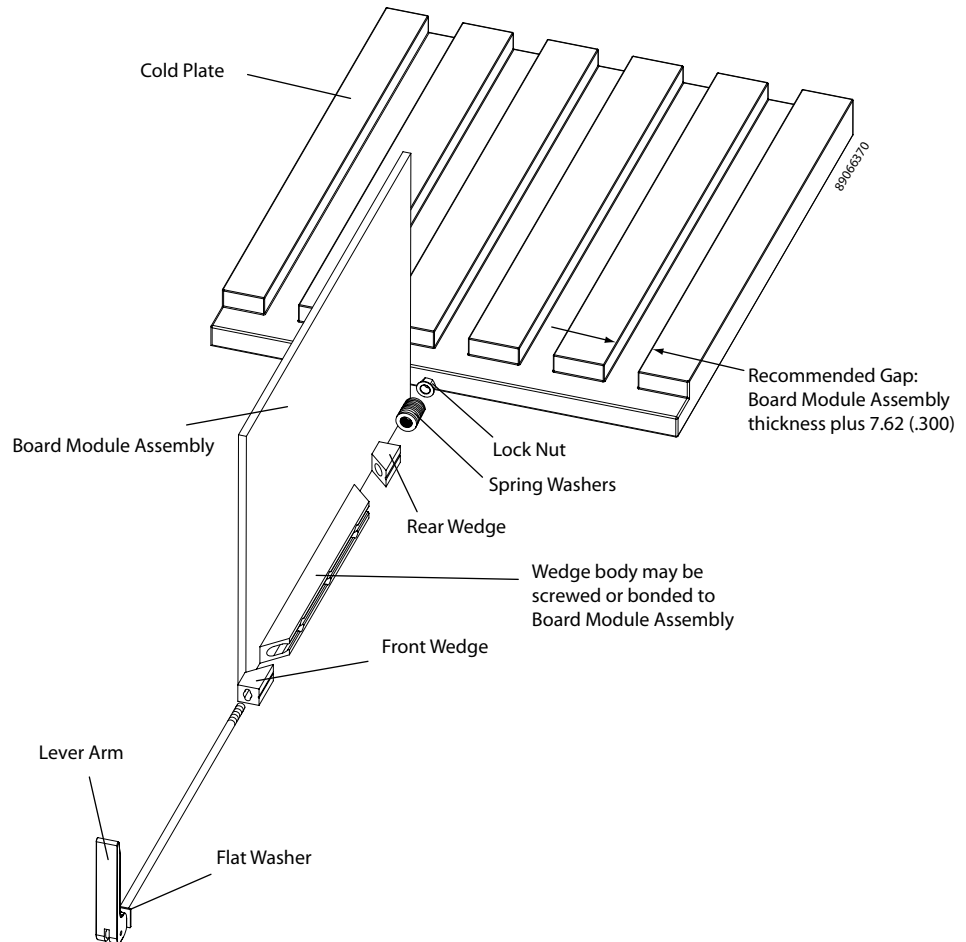

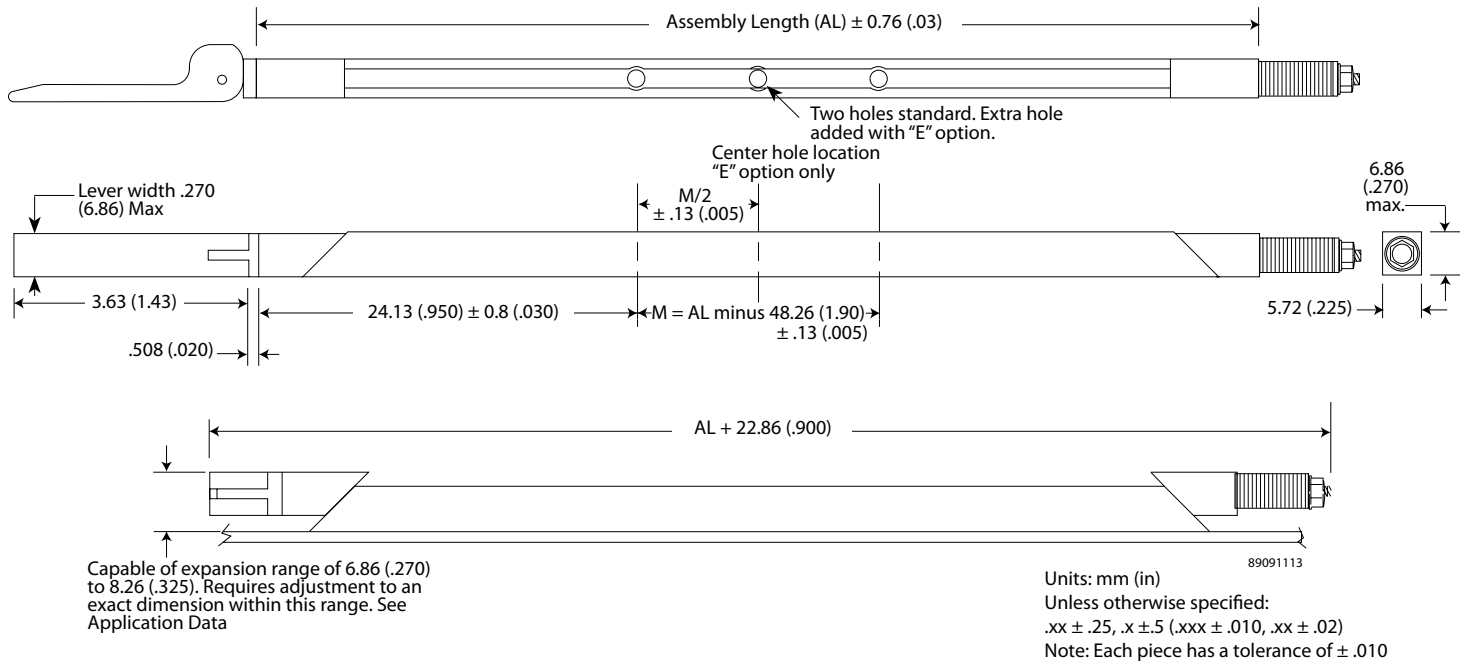

APPLICATION DATA

CLAMPING FORCE ADJUSTMENT PROCEDURE

- NOTE: Lever-Lok furnished assembled but not adjusted.
1. Fasten Lever-Lok to Board Module Assembly.
 2. Insert Board Module Assembly into slot in cold plate.
 3. Actuate lever to locked/closed position.
 4. Tighten locknut on end of screw until wedges initially contact wall of cold plate slot, or slight insertion/extraction drag is felt.
 5. Additionally tighten locknut two (2) full turns.
DO NOT EXCEED TWO (2) TURNS.
 6. Lever-Lok is now ready for use.

NOTE: Factory adjustment of clamping force available on request.

CLAMPING FORCE DATA

- Direct force of assembly is approximately 534N (120 lbs), when adjusted per recommended procedure.
- Direct force of assembly is affected as follows: 8N (1.8 lbs) per each .025 (.001) variation of cold plate slot width, or 200N (45 lbs) per each full turn of locknut.

Part Number Code

Series L225 Card-Lok Three Piece

L225 - 3.80 E TO

Suffix options

Assembly length in inches. Standard lengths range from 71.12 (2.80), 96.52 (3.80) and 121.9 (4.80).

Other lengths available upon request

Additional Center Mounting Hole _____ E

No additional center mounting hole _____ [blank]

Mounting Options - 0-80 tapped holes _____ TO
or choose from Mounting Option Table

length.xx

Part Number Code Example:

L225-2.80

Series L225 Ejecting Card-Lok three piece 71.12 (2.80) long with black anodize finish and 2-56 tapped holes

MOUNTING METHOD TABLE

Code Letter	Method
[blank]	2-56 ⁺ tapped hole
"TO"	0-80 tapped hole
"TM2"	M2 x 0.40 tapped hole
"TM2.5"	M2.5 x 0.45 tapped hole

Calmark offers the Series 226 "Card-Lok" retainer for cold plate-heat exchanger applications. A maximum efficiency heat sinking Board Module Assembly retainer designed specifically for part length of 4.80 (121.9) inches or longer with five or more wedge and body segments. The Series 226 design incorporates a Self-Positioning feature which minimizes wedge and body misalignment and provides easy insertion.

FEATURES

- Self-positioning design minimizes wedge and body misalignment providing easy insertion
- Positive locking provides maximum reliability
- Maximum thermal transfer
- Maximum resistance to shock and vibration
- Zero insertion and extraction forces
- Design Flexibility - Special lengths, finishes or other design variations available on request

BODIES & WEDGES

Material:

Aluminum alloy 6061-T6 per ASTM-B221 or AMS-QQ-A-200/8

Finish:

See Finish Table

SCREW

Material:

Stainless steel per ASTM-A582

Finish:

Passivate per AMS2700

WEIGHT

1.34 g/cm (.120 oz/in)

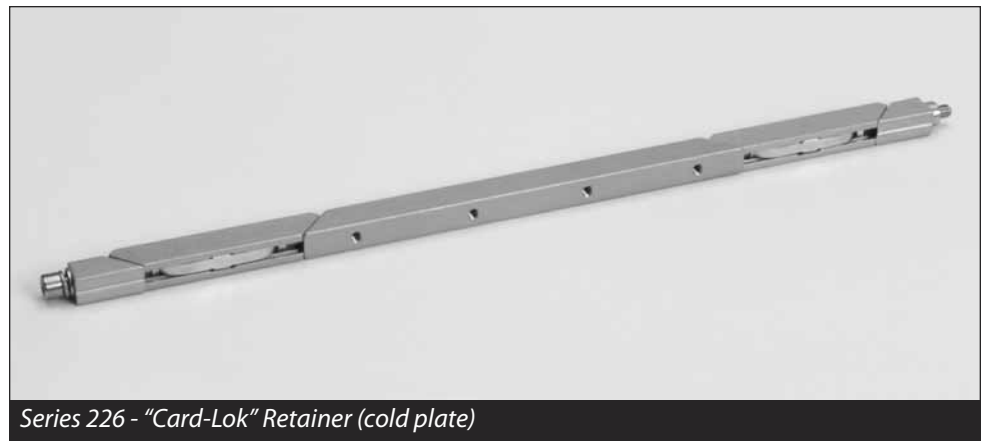

Series 226 - "Card-Lok" Retainer (cold plate)

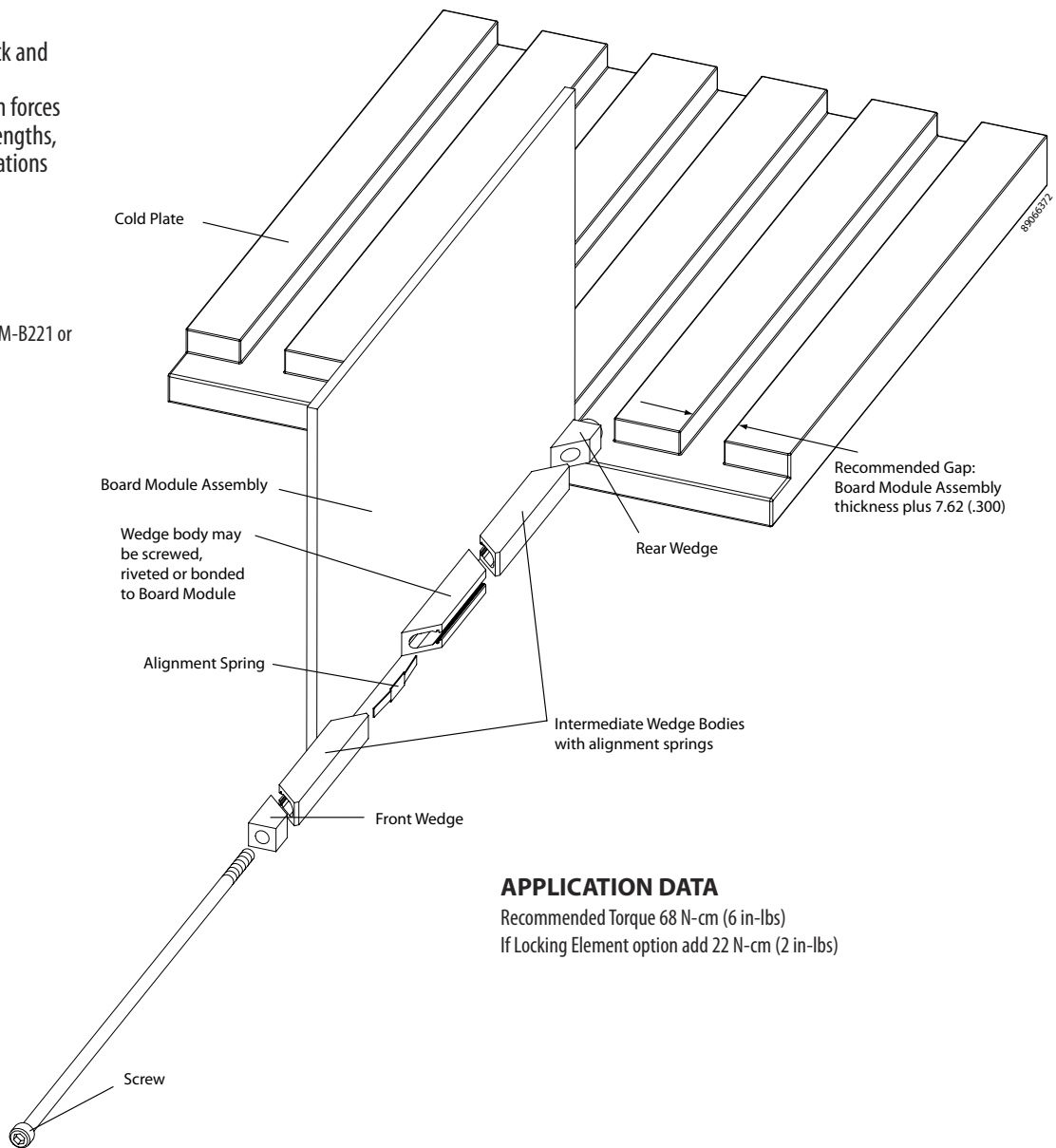

APPLICATION DATA

Recommended Torque 68 N-cm (6 in-lbs)

If Locking Element option add 22 N-cm (2 in-lbs)

OPTION PREFIX

Detail "V"

Provides visual lock indication.

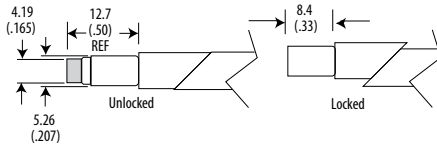

OPTION SUFFIX

Detail "L"

Provides prevailing torque for resistance to loosening from shock and vibration. Adds 22 N-cm (2 in-lbs) of torque to assembly. See application data on previous sheet.

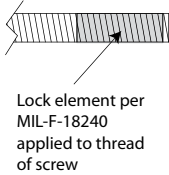

Detail "R"

Reduces the possibility of unintentional disassembly of the screw from rear wedge. This option adds 2.5 (.10) to the screw length unless combined with the "W" suffix option, then 5.1 (.20) total.

Detail "W"

Provides added resistance to loosening from shock and vibration. This option adds 2.5 (.10) to the screw length unless combined with the "R" suffix option, then adds 5.1 (.20) total.

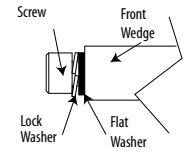

Detail "K"

Prevents the unintentional disassembly of screw from rear wedge. This option adds 5.1 (.20) to the screw length.

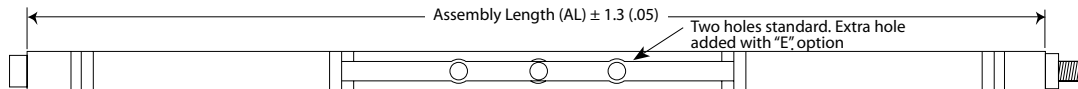
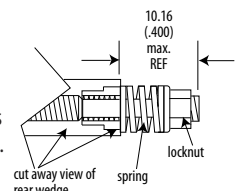

Assembly Length Range	M ± .13 (.005)
121.9 (4.80) to 190.4 (7.49)	22.86 (.900)
190.5 (7.50) to 215.9 (8.49)	48.26 (1.90)
216.0 (8.50) to 329.9 (12.99)	73.66 (2.90)

Mounting holes shown in wedge body - Screw and alignment spring hidden for clarity

Units: mm (in)
Unless otherwise specified:
.xx ± .25, x ± 5 (.xxx ± .010, xx ± .02)
Note: Each piece has a tolerance of ± .010

2.38 (.094)
Hex Socket Cap
Per ANSI/ASME B18.3

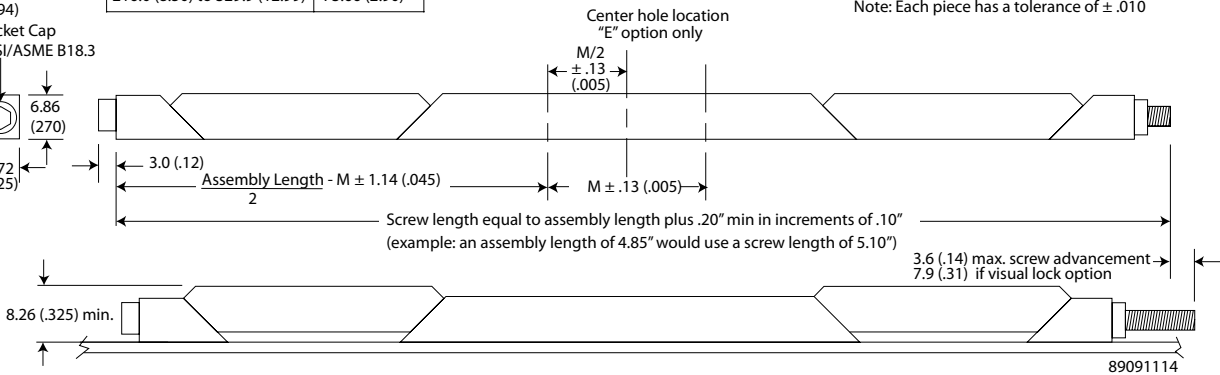
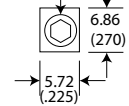

Part Number Code

Series 226 Card-Lok Five Piece

None [blank]

M W V A 226 - 4.80 E H L R

Prefix options

Metric Screw Head M2.5 Hex Drive **M**
Standard Screw Head 3/32 Hex Drive [blank]
Lock and Flat Washer **W**
None [blank]
Visual Indicator **V**
No Visual Indicator [blank]
Black Anodize **A**
or choose from Finish Table *see table*

Suffix options

Stainless Steel Captive (and Lock Nut if "R" option is also selected) **CR**
Standard Plated Steel **".."**
Assembly length in inches. Standard lengths range from 71.12 (2.80), 96.52 (3.80) and 121.9 (4.80). **length.xx**
Other lengths available upon request
Additional Center Mounting Hole **E**
None [blank]
Mounting Options - holes for rivet mounting or choose from Mounting Option Table *see table*
Lock Element **L**
None [blank]
Lock Nut **R**
Captive Screw **K**
None [blank]

Part Number Code Example:

MWA226-4.80HK

Series 226 Card-Lok five piece 121.9 (4.80) long with M2.5 hex drive, lock and flat washer, black anodize finish, holes for rivet mounting and captive screw feature

FINISH TABLE

Code Letter	Finish
[blank]	Chemical Film per Mil-DTL-5541 Class 1A, Type 1, Gold
"R"	Chemical Film per Mil-DTL-5541 Class 3, Type II, Clear
"A"	Black Anodize per Mil-A-8625 Type II, Class 2
"HA"	Hard Black Anodize per Mil-A-8625 Type III, Class 2
"EN"	Electroless Nickel per Mil-C-26074 Class 4, Grade B, Bright

MOUNTING METHOD TABLE

Code Letter	Method
[blank]	No mounting holes
"H"	Rivet Mounting Ø1.70 (.067) hole with 3.96 (.156) counterbore x 5.08 (.200) deep and 100° x 3.56 (.140) countersink
"T0"	0-80 tapped hole
"T2"	2-56 tapped hole
"TM2"	M2 x 0.40 tapped hole
"TM2.5"	M2.5 x 0.45 tapped hole

Calmark offers the Series 230 "Card-Lok" retainer for cold plate-heat exchanger applications. A mid-width configuration, to meet Board Module Assembly retainer expansion requirements between the Series 225 and 240.

FEATURES

- Maximum Reliability – Screw-actuated wedge action locks Board Module Assembly in place
- Maximum Thermal Transfer – Wedge action design provides maximum contact between thermal paths on Board Module Assembly and the heat sinking surface
- Maximum Resistance to Shock & Vibration – Wedge action design locks Board Module Assembly in place to provide maximum resistance to shock and vibration
- Zero Insertion & Extraction Forces – Screw actuation provides zero insertion and extraction force on Board Module Assembly
- Design Flexibility – Special lengths, finishes or other design variations available on request

BODIES & WEDGES

Material:

Aluminum alloy 6061-T6 per ASTM-B221 or AMS-QQ-A-200/8

Finish:

See Finish Table

SCREW

Material:

Stainless steel per ASTM-A582

Finish:

Passivate per AMS2700

WEIGHT

1.34 g/cm (.120 oz/in)

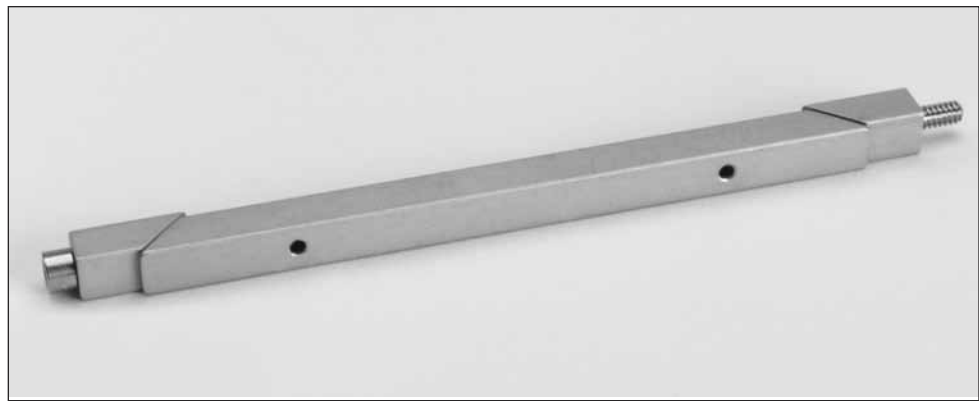

Series 230 - "Card-Lok" Retainer (cold plate)

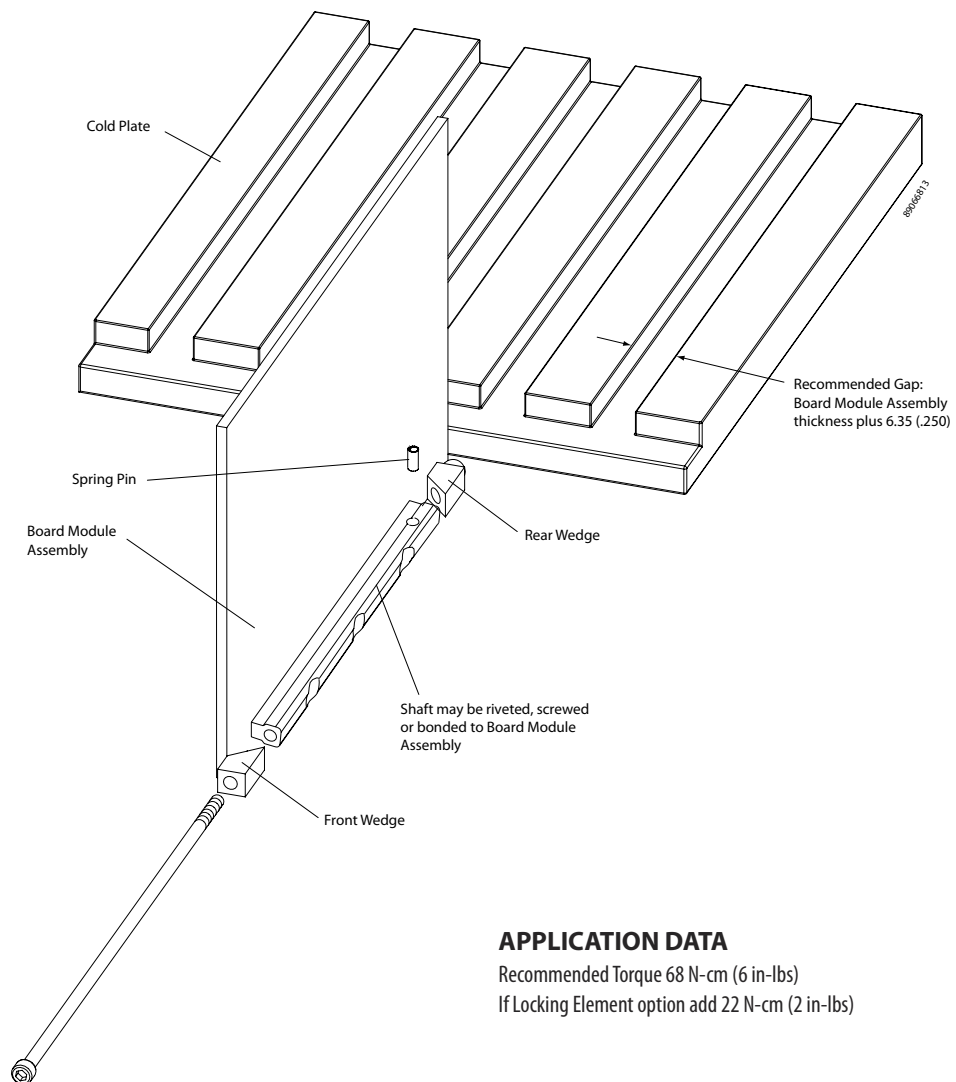

APPLICATION DATA

Recommended Torque 68 N-cm (6 in-lbs)

If Locking Element option add 22 N-cm (2 in-lbs)

OPTION PREFIX

Detail "V"

Provides visual lock indication.

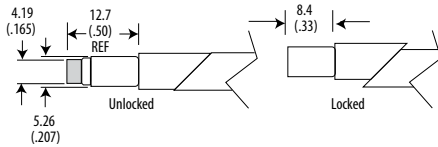

Detail "W"

Provides added resistance to loosening from shock and vibration. This option adds no additional screw length unless combined with the "R" suffix option, then adds 2.5 (.10) total.

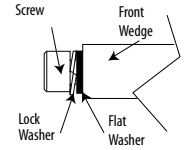

OPTION SUFFIX

Detail "L"

Provides prevailing torque for resistance to loosening from shock and vibration.

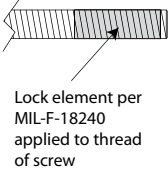

Detail "R"

Reduces the possibility of unintentional disassembly of the screw from rear wedge. This option adds no additional screw length with or without "CR" unless included with "W" option, then 2.5 (.10) total.

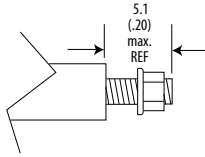

Detail "K"

Prevents the unintentional disassembly of screw from rear wedge. This option adds 5.1 (.20) to the screw length.

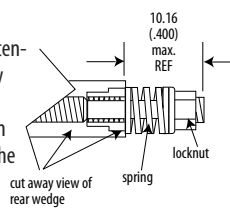

Detail "CR"

If the "R" option is included with this "CR" option, then the locknut is stainless steel.

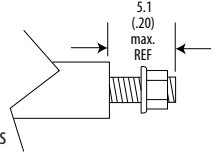

2.38 (.094) Hex Socket Cap Per ANSI/ASME B18.3

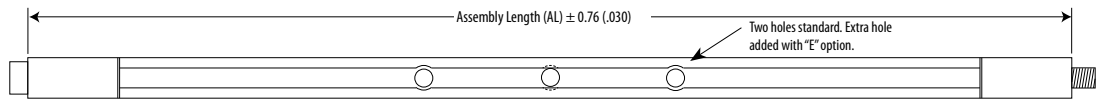
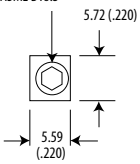

Mounting holes shown in wedge body - Screw hidden for clarity

Units: mm (in.)
Unless otherwise specified:
.xx ± .25, x ± 5
(.xxx ± .010, .xx ± .02)
Note: Each piece has a tolerance of ± .010

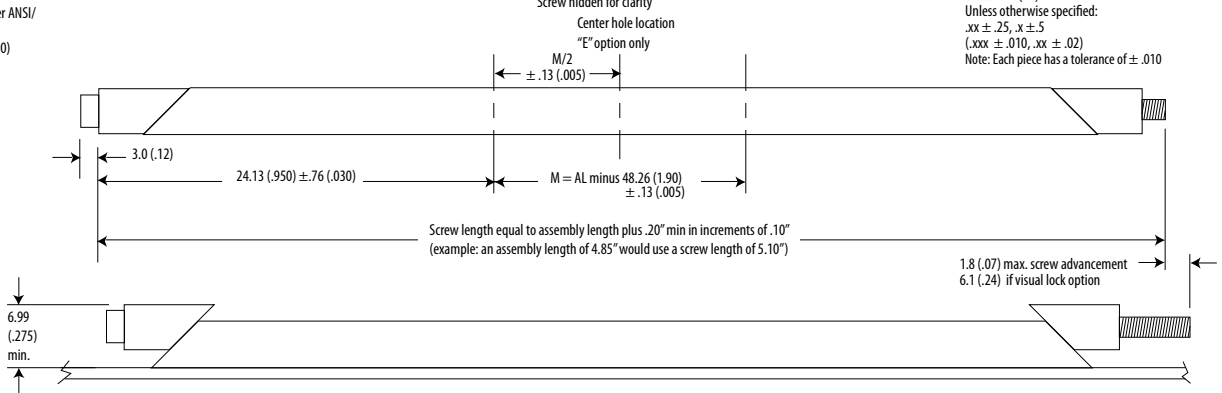

Part Number Code

Series 230 Card-Lok Three Piece

None _____ [blank] M W V A 230 - 3.80 E H L R

Prefix options

Metric Screw Head M2.5 Hex Drive _____ M
Standard Screw Head 3/32 Hex Drive _____ [blank]
Lock and Flat Washer _____ W
None _____ [blank]
Visual Indicator _____ V
No Visual Indicator _____ [blank]
Black Anodize _____ A
or choose from Finish Table _____ see table

Suffix options

Stainless Steel Lock Nut if "R" option is selected _____ CR
Standard Steel Lock Nut _____ "-"

Assembly length in inches. Standard lengths range from 71.12 (2.80), 96.52 (3.80) and 121.9 (4.80). _____ length.xx
Other lengths available upon request

Additional Center Mounting Hole _____ E
None _____ [blank]

Mounting Options - holes for rivet mounting _____ H
or choose from Mounting Option _____ see table

Lock Element _____ L
None _____ [blank]

Lock Nut _____ R
Captive Screw _____ K
None _____ [blank]

Part Number Code Example:

VA230CR4.80HR

Series 230 Card-Lok three piece 121.9 (4.80) long with visual indicator, black anodize finish, standard rivet mounting holes and stainless steel lock nut option

Code Letter	Finish
[blank]	Chemical Film per Mil-DTL-5541 Class 1A, Type 1, Gold
"R"	Chemical Film per Mil-DTL-5541 Class 3, Type II, Clear
"A"	Black Anodize per Mil-A-8625 Type II, Class 2
"HA"	Hard Black Anodize per Mil-A-8625 Type III, Class 2
"EN"	Electroless Nickel per Mil-C-26074 Class 4, Grade B, Bright

Code Letter	Method
[blank]	No mounting holes
"H"	Rivet Mounting Ø1.70 (.067) hole with 3.96 (.156) counterbore x 4.19 (.165) deep and 100° x 3.56 (.140) countersink
"T0"	0-80 tapped hole
"T2"	2-56 tapped hole
"TM2"	M2 x 0.40 tapped hole
"TM2.5"	M2.5 x 0.45 tapped hole

Calmark offers the Series 231 "Card-Lok" retainer for cold plate-heat exchanger applications. A mid-width configuration, to meet Board Module Assembly retainer expansion requirements between the Series 225 and 240.

FEATURES

- Maximum Reliability – Screw-actuated wedge action locks Board Module Assembly in place
- Maximum Thermal Transfer – Wedge action design provides maximum contact between thermal paths on Board Module Assembly and the heat sinking surface
- Maximum Resistance to Shock & Vibration – Wedge action design locks Board Module Assembly in place to provide maximum resistance to shock and vibration
- Zero Insertion & Extraction Forces – Screw actuation provides zero insertion and extraction force on Board Module Assembly
- Design Flexibility – Special lengths, finishes or other design variations available on request

BODIES & WEDGES

Material:

Aluminum alloy 6061-T6 per ASTM-B221 or AMS-QQ-A-200/8

Finish:

See Finish Table

SCREW

Material:

Stainless steel per ASTM-A582

Finish:

Passivate per AMS2700

WEIGHT

1.34 g/cm (.120 oz/in)

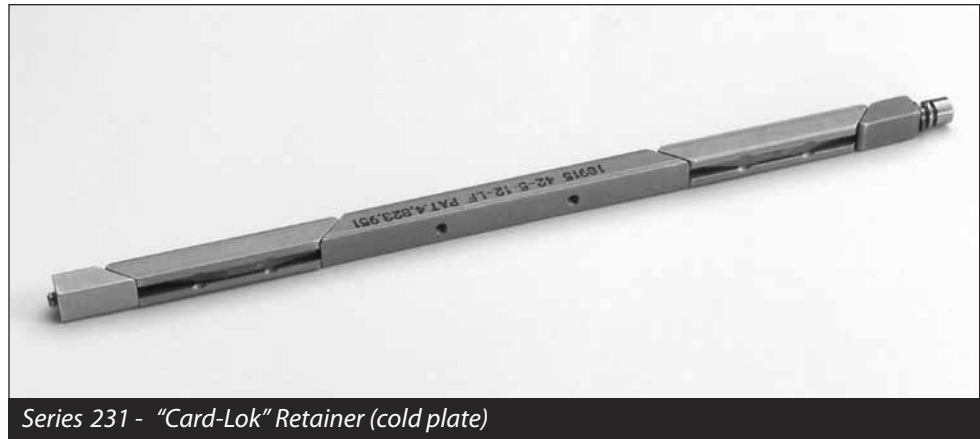

Series 231 - "Card-Lok" Retainer (cold plate)

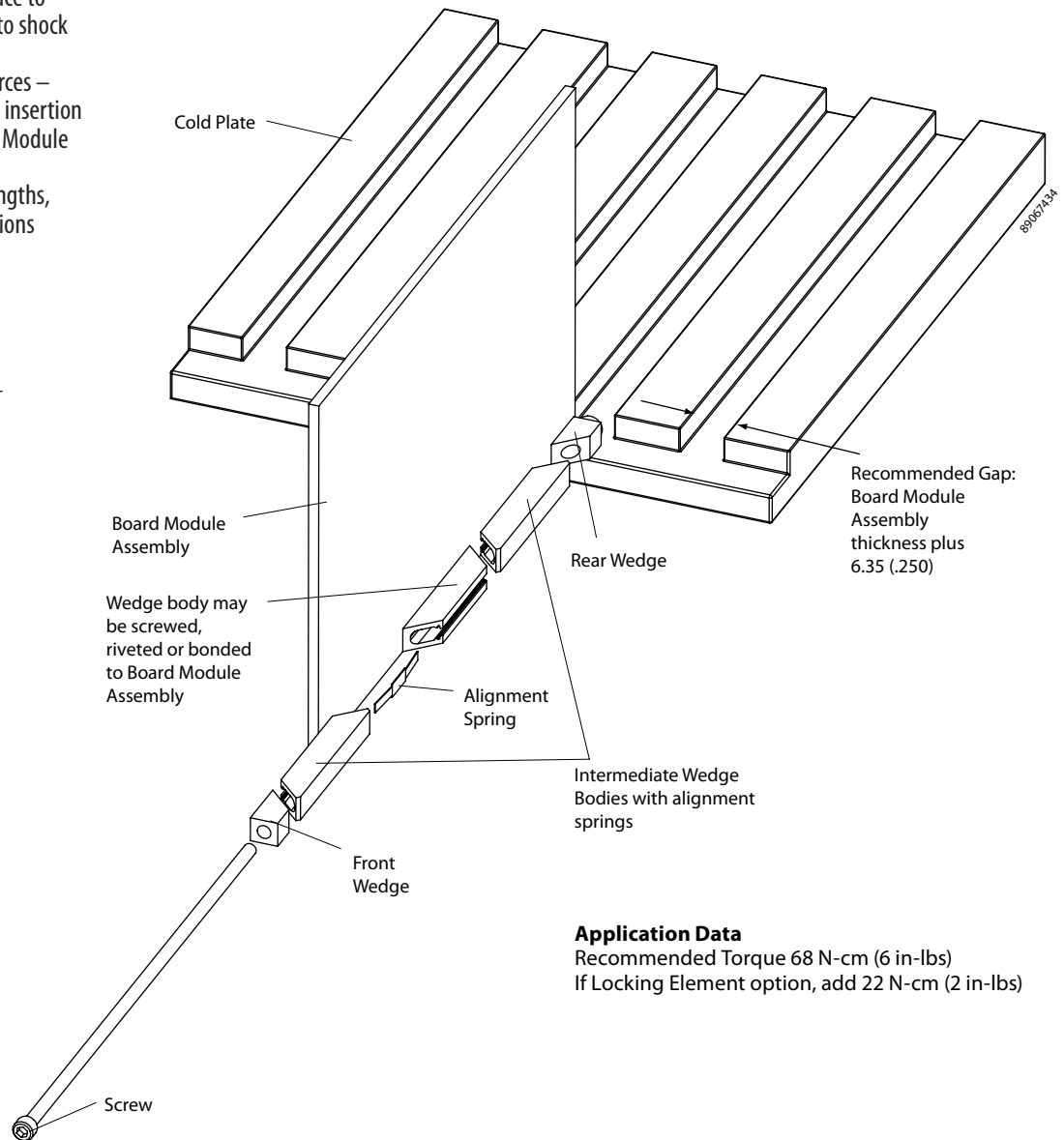

Application Data

Recommended Torque 68 N-cm (6 in-lbs)

If Locking Element option, add 22 N-cm (2 in-lbs)

OPTION PREFIX

Detail "V"

Provides visual lock indication.

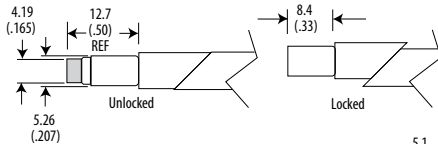

Detail "W"

Provides added resistance to loosening from shock and vibration. This option adds no additional screw length unless combined with the "R" suffix option, then adds 2.5 (.10) total.

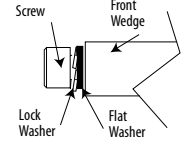

OPTION SUFFIX

Detail "L"

Provides prevailing torque for resistance to loosening from shock and vibration.

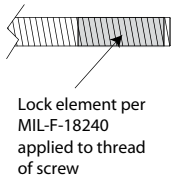

Lock element per MIL-F-18240 applied to thread of screw

Detail "R"

Reduces the possibility of unintentional disassembly of the screw from rear wedge. This option adds no additional screw length with or without "CR" unless included with "W" option, then 2.5 (.10) total.

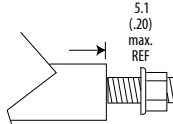

Detail "K"

Prevents the unintentional disassembly of screw from rear wedge. This option adds 5.1 (.20) to the screw length.

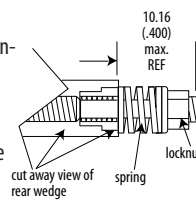

Detail "CR"

If the "R" option is included with this "CR" option, then the locknut is stainless steel.

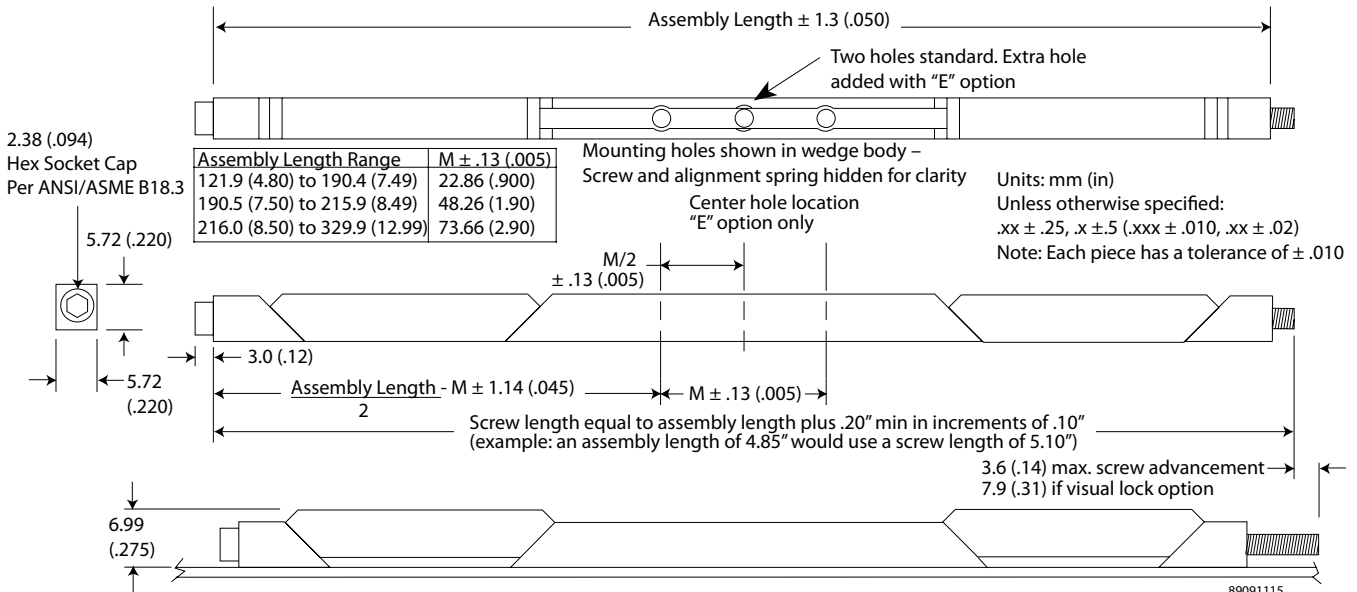
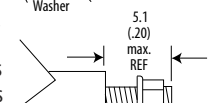

89091115

Part Number Code
Series 231 Card-Lok Five Piece

Metric Screw Head M2.5 _____ **M**
 Standard Screw Head 3/32 _____ [blank]
 Lock and Flat Washer _____ **W**
 None _____ [blank]
 Visual Indicator _____ **V**
 No Visual Indicator _____ [blank]
 Black Anodize _____ **A**
 or choose from Finish Table _____ see table

Suffix options
 Stainless Steel Lock Nut if "R" option is selected _____ **CR**
 Standard Plated Steel _____ [blank]

Assembly length in inches. Standard lengths range from 71.12 (2.80), 96.52 (3.80) and 121.9 (4.80). _____ length.xx
 Other lengths available upon request

Additional Center Mounting Hole _____ **E**
 None _____ [blank]
 Mounting Options - holes for rivet mounting _____ **H**
 or choose from Mounting Option Table _____ see table
 Lock Element _____ **L**
 None _____ [blank]
 Lock Nut _____ **R**
 Captive Screw _____ **K**
 None _____ [blank]

Part Number Code Example:

W231-4.80LR

Series 231 Card-Lok five piece 121.9 (4.80) long with lock and flat washer, gold chemical finish, lock element, no mounting holes and a plated steel lock nut

Code

Letter Finish

[blank]

"R"

"A"

"HA"

"EN"

FINISH TABLE

Code	Letter	Finish
[blank]		Chemical Film per Mil-DTL-5541 Class 1A, Type 1, Gold
"R"		Chemical Film per Mil-DTL-5541 Class 3, Type II, Clear
"A"		Black Anodize per Mil-A-8625 Type II, Class 2
"HA"		Hard Black Anodize per Mil-A-8625 Type III, Class 2
"EN"		Electroless Nickel per Mil-C-26074 Class 4, Grade B, Bright

Code

Letter Method

[blank]

"H"

"T0"

"T2"

"TM2"

"TM2.5"

MOUNTING METHOD TABLE

Code	Letter	Method
[blank]		No mounting holes
"H"		Rivet Mounting Ø1.70 (.067) hole with 3.96 (.156) counterbore x 4.19 (.165) deep and 100° x 3.56 (.140) countersink
"T0"		0-80 tapped hole
"T2"		2-56 tapped hole
"TM2"		M2 x 0.40 tapped hole
"TM2.5"		M2.5 x 0.45 tapped hole

Calmark offers the 3 piece Series 235 metric "Card-Lok" retainer for cold plate-heat exchanger applications. Closed shape segments provide maximum rigidity and resistance to distortion under load. Dual front and rear threads accomplishes rapid clamp and release action. Enclosed spring maintains alignment of segments providing easy insertion.

FEATURES

- Closed shape segments provide maximum rigidity and resistance to distortion under load
- Dual threads provide rapid clamp and release action
- Enclosed springs maintain alignment of segments providing easy insertion
- Maximum resistance to shock and vibration
- Zero insertion and extraction forces
- Design Flexibility - Special lengths, finishes or other design variations available on request

BODIES & WEDGES

Material:

Aluminum alloy 6061-T6 per ASTM-B221 or AMS-QQ-A-200/8

Finish:

See Finish Table

SCREW

Material:

Stainless steel per ASTM-A582

Finish:

Passivate per MIL-S-5002

WEIGHT

1.34 g/cm (.120 oz/in)



Series 235 - "Card-Lok" Retainer (cold plate)

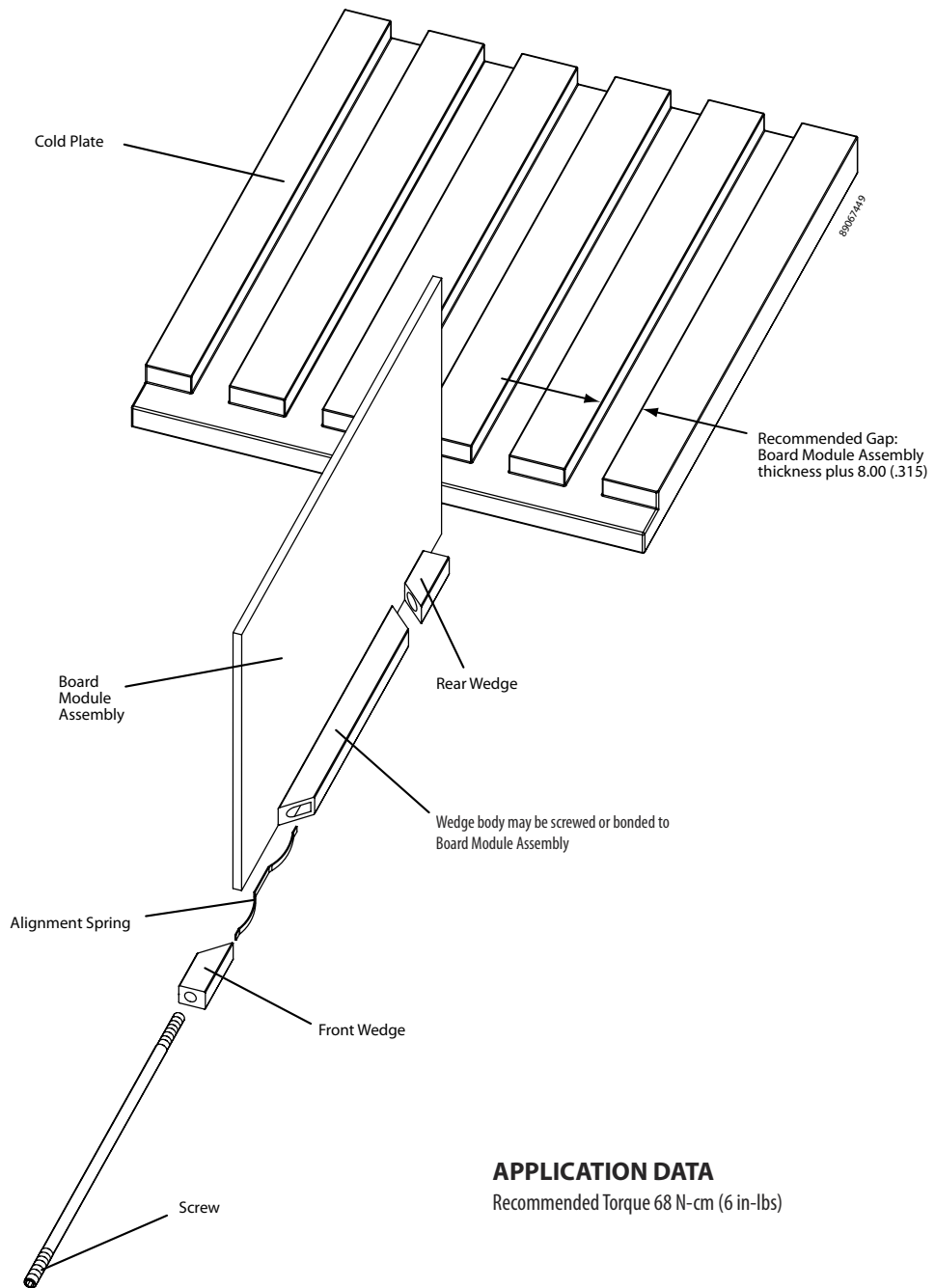

APPLICATION DATA

Recommended Torque 68 N-cm (6 in-lbs)

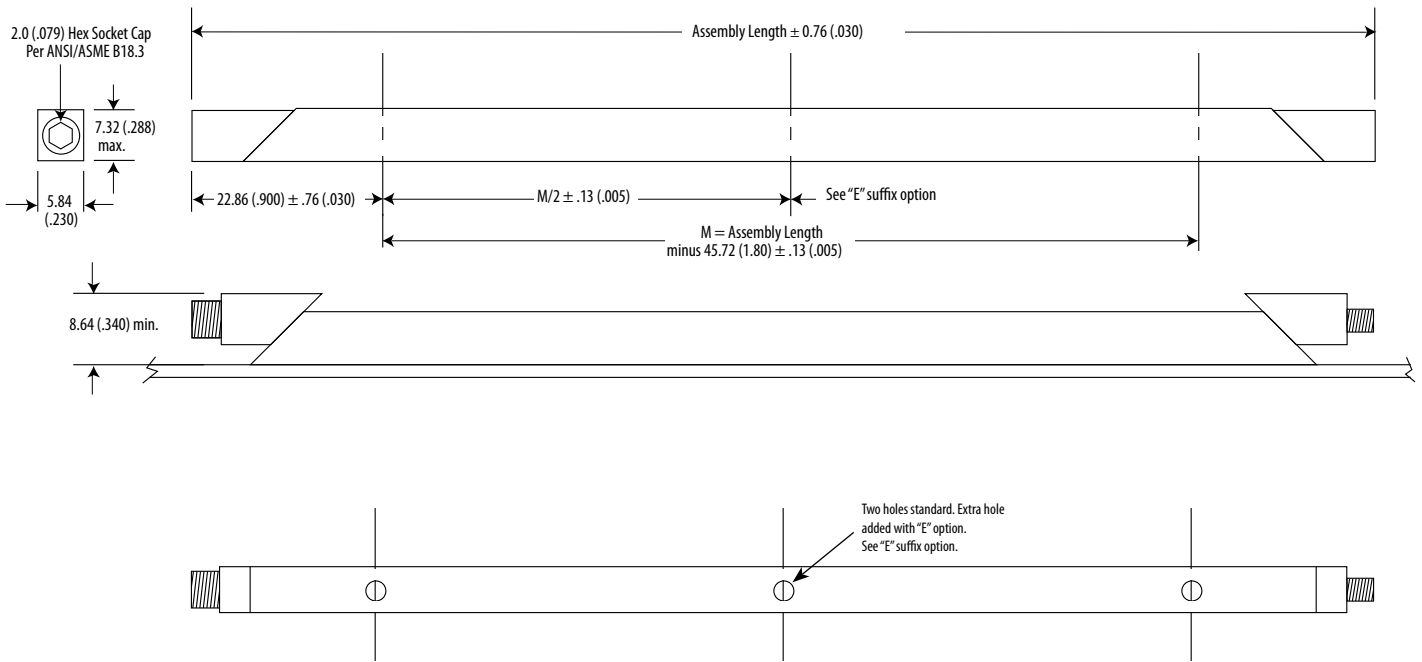

Units: mm (in.)
 Unless otherwise specified:
 .xx ± .25, x ± .5
 (.xxx ± .010, xx ± .02)
 Note: Each piece has a tolerance of ± .010

Part Number Code
Series 235 Card-Lok Three Piece

Prefix options	S	A	235	-	4.80	E	TM2.5	P
Slotted Drive	S							
2mm Hex Drive	[blank]							
Finish options		A						
Black Anodize		A						
or choose from Finish Table								
Assembly length in inches. Standard lengths range from 71.12 (2.80), 96.52 (3.80) and 121.9 (4.80). Other lengths available upon request					length.xx			
Additional Center Mounting Hole						E		
None						[blank]		
Mounting Options - M2.5 tapped hole							TM2.5	
or choose from Mounting Option Table							see table	
Locking Insert Option								P
None								[blank]

Part Number Code Example:

A235-2.80ETM2.5

Series 235 Card-Lok three piece, black anodized, 71.12 (2.80) assembly length, with three M2.5 tapped mounting holes and 2.5mm Hex Drive Screw Head

Code Letter	FINISH TABLE
[blank]	Chemical Film per Mil-DTL-5541 Class 1A, Type 1, Gold
"R"	Chemical Film per Mil-DTL-5541 Class 3, Type II, Clear
"A"	Black Anodize per Mil-A-8625 Type II, Class 2
"HA"	Hard Black Anodize per Mil-A-8625 Type III, Class 2
"EN"	Electroless Nickel per Mil-C-26074 Class 4, Grade B, Bright

Code Letter	MOUNTING METHOD TABLE
[blank]	No mounting holes
"T0"	0-80 tapped hole
"T2"	2-56 tapped hole
"TM2"	M2 x 0.40 tapped hole
"TM2.5"	M2.5 x 0.45 tapped hole

Calmark offers the 5 piece Series 236 metric "Card-Lok" retainer for cold plate-heat exchanger applications. Closed shape segments provide maximum rigidity and resistance to distortion under load. Dual front and rear threads accomplishes rapid clamp and release action. Enclosed springs maintain alignment of segments providing easy insertion.

FEATURES

- Closed shape segments provide maximum rigidity and resistance to distortion under load
- Dual threads provide rapid clamp and release action
- Enclosed springs maintain alignment of segments providing easy insertion
- Maximum resistance to shock and vibration
- Zero insertion and extraction forces
- Design Flexibility - Special lengths, finishes or other design variations available on request

BODIES & WEDGES

Material:

Aluminum alloy 6061-T6 per ASTM-B221 or AMS-QQ-A-200/8

Finish:

See Finish Table

SCREW

Material:

Stainless steel per ASTM-A582

Finish:

Passivate per MIL-S-5002

WEIGHT

1.34 g/cm (.120 oz/in)



Series 236 - "Card-Lok" Retainer (cold plate)

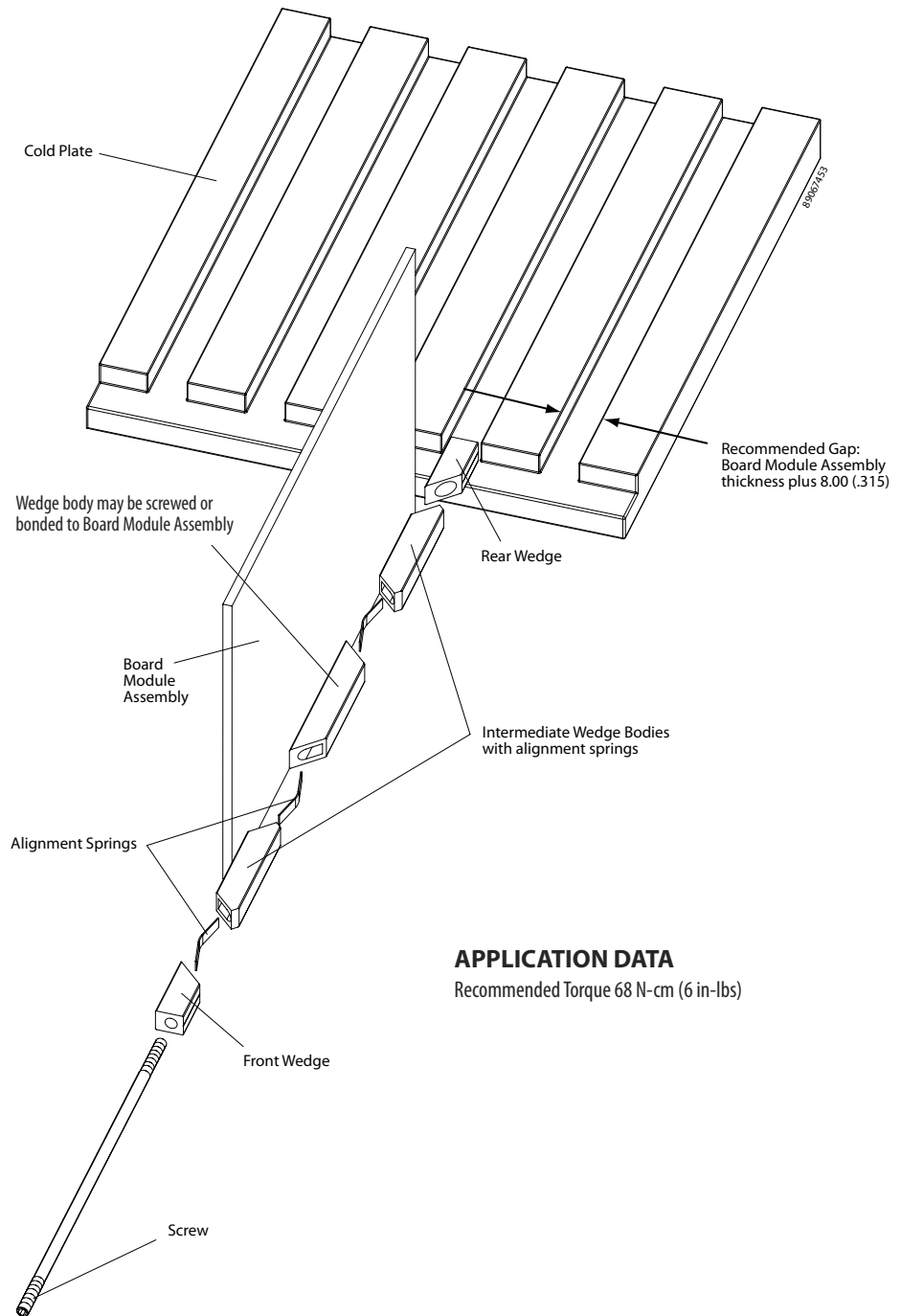

APPLICATION DATA

Recommended Torque 68 N-cm (6 in-lbs)

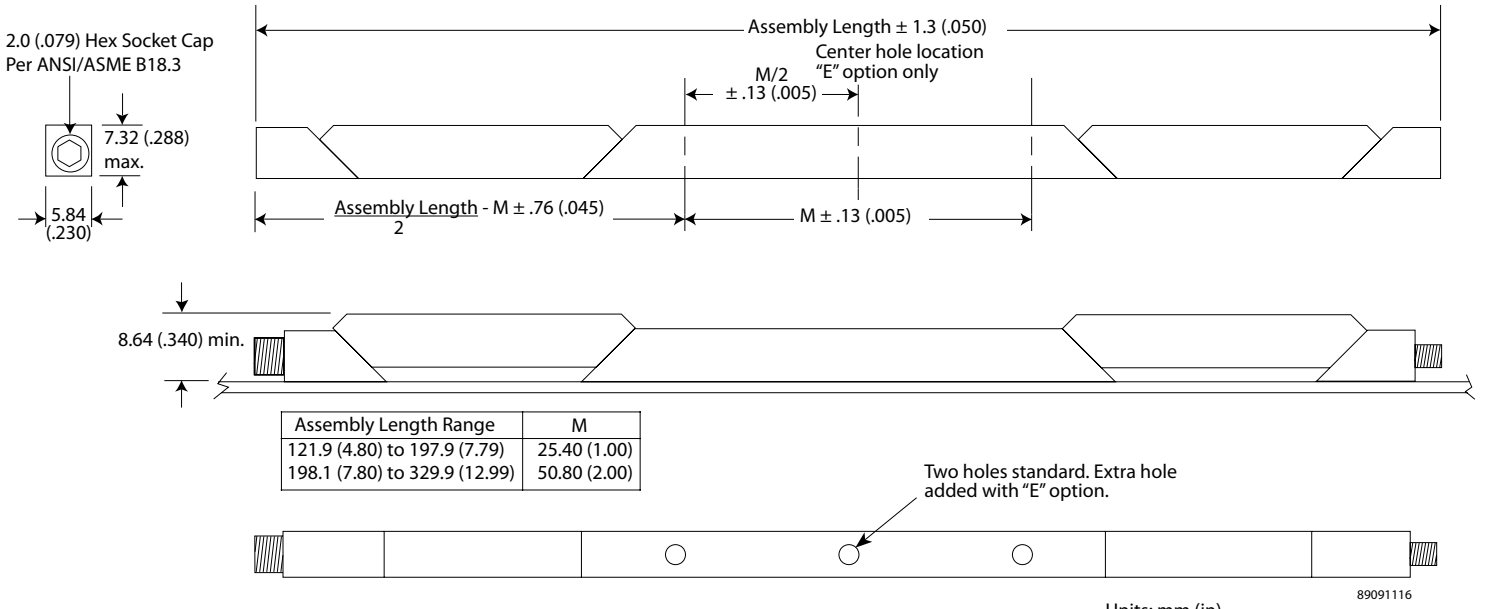

Units: mm (in)
 Unless otherwise specified:
 .xx ± .25, .x ± .5 (.xxx ± .010, .xx ± .02)
 Note: Each piece has a tolerance of ± .010

Part Number Code
Series 236 Card-Lok Five Piece

S A 236 - 5.80 E TM2.5 P

Prefix options
 Slotted Drive S
 2mm Hex Drive [blank]

Finish options
 Black Anodize A
 or choose from Finish Table

Suffix options
 Assembly length in inches. Standard lengths range from 71.12 (2.80), 96.52 (3.80) and 121.9 (4.80). length.xx
 Other lengths available upon request

Additional Center Mounting Hole E
 None [blank]

Mounting Options - M2.5 tapped hole TM2.5
 or choose from Mounting Option Table see table

Locking Insert Option P
 None [blank]

Part Number Code Example:

A236-2.80ETM2.5

Series 236 Card-Lok five piece, black anodized, 71.12 (2.80) assembly length, with three M2.5 tapped mounting holes and 2.5mm Hex Drive Screw Head

FINISH TABLE

Code Letter	Finish
[blank]	Chemical Film per Mil-DTL-5541 Class 1A, Type 1, Gold
"R"	Chemical Film per Mil-DTL-5541 Class 3, Type II, Clear
"A"	Black Anodize per Mil-A-8625 Type II, Class 2
"HA"	Hard Black Anodize per Mil-A-8625 Type III, Class 2
"EN"	Electroless Nickel per Mil-C-26074 Class 4, Grade B, Bright

MOUNTING METHOD TABLE

Code Letter	Method
[blank]	No mounting holes
"T0"	0-80 tapped hole
"T2"	2-56 tapped hole
"TM2"	M2 x 0.40 tapped hole
"TM2.5"	M2.5 x 0.45 tapped hole

Calmark offers the Series 240 "Card-Lok" retainer for cold plate-heat exchanger applications. A narrow configuration Board Module Assembly retainer that provides maximum heat sinking efficiency for high density card spacing.

FEATURES

- Narrow width allows minimum card spacing
- Positive locking provides maximum reliability
- Maximum thermal transfer
- Maximum resistance to shock and vibration
- Zero insertion and extraction forces
- Design Flexibility - Special lengths, finishes or other design variations available on request

BODIES & WEDGES

Material:

Aluminum alloy 6061-T6 per ASTM-B221 or AMS-QQ-A-200/8

Finish:

See Finish Table

SCREW

Material:

Stainless steel per ASTM-A582

Finish:

Passivate per MIL-S-5002

WEIGHT

.86 g/cm (.077 oz/in)

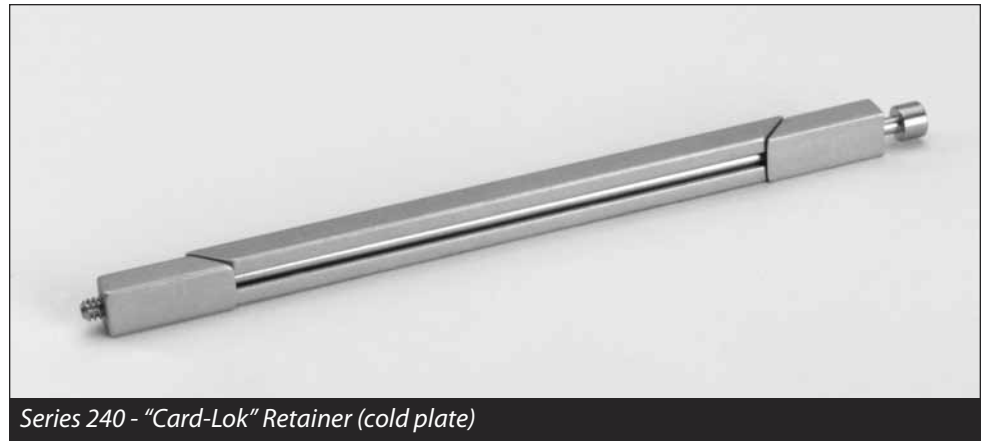

Series 240 - "Card-Lok" Retainer (cold plate)

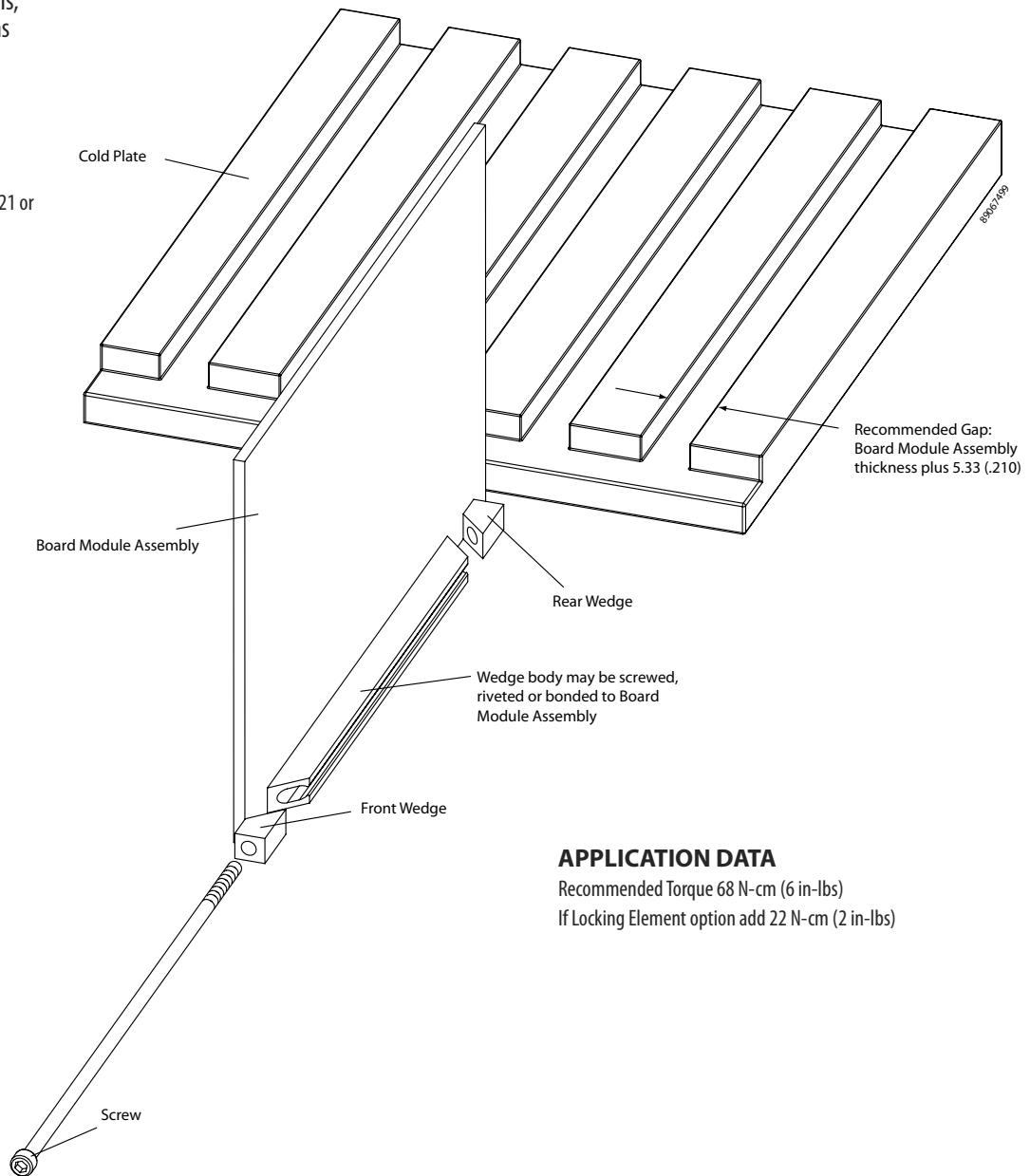

APPLICATION DATA

Recommended Torque 68 N-cm (6 in-lbs)

If Locking Element option add 22 N-cm (2 in-lbs)

OPTION PREFIX

Detail "W"

Provides added resistance to loosening from shock and vibration. This option adds 2.54 (.100) to the screw length when combined with the "R" option.

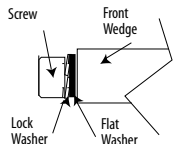

OPTION SUFFIX

Detail "L"

Provides prevailing torque for resistance to loosening from shock and vibration. Adds 22 N-cm (2 in-lbs) torque to assembly. See application data on previous sheet.

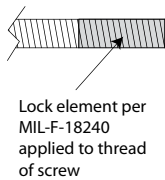

Detail "R"

Reduces the possibility of unintentional disassembly of the screw from rear wedge. This option adds 2.54 (.100) to the screw length when combined with the "W" option. Lock Nut material: stainless steel.

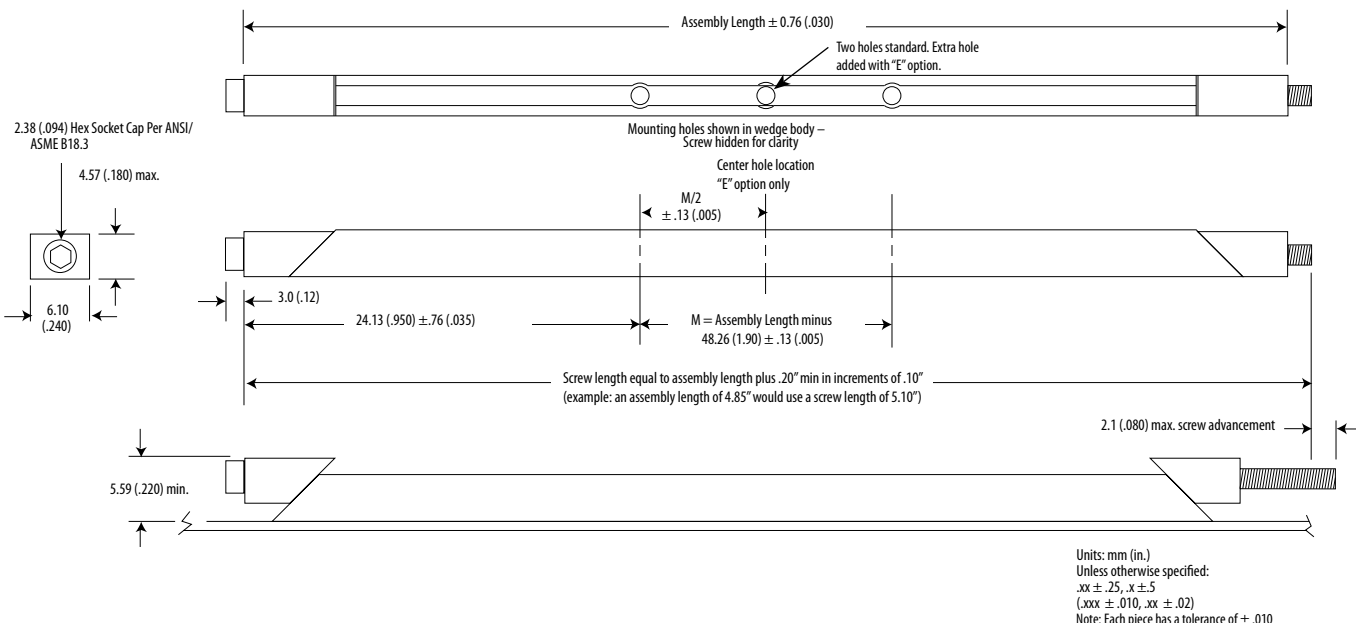
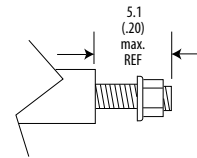

Part Number Code		Series 240 Card-Lok Three Piece	
M	W	A	240 - 4.80 E H L R
Prefix options			
Metric Screw Head M2.5 Hex Drive		M	
Standard Screw Head 3/32 Hex Drive		[blank]	
Lock and Flat Washer		W	
None		[blank]	
Black Anodize		A	
or choose from Finish Table		see table	
Suffix options			
Assembly length in inches. Standard lengths range from 71.12 (2.80), 96.52 (3.80) and 121.9 (4.80).		length.xx	
Other lengths available upon request			
Additional Center Mounting Hole		E	
None		[blank]	
Mounting Options - holes for rivet mounting		H	
or choose from Mounting Option Table		see table	
Lock Element		L	
None		[blank]	
Lock Nut		R	
None		[blank]	

Part Number Code Example:

A240CR3.80EHLR

Series 240 three piece Card-Lok, black anodized finish, 96.52 (3.80) long, holes for rivet mounting including an extra center mounting hole, with locking element on the screw thread and a stainless steel locknut

FINISH TABLE

Code Letter	Finish
[blank]	Chemical Film per Mil-DTL-5541 Class 1A, Type 1, Gold
"R"	Chemical Film per Mil-DTL-5541 Class 3, Type II, Clear
"A"	Black Anodize per Mil-A-8625 Type II, Class 2
"HA"	Hard Black Anodize per Mil-A-8625 Type III, Class 2
"EN"	Electroless Nickel per Mil-C-26074 Class 4, Grade B, Bright

MOUNTING METHOD TABLE

Code Letter	Method
[blank]	No mounting holes
"H"	Rivet Mounting $\varnothing 1.70 (.067)$ hole with 3.96 (.156) counterbore x 5.08 (.200) deep and 100° x 3.56 (.140) countersink
"T0"	0-80 tapped hole
"T2"	2-56 tapped hole
"TM2"	M2 x 0.40 tapped hole
"TM2.5"	M2.5 x 0.45 tapped hole

Calmark offers the Series 245 "Card-Lok" retainer for cold plate-heat exchanger applications. A maximum efficiency heat sinking Board Module Assembly retainer offered to retrofit the Series 225 but uses a 6-32 screw to provide greater clamping force and load capacity.

FEATURES

- Maximum reliability - Screw-actuated wedge action locks Board Module Assembly in place
- Maximum thermal transfer - Wedge action design provides maximum contact between thermal paths on Board Module Assembly and the heat sinking surface
- Maximum resistance to shock and vibration - Wedge action design locks Board Module Assembly in place to provide maximum resistance to shock and vibration
- Zero insertion and extraction forces - Screw actuation provides zero insertion and extraction force on Board Module Assembly
- Design flexibility - Special lengths, finishes or other design variations available on request

BODIES & WEDGES

Material:

Aluminum alloy 6061-T6 per ASTM-B221 or AMS-QQ-A-200/8

Finish:

See Finish Table

SCREW

Material:

Stainless steel per ASTM-A582

Finish:

Passivate per MIL-S-5002

WEIGHT

1.77 g/cm (.159 oz/in)

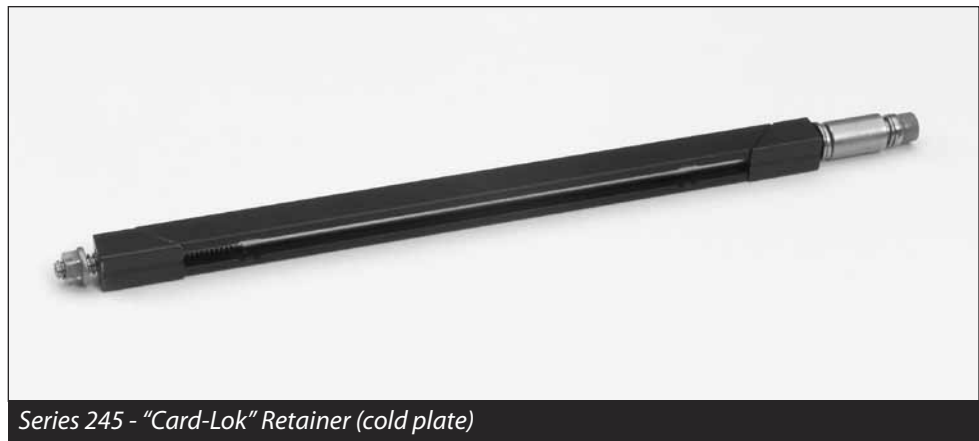

Series 245 - "Card-Lok" Retainer (cold plate)

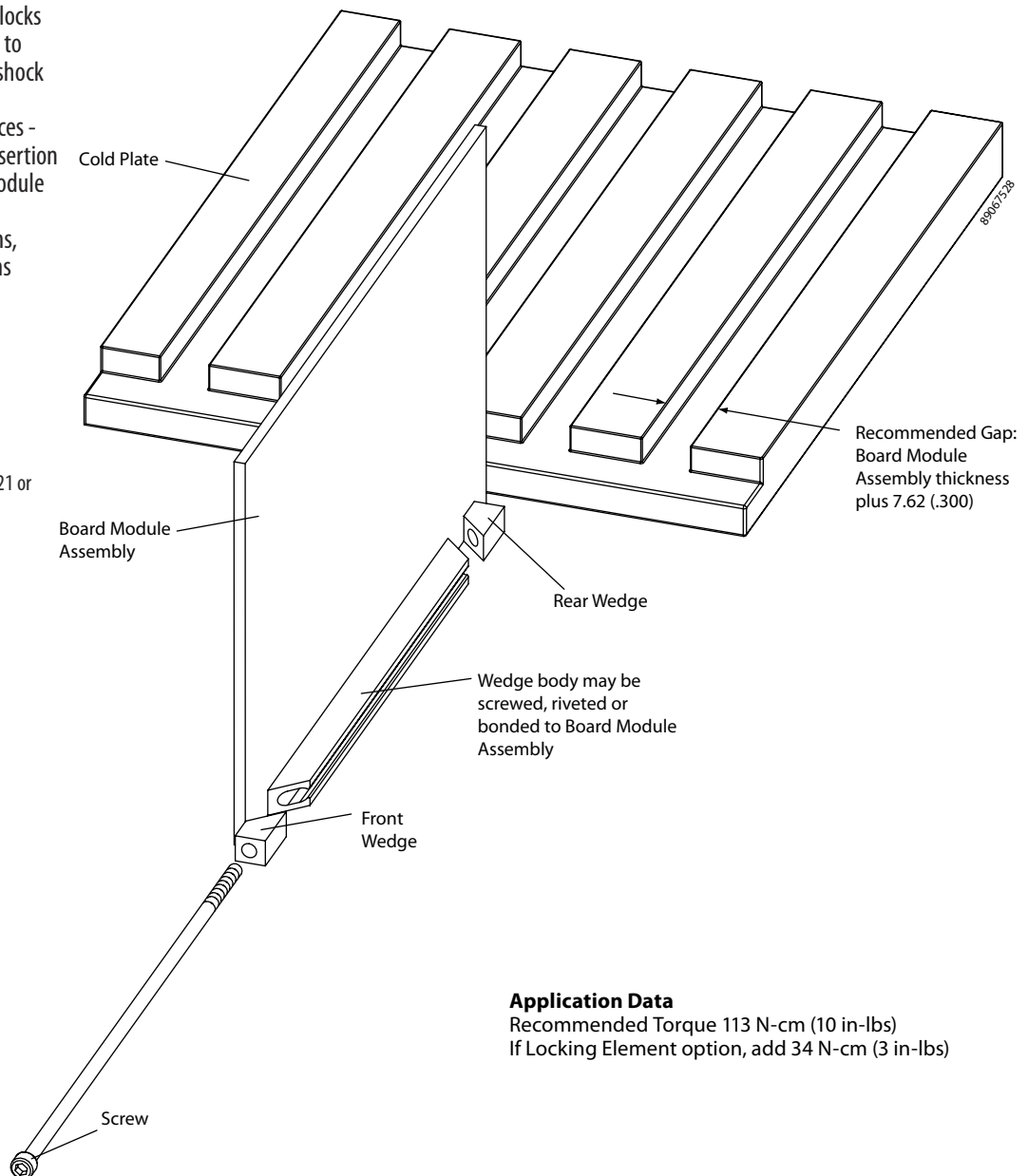

Application Data

Recommended Torque 113 N-cm (10 in-lbs)
If Locking Element option, add 34 N-cm (3 in-lbs)

OPTION PREFIX

Detail "V"

Provides visual lock indication. Changes hex drive to 2.38 (.094). This option adds 5.08 (.20) to screw length

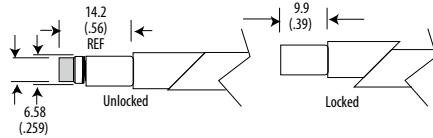

OPTION SUFFIX

Detail "L"

Provides prevailing torque for resistance to loosening from shock and vibration. Adds 34 N-cm (3 in-lbs) torque to assembly. See application data on previous sheet.

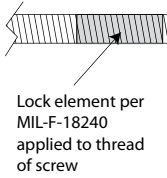

Detail "R"

Reduces the possibility of unintentional disassembly of the screw from rear wedge. This option adds 2.54 (.10) to the screw length unless when combined with the "W" suffix option, then it adds 5.08 (.20).

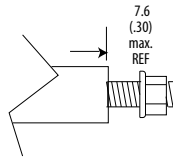

Detail "K"

Prevents the unintentional disassembly of screw from rear wedge. This option adds 5.08 (.200) to the screw length.

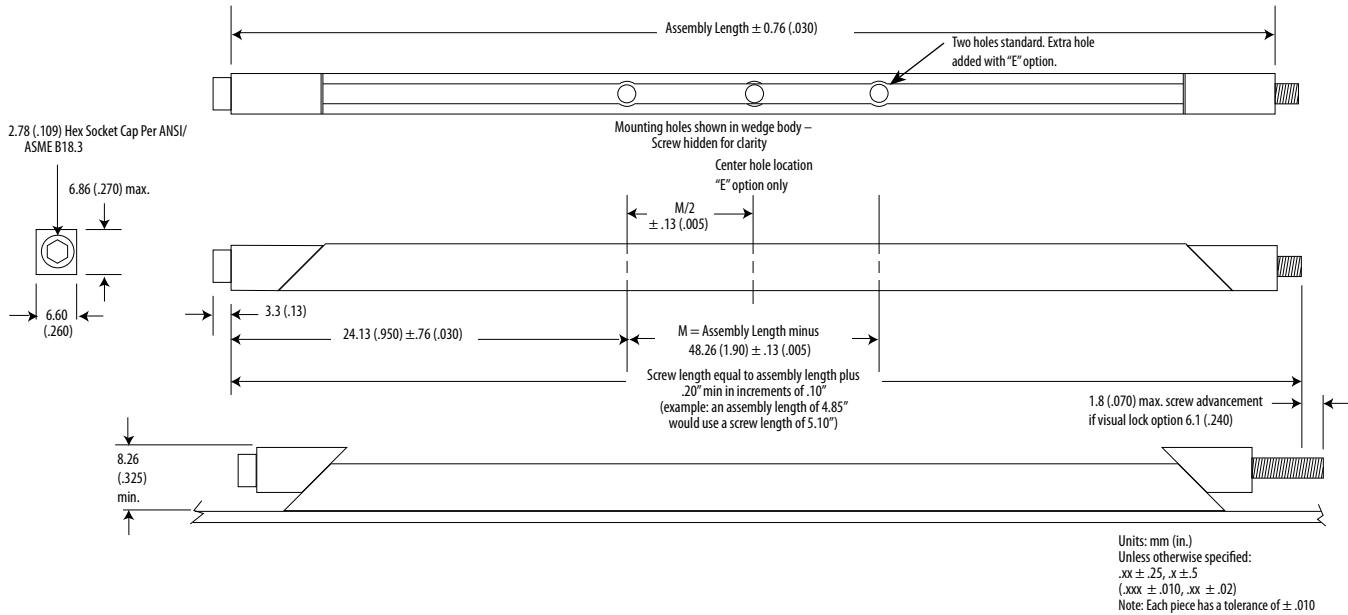
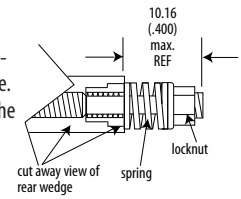
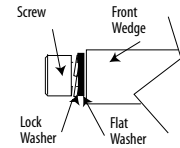

Part Number Code Series 245 Card-Lok Three Piece

M W V A 245 - 4.80 E H L R

Prefix options

- Metric Screw Head M2.5 **M**
- Standard Screw Head 7/64 **[blank]**
- Lock and Flat Washer **W**
- None **[blank]**
- Visual Indicator (changes hex drive to 3/32) **V**
- No Visual Indicator **[blank]**
- Black Anodize **A**
- or choose from Finish Table **see table**

Suffix options

- Stainless Steel Lock Nut if "R" option is selected **CR**
- Standard Plated Steel **" "**
- Assembly length in inches. Standard lengths range from 71.12 (2.80), 96.52 (3.80) and 121.9 (4.80). **length.xx**
- Other lengths available upon request
- Additional Center Mounting Hole **E**
- None **[blank]**
- Mounting Options - holes for rivet mounting **H**
- or choose from Mounting Option Table **see table**
- Lock Element **L**
- None **[blank]**
- Lock Nut **R**
- None **[blank]**
- Captive Screw **K**
- None **[blank]**

Part Number Code Example:

245-3.80H Series 245 three piece Card-Lok, 96.52 (3.80) long, gold chemical film finish with holes for rivet mounting

FINISH TABLE

Code Letter	Finish
[blank]	Chemical Film per Mil-DTL-5541 Class 1A, Type 1, Gold
"R"	Chemical Film per Mil-DTL-5541 Class 3, Type II, Clear
"A"	Black Anodize per Mil-A-8625 Type II, Class 2
"HA"	Hard Black Anodize per Mil-A-8625 Type III, Class 2
"EN"	Electroless Nickel per Mil-C-26074 Class 4, Grade B, Bright

MOUNTING METHOD TABLE

Code Letter	Method
[blank]	No mounting holes
"H"	Rivet Mounting Ø1.70 (.067) hole with 3.96 (.156) counterbore x 5.08 (.200) deep and 100° x 3.56 (.140) countersink
"T0"	0-80 tapped hole
"T2"	2-56 tapped hole
"TM2"	M2 x 0.40 tapped hole
"TM2.5"	M2.5 x 0.45 tapped hole

Calmark offers the Series 250 "Card-Lok" Retainer for cold plate-heat exchanger applications. A maximum efficiency heat sinking Board Module Assembly retainer offered to provide greater clamping force and load capacity for Board Module Assembly of greater weight and mass.

FEATURES

- Maximum reliability - Screw-actuated wedge action locks Board Module Assembly in place
- Maximum thermal transfer - Wedge action design provides maximum contact between thermal paths on Board Module Assembly and the heat sinking surface
- Maximum resistance to shock and vibration - Wedge action design locks Board Module Assembly in place to provide maximum resistance to shock and vibration
- Zero insertion and extraction forces - Screw actuation provides zero insertion and extraction force on Board Module Assembly
- Design flexibility - Special lengths, finishes or other design variations available on request



Series 250 - "Card-Lok" Retainer (cold plate)

BODIES & WEDGES

Material:

Aluminum alloy 6061-T6 per ASTM-B221 or AMS-QQ-A-200/8

Finish:

See Finish Table

SCREW

Material:

Stainless steel per ASTM-A582

Finish:

Passivate per MIL-S-5002

WEIGHT

3.63 g/cm (.325 oz/in)

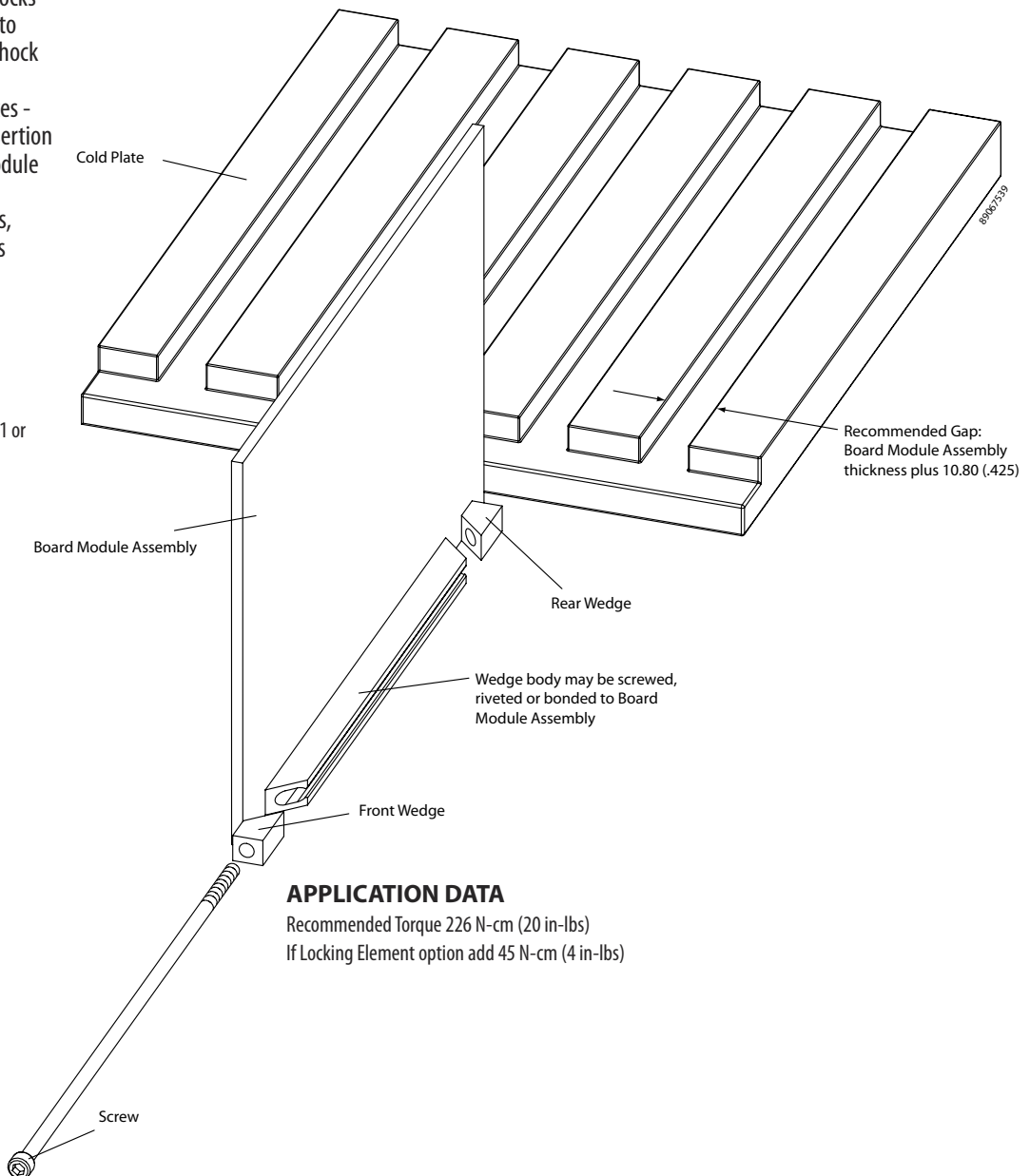

APPLICATION DATA

Recommended Torque 226 N-cm (20 in-lbs)
If Locking Element option add 45 N-cm (4 in-lbs)

OPTION PREFIX

Detail "V"

Provides visual lock indication. This option adds 5.08 (.20) to the screw length.

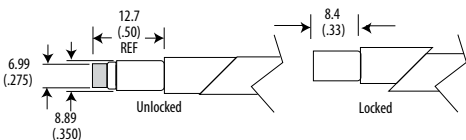

Detail "W"

Provides added resistance to loosening from shock and vibration. This option adds 5.08 (.20) to the screw length when combined with the "R" suffix option.

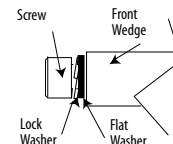

OPTION SUFFIX

Detail "L"

Provides prevailing torque for resistance to loosening from shock and vibration. Adds 45 N-cm (4 in-lbs) torque to assembly. See application data on previous sheet.

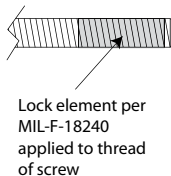

Detail "R"

Reduces the possibility of unintentional disassembly of the screw from rear wedge. This option adds no additional screw length unless included with "W" option, then 5.08 (.20) total.

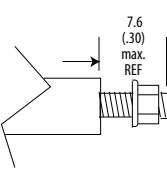

Detail "K"

Prevents the unintentional disassembly of screw from rear wedge. This option adds 5.08 (.20) to the screw length.

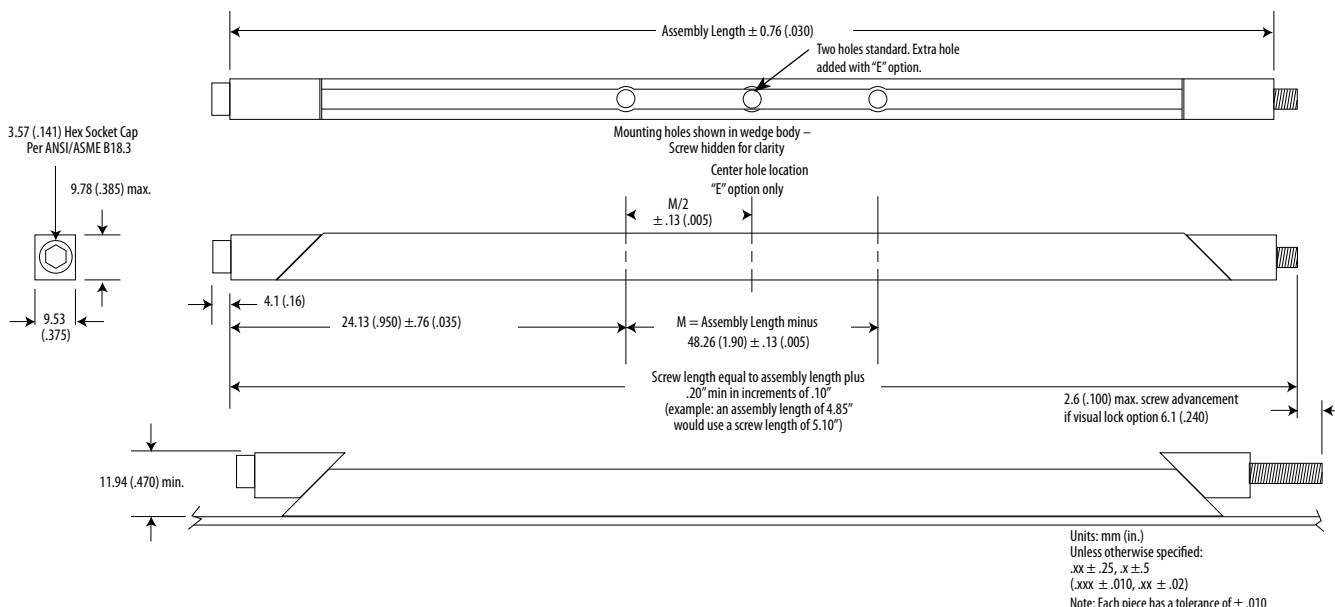
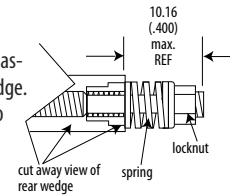

Part Number Code		Series 250 Card-Lok Three Piece	
Prefix options	M W V A	250 -	3.80 E H L R
Metric Screw Head M4 Hex Drive	M		
Standard Screw Head 9/64 Hex Drive	[blank]		
Lock and Flat Washer	W		
None	[blank]		
Visual Indicator	V		
No Visual Indicator	[blank]		
Black Anodize	A		
or choose from Finish Table	see table		
Suffix options			CR "-"
Stainless Steel Lock Nut if "R" option is selected			CR
Standard Plated Steel Lock Nut			"-"
Assembly length in inches. Standard lengths range from 71.12 (2.80), 96.52 (3.80) and 121.9 (4.80).		length.xx	
Other lengths available upon request			
Additional Center Mounting Hole			E
None			[blank]
Mounting Options - holes for rivet mounting			H
or choose from Mounting Option Table			see table
Lock Element			L
None			[blank]
Lock Nut			R
None			[blank]
Captive Screw			K
None			[blank]

Part Number Code Example:

V250CR4.80HR

Series 250 Card-Lok three piece 121.9 (4.80) long with Visual Indicator, gold chemical film finish, standard rivet mounting hole and stainless steel lock nut option

FINISH TABLE

Code Letter	Finish
[blank]	Chemical Film per Mil-DTL-5541 Class 1A, Type 1, Gold
"R"	Chemical Film per Mil-DTL-5541 Class 3, Type II, Clear
"A"	Black Anodize per Mil-A-8625 Type II, Class 2
"HA"	Hard Black Anodize per Mil-A-8625 Type III, Class 2
"EN"	Electroless Nickel per Mil-C-26074 Class 4, Grade B, Bright

MOUNTING METHOD TABLE

Code Letter	Method
[blank]	No mounting holes
"H"	Rivet Mounting Ø3.45 (.136) hole with 4.95 (.195) counterbore x 7.62 (.300) deep and 100° x 4.95 (.195) countersink
"T0"	0-80 tapped hole
"T2"	2-56 tapped hole
"TM2"	M2 x 0.40 tapped hole
"TM2.5"	M2.5 x 0.45 tapped hole

Calmark offers the Series 255 "Card-Lok" Retainer for cold plate-heat exchanger applications. A maximum efficiency heat sinking Board Module Assembly retainer offered to provide greater clamping force and load capacity for Board Module Assembly of greater weight and mass.

FEATURES

- Maximum reliability - Screw-actuated wedge action locks Board Module Assembly in place
- Maximum thermal transfer - Wedge action design provides maximum contact between thermal paths on Board Module Assembly and the heat sinking surface
- Maximum resistance to shock and vibration - Wedge action design locks Board Module Assembly in place to provide maximum resistance to shock and vibration
- Zero insertion and extraction forces - Screw actuation provides zero insertion and extraction force on Board Module Assembly
- Design flexibility - Special lengths, finishes or other design variations available on request

BODIES & WEDGES

Material:

Aluminum alloy 6061-T6 per ASTM-B221 or AMS-QQ-A-200/8

Finish:

See Finish Table

SCREW

Material:

Stainless steel per ASTM-A582

Finish:

Passivate per MIL-S-5002

WEIGHT

4.74 g/cm (.425 oz/in)



Series 255 "Card-Lok" Retainer (cold plate)

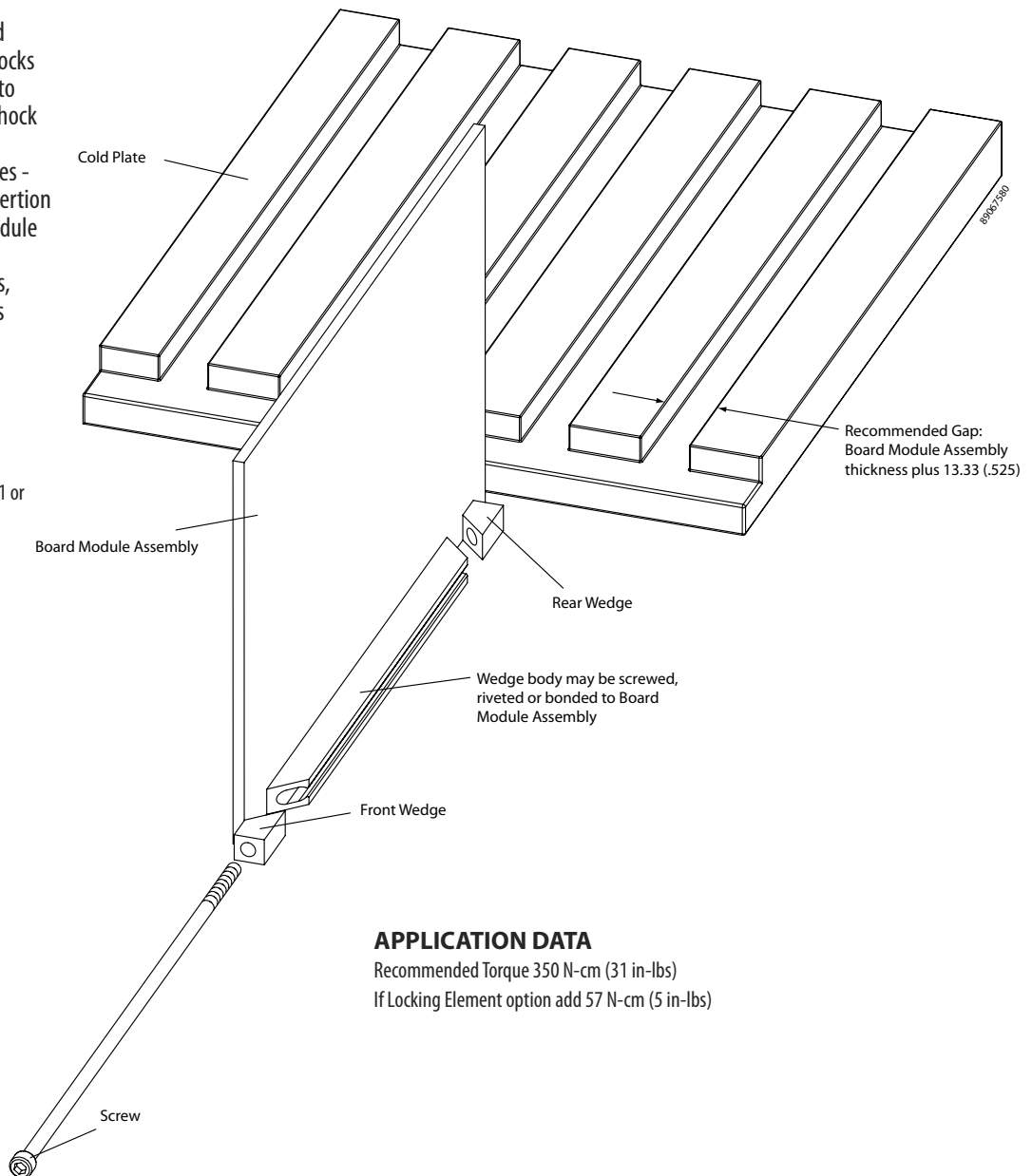

APPLICATION DATA

Recommended Torque 350 N-cm (31 in-lbs)

If Locking Element option add 57 N-cm (5 in-lbs)

OPTION PREFIX

Detail "V"

Provides visual lock indication. This option adds 5.08 (.20) to the screw length.

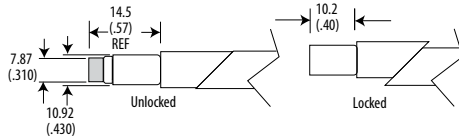

Detail "W"

Provides added resistance to loosening from shock and vibration. This option adds 5.08 (.20) to the screw length when combined with the "R" suffix option.

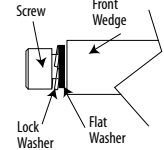

OPTION SUFFIX

Detail "L"

Provides prevailing torque for resistance to loosening from shock and vibration. Adds 57 N-cm (5 in-lbs) torque to assembly. See application data on previous sheet.

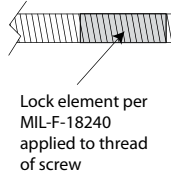

Lock element per MIL-F-18240 applied to thread of screw

Detail "R"

Reduces the possibility of unintentional disassembly of the screw from rear wedge. This option adds no additional screw length unless included with "W" option, then 5.1 (.20) total.

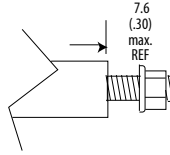

Detail "K"

Prevents the unintentional disassembly of screw from rear wedge. This option adds 5.08 (.20) to the screw length.

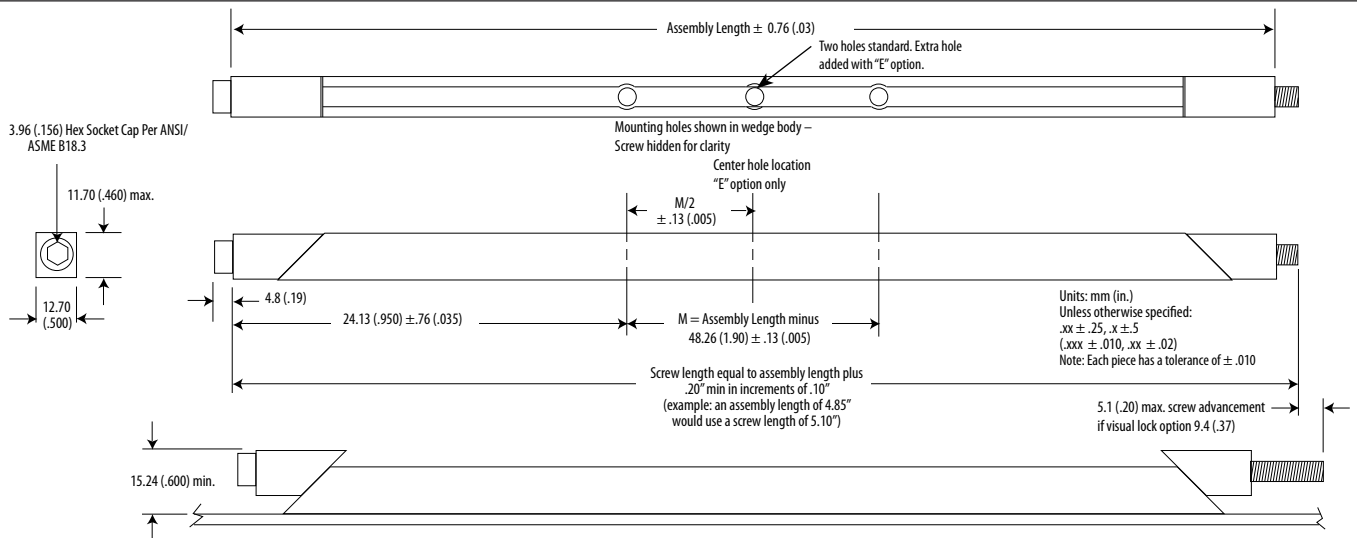
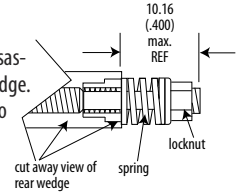

3.96 (.156) Hex Socket Cap Per ANSI/ASME B18.3

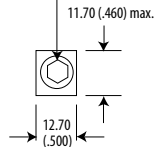

15.24 (.600) min.

Part Number Code

Series 255 Card-Lok Three Piece

Prefix options

Metric Screw Head M4 Hex Drive **M**
 Standard Screw Head 5/32 Hex Drive **[blank]**
 Lock and Flat Washer **W**
 None **[blank]**
 Visual Indicator **V**
 No Visual Indicator **[blank]**
 Black Anodize **A**
 or choose from Finish Table **see table**

Suffix options

Stainless Steel Lock Nut if "CR" option is selected **CR**
 Standard Plated Steel Lock Nut **"_"**

Assembly length in inches. Standard lengths range from 71.12 (2.80), 96.52 (3.80) and 121.9 (4.80). **length.xx**
 Other lengths available upon request

Additional Center Mounting Hole **E**
 None **[blank]**
 Mounting Options - holes for rivet mounting or choose from Mounting Option Table **see table**
 Lock Element **L**
 None **[blank]**
 Lock Nut **R**
 None **[blank]**
 Captive Screw **K**
 None **[blank]**

Part Number Code Example:

VA255CR4.80HR

Series 255 Card-Lok three piece 121.9 (4.80) long with Visual Indicator, black anodized finish, standard rivet mounting hole and stainless steel lock nut option

FINISH TABLE

Code	Finish
[blank]	Chemical Film per Mil-DTL-5541 Class 1A, Type 1, Gold
"R"	Chemical Film per Mil-DTL-5541 Class 3, Type II, Clear
"A"	Black Anodize per Mil-A-8625 Type II, Class 2
"HA"	Hard Black Anodize per Mil-A-8625 Type III, Class 2
"EN"	Electroless Nickel per Mil-C-26074 Class 4, Grade B, Bright

MOUNTING METHOD TABLE

Code	Method
[blank]	No mounting holes
"H"	Rivet Mounting Ø3.45 (.136) hole with 4.95 (.195) counterbore x 9.91 (.390) deep and 100° x 4.95 (.195) countersink
"T0"	0-80 tapped hole
"T2"	2-56 tapped hole
"TM2"	M2 x 0.40 tapped hole
"TM2.5"	M2.5 x 0.45 tapped hole

Calmark offers the advance design Series 260 "Card-Lok" retainer for cold plate/heat exchanger applications. This totally unique design incorporates design advancements that provide increased thermal transfer, easy insertion and lighter weight. Conforms to DSSC 89024.

FEATURES

- Maximum uniform clamping force
- Increased thermal transfer
- Maintains wedge and body alignment for easy insertion
- Captivated rear wedge
- Choice of screw head style
- Dimensionally compatible with Series 225 & 245
- Lighter weight
- Design Flexibility - Special lengths, finishes or other design options available on request

BODIES, WEDGES & SHAFTS

Material:

Aluminum alloy 6061-T6 per ASTM-B221 or AMS-QQ-A-200/8

Finish:

See Part Number Code

SCREW, LOCK & FLAT WASHER

Screw:

Stainless steel per ASTM-A582
Passivated per AMS2700
or NAS1352C (depending on option)

Washer:

Stainless steel per ASTM-A240
Passivated per AMS2700

Lock Washer:

MS35338-135

WEIGHT

.95 g/cm (.085 oz/in)

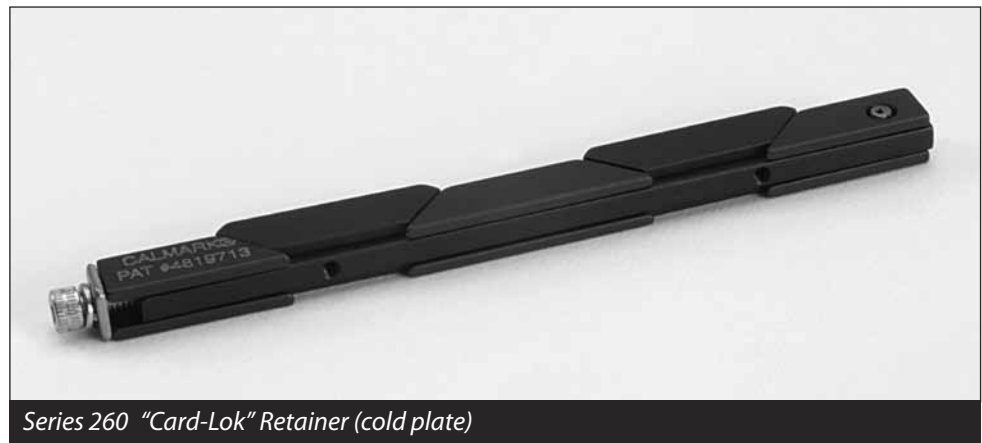

Series 260 "Card-Lok" Retainer (cold plate)

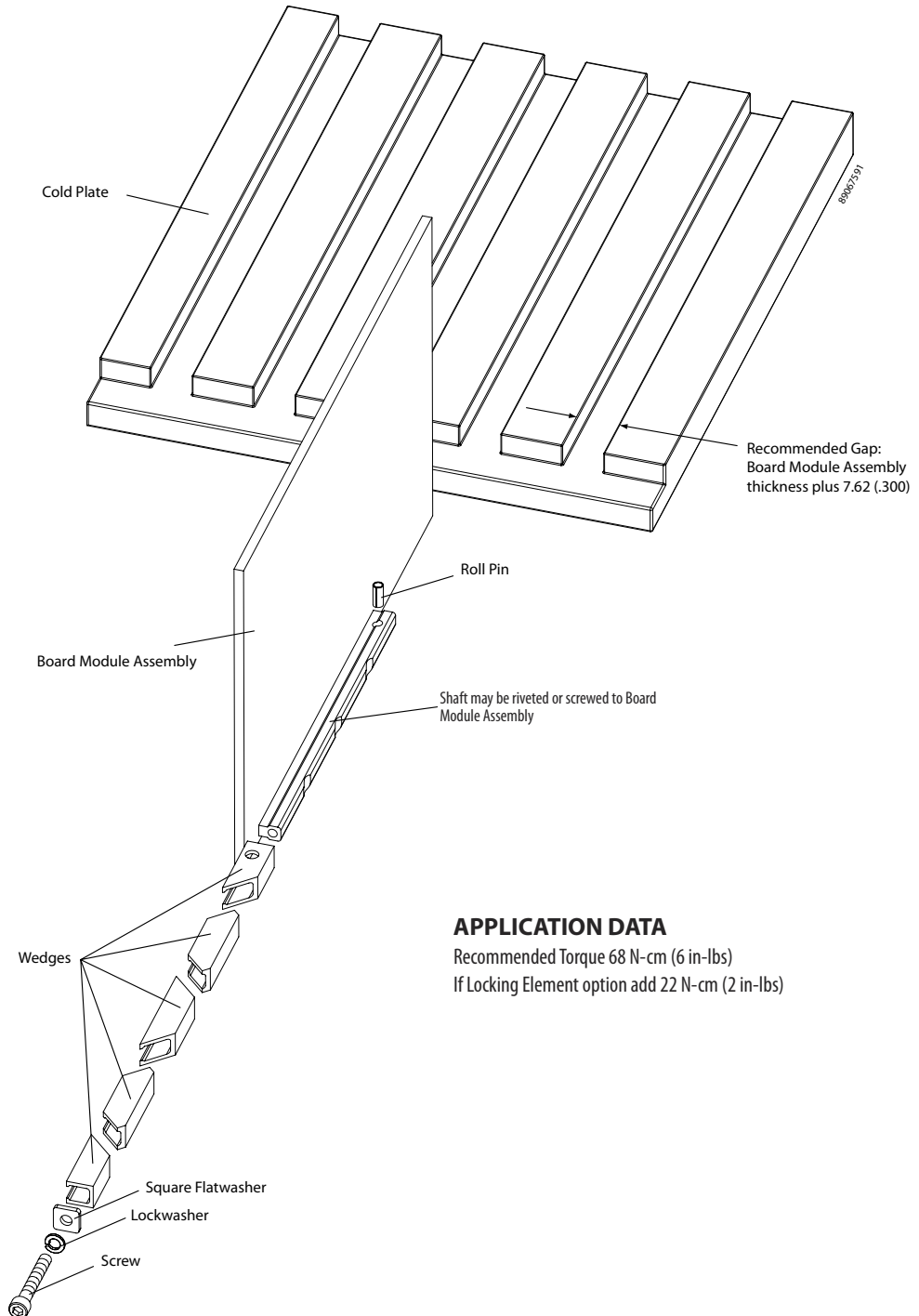

APPLICATION DATA

Recommended Torque 68 N-cm (6 in-lbs)
If Locking Element option add 22 N-cm (2 in-lbs)

OPTION PREFIX

Detail "V"

Provides visual lock indication.

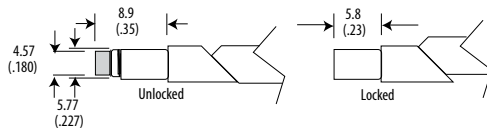

OPTION SUFFIX

Detail "L"

Provides prevailing torque for resistance to loosening from shock and vibration. Adds 22 N-cm (2 in-lbs) torque to assembly. See application data on previous sheet.

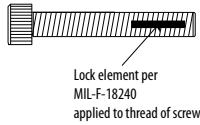

Detail "K"

Prevents the unintentional disassembly of screw from front wedge.

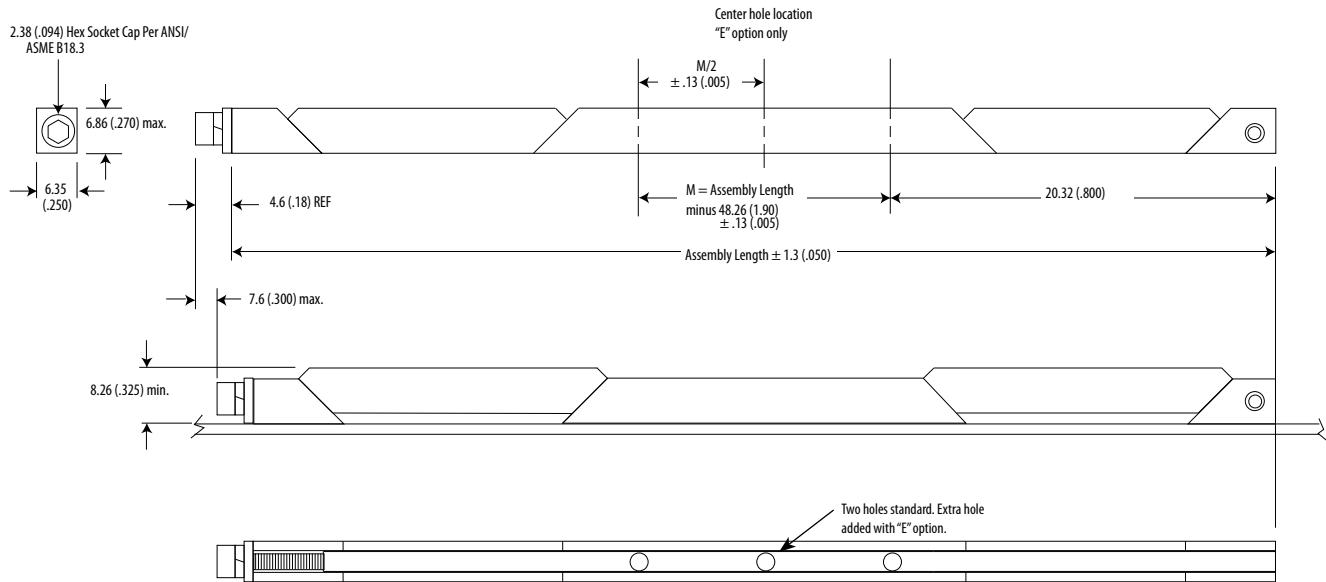
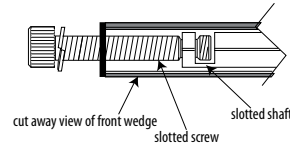

Units: mm (in.)
Unless otherwise specified:
.xx ± .25, x ± 5
(xxx ± .010, xx ± .02)
Note: Each piece has a tolerance of ± .010

Part Number Code Series 260 Card-Lok Five Piece

M V A 260 - 3.80 E H L K

Prefix options

Metric Screw Head M2.5 Hex Drive **M**
Standard Screw Head 3/32 Hex Drive [blank]
Visual Indicator **V**
No Visual Indicator [blank]
Black Anodize **A**
or choose from Finish Table *see table*

Suffix options

Assembly length in inches. Standard lengths range from 71.12 (2.80), 96.52 (3.80) and 121.9 (4.80). length.xx
Other lengths available upon request
Additional Center Mounting Hole **E**
None [blank]
Mounting Options - through mounting holes **H**
or choose from Mounting Option Table *see table*
Lock Element **L**
None [blank]
Captive Screw **K**
None [blank]

Part Number Code Example:

MVA260-3.80ET2LK

Series 260 Card-Lok five piece 96.52 (3.80) long black anodized with M2.5 hex drive, visual indicator, three mounting holes tapped for 2-56 thread, locking element and captive screw feature

Code Letter	Finish
[blank]	Chemical Film per Mil-DTL-5541 Class 1A, Type 1, Gold
"R"	Chemical Film per Mil-DTL-5541 Class 3, Type II, Clear
"A"	Black Anodize per Mil-A-8625 Type II, Class 2
"HA"	Hard Black Anodize per Mil-A-8625 Type III, Class 2
"EN"	Electroless Nickel per Mil-C-26074 Class 4, Grade B, Bright

Code Letter	Method
"H"	Ø1.73/1.85 (.068/.073) dia. through holes countersink 100° x 1.50 (.060) deep
"T0"	0-80 tapped hole
"T2"	2-56 tapped hole
"TM2"	M2 x 0.40 tapped hole
"TM2.5"	M2.5 x 0.45 tapped hole

Calmark offers the Series L260 Lever-Lok "Card-Lok" retainer for cold plate/heat exchanger applications. This totally unique design provides tool free, lever action locking on the advance design Series 260 Card-Lok. The Series L260 provides visual indication of accurate, repeatable locking to a preset clamping force.

FEATURES

- Tool-free actuation
- Visual indication of locked or unlocked status
- Preset and adjustable clamping force
- Clamping force consistently repeated
- Maintains wedge and body alignment for easy installation
- Design Flexibility - Special lengths, finishes, or other design options available on request

MATERIALS & FINISHES

WEDGE, BODY, SHAFT & LEVER

Material:

Aluminum alloy 6061-T6 per ASTM-B221 or AMS-QQ-A-200/8

Finish:

Wedge, Body, Shaft & Lever: Black Anodize per MIL-A-8625, Type II, Class 2.

Wedges: also have Dry Film Lube per MIL-PRF-46010

Lever: Hard Black Anodize per MIL-A-8625, Type III, Class 2

ADJUSTMENT SCREW

Material:

Stainless Steel per ASTM-A582\QQ-S-763

Finish:

Passivate per AMS2700

HARDWARE

Material:

Front Washer: MPIF Standard 35

Rear Washer: ASTM-A240

Spring Washers: ASTM-A666

Finish:

Passivate per Mil-S-5002

WEIGHT

1.17 g/cm (.105 oz/in)



Series L260 "Card-Lok" Retainer (Lever-Lok)

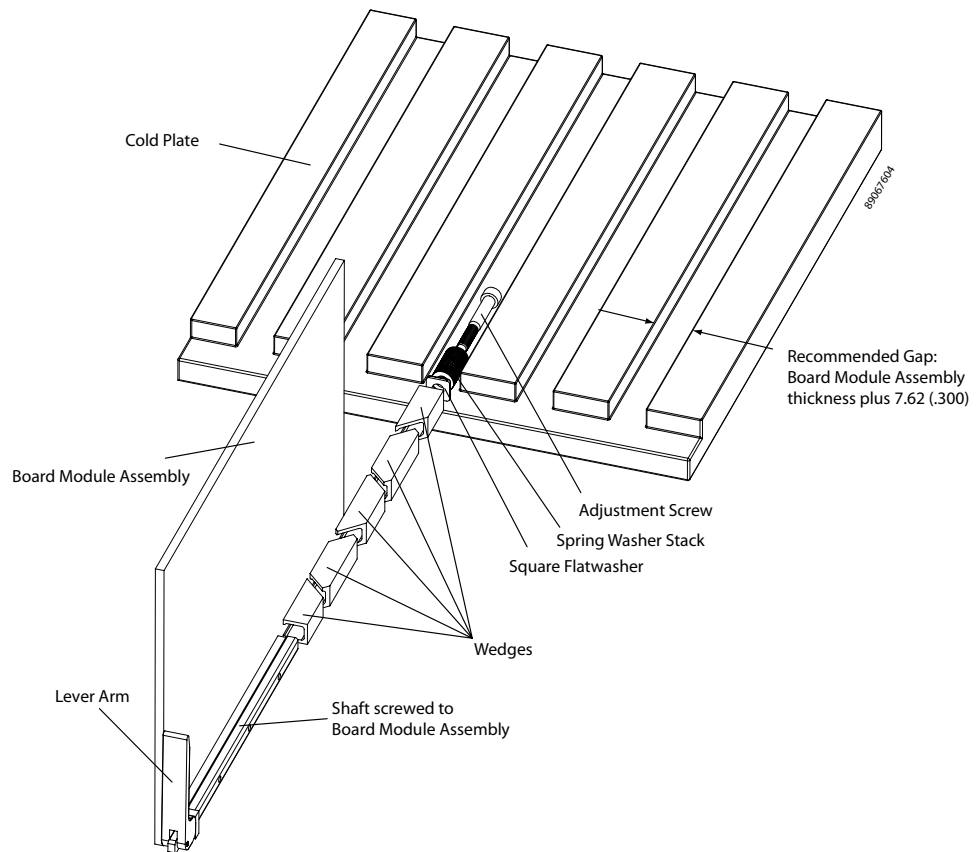

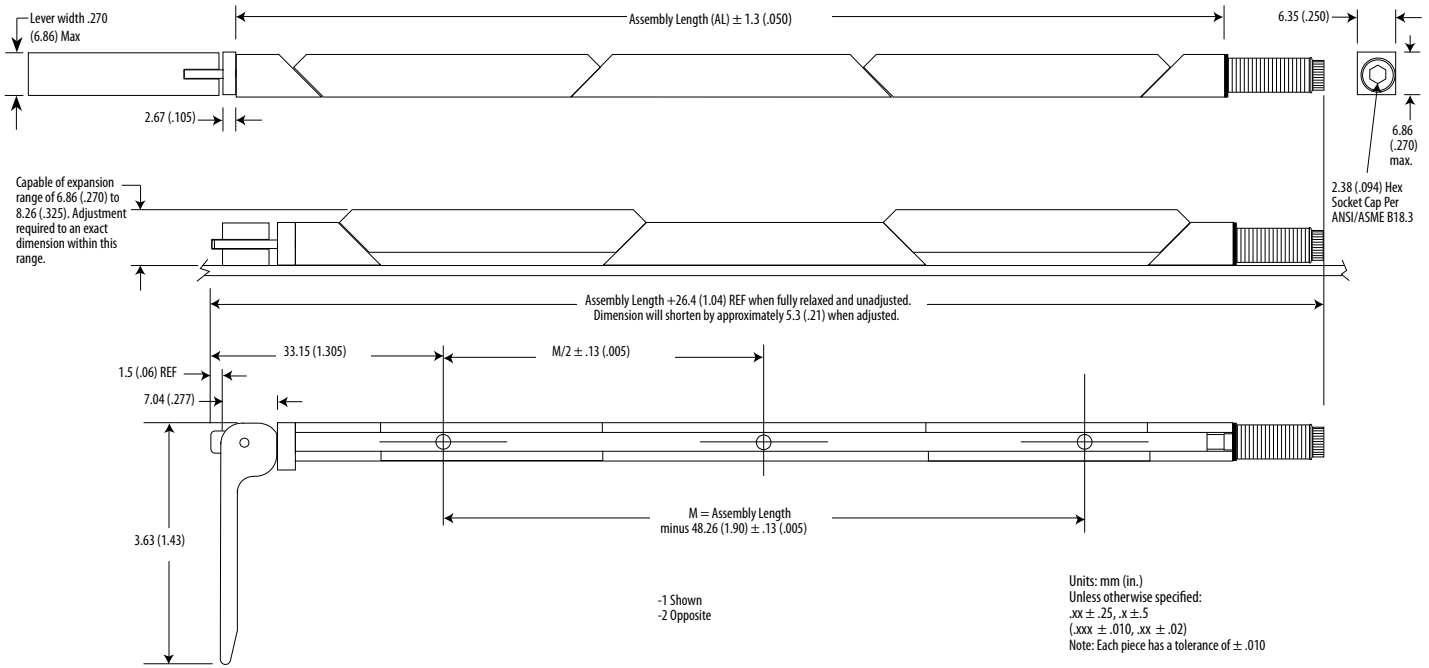

CLAMPING FORCE ADJUSTMENT PROCEDURE

Lever-Lok is furnished unadjusted and will require the use of the following procedure to achieve proper clamping.

NOTE: Factory preset adjustment available on request. (See part number code)

1. Fasten Lever-Lok to Board Module Assembly
2. Insert Board Module Assembly into slot in cold plate
3. Actuate lever to locked/closed position
4. Tighten screw on end of shaft until wedges initially contact wall of cold plate slot, or slight insertion extraction drag is felt
5. Additionally tighten screw 2 full turns.

DO NOT EXCEED TWO (2) TURNS

6. Lever-Lok is now ready to use

Note: Factory adjustment of clamping force available on request. See P and P2 suffix option in Part Number Code table.

CLAMPING FORCE DATA

Direct force of assembly is approximately 556N (125lbs), when adjusted per recommended procedure.

Direct force of assembly is affected approximately as follows: 26.7N (6lbs) per each .025 (.001) variation of cold plate slot width, or 169N (38lbs) per each full turn of screw.

Part Number Code	
Series L260 Card-Lok Five Piece	L260 - 3.80 TM2 -1 P
Suffix options	
Assembly length in inches. Standard lengths range from 71.12 (2.80), 96.52 (3.80) and 121.9 (4.80)	length.xx
Other lengths available upon request	
Mounting Options - M2 x 0.40 tapped holes	TM2
or choose from Mounting Option Table	see table
Lever Direction	-1
	-2
Factory Preset clamping force when expanded to 7.63 (.300)	
556N (125lbs)	P
645N (145lbs)	P2
None	[blank]

Part Number Code Example:

L260-3.80TM2-1

Series L260 five piece lever actuated Card-Lok 96.52 (3.80) long with black anodized finish, -1 lever direction and no factory preset clamping load

MOUNTING METHOD TABLE

Code Letter	Method
[blank]	2-56 tapped hole
"TM2"	M2 x 0.40 tapped hole
"TM2.5"	M2.5 x 0.45 tapped hole

Calmark offers the Series LE260 Extracting/Lever-Lok ("Card-Lok") retainer for cold plate/heat-exchanger applications. This totally unique design provides the significant feature of Board Module Assembly extraction in addition to tool free lever action locking. The Series LE260 provides visual indication of accurate, repeatable locking to a preset clamping force.

FEATURES

- Safe and easy Board Module Assembly extraction with 4:1 mechanical advantage
- Tool-free actuation
- Visual indication of locked or unlocked status
- Preset and adjustable clamping force
- Clamping force consistently repeated
- Maintains wedge and body alignment for easy installation
- Design Flexibility - Special lengths, finishes, or other design options available on request

MATERIALS & FINISHES

WEDGE, BODY, SHAFT & LEVER

Material:

Aluminum alloy 6061-T6 per ASTM-B221 or AMS-QQ-A-200/8

Finish:

Wedge & Shaft: Black Anodize per MIL-A-8625, Type II, Class 2

Wedges: also have Dry Film Lube per MIL-PRF-46010

Lever: Hard Black Anodize per MIL-A-8625, Type III, Class 2

ADJUSTMENT SCREW

Material:

Stainless steel per ASTM-A582 or AMS-QQ-S-763

Finish:

Passivate per AMS2700

HARDWARE

Material:

Front Washer: MPIF Standard 35

Rear Washer: ASTM-A240

Spring Washers: ASTM-A266

Finish:

Passivate per Mil-S-5002

WEIGHT

1.17 g/cm (.105 oz/in)



Series LE260 "Card-Lok" Retainer (extracting/lever-lok)

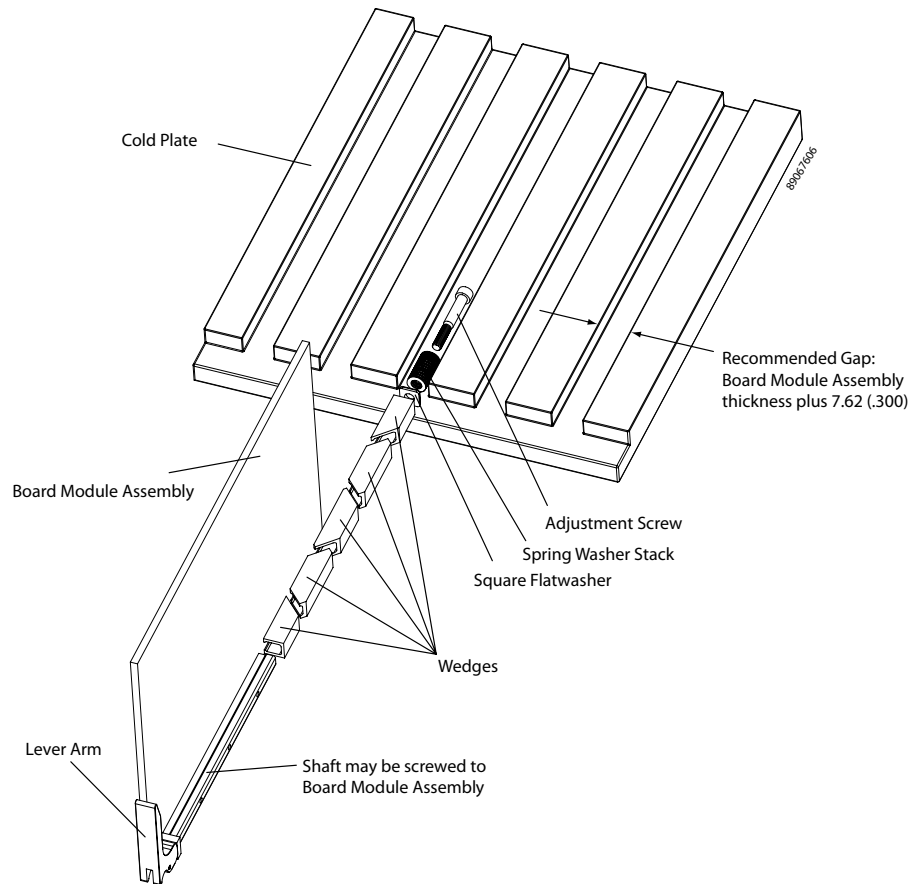

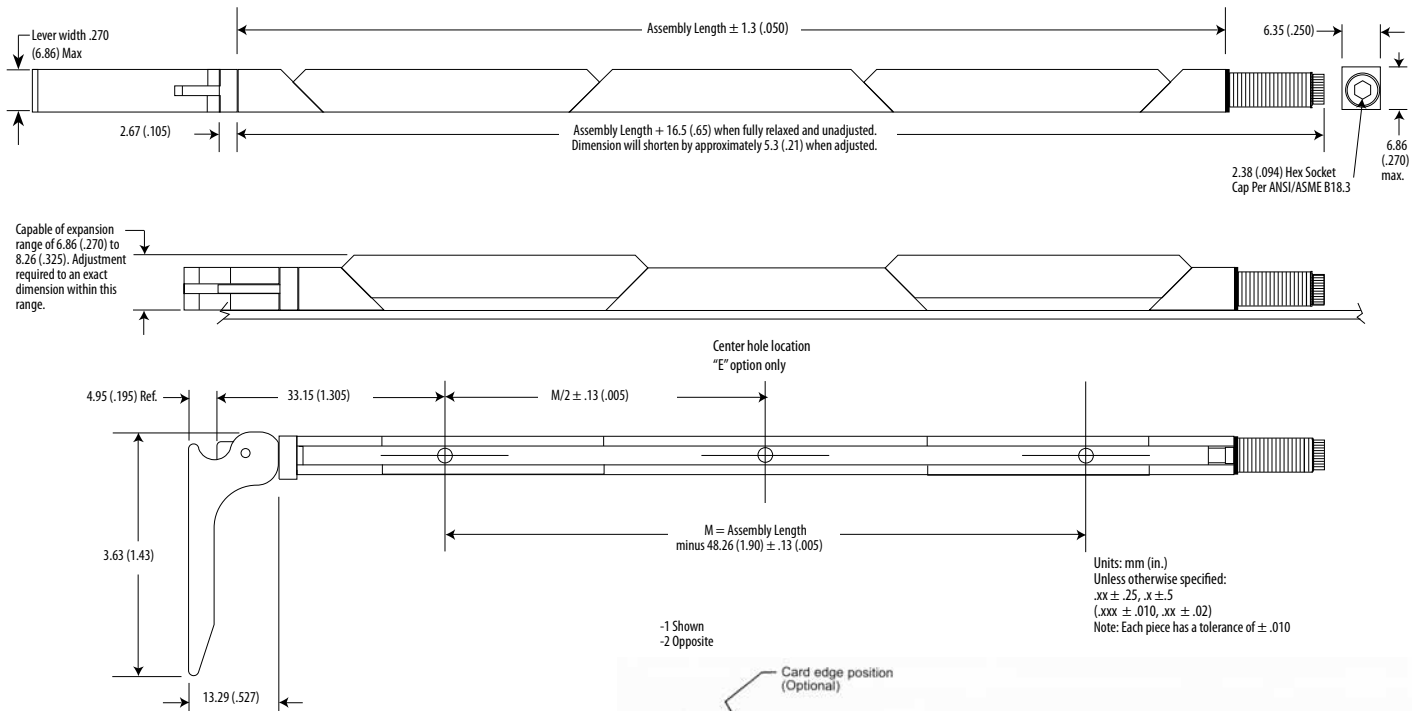

CLAMPING FORCE ADJUSTMENT PROCEDURE

Lever-Lok furnished assembled with spring stack preloaded but not adjusted.

1. Fasten Lever-Lok to Board Module Assembly
2. Insert Board Module Assembly into slot in cold plate
3. Actuate lever to locked/closed position
4. Tighten screw on end of shaft until wedges initially contact wall of cold plate slot, or slight insertion extraction drag is felt
5. Additionally tighten locknut two full turns. **DO NOT EXCEED TWO (2) TURNS.**
6. Lever-Lok is now ready to use

NOTE: Factory adjustment of clamping force available on request. See part number code.

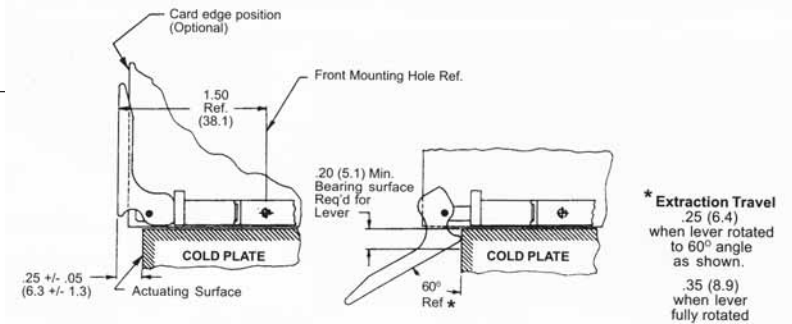

CLAMPING FORCE DATA

Direct force of assembly is approximately 556N (125lbs), when adjusted per recommended procedure.

Direct force of assembly is affected approximately as follows: 26.7N (6lbs) per each .025 (.001) variation of cold plate slot width, or 169N (38lbs) per each full turn of screw.

Part Number Code
Series LE260 Card-Lok Five Piece _____

LE260 - 3.80 TO -1 P

Suffix options
 Assembly length in inches. Standard lengths range from 71.12 (2.80), 96.52 (3.80) and 121.9 (4.80). _____ length.xx
 Other lengths available upon request

Mounting Options - 0-80 tapped holes _____ TO
 or choose from Mounting Option Table _____ see table

Lever Direction _____ -1
 _____ -2

Factory Preset clamping force when expanded to 7.62 (.300)
 556N (125lbs) _____ P
 645N (145lbs) _____ P2
 None _____ [blank]

Part Number Code Example:

LE260-2.80TM2-1P2

Series LE260 five piece lever actuated Card-Lok with extractor feature, 71.12 (2.80) long with M2 x .40 tapped mounting holes, -1 lever direction and factory preset for 645N (145lbs) clamping force when expanded to .300 DIM

MOUNTING METHOD TABLE

Code Letter	Method
[blank]	2-56 tapped hole
"TO"	0-80 tapped hole
"TM2"	M2 x 0.40 tapped hole
"TM2.5"	M2.5 x 0.45 tapped hole

Calmark offers the Series 261 "Card-Lok" Retainer for cold-plate, heat exchanger applications.

FEATURES

- Maximum uniform clamping force
- Increased thermal transfer
- Maintains wedge and body alignment for easy installation
- Captivated rear wedge
- Choice of screw head style
- Lighter weight
- Design Flexibility - Special lengths, finishes, or other design options available on request



Series 261 "Card-Lok" Retainer (cold plate)

WEDGES, BODY & SHAFT

Material:

Aluminum alloy 6061-T6 per ASTM-B221 or AMS-QQ-A-200/8

Finish:

See Finish Table

SCREW, LOCK & FLAT WASHER

Material:

300 Series Stainless Steel

Finish:

Passivate per Mil-S-5002

ROLL PIN

Material:

MS39086-125

Finish:

Passivate per Mil-S-5002

WEIGHT

.95 g/cm (.085 oz/in)

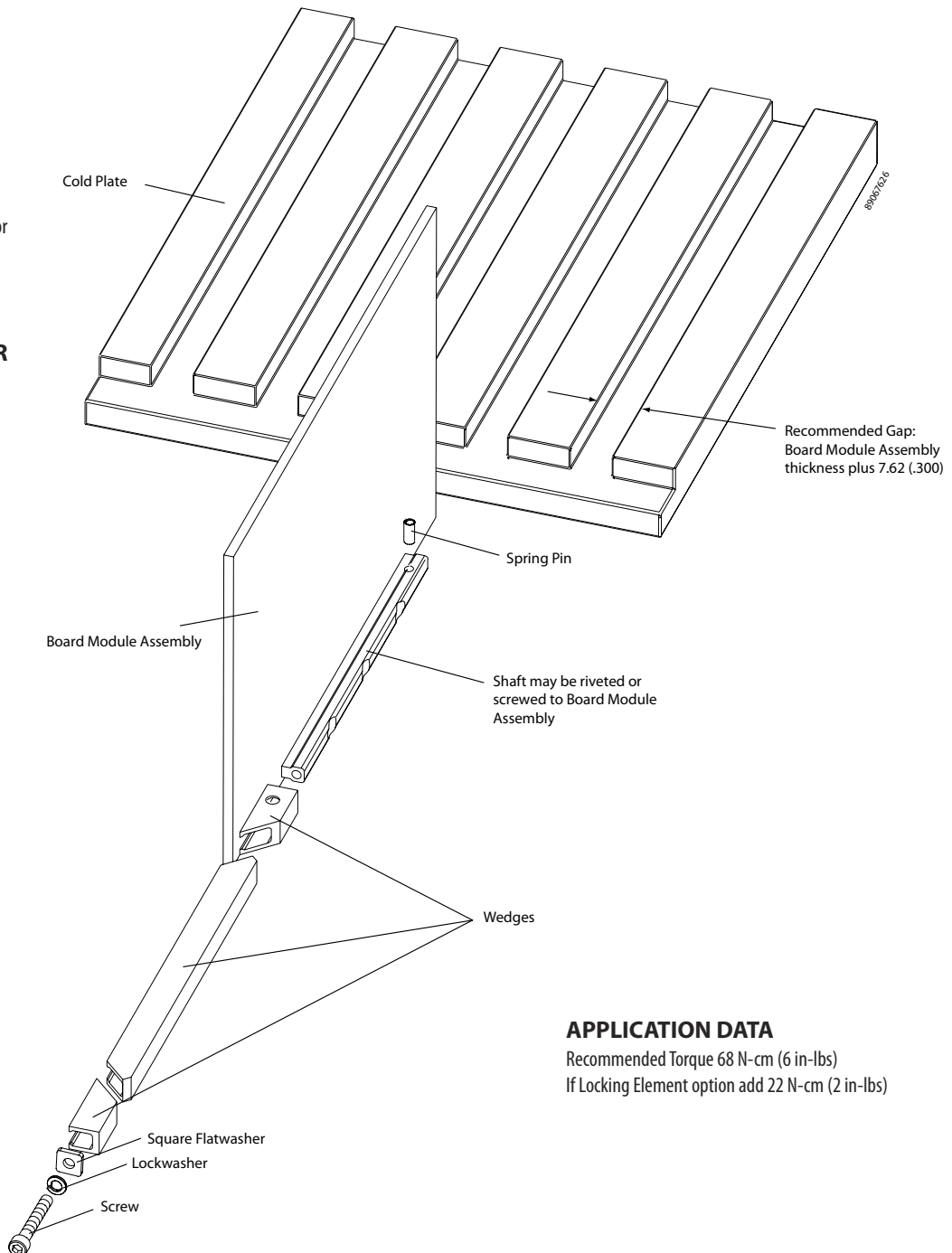

APPLICATION DATA

Recommended Torque 68 N-cm (6 in-lbs)
If Locking Element option add 22 N-cm (2 in-lbs)

OPTION PREFIX

Detail "V"

Provides visual lock indication.

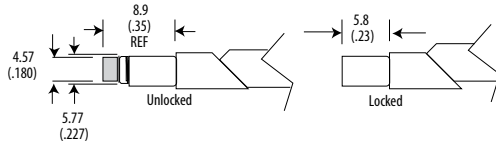

OPTION SUFFIX

Detail "L"

Provides prevailing torque for resistance to loosening from shock and vibration. Adds 22 N-cm (2 in-lbs) torque to assembly. See application data on previous sheet.

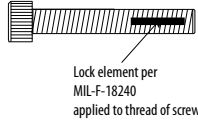

Detail "K"

Prevents the unintentional disassembly of screw from front wedge.

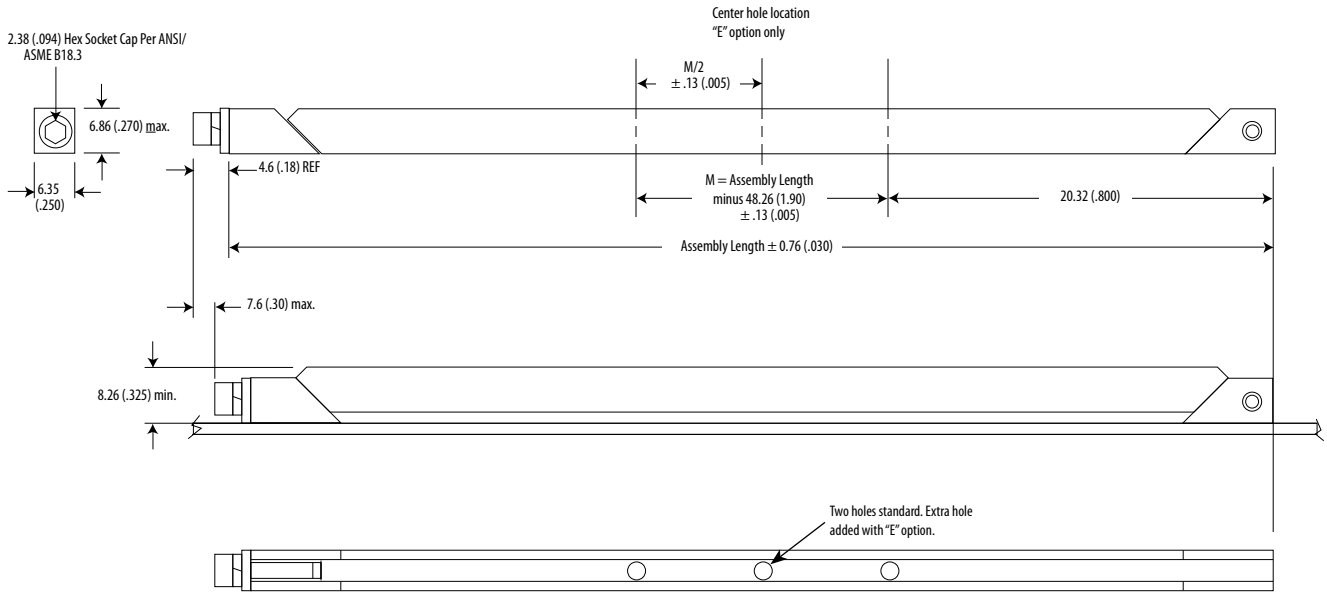
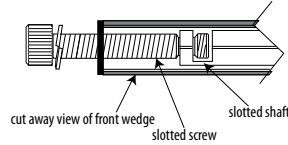

Units: mm (in.)
Unless otherwise specified:
.xx ± .25, .x ± .5
(.xxx ± .010, .xx ± .02)
Note: Each piece has a tolerance of ± .010

Part Number Code

Series 261 Card-Lok Three Piece

Prefix options

Metric Screw Head M2.5 Hex Drive **M**
Standard Screw Head 3/32 Hex Drive **[blank]**
Visual Indicator **V**
No Visual Indicator **[blank]**
Black Anodize **A**
or choose from Finish Table **see table**

Suffix options

Assembly length in inches. Standard lengths range from 71.12 (2.80), 96.52 (3.80) and 121.9 (4.80). **length.xx**
Additional Center Mounting Hole **E**
None **[blank]**
Mounting Options - Through mounting holes **H**
or choose from Mounting Option Table **see table**
Lock Element **L**
None **[blank]**
Captive Screw **K**
None **[blank]**

Part Number Code Example:

MVA261-3.80H

Series 261 Card-Lok three piece 96.52 (3.80) long with M2.5 socket head screw, visual indicator, black anodize finish and standard rivet mounting hole

FINISH TABLE

Code Letter	Finish
[blank]	Chemical Film per Mil-DTL-5541 Class 1A, Type 1, Gold
"R"	Chemical Film per Mil-DTL-5541 Class 3, Type II, Clear
"A"	Black Anodize per Mil-A-8625 Type II, Class 2
"HA"	Hard Black Anodize per Mil-A-8625 Type III, Class 2
"EN"	Electroless Nickel per Mil-C-26074 Class 4, Grade B, Bright

MOUNTING METHOD TABLE

Code Letter	Method
"H"	Ø1.73/1.85 (.068/.073) dia. through holes countersink 100° x 1.50 (.060) deep
"T0"	0-80 tapped hole
"T2"	2-56 tapped hole
"TM2"	M2 x 0.40 tapped hole
"TM2.5"	M2.5 x 0.45 tapped hole

Calmark offers the Series 263 "Card-Lok" Retainer for cold-plate, heat exchanger applications. This "Card-Lok" configuration offers a larger cross sectional profile for increased clamping force and thermal transfer.

FEATURES

- Maximum uniform clamping force
- Increased thermal transfer
- Maintains wedge and body alignment for easy installation
- Captivated rear wedge
- Choice of screw head style
- Lighter weight
- Lower cost - faster delivery
- Design Flexibility - Special lengths, finishes, or other design options available on request

WEDGES, BODIES & SHAFT

Material:

Aluminum alloy 6061-T6 per ASTM-B221 or AMS-QQ-A-200/8

Finish:

See Finish Table

SCREW

Material:

NAS1352C, Modified NAS1352C04 or 18-8 stainless steel

Finish:

Passivate per Mil-S-5002

LOCK WASHER

Material:

MS35338-135

Finish:

Passivate per Mil-S-5002

FLAT WASHER

Material:

300 Series Stainless Steel

Finish:

Passivate per Mil-S-5002

ROLL PIN

Material:

400 Series Stainless Steel

Finish:

Passivate per Mil-S-5002

WEIGHT

1.07 g/cm (.096 oz/in)



Series 263 "Card-Lok" Retainer (cold plate)

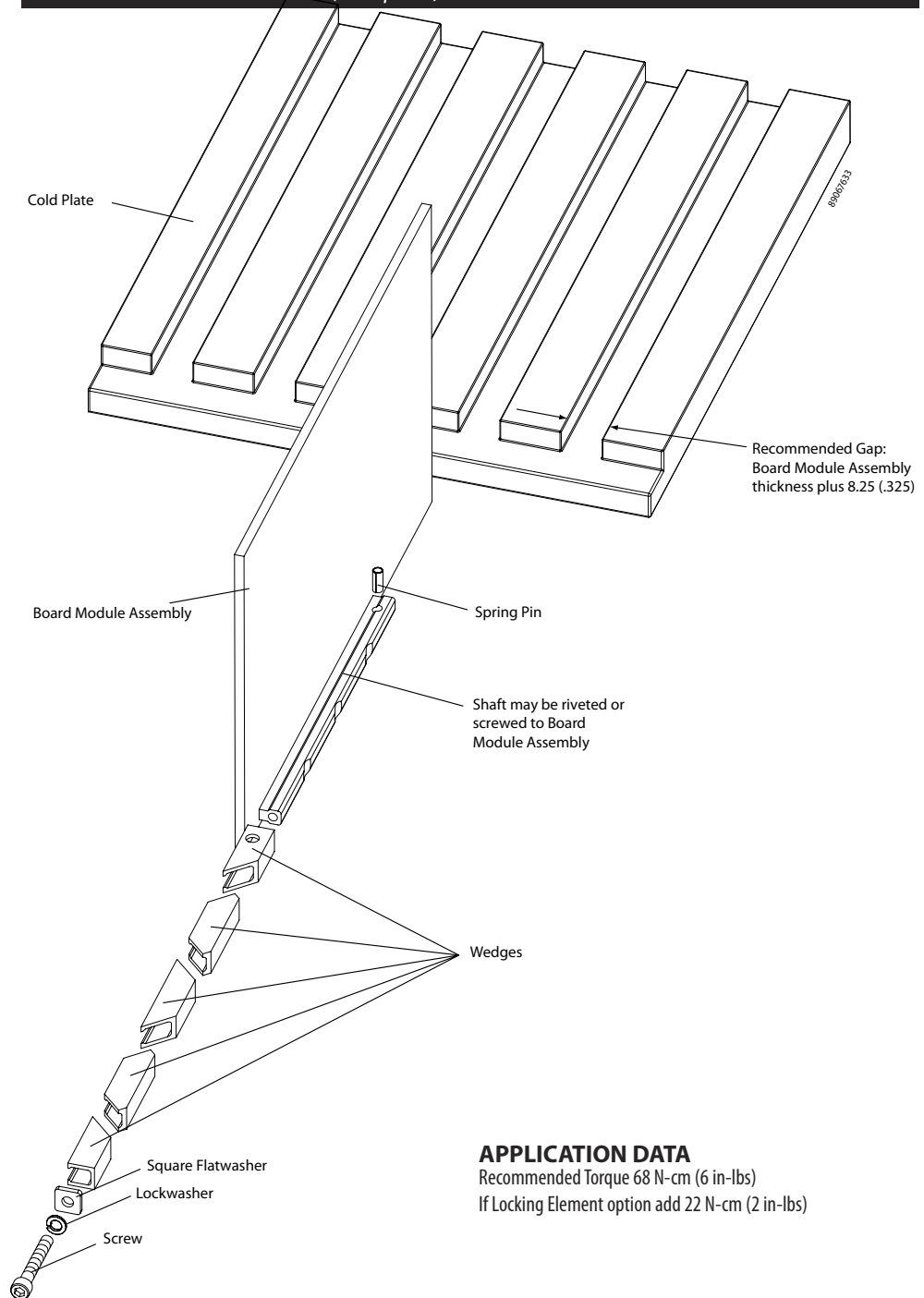

APPLICATION DATA

Recommended Torque 68 N-cm (6 in-lbs)

If Locking Element option add 22 N-cm (2 in-lbs)

OPTION PREFIX

Detail "V"

Provides visual lock indication.

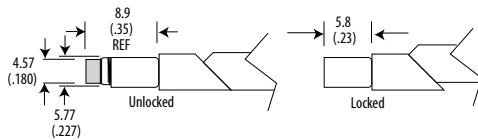

OPTION SUFFIX

Detail "L"

Provides prevailing torque for resistance to loosening from shock and vibration. Adds 22 N-cm (2 in-lbs) torque to assembly. See application data on previous sheet.

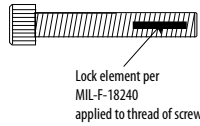

Detail "K"

Prevents the unintentional disassembly of screw from front wedge.

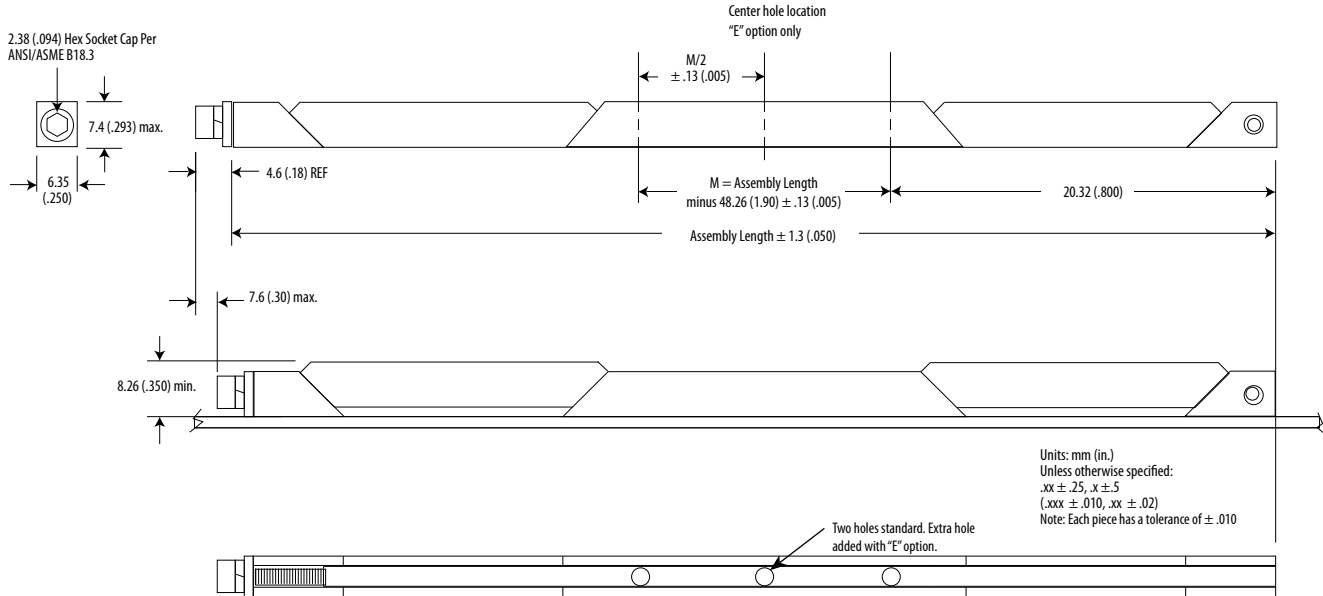
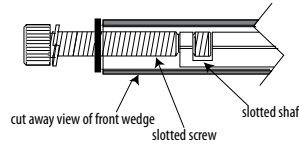

Units: mm (in.)
Unless otherwise specified:
.xx ± .25, .x ± .5
(.xxx ± .010, .xx ± .02)
Note: Each piece has a tolerance of ± .010

Part Number Code Series 263 Card-Lok Five Piece

M V A 263 - 3.80 E H L K

Prefix options

- Metric Screw Head M2.5 Hex Drive **M**
- Standard Screw Head 3/32 Hex Drive **[blank]**
- Visual Indicator **V**
- No Visual Indicator **[blank]**
- Black Anodize **A**
- or choose from Finish Table **see table**

Suffix options

- Assembly length in inches. Standard lengths range from 71.12 (2.80), 96.52 (3.80) and 121.9 (4.80). **length.xx**
- Other lengths available upon request
- Additional Center Mounting Hole **E**
- None **[blank]**
- Mounting Options - through mounting holes **H**
- or choose from Mounting Option Table **see table**
- Lock Element **L**
- None **[blank]**
- Captive Screw **K**
- None **[blank]**

Part Number Code Example:

V263-3.80ET0K

Series 263 Card-Lok five piece 96.52 (3.80) long with M3 socket head screw, visual indicator, gold chemical finish, 0-80 tapped mounting holes with an additional center mounting hole and a captive screw option

FINISH TABLE

Code Letter	Finish
[blank]	Chemical Film per Mil-DTL-5541 Class 1A, Type 1, Gold
"R"	Chemical Film per Mil-DTL-5541 Class 3, Type II, Clear
"A"	Black Anodize per Mil-A-8625 Type II, Class 2
"HA"	Hard Black Anodize per Mil-A-8625 Type III, Class 2
"EN"	Electroless Nickel per Mil-C-26074 Class 4, Grade B, Bright

MOUNTING METHOD TABLE

Code Letter	Method
"H"	Ø1.73/1.85 (.068/.073) dia. through holes countersink 100° x 1.50 (.060) deep
"T0"	0-80 tapped hole
"T2"	2-56 tapped hole
"TM2"	M2 x 0.40 tapped hole
"TM2.5"	M2.5 x 0.45 tapped hole

Calmark offers the Series 264 "Card-Lok" Retainer for cold-plate, heat exchanger applications. This "Card-Lok" configuration offers a larger cross sectional profile for increased clamping force and thermal transfer.

FEATURES

- Maximum uniform clamping force
- Increased thermal transfer
- Maintains wedge and body alignment for easy installation
- Captivated rear wedge
- Choice of screw head style
- Lighter weight
- Lower cost - faster delivery
- Design Flexibility - Special lengths, finishes, or other design options available on request

WEDGES, BODIES & SHAFT

Material:

Aluminum alloy 6061-T6 per ASTM-B221 or AMS-QQ-A-200/8

Finish:

See Part Number Code

SCREW

Material:

NAS1352C, Modified NAS1352C04 or 18-8 stainless steel, Stainless steel per ASTM-A582

Finish:

Passivate per Mil-S-5002

LOCK WASHER

Material:

MS35338-135

Finish:

Passivate per Mil-S-5002

FLAT WASHER

Material:

300 Series Stainless Steel

Finish:

Passivate per Mil-S-5002

ROLL PIN

Material:

400 Series Stainless Steel

Finish:

Passivate per Mil-S-5002

WEIGHT

1.07 g/cm (.096 oz/in)

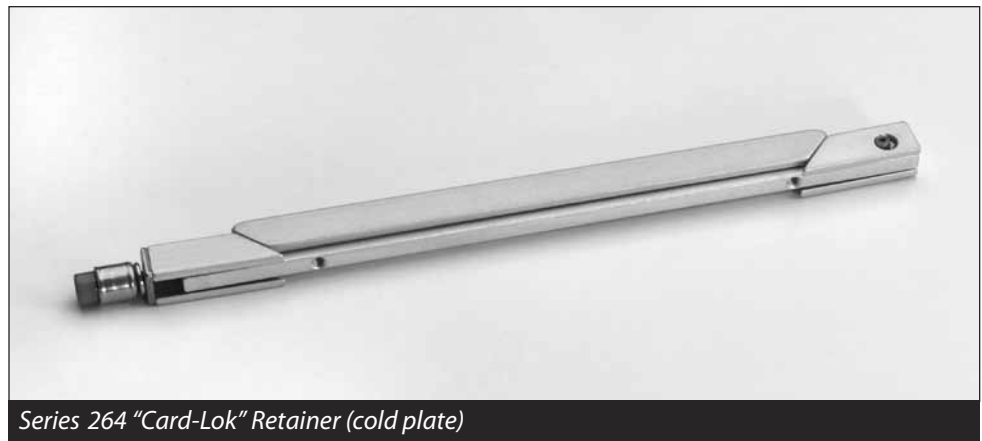

Series 264 "Card-Lok" Retainer (cold plate)

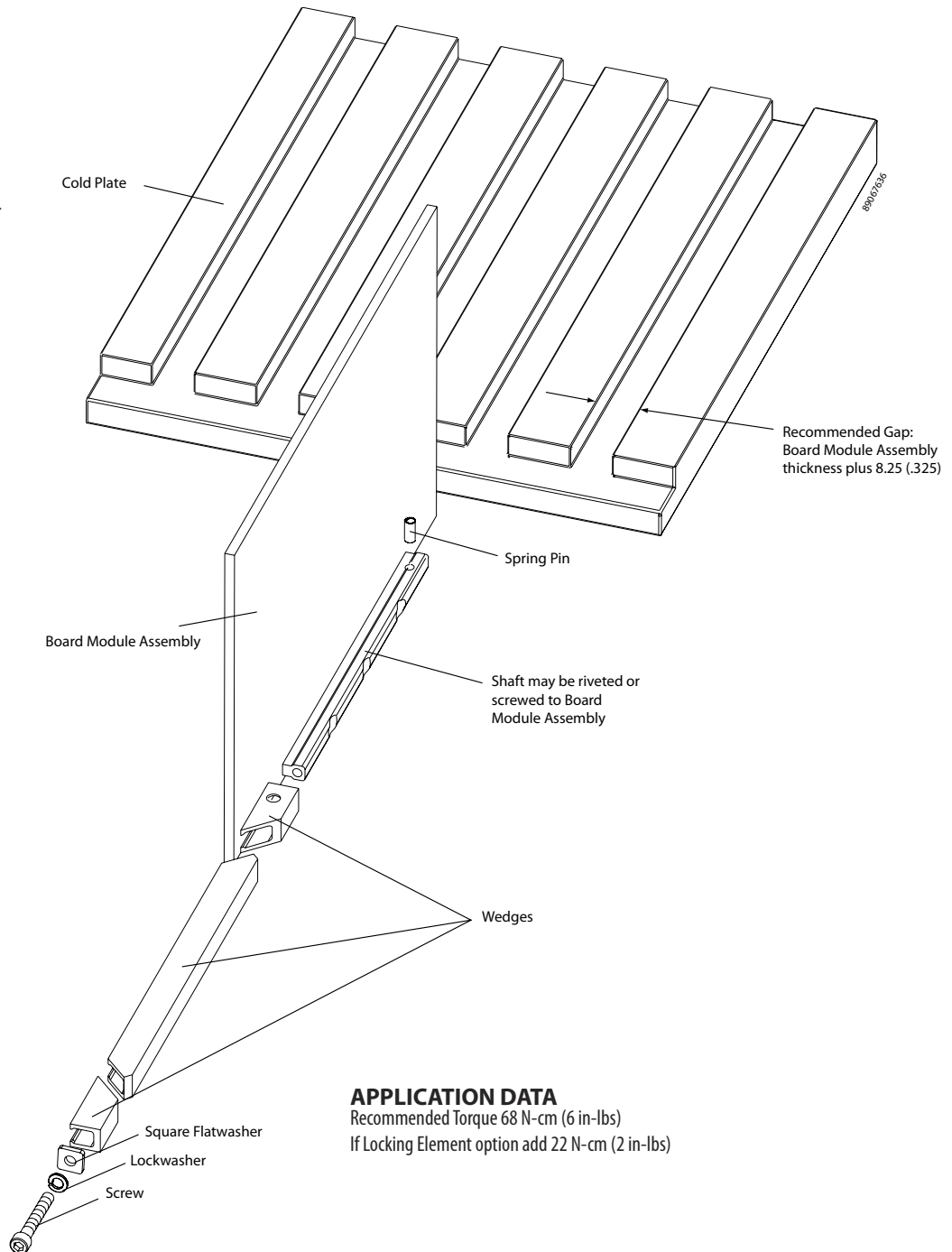

APPLICATION DATA

Recommended Torque 68 N-cm (6 in-lbs)

If Locking Element option add 22 N-cm (2 in-lbs)

OPTION PREFIX

Detail "V"

Provides visual lock indication.

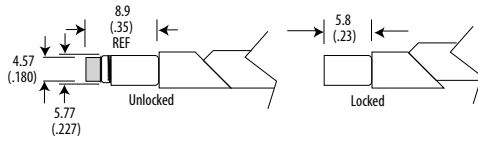

OPTION SUFFIX

Detail "L"

Provides prevailing torque for resistance to loosening from shock and vibration. Adds 22 N-cm (2 in-lbs) torque to assembly. See application data on previous sheet.

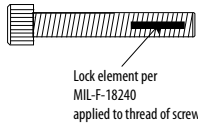

Detail "K"

Prevents the unintentional disassembly of screw from front wedge.

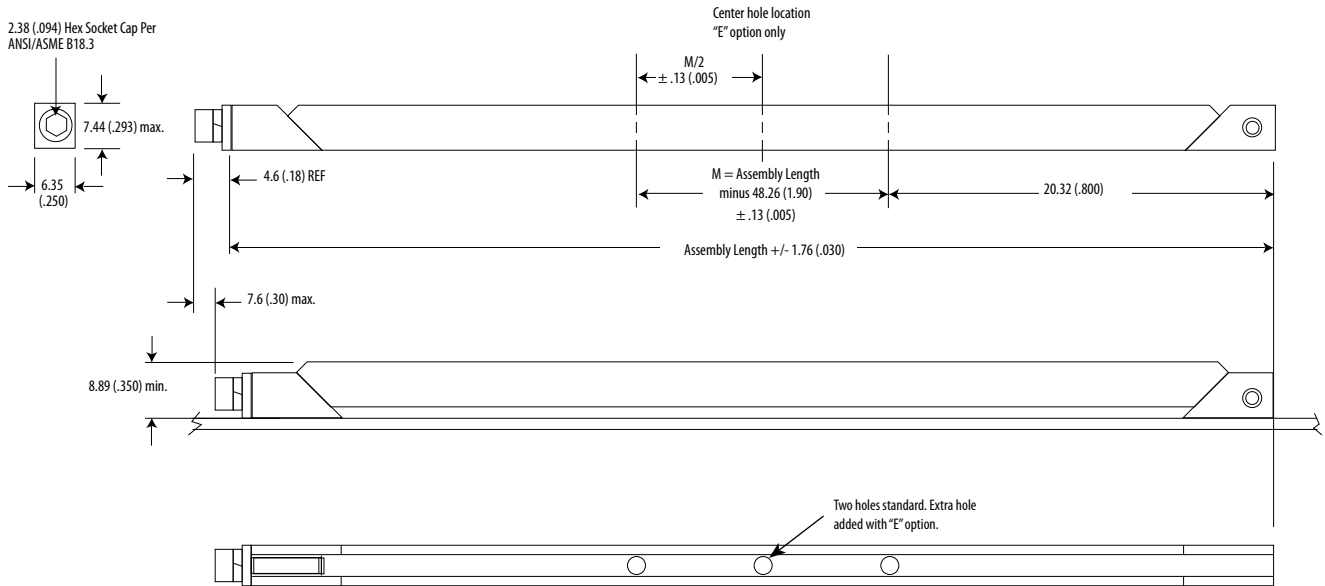
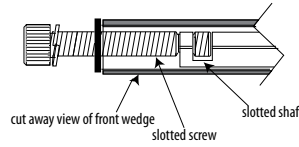

Units: mm (in.)
 Unless otherwise specified:
 .xx ± .25, .x ± .5
 (.xxx ± .010, .xx ± .02)
 Note: Each piece has a tolerance of ± .010

Part Number Code

Series 264 Card-Lok Three Piece

Prefix options

Metric Screw Head M2.5 Hex Drive **M**
 Standard Screw Head 3/32 Hex Drive **[blank]**
 Visual Indicator **V**
 No Visual Indicator **[blank]**
 Black Anodize **A**
 or choose from Finish Table **see table**

Suffix options

Assembly length in inches. Standard lengths range from 71.12 (2.80), 96.52 (3.80) and 121.9 (4.80). **length.xx**
 Other lengths available upon request
 Additional Center Mounting Hole **E**
 None **[blank]**
 Mounting Options - holes for rivet mounting **H**
 or choose from Mounting Option Table **see table**
 Lock Element **L**
 None **[blank]**
 Captive Screw **K**
 None **[blank]**

Part Number Code Example:

M264-2.80T2LK

Series 264 Card-Lok three piece 71.12 (2.80) long with .094-in. hex drive, chemical film finish, 2-56 mounting holes, lock element and captive screw.

FINISH TABLE	
Code Letter	Finish
[blank]	Chemical Film per Mil-DTL-5541 Class 1A, Type 1, Gold
"R"	Chemical Film per Mil-DTL-5541 Class 3, Type II, Clear
"A"	Black Anodize per Mil-A-8625 Type II, Class 2
"HA"	Hard Black Anodize per Mil-A-8625 Type III, Class 2
"EN"	Electroless Nickel per Mil-C-26074 Class 4, Grade B, Bright

MOUNTING METHOD TABLE	
Code Letter	Method
"H"	Ø1.73/1.85 (.068/.073) dia. through holes countersink 100° x 1.52 (.060) deep
"T0"	0-80 tapped hole
"T2"	2-56 tapped hole
"TM2"	M2 x 0.40 tapped hole
"TM2.5"	M2.5 x 0.45 tapped hole

Calmark offers the narrow, advance design Series 265 "Card-Lok" retainer for cold plate/heat exchanger applications. This totally unique design incorporates design advancements that provide increased thermal transfer, easy insertion, lighter weight and now closer center to center board spacing.

FEATURES

- Narrow design permits closer board spacing
- Maximum uniform clamping force
- Increased thermal transfer
- Maintains wedge and body alignment for easy installation
- Captivated rear wedge
- Choice of screw head style
- Lighter weight
- Lower cost - faster delivery
- Design Flexibility - Special lengths, finishes, or other design options available on request

WEDGES, BODIES & SHAFT

Material:

Wedges: Aluminum alloy 6061-T6 per ASTM-B221 or AMS-QQ-A-200/8

Shaft: Aluminum alloy 7075-T6 per ASTM-B221 or AMS-QQ-A-200/11

Finish:

See Finish Table

SCREW, LOCK & FLAT WASHER

Material:

NAS1352C, Modified NAS1352C04 or 18-8 stainless steel, Stainless steel per ASTM-A582

Finish:

Passivate per Mil-S-5002

ROLL PIN

Material:

400 Series Stainless Steel

Finish:

Passivate per Mil-S-5002

WEIGHT

.89 g/cm (.080 oz/in)



Series 265 "Card-Lok" Retainer (cold plate)

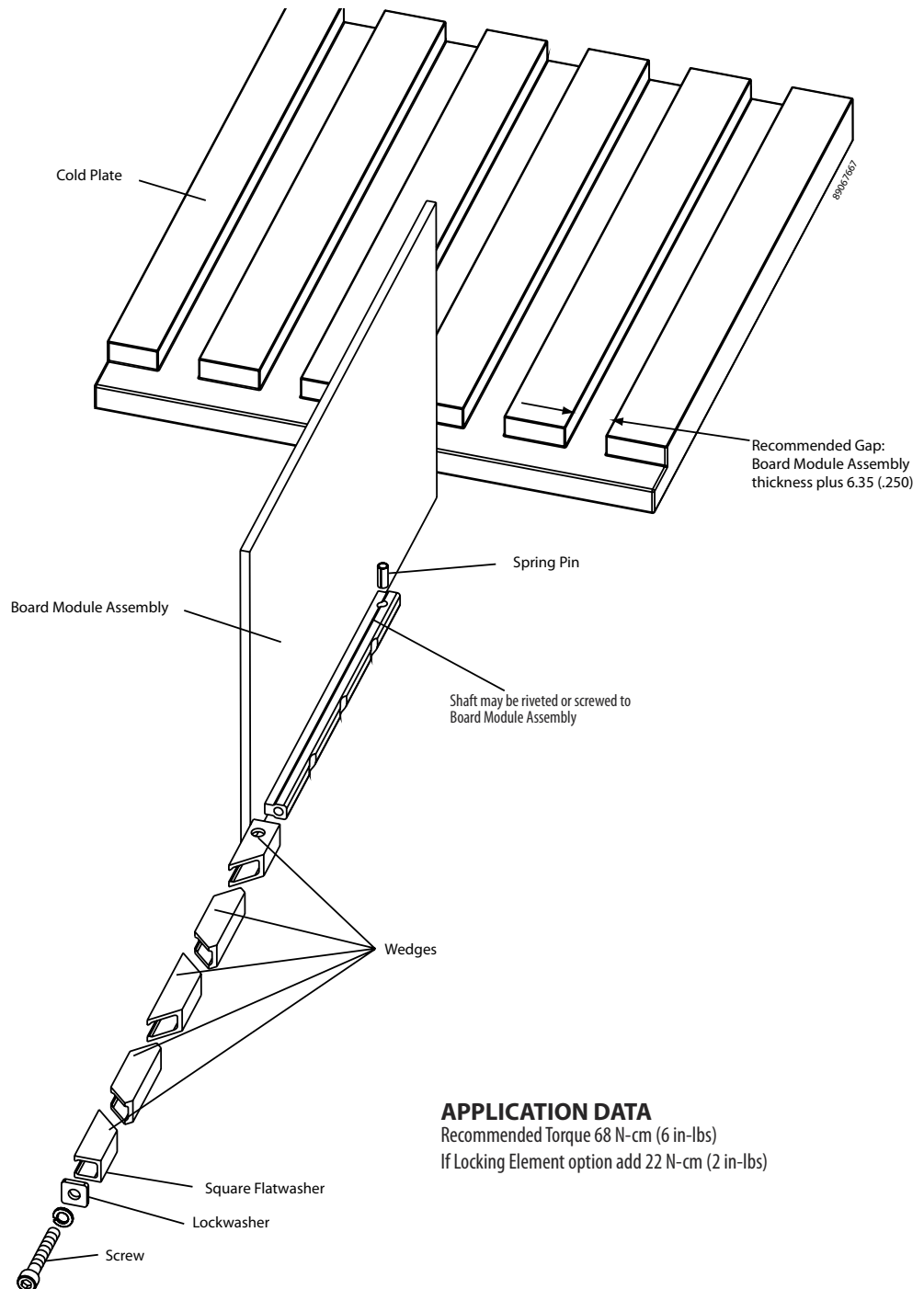

APPLICATION DATA

Recommended Torque 68 N-cm (6 in-lbs)

If Locking Element option add 22 N-cm (2 in-lbs)

OPTION PREFIX

Detail "V"

Provides visual lock indication.

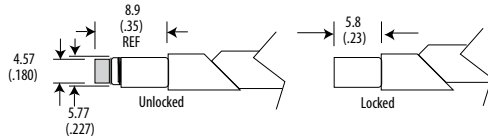

OPTION SUFFIX

Detail "L"

Provides prevailing torque for resistance to loosening from shock and vibration. Adds 22 N-cm (2 in-lbs) torque to assembly. See application data on previous sheet.

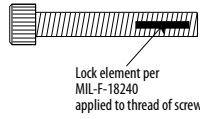

Detail "K"

Prevents the unintentional disassembly of screw from front wedge.

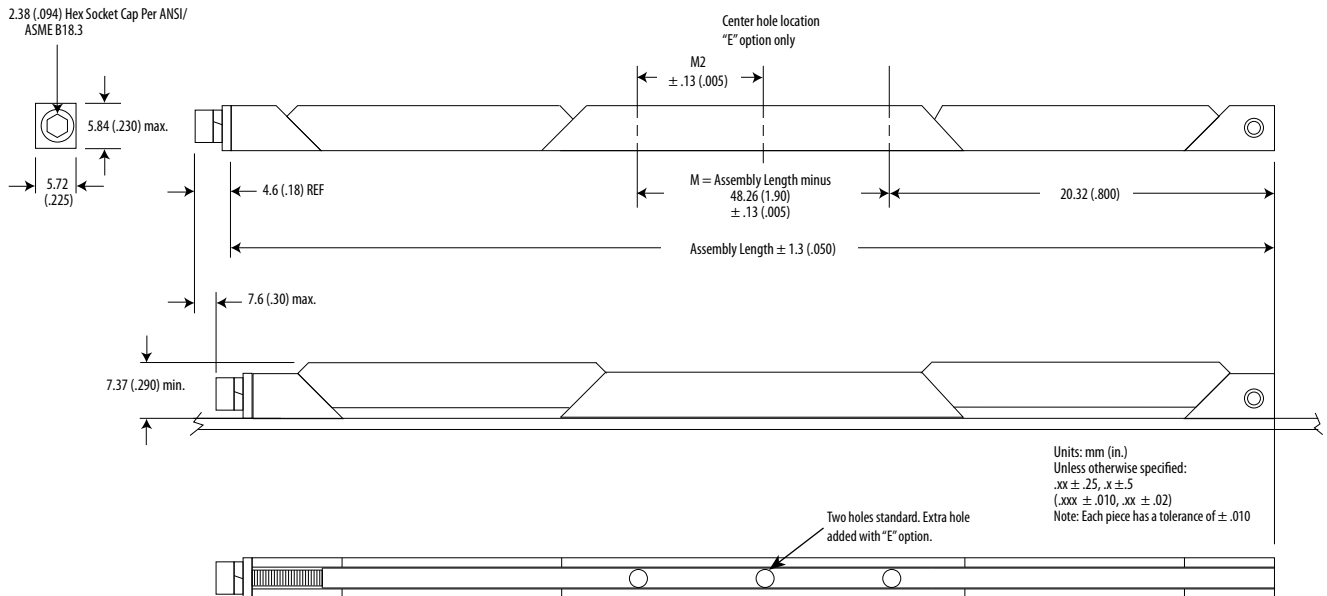
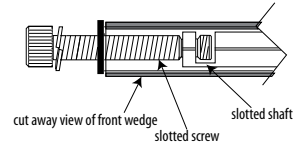

Part Number Code
Series 265 Card-Lok Five Piece

Prefix options

Metric Screw Head M2.5 Hex Drive **M**
Standard Screw Head 3/32 Hex Drive [blank]
Visual Indicator **V**
No Visual Indicator [blank]
Black Anodize **A**
or choose from Finish Table *see table*

Suffix options

Assembly length in inches. Standard lengths range from 71.12 (2.80), 96.52 (3.80) and 121.9 (4.80). **length.xx**
Other lengths available upon request
Additional Center Mounting Hole **E**
None [blank]
Mounting Options - through mounting holes **H**
or choose from Mounting Option Table *see table*
Lock Element **L**
None [blank]
Captive Screw **K**
None [blank]

Part Number Code Example:

M265-4.80H

Series 265 Card-Lok five piece 121.9 (4.80) long with M2.5 hex drive, gold chemical film finish and standard rivet hole mounting

Code Letter	FINISH TABLE
[blank]	Chemical Film per Mil-DTL-5541 Class 1A, Type 1, Gold
"R"	Chemical Film per Mil-DTL-5541 Class 3, Type II, Clear
"A"	Black Anodize per Mil-A-8625 Type II, Class 2
"HA"	Hard Black Anodize per Mil-A-8625 Type III, Class 2
"EN"	Electroless Nickel per Mil-C-26074 Class 4, Grade B, Bright

Code Letter	MOUNTING METHOD TABLE
[blank]	Method
"H"	Ø1.73/1.85 (.068/.073) dia. through holes countersink 100° x 1.52 (.060) deep
"T0"	0-80 tapped hole
"T2"	2-56 tapped hole
"TM2"	M2 x 0.40 tapped hole
"TM2.5"	M2.5 x 0.45 tapped hole

Calmark offers the narrow, advance design Series 266 "Card-Lok" retainer for cold plate/heat exchanger applications. This totally unique design incorporates design advancements that provide increased thermal transfer, easy insertion, lighter weight and now closer center to center board spacing.

FEATURES

- Narrow design permits closer board spacing
- Maximum uniform clamping force
- Increased thermal transfer
- Maintains wedge and body alignment for easy insertion
- Captivated rear wedge
- Choice of screw head style
- Lighter weight
- Lower cost - Faster delivery
- Special lengths, finishes, or other design options available on request

WEDGES, BODIES & SHAFT

Material:

Wedges: Aluminum alloy 6061-T6 per ASTM-B221 or AMS-QQ-A-200/8
 Aluminum alloy 6061-T6 per ASTM-B221 or AMS-QQ-A-200/8
 Shaft: Aluminum alloy 7075-T6 per ASTM-B221 and AMS-QQ-A-200/11

Finish:

See Finish Table

SCREW, LOCK & FLAT WASHER

Material:

NAS1352C, Modified NAS1352C04 or 18-8 stainless steel, Stainless steel per ASTM-A582

Finish:

Passivate per MIL-S-5002

ROLL PIN

Material:

400 Series Stainless Steel

Finish:

Passivate per Mil-S-5002

WEIGHT

.89 g/cm (.080 oz/in)

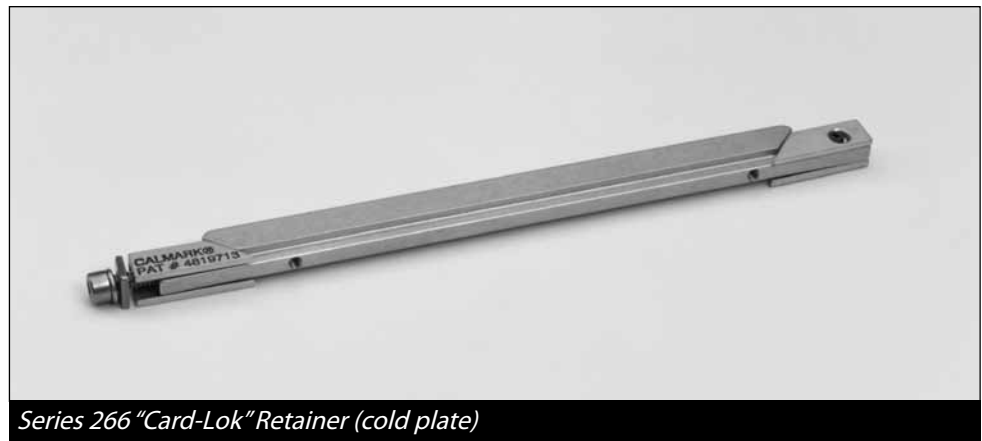

Series 266 "Card-Lok" Retainer (cold plate)

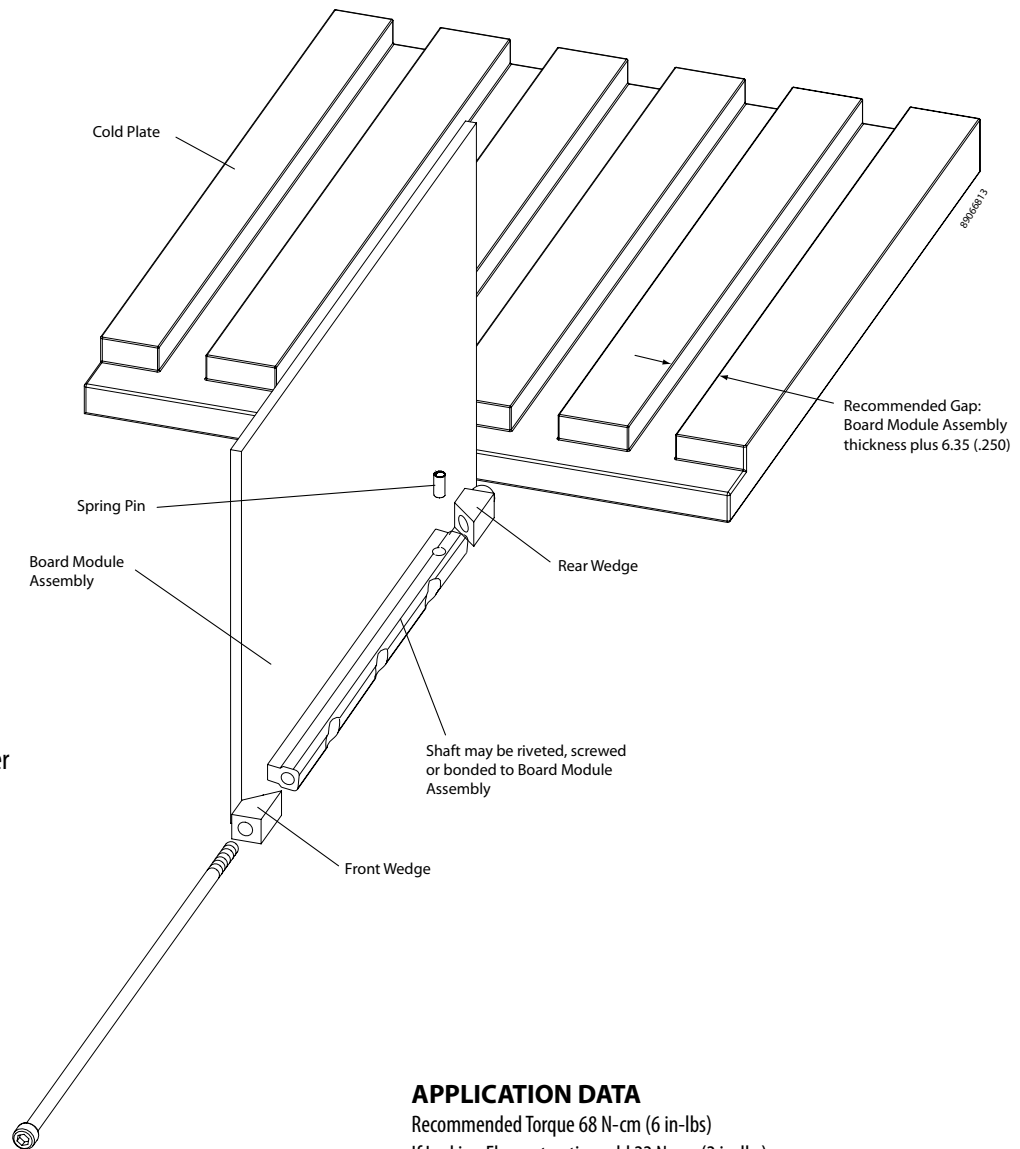

APPLICATION DATA

Recommended Torque 68 N-cm (6 in-lbs)
 If Locking Element option add 22 N-cm (2 in-lbs)

Calmark offers the narrow configuration Series 267 "Card-Lok" Retainer for cold-plate, heat exchanger applications. This design features narrowest cross sectional size in addition to optimum thermal transfer, easy insertion, lighter weight and now closer center to center board spacing.

FEATURES

- Narrow design permits closer board spacing
- Maximum uniform clamping force
- Increased thermal transfer
- Maintains wedge and body alignment for easy insertion
- Captivated rear wedge
- Choice of screw head style
- Lighter weight
- Lower cost - Faster delivery
- Special lengths, finishes, or other design option available on request

WEDGES, BODIES & SHAFT

Material:

Wedges: Aluminum alloy 6061-T6 per ASTM-B221 or AMS-QQ-A-200/8
 Aluminum alloy 6061-T6 per ASTM-B221 or AMS-QQ-A-200/8
 Shaft: Aluminum alloy 7075-T6 per ASTM-B221 and AMS-QQ-A-200/11

Finish:

See Finish Table

SCREW, LOCK & FLAT WASHER

Material:

300 Series Stainless Steel

Finish:

Passivate per Mil-S-5002

ROLL PIN

Material:

400 Series Stainless Steel

Finish:

Passivate per Mil-S-5002

WEIGHT

.75 g/cm (.067 oz/in)

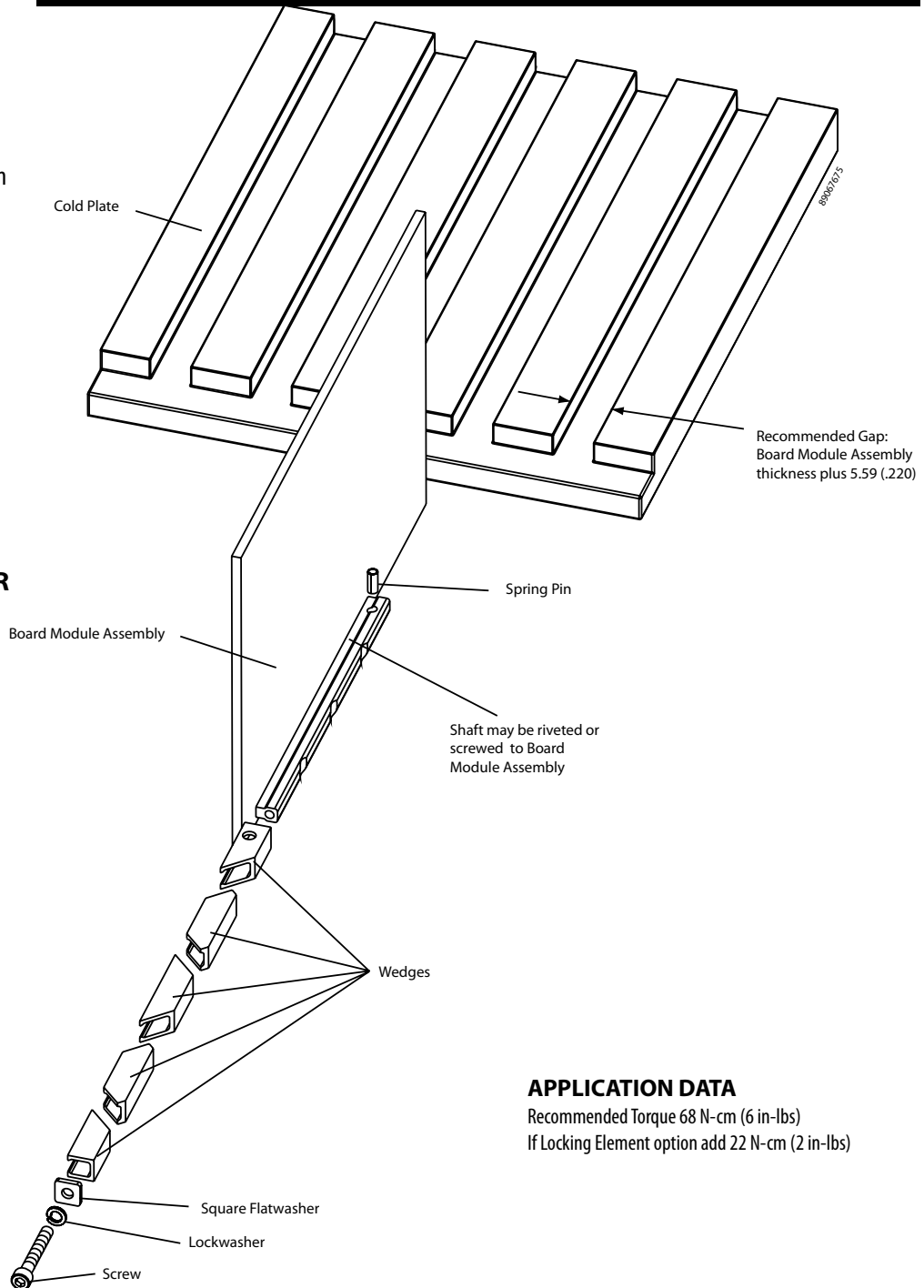
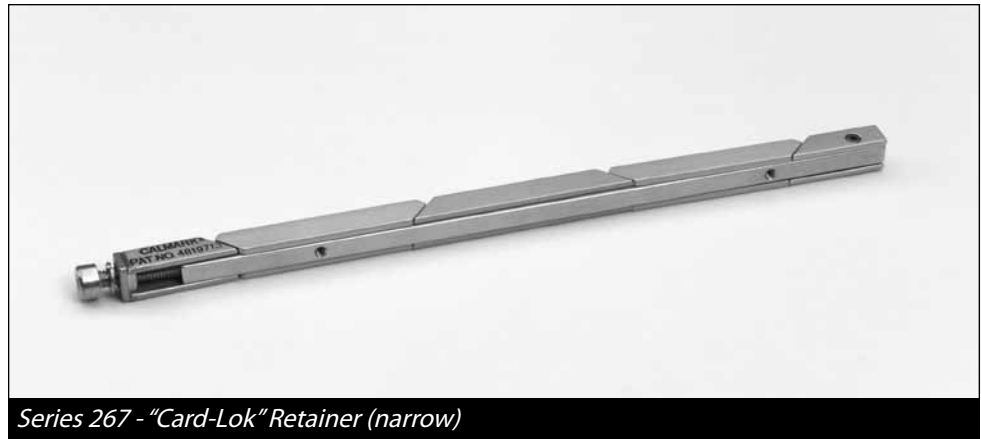

APPLICATION DATA

Recommended Torque 68 N-cm (6 in-lbs)

If Locking Element option add 22 N-cm (2 in-lbs)

OPTION PREFIX

Detail "V"

Provides visual lock indication.

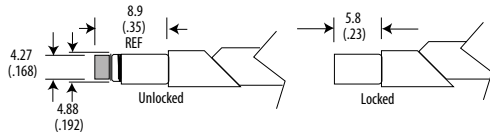

OPTION SUFFIX

Detail "L"

Provides prevailing torque for resistance to loosening from shock and vibration. Adds 22 N-cm (2 in-lbs) torque to assembly. See application data on previous sheet.

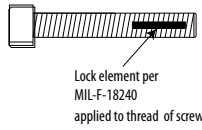

Detail "K"

Prevents the unintentional disassembly of screw from shaft

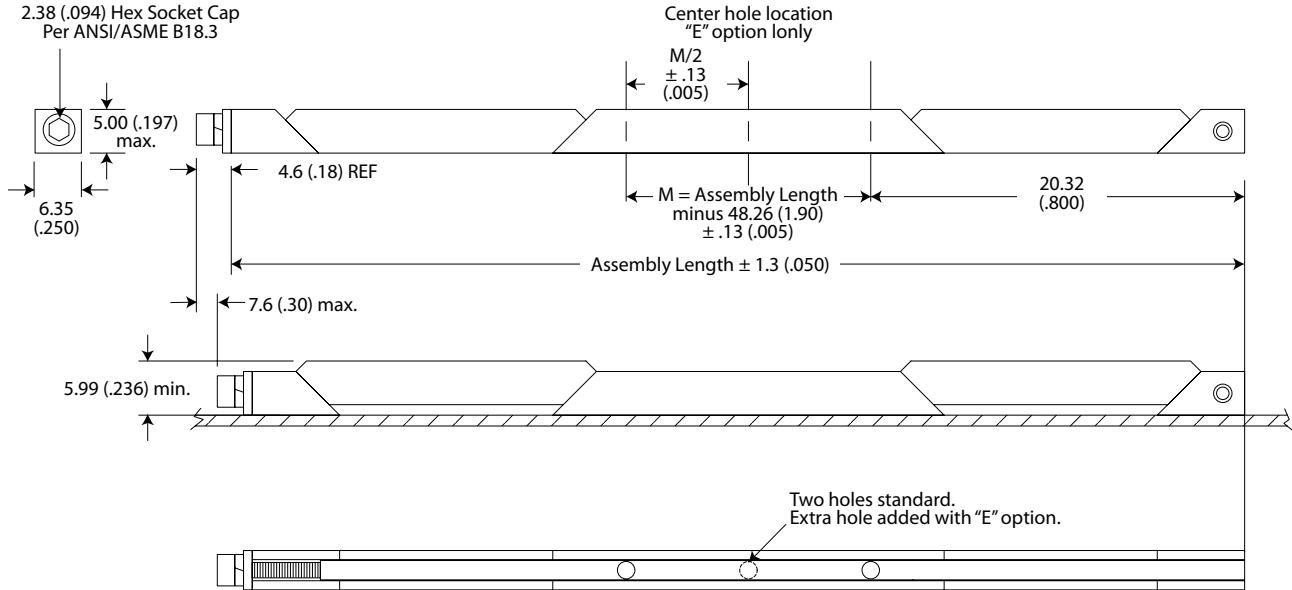
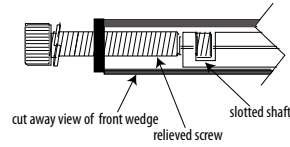

Units: mm (in)
Unless otherwise specified:
.xx ± .25, .x ± .5 (.xxx ± .010, .xx ± .02)
Note: Each piece has a tolerance of ± .010

89067677

Part Number Code Series 267 Card-Lok Five Piece

Prefix options

Metric Screw Head M2.5 Hex Drive **M**
Standard Screw Head 3/32 Hex Drive [blank]
Visual Indicator **V**
No Visual Indicator [blank]
Black Anodize **A**
or choose from Finish Table see table

Suffix options

Assembly length in inches. Standard lengths range from 71.12 (2.80), 96.52 (3.80) and 121.9 (4.80). length.xx
Other lengths available upon request.
Additional Center Mounting Hole **E**
None [blank]
Mounting Options - holes for rivet mounting or choose from Mounting Option Table see table
Lock Element **L**
None [blank]
Captive Screw **K**
None [blank]

Part Number Code Example:

267-2.80T2K Series 267 five piece Card-Lok gold chemical film finish, 71.12 (2.80) long with 2-56 tapped mounting holes and captive screw feature

FINISH TABLE

Code Letter	Finish
[blank]	Chemical Film per Mil-DTL-5541 Class 1A, Type 1, Gold
"R"	Chemical Film per Mil-DTL-5541 Class 3, Type II, Clear
"A"	Black Anodize per Mil-A-8625 Type II, Class 2
"HA"	Hard Black Anodize per Mil-A-8625 Type III, Class 2
"EN"	Electroless Nickel per Mil-C-26074 Class 4, Grade B, Bright

MOUNTING METHOD TABLE

Code Letter	Method
"H"	Ø1.73/1.85 (.068/.073) dia. through holes countersink 100° x 1.52 (.060) deep
"T0"	0-80 tapped hole
"T2"	2-56 tapped hole
"TM2"	M2 x 0.40 tapped hole
"TM2.5"	M2.5 x 0.45 tapped hole

Calmark offers the advance design Series 280 "Card-Lok" Retainer for cold plate-heat exchanger applications. This totally unique design incorporates design advancements that provide increased thermal transfer, easy insertion, lighter weight and lower cost. The Series 280 specifically provides greater clamping force and load capacity for Board Module Assembly of higher weight and mass.

FEATURES

- Greater clamping force and load capacity for Board Module Assembly with higher weight and mass
- Maximum uniform clamping force
- Increased thermal transfer
- Maintains wedge and body alignment for easy insertion
- Captive rear wedge
- Choice of screw head style
- Dimensionally compatible with Series 250
- Lighter weight
- Lower cost
- Special lengths, finishes, or other design options available on request

WEDGES, BODIES & SHAFT

Material:

Wedges: Aluminum alloy 6061-T6 per ASTM-B221 or AMS-QQ-A-200/8
 Aluminum alloy 6061-T6 per ASTM-B221 or AMS-QQ-A-200/8
 Shaft: Aluminum alloy 7075-T6 per ASTM-B221 and AMS-QQ-A-200/11

Finish:

See Finish Table

SCREW, LOCK & FLAT WASHER

Material:

300 Series Stainless Steel

Finish:

Passivate per Mil-S-5002

ROLL PIN

Material:

400 Series Stainless Steel

Finish:

Passivate per Mil-S-5002

WEIGHT

2.18 g/cm (.195 oz/in)



Series 280 - "Card-Lok" Retainer (Cold Plate)

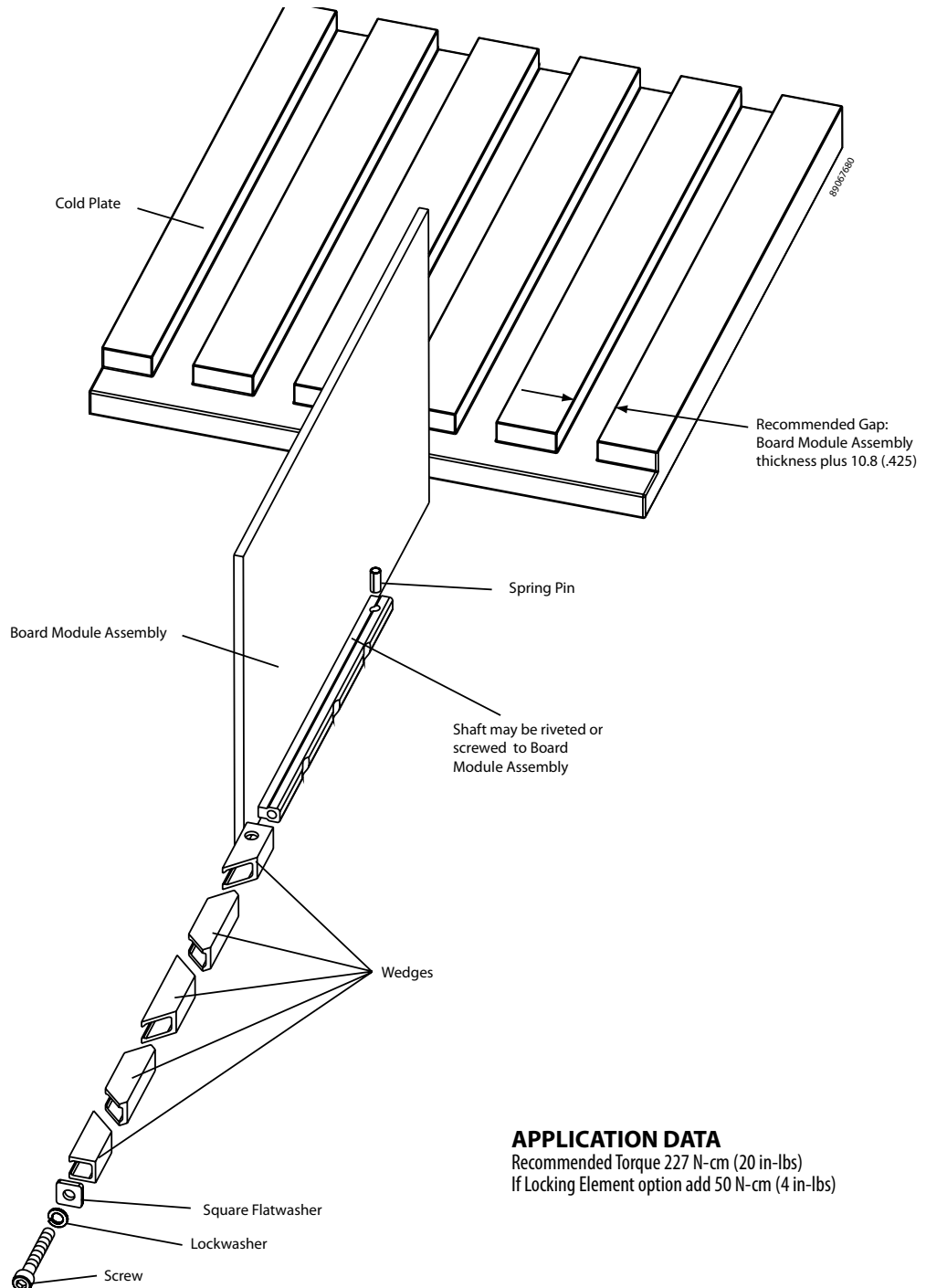

APPLICATION DATA

Recommended Torque 227 N-cm (20 in-lbs)
 If Locking Element option add 50 N-cm (4 in-lbs)

Calmark offers the advance design Series 281 "Card-Lok" Retainer for cold plate-heat exchanger applications. This totally unique design incorporates design advancements that provide increased thermal transfer, easy insertion, lighter weight and lower cost. The Series 281 specifically provides greater clamping force and load capacity for Board Module Assembly of higher weight and mass.

FEATURES

- Greater clamping force and load capacity for Board Module Assembly with higher weight and mass
- Maximum uniform clamping force
- Increased thermal transfer
- Maintains wedge and body alignment for easy insertion
- Captive rear wedge
- Choice of screw head style
- Dimensionally compatible with Series 250
- Lighter weight
- Lower cost
- Special lengths, finishes, or other design options available on request

WEDGES, BODIES & SHAFT

Material:

Wedges: Aluminum alloy 6061-T6 per ASTM-B221 or AMS-QQ-A-200/8
 Aluminum alloy 6061-T6 per ASTM-B221 or AMS-QQ-A-200/8
 Shaft: Aluminum alloy 7075-T6 per ASTM-B221 and AMS-QQ-A-200/11

Finish:

See Finish Table

SCREW, LOCK & FLAT WASHER

Material:

300 Series Stainless Steel

Finish:

Passivate per Mil-S-5002

ROLL PIN

Material:

400 Series Stainless Steel

Finish:

Passivate per Mil-S-5002

WEIGHT

2.18 g/cm (.195 oz/in)

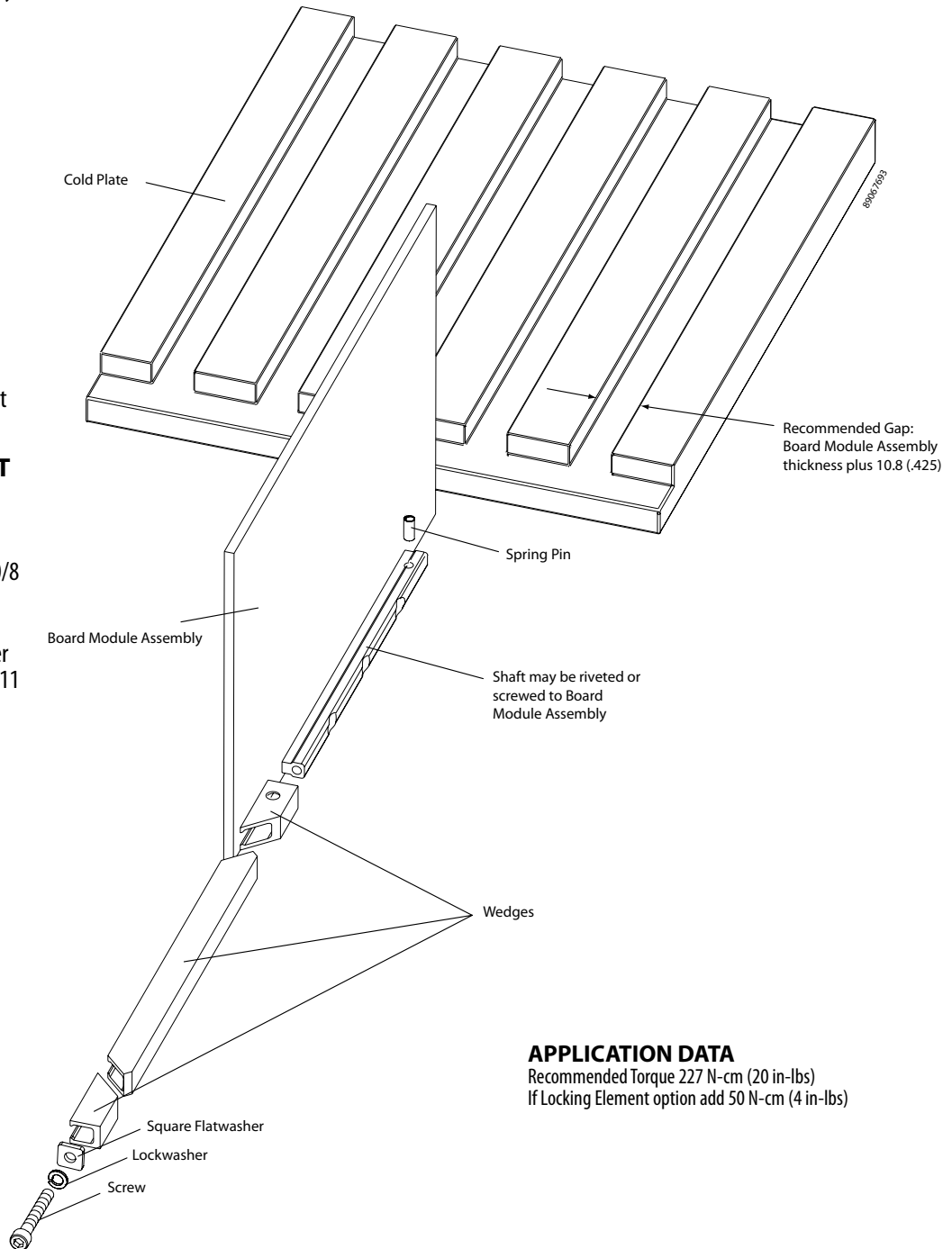
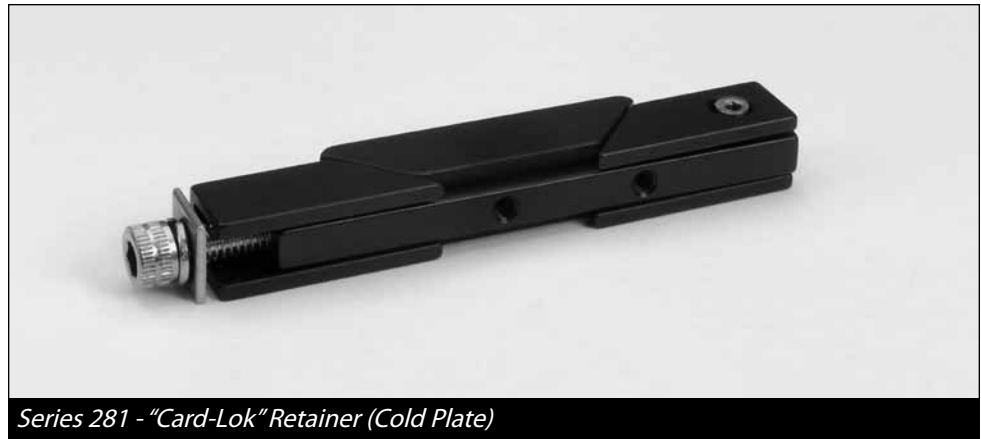

APPLICATION DATA

Recommended Torque 227 N-cm (20 in-lbs)
 If Locking Element option add 50 N-cm (4 in-lbs)

OPTION PREFIX

Detail "V"

Provides visual lock indication.

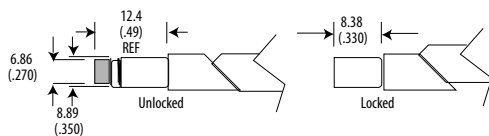

OPTION SUFFIX

Detail "L"

Provides prevailing torque for resistance to loosening from shock and vibration. Adds 50 N-cm (4 in-lbs) torque to assembly. See application data on previous sheet.

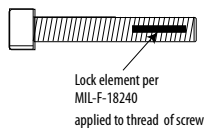

Detail "K"

Prevents the unintentional disassembly of screw from shaft.

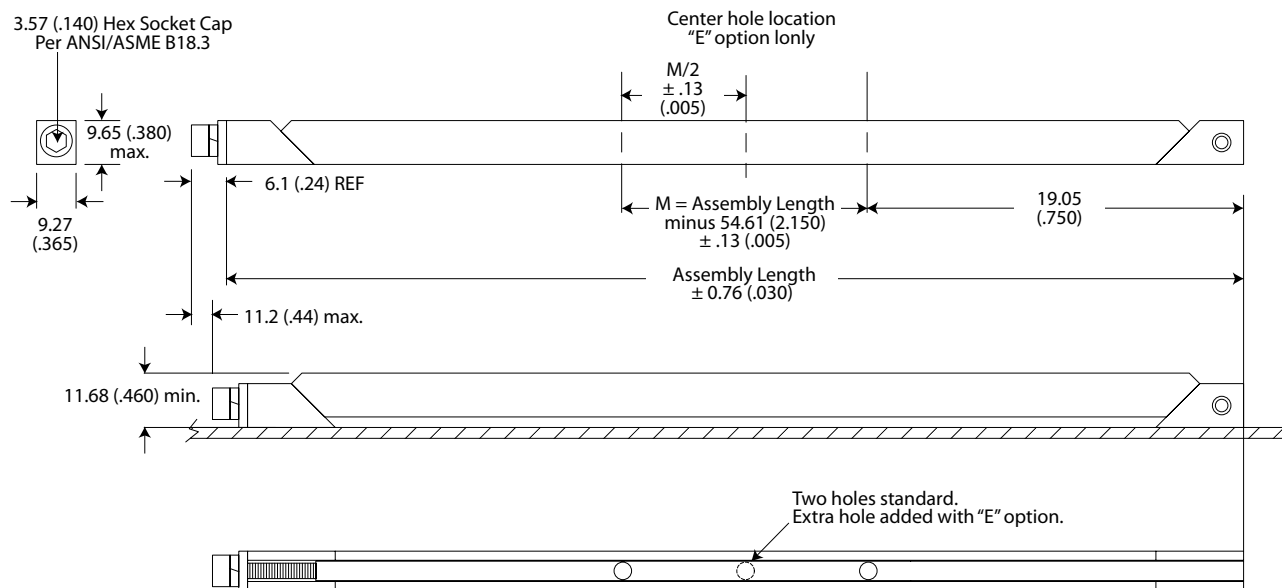
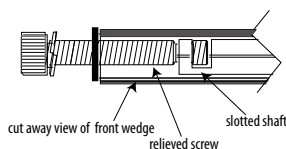

Units: mm (in)
 Unless otherwise specified:
 .xx ± .25, .x ± .5 (.xxx ± .010, .xx ± .02)
 Note: Each piece has a tolerance of ± .010

89067695

Part Number Code Series 281 Card-Lok Three Piece

Prefix options

Metric Screw Head M3 Hex Drive M
 Standard Screw Head 9/64 Hex Drive [blank]
 Visual Indicator V
 No Visual Indicator [blank]
 Black Anodize A
 or choose from Finish Table see table

Suffix options

Assembly length in inches. Standard lengths range from 71.12 (2.80), 96.52 (3.80) and 121.9 (4.80) length.xx
 Other lengths available upon request.
 Additional Center Mounting Hole E
 None [blank]
 Mounting Options - holes for rivet mounting H
 or choose from Mounting Option Table see table
 Lock Element L
 None [blank]
 Captive Screw K
 None [blank]

Part Number Code Example:

281-2.80H

Series 281 Card-Lok three piece 71.12 (2.80) long with chemical film finish and standard rivet mounting hole

Code

Letter Finish

FINISH TABLE

[blank] Chemical Film per Mil-DTL-5541 Class 1A, Type 1, Gold
 "R" Chemical Film per Mil-DTL-5541 Class 3, Type II, Clear
 "A" Black Anodize per Mil-A-8625 Type II, Class 2
 "HA" Hard Black Anodize per Mil-A-8625 Type III, Class 2
 "EN" Electroless Nickel per Mil-C-26074 Class 4, Grade B, Bright

MOUNTING METHOD TABLE

Code

Letter Method

"H" Ø3.40/3.53 (.0134/.139) dia. through holes countersink 60° x 3.81 (.150) deep
 "T4" 4-40 tapped hole
 "TM3" M3 x 0.50 tapped hole

Calmark offers the Series 227 and 228 Channel Mounted "Card-Lok". This design consists of three or five segment Card-Lok retainer mounted in its own individual chassis mountable heatsink channel.

FEATURES

- Self contained Card-Lok/Heatsink Channel – Three or five segment Card-Lok mounted in an individually mountable heatsink channel
- Maximum Reliability – Screw-actuated wedge action locks Plug-in Unit in place
- Maximum Thermal Transfer – Wedge action design provides maximum contact between thermal paths on Plug-in Unit and the heat sinking surface
- Maximum Resistance to Shock & Vibration – Wedge action design locks Plug-in Unit in place to provide maximum resistance to shock and vibration
- Zero Insertion & Extraction Forces – Screw actuation provides zero insertion and extraction force on Plug-in Unit
- Design Flexibility – Special lengths, finishes or other design variations available on request

MATERIALS

CHANNEL, BODIES & WEDGES

Material:

Aluminum alloy 6061-T6 per ASTM-B221 or AMS-QQ-A-200/8

Finish:

See Finish Table

SCREW

Material:

Stainless Steel per ASTM-A582

Finish:

Passivated per Mil-S-5002

FLAT WASHERS, RETAINING RING & SPRING

Passivated Stainless Steel

WEIGHT

2.44g/cm (0.22 oz/in)



Series 227 - "Channel-Lok" Retainer (cold plate)



Series 228 - "Channel-Lok" Retainer (cold plate)

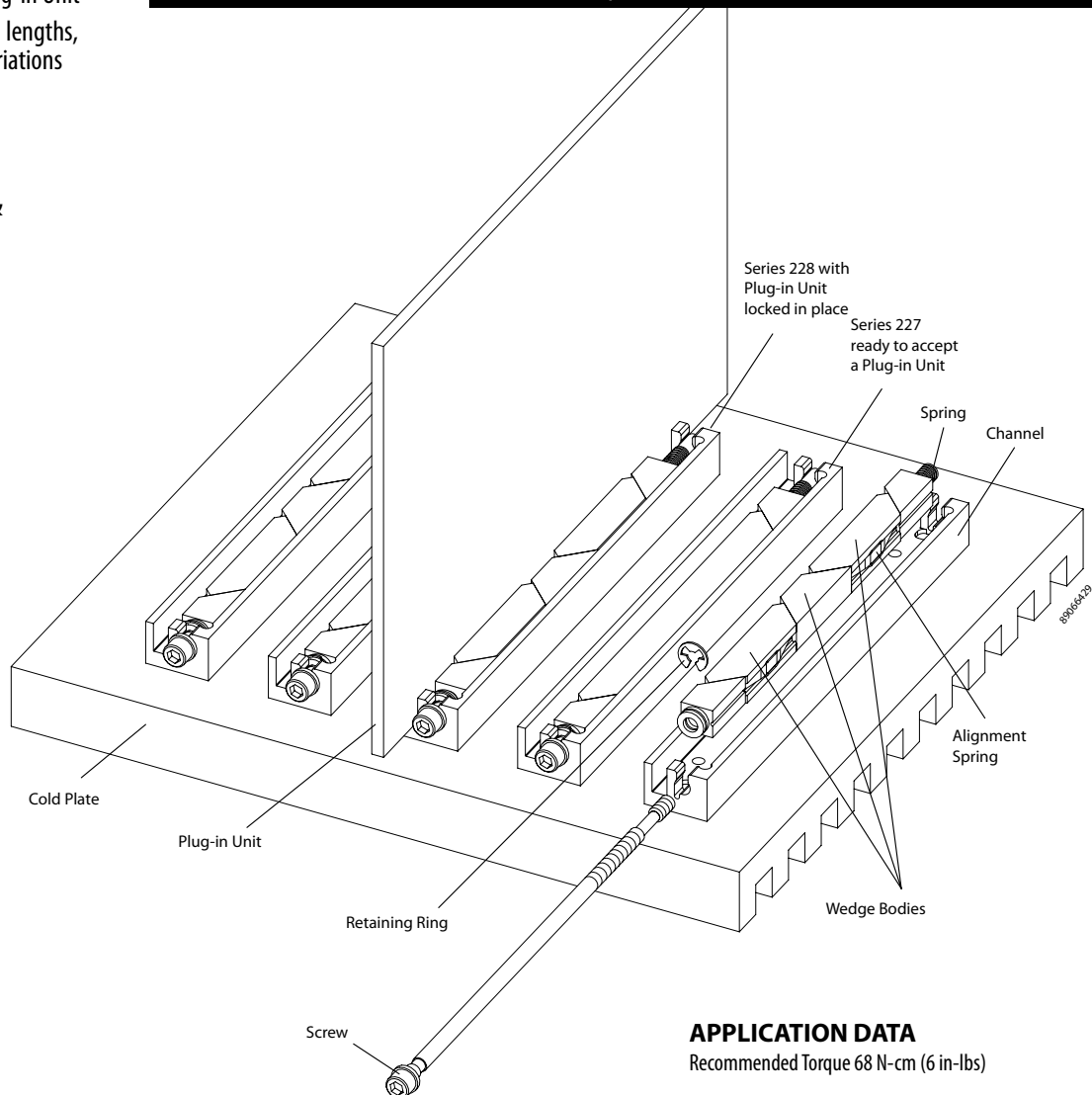

APPLICATION DATA

Recommended Torque 68 N-cm (6 in-lbs)

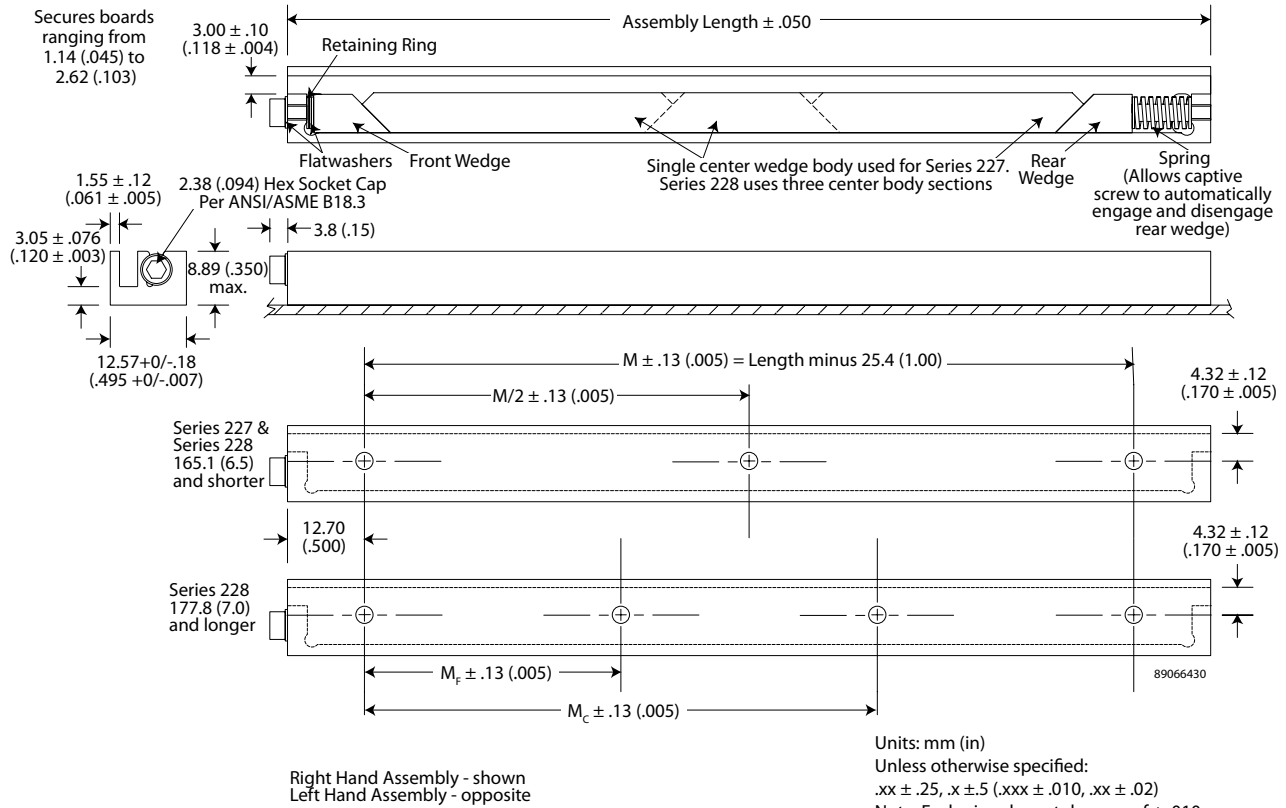

Series 227								
Length	76.2 (3.00)	88.9 (3.50)	101.6 (4.00)	114.3 (4.50)	127.0 (5.00)	139.7 (5.50)	152.4 (6.00)	165.1 (6.50)
MF	25.4 (1.000)	31.75 (1.250)	38.10 (1.500)	127.00 (1.750)	50.80 (2.000)	57.15 (2.250)	63.50 (2.500)	69.85 (2.750)
MC	50.80 (2.000)	63.50 (2.500)	76.20 (3.000)	88.90 (3.500)	101.60 (4.000)	114.30 (4.500)	127.00 (5.000)	139.70 (5.500)

Series 228												
Length	114.3 (4.50)	127.0 (5.00)	139.7 (5.50)	152.4 (6.00)	165.1 (6.50)	177.8 (7.00)	190.5 (7.50)	203.2 (8.00)	215.9 (8.50)	228.6 (9.00)	241.3 (9.50)	254.0 (10.00)
MF	44.45 (1.750)	50.80 (2.000)	57.15 (2.250)	63.50 (2.500)	69.85 (2.750)	50.80 (2.000)	57.15 (2.250)	57.15 (2.250)	63.50 (2.500)	63.50 (2.500)	69.85 (2.750)	76.20 (3.000)
MC	N/A	N/A	N/A	N/A	N/A	101.60 (4.000)	107.95 (4.250)	120.65 (4.750)	127.00 (5.000)	139.70 (5.500)	146.05 (5.750)	152.40 (6.000)
Length	266.7 (10.50)	279.4 (11.00)	304.8 (11.50)	317.5 (12.00)	330.2 (12.50)	342.9 (13.00)	355.6 (13.50)	368.3 (14.00)	368.3 (14.50)	381.0 (15.00)	393.7 (15.50)	406.4 (16.00)
MF	82.55 (3.250)	88.90 (3.500)	95.25 (3.750)	101.60 (4.000)	107.95 (4.250)	114.30 (4.500)	120.65 (4.750)	127.00 (5.000)	133.35 (5.250)	139.70 (5.500)	146.05 (5.750)	152.40 (6.000)
MC	158.75 (6.250)	165.10 (6.500)	171.45 (6.750)	177.80 (7.000)	184.15 (7.250)	190.50 (7.500)	196.85 (7.750)	203.20 (8.000)	209.55 (8.250)	215.90 (8.500)	222.25 (8.750)	228.60 (9.000)

Part Number Code
Series 227 Card-Lok Three Piece
Series 228 Card-Lok Five Piece

M A 228 R - 5.00 T4

Prefix options
 Metric Screw Head M2.5 Hex Drive **M**
 Standard Screw Head 3/32 Hex Drive **[blank]**
 Black Anodize **A**
 or choose from Finish Table **see table**

Suffix options
 Right or **R**
 Left **L**
 Series 227
 Standard lengths from 76.2 (3.00) to 165.1 (6.50)
 in 12.7 (.500) increments
 Series 228
 Standard lengths from 101.5 (4.00) to 406.4 (16.00)
 in 12.7 (.500) increments **length.xx**

Mounting Options
 4-40 tapped mounting holes **T4**
 M3 tapped mounting holes **TM3**

Part Number Code Example:
 227R-6.50T4
 Series 227 Channel-Lok three piece 165.1 (6.50) long with chemical film finish and 4-40 tapped mounting holes; this assembly is for the right side
 A228L-9.50TM3
 Series 228 Channel-Lok five piece 241.3 (9.50) long with black anodize finish and M3 tapped holes; this assembly is for the left side

FINISH TABLE

Code Letter	Finish
[blank]	Chemical Film per Mil-DTL-5541 Class 1A, Type 1, Gold
"R"	Chemical Film per Mil-DTL-5541 Class 3, Type II, Clear
"A"	Black Anodize per Mil-A-8625 Type II, Class 2
"HA"	Hard Black Anodize per Mil-A-8625 Type III, Class 2
"EN"	Electroless Nickel per Mil-C-26074 Class 4, Grade B, Bright

Calmark offers the Series 125/126 Card Retainer as the economical approach to protecting your Printed Circuit Board in shock and vibration applications. For those applications that require shock and vibration protection and heat sinking and grounding, the Series 165/166 may be the answer to your problem. The Series 125/126 is made from rugged stainless steel while the Series 165/166 is made from Alloy 10 BeCu for exceptional thermal and electrical conductivity. These Retainers conform to DSCC 85034.

125/126 Material:

.41 (.016) thick Stainless Steel Type 301, Cond. 1/2 H, ASTM -A240

Finish:

Passivate per MIL -S-5002

SPRING RATE

60.4N/cm (34.5lbs/in) of deflection per spring finger

WEIGHT

.4g/cm (.036oz/inch)

165/166 Material:

.41 (.016) thick Alloy 10 Beryllium Copper. Cond. "AT" per Mil-C-81021

Finish:

See Part No. Code

SPRING RATE

56.0 N/cm (32 lbs/in) of deflection per spring finger

WEIGHT

.48g/cm (.043oz/in)



Series 125/126/165/166 retainers

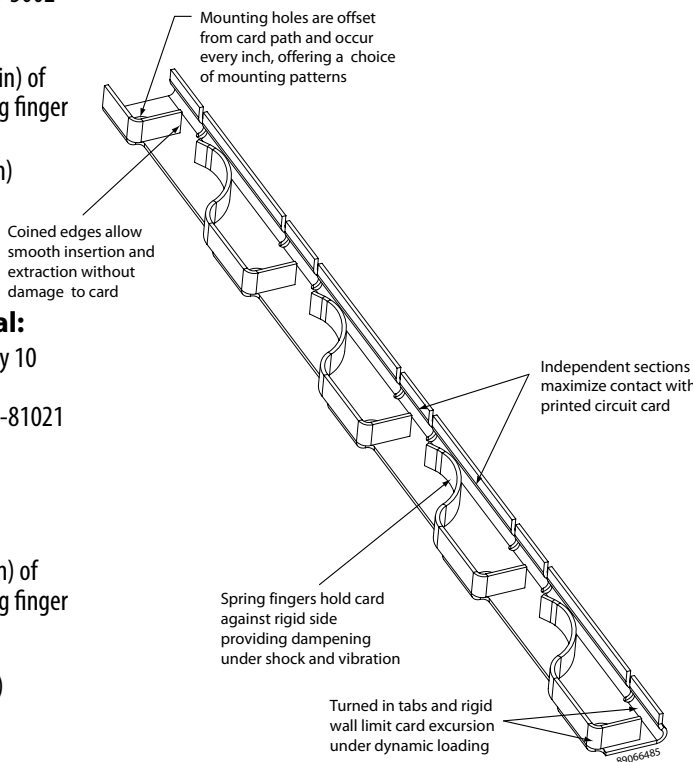

Part Number Code

Series

125, 126, 165, 166

PCB Thickness

125 06 09 3.25 N
 1.6 (.063) 06
 2.4 (.094) 09

Length

31.75 (1.25) to 311.15 (12.25) length.xx
 in 25.4 (1.00) increments
 Other lengths available on request

Finish (165/166 only)

Nickel plate N
 or choose from Finish Table

Part Number Code Example:

125-06-4.25

Series 125 passivated stainless steel, 107.95 (4.25) long designed for 1.6 (.063) thick printed circuit boards

FINISH TABLE

Code

Letter Finish

[blank] 125/126: passivated
 165/166: no finish

For 165/166 only

"T" Bright Tin plate per Mil-T-10727 .005 (.0002) min.

"N" Nickel plate per QQ-N-290 Cl. 1, Gr. F

"ZN" Zinc plate per ASTM-B633 Type III (clear), SC1

"EN" Electroless nickel plate per Mil-C-26074 Cl. 1 Gr. B

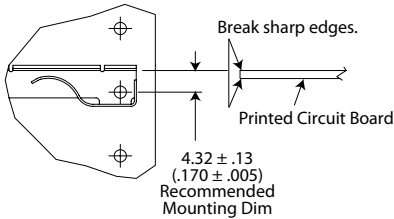

Dash No.	PCB Thickness	B Dimension +0.38 (.015) \-0.0 (.000)	G Dimension +0.0 (.00) \-0.80 (.03)
-06	1.6 (1/16)	1.91 (.075)	1.14 (.045)
-09	2.4 (3/32)	2.67 (.105)	1.91 (.075)

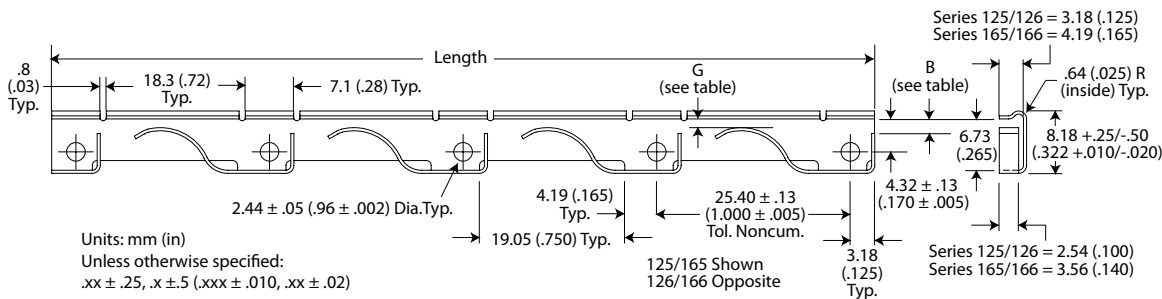

Units: mm (in)
 Unless otherwise specified:
 .xx ± .25, .x ± .5 (.xxx ± .010, .xx ± .02)

125/165 Shown
 126/166 Opposite



Series NW125/NW126/NW165/NW166 retainers

Part Number Code	
Series	
NW125, NW126, NW165, NW166	
	NW125 -06 -3.25 N
PCB Thickness	
1.6 (.063)	06
2.4 (.094)	09
Length	
31.75 (1.25) to 311.15 (12.25)	length.xx
in 25.4 (1.00) increments. Other lengths available on request	
Finish (NW165/NW166 only)	
Nickel plate	N
or choose from Finish Table	

FINISH TABLE

Code	Finish
Letter	Finish
[blank]	NW125/NW126: passivated NW165/NW166: no finish

For NW165/NW166 only

- "T" Bright Tin plate per Mil-T-10727
.005 (.0002) min.
- "N" Nickel plate per QQ-N-290 Cl. 1, Gr. F
- "ZN" Zinc plate per ASTM-B633 Type III (clear), SC1
- "EN" Electroless nickel plate per Mil-C-26074 Cl. 1 Gr. B

Spring fingers hold printed circuit board against rigid side for thermal and electrical contact. It also provides dampening under shock and vibration.

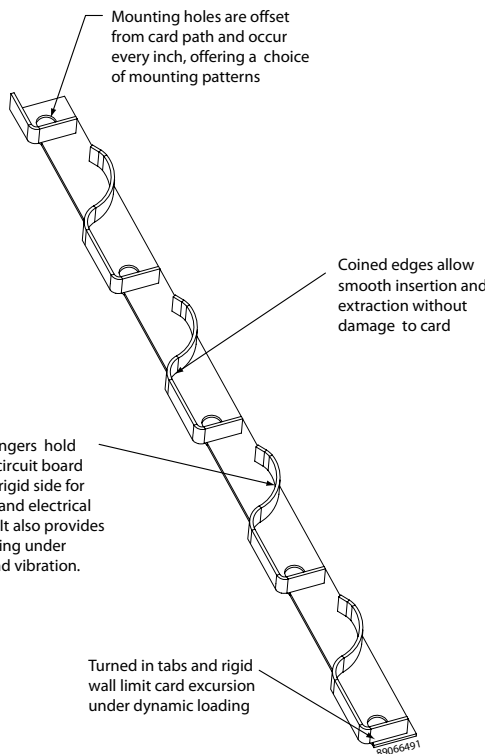

Calmark offers the Series NW125/NW126 and NW165/NW166 Card Retainers for cold plate heat exchanger applications. These Retainers provide the necessary spring pressure to insure positive contact between the thermal path on the Printed Circuit Board and the cold plate surface. The NW165/NW166 provides the additional benefit of improved thermal characteristics. These retainers conform to the DSCC 85034 specification.

NW125/126

Material:

0.41 (.016) thick Stainless Steel
Type 301, Cond. 1/2 H, ASTM -A240

Finish:

Passivate per MIL -S-5002

WEIGHT

.32 g/cm (.029 oz/inch)

SPRING RATE

60.4 N/cm (34.5 lbs/in) of deflection per spring finger

NW165/NW166

Material:

0.41 (.016) thick Alloy 10 Beryllium Copper
Cond. "AT" per Mil-C-81021

Finish:

See Part No. Code

SPRING RATE

56.0 N/cm (32 lbs/in) of deflection per spring finger

WEIGHT

.38 g/cm (.034 oz/in)

Part Number Code Example:

NW165-09-4.25EN

Series NW165 BeCu with Electroless Nickel finish, 107.95 (4.25) long designed for 2.4 (.094) thick printed circuit boards

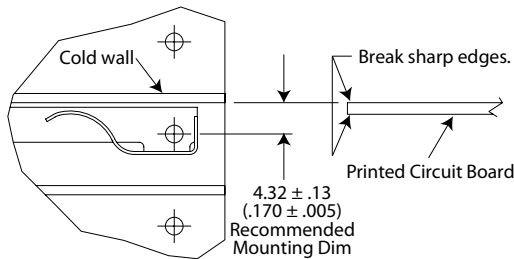

Dash No.	PCB Thickness	B Dimension +0.38 (.015) \-0.0 (.000)	G Dimension +0.0 (.00) \-0.80 (.03)
-06	1.6 (1/16)	2.41 (.095)	3.94 (.155)
-09	2.4 (3/32)	1.65 (.065)	3.18 (.125)

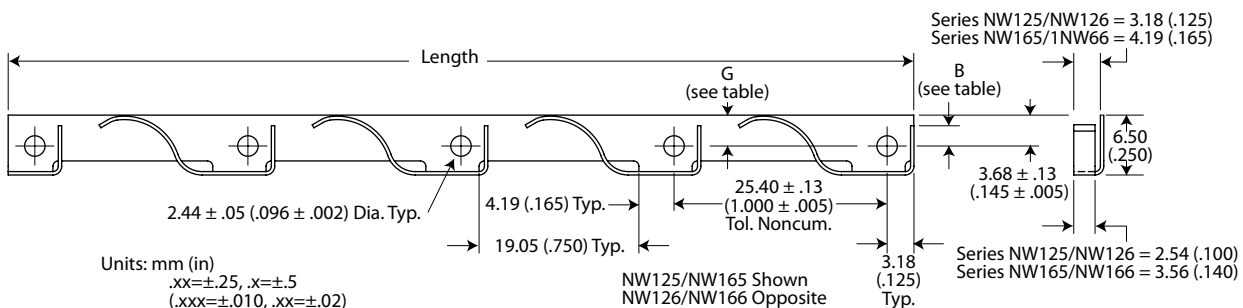

Units: mm (in)
.xx=±.25, .x=±.5
(.xxx=±.010, .xx=±.02)

NW125/NW165 Shown
NW126/NW166 Opposite

89066492

Calmark offers the Series 115-287 Card Guide, a most unique design in PC card guides. The Series 115-287 Card Guide allows users of louver or lance type card guides to easily change to an insulated nylon card guide with a minimum modification of strength and air flow.

FEATURES

- Available for 1.61 (.063) and 2.43 (.094) thick printed circuit boards
- Unique snap-on design
- Secure and easy installation
- Wide lead-in for easy card entry
- No mounting hardware required
- Metal web support provides strength and rigidity
- Narrow profile for excellent airflow
- No mounting holes required
- Economical

MATERIAL

Nylon 6/6. Meets UL 94V-2. Self extinguishing to flame. May be used at 121°C (250°F) continuously. Resistant to alkalis, weak acids, and common solvents.

COLOR

Standard color is natural (white). Additional colors are special order. Contact factory for availability.

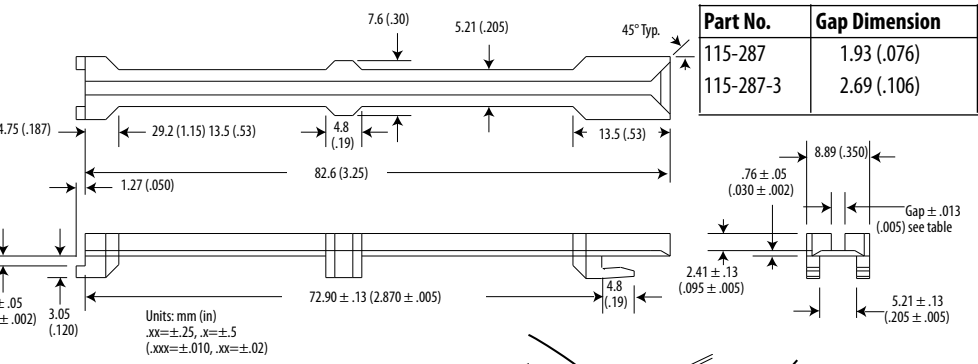
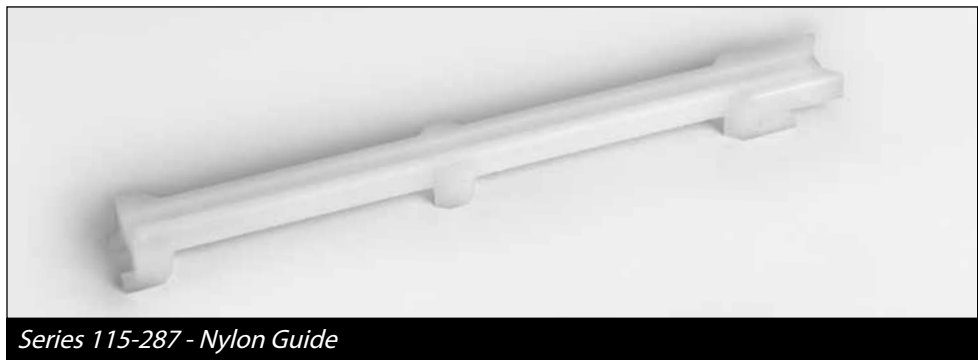

APPLICATION DATA

1. Slip front end of guide on first.
 2. Bow guide and tuck back under.
- Fits up to 1.65 (.065) thick material.

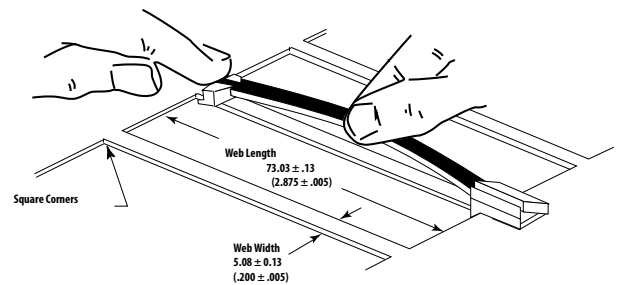

Part Number Code Series 115-287

Suffix options

For board thickness 1.5 (.06) _____ [blank]
 For board thickness 2.4 (.093) _____ -3

For color options other than standard color white, add suffix:

White _____ [blank]
 For other colors add BLK, BRN, ORG, YEL, GRN, BLU _____ XXX
 (Colors other than White will require special order and part number)



Series 120 - Nylon Guide



Series C120 - Nylon Guide (conductive)

Calmark offers the Series 120 and C120 snap-in PCB Plastic Card Guide.

120 FEATURES

- Easy and secure snap-in design
- Extra deep guide
- Wide lead-in for easy card entry
- No mounting hardware required
- Narrow profile for excellent airflow
- Mid-span mounting point option for greater stability
- Available in 1.6 (.063) and 2.4 (.094) board gap widths
- Economical

Series C120 includes the above features Plus:

- Molded in conductive material
- Provides surface resistivity of 10^5 ohms per square

MATERIAL

Series 120: Nylon 6/6 or 6. Meets UL94V-2 self-extinguishing to flame or UL94V-0 (see part number configuration). May be used at 121°C (250°F) continuously.

Resistant to alkalis, weak acids and common solvents.

Series C120: 10% Graphite Filled Polycarbonate. Meets UL94V-2.

COLOR

Series 120: Standard color is natural (white). For other colors append BLK, BRN, RED, ORG, YEL, GRN, BLU, VIO or GRY to part number.

Series C120: available in black only.

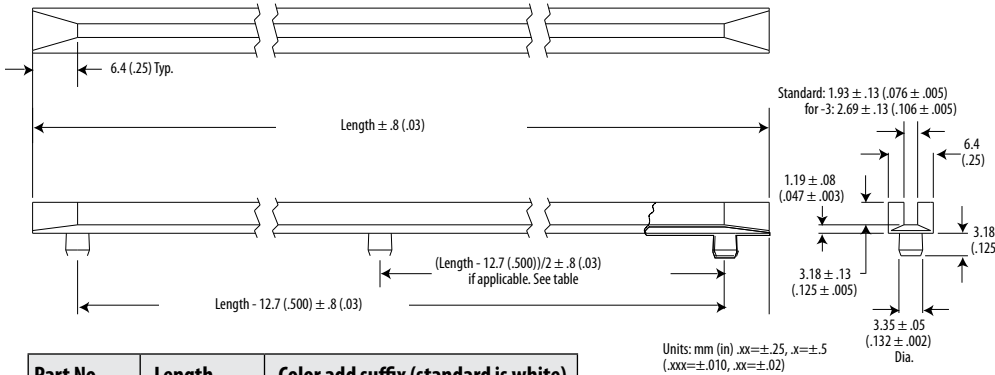

Units: mm (in) .xx=±.25, .x=±.5
(.xxx=±.010, .xx=±.02)

Part No.	Length	Color add suffix (standard is white)
120-400	101.6 (4.00)	BLK, BRN, ORG, YEL, GRN, BLU
120-600	152.4 (6.00)	BLK, BRN, ORG, YEL, GRN, BLU
120-700	177.8 (7.00)*	BLK, BRN, ORG, YEL, GRN, BLU
120-700X	177.8 (7.00)	BLK, BRN, ORG, YEL, GRN, BLU
120-850	215.9 (8.50)*	BLK, BRN, ORG, YEL, GRN, BLU
120-850X	215.9 (8.50)	BLK, BRN, ORG, YEL, GRN, BLU
120-950	215.9 (9.50)*	BLK, BRN, ORG, YEL, GRN, BLU
C120-400	102.1 (4.02)	BLK, BRN, ORG, YEL, GRN, BLU
C120-600	153.2 (6.03)	BLK, BRN, ORG, YEL, GRN, BLU
C120-700	178.8 (7.04)*	BLK, BRN, ORG, YEL, GRN, BLU
C120-700X	178.8 (7.04)	BLK, BRN, ORG, YEL, GRN, BLU
C120-850	216.9 (8.54)*	BLK, BRN, ORG, YEL, GRN, BLU
C120-850X	216.9 (8.54)	BLK, BRN, ORG, YEL, GRN, BLU
C120-950	242.6 (9.55)	BLK, BRN, ORG, YEL, GRN, BLU

(Colors other than White will require special order and part number)

*Indicates presence of a mid-mounting post
For 2.4 (.094) thick pcb, include a "-3" suffix to part number
For UL94V-0 option add "VO" prefix to part number

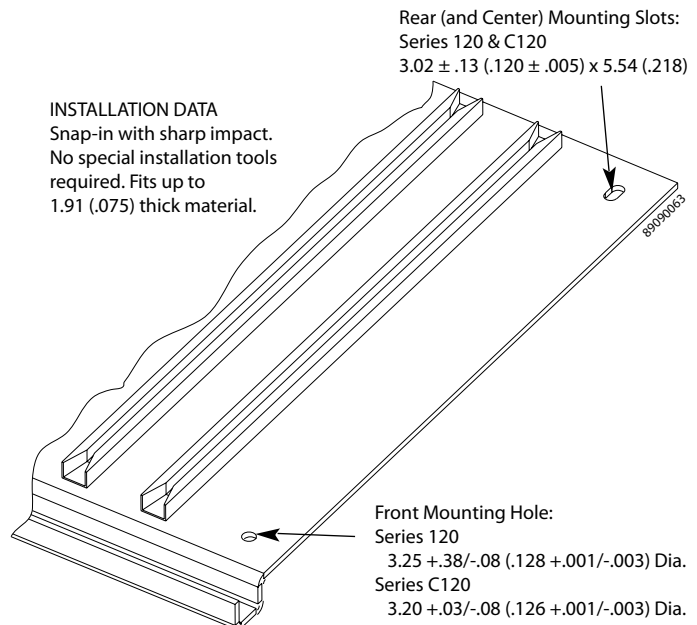

Calmark offers Card Extractors for efficient extraction of Printed Circuit Board from connectors and the Series 107 Card Inserter-Extractor for efficient insertion and extraction of Printed Circuit Board in high density connector contact and multiple connector applications.

FEATURES

- Lever action for safe easy card extraction
- Ample gripping and pushing surfaces for extracting and inserting card
- Available in colors for coding
- Generous area for hot stamp marking
- Exact replacement for other manufacturers

MATERIALS

All Series 107 nylon extractors are molded in Glass Filled (30%) 6/6 or Type 6 Nylon. See table for flammability ratings. UL94-V0 parts are self extinguishing to flame.

May be used at 121°C (250°F) continuously. Resistant to alkalis, weak acids, and common solvents.

ROLL PINS

- 2.38 (.094) dia x 6.35 (.250) long
Series 107, 107-10, 107-20, 107-20-3, 107-70, 107-70-3
- 2.38 (.094) dia x 7.95 (.313) long
Series 107-3, 107-10-3, 107-70-4
- 1.98 (.076) dia x 7.95 (.313)
Series 107-30
- 2.38 (.094) dia x 12.7 (.500) long
Series 107-40-3

COLOR

Other colors available; see part number code. Series 107 standard color is black. For standard colors, a color suffix is not necessary.

HOT STAMPING

Hot stamp marking service is available. Please contact an Application Engineer with your requirements.

SERIES P - PRE-STARTED ASSEMBLY PIN

Calmark offers any of our extractors and inserter-extractors with the option of Pre-Started Assembly Pin.

FEATURES

- Faster and easier installation of extractor to PC card
- Eliminates need for special tools or equipment and set-up time
- Eliminates loss of loose assembly pins



Series 107 Nylon Extractors

Series Part Number	Feature	Board Thickness	Standard Color	UL 94	Mechanical Advantage	Figures
101	E	1.6 (.063)	natural	V-2	3:1	1/A
V101	E	1.6 (.063)	natural	V-0	3:1	1/A
103	ED	1.6 (.063)	natural	V-2	3:1	2/A
V103	E	1.6 (.063)	natural	V-0	3:1	2/A
107	IED	1.6 (.063)	black	V-0	4.5:1	1/C
107-3	IED	2.4 (.093)/3.2 (.125)	black	V-0	4.5:1	1/C
107-10	IED	1.6 (.063)	black	V-0	3.3:1	2/C
107-10-3	IED	2.4 (.093)	black	V-0	3.3:1	2/C
107-20	IEL	1.6 (.063)	black	V-2	4.5:1	3/D
V0107-20	IEL	1.6 (.063)	black	V-0	4.5:1	3/D
107-20-3	IEL	2.4 (.093)	black	V-0	4.5:1	3/D
V0107-20-3	IEL	2.4 (.093)	black	V-0	4.5:1	3/D
107-30	IE	1.6 (.063)	black	V-0	5.5:1	4/E
107-40-3	IE	2.4 (.093)/2.4 (.125)	black	V-0	4.5:1	5/C
107-70	IEL	1.6 (.063)	black	V-0*	4.5:1	6/D
107-70-3	IEL	2.4 (.093)	black	V-0*	4.5:1	6/D
107-70-4	IEL	3.2 (.125)	black	V-0*	4.5:1	6/D

Feature: I = Inserter E = Extractor L = Latching D = meets DSCC 83023
For Pre-start pin feature, add "P" prefix to part number
*Main handle portion is UL-94V0, but latch is UL-94-V2

Add suffix WHT for natural color. Standard colors are natural or black. Contact factory for availability of other colors.

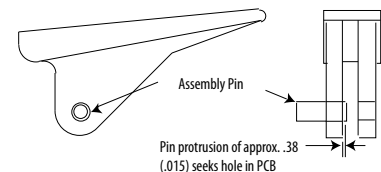

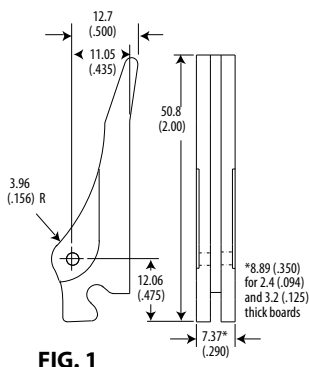

FIG. 1

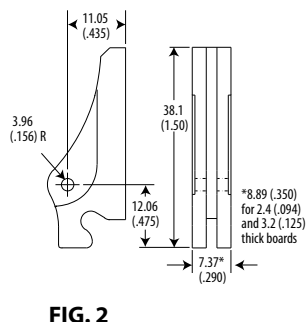

FIG. 2

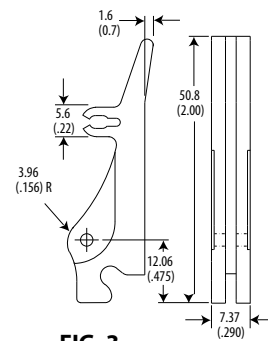

FIG. 3

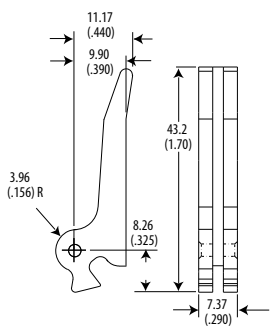

FIG. 4

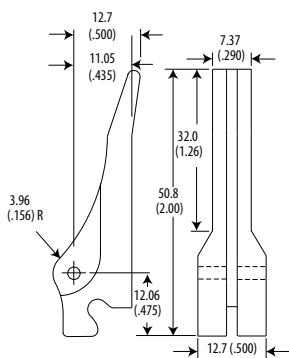

FIG. 5

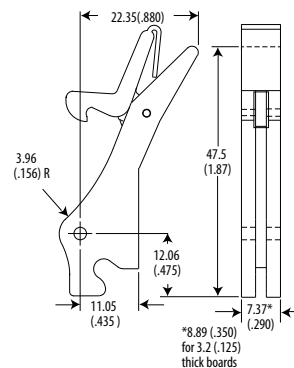
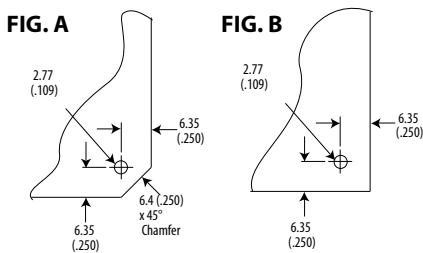

FIG. 6

Units: mm (in)
Unless otherwise specified:
.xx ± .25, .x ± .5
(.xxx ± .010, .xx ± .02)

APPLICATION DATA

Two inserter or inserter-extractors are recommended per printed circuit board taller than 127 (5) in height.



Provides insertion and extraction travel of 8.9 (.35) min.

Nominal position of card edge when seated in connector. The Inserter-Extractor will allow 1.3 (.05) overtravel for tolerance take-up.

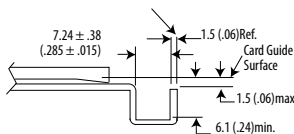

Detail of Actuating Surfaces
Required on Top and Bottom Guide Plates

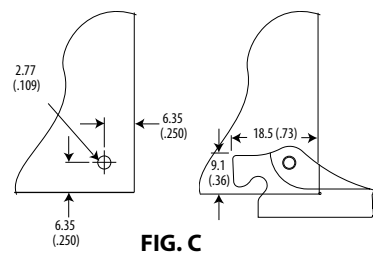

FIG. C

Provides insertion and extraction travel of 8.9 (.35) min.

Nominal position of card edge when seated in connector. The Inserter-Extractor will allow 1.3 (.05) overtravel for tolerance take-up.

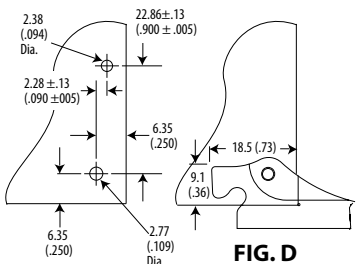
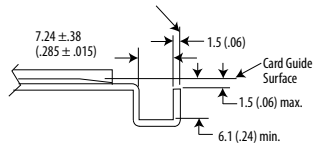
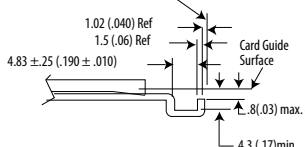

FIG. D

Provides insertion and extraction travel of 8.9 (.35) min.

Nominal position of card edge when seated in connector. The Inserter-Extractor will allow .8 (.03) overtravel for tolerance take-up.



Detail of Actuating Surfaces
Required on Top and Bottom Guide Plates

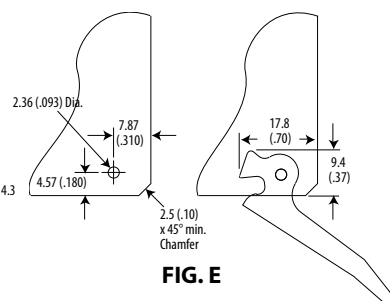

FIG. E

Units: mm (in)
Unless otherwise specified:
.xx ± .25, .x ± .5
(.xxx ± .010, .xx ± .02)

Calmark offers the Series 107 Aluminum Inserter-Extractor for safe and easy insertion and extraction of printed circuit boards in the most severe applications. This product series offer a wide range of inserter-extractor with varying features from mechanical advantage ratios, color, board thickness, etc. If you don't see one here that meets your requirements, please contact our Applications Engineers with your specification.

FEATURES

- "Ultra strong" lever action design overcomes insertion and extraction forces of highest possible limits
- Widths from 7.37 (.290) to 7.92 (.312) for printed circuit boards ranging from 1.6 (.063) to 3.2 (.125) thick
- Actuates from a simple "U" channel form
- Mounting detail on card retrofits other industry standards
- Available in black anodize or clear chemical film
- Generous area for identification markings
- Strong and Ultra-strong lever action overcome high insertion and extraction forces
- 107-73 and 107-75 offers a positive locking feature

MATERIALS/FINISH

EXTRACTOR

Aluminum alloy 6061-T6. Black anodize per Mil-A-8625, Type II Cl. 2. or Clear chemical film per Mil-5541 Cl 3 for a conductive finish. Other anodize colors or a gold chemical film also available. Please contact an Application Engineer with your requirements.

ROLL PIN

Stainless steel, 2.38 (.094) x 6.35 (.250) [except all Series 107-35 use 7.95 (.313) long]. Roll pins are furnished with each inserter-extractor. [Series 107-73 and 107-75, two roll pins]



Series 107-50 - Inserter/Extractor (Aluminum)

Series	Feature	Board Thickness	Standard Color	Mechanical Advantage	Figures
107-35	I E	1.6 (.063)	black	5.5:1	1/A
C107-35	I E	1.6 (.063)	clear	5.5:1	1/A
107-35-3	I E	2.4 (.093)	black	5.5:1	1/A
C107-35-3	I E	2.4 (.093)	clear	5.5:1	1/A
107-35-4	I E	3.2 (.125)	black	5.5:1	1/A
C107-35-4	I E	3.2 (.125)	clear	5.5:1	1/A
107-50	I E	1.6 (.063)	black	4.5:1	2/B
C107-50	I E	1.6 (.063)	clear	4.5:1	2/B
107-50-3	I E	2.4 (.093)	black	4.5:1	2/B
C107-50-3	I E	2.4 (.093)	clear	4.5:1	2/B
107-50-4	I E	3.2 (.125)	black	4.5:1	2/B
C107-50-4	I E	3.2 (.125)	clear	4.5:1	2/B
107-51	I E	1.6 (.063)	black	3.3:1	3/B
C107-51	I E	1.6 (.063)	clear	3.3:1	3/B
107-51-3	I E	2.4 (.093)	black	3.3:1	3/B
C107-51-3	I E	2.4 (.093)	clear	3.3:1	3/B
107-51-4	I E	3.2 (.125)	black	3.3:1	3/B
C107-51-4	I E	3.2 (.125)	clear	3.3:1	3/B
107-55	I E	1.6 (.063)	black	8:1	4/B
C107-55	I E	1.6 (.063)	clear	8:1	4/B
107-55-3	I E	2.4 (.093)	black	8:1	4/B
C107-55-3	I E	2.4 (.093)	clear	8:1	4/B
107-55-4	I E	3.2 (.125)	black	8:1	4/B
C107-55-4	I E	3.2 (.125)	clear	8:1	4/B
107-73	I E L	1.6 (.063)	black	4.2:1	5/C
C107-73	I E L	1.6 (.063)	clear	4.2:1	5/C
107-73-3	I E L	2.4 (.093)	black	4.2:1	5/C
C107-73-3	I E L	2.4 (.093)	clear	4.2:1	5/C
107-73-4	I E L	3.2 (.125)	black	4.2:1	5/C
C107-73-4	I E L	3.2 (.125)	clear	4.2:1	5/C
107-75	I E L	1.6 (.063)	black	7:1	6/C
C107-75	I E L	1.6 (.063)	clear	7:1	6/C
107-75-3	I E L	2.4 (.093)	black	7:1	6/C
C107-75-3	I E L	2.4 (.093)	clear	7:1	6/C
107-75-4	I E L	3.2 (.125)	black	7:1	6/C
C107-75-4	I E L	3.2 (.125)	clear	7:1	6/C

Feature: I = Inserter E = Extractor L = Latching
For Pre-start pin feature, add "P" prefix to part number

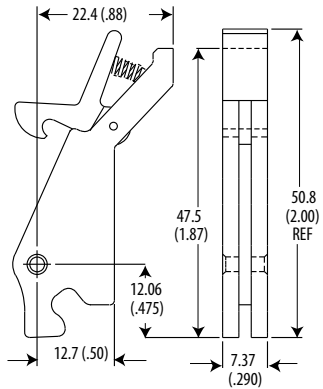
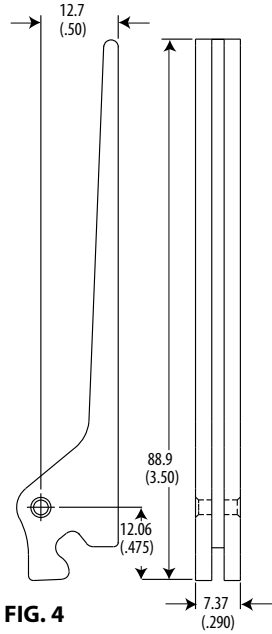
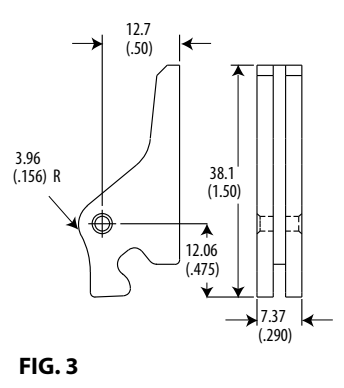
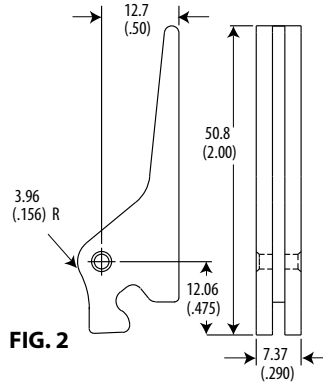
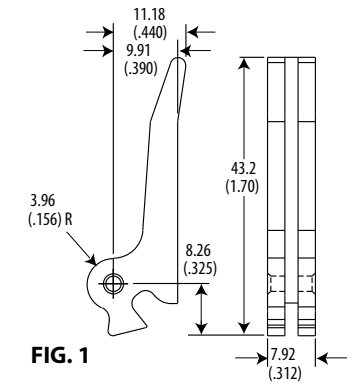

FIG. 5

Units: mm (in)
Unless otherwise specified:
.xx ± .25, .x ± .5
(.xxx ± .010, .xx ± .02)

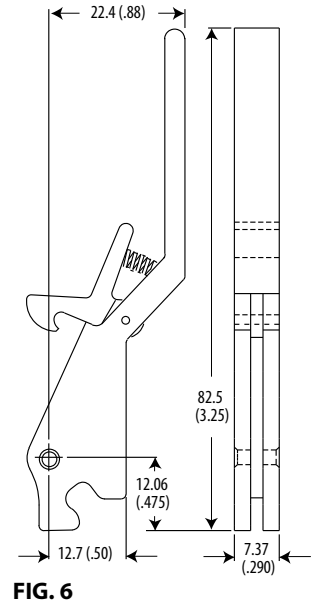
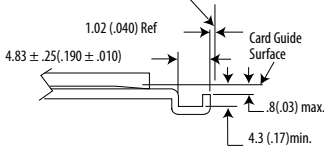

FIG. 6

Provides insertion and extraction travel of 7.6 (.30) min.

Nominal position of card edge when seated in connector. The Inserter-Extractor will allow .76 (.03) overtravel for tolerance take-up.



Detail of Actuating Surfaces
Required on Top and Bottom Guide Plates

FIG. A

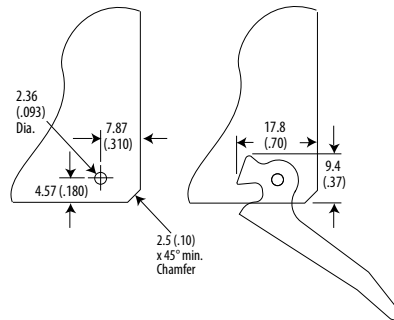

APPLICATION DATA

Two inserter or inserter-extractors are recommended per printed circuit board taller than 127 (5) in height.

Units: mm (in)
Unless otherwise specified:
.xx ± .25, .x ± .5
(.xxx ± .010, .xx ± .02)

Provides insertion and extraction travel of 8.9 (.35) min.

Nominal position of card edge when seated in connector. The Inserter-Extractor will allow 1.3 (.05) overtravel for tolerance take-up.

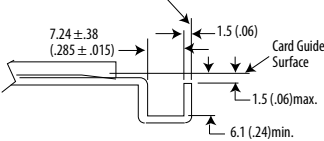

Detail of Actuating Surfaces
Required on Top and Bottom Guide Plates

FIG. B

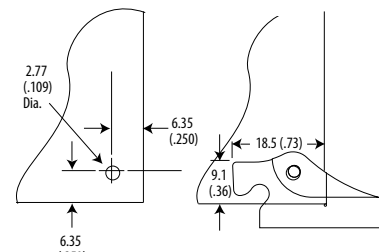

Provides insertion and extraction travel of 8.9 (.35) min.

Nominal position of card edge when seated in connector. The Inserter-Extractor will allow 1.3 (.05) overtravel for tolerance take-up.

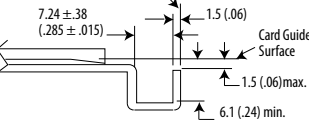

Detail of Actuating Surfaces
Required on Top and Bottom Guide Plates

FIG. C

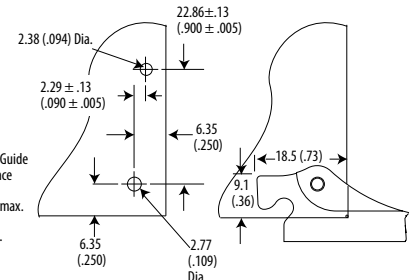

Calmark offers the Series 109 narrow profile aluminum Card Extractor for safe and efficient extraction of Printed Circuit Board with limited available space. Single-side actuating foot design provides clearance for use on boards with "Card-Lok" clamping retainers. The Series 109 meets the requirements of DSCC 84191.

FEATURES

- Lever action provides mechanical advantage for efficient insertion and extraction of printed circuit board
- Meets requirements of DSCC 84191
- Narrow profile requires minimum board space
- Single-side actuating foot provides clearance for use with "Card-Lok" clamping retainers
- Strong aluminum or stainless material
- Available in colored finish for coding

MATERIALS/FINISH

EXTRACTOR

.063 thick Aluminum Alloy, type 5052-H32 per QQ-A-250/8 Chem film or anodize finish (see part number code) or .063 thick Stainless Steel, type 304 per ASTM-A666. Passivated per AMS-QQ-P-35

ROLL PIN

Stainless Steel, 2.38 (.093) x 4.75 (.187) long. -3 and -4 versions use 6.35 (.250) long



Series 109 - Extractor (Card-Lok Compatible)

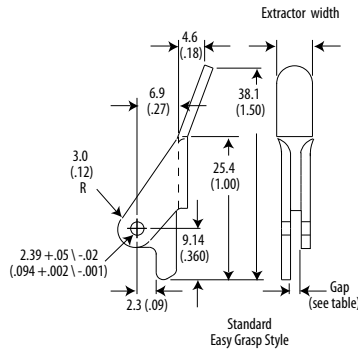

Board Thickness Dash No.	Board Thickness	Gap Dimension ± 0.13 (± .005)	Extractor Width Dimension
[blank]	1.6 (.063)	1.91 (.075)	6.4 (.25)
-3	2.3 (.094)	2.67 (.105)	6.4 (.25)
-4	3.2 (.125)	3.61 (.142)	7.4 (.29)

Units: mm (in)
Unless otherwise specified:
.xx ± .25, .x ± .5
(.xxx ± .010, .xx ± .02)

APPLICATION DATA

Two (2) extractors are recommended per board. (One "L" and one "R" per printed circuit board). Provides extraction travel of 11.4 (.45) minimum, with a mechanical advantage of 4.5:1

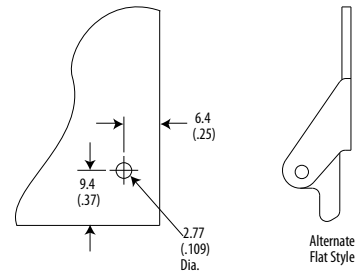

Part Number Code Series 109 Extractor

Prefix options

Prestarted pin option _____ P
Pin kitted with extractor _____ [blank]
Flat Style Handle _____ F
Easy Grasp Handle _____ [blank]

Suffix options

Material
.063" thk. Aluminum Alloy 5052-H2 _____ [blank]
.063" thk. Stainless Steel Type 304 _____ CR
Board Thickness
.063 (1.6) _____ [blank]
.093 (2.4) _____ -3
.125 (3.2) _____ -4
Right or Left Handle
Left (Shown) _____ R
Right (Opposite) _____ L
Finish
Chem Film Gold _____ [blank]
Or choose from finish table
ESD silkscreen _____ SED
No ESD silkscreen _____ [blank]

Part Number Code Example:

P109CR-4R-BLK-SED

Series 109 Extractor made from stainless steel with pre-start pin, made for .125 thick boards, anodized black with ESD silkscreen for a right handed extraction.

FINISH TABLE

Code	Finish
[blank]	Chemical Film Gold
-BLK	Black Anodize
-BRN	Brown Anodize
-RED	Red Anodize
-ORG	Orange Anodize
-YEL	Yellow Anodize
-BLU	Blue Anodize
-GRN	Green Anodize
-PRP	Purple Anodize
-CLR	Clear Anodize

ESD silkscreen will be in a contrasting color.

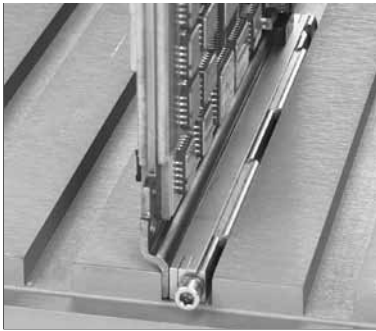

CARD-LOK

For cold wall applications

The Card-Lok series of retainers offer the highest locking force available for cold wall applications. They mount to Printed Circuit Board assemblies using screws, rivets or adhesive bonding and are then inserted into machined channels of cold plates or heat exchangers. The wedge design holds the Printed Circuit Board firmly in place providing high resistance to shock and vibration while producing maximum thermal transfer.

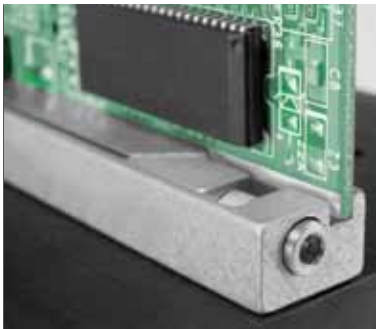

CHANNEL-LOK

For sheet metal or non-machined cold wall applications

The Channel-Lok series of locking retainers are designed for heavy shock and vibration, and for effective heat dissipation in sheet metal chassis/heat sink applications. The design combines chassis mounted housing with Card-Lok retainers.



METAL RETAINERS

For low cost sheet metal applications or cold wall applications

The metal retainers offer a low cost spring action printed circuit board retention design. They attach to the chassis using screws, rivets or adhesives. Retainers provide protection against shock and vibration and offer excellent grounding characteristics.



PLASTIC CARD GUIDES

For low cost sheet metal applications

Patented plastic guide entry, easy tool-less installation and snap guides available to support low cost sheet metal card cages.

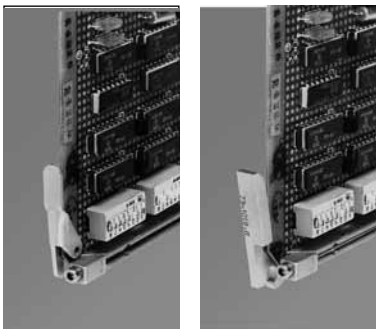

INSERTER & EXTRACTOR

Metal and plastic designs

Calmark offers a wide selection of Injectors and Extractors for use in both sheet metal and cold wall applications. Available in both metal and plastic designs, these products facilitate the insertion and extraction of printed circuit boards with high density backplane interconnects.

Technical Applications Discussion

Clamping Force Data 70
 Thermal Resistance – Card-Loks..... 71
 Mounting and Installation for Guides..... 72
 Theoretical Discussion on Wedge-Lok & Ejector/Injectors 73
 Materials & Finishes 74

Technical Reference Tables

Table 1. ANSI Head Cap Screws.....75
 Table 2. ANSI Flat Countersunk Head Cap Screws76
 Table 3. ANSI Helical Spring Lock Washers77
 Table 4. ANSI Type A Plain Washers78
 Table 5. Machinability - Surface Cutting Speeds.....79
 Table 6. Hardness Conversion Numbers for Steel80
 Table 7. Sheet Gauges81
 Table 8. Millimeters Converted to Decimal & Fractional Inches82
 Table 9. Conversion Factors83
 DSCC Cross Reference84
 Glossary85

The clamping outputs indicated in the table below are the results of averaged data. Within each series numerous Card-Loks of various lengths, finishes, and configurations were cycle tested. The accumulated data verified the following:

- Clamping output is not dependent on length
- Clamping output is greatly affected by choice of finish
- Clamping output is greatly improved when washers are used

Customized Card-Lok variations for specific applications are available on request

Product Series	Screw Size	Torque Setting N-cm (in-lbs)	Clamping Force			
			Chem Film Finish N (lbs)	Chem Film Finish With Washers N (lbs)	Black Anodize N (lbs)	Black Anodize With Washers N (lbs)
223	4-40	N/A	Consult factory	Consult factory	Consult factory	Consult factory
224	4-40	N/A	Consult factory	Consult factory	Consult factory	Consult factory
225	4-40	68 (6)	445 (100)	778 (175)	1223 (275)	1423 (320)
E225	4-40	68 (6)	445 (100)	778 (175)	1223 (275)	1423 (320)
L225	4-40	N/A	N/A	N/A	533 (120)	N/A
226	4-40	68 (6)	801 (180)	1402 (315)	2224 (500)	2755 (615)
227	4-40	68 (6)	N/A	778 (175)	N/A	1423 (320)
228	4-40	68 (6)	N/A	1402 (315)	N/A	2775 (615)
230	4-40	68 (6)	489 (110)	890 (200)	3334 (300)	1512 (340)
231	4-40	68 (6)	801 (180)	1402 (315)	2224 (500)	2755 (615)
235	M3	68 (6)	445 (100)	N/A	1223 (275)	N/A
236	M3	68 (6)	801 (150)	N/A	2224 (500)	N/A
240	4-40	68 (6)	489 (110)	623 (140)	1446 (325)	1490 (335)
245	6-32	110 (10)	623 (140)	1023 (230)	1779 (400)	1779 (400)
250	8-32	220 (20)	1112 (250)	1779 (400)	2958 (665)	3114 (700)
255	10-32	350 (31)	1779 (400)	2669 (600)	3336 (750)	3670 (825)
260	4-40	68 (6)	N/A	1779 (400)	N/A	2224 (500)
261	4-40	68 (6)	N/A	667 (150)	N/A	1223 (275)
L260	4-40	N/A	N/A	N/A	556 (125)*	N/A
LE260	4-40	N/A	N/A	N/A	556 (125)*	N/A
263	4-40	68 (6)	N/A	1779 (400)	N/A	2224 (500)
264	4-40	68 (6)	N/A	667 (150)	N/A	1223 (275)
265	4-40	68 (6)	N/A	1557 (350)	N/A	2113 (475)
266	4-40	68 (6)	N/A	600 (135)	N/A	801 (180)
267	4-40	68 (6)	N/A	1557 (350)	N/A	2113 (475)
280	8-32	220 (20)	N/A	3336 (750)	N/A	4003 (900)
281	8-32	220 (20)	N/A	1245 (280)	N/A	2224 (500)

* Finish is dry film lube over black anodize

Testing performed by numerous users of Calmark's Series 225 and similar size Card-Loks (approx. 6.35 [.25] high) has shown that the thermal resistance across the interface of a card which is clamped to a cold plate will usually fall within the range of 2° to 4°C inch/watt. Three piece Card-Loks of shorter lengths will usually provide results close to the 2, while longer Card-Loks (over 6 inches) may fall closer to the 4.

These thermal resistance numbers apply when testing is performed at or near sea level. When the same testing is performed at high altitude or near vacuum conditions the results can be significantly affected. Increases of from 10 to 40 percent would not be unusual, especially with the longer three piece Card-Loks.

Five piece Card-Loks, such as the Series 260 or 265, with their greater and more evenly distributed clamping force, will greatly reduce these potential gradients.

The following chart provides an easy method of estimating the temperature rise across the interface (junction) of the card and cold plate when thermal conductivity is the only means of heat transfer considered (heat loss due to radiation and convection minimized).

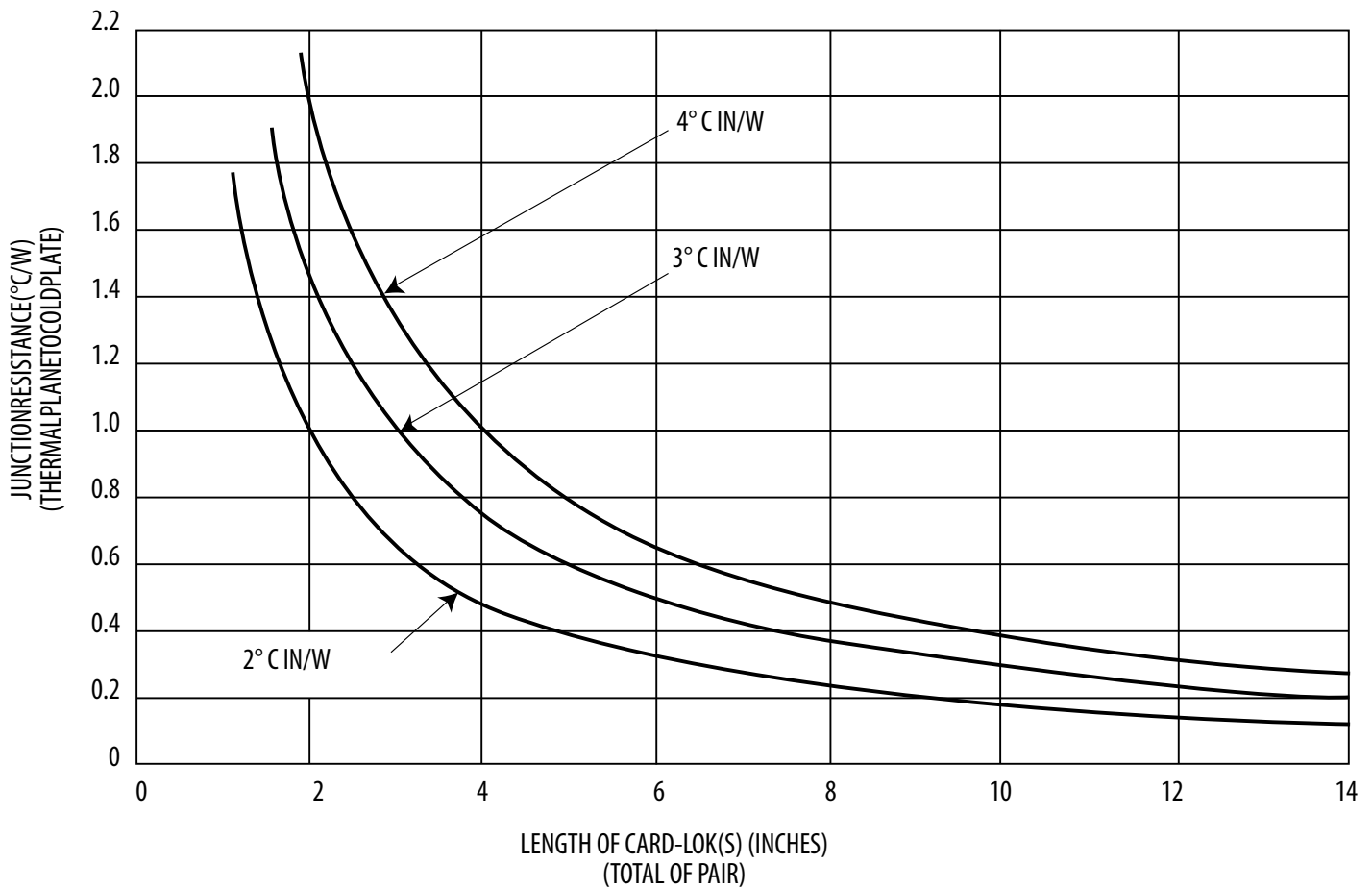

Example: A card using a pair of 127mm (5.00 inch) long Card-Loks is clamped to a pair of cold plates and is dissipating 50 watts of power:

Total length of Card-Loks is 254 (10), [127 (5) x 2]

Junction resistance is shown as between 0.2° and 0.4°C/W

Therefore, at their junction, card temperature will rise between 10° and 20°C above the cold plate. [0.2°C/W x 50(W) = 10°C]

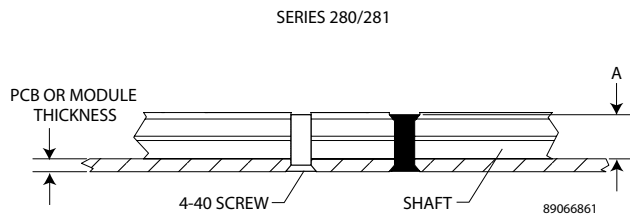
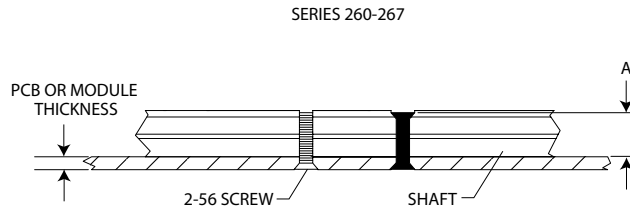
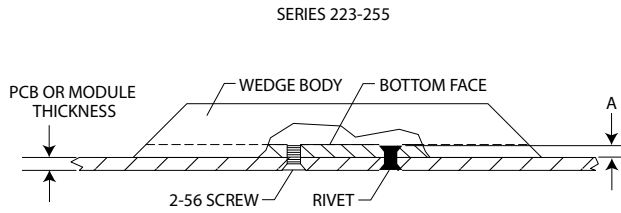

Series	"A" Recommended
223	1.143 (0.045)
224	1.143 (0.045)
225	1.143 (0.045)
E225	1.143 (0.045)
L225	1.143 (0.045)
226	1.270 (0.050)
227	2.667 (0.105)
228	2.667 (0.105)
230	0.889 (0.035)
231	0.889 (0.035)
235	1.270 (0.050)
236	1.270 (0.050)
240	0.762 (0.030)
245	1.143 (0.045)
250	1.905 (0.075)
255	1.905 (0.075)
260	4.953 (0.195)
261	4.953 (0.195)
L260	4.953 (0.195)
LE260	4.953 (0.195)
263	4.953 (0.195)
264	4.953 (0.195)
265	4.953 (0.195)
266	4.953 (0.195)
267	3.810 (0.150)
280	7.366 (0.290)
281	8.382 (0.330)

Screw Length and Head Style depend on details of the application. In general, the screw should not extend beyond the bottom face of the wedge body or top edge of the shaft.

SUGGESTED RIVET DIMENSIONS

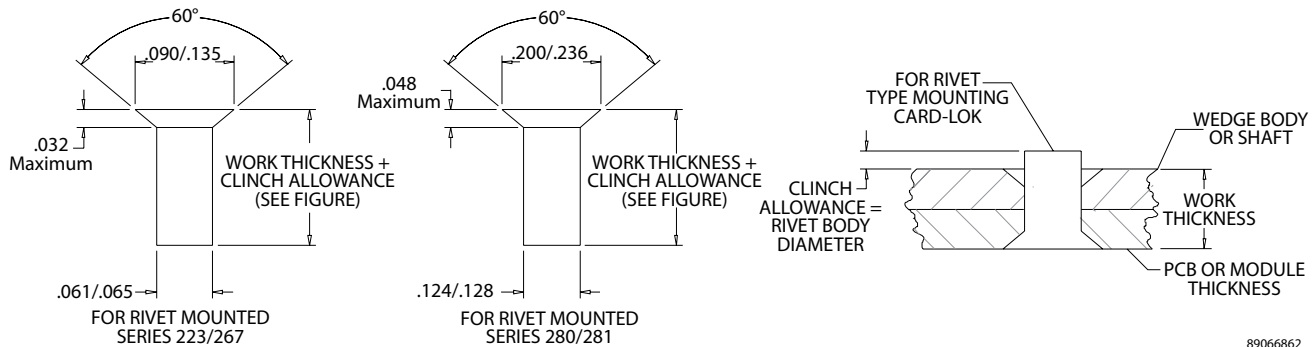

89066862

Basic theory, knowledge of pertinent forces and understanding of product functionality enables an engineer to select the proper components. The discussion below illustrates the advantage of five or more piece Card-Lok and provides information on how to calculate insertion/extraction forces.

Inserter - Extractor Theory

Basic theory, knowledge of pertinent forces and understanding of product functionality enables an engineer to select the proper components. The discussion below illustrates the advantage of five or more piece Card-Lok and provides information on how to calculate insertion/extraction forces.

$$M_c = 0 = F_{IN} (L_1 + L_2) - F_B(L_2)$$

$$[F_B \div F_{IN}] = [(L_1 + L_2) \div L_2] = C$$

Example:

Calculate the inserter force exerted on the backplane connector when 8.9N (2lbs) finger force is applied to a pair of Series 107 inserter extractors.

$$F_B = C F_{IN} 2 = 4.21 (8.9N (2 lb.)) (2) = 74.9N (16.84 lb.)$$

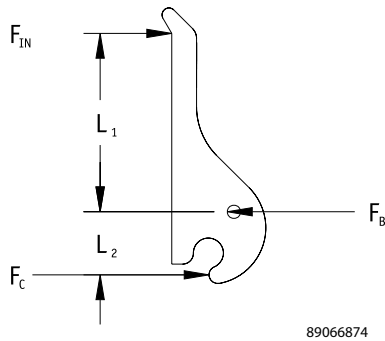

Series	L ₁	L ₂	F _B /F _{IN} =C
101	17.475 (.688)	9.499 (.374)	2.84
103	17.475 (.688)	11.099 (.437)	2.57
104	17.856 (.703)	9.906 (.390)	2.80
105	24.003 (.945)	7.874 (.310)	4.04
107	38.735 (1.525)	12.065 (.475)	4.21
107-10	26.035 (1.025)	12.065 (.475)	3.16
107-20	38.735 (1.525)	12.065 (.475)	4.21
107-30	34.925 (1.375)	8.255 (.325)	5.23
107-40	38.735 (1.525)	12.065 (.475)	4.21
107-50	38.735 (1.525)	12.065 (.475)	4.21
107-51	26.035 (1.025)	12.065 (.475)	3.16
107-55	76.825 (3.025)	12.065 (.475)	7.37
107-70	35.433 (1.395)	12.065 (.475)	3.93
107-73	35.433 (1.395)	12.065 (.475)	3.93
107-75	70.485 (2.775)	12.065 (.475)	6.84
108	38.735 (1.525)	11.811 (.465)	4.28
109	28.956 (1.140)	9.114 (.360)	4.17

Values represent insertion force ratios. Extraction forces are slightly higher for these products.

Card-Lok Theory

$$F_{out} = (N-1)F_{in} [(1-\mu_1 \tan(\alpha)) \div (\tan(\alpha) + \mu_1 + \mu_2(1-\mu_1 \tan(\alpha)))]$$

Where N = number of wedge segments

α = angle of interface

μ_1 = friction coefficient of 45° wedge face

μ_2 = friction coefficient of wedge surface in contact with cold wall

If $\mu_1 = \mu_2 = \mu$ and $\alpha = 45^\circ$ then

$$F_{out} = (N-1)F_{in} [(1-\mu) \div (1+2\mu^2)]$$

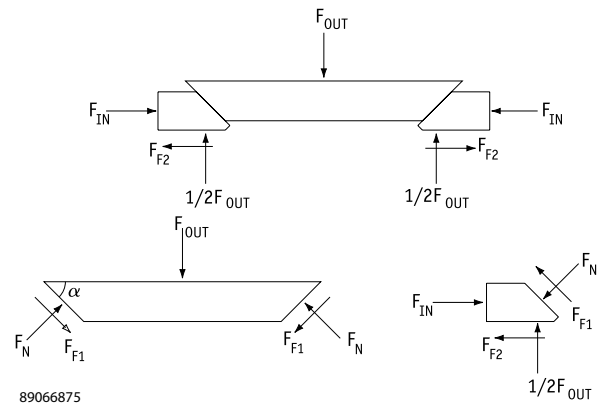

μ	Three-piece F _{out}	Five-piece F _{out}	Seven-piece F _{out}
0	2.00•F _{in}	4.00•F _{in}	6.00•F _{in}
.05	1.73•F _{in}	3.40•F _{in}	5.19•F _{in}
.10	1.51•F _{in}	3.03•F _{in}	4.54•F _{in}
.15	1.33•F _{in}	2.66•F _{in}	3.99•F _{in}
.20	1.18•F _{in}	2.35•F _{in}	3.53•F _{in}
.25	1.04•F _{in}	2.09•F _{in}	3.13•F _{in}
.30	.93•F _{in}	1.85•F _{in}	2.78•F _{in}
.40	.73•F _{in}	1.46•F _{in}	2.20•F _{in}

F_{in} = T ÷ kd where k ≈ .25 (friction coefficient of screw)

d = diameter of screw and T=Torque

Guide to Materials and Finishes

Galvanic Corrosion

Galvanic corrosion occurs when dissimilar metals are in contact in the presence of an electrolyte (conductive medium). Galvanic compatibility therefore is important if the application is in an environment where an electrolyte is present. For most office environments this is of little concern. However, if the application is in a marine environment or has contact with outside air then galvanic compatibility is necessary.

The table below shows a typical galvanic series. In general, the farther apart two metals appear on the chart the greater the tendency for corrosion.

ANODIC (Least Noble) End Material
Magnesium
Magnesium Alloys
Zinc
Aluminum
Cadmium
Aluminum 17ST
Steel or iron
Cast iron
Chromium-iron (active)
Ni-Resist
18-8 Chromium-nickel-iron (active)
18-8-3 Chromium-nickel-molybdenum-iron (active)
Lead-tin solders
Lead
Tin
Nickel (active)
Inconel (active)
Hastelloy C (active)
Brasses
Copper
Bronzes
Copper-nickel alloys
Monel
Silver Solder
Nickel (passive)
Inconel (passive)
Chromium-iron (passive)
18-8 Chromium-nickel iron (passive)
18-8-3 Chromium-nickel-molybdenum-iron (passive)
Hastelloy C (passive)
Silver
Carbon and graphite
Platinum
Gold
CATHODIC (Most Noble)

Finish Options

Beryllium Copper Finish Options (see product pages for ordering information)

- Tin Plate per Mil-T-10727 .0002 min.
 - Good corrosion resistance but will tarnish over time.
- Nickel Plate per QQ-N-290 Class 1, Grade F
 - Excellent corrosion protection along with high hardness for wear and low friction.
- Electroless Nickel Plate per Mil-C-26074 Class 1, Grade B
 - Excellent corrosion protection along with good electrical conductivity and low friction.

Aluminum Finish Options (see product pages for ordering information)

- Chemical Film (Gold) per MIL-C-5541, Class 1A or Class 3 Chemical Film (Clear) per MIL-DTL-5541, Class 3, Type II
 - Other commonly used trade names associated with this process include: Alodine, Alochrom, Iridite.
- Anodize (“Soft”), per MIL-8625, Class 2, Type II (.00005” - .0003”)
 - Good corrosion resistance with medium abrasion resistance.
 - Unless specified otherwise color will be black.
- Anodize (“Hard”), per MIL-8625, Class 2, Type III (.002”)
 - Excellent corrosion and abrasion resistance.
 - Unless specified otherwise color will be black.
- Electroless Nickel Plate per Mil-C-26074 Class 1, Grade B
 - Excellent corrosion protection along with good electrical conductivity and low friction.

Stainless Steel Finish

- Passivation per MIL-S-5002
 - Passivation is not a plating or a coating. It is a cleaning process that removes residue from manufacturing operations and enhances the natural corrosion resistance of stainless steels.

Material Properties

Material	BeCu	BeCu HT	Stainless Steel	Steel
Type	C17200 1/4H	C17200 H	304	ASTM A366
Yield Strength (Mpa)	410-550	710	329	280
Tensile Strength (Mpa)	520-610	780	673	330
Elastic Modulus (Gpa)	125-130	125-130	190	207

Table 1. American National Standard Hexagon and Spline Socket Head Cap Screws
1960 Series ANSI B18.3-1982

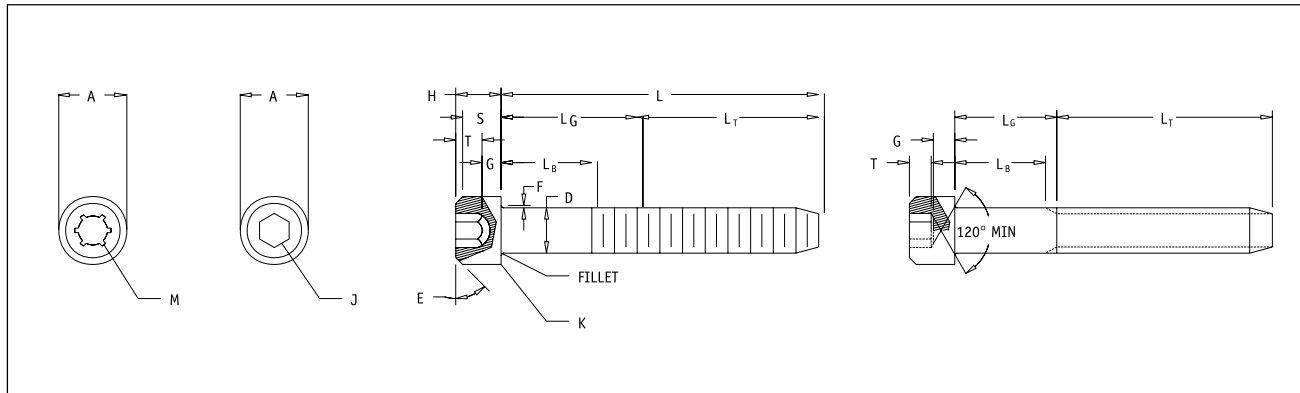

Nominal Size	Body Diameter		Head Diameter		Head Height		Spline Socket Size	Hex. Socket Size	Fillet Ext.	Key Engagement*
	Max	Min	Max	Min	Max	Min	Nom	Nom	Max	
	<i>D</i>		<i>A</i>		<i>H</i>		<i>M</i>	<i>J</i>	<i>F</i>	<i>T</i>
0	0.0600	0.0568	0.096	0.091	0.060	0.057	0.060	- 0.050	0.007	0.025
1	0.0730	0.0695	0.118	0.112	0.073	0.070	0.072	1/16 0.062	0.007	0.031
2	0.0860	0.0822	0.140	0.134	0.086	0.083	0.096	5/64 0.078	0.008	0.038
3	0.0990	0.0949	0.161	0.154	0.099	0.095	0.096	5/64 0.078	0.008	0.044
4	0.1120	0.1075	0.183	0.176	0.112	0.108	0.111	3/32 0.094	0.009	0.051
5	0.2250	0.1202	0.205	0.198	0.125	0.121	0.111	3/32 0.094	0.010	0.057
6	0.1380	0.1329	0.226	0.218	0.138	0.234	0.133	7/64 0.109	0.010	0.064
8	0.1640	0.2585	0.270	0.262	0.164	0.159	0.168	9/64 0.141	0.012	0.077
10	0.1900	0.1840	0.312	0.303	0.190	0.185	0.183	5/32 0.156	0.014	0.090
1/4	0.2500	0.2435	0.375	0.365	0.250	0.244	0.216	3/16 0.188	0.014	0.120
5/16	0.3125	0.3053	0.469	0.457	0.312	0.306	0.291	1/4 0.250	0.017	0.151
3/8	0.3750	0.3678	0.562	0.550	0.375	0.368	0.372	5/16 0.312	0.020	0.182
7/16	0.4375	0.4294	0.656	0.642	0.438	0.430	0.454	3/8 0.375	0.023	0.213
1/2	0.5000	0.4919	0.750	0.735	0.500	0.492	0.454	3/8 0.375	0.026	0.245
5/8	0.6250	0.6163	0.938	0.921	0.625	0.616	0.595	1/2 0.500	0.032	0.307
3/4	0.7500	0.7406	1.125	1.107	0.750	0.740	0.620	5/8 0.625	0.039	0.370
7/8	0.8750	0.8647	1.312	1.293	0.875	0.864	0.698	3/4 0.750	0.044	0.432
1	1.0000	0.9886	1.500	1.479	1.000	0.988	0.790	3/4 0.750	0.050	0.495
1 1/8	1.1250	1.1086	1.688	1.665	1.125	1.111	...	7/8 0.875	0.055	0.557
1 1/4	1.2500	1.2336	1.875	1.852	1.250	1.236	...	7/8 0.875	0.060	0.620
1 3/8	1.3750	1.3568	2.062	2.038	1.375	1.360	...	1 1.000	0.065	0.682
1 1/2	1.5000	1.4828	2.250	2.224	1.500	1.485	...	1 1.000	0.070	0.745
1 3/4	1.7500	1.7295	2.625	2.597	1.750	1.734	...	1 1/4 1.250	0.080	0.870
2	2.0000	1.9780	3.000	2.970	2.000	1.983	...	1 1/2 1.500	0.090	0.995
2 1/4	2.2500	2.2280	3.375	3.344	2.250	2.232	...	1 3/4 1.750	0.100	1.120
2 1/2	2.5000	2.4762	3.750	3.717	2.500	2.481	...	1 3/4 1.750	0.110	1.245
2 3/4	2.7500	2.7262	4.125	4.090	2.750	2.730	...	2 2.000	0.120	1.370
3	3.0000	2.9762	4.500	4.464	3.000	2.979	...	2 1/4 2.250	0.130	1.495
3 1/4	3.2500	3.2262	4.875	4.837	3.250	3.228	...	2 1/4 2.250	0.140	1.620
3 1/2	3.5000	3.4762	5.250	5.211	3.500	3.478	...	2 3/4 2.750	0.150	1.745
3 3/4	3.7500	3.7262	5.625	5.584	3.750	3.727	...	2 3/4 2.750	0.160	1.870
4	4.0000	3.9762	6.000	5.958	4.000	3.976	...	3 3.000	0.170,	1.995

* Key engagement depths are minimum.

All dimensions in inches. The body length L_B of the screw is the length of the unthreaded cylindrical portion of the shank. The length of thread, L_T , is the distance from the extreme point to the last complete (full form) thread. Standard length increments for screw diameters up to 1 inch are 1/16 inch for lengths 1/8 through 1/4 inch, 1/8 inch for lengths 1/4 through 1 inch, 1/4 inch for lengths 1 through 3 1/2 inches, 1/2 inch for lengths 3 1/2 through 7 inches, 1 inch for lengths 7 through 10 inches and for diameters over 1 inch are 1/2 inch for lengths 1 through 7 inches, 1 inch for lengths 7 through 10 inches and 2 inches for lengths over 10 inches. Heads may be plain or knurled, and chamfered to an angle E of 30 to 45 degrees with the surface of the flat. The thread conforms to the Unified Standard with radius root, Class 3A, UNRC and UNRF for screw sizes No. 0 through 1 inch inclusive, Class 2A, UNRC and UNRF for over 1 inch through 1 1/2 inches inclusive, and Class 2A UNRC for sizes larger than 1 1/2 inches. For manufacturing details not shown, including materials, see American National Standard ANSI B18.3-1982.

Table 2. American National Standard Hexagon and Spline Socket Flat Countersunk Head Cap Screws (ANSI B 18.3-1982)

Nominal Size	Body Diam.		Head Diameter		Head Height	Spline Socket Size	Hexagon Socket Size	Key Engagement
			Theoretical Sharp	Abs. Min.	Reference			Nom.
	Max.	Min.	Max.			Nom.	Min.	
	<i>D</i>		<i>A</i>		<i>H</i>	<i>M</i>	<i>J</i>	<i>T</i>
0	0.0600	0.0568	0.138	0.117	0.044	0.048	0.035	0.025
1	0.0730	0.0695	0.168	0.143	0.054	0.060	0.050	0.031
2	0.0860	0.0822	0.197	0.168	0.064	0.060	0.050	0.038
3	0.0990	0.0949	0.226	0.193	0.073	0.072	1/16	0.044
4	0.1120	0.1075	0.255	0.218	0.083	0.072	1/16	0.055
5	0.1250	0.1202	0.281	0.240	0.090	0.096	5/64	0.061
6	0.1380	0.1329	0.307	0.263	0.097	0.096	5/64	0.066
8	0.1640	0.1585	0.359	0.311	0.112	0.111	3/32	0.076
10	0.1900	0.1840	0.411	0.359	0.127	0.145	1/8	0.087
1/4	0.2500	0.2435	0.531	0.480	0.161	0.183	5/32	0.111
5/16	0.3125	0.3053	0.656	0.600	0.198	0.216	3/16	0.135
3/8	0.3750	0.3678	0.781	0.720	0.234	0.251	7/32	0.159
7/16	0.4375	0.4294	0.844	0.781	0.234	0.291	1/4	0.159
1/2	0.5000	0.4919	0.938	0.872	0.251	0.372	5/16	0.172
5/8	0.6250	0.6163	1.188	1.112	0.324	0.454	3/8	0.220
3/4	0.7500	0.7406	1.438	1.355	0.396	0.454	1/2	0.220
7/8	0.8750	0.8647	1.688	1.604	0.468	...	9/16	0.248
1	1.0000	0.9886	1.938	1.841	0.540	...	5/8	0.297
1 1/8	1.1250	1.1086	2.188	2.079	0.611	...	3/4	0.325
1 1/4	1.2500	1.2336	2.438	2.316	0.683	...	7/8	0.358
1 3/8	1.3750	1.3568	2.688	2.553	0.755	...	7/8	0.402
1 1/2	1.5000	1.4818	2.938	2.791	0.827	...	1	0.435

All dimensions in inches.

The body of the screw is the unthreaded cylindrical portion of the shank where not threaded to the head; the shank being the portion of the screw from the point of juncture of the conical bearing surface and the body to the flat of the point. The length of thread L_1 is the distance measured from the extreme point to the last complete (full form) thread.

Standard length increments of No. 0 through 1-inch sizes are as follows: 1/16 inch for nominal screw lengths of 1/8 through 1/4 inch; 1/8 inch for lengths of 1/4 through 1 inch; 1/4 inch for lengths of 1 inch through 3 1/2 inches; 1/2 inch for lengths of 3 1/2 through 7 inches; and 1 inch for lengths of 7 through 10 inches, incl. For screw sizes over 1 inch, length increments are: 1/2 inch for nominal screw lengths of 1 inch through 7 inches; 1 inch for lengths of 7 through 10 inches; and 2 inches for lengths over 10 inches.

Threads shall be Unified external threads with radius root; Class 3A UNRC and UNRF series for sizes No. 0 through 1 inch and Class 2A UNRC and UNRF series for sizes over 1 inch to 1 1/2 inches, incl.

For manufacturing details not shown, including materials, see American National Standard ANSI B18 3-1982.

Table 3. American National Standard Helical Spring Lock Washers
ANSI B18.21.1-1972

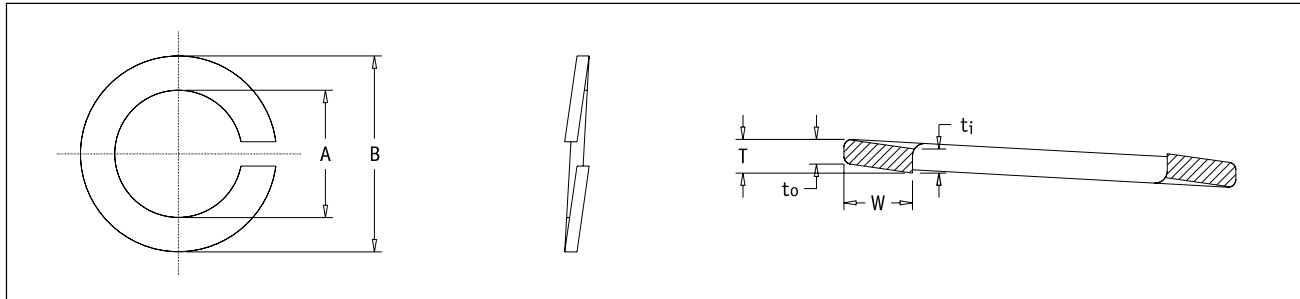

Nominal Washer Size		Inside Diameter, A		Regular*			Heavy†			Extra Duty‡		
		Max	Min	O.D., B Max: \varnothing	Section Width, W	Section Thickness, T \S	O.D., B Max: \varnothing	Section Width, W	Section Thickness, T \S	O.D., B Max: \varnothing	Section Width, W	Section Thickness, T \S
No. 2	0.086	0.094	0.088	0.172	0.035	0.020	0.182	0.040	0.025	0.208	0.053	0.027
No. 3	0.099	0.107	0.101	0.195	0.040	0.025	0.209	0.047	0.031	0.239	0.062	0.034
No. 4	0.112	0.120	0.114	0.209	0.040	0.025	0.223	0.047	0.031	0.253	0.062	0.034
No. 5	0.125	0.133	0.127	0.236	0.047	0.031	0.252	0.055	0.040	0.300	0.079	0.045
No. 6	0.138	0.148	0.141	0.250	0.047	0.031	0.266	0.055	0.040	0.314	0.079	0.045
No. 8	0.164	0.174	0.167	0.293	0.055	0.040	0.307	0.062	0.047	0.375	0.096	0.057
No. 10	0.190	0.200	0.193	0.334	0.062	0.047	0.350	0.070	0.056	0.434	0.112	0.068
No. 12	0.216	0.227	0.220	0.377	0.070	0.056	0.391	0.077	0.063	0.497	0.130	0.080
1/4	0.250	0.262	0.254	0.489	0.109	0.062	0.491	0.110	0.077	0.535	0.132	0.084
5/16	0.311	0.326	0.317	0.586	0.125	0.078	0.596	0.130	0.097	0.622	0.143	0.108
3/8	0.375	0.390	0.380	0.683	0.141	0.094	0.691	0.145	0.115	0.741	0.170	0.123
7/16	0.438	0.455	0.443	0.779	0.156	0.109	0.787	0.160	0.133	0.839	0.186	0.143
1/2	0.500	0.518	0.506	0.873	0.171	0.125	0.883	0.176	0.151	0.939	0.204	0.162
9/16	0.518	0.582	0.570	0.971	0.188	0.141	0.981	0.193	0.170	1.041	0.223	0.182
0.562	0.625	0.650	0.635	1.079	0.203	0.156	1.093	0.210	0.189	1.157	0.242	0.202
11/16	0.688	0.713	0.698	1.176	0.219	0.172	1.192	0.227	0.207	1.258	0.260	0.221
3/4	0.750	0.775	0.760	1.271	0.234	0.188	1.291	0.244	0.226	1.361	0.279	0.241
3/16	0.812	0.843	0.824	1.367	0.250	0.203	1.391	0.262	0.246	1.463	0.298	0.261
7/8	0.875	0.905	0.887	1.464	0.266	0.219	1.494	0.281	0.266	1.576	0.322	0.285
15/16	0.938	0.970	0.950	1.560	0.281	0.234	1.594	0.298	0.284	1.688	0.345	0.308
1	1.000	1.042	1.017	1.661	0.297	0.250	1.705	0.319	0.306	1.799	0.366	0.330
1 1/16	1.062	1.107	1.080	1.756	0.312	0.266	1.808	0.338	0.326	1.910	0.389	0.352
1 1/8	1.125	1.172	1.144	1.853	0.328	0.281	1.909	0.356	0.345	2.019	0.411	0.375
1 13/16	1.188	1.237	1.208	1.950	0.344	0.297	2.008	0.373	0.364	2.124	0.431	0.396
1 1/4	1.250	1.302	1.271	2.045	0.359	0.312	2.113	0.393	0.384	2.231	0.452	0.417
1 5/16	1.312	1.366	1.334	2.141	0.375	0.328	2.211	0.410	0.403	2.335	0.472	0.438
1 3/8	1.375	1.432	1.398	2.239	0.391	0.344	2.311	0.427	0.422	2.439	0.491	0.458
1 7/16	1.438	1.497	1.462	2.334	0.406	0.359	2.406	0.442	0.440	2.540	0.509	0.478
1 1/2	1.500	1.561	1.525	2.430	0.422	0.375	2.502	0.458	0.458	2.638	0.526	0.496

All dimensions are given in inches.

* Formerly designated Medium Helical Spring Lock Washers.

† Not recommended for new applications.

‡ Formerly designated Extra Heavy Helical Spring Lock Washers.

\varnothing The maximum outside diameters specified allow for the commercial tolerances on cold-drawn wire.

T \S = mean section thickness = $(t_i + t_o) \div 2$

Table 4. American National Standard Type A Plain Washers
Preferred Sizes ANSI B18.22.1-1965, R1975**

Nominal Washer Size***	Series	Inside Diameter			Outside Diameter			Thickness			
		Basic	Tolerance		Basic	Tolerance		Basic	Max.	Min.	
			Plus	Minus		Plus	Minus				
-	-	0.078	0.000	0.005	0.188	0.000	0.005	0.020	0.025	0.016	
-	-	0.094	0.000	0.005	0.250	0.000	0.005	0.020	0.025	0.016	
-	-	0.125	0.008	0.005	0.312	0.008	0.005	0.032	0.040	0.025	
No. 6	0.138	0.156	0.008	0.005	0.375	0.015	0.005	0.049	0.065	0.036	
No. 8	0.164	0.188	0.008	0.005	0.438	0.015	0.005	0.049	0.065	0.036	
No. 10	0.190	0.219	0.008	0.005	0.500	0.015	0.005	0.049	0.065	0.036	
3/16	0.188	0.250	0.015	0.005	0.562	0.015	0.005	0.049	0.065	0.036	
No. 12	0.216	0.250	0.015	0.005	0.562	0.015	0.005	0.065	0.080	0.051	
1/4	0.250	N	0.281	0.015	0.005	0.625	0.015	0.005	0.065	0.080	0.051
1/4	0.250	W	0.312	0.015	0.005	0.734*	0.015	0.007	0.065	0.080	0.051
5/16	0.312	N	0.344	0.015	0.005	0.688	0.015	0.007	0.065	0.080	0.051
5/16	0.312	W	0.375	0.015	0.005	0.875	0.030	0.007	0.083	0.104	0.064
3/8	0.375	N	0.406	0.015	0.005	0.812	0.015	0.007	0.065	0.080	0.051
3/8	0.375	W	0.438	0.015	0.005	1.000	0.030	0.007	0.083	0.104	0.064
7/16	0.438	N	0.469	0.015	0.005	0.922	0.015	0.007	0.065	0.080	0.051
7/16	0.438	W	0.500	0.015	0.005	1.250	0.030	0.007	0.083	0.104	0.064
1/2	0.500	N	0.531	0.015	0.005	1.062	0.030	0.007	0.095	0.121	0.074
1/2	0.500	W	0.562	0.015	0.005	1.375	0.030	0.007	0.109	0.132	0.086
9/16	0.562	N	0.594	0.015	0.005	1.156*	0.030	0.007	0.095	0.121	0.074
9/16	0.562	W	0.625	0.015	0.005	1.469*	0.030	0.007	0.109	0.132	0.086
5/8	0.625	N	0.656	0.030	0.007	1.312	0.030	0.007	0.095	0.121	0.074
5/8	0.625	W	0.688	0.030	0.007	1.750	0.030	0.007	0.134	0.160	0.108
3/4	0.750	N	0.812	0.030	0.007	1.469	0.030	0.007	0.134	0.160	0.108
3/4	0.750	W	0.812	0.030	0.007	2.000	0.030	0.007	0.148	0.177	0.122
7/8	0.875	N	0.938	0.030	0.007	1.750	0.030	0.007	0.134	0.160	0.108
7/8	0.875	W	0.938	0.030	0.007	2.250	0.030	0.007	0.165	0.192	0.136
1	1.000	N	1.062	0.030	0.007	2.000	0.030	0.007	0.134	0.160	0.108
1	1.000	W	1.062	0.030	0.007	2.500	0.030	0.007	0.165	0.192	0.136
1 1/8	1.125	N	1.250	0.030	0.007	2.250	0.030	0.007	0.134	0.160	0.108
1 1/8	1.125	W	1.250	0.030	0.007	2.750	0.030	0.007	0.165	0.192	0.136
1 1/4	1.250	N	1.375	0.030	0.007	2.500	0.030	0.007	0.165	0.192	0.136
1 1/4	1.250	W	1.375	0.030	0.007	3.000	0.030	0.007	0.165	0.192	0.136
1 3/8	1.375	N	1.500	0.030	0.007	2.750	0.030	0.007	0.165	0.192	0.136
1 3/8	1.375	W	1.500	0.045	0.010	3.250	0.045	0.010	0.180	0.213	0.153
1 1/2	1.500	N	1.625	0.030	0.007	3.000	0.030	0.007	0.165	0.192	0.136
1 1/2	1.500	W	1.625	0.045	0.010	3.500	0.045	0.010	0.180	0.213	0.153
1 5/8	1.625		1.750	0.045	0.010	3.750	0.045	0.010	0.180	0.213	0.153
1 3/4	1.750		1.875	0.045	0.010	4.000	0.045	0.010	0.180	0.213	0.153
1 7/8	1.875		2.000	0.045	0.010	4.250	0.045	0.010	0.180	0.213	0.153
2	2.000		2.125	0.045	0.010	4.500	0.045	0.010	0.180	0.213	0.153
2 1/4	2.250		2.375	0.045	0.010	4.750	0.045	0.010	0.220	0.248	0.193
2 1/2	2.500		2.625	0.045	0.010	5.000	0.045	0.010	0.238	0.280	0.210
2 3/4	2.750		2.875	0.065	0.010	5.250	0.065	0.010	0.259	0.310	0.228
3	3.000		3.125	0.065	0.010	5.500	0.065	0.010	0.284	0.327	0.249

All dimensions are in inches.

* The 0.734-inch, 1.156-inch, and 1.469-inch outside diameters avoid washers which could be used in coin operated devices.

** Preferred sizes are for the most part from series previously designated "Standard Plate" and "SAE." Where common sizes existed in the two series, the SAE size is designated "N" (narrow) and the Standard Plate "W" (wide). These sizes as well as all other sizes of Type A Plain Washers are to be ordered by ID, OD, and thickness dimensions.

*** Nominal washer sizes are intended for use with comparable nominal screw or bolt sizes.

Table 5. Machinability
Surface Cutting Speeds

Surface cutting speeds given below are approximate and are intended as a guide in calculating the proper speed for the part in hand. The figures are average for the general run of parts and are based on the use of high speed cutting tools. Any extraordinary features in the part to be made should be taken into consideration and speeds altered accordingly.

For the carbon and alloy grades listed, the figures are based on cold drawn bars in the as-drawn condition, except when it is noted that the grade is annealed.

Surface cutting speeds for hot rolled as-rolled bars and hot rolled heat treated bars are not available, since the machining qualities of these bars vary according to hardness, microstructure, condition of the surface, etc.

For the stainless steels and super alloys listed, all grades are annealed or solution annealed except where otherwise indicated.

CARBON STEELS			ALLOY STEELS		
Grade	Surface Feet per Minute	Rating*	Grade	Surface Feet per Minute	Rating*
1015	120	72%	2355 Ann.	115	70%
1018	130	78%	4130 Ann.	120	72%
1020	120	72%	4140 Ann.	110	66%
1022	130	78%	4142 Ann.	110	66%
1030	115	70%	41L42 Ann.	127	77%
1040	105	64%	4150 Ann.	100	60%
1042	105	64%	4150 Resul. Heat Treat	65	40%
1050	90	54%	4330 Mod. Ann.	95	59%
1095	70	42%	4340 Ann.	95	57%
1117	150	91%	4340 Mod. (300M) Ann.	95	57%
1137	120	72%	4620	110	66%
1141	115	70%	4820 Ann.	80	49%
1141 Ann.	135	81%	52100 Ann.	65	40%
1144	125	76%	6150 Ann.	100	60%
1144 Ann.	140	85%	8620	110	66%
1212	165	100%	86L20	127	77%
1213	225	136%	9310 Ann.	85	51%
12L14	280	170%	D6AC Ann.	50	30%
1215	225	136%	"e.t.d." 150	125	75%
1144 Hi Stress	130	79%	H-11 Ann.	49	29%
Stressproof	140	83%	HS 220-18 Ann.	85	51%
Fatigue-proof	134	80%	Nitriding #3 135 Mod. Ann.	76	45%
Leaded Grade A	325	193%			
Ledloy A, La-Led	325	193%			
Leaded Grade AX,AY,AZ	420	250%			
Ledloy AZ, La-Led X	420	250%			
STAINLESS & SUPER ALLOYS					
Grade	Surface Feet per Minute	Rating"	Grade	Surface Feet per Minute	Rating"
302	75	45%	431	75	45%
303	130	78%	440A	75	45%
303MA	135	82%	440B&C	65	40%
304	75	45%	15-5 Condition A	80	48%
304L	75	45%	Condition H1150	90	55%
316	75	45%	Condition H1150M	125	76%
321	60	36%	17-4 Condition A	80	48%
347	60	36%	Nitronic 50 (22-13-5)	50	21%
410	90	54%	A286 Aged	55	33%
416	180	110%	Hastelloy X	32	19%
420	75	45%	Maraging 18 Ni 250	50	30%
430	90	54%			
430F	150	91%			

*"Rating" refers to relative speed, base on 1212 as 100%.

Table 6. Hardness Conversion Numbers for Steel

BRINELL 3000 kg. Load 10 mm. Ball		ROCKWELL				SHORE SCLERO- SCOPE	TENSILE STRENGTH psi (Approx.)
Diameter Milli- meters	Hardness Number	A Scale	B Scale	C Scale	15-N Scale		
2.25	745	84.1	-	65.3	92.3	91	-
2.30	712	-	-	-	-	-	-
2.35	682	82.2	-	61.7	91.0	84	-
2.40	653	81.2	-	60.0	90.2	81	-
2.45	627	80.5	-	58.7	89.6	79	-
2.50	601	79.8	-	57.3	89.0	77	-
2.55	578	79.1	-	56.0	88.4	75	-
2.60	555	78.4	-	54.7	87.8	73	298000
2.65	534	77.8	-	53.5	87.2	71	288000
2.70	514	76.9	-	52.1	86.5	70	274000
2.75	495	76.3	-	51.0	85.9	68	264000
2.80	477	75.6	-	49.6	85.3	66	252000
2.85	461	74.9	-	48.5	84.7	65	242000
2.90	444	74.2	-	47.1	84.0	63	230000
2.95	429	73.4	-	45.7	83.4	61	219000
3.00	415	72.8	-	44.5	82.8	59	212000
3.05	401	72.0	-	43.1	82.0	58	202000
3.10	388	71.4	-	41.8	81.4	56	193000
3.15	375	70.6	-	40.4	80.6	54	184000
3.20	363	70.0	-	39.1	80.0	52	177000
3.25	352	69.3	110.0	37.9	79.3	51	170000
3.30	341	68.7	109.0	36.6	78.6	50	163000
3.35	331	68.1	108.5	35.5	78.0	48	158000
3.40	321	67.5	108.0	34.3	77.3	47	152000
3.45	311	66.9	107.5	33.1	76.7	46	147000
3.50	302	66.3	107.0	32.1	76.1	45	143000
3.55	293	65.7	106.0	30.9	75.5	43	139000
3.60	285	65.3	105.5	29.9	75.0	-	136000
3.65	277	64.6	104.5	28.8	74.4	41	131000
3.70	269	64.1	104.0	27.6	73.7	40	128000
3.75	262	63.6	103.0	26.6	73.1	39	125000
3.80	255	63.0	102.0	25.4	72.5	38	121000
3.85	248	62.5	101.0	24.2	71.7	37	118000
3.90	241	61.8	100.0	22.8	70.9	36	114000
3.95	235	61.4	99.0	21.7	70.3	35	111000
4.00	229	60.8	98.2	20.5	69.7	34	109000
4.05	223	-	97.3	18.8	-	-	104000
4.10	217	-	96.4	17.5	-	33	103000
4.15	212	-	95.5	16.0	-	-	100000
4.20	207	-	94.6	15.2	-	32	99000
4.25	201	-	93.8	13.8	-	31	97000
4.30	197	-	92.8	12.7	-	30	94000
4.35	192	-	91.9	11.5	-	29	92000
4.40	187	-	90.7	10.0	-	-	90000
4.45	183	-	90.0	9.0	-	28	89000
4.50	179	-	89.0	8.0	-	27	88000
4.55	174	-	87.8	6.4	-	-	86000
4.60	170	-	86.8	5.4	-	26	84000
4.65	167	-	86.0	4.4	-	-	83000
4.70	163	-	85.0	3.3	-	25	82000
4.80	156	-	82.9	0.9	-	-	80000
4.90	149	-	80.8	-	-	23	-
5.00	143	-	78.7	-	-	22	-
5.10	137	-	76.4	-	-	21	-
5.20	131	-	74.0	-	-	-	-
5.30	126	-	72.0	-	-	20	-
5.40	121	-	69.8	-	-	19	-
5.50	116	-	67.6	-	-	18	-
5.60	111	-	65.7	-	-	15	-

ROCKWELL							BRINELL 500 kg. Load 10 mm. Ball
B Scale Scale	F Scale	15-T Scale	30-T Scale	E Scale	H Scale	A Scale	
74	99.0	-	66.0	-	-	46.0	118
72	98.0	84.0	65.0	-	-	45.0	114
70	97.0	83.5	63.5	99.5	-	44.0	110
68	95.5	-	62.0	98.0	-	43.0	107
66	94.5	82.0	60.5	97.0	-	42.0	104
64	93.5	81.5	59.5	95.5	-	41.5	101
62	92.0	-	58.0	94.5	-	40.5	98
60	91.0	-	56.5	93.0	-	39.5	95
58	90.0	79.5	55.0	92.0	-	38.5	92
56	89.0	79.0	54.0	90.5	-	-	90
54	87.5	-	52.5	89.5	-	37.0	87
52	86.5	77.5	51.0	88.0	-	36.0	85
50	85.5	77.0	49.5	87.0	-	35.0	83
48	84.5	-	48.5	85.5	-	34.5	81
46	83.0	75.5	47.0	84.5	-	33.5	-
44	82.0	75.0	45.5	83.5	-	32.5	78
42	81.0	-	44.0	82.0	-	31.5	76
40	79.5	73.5	43.0	81.0	-	-	-
38	78.5	73.0	41.5	79.5	-	30.0	73
36	77.5	-	40.0	78.5	100.0	29.0	-
34	76.5	71.5	38.5	77.0	99.0	28.0	70
32	75.0	71.0	37.5	76.0	98.5	27.5	-
30	74.0	70.5	36.0	75.0	-	26.5	67
28	73.0	-	34.5	73.5	97.0	25.5	66
26	72.0	69.0	33.0	72.5	-	24.5	65
24	70.5	68.5	32.0	71.0	95.5	24.0	-
22	69.5	-	30.5	70.0	95.0	23.0	-
20	68.5	-	29.0	68.5	-	22.0	-
18	67.0	66.5	27.5	67.5	93.5	-	-
16	66.0	66.0	26.0	66.5	-	20.5	-
14	65.0	-	25.0	65.0	92.0	-	-
12	64.0	64.5	23.5	64.0	91.5	-	-
10	63.0	64.0	22.0	62.5	90.5	-	57
8	61.5	63.5	20.5	61.5	90.0	-	-
6	60.5	-	19.5	60.5	-	-	-
4	59.5	62.0	18.0	59.0	88.5	-	-
2	58.0	61.5	16.5	58.0	-	-	54
0	57.0	-	15.0	57.0	87.0	-	53

ROCKWELL HARDNESS SCALES

Scale	Major Load, Kg.	Indenter	Use of Scale
A	60	Diamond cone	Extremely hard material such as tungsten carbide or hard sheet material too thin for heavy load.
B	100	1/16" ball	Materials of B 0 to B 100 hardness.
C	150	Diamond cone	Materials of C 20 to C 70 hardness.
E	100	1/8" ball	Very soft materials such as bearing metals.
F	60	1/16" ball	Very soft materials such as bearing metals.
H	60	1/8" ball	Very soft materials such as bearing metals.
ROCKWELL SUPERFICIAL HARDNESS SCALES			
15-N	15	Diamond cone	Materials comparable in hardness of C 20 to C 70.
15-T	15	1/16" ball	Materials comparable in hardness of B 0 to B 100.
30-T	30	1/16" ball	Materials comparable in hardness of B 0 to B 100.

Table 7. Sheet Gauges

Gauge No.	STEEL SHEETS		GALVANIZED SHEETS		STAINLESS STEEL SHEETS			ALUMINUM SHEETS	
	Weight Lbs. Per Square Foot	Thickness in Inches	Weight Lbs. per Square Fit	Thickness in Inches	Wt., Lbs. per Sq. Ft.		Approx. Thickness in lathes	Weight Lbs. per Sq. Ft. (1100)	Thickness in Inches
					Straight Chromium (400 Series)	Chromium Nickel (300 Series)			
38	.25000	.0060						.0558	.0039
37	.26562	.0064						.0627	.0044
36	.28125	.0067						.0705	.00500
35	.31250	.0075						.0791	.0056
34	.34375	.0082						.0888	.00630
33	.37500	.0090						.0998	.00701
32	.40625	.0097	.56250	.0134	.3708	.3780	.010	.1121	.00795
31	.43750	.0105	.59375	.0142	.4506	.4594	.011	.1259	.00893
30	.50000	.0120	.65625	.0157	.5150	.5250	.013	.1410	.0100
29	.56250	.0135	.71875	.0172	.5794	.5906	.014	.1593	.0113
28	.62500	.0149	.78125	.0187	.6438	.6562	.016	.1777	.0126
27	.68750	.0164	.84375	.0202	.7081	.7218	.017	.2002	.0142
26	.75000	.0179	.90625	.0217	.7725	.7875	.019	.2242	.0159
25	.87500	.0209	1.03125	.0247	.9013	.9187	.022	.2524	.0179
24	1.0000	.0239	1.15625	.0276	1.0300	1.0500	.025	.2834	.0201
23	1.1250	.0269	1.28125	.0306	1.1587	1.1813	.028	.3187	.0226
22	1.2500	.0299	1.40625	.0336	1.2875	1.3125	.031	.3567	.0253
21	1.3750	.0329	1.53125	.0366	1.4160	1.4437	.034	.4019	.0285
20	1.5000	.0359	1.65625	.0396	1.5450	1.5750	.038	.4512	.0320
19	1.7500	.0418	1.90625	.0456	1.8025	1.8375	.044	.5062	.0359
18	2.0000	.0478	2.15625	.0516	2.0600	2.1000	.050	.5682	.0403
17	2.2500	.0538	2.40625	.0575	2.3175	2.3625	.056	.6387	.0453
16	2.5000	.0598	2.65625	.0635	2.5750	2.6250	.063	.7163	.0508
15	2.8125	.0673	2.96875	.0710	2.8968	2.9531	.070	.8051	.0571
14	3.1250	.0747	3.28125	.0785	3.2187	3.2812	.078	.9038	.0641
13	3.7500	.0897	3.90625	.0934	3.8625	3.9375	.094	1.015	.0720
12	4.3750	.1046	4.53125	.1084	4.5063	4.5937	.109	1.139	.0808
11	5.0000	.1196	5.15625	.1233	5.1500	5.2500	.125	1.279	.0907
10	5.6250	.1345	5.78125	.1382	5.7937	5.9062	.141	1.437	.1019
9	6.2500	.1495	6.40625	.1532	6.4375	6.5625	.156	1.613	.1144
8	6.8750	.1644	7.03125	.1681	7.0813	7.2187	.172	1.812	.1285
7	7.5000	.1793						2.035	.1443
6	8.1250	.1943						2.284	.1620
5	8.7500	.2092						2.565	.1819
4	9.3750	.2242						2.881	.2043
3	10.000	.2391						3.235	.2294

Table 8. Millimeters Converted to Decimal and Fractional Inches

Milli-meters	Fractional Decimal Inches	Inches (to nearest 64th)	Milli-Meters	Fractional Decimal Inches	Inches (to nearest 64th)	Milli-meters	Fractional Decimal Inches	Inches (to nearest 64th)
1	.0394	3/64	34	1.339	1 11/32	67	2.638	2 41/64
2	.0787	5/64	35	1.378	1 3/8	68	2.677	2 43/64
3	.1181	1/6	36	1.417	1 27/64	69	2.717	2 23/32
4	.1575	5/32	37	1.457	1 29/64	70	2.756	2 3/4
5	.1969	13/64	38	1.496	1 1/2	71	2.795	2 51/64
6	.2362	15/64	39	1.535	1 17/32	72	2.835	2 53/64
7	.2756	9/32	40	1.575	1 37/64	73	2.874	2 7/8
8	.3150	5/16	41	1.614	1 39/64	74	2.913	2 29/32
9	.3543	23/64	42	1.654	1 21/32	75	2.953	2 61/64
10	.3937	26/64	43	1.693	1 11/16	76	2.992	2 63/64
11	.4331	7/16	44	1.732	1 47/64	77	3.031	3 1/32
12	.4724	15/32	45	1.772	1 49/64	78	3.071	3 5/64
13	.5118	33/64	46	1.811	1 13/16	79	3.110	3 7/64
14	.5512	35/64	47	1.850	1 27/32	80	3.150	3 5/32
15	.5906	19/32	48	1.890	1 57/64	81	3.189	3 3/16
16	.6299	5/8	49	1.929	1 59/64	82	3.228	3 15/64
17	.6693	43/64	50	1.969	1 31/32	83	3.268	3 17/64
18	.7087	45/64	51	2.008	2 1/64	84	3.307	3 5/16
19	.7480	3/4	52	2.047	2 3/64	85	3.346	3 11/32
20	.7874	25/32	53	2.087	2 3/32	86	3.386	3 25/64
21	.8268	53/64	54	2.126	2 1/8	87	3.425	3 27/64
22	.8661	55/64	55	2.165	2 11/64	88	3.465	3 15/32
23	.9055	29/32	56	2.205	2 13/64	89	3.504	3 1/2
24	.9449	15/16	57	2.244	2 1/4	90	3.543	3 35/64
25	.9843	63/64	58	2.283	2 9/32	91	3.583	3 37/64
26	1.024	1 1/32	59	2.323	2 21/64	92	3.622	3 5/8
27	1.063	1 1/16	60	2.362	2 23/64	93	3.661	3 21/32
28	1.102	1 7/64	61	2.402	2 13/32	94	3.701	3 45/64
29	1.142	1 9/64	62	2.441	2 7/16	95	3.740	3 47/64
30	1.181	1 3/16	63	2.480	2 31/64	96	3.780	3 25/32
31	1.220	1 7/32	64	2.520	2 33/64	97	3.819	3 13/16
32	1.260	1 17/64	65	2.559	2 9/16	98	3.858	3 55/64
33	1.299	1 19/64	66	2.598	2 19/32	99	3.898	3 57/64
						100	3.937	3 15/16

Table 9. Conversion Factors

Acceleration	1 m/s ²	= 4.252 x 10 ⁷ ft/h ²
Area	1 m ²	= 1550.0 in ²
		= 10.764 ft ²
Degree (angle)	1 radian	= 57.471 degree
Energy	1 J	= 9.4787 x 10 ⁻⁴ Btu
	1 kcal	= 3.968 Btu
Force	1 N	= .22481 lbf
Heat Flux	1 W/m ²	= .3171 Btu/h•ft ²
Heat Transfer Coefficient	1 W/m ² •K	= 0.17612 Btu/h•ft ² •°F
Heat Transfer Rate	1 W	= 3.4123 Btu/h
Length	1 m	= 39.370 in
		= 3.2808 ft
Mass	1 kg	= 2.2046 lbm
	1 lbm	= 16 oz
Mass Density	1 kg/m ³	= .062428 lbm/ft ³
Pressure and Stress	1 N/m ²	= .020886 lbf/ft ²
		= 1.4504 x 10 ⁻⁴ lbf/in ²
		= 4.015 x 10 ⁻³ inH ₂ O
		= 2.953 x 10 ⁻⁴ inHg
		= 1 standard atmosphere
	1.1033 x 10 ⁵ N/m ²	= 1 bar
	1 x 10 ⁵ N/m ²	= 1 bar
Temperature	1 K	= (5/9) °R
		= (5/9)(°F + 459.67)
		= °C + 273.15
Temperature Difference	1 K	= 1 °C
		= (9/5) °R = (9/5)°F
Thermal Conductivity	1 W/m•K	= .57782 Btu/h•ft•°F
Thermal Resistance	1 K/W	= .52750 °F/h•Btu
Volume	1 m ³	= 6.1023 x 10 ⁴ in ³
		= 35.314 ft ³
		= 264.17 gal
Volume Flow Rate	1 m ³ /s	= 1.2713 x 10 ⁵ ft ³ /h
		= 2.1189 x 10 ³ ft ³ /min
		= 1.5850 x 10 ⁴ gal/min

DSCC Specification	Calmark Series
83023	Series 103, 104, 105 and 107 (plastic)
84103	Series 225, 230, 240
84191	Series 109
85034	Series 125/126, 165/166, NW125/NW126, NW165/NW166
89024	Series 260
89064	Series 226, 231
AA59590/18	Series 245
AA59590/1	Series L225
AA59590/2	Series E225
AA59590/3	Series V225
AA59590/4	Series 225
AA59590/5	Series 225
AA59590/6	Series V225
AA59590/7	Series 230
AA59590/10	Series V230
AA59590/11	Series V240
AA59590/12	Series 240
AA59590/13	Series 250
AA59590/14	Series V250
AA59590/15	Series 250
AA59590/16	Series V250
AA59590/17	Series 245
AA59590/18	Series V245
AA59590/19	Series 245
AA59590/20	Series V245
AA59590/21	Series 255
AA59590/22	Series V255
AA59590/23	Series 255
AA59590/24	Series V255
AA59590/25	Series VE225
AA59789/1	Series 226
AA59789/2	Series V226
AA59789/3	Series 231
AA59789/4	Series V231
AA59789/5	Series L260
AA59789/6	Series LE260
AA59789/7	Series 267
AA59789/8	Series V267
AA59789/9	Series 265
AA59789/10	Series V265

Beryllium Copper - A metal alloy consisting principally of copper with a small amount of Beryllium (usually 1%-2%)

Board Module Assembly - A mechanical structure that supports a plug-in unit, like a power supply, radio or CCA, etc.

Board Mount - Where the device is mounted onto the PC board

Card-Lok - PC board retainer using wedge configuration to provide a locking force

Card Retainer - A device that securely holds a PCB or Board Module Assembly in a chassis

CCA - A Conduction Cooled Assembly consisting of a conduction frame, extractors, wedge clamps and backing plate or strip that is mounted to a Plug-In Unit for structural and thermal performance enhancement

Chassis Mount - Where the device is mounted directly onto the chassis or cold wall

Cold Wall or Cold Plate - The portion of the chassis that sinks heat away from the card to the environment

Conduction - A mode of heat transfer in a stationary medium

Contact Intimacy - Direct PCB or Board Module Assembly contact with the cold wall for maximum heat dissipation

DSCC - Defense Supply Center Columbus
(For 5998 documents)
Attn: DSCC-VAC, PO Box 3990
Columbus, OH 43215-5000
Tel: 614-692-0562 Fax: 614-692-6939
E-mail: 5998_Documents@dsccl.dta.mil

Datum - The starting point (zero) for dimensioning a part

Extractor - Hardware used to disengage PCB or Board Module Assembly from backplate interconnects

Insertor - Hardware to assist insertion of PC board into backplane interconnects

Lever Actuated - A means to activate a Card-Lok without tools required

Normal Force - Force acting perpendicular to the long axis of a PCB retainer such as a Wedge-Lok™

Plug-in Unit - A generic description of an assembly usually consisting of a PCB with connectors and may optionally have extractors and covers

PCB - Printed Circuit Board

PC - Printed Circuit

Retention Force - The force required to move a locked PC board that is not connected to a backplane; unit: lbs. or oz.

Shock - A violent impact

Thermal Grease - A compound that reduces thermal resistance at interfaces

Thermal Resistance - Resistance to the flow of heat usually measured as a temperature drop across an interface; units: °C per Watt per inch

Thermal Transfer - The passage of heat from PC board to chassis or heat sink

Thermocouple - A sensor that measures temperature

Torque - A measure of rotational force; Units: Newton-meters, Newton-centimeters, inch-lbs or inch-oz.

Vibration - Quick motion to and fro; oscillatory

Zero Entry Force - No force is required to insert or extract a board into or out of a card guide or channel

X-ON Electronics

Largest Supplier of Electrical and Electronic Components

Click to view similar products for [Schroff](#) manufacturer:

Other Similar products are found below :

[13100103](#) [21006-945](#) [24563-157](#) [24827-024](#) [20848-487](#) [24566-125](#) [34561-198](#) [60817097](#) [60817071](#) [60807211](#) [60817072](#) [60817054](#)
[64560010](#) [14575271](#) [14576145](#) [14575265](#) [20117-156](#) [20817772](#) [20846211](#) [20860229](#) [21100777](#) [23022602](#) [23130082](#) [24571331](#) [24571586](#)
[24572066](#) [24822075](#) [26230-374](#) [30817-001](#) [30825080](#) [20849021](#) [21100359](#) [23001021](#) [24571303](#) [24572054](#) [34560489](#) [21006959](#) [20860-](#)
[624](#) [20860-611](#) [20848496](#) [20838-111](#) [20838-116](#) [20860-612](#) [20860-628](#) [20860-633](#) [10225-602](#) [14826207](#) [10828058](#) [13100105](#) [13100136](#)