

Cree® XLamp® XT-E LEDs

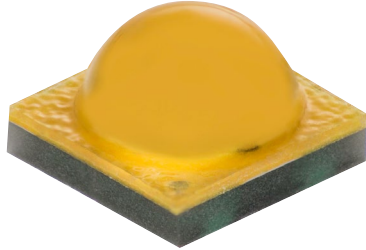

XT-E White

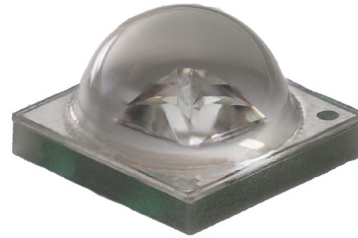

XT-E Royal Blue

PRODUCT DESCRIPTION

Optimized for directional, high-lumen applications, from indoor and outdoor to portable and lamp retrofits, the XLamp® XT-E LED delivers high performance and high reliability in the industry-standard XP/XT footprint. The XT-E LED offers the benefits of the XT/XP platform – compact and proven 3.45 mm x 3.45 mm package and established ecosystem – enabling lighting manufacturers to simplify the design process and shorten time to market.

The XT-E LED is available in royal blue and white. The XT-E White LED offers a high-efficiency option. In this document, the term White denotes the white XT-E LED without regard to its efficacy. The terms Standard and High Efficacy are used when necessary to differentiate the performance of the High Efficacy XT-E LED from the XT-E LED without the high-efficiency option.

FEATURES

- Maximum Vf for High Efficacy XT-E White: 2.85 V
- Available in 70-, 80- and 90-CRI minimum white
- Binned at 85 °C
- Available in 2200 K CCT
- Thermal resistance: 5 °C/W
- Wide viewing angle: 115°-140°
- Maximum drive current: White 1.5 A, Royal Blue 1.5 A
- Electrically neutral thermal path
- Vf binning supported for XT-E White and Royal Blue
- XT-E Royal Blue sorted into 2.5-nm-wavelength bins
- Unlimited floor life at ≤ 30 °C/85% RH
- Reflow solderable - JEDEC J-STD-020C compatible
- RoHS and REACH compliant
- UL® recognized component (E349212)



NOTE: For remote phosphor applications, a separate license to certain Cree patents is required.

TABLE OF CONTENTS

| | |
|--|----|
| Characteristics | 3 |
| Flux Characteristics - White, Standard..... | 4 |
| Flux Characteristics - White, High Efficacy | 15 |
| Flux Characteristics - Royal Blue..... | 20 |
| Relative Spectral Power Distribution - White..... | 21 |
| Relative Spectral Power Distribution - Royal Blue..... | 21 |
| Relative Luminous Flux vs. Junction Temperature - White | 22 |
| Relative Radiant Flux vs. Junction Temperature - Royal Blue | 22 |
| Electrical Characteristics - White, Standard, Royal Blue..... | 23 |
| Electrical Characteristics - White, High Efficacy | 23 |
| Relative Luminous Flux vs. Current - White..... | 24 |
| Relative Radiant Flux vs. Current - Royal Blue..... | 24 |
| Relative Chromaticity vs. Current and Temperature | 25 |
| Typical Spatial Distribution - White | 26 |
| Typical Spatial Distribution - Royal Blue | 26 |
| Thermal Design - White | 27 |
| Thermal Design - Royal Blue..... | 27 |
| Performance Groups - Luminous Flux..... | 28 |
| Performance Groups - Radiant Flux..... | 28 |
| Performance Groups - Dominant Wavelength | 29 |
| Performance Groups - Forward Voltage..... | 29 |
| Performance Groups - Chromaticity | 29 |
| Cree's White Chromaticity Regions Plotted on the CIE 1931 Curve..... | 33 |
| Cree's Cool White Kits Plotted on ANSI Standard Chromaticity Regions..... | 34 |
| Cree's White Kits Plotted on ANSI Standard Chromaticity Regions..... | 35 |
| Cree's Warm and Neutral White Kits Plotted on ANSI Standard Chromaticity Regions | 36 |
| Cree's 2200 K CCT White Kit Plotted on ANSI Standard Chromaticity Regions..... | 37 |
| Cree's Standard Chromaticity Kits | 37 |
| Bin and Order Code Formats | 38 |
| Reflow Soldering Characteristics..... | 39 |
| Notes | 40 |
| Mechanical Dimensions | 42 |
| Tape and Reel..... | 43 |
| Packaging..... | 44 |

CHARACTERISTICS

| Characteristics | Unit | Minimum | Typical | Maximum |
|--|---------|---------|---------|---------|
| Thermal resistance, junction to solder point | °C/W | | 5 | |
| Viewing angle (FWHM) - white | degrees | | 115 | |
| Viewing angle (FWHM) - royal blue | degrees | | 140 | |
| Temperature coefficient of voltage | mV/°C | | -2.5 | |
| ESD withstand voltage (HBM per Mil-Std-883D) | V | | | 8000 |
| DC forward current - white | mA | | | 1500 |
| DC forward current - royal blue | mA | | | 1500 |
| Reverse voltage | V | | | 5 |
| Forward voltage - white - Standard, royal blue (@ 350 mA, 85 °C) | V | | 2.85 | 3.1 |
| Forward voltage - white - High Efficacy (@ 350 mA, 85 °C) | V | | 2.77 | 2.85 |
| LED junction temperature | °C | | | 150 |

FLUX CHARACTERISTICS - WHITE, STANDARD (T_j = 85 °C)

The following tables provide order codes for Standard XLamp XT-E White LEDs. For a complete description of the order code nomenclature, please see the Bin and Order Code Formats section (page 38). For definitions of the chromaticity kits, please see the Cree's Standard Chromaticity Kits section (page 37).

| Chromaticity | | Minimum Luminous Flux (lm) @ 350 mA | | | Order Codes | | | | | |
|--------------|--------|-------------------------------------|-------------------|--------------------|--------------------------|---------------------------|----------------|---------------------------|----------------|----------------|
| Kit | CCT | Code | Flux (lm) @ 85 °C | Flux (lm) @ 25 °C* | No Minimum CRI | 70 CRI Minimum | 75 CRI Typical | 80 CRI Minimum | 85 CRI Minimum | 90 CRI Minimum |
| 51 | 6200 K | S3 | 156 | 171 | XTEAWT-00-0000-000000K51 | XTEAWT-00-0000-000000BK51 | | | | |
| | | S2 | 148 | 163 | XTEAWT-00-0000-000000J51 | XTEAWT-00-0000-000000BJ51 | | | | |
| | | R5 | 139 | 153 | XTEAWT-00-0000-000000H51 | XTEAWT-00-0000-000000BH51 | | XTEAWT-00-0000-000000HH51 | | |
| | | R4 | 130 | 143 | XTEAWT-00-0000-000000G51 | XTEAWT-00-0000-000000BG51 | | XTEAWT-00-0000-000000HG51 | | |
| | | R3 | 122 | 134 | XTEAWT-00-0000-000000F51 | XTEAWT-00-0000-000000BF51 | | XTEAWT-00-0000-000000HF51 | | |
| | | R2 | 114 | 125 | XTEAWT-00-0000-000000E51 | XTEAWT-00-0000-000000BE51 | | XTEAWT-00-0000-000000HE51 | | |
| | | Q5 | 107 | 118 | | | | XTEAWT-00-0000-000000HD51 | | |
| 53 | 6000 K | S3 | 156 | 171 | XTEAWT-00-0000-000000K53 | XTEAWT-00-0000-000000BK53 | | | | |
| | | S2 | 148 | 163 | XTEAWT-00-0000-000000J53 | XTEAWT-00-0000-000000BJ53 | | | | |
| | | R5 | 139 | 153 | XTEAWT-00-0000-000000H53 | XTEAWT-00-0000-000000BH53 | | XTEAWT-00-0000-000000HH53 | | |
| | | R4 | 130 | 143 | XTEAWT-00-0000-000000G53 | XTEAWT-00-0000-000000BG53 | | XTEAWT-00-0000-000000HG53 | | |
| | | R3 | 122 | 134 | XTEAWT-00-0000-000000F53 | XTEAWT-00-0000-000000BF53 | | XTEAWT-00-0000-000000HF53 | | |
| | | R2 | 114 | 125 | XTEAWT-00-0000-000000E53 | XTEAWT-00-0000-000000BE53 | | XTEAWT-00-0000-000000HE53 | | |
| | | Q5 | 107 | 118 | | | | XTEAWT-00-0000-000000HD53 | | |

Notes:

- Cree maintains a tolerance of $\pm 7\%$ on flux and power measurements, ± 0.005 on chromaticity (CCx, CCy) measurements and ± 2 on CRI measurements. See the Measurements section (page 40).
- Cree XLamp XT-E LED order codes specify only a minimum flux bin and not a maximum. Cree may ship reels in flux bins higher than the minimum specified by the order code without advance notice. Shipments will always adhere to the chromaticity or DWL bin restrictions specified by the order code.
- * Flux values @ 25 °C are calculated and for reference only.

FLUX CHARACTERISTICS - WHITE, STANDARD (T_j = 85 °C) - CONTINUED

| Chromaticity | | Minimum Luminous Flux (lm) @ 350 mA | | | Order Codes | | | | | |
|--------------|--------|-------------------------------------|-------------------|--------------------|--------------------------|---------------------------|----------------|---------------------------|----------------|----------------|
| Kit | CCT | Code | Flux (lm) @ 85 °C | Flux (lm) @ 25 °C* | No Minimum CRI | 70 CRI Minimum | 75 CRI Typical | 80 CRI Minimum | 85 CRI Minimum | 90 CRI Minimum |
| 50 | 6200 K | S3 | 156 | 171 | XTEAWT-00-0000-000000K50 | XTEAWT-00-0000-000000BK50 | | | | |
| | | S2 | 148 | 163 | XTEAWT-00-0000-000000J50 | XTEAWT-00-0000-000000BJ50 | | | | |
| | | R5 | 139 | 153 | XTEAWT-00-0000-000000H50 | XTEAWT-00-0000-000000BH50 | | XTEAWT-00-0000-000000HH50 | | |
| | | R4 | 130 | 143 | XTEAWT-00-0000-000000G50 | XTEAWT-00-0000-000000BG50 | | XTEAWT-00-0000-000000HG50 | | |
| | | R3 | 122 | 134 | XTEAWT-00-0000-000000F50 | XTEAWT-00-0000-000000BF50 | | XTEAWT-00-0000-000000HF50 | | |
| | | R2 | 114 | 125 | XTEAWT-00-0000-000000E50 | XTEAWT-00-0000-000000BE50 | | XTEAWT-00-0000-000000HE50 | | |
| | | Q5 | 107 | 118 | | | | XTEAWT-00-0000-000000HD50 | | |
| E1 | 6500 K | S3 | 156 | 171 | XTEAWT-00-0000-000000KE1 | XTEAWT-00-0000-000000BKE1 | | | | |
| | | S2 | 148 | 163 | XTEAWT-00-0000-000000JE1 | XTEAWT-00-0000-000000BJE1 | | | | |
| | | R5 | 139 | 153 | XTEAWT-00-0000-000000HE1 | XTEAWT-00-0000-000000BHE1 | | XTEAWT-00-0000-000000HHE1 | | |
| | | R4 | 130 | 143 | XTEAWT-00-0000-000000GE1 | XTEAWT-00-0000-000000BGE1 | | XTEAWT-00-0000-000000HGE1 | | |
| | | R3 | 122 | 134 | XTEAWT-00-0000-000000FE1 | XTEAWT-00-0000-000000BFE1 | | XTEAWT-00-0000-000000HFE1 | | |
| | | R2 | 114 | 125 | XTEAWT-00-0000-000000EE1 | XTEAWT-00-0000-000000BEE1 | | XTEAWT-00-0000-000000HEE1 | | |
| | | Q5 | 107 | 118 | | | | XTEAWT-00-0000-000000HDE1 | | |
| E2 | 5700 K | S3 | 156 | 171 | XTEAWT-00-0000-000000KE2 | XTEAWT-00-0000-000000BKE2 | | | | |
| | | S2 | 148 | 163 | XTEAWT-00-0000-000000JE2 | XTEAWT-00-0000-000000BJE2 | | | | |
| | | R5 | 139 | 153 | XTEAWT-00-0000-000000HE2 | XTEAWT-00-0000-000000BHE2 | | XTEAWT-00-0000-000000HHE2 | | |
| | | R4 | 130 | 143 | XTEAWT-00-0000-000000GE2 | XTEAWT-00-0000-000000BGE2 | | XTEAWT-00-0000-000000HGE2 | | |
| | | R3 | 122 | 134 | XTEAWT-00-0000-000000FE2 | XTEAWT-00-0000-000000BFE2 | | XTEAWT-00-0000-000000HFE2 | | |
| | | R2 | 114 | 125 | XTEAWT-00-0000-000000EE2 | XTEAWT-00-0000-000000BEE2 | | XTEAWT-00-0000-000000HEE2 | | |
| | | Q5 | 107 | 118 | | | | XTEAWT-00-0000-000000HDE2 | | |

Notes:

- Cree maintains a tolerance of $\pm 7\%$ on flux and power measurements, ± 0.005 on chromaticity (CCx, CCy) measurements and ± 2 on CRI measurements. See the Measurements section (page 40).
- Cree XLamp XT-E LED order codes specify only a minimum flux bin and not a maximum. Cree may ship reels in flux bins higher than the minimum specified by the order code without advance notice. Shipments will always adhere to the chromaticity or DWL bin restrictions specified by the order code.
- * Flux values @ 25 °C are calculated and for reference only.

FLUX CHARACTERISTICS - WHITE, STANDARD (T_j = 85 °C) - CONTINUED

| Chromaticity | | Minimum Luminous Flux (lm) @ 350 mA | | | Order Codes | | | | | | |
|--------------|--------|-------------------------------------|-------------------|--------------------|--------------------------|---------------------------|---------------------------|---------------------------|---------------------------|---------------------------|---------------------------|
| Kit | CCT | Code | Flux (lm) @ 85 °C | Flux (lm) @ 25 °C* | No Minimum CRI | 70 CRI Minimum | 75 CRI Typical | 80 CRI Minimum | 85 CRI Minimum | 90 CRI Minimum | |
| E3 | 5000 K | S3 | 156 | 171 | XTEAWT-00-0000-000000KE3 | XTEAWT-00-0000-000000BKE3 | | | | | |
| | | S2 | 148 | 163 | XTEAWT-00-0000-000000JE3 | XTEAWT-00-0000-000000BJE3 | XTEAWT-00-0000-000000LJE3 | | | | |
| | | R5 | 139 | 153 | XTEAWT-00-0000-000000HE3 | XTEAWT-00-0000-000000BHE3 | XTEAWT-00-0000-000000LHE3 | XTEAWT-00-0000-000000HHE3 | | | |
| | | R4 | 130 | 143 | XTEAWT-00-0000-000000GE3 | XTEAWT-00-0000-000000BGE3 | XTEAWT-00-0000-000000LGE3 | XTEAWT-00-0000-000000HGE3 | | | |
| | | R3 | 122 | 134 | XTEAWT-00-0000-000000FE3 | XTEAWT-00-0000-000000BFE3 | XTEAWT-00-0000-000000LFE3 | XTEAWT-00-0000-000000HFE3 | | | |
| | | R2 | 114 | 125 | XTEAWT-00-0000-000000EE3 | XTEAWT-00-0000-000000BEE3 | XTEAWT-00-0000-000000LEE3 | XTEAWT-00-0000-000000HEE3 | | | |
| | | Q5 | 107 | 118 | | | | | XTEAWT-00-0000-000000HDE3 | XTEAWT-00-0000-000000PDE3 | XTEAWT-00-0000-000000UDE3 |
| | | Q4 | 100 | 110 | | | | | | XTEAWT-00-0000-000000PCE3 | XTEAWT-00-0000-000000UCE3 |
| | | Q3 | 93.9 | 103 | | | | | | XTEAWT-00-0000-000000PBE3 | XTEAWT-00-0000-000000UBE3 |
| | | Q2 | 87.4 | 96.1 | | | | | | XTEAWT-00-0000-000000PAE3 | XTEAWT-00-0000-000000UAE3 |
| C1 | 5000 K | S3 | 156 | 171 | XTEAWT-00-0000-000000KC1 | XTEAWT-00-0000-000000BKC1 | | | | | |
| | | S2 | 148 | 163 | XTEAWT-00-0000-000000JC1 | XTEAWT-00-0000-000000BJC1 | XTEAWT-00-0000-000000LJC1 | | | | |
| | | R5 | 139 | 153 | XTEAWT-00-0000-000000HC1 | XTEAWT-00-0000-000000BHC1 | XTEAWT-00-0000-000000LHC1 | | | | |
| | | R4 | 130 | 143 | XTEAWT-00-0000-000000GC1 | XTEAWT-00-0000-000000BGC1 | XTEAWT-00-0000-000000LGC1 | | | | |
| | | R3 | 122 | 134 | XTEAWT-00-0000-000000FC1 | XTEAWT-00-0000-000000BFC1 | XTEAWT-00-0000-000000LFC1 | | | | |
| | | R2 | 114 | 125 | XTEAWT-00-0000-000000EC1 | XTEAWT-00-0000-000000BEC1 | XTEAWT-00-0000-000000LEC1 | | | | |

Notes:

- Cree maintains a tolerance of $\pm 7\%$ on flux and power measurements, ± 0.005 on chromaticity (CCx, CCy) measurements and ± 2 on CRI measurements. See the Measurements section (page 40).
- Cree XLamp XT-E LED order codes specify only a minimum flux bin and not a maximum. Cree may ship reels in flux bins higher than the minimum specified by the order code without advance notice. Shipments will always adhere to the chromaticity or DWL bin restrictions specified by the order code.
- * Flux values @ 25 °C are calculated and for reference only.

FLUX CHARACTERISTICS - WHITE, STANDARD (T_j = 85 °C) - CONTINUED

| Chromaticity | | Minimum Luminous Flux (lm) @ 350 mA | | | Order Codes | | | | | |
|--------------|--------|-------------------------------------|-------------------|--------------------|--------------------------|---------------------------|---------------------------|---------------------------|---------------------------|---------------------------|
| Kit | CCT | Code | Flux (lm) @ 85 °C | Flux (lm) @ 25 °C* | No Minimum CRI | 70 CRI Minimum | 75 CRI Typical | 80 CRI Minimum | 85 CRI Minimum | 90 CRI Minimum |
| F4 | 4750 K | S3 | 156 | 171 | XTEAWT-00-0000-000000KF4 | XTEAWT-00-0000-000000BKF4 | | | | |
| | | S2 | 148 | 163 | XTEAWT-00-0000-000000JF4 | XTEAWT-00-0000-000000BJF4 | XTEAWT-00-0000-000000LJF4 | | | |
| | | R5 | 139 | 153 | XTEAWT-00-0000-000000HF4 | XTEAWT-00-0000-000000BHF4 | XTEAWT-00-0000-000000LHF4 | XTEAWT-00-0000-000000HHF4 | | |
| | | R4 | 130 | 143 | XTEAWT-00-0000-000000GF4 | XTEAWT-00-0000-000000BGF4 | XTEAWT-00-0000-000000LGF4 | XTEAWT-00-0000-000000HGF4 | | |
| | | R3 | 122 | 134 | XTEAWT-00-0000-000000FF4 | XTEAWT-00-0000-000000BFF4 | XTEAWT-00-0000-000000LFF4 | XTEAWT-00-0000-000000HFF4 | | |
| | | R2 | 114 | 125 | XTEAWT-00-0000-000000EF4 | XTEAWT-00-0000-000000BEF4 | XTEAWT-00-0000-000000LEF4 | XTEAWT-00-0000-000000HEF4 | | |
| | | Q5 | 107 | 118 | | | XTEAWT-00-0000-000000LDF4 | XTEAWT-00-0000-000000HDF4 | XTEAWT-00-0000-000000PDF4 | XTEAWT-00-0000-000000UDF4 |
| | | Q4 | 100 | 110 | | | | | XTEAWT-00-0000-000000PCF4 | XTEAWT-00-0000-000000UCF4 |
| | | Q3 | 93.9 | 103 | | | | | XTEAWT-00-0000-000000PBF4 | XTEAWT-00-0000-000000UBF4 |
| | | Q2 | 87.4 | 96.1 | | | | | XTEAWT-00-0000-000000PAF4 | XTEAWT-00-0000-000000UAF4 |
| D1 | 4750 K | S3 | 156 | 171 | XTEAWT-00-0000-000000KD1 | XTEAWT-00-0000-000000BKD1 | | | | |
| | | S2 | 148 | 163 | XTEAWT-00-0000-000000JD1 | XTEAWT-00-0000-000000BJD1 | XTEAWT-00-0000-000000LJD1 | | | |
| | | R5 | 139 | 153 | XTEAWT-00-0000-000000HD1 | XTEAWT-00-0000-000000BHD1 | XTEAWT-00-0000-000000LHD1 | | | |
| | | R4 | 130 | 143 | XTEAWT-00-0000-000000GD1 | XTEAWT-00-0000-000000BGD1 | XTEAWT-00-0000-000000LGD1 | | | |
| | | R3 | 122 | 134 | XTEAWT-00-0000-000000FD1 | XTEAWT-00-0000-000000BFD1 | XTEAWT-00-0000-000000LFD1 | | | |
| | | R2 | 114 | 125 | XTEAWT-00-0000-000000ED1 | XTEAWT-00-0000-000000BED1 | XTEAWT-00-0000-000000LED1 | | | |

Notes:

- Cree maintains a tolerance of ±7% on flux and power measurements, ±0.005 on chromaticity (CCx, CCy) measurements and ±2 on CRI measurements. See the Measurements section (page 40).
- Cree XLamp XT-E LED order codes specify only a minimum flux bin and not a maximum. Cree may ship reels in flux bins higher than the minimum specified by the order code without advance notice. Shipments will always adhere to the chromaticity or DWL bin restrictions specified by the order code.
- * Flux values @ 25 °C are calculated and for reference only.

FLUX CHARACTERISTICS - WHITE, STANDARD (T_j = 85 °C) - CONTINUED

| Chromaticity | | Minimum Luminous Flux (lm) @ 350 mA | | | Order Codes | | | | | |
|--------------|--------|-------------------------------------|-------------------|--------------------|--------------------------|---------------------------|---------------------------|---------------------------|---------------------------|---------------------------|
| Kit | CCT | Code | Flux (lm) @ 85 °C | Flux (lm) @ 25 °C* | No Minimum CRI | 70 CRI Minimum | 75 CRI Typical | 80 CRI Minimum | 85 CRI Minimum | 90 CRI Minimum |
| E4 | 4500 K | S3 | 156 | 171 | XTEAWT-00-0000-000000KE4 | XTEAWT-00-0000-000000BKE4 | | | | |
| | | S2 | 148 | 163 | XTEAWT-00-0000-000000JE4 | XTEAWT-00-0000-000000BJE4 | XTEAWT-00-0000-000000LJE4 | | | |
| | | R5 | 139 | 153 | XTEAWT-00-0000-000000HE4 | XTEAWT-00-0000-000000BHE4 | XTEAWT-00-0000-000000LHE4 | XTEAWT-00-0000-000000HHE4 | | |
| | | R4 | 130 | 143 | XTEAWT-00-0000-000000GE4 | XTEAWT-00-0000-000000BGE4 | XTEAWT-00-0000-000000LGE4 | XTEAWT-00-0000-000000HGE4 | | |
| | | R3 | 122 | 134 | XTEAWT-00-0000-000000FE4 | XTEAWT-00-0000-000000BFE4 | XTEAWT-00-0000-000000LFE4 | XTEAWT-00-0000-000000HFE4 | | |
| | | R2 | 114 | 125 | XTEAWT-00-0000-000000EE4 | XTEAWT-00-0000-000000BEE4 | XTEAWT-00-0000-000000LEE4 | XTEAWT-00-0000-000000HEE4 | | |
| | | Q5 | 107 | 118 | | | XTEAWT-00-0000-000000LDE4 | XTEAWT-00-0000-000000HDE4 | XTEAWT-00-0000-000000PDE4 | XTEAWT-00-0000-000000UDE4 |
| | | Q4 | 100 | 110 | | | | | XTEAWT-00-0000-000000PCE4 | XTEAWT-00-0000-000000UCE4 |
| | | Q3 | 93.9 | 103 | | | | | XTEAWT-00-0000-000000PBE4 | XTEAWT-00-0000-000000UBE4 |
| | | Q2 | 87.4 | 96.1 | | | | | XTEAWT-00-0000-000000PAE4 | XTEAWT-00-0000-000000UAE4 |
| D2 | 4500 K | S3 | 156 | 171 | XTEAWT-00-0000-000000KD2 | XTEAWT-00-0000-000000BKD2 | | | | |
| | | S2 | 148 | 163 | XTEAWT-00-0000-000000JD2 | XTEAWT-00-0000-000000BJD2 | | | | |
| | | R5 | 139 | 153 | XTEAWT-00-0000-000000HD2 | XTEAWT-00-0000-000000BHD2 | XTEAWT-00-0000-000000LHD2 | | | |
| | | R4 | 130 | 143 | XTEAWT-00-0000-000000GD2 | XTEAWT-00-0000-000000BGD2 | XTEAWT-00-0000-000000LGD2 | | | |
| | | R3 | 122 | 134 | XTEAWT-00-0000-000000FD2 | XTEAWT-00-0000-000000BFD2 | XTEAWT-00-0000-000000LFD2 | | | |
| | | R2 | 114 | 125 | XTEAWT-00-0000-000000ED2 | XTEAWT-00-0000-000000BED2 | XTEAWT-00-0000-000000LED2 | | | |
| | | Q5 | 107 | 118 | | | XTEAWT-00-0000-000000LDD2 | | | |

Notes:

- Cree maintains a tolerance of $\pm 7\%$ on flux and power measurements, ± 0.005 on chromaticity (CCx, CCy) measurements and ± 2 on CRI measurements. See the Measurements section (page 40).
- Cree XLamp XT-E LED order codes specify only a minimum flux bin and not a maximum. Cree may ship reels in flux bins higher than the minimum specified by the order code without advance notice. Shipments will always adhere to the chromaticity or DWL bin restrictions specified by the order code.
- * Flux values @ 25 °C are calculated and for reference only.

FLUX CHARACTERISTICS - WHITE, STANDARD (T_j = 85 °C) - CONTINUED

| Chromaticity | | Minimum Luminous Flux (lm) @ 350 mA | | | Order Codes | | | | | |
|--------------|--------|-------------------------------------|-------------------|--------------------|--------------------------|---------------------------|---------------------------|----------------|----------------|----------------|
| Kit | CCT | Code | Flux (lm) @ 85 °C | Flux (lm) @ 25 °C* | No Minimum CRI | 70 CRI Minimum | 75 CRI Typical | 80 CRI Minimum | 85 CRI Minimum | 90 CRI Minimum |
| C2 | 4500 K | S3 | 156 | 171 | XTEAWT-00-0000-000000KC2 | XTEAWT-00-0000-000000BKC2 | | | | |
| | | S2 | 148 | 163 | XTEAWT-00-0000-000000JC2 | XTEAWT-00-0000-000000BJC2 | XTEAWT-00-0000-000000LJC2 | | | |
| | | R5 | 139 | 153 | XTEAWT-00-0000-000000HC2 | XTEAWT-00-0000-000000BHC2 | XTEAWT-00-0000-000000LHC2 | | | |
| | | R4 | 130 | 143 | XTEAWT-00-0000-000000GC2 | XTEAWT-00-0000-000000BGC2 | XTEAWT-00-0000-000000LGC2 | | | |
| | | R3 | 122 | 134 | XTEAWT-00-0000-000000FC2 | XTEAWT-00-0000-000000BFC2 | XTEAWT-00-0000-000000LFC2 | | | |
| | | R2 | 114 | 125 | XTEAWT-00-0000-000000EC2 | XTEAWT-00-0000-000000BEC2 | XTEAWT-00-0000-000000LEC2 | | | |
| C3 | 4300 K | S3 | 156 | 171 | XTEAWT-00-0000-000000KC3 | XTEAWT-00-0000-000000BKC3 | | | | |
| | | S2 | 148 | 163 | XTEAWT-00-0000-000000JC3 | XTEAWT-00-0000-000000BJC3 | XTEAWT-00-0000-000000LJC3 | | | |
| | | R5 | 139 | 153 | XTEAWT-00-0000-000000HC3 | XTEAWT-00-0000-000000BHC3 | XTEAWT-00-0000-000000LHC3 | | | |
| | | R4 | 130 | 143 | XTEAWT-00-0000-000000GC3 | XTEAWT-00-0000-000000BGC3 | XTEAWT-00-0000-000000LGC3 | | | |
| | | R3 | 122 | 134 | XTEAWT-00-0000-000000FC3 | XTEAWT-00-0000-000000BFC3 | XTEAWT-00-0000-000000LFC3 | | | |
| | | R2 | 114 | 125 | XTEAWT-00-0000-000000EC3 | XTEAWT-00-0000-000000BEC3 | XTEAWT-00-0000-000000LEC3 | | | |

Notes:

- Cree maintains a tolerance of $\pm 7\%$ on flux and power measurements, ± 0.005 on chromaticity (CCx, CCy) measurements and ± 2 on CRI measurements. See the Measurements section (page 40).
- Cree XLamp XT-E LED order codes specify only a minimum flux bin and not a maximum. Cree may ship reels in flux bins higher than the minimum specified by the order code without advance notice. Shipments will always adhere to the chromaticity or DWL bin restrictions specified by the order code.
- * Flux values @ 25 °C are calculated and for reference only.

FLUX CHARACTERISTICS - WHITE, STANDARD (T_j = 85 °C) - CONTINUED

| Chromaticity | | Minimum Luminous Flux (lm) @ 350 mA | | | Order Codes | | | | | | |
|--------------|--------|-------------------------------------|-------------------|--------------------|-------------------------|--------------------------|--------------------------|--------------------------|--------------------------|--------------------------|--|
| Kit | CCT | Code | Flux (lm) @ 85 °C | Flux (lm) @ 25 °C* | No Minimum CRI | 70 CRI Minimum | 75 CRI Typical | 80 CRI Minimum | 85 CRI Minimum | 90 CRI Minimum | |
| F5 | 4250 K | S3 | 156 | 171 | XTEAWT-00-0000-00000KF5 | | | | | | |
| | | S2 | 148 | 163 | XTEAWT-00-0000-00000JF5 | XTEAWT-00-0000-00000BJF5 | | | | | |
| | | R5 | 139 | 153 | XTEAWT-00-0000-00000HF5 | XTEAWT-00-0000-00000BHF5 | XTEAWT-00-0000-00000LHF5 | | | | |
| | | R4 | 130 | 143 | XTEAWT-00-0000-00000GF5 | XTEAWT-00-0000-00000BGF5 | XTEAWT-00-0000-00000LGF5 | XTEAWT-00-0000-00000HGF5 | | | |
| | | R3 | 122 | 134 | XTEAWT-00-0000-00000FF5 | XTEAWT-00-0000-00000BFF5 | XTEAWT-00-0000-00000LFF5 | XTEAWT-00-0000-00000HFF5 | | | |
| | | R2 | 114 | 125 | XTEAWT-00-0000-00000EF5 | XTEAWT-00-0000-00000BEF5 | XTEAWT-00-0000-00000LEF5 | XTEAWT-00-0000-00000HEF5 | | | |
| | | Q5 | 107 | 118 | XTEAWT-00-0000-00000DF5 | XTEAWT-00-0000-00000BDF5 | XTEAWT-00-0000-00000LDF5 | XTEAWT-00-0000-00000HDF5 | | | |
| | | Q4 | 100 | 110 | | | XTEAWT-00-0000-00000LCF5 | XTEAWT-00-0000-00000HCF5 | XTEAWT-00-0000-00000PCF5 | XTEAWT-00-0000-00000UCF5 | |
| | | Q3 | 93.9 | 103 | | | | | XTEAWT-00-0000-00000PBF5 | XTEAWT-00-0000-00000UBF5 | |
| | | Q2 | 87.4 | 96.1 | | | | | XTEAWT-00-0000-00000PAF5 | XTEAWT-00-0000-00000UAF5 | |
| | | P4 | 80.6 | 88.6 | | | | | XTEAWT-00-0000-00000P9F5 | XTEAWT-00-0000-00000U9F5 | |

Notes:

- Cree maintains a tolerance of $\pm 7\%$ on flux and power measurements, ± 0.005 on chromaticity (CCx, CCy) measurements and ± 2 on CRI measurements. See the Measurements section (page 40).
- Cree XLamp XT-E LED order codes specify only a minimum flux bin and not a maximum. Cree may ship reels in flux bins higher than the minimum specified by the order code without advance notice. Shipments will always adhere to the chromaticity or DWL bin restrictions specified by the order code.
- * Flux values @ 25 °C are calculated and for reference only.

FLUX CHARACTERISTICS - WHITE, STANDARD (T_j = 85 °C) - CONTINUED

| Chromaticity | | Minimum Luminous Flux (lm) @ 350 mA | | | Order Codes | | | | | | |
|--------------|--------|-------------------------------------|-------------------|--------------------|--------------------------|---------------------------|---------------------------|---------------------------|---------------------------|---------------------------|---------------------------|
| Kit | CCT | Code | Flux (lm) @ 85 °C | Flux (lm) @ 25 °C* | No Minimum CRI | 70 CRI Minimum | 75 CRI Typical | 80 CRI Minimum | 85 CRI Minimum | 90 CRI Minimum | |
| E5 | 4000 K | S3 | 156 | 171 | XTEAWT-00-0000-000000KE5 | | | | | | |
| | | S2 | 148 | 163 | XTEAWT-00-0000-000000JE5 | XTEAWT-00-0000-000000BJE5 | | | | | |
| | | R5 | 139 | 153 | XTEAWT-00-0000-000000HE5 | XTEAWT-00-0000-000000BHE5 | XTEAWT-00-0000-000000LHE5 | | | | |
| | | R4 | 130 | 143 | XTEAWT-00-0000-000000GE5 | XTEAWT-00-0000-000000BGE5 | XTEAWT-00-0000-000000LGE5 | XTEAWT-00-0000-000000HGE5 | | | |
| | | R3 | 122 | 134 | XTEAWT-00-0000-000000FE5 | XTEAWT-00-0000-000000BFE5 | XTEAWT-00-0000-000000LFE5 | XTEAWT-00-0000-000000HFE5 | | | |
| | | R2 | 114 | 125 | XTEAWT-00-0000-000000EE5 | XTEAWT-00-0000-000000BEE5 | XTEAWT-00-0000-000000LEE5 | XTEAWT-00-0000-000000HEE5 | | | |
| | | Q5 | 107 | 118 | XTEAWT-00-0000-000000DE5 | XTEAWT-00-0000-000000BDE5 | XTEAWT-00-0000-000000LDE5 | XTEAWT-00-0000-000000HDE5 | | | |
| | | Q4 | 100 | 110 | | | XTEAWT-00-0000-000000LCE5 | XTEAWT-00-0000-000000HCE5 | XTEAWT-00-0000-000000PCE5 | XTEAWT-00-0000-000000UCE5 | |
| | | Q3 | 93.9 | 103 | | | | | | XTEAWT-00-0000-000000PBE5 | XTEAWT-00-0000-000000UBE5 |
| | | Q2 | 87.4 | 96.1 | | | | | | XTEAWT-00-0000-000000PAE5 | XTEAWT-00-0000-000000UAE5 |
| | | P4 | 80.6 | 88.6 | | | | | | XTEAWT-00-0000-000000P9E5 | XTEAWT-00-0000-000000U9E5 |

Notes:

- Cree maintains a tolerance of $\pm 7\%$ on flux and power measurements, ± 0.005 on chromaticity (CCx, CCy) measurements and ± 2 on CRI measurements. See the Measurements section (page 40).
- Cree XLamp XT-E LED order codes specify only a minimum flux bin and not a maximum. Cree may ship reels in flux bins higher than the minimum specified by the order code without advance notice. Shipments will always adhere to the chromaticity or DWL bin restrictions specified by the order code.
- * Flux values @ 25 °C are calculated and for reference only.

FLUX CHARACTERISTICS - WHITE, STANDARD (T_j = 85 °C) - CONTINUED

| Chromaticity | | Minimum Luminous Flux (lm) @ 350 mA | | | Order Codes | | | | | |
|--------------|--------|-------------------------------------|-------------------|--------------------|--------------------------|---------------------------|---------------------------|---------------------------|---------------------------|---------------------------|
| Kit | CCT | Code | Flux (lm) @ 85 °C | Flux (lm) @ 25 °C* | No Minimum CRI | 70 CRI Minimum | 80 CRI Typical | 80 CRI Minimum | 85 CRI Minimum | 90 CRI Minimum |
| F6 | 3750 K | R5 | 139 | 153 | XTEAWT-00-0000-000000HF6 | XTEAWT-00-0000-000000BHF6 | XTEAWT-00-0000-000000LHF6 | | | |
| | | R4 | 130 | 143 | XTEAWT-00-0000-000000GF6 | XTEAWT-00-0000-000000BGF6 | XTEAWT-00-0000-000000LGF6 | | | |
| | | R3 | 122 | 134 | XTEAWT-00-0000-000000FF6 | XTEAWT-00-0000-000000BFF6 | XTEAWT-00-0000-000000LFF6 | XTEAWT-00-0000-000000HFF6 | | |
| | | R2 | 114 | 125 | XTEAWT-00-0000-000000EF6 | XTEAWT-00-0000-000000BEF6 | XTEAWT-00-0000-000000LEF6 | XTEAWT-00-0000-000000HEF6 | | |
| | | Q5 | 107 | 118 | XTEAWT-00-0000-000000DF6 | XTEAWT-00-0000-000000BDF6 | XTEAWT-00-0000-000000LDF6 | XTEAWT-00-0000-000000HDF6 | | |
| | | Q4 | 100 | 110 | | | XTEAWT-00-0000-000000LCF6 | XTEAWT-00-0000-000000HCF6 | XTEAWT-00-0000-000000PCF6 | XTEAWT-00-0000-000000UCF6 |
| | | Q3 | 93.9 | 103 | | | | | XTEAWT-00-0000-000000PBF6 | XTEAWT-00-0000-000000UBF6 |
| | | Q2 | 87.4 | 96.1 | | | | | XTEAWT-00-0000-000000PAF6 | XTEAWT-00-0000-000000UAF6 |
| | | P4 | 80.6 | 88.6 | | | | | XTEAWT-00-0000-000000P9F6 | XTEAWT-00-0000-000000U9F6 |
| E6 | 3500 K | R5 | 139 | 153 | XTEAWT-00-0000-000000HE6 | XTEAWT-00-0000-000000BHE6 | XTEAWT-00-0000-000000LHE6 | | | |
| | | R4 | 130 | 143 | XTEAWT-00-0000-000000GE6 | XTEAWT-00-0000-000000BGE6 | XTEAWT-00-0000-000000LGE6 | | | |
| | | R3 | 122 | 134 | XTEAWT-00-0000-000000FE6 | XTEAWT-00-0000-000000BFE6 | XTEAWT-00-0000-000000LFE6 | XTEAWT-00-0000-000000HFE6 | | |
| | | R2 | 114 | 125 | XTEAWT-00-0000-000000EE6 | XTEAWT-00-0000-000000BEE6 | XTEAWT-00-0000-000000LEE6 | XTEAWT-00-0000-000000HEE6 | | |
| | | Q5 | 107 | 118 | XTEAWT-00-0000-000000DE6 | XTEAWT-00-0000-000000BDE6 | XTEAWT-00-0000-000000LDE6 | XTEAWT-00-0000-000000HDE6 | | |
| | | Q4 | 100 | 110 | | | XTEAWT-00-0000-000000LCE6 | XTEAWT-00-0000-000000HCE6 | XTEAWT-00-0000-000000PCE6 | XTEAWT-00-0000-000000UCE6 |
| | | Q3 | 93.9 | 103 | | | | | XTEAWT-00-0000-000000PBE6 | XTEAWT-00-0000-000000UBE6 |
| | | Q2 | 87.4 | 96.1 | | | | | XTEAWT-00-0000-000000PAE6 | XTEAWT-00-0000-000000UAE6 |
| | | P4 | 80.6 | 88.6 | | | | | XTEAWT-00-0000-000000P9E6 | XTEAWT-00-0000-000000U9E6 |

Notes:

- Cree maintains a tolerance of ±7% on flux and power measurements, ±0.005 on chromaticity (CCx, CCy) measurements and ±2 on CRI measurements. See the Measurements section (page 40).
- Cree XLamp XT-E LED order codes specify only a minimum flux bin and not a maximum. Cree may ship reels in flux bins higher than the minimum specified by the order code without advance notice. Shipments will always adhere to the chromaticity or DWL bin restrictions specified by the order code.
- * Flux values @ 25 °C are calculated and for reference only.

FLUX CHARACTERISTICS - WHITE, STANDARD (T_j = 85 °C) - CONTINUED

| Chromaticity | | Minimum Luminous Flux (lm) @ 350 mA | | | Order Codes | | | | | |
|--------------|--------|-------------------------------------|-------------------|--------------------|--------------------------|---------------------------|---------------------------|---------------------------|---------------------------|---------------------------|
| Kit | CCT | Code | Flux (lm) @ 85 °C | Flux (lm) @ 25 °C* | No Minimum CRI | 70 CRI Minimum | 80 CRI Typical | 80 CRI Minimum | 85 CRI Minimum | 90 CRI Minimum |
| F7 | 3250 K | R4 | 130 | 143 | XTEAWT-00-0000-000000GF7 | XTEAWT-00-0000-000000BGF7 | XTEAWT-00-0000-000000LGF7 | | | |
| | | R3 | 122 | 134 | XTEAWT-00-0000-000000FF7 | XTEAWT-00-0000-000000BFF7 | XTEAWT-00-0000-000000LFF7 | XTEAWT-00-0000-000000HFF7 | | |
| | | R2 | 114 | 125 | XTEAWT-00-0000-000000EF7 | XTEAWT-00-0000-000000BEF7 | XTEAWT-00-0000-000000LEF7 | XTEAWT-00-0000-000000HEF7 | | |
| | | Q5 | 107 | 118 | XTEAWT-00-0000-000000DF7 | XTEAWT-00-0000-000000BDF7 | XTEAWT-00-0000-000000LDF7 | XTEAWT-00-0000-000000HDF7 | | |
| | | Q4 | 100 | 110 | XTEAWT-00-0000-000000CF7 | XTEAWT-00-0000-000000BCF7 | XTEAWT-00-0000-000000LCF7 | XTEAWT-00-0000-000000HCF7 | | |
| | | Q3 | 93.9 | 103 | | | XTEAWT-00-0000-000000LBF7 | XTEAWT-00-0000-000000HBF7 | XTEAWT-00-0000-000000PBF7 | XTEAWT-00-0000-000000UBF7 |
| | | Q2 | 87.4 | 96.1 | | | | | XTEAWT-00-0000-000000PAF7 | XTEAWT-00-0000-000000UAF7 |
| | | P4 | 80.6 | 88.6 | | | | | XTEAWT-00-0000-000000P9F7 | XTEAWT-00-0000-000000U9F7 |
| | | P3 | 73.9 | 81.2 | | | | | XTEAWT-00-0000-000000P8F7 | XTEAWT-00-0000-000000U8F7 |
| E7 | 3000 K | R4 | 130 | 143 | XTEAWT-00-0000-000000GE7 | XTEAWT-00-0000-000000BGE7 | XTEAWT-00-0000-000000LGE7 | | | |
| | | R3 | 122 | 134 | XTEAWT-00-0000-000000FE7 | XTEAWT-00-0000-000000BFE7 | XTEAWT-00-0000-000000LFE7 | XTEAWT-00-0000-000000HFE7 | | |
| | | R2 | 114 | 125 | XTEAWT-00-0000-000000EE7 | XTEAWT-00-0000-000000BEE7 | XTEAWT-00-0000-000000LEE7 | XTEAWT-00-0000-000000HEE7 | | |
| | | Q5 | 107 | 118 | XTEAWT-00-0000-000000DE7 | XTEAWT-00-0000-000000BDE7 | XTEAWT-00-0000-000000LDE7 | XTEAWT-00-0000-000000HDE7 | | |
| | | Q4 | 100 | 110 | XTEAWT-00-0000-000000CE7 | XTEAWT-00-0000-000000BCE7 | XTEAWT-00-0000-000000LCE7 | XTEAWT-00-0000-000000HCE7 | | |
| | | Q3 | 93.9 | 103 | | | XTEAWT-00-0000-000000LBE7 | XTEAWT-00-0000-000000HBE7 | XTEAWT-00-0000-000000PBE7 | XTEAWT-00-0000-000000UBE7 |
| | | Q2 | 87.4 | 96.1 | | | | | XTEAWT-00-0000-000000PAE7 | XTEAWT-00-0000-000000UAE7 |
| | | P4 | 80.6 | 88.6 | | | | | XTEAWT-00-0000-000000P9E7 | XTEAWT-00-0000-000000U9E7 |
| | | P3 | 73.9 | 81.2 | | | | | XTEAWT-00-0000-000000P8E7 | XTEAWT-00-0000-000000U8E7 |

Notes:

- Cree maintains a tolerance of ±7% on flux and power measurements, ±0.005 on chromaticity (CCx, CCy) measurements and ±2 on CRI measurements. See the Measurements section (page 40).
- Cree XLamp XT-E LED order codes specify only a minimum flux bin and not a maximum. Cree may ship reels in flux bins higher than the minimum specified by the order code without advance notice. Shipments will always adhere to the chromaticity or DWL bin restrictions specified by the order code.
- * Flux values @ 25 °C are calculated and for reference only.

FLUX CHARACTERISTICS - WHITE, STANDARD (T_j = 85 °C) - CONTINUED

| Chromaticity | | Minimum Luminous Flux (lm) @ 350 mA | | | Order Codes | | | | | |
|--------------|--------|-------------------------------------|-------------------|--------------------|--------------------------|--------------------------|--------------------------|--------------------------|--------------------------|--------------------------|
| Kit | CCT | Code | Flux (lm) @ 85 °C | Flux (lm) @ 25 °C* | No Minimum CRI | 70 CRI Minimum | 80 CRI Typical | 80 CRI Minimum | 85 CRI Minimum | 90 CRI Minimum |
| E8 | 2700 K | R3 | 122 | 134 | XTEAWT-00-0000-000000FE8 | XTEAWT-00-0000-00000BFE8 | XTEAWT-00-0000-00000LFE8 | | | |
| | | R2 | 114 | 125 | XTEAWT-00-0000-000000EE8 | XTEAWT-00-0000-00000BEE8 | XTEAWT-00-0000-00000LEE8 | XTEAWT-00-0000-00000HEE8 | | |
| | | Q5 | 107 | 118 | XTEAWT-00-0000-000000DE8 | XTEAWT-00-0000-00000BDE8 | XTEAWT-00-0000-00000LDE8 | XTEAWT-00-0000-00000HDE8 | | |
| | | Q4 | 100 | 110 | XTEAWT-00-0000-000000CE8 | XTEAWT-00-0000-00000BCE8 | XTEAWT-00-0000-00000LCE8 | XTEAWT-00-0000-00000HCE8 | | |
| | | Q3 | 93.9 | 103 | XTEAWT-00-0000-000000BE8 | XTEAWT-00-0000-00000BBE8 | XTEAWT-00-0000-00000LBE8 | XTEAWT-00-0000-00000HBE8 | XTEAWT-00-0000-00000PBE8 | |
| | | Q2 | 87.4 | 96.1 | | | XTEAWT-00-0000-00000LAE8 | XTEAWT-00-0000-00000HAE8 | XTEAWT-00-0000-00000PAE8 | XTEAWT-00-0000-00000UAE8 |
| | | P4 | 80.6 | 88.6 | | | | | XTEAWT-00-0000-00000P9E8 | XTEAWT-00-0000-00000U9E8 |
| | | P3 | 73.9 | 81.2 | | | | | XTEAWT-00-0000-00000P8E8 | XTEAWT-00-0000-00000U8E8 |

Notes:

- Cree maintains a tolerance of $\pm 7\%$ on flux and power measurements, ± 0.005 on chromaticity (CCx, CCy) measurements and ± 2 on CRI measurements. See the Measurements section (page 40).
- Cree XLamp XT-E LED order codes specify only a minimum flux bin and not a maximum. Cree may ship reels in flux bins higher than the minimum specified by the order code without advance notice. Shipments will always adhere to the chromaticity or DWL bin restrictions specified by the order code.
- * Flux values @ 25 °C are calculated and for reference only.

FLUX CHARACTERISTICS - WHITE, HIGH EFFICACY (T_j = 85 °C)

The following tables provide order codes for XLamp High Efficacy XT-E White LEDs. For a complete description of the order code nomenclature, please see the Bin and Order Code Formats section (page 38). For definitions of the chromaticity kits, please see the Cree's Standard Chromaticity Kits section (page 37).

| Chromaticity | | Minimum Luminous Flux (lm) @ 350 mA | | | Order Codes | | | |
|--------------|--------|-------------------------------------|-------------------|--------------------|--------------------------|--------------------------|--------------------------|----------------|
| Kit | CCT | Code | Flux (lm) @ 85 °C | Flux (lm) @ 25 °C* | No Minimum CRI | 70 CRI Minimum | 80 CRI Minimum | 90 CRI Minimum |
| 51 | 6200 K | S4 | 164 | 180 | XTEAWT-E0-0000-000000L51 | XTEAWT-E0-0000-00000BL51 | | |
| | | S3 | 156 | 171 | XTEAWT-E0-0000-000000K51 | XTEAWT-E0-0000-00000BK51 | | |
| | | S2 | 148 | 163 | XTEAWT-E0-0000-000000J51 | XTEAWT-E0-0000-00000BJ51 | | |
| | | R5 | 139 | 153 | XTEAWT-E0-0000-000000H51 | XTEAWT-E0-0000-00000BH51 | XTEAWT-E0-0000-00000HH51 | |
| | | R4 | 130 | 143 | XTEAWT-E0-0000-000000G51 | XTEAWT-E0-0000-00000BG51 | XTEAWT-E0-0000-00000HG51 | |
| | | R3 | 122 | 134 | | | XTEAWT-E0-0000-00000HF51 | |
| | | R2 | 114 | 125 | | | XTEAWT-E0-0000-00000HE51 | |
| 53 | 6000 K | S4 | 164 | 180 | XTEAWT-E0-0000-000000L53 | XTEAWT-E0-0000-00000BL53 | | |
| | | S3 | 156 | 171 | XTEAWT-E0-0000-000000K53 | XTEAWT-E0-0000-00000BK53 | | |
| | | S2 | 148 | 163 | XTEAWT-E0-0000-000000J53 | XTEAWT-E0-0000-00000BJ53 | | |
| | | R5 | 139 | 153 | XTEAWT-E0-0000-000000H53 | XTEAWT-E0-0000-00000BH53 | XTEAWT-E0-0000-00000HH53 | |
| | | R4 | 130 | 143 | XTEAWT-E0-0000-000000G53 | XTEAWT-E0-0000-00000BG53 | XTEAWT-E0-0000-00000HG53 | |
| | | R3 | 122 | 134 | | | XTEAWT-E0-0000-00000HF53 | |
| | | R2 | 114 | 125 | | | XTEAWT-E0-0000-00000HE53 | |
| 50 | 6200 K | S4 | 164 | 180 | XTEAWT-E0-0000-000000L50 | XTEAWT-E0-0000-00000BL50 | | |
| | | S3 | 156 | 171 | XTEAWT-E0-0000-000000K50 | XTEAWT-E0-0000-00000BK50 | | |
| | | S2 | 148 | 163 | XTEAWT-E0-0000-000000J50 | XTEAWT-E0-0000-00000BJ50 | | |
| | | R5 | 139 | 153 | XTEAWT-E0-0000-000000H50 | XTEAWT-E0-0000-00000BH50 | XTEAWT-E0-0000-00000HH50 | |
| | | R4 | 130 | 143 | XTEAWT-E0-0000-000000G50 | XTEAWT-E0-0000-00000BG50 | XTEAWT-E0-0000-00000HG50 | |
| | | R3 | 122 | 134 | | | XTEAWT-E0-0000-00000HF50 | |
| | | R2 | 114 | 125 | | | XTEAWT-E0-0000-00000HE50 | |
| E1 | 6500 K | S3 | 156 | 171 | XTEAWT-E0-0000-000000KE1 | XTEAWT-E0-0000-00000BKE1 | | |
| | | S2 | 148 | 163 | XTEAWT-E0-0000-000000JE1 | XTEAWT-E0-0000-00000BJE1 | | |
| | | R5 | 139 | 153 | XTEAWT-E0-0000-000000HE1 | XTEAWT-E0-0000-00000BHE1 | XTEAWT-E0-0000-00000HHE1 | |
| | | R4 | 130 | 143 | XTEAWT-E0-0000-000000GE1 | XTEAWT-E0-0000-00000BGE1 | XTEAWT-E0-0000-00000HGE1 | |
| | | R3 | 122 | 134 | | | XTEAWT-E0-0000-00000HFE1 | |
| | | R2 | 114 | 125 | | | XTEAWT-E0-0000-00000HEE1 | |

Notes:

- Cree maintains a tolerance of $\pm 7\%$ on flux and power measurements, ± 0.005 on chromaticity (CCx, CCy) measurements and ± 2 on CRI measurements. See the Measurements section (page 40).
- Cree XLamp XT-E LED order codes specify only a minimum flux bin and not a maximum. Cree may ship reels in flux bins higher than the minimum specified by the order code without advance notice. Shipments will always adhere to the chromaticity or DWL bin restrictions specified by the order code.
- * Flux values @ 25 °C are calculated and for reference only.

FLUX CHARACTERISTICS - WHITE, HIGH EFFICACY (T_j = 85 °C) - CONTINUED

| Chromaticity | | Minimum Luminous Flux (lm) @ 350 mA | | | Order Codes | | | |
|--------------|--------|-------------------------------------|-------------------|--------------------|--------------------------|--------------------------|--------------------------|--------------------------|
| Kit | CCT | Code | Flux (lm) @ 85 °C | Flux (lm) @ 25 °C* | No Minimum CRI | 70 CRI Minimum | 80 CRI Minimum | 90 CRI Minimum |
| E2 | 5700 K | S4 | 164 | 180 | XTEAWT-E0-0000-000000LE2 | XTEAWT-E0-0000-00000BLE2 | | |
| | | S3 | 156 | 171 | XTEAWT-E0-0000-000000KE2 | XTEAWT-E0-0000-00000BKE2 | | |
| | | S2 | 148 | 163 | XTEAWT-E0-0000-000000JE2 | XTEAWT-E0-0000-00000BJE2 | | |
| | | R5 | 139 | 153 | XTEAWT-E0-0000-000000HE2 | XTEAWT-E0-0000-00000BHE2 | XTEAWT-E0-0000-00000HHE2 | |
| | | R4 | 130 | 143 | XTEAWT-E0-0000-000000GE2 | XTEAWT-E0-0000-00000BGE2 | XTEAWT-E0-0000-00000HGE2 | |
| | | R3 | 122 | 134 | | | XTEAWT-E0-0000-00000HFE2 | |
| | | R2 | 114 | 125 | | | XTEAWT-E0-0000-00000HEE2 | |
| E3 | 5000 K | S4 | 164 | 180 | XTEAWT-E0-0000-000000LE3 | XTEAWT-E0-0000-00000BLE3 | | |
| | | S3 | 156 | 171 | XTEAWT-E0-0000-000000KE3 | XTEAWT-E0-0000-00000BKE3 | | |
| | | S2 | 148 | 163 | XTEAWT-E0-0000-000000JE3 | XTEAWT-E0-0000-00000BJE3 | | |
| | | R5 | 139 | 153 | XTEAWT-E0-0000-000000HE3 | XTEAWT-E0-0000-00000BHE3 | XTEAWT-E0-0000-00000HHE3 | |
| | | R4 | 130 | 143 | XTEAWT-E0-0000-000000GE3 | XTEAWT-E0-0000-00000BGE3 | XTEAWT-E0-0000-00000HGE3 | XTEAWT-E0-0000-00000UGE3 |
| | | R3 | 122 | 134 | | | XTEAWT-E0-0000-00000HFE3 | XTEAWT-E0-0000-00000UFE3 |
| | | R2 | 114 | 125 | | | XTEAWT-E0-0000-00000HEE3 | XTEAWT-E0-0000-00000UEE3 |
| | | Q5 | 107 | 118 | | | | XTEAWT-E0-0000-00000UDE3 |
| | | Q4 | 100 | 110 | | | | XTEAWT-E0-0000-00000UCE3 |
| | | Q3 | 93.9 | 103 | | | | XTEAWT-E0-0000-00000UBE3 |
| Q2 | 87.4 | 96.1 | | | | XTEAWT-E0-0000-00000UAE3 | | |
| F4 | 4750 K | R5 | 139 | 153 | | | XTEAWT-E0-0000-00000HFF4 | |
| | | R4 | 130 | 143 | | | XTEAWT-E0-0000-00000HGF4 | XTEAWT-E0-0000-00000UGF4 |
| | | R3 | 122 | 134 | | | XTEAWT-E0-0000-00000HFF4 | XTEAWT-E0-0000-00000UFF4 |
| | | R2 | 114 | 125 | | | XTEAWT-E0-0000-00000HEF4 | XTEAWT-E0-0000-00000UEF4 |
| | | Q5 | 107 | 118 | | | | XTEAWT-E0-0000-00000UDF4 |
| | | Q4 | 100 | 110 | | | | XTEAWT-E0-0000-00000UCF4 |
| | | Q3 | 93.9 | 103 | | | | XTEAWT-E0-0000-00000UBF4 |
| Q2 | 87.4 | 96.1 | | | | XTEAWT-E0-0000-00000UAF4 | | |

Notes:

- Cree maintains a tolerance of ±7% on flux and power measurements, ±0.005 on chromaticity (CCx, CCy) measurements and ±2 on CRI measurements. See the Measurements section (page 40).
- Cree XLamp XT-E LED order codes specify only a minimum flux bin and not a maximum. Cree may ship reels in flux bins higher than the minimum specified by the order code without advance notice. Shipments will always adhere to the chromaticity or DWL bin restrictions specified by the order code.
- * Flux values @ 25 °C are calculated and for reference only.

FLUX CHARACTERISTICS - WHITE, HIGH EFFICACY (T_j = 85 °C) - CONTINUED

| Chromaticity | | Minimum Luminous Flux (lm) @ 350 mA | | | Order Codes | | | |
|--------------|--------|-------------------------------------|-------------------|--------------------|--------------------------|---------------------------|---------------------------|---------------------------|
| Kit | CCT | Code | Flux (lm) @ 85 °C | Flux (lm) @ 25 °C* | No Minimum CRI | 70 CRI Minimum | 80 CRI Minimum | 90 CRI Minimum |
| E4 | 4500 K | S3 | 156 | 171 | XTEAWT-E0-0000-000000KE4 | XTEAWT-E0-0000-000000BKE4 | | |
| | | S2 | 148 | 163 | XTEAWT-E0-0000-000000JE4 | XTEAWT-E0-0000-000000BJE4 | | |
| | | R5 | 139 | 153 | XTEAWT-E0-0000-000000HE4 | XTEAWT-E0-0000-000000BHE4 | XTEAWT-E0-0000-000000HHE4 | |
| | | R4 | 130 | 143 | XTEAWT-E0-0000-000000GE4 | XTEAWT-E0-0000-000000BGE4 | XTEAWT-E0-0000-000000HGE4 | XTEAWT-E0-0000-000000UGE4 |
| | | R3 | 122 | 134 | | | XTEAWT-E0-0000-000000HFE4 | XTEAWT-E0-0000-000000UFE4 |
| | | R2 | 114 | 125 | | | XTEAWT-E0-0000-000000HEE4 | XTEAWT-E0-0000-000000UEE4 |
| | | Q5 | 107 | 118 | | | | XTEAWT-E0-0000-000000UDE4 |
| | | Q4 | 100 | 110 | | | | XTEAWT-E0-0000-000000UCE4 |
| | | Q3 | 93.9 | 103 | | | | XTEAWT-E0-0000-000000UBE4 |
| | | Q2 | 87.4 | 96.1 | | | | XTEAWT-E0-0000-000000UAE4 |
| F5 | 4250 K | S3 | 156 | 171 | XTEAWT-E0-0000-000000KF5 | XTEAWT-E0-0000-000000BKF5 | | |
| | | S2 | 148 | 163 | XTEAWT-E0-0000-000000JF5 | XTEAWT-E0-0000-000000BJF5 | | |
| | | R5 | 139 | 153 | XTEAWT-E0-0000-000000HF5 | XTEAWT-E0-0000-000000BHF5 | | |
| | | R4 | 130 | 143 | XTEAWT-E0-0000-000000GF5 | XTEAWT-E0-0000-000000BGF5 | XTEAWT-E0-0000-000000HGF5 | |
| | | R3 | 122 | 134 | | | XTEAWT-E0-0000-000000HFF5 | XTEAWT-E0-0000-000000UFF5 |
| | | R2 | 114 | 125 | | | XTEAWT-E0-0000-000000HEF5 | XTEAWT-E0-0000-000000UEF5 |
| | | Q5 | 107 | 118 | | | XTEAWT-E0-0000-000000HDF5 | XTEAWT-E0-0000-000000UDF5 |
| | | Q4 | 100 | 110 | | | | XTEAWT-E0-0000-000000UCF5 |
| | | Q3 | 93.9 | 103 | | | | XTEAWT-E0-0000-000000UBF5 |
| | | Q2 | 87.4 | 96.1 | | | | XTEAWT-E0-0000-000000UAF5 |
| E5 | 4000 K | S3 | 156 | 171 | XTEAWT-E0-0000-000000KE5 | XTEAWT-E0-0000-000000BKE5 | | |
| | | S2 | 148 | 163 | XTEAWT-E0-0000-000000JE5 | XTEAWT-E0-0000-000000BJE5 | | |
| | | R5 | 139 | 153 | XTEAWT-E0-0000-000000HE5 | XTEAWT-E0-0000-000000BHE5 | | |
| | | R4 | 130 | 143 | XTEAWT-E0-0000-000000GE5 | XTEAWT-E0-0000-000000BGE5 | XTEAWT-E0-0000-000000HGE5 | |
| | | R3 | 122 | 134 | | | XTEAWT-E0-0000-000000HFE5 | XTEAWT-E0-0000-000000UFE5 |
| | | R2 | 114 | 125 | | | XTEAWT-E0-0000-000000HEE5 | XTEAWT-E0-0000-000000UEE5 |
| | | Q5 | 107 | 118 | | | XTEAWT-E0-0000-000000HDE5 | XTEAWT-E0-0000-000000UDE5 |
| | | Q4 | 100 | 110 | | | | XTEAWT-E0-0000-000000UCE5 |
| | | Q3 | 93.9 | 103 | | | | XTEAWT-E0-0000-000000UBE5 |
| | | Q2 | 87.4 | 96.1 | | | | XTEAWT-E0-0000-000000UAE5 |
| | | P4 | 80.6 | 88.6 | | | | XTEAWT-E0-0000-000000U9E5 |

Notes:

- Cree maintains a tolerance of $\pm 7\%$ on flux and power measurements, ± 0.005 on chromaticity (CCx, CCy) measurements and ± 2 on CRI measurements. See the Measurements section (page 40).
- Cree XLamp XT-E LED order codes specify only a minimum flux bin and not a maximum. Cree may ship reels in flux bins higher than the minimum specified by the order code without advance notice. Shipments will always adhere to the chromaticity or DWL bin restrictions specified by the order code.
- * Flux values @ 25 °C are calculated and for reference only.

FLUX CHARACTERISTICS - WHITE, HIGH EFFICACY (T_j = 85 °C) - CONTINUED

| Chromaticity | | Minimum Luminous Flux (lm) @ 350 mA | | | Order Codes | | | |
|--------------|--------|-------------------------------------|-------------------|--------------------|--------------------------|---------------------------|---------------------------|---------------------------|
| Kit | CCT | Code | Flux (lm) @ 85 °C | Flux (lm) @ 25 °C* | No Minimum CRI | 70 CRI Minimum | 80 CRI Minimum | 90 CRI Minimum |
| F6 | 3750 K | R5 | 139 | 153 | XTEAWT-E0-0000-000000HF6 | XTEAWT-E0-0000-000000BHF6 | | |
| | | R4 | 130 | 143 | XTEAWT-E0-0000-000000GF6 | XTEAWT-E0-0000-000000BGF6 | | |
| | | R3 | 122 | 134 | XTEAWT-E0-0000-000000FF6 | XTEAWT-E0-0000-000000BFF6 | XTEAWT-E0-0000-000000HFF6 | |
| | | R2 | 114 | 125 | XTEAWT-E0-0000-000000EF6 | XTEAWT-E0-0000-000000BEF6 | XTEAWT-E0-0000-000000HEF6 | XTEAWT-E0-0000-000000UEF6 |
| | | Q5 | 107 | 118 | | | XTEAWT-E0-0000-000000HDF6 | XTEAWT-E0-0000-000000UDF6 |
| | | Q4 | 100 | 110 | | | XTEAWT-E0-0000-000000HCF6 | XTEAWT-E0-0000-000000UCF6 |
| | | Q3 | 93.9 | 103 | | | | XTEAWT-E0-0000-000000UBF6 |
| | | Q2 | 87.4 | 96.1 | | | | XTEAWT-E0-0000-000000UAF6 |
| | | P4 | 80.6 | 88.6 | | | | XTEAWT-E0-0000-000000U9F6 |
| E6 | 3500 K | R5 | 139 | 153 | XTEAWT-E0-0000-000000HE6 | XTEAWT-E0-0000-000000BHE6 | | |
| | | R4 | 130 | 143 | XTEAWT-E0-0000-000000GE6 | XTEAWT-E0-0000-000000BGE6 | | |
| | | R3 | 122 | 134 | XTEAWT-E0-0000-000000FE6 | XTEAWT-E0-0000-000000BFE6 | XTEAWT-E0-0000-000000HFE6 | |
| | | R2 | 114 | 125 | XTEAWT-E0-0000-000000EE6 | XTEAWT-E0-0000-000000BEE6 | XTEAWT-E0-0000-000000HEE6 | XTEAWT-E0-0000-000000UEE6 |
| | | Q5 | 107 | 118 | | | XTEAWT-E0-0000-000000HDE6 | XTEAWT-E0-0000-000000UDE6 |
| | | Q4 | 100 | 110 | | | XTEAWT-E0-0000-000000HCE6 | XTEAWT-E0-0000-000000UCE6 |
| | | Q3 | 93.9 | 103 | | | | XTEAWT-E0-0000-000000UBE6 |
| | | Q2 | 87.4 | 96.1 | | | | XTEAWT-E0-0000-000000UAE6 |
| | | P4 | 80.6 | 88.6 | | | | XTEAWT-E0-0000-000000U9E6 |
| F7 | 3250 K | R4 | 130 | 143 | XTEAWT-E0-0000-000000GF7 | XTEAWT-E0-0000-000000BGF7 | | |
| | | R3 | 122 | 134 | XTEAWT-E0-0000-000000FF7 | XTEAWT-E0-0000-000000BFF7 | XTEAWT-E0-0000-000000HFF7 | |
| | | R2 | 114 | 125 | XTEAWT-E0-0000-000000EF7 | XTEAWT-E0-0000-000000BEF7 | XTEAWT-E0-0000-000000HEF7 | XTEAWT-E0-0000-000000UEF7 |
| | | Q5 | 107 | 118 | XTEAWT-E0-0000-000000DF7 | XTEAWT-E0-0000-000000BDF7 | XTEAWT-E0-0000-000000HDF7 | XTEAWT-E0-0000-000000UDF7 |
| | | Q4 | 100 | 110 | | | XTEAWT-E0-0000-000000HCF7 | XTEAWT-E0-0000-000000UCF7 |
| | | Q3 | 93.9 | 103 | | | | XTEAWT-E0-0000-000000UBF7 |
| | | Q2 | 87.4 | 96.1 | | | | XTEAWT-E0-0000-000000UAF7 |
| | | P4 | 80.6 | 88.6 | | | | XTEAWT-E0-0000-000000U9F7 |
| | | P3 | 73.9 | 81.2 | | | | XTEAWT-E0-0000-000000U8F7 |

Notes:

- Cree maintains a tolerance of ±7% on flux and power measurements, ±0.005 on chromaticity (CCx, CCy) measurements and ±2 on CRI measurements. See the Measurements section (page 40).
- Cree XLamp XT-E LED order codes specify only a minimum flux bin and not a maximum. Cree may ship reels in flux bins higher than the minimum specified by the order code without advance notice. Shipments will always adhere to the chromaticity or DWL bin restrictions specified by the order code.
- * Flux values @ 25 °C are calculated and for reference only.

FLUX CHARACTERISTICS - WHITE, HIGH EFFICACY (T_j = 85 °C) - CONTINUED

| Chromaticity | | Minimum Luminous Flux (lm) @ 350 mA | | | Order Codes | | | |
|--------------|--------|-------------------------------------|-------------------|--------------------|--------------------------|---------------------------|---------------------------|---------------------------|
| Kit | CCT | Code | Flux (lm) @ 85 °C | Flux (lm) @ 25 °C* | No Minimum CRI | 70 CRI Minimum | 80 CRI Minimum | 90 CRI Minimum |
| E7 | 3000 K | R4 | 130 | 143 | XTEAWT-E0-0000-000000GE7 | XTEAWT-E0-0000-000000BGE7 | | |
| | | R3 | 122 | 134 | XTEAWT-E0-0000-000000FE7 | XTEAWT-E0-0000-000000BFE7 | XTEAWT-E0-0000-000000HFE7 | |
| | | R2 | 114 | 125 | XTEAWT-E0-0000-000000EE7 | XTEAWT-E0-0000-000000BEE7 | XTEAWT-E0-0000-000000HEE7 | XTEAWT-E0-0000-000000UEE7 |
| | | Q5 | 107 | 118 | XTEAWT-E0-0000-000000DE7 | XTEAWT-E0-0000-000000BDE7 | XTEAWT-E0-0000-000000HDE7 | XTEAWT-E0-0000-000000UDE7 |
| | | Q4 | 100 | 110 | | | XTEAWT-E0-0000-000000HCE7 | XTEAWT-E0-0000-000000UCE7 |
| | | Q3 | 93.9 | 103 | | | | XTEAWT-E0-0000-000000UBE7 |
| | | Q2 | 87.4 | 96.1 | | | | XTEAWT-E0-0000-000000UAE7 |
| | | P4 | 80.6 | 88.6 | | | | XTEAWT-E0-0000-000000U9E7 |
| | | P3 | 73.9 | 81.2 | | | | XTEAWT-E0-0000-000000U8E7 |
| F8 | 2850 K | R3 | 122 | 134 | XTEAWT-E0-0000-000000FF8 | XTEAWT-E0-0000-000000BFF8 | | |
| | | R2 | 114 | 125 | XTEAWT-E0-0000-000000EF8 | XTEAWT-E0-0000-000000BEF8 | XTEAWT-E0-0000-000000HEF8 | |
| | | Q5 | 107 | 118 | XTEAWT-E0-0000-000000DF8 | XTEAWT-E0-0000-000000BDF8 | XTEAWT-E0-0000-000000HDF8 | XTEAWT-E0-0000-000000UDF8 |
| | | Q4 | 100 | 110 | XTEAWT-E0-0000-000000CF8 | XTEAWT-E0-0000-000000BCF8 | XTEAWT-E0-0000-000000HCF8 | XTEAWT-E0-0000-000000UCF8 |
| | | Q3 | 93.9 | 103 | | | XTEAWT-E0-0000-000000HBF8 | XTEAWT-E0-0000-000000UBF8 |
| | | Q2 | 87.4 | 96.1 | | | | XTEAWT-E0-0000-000000UAF8 |
| | | P4 | 80.6 | 88.6 | | | | XTEAWT-E0-0000-000000U9F8 |
| | | P3 | 73.9 | 81.2 | | | | XTEAWT-E0-0000-000000U8F8 |
| E8 | 2700 K | R3 | 122 | 134 | XTEAWT-E0-0000-000000FE8 | XTEAWT-E0-0000-000000BFE8 | | |
| | | R2 | 114 | 125 | XTEAWT-E0-0000-000000EE8 | XTEAWT-E0-0000-000000BEE8 | XTEAWT-E0-0000-000000HEE8 | |
| | | Q5 | 107 | 118 | XTEAWT-E0-0000-000000DE8 | XTEAWT-E0-0000-000000BDE8 | XTEAWT-E0-0000-000000HDE8 | XTEAWT-E0-0000-000000UDE8 |
| | | Q4 | 100 | 110 | XTEAWT-E0-0000-000000CE8 | XTEAWT-E0-0000-000000BCE8 | XTEAWT-E0-0000-000000HCE8 | XTEAWT-E0-0000-000000UCE8 |
| | | Q3 | 93.9 | 103 | | | XTEAWT-E0-0000-000000HBE8 | XTEAWT-E0-0000-000000UBE8 |
| | | Q2 | 87.4 | 96.1 | | | | XTEAWT-E0-0000-000000UAE8 |
| | | P4 | 80.6 | 88.6 | | | | XTEAWT-E0-0000-000000U9E8 |
| | | P3 | 73.9 | 81.2 | | | | XTEAWT-E0-0000-000000U8E8 |
| EA | 2200 K | Q4 | 100 | 110 | | XTEAWT-E0-0000-000000BCEA | | |
| | | Q3 | 93.9 | 103 | | XTEAWT-E0-0000-000000BBEA | XTEAWT-E0-0000-000000HBEA | |
| | | Q2 | 87.4 | 96.1 | | XTEAWT-E0-0000-000000BAEA | XTEAWT-E0-0000-000000HAEA | |
| | | P4 | 80.6 | 88.6 | | XTEAWT-E0-0000-000000B9EA | XTEAWT-E0-0000-000000H9EA | |
| | | P3 | 73.9 | 81.2 | | | XTEAWT-E0-0000-000000H8EA | |

Note:

- Cree maintains a tolerance of ±7% on flux and power measurements, ±0.005 on chromaticity (CCx, CCy) measurements, ±2 on CRI measurements and ±1 nm on dominant wavelength measurements. See the Measurements section (page 40).
- Cree XLamp XT-E LED order codes specify only a minimum flux bin and not a maximum. Cree may ship reels in flux bins higher than the minimum specified by the order code without advance notice. Shipments will always adhere to the chromaticity or DWL bin restrictions specified by the order code.
- Calculated Photosynthetic Photon Flux (PPF) values are for reference only.

FLUX CHARACTERISTICS - ROYAL BLUE ($T_j = 85\text{ }^\circ\text{C}$)

The following tables provide order codes for XLamp XT-E Royal Blue LEDs. For a complete description of the order code nomenclature, please see the Bin and Order Code Formats section (page 38).

| DWL Kit Codes | Dominant Wavelength Range | | | | Order Codes, Minimum Radiant Flux @ 350 mA, $T_j=85\text{ }^\circ\text{C}$ | | | | | |
|---------------|---------------------------|----------|---------|----------|--|---|---|---|---|---|
| | Minimum | | Maximum | | 475 mW - Radiant Flux Group Code 31(K) | 500 mW - Radiant Flux Group Code 32(L) | 525 mW - Radiant Flux Group Code 33(M) | 550 mW - Radiant Flux Group Code 34(N) | 575 mW - Radiant Flux Group Code 35(P) | 600 mW - Radiant Flux Group Code 36(Q) |
| | Group | DWL (nm) | Group | DWL (nm) | | | | | | |
| | | | | | Calculated PPF ($\mu\text{mol/s}$) = 1.80 | Calculated PPF ($\mu\text{mol/s}$) = 1.90 | Calculated PPF ($\mu\text{mol/s}$) = 1.99 | Calculated PPF ($\mu\text{mol/s}$) = 2.08 | Calculated PPF ($\mu\text{mol/s}$) = 2.18 | Calculated PPF ($\mu\text{mol/s}$) = 2.27 |
| 01 | D36 | 450 | D57 | 465 | XTEARY-00-0000-000000K01 | XTEARY-00-0000-000000L01 | XTEARY-00-0000-000000M01 | XTEARY-00-0000-000000N01 | XTEARY-00-0000-000000P01 | XTEARY-00-0000-000000Q01 |
| 02 | D36 | 450 | D47 | 460 | XTEARY-00-0000-000000K02 | XTEARY-00-0000-000000L02 | XTEARY-00-0000-000000M02 | XTEARY-00-0000-000000N02 | XTEARY-00-0000-000000P02 | XTEARY-00-0000-000000Q02 |
| 03 | D46 | 455 | D57 | 465 | XTEARY-00-0000-000000K03 | XTEARY-00-0000-000000L03 | XTEARY-00-0000-000000M03 | XTEARY-00-0000-000000N03 | XTEARY-00-0000-000000P03 | |
| 04 | D36 | 450 | D37 | 455 | XTEARY-00-0000-000000K04 | XTEARY-00-0000-000000L04 | XTEARY-00-0000-000000M04 | XTEARY-00-0000-000000N04 | XTEARY-00-0000-000000P04 | XTEARY-00-0000-000000Q04 |
| 05 | D46 | 455 | D47 | 460 | XTEARY-00-0000-000000K05 | XTEARY-00-0000-000000L05 | XTEARY-00-0000-000000M05 | XTEARY-00-0000-000000N05 | XTEARY-00-0000-000000P05 | |
| 06 | D56 | 460 | D57 | 465 | XTEARY-00-0000-000000K06 | XTEARY-00-0000-000000L06 | XTEARY-00-0000-000000M06 | XTEARY-00-0000-000000N06 | | |
| 07 | D37 | 452.5 | D46 | 457.5 | XTEARY-00-0000-000000K07 | XTEARY-00-0000-000000L07 | XTEARY-00-0000-000000M07 | XTEARY-00-0000-000000N07 | XTEARY-00-0000-000000P07 | |
| 08 | D47 | 457.5 | D56 | 462.5 | XTEARY-00-0000-000000K08 | XTEARY-00-0000-000000L08 | XTEARY-00-0000-000000M08 | XTEARY-00-0000-000000N08 | | |
| 09 | D37 | 452.5 | D56 | 462.5 | XTEARY-00-0000-000000K09 | XTEARY-00-0000-000000L09 | XTEARY-00-0000-000000M09 | XTEARY-00-0000-000000N09 | XTEARY-00-0000-000000P09 | |

RELATIVE SPECTRAL POWER DISTRIBUTION - WHITE

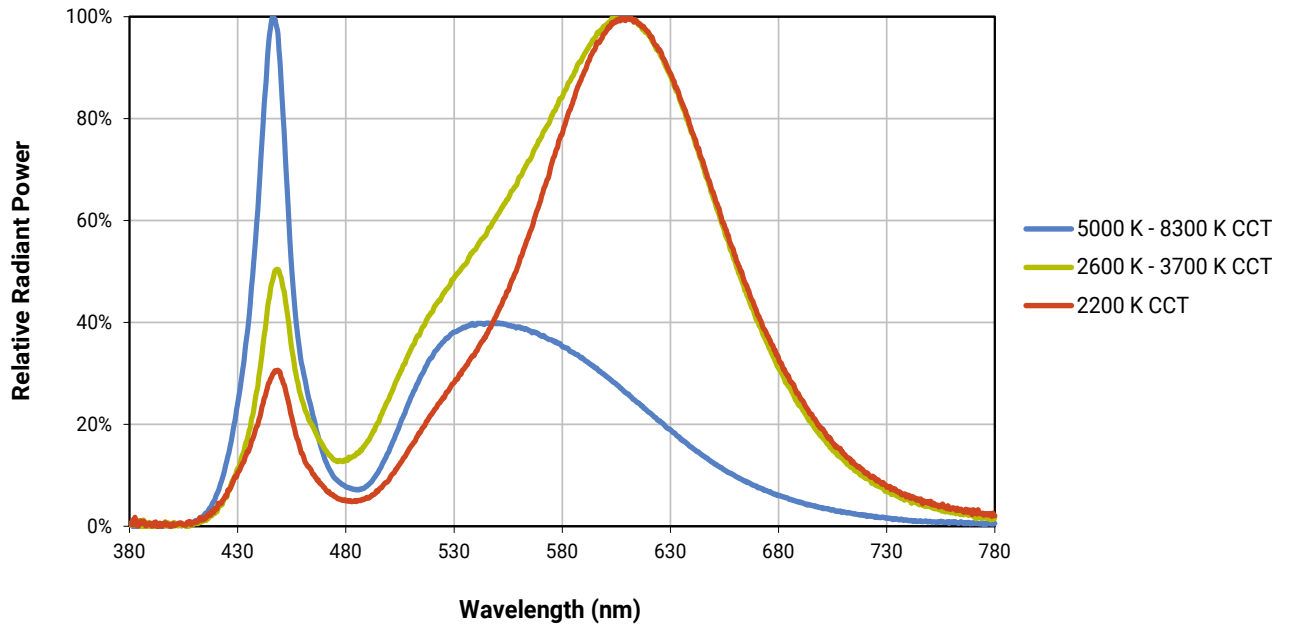

RELATIVE SPECTRAL POWER DISTRIBUTION - ROYAL BLUE

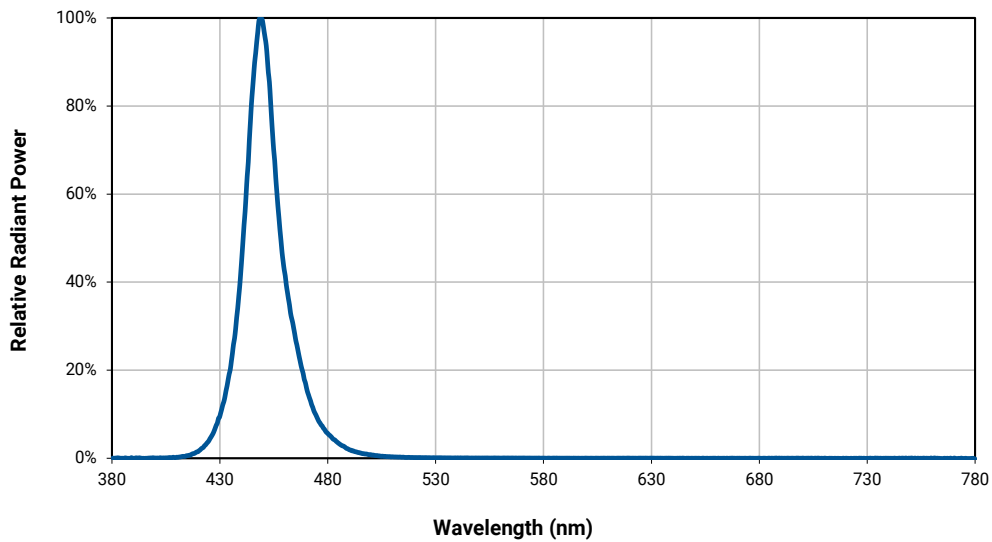

RELATIVE LUMINOUS FLUX VS. JUNCTION TEMPERATURE - WHITE ($I_F = 350\text{ mA}$)

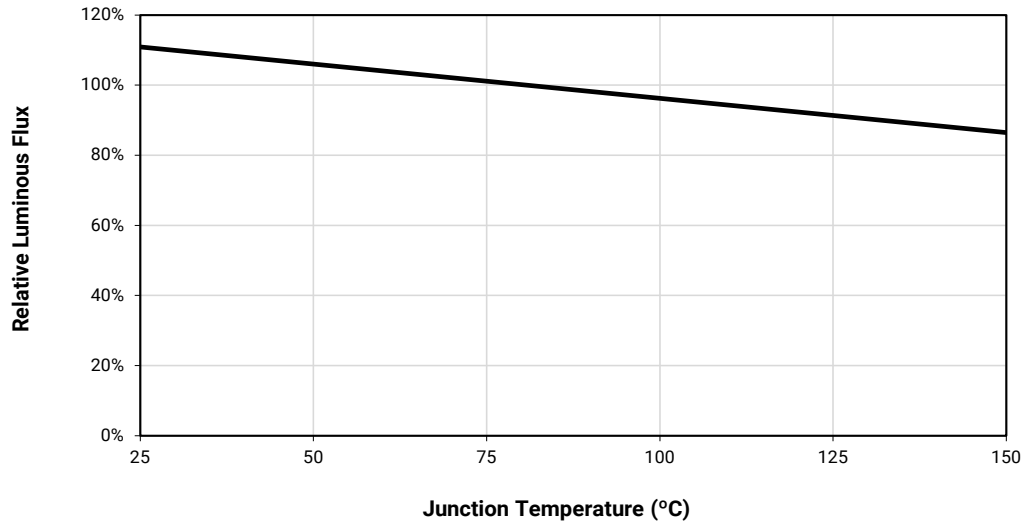

RELATIVE RADIANT FLUX VS. JUNCTION TEMPERATURE - ROYAL BLUE ($I_F = 350\text{ mA}$)

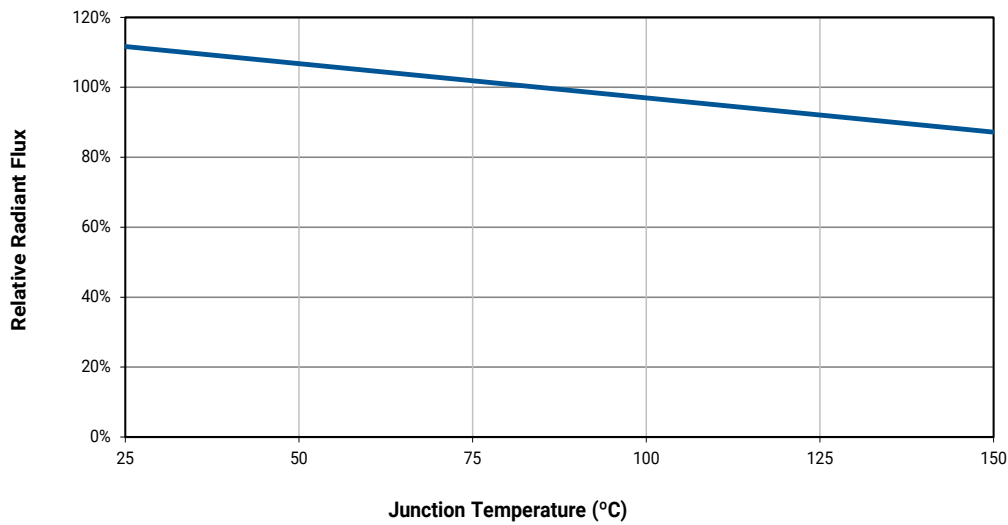

ELECTRICAL CHARACTERISTICS - WHITE, STANDARD, ROYAL BLUE ($T_j = 85\text{ }^\circ\text{C}$)

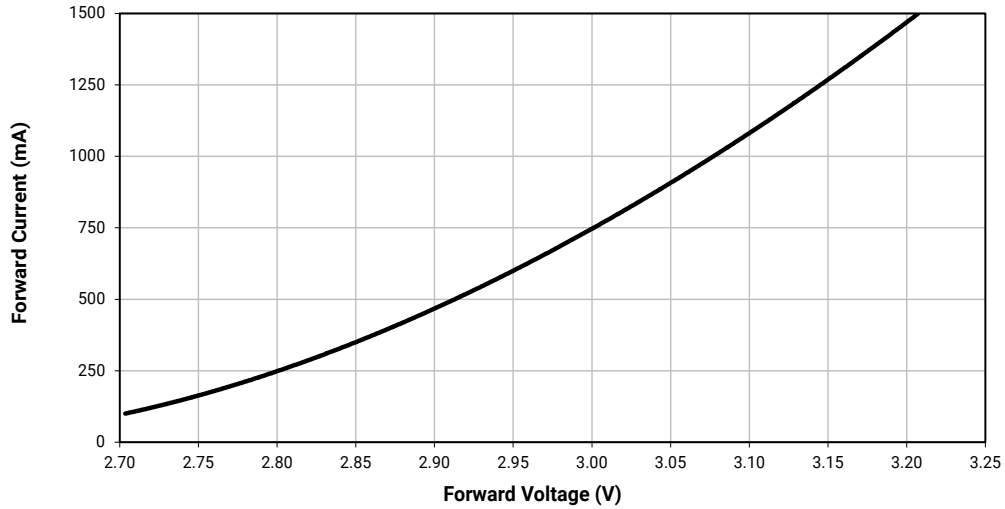

ELECTRICAL CHARACTERISTICS - WHITE, HIGH EFFICACY ($T_j = 85\text{ }^\circ\text{C}$)

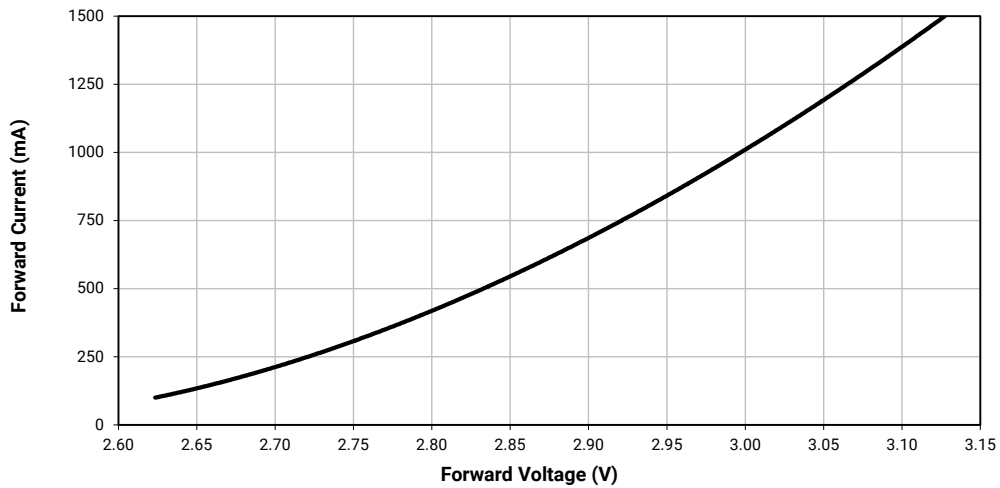

RELATIVE LUMINOUS FLUX VS. CURRENT - WHITE ($T_j = 85\text{ }^\circ\text{C}$)

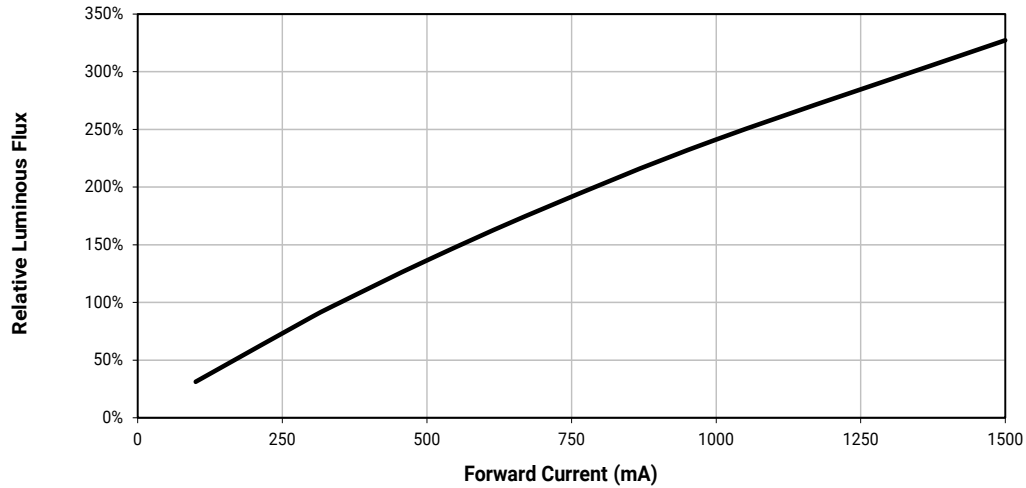

RELATIVE RADIANT FLUX VS. CURRENT - ROYAL BLUE ($T_j = 85\text{ }^\circ\text{C}$)

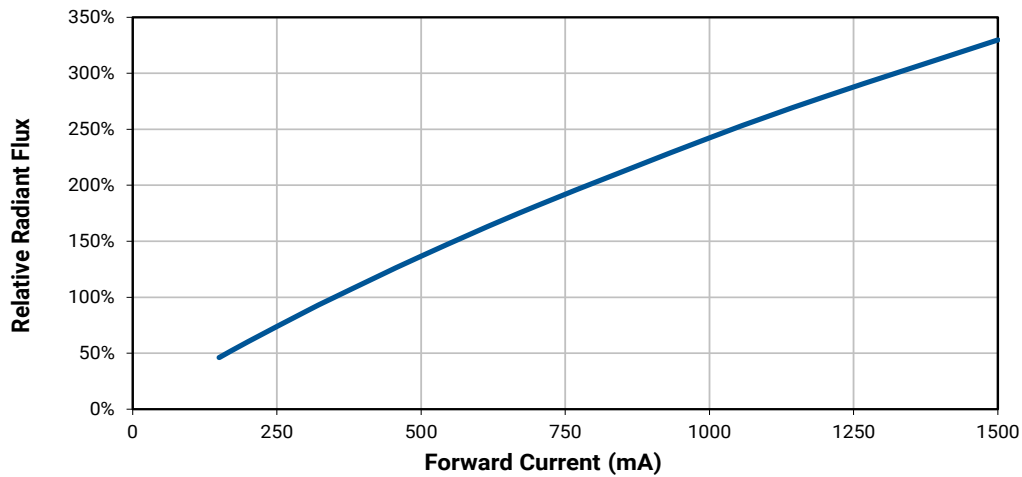

RELATIVE CHROMATICITY VS. CURRENT AND TEMPERATURE - WARM WHITE

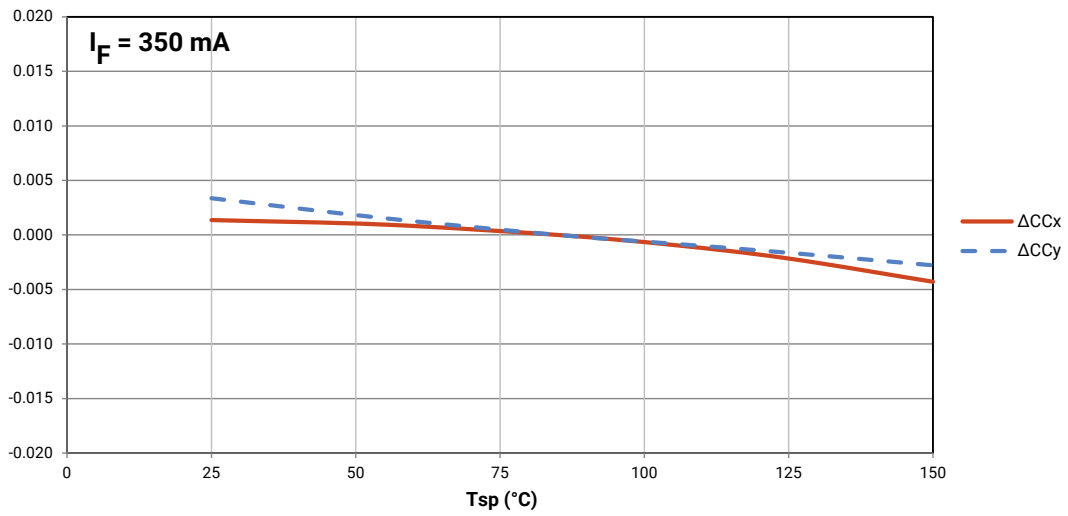
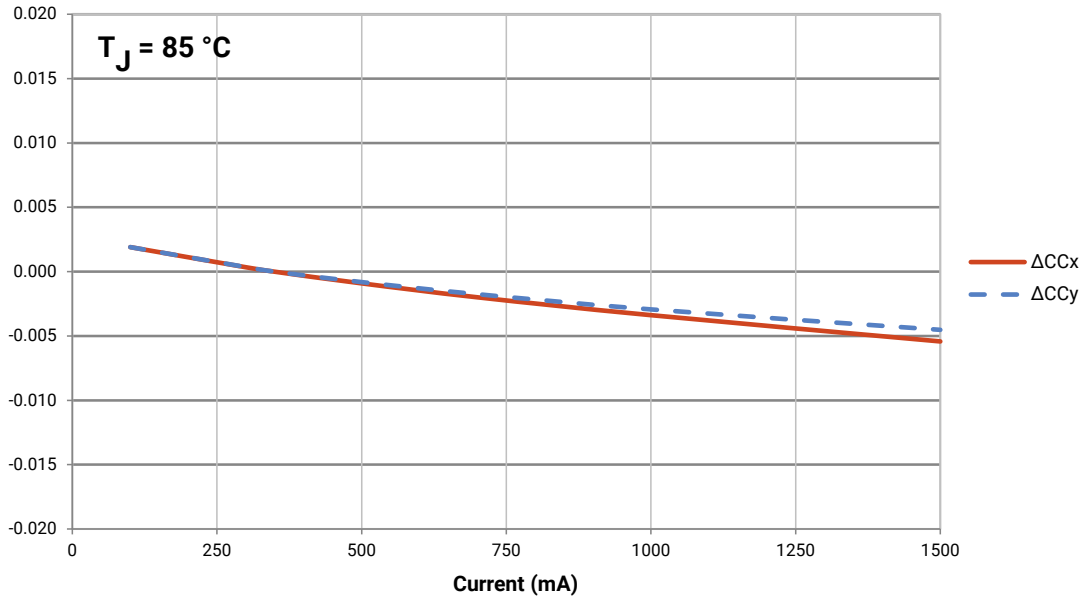

TYPICAL SPATIAL DISTRIBUTION - WHITE

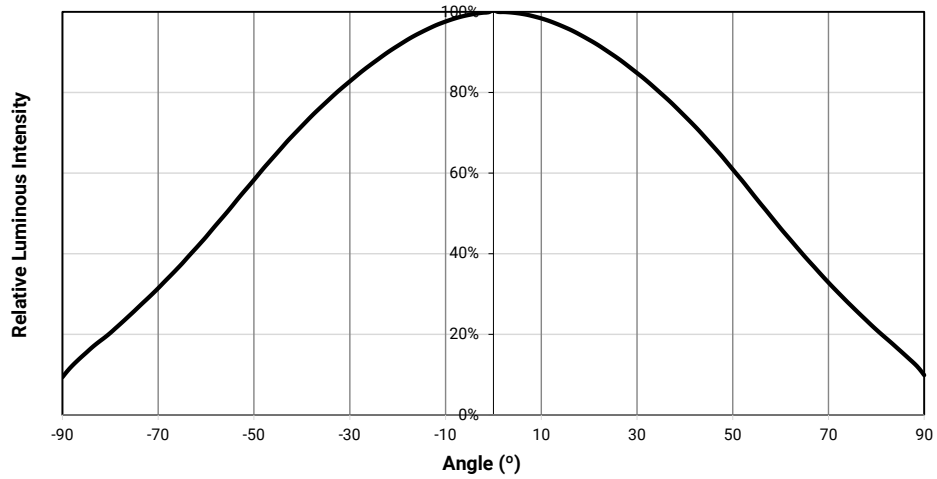

TYPICAL SPATIAL DISTRIBUTION - ROYAL BLUE

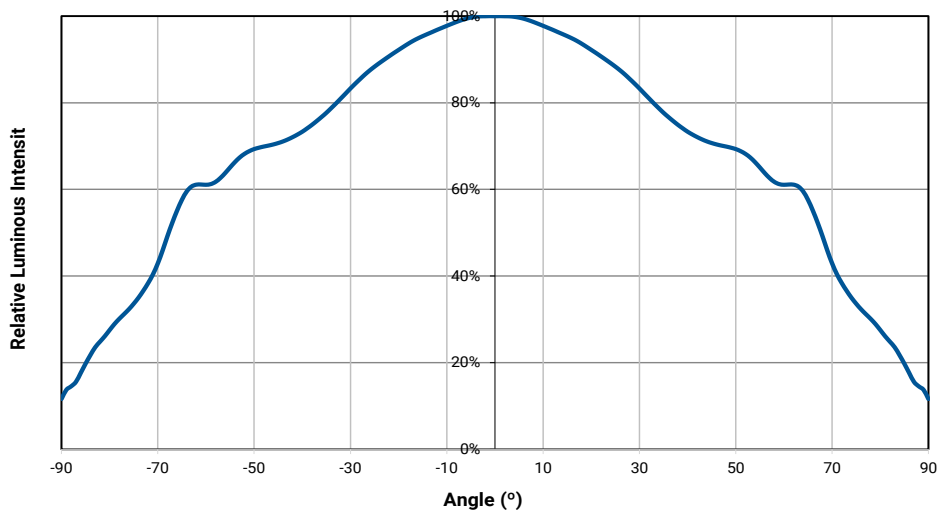

THERMAL DESIGN - WHITE

The maximum forward current is determined by the thermal resistance between the LED junction and ambient. It is crucial for the end product to be designed in a manner that minimizes the thermal resistance from the solder point to ambient in order to optimize lamp life and optical characteristics.

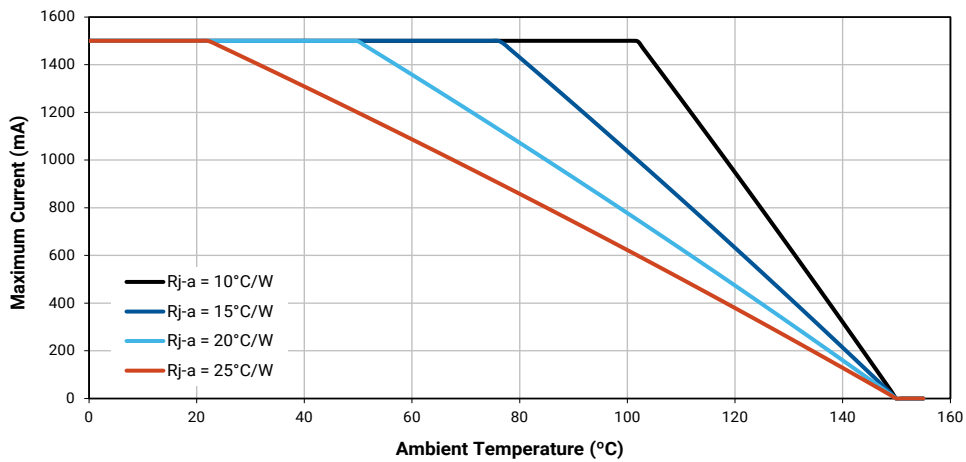

THERMAL DESIGN - ROYAL BLUE

The maximum forward current is determined by the thermal resistance between the LED junction and ambient. It is crucial for the end product to be designed in a manner that minimizes the thermal resistance from the solder point to ambient in order to optimize lamp life and optical characteristics.

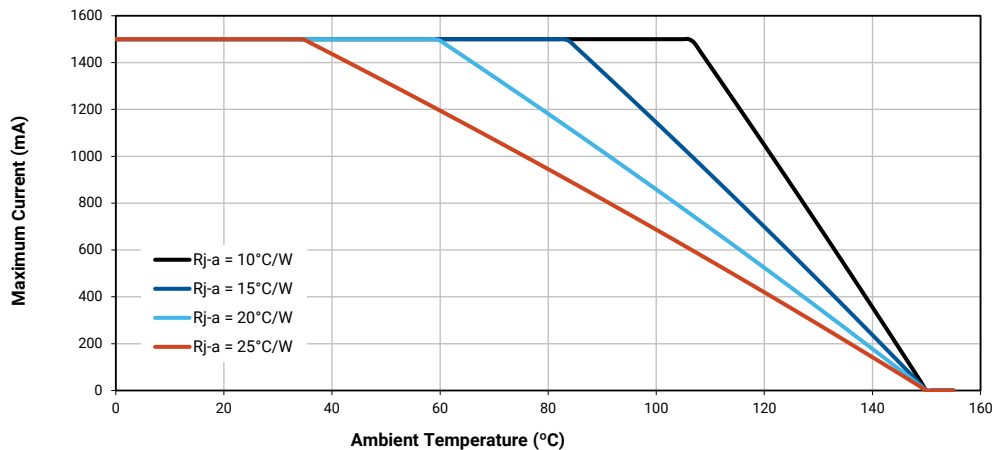

PERFORMANCE GROUPS - LUMINOUS FLUX ($T_J = 85\text{ }^\circ\text{C}$)

XLamp XT-E White LEDs are tested for luminous flux and placed into one of the following luminous-flux groups.

| Group Code | Minimum Luminous Flux (lm) @ 350 mA | Maximum Luminous Flux (lm) @ 350 mA |
|------------|-------------------------------------|-------------------------------------|
| P3 | 73.9 | 80.6 |
| P4 | 80.6 | 87.4 |
| Q2 | 87.4 | 93.9 |
| Q3 | 93.9 | 100 |
| Q4 | 100 | 107 |
| Q5 | 107 | 114 |
| R2 | 114 | 122 |
| R3 | 122 | 130 |
| R4 | 130 | 139 |
| R5 | 139 | 148 |
| S2 | 148 | 156 |
| S3 | 156 | 164 |
| S4 | 164 | 172 |
| S5 | 172 | 188 |

PERFORMANCE GROUPS - RADIANT FLUX ($T_J = 85\text{ }^\circ\text{C}$)

XLamp XT-E Royal Blue LEDs are tested for radiant flux and placed into one the following bins.

| Group Code | Minimum Radiant Flux (mW) | Maximum Radiant Flux (mW) | Calculated PPF ($\mu\text{mol/s}$) | |
|------------|---------------------------|---------------------------|--------------------------------------|---------|
| | | | Minimum | Maximum |
| 31 (K) | 475 | 500 | 1.80 | 1.90 |
| 32 (L) | 500 | 525 | 1.90 | 1.99 |
| 33 (M) | 525 | 550 | 1.99 | 2.08 |
| 34 (N) | 550 | 575 | 2.08 | 2.18 |
| 35 (P) | 575 | 600 | 2.18 | 2.27 |
| 36 (Q) | 600 | 625 | 2.27 | 2.37 |

Note

- Calculated PPF values are for reference only.

PERFORMANCE GROUPS - DOMINANT WAVELENGTH ($T_J = 85\text{ }^\circ\text{C}$)

XLamp XT-E Royal Blue LEDs are tested for dominant wavelength (DWL) and placed into one of the regions defined by the following bounding coordinates.

| Group Code | Minimum Dominant Wavelength (nm) | Maximum Dominant Wavelength (nm) | Typical Peak Wavelength (nm) |
|------------|----------------------------------|----------------------------------|------------------------------|
| D36 | 450.0 | 452.5 | 446.0 |
| D37 | 452.5 | 455.0 | 448.5 |
| D46 | 455.0 | 457.5 | 451.0 |
| D47 | 457.5 | 460.0 | 453.5 |
| D56 | 460.0 | 462.5 | 456.0 |
| D57 | 462.5 | 465.0 | 458.5 |

Note

- Typical peak wavelength values are calculated and for reference only.

PERFORMANCE GROUPS - FORWARD VOLTAGE ($T_J = 85\text{ }^\circ\text{C}$)

XLamp XT-E LEDs are tested for forward voltage and placed into one of the following voltage bins.

| Group Code | Minimum Forward Voltage (V) | Maximum Forward Voltage (V) |
|------------|-----------------------------|-----------------------------|
| 1 | 2.50 | 2.85 |
| E | 2.50 | 2.75 |
| F | 2.75 | 3.00 |
| G | 3.00 | 3.25 |
| H | 3.25 | 3.50 |

PERFORMANCE GROUPS - CHROMATICITY

| Region | x | y | Region | x | y | Region | x | y | Region | x | y |
|--------|--------|--------|--------|--------|--------|--------|--------|--------|--------|--------|--------|
| 0A | 0.2950 | 0.2970 | 0B | 0.2920 | 0.3060 | 0C | 0.2984 | 0.3133 | 0D | 0.2984 | 0.3133 |
| | 0.2920 | 0.3060 | | 0.2895 | 0.3135 | | 0.2962 | 0.3220 | | 0.3048 | 0.3207 |
| | 0.2984 | 0.3133 | | 0.2962 | 0.3220 | | 0.3028 | 0.3304 | | 0.3068 | 0.3113 |
| | 0.3009 | 0.3042 | | 0.2984 | 0.3133 | | 0.3048 | 0.3207 | | 0.3009 | 0.3042 |
| 0R | 0.2980 | 0.2880 | 0S | 0.2895 | 0.3135 | 0T | 0.2962 | 0.3220 | 0U | 0.3037 | 0.2937 |
| | 0.2950 | 0.2970 | | 0.2870 | 0.3210 | | 0.2937 | 0.3312 | | 0.3009 | 0.3042 |
| | 0.3009 | 0.3042 | | 0.2937 | 0.3312 | | 0.3005 | 0.3415 | | 0.3068 | 0.3113 |
| | 0.3037 | 0.2937 | | 0.2962 | 0.3220 | | 0.3028 | 0.3304 | | 0.3093 | 0.2993 |
| 1A | 0.3048 | 0.3207 | 1B | 0.3028 | 0.3304 | 1C | 0.3115 | 0.3391 | 1D | 0.3130 | 0.3290 |
| | 0.3130 | 0.3290 | | 0.3115 | 0.3391 | | 0.3205 | 0.3481 | | 0.3213 | 0.3373 |
| | 0.3144 | 0.3186 | | 0.3130 | 0.3290 | | 0.3213 | 0.3373 | | 0.3221 | 0.3261 |
| | 0.3068 | 0.3113 | | 0.3048 | 0.3207 | | 0.3130 | 0.3290 | | 0.3144 | 0.3186 |

PERFORMANCE GROUPS - CHROMATICITY (CONTINUED)

| Region | x | y | Region | x | y | Region | x | y | Region | x | y |
|--------|--------|--------|--------|--------|--------|--------|--------|--------|--------|--------|--------|
| 1R | 0.3068 | 0.3113 | 1S | 0.3005 | 0.3415 | 1T | 0.3099 | 0.3509 | 1U | 0.3144 | 0.3186 |
| | 0.3144 | 0.3186 | | 0.3099 | 0.3509 | | 0.3196 | 0.3602 | | 0.3221 | 0.3261 |
| | 0.3161 | 0.3059 | | 0.3115 | 0.3391 | | 0.3205 | 0.3481 | | 0.3231 | 0.3120 |
| | 0.3093 | 0.2993 | | 0.3028 | 0.3304 | | 0.3115 | 0.3391 | | 0.3161 | 0.3059 |
| 2A | 0.3215 | 0.3350 | 2B | 0.3207 | 0.3462 | 2C | 0.3290 | 0.3538 | 2D | 0.3290 | 0.3417 |
| | 0.3290 | 0.3417 | | 0.3290 | 0.3538 | | 0.3376 | 0.3616 | | 0.3371 | 0.3490 |
| | 0.3290 | 0.3300 | | 0.3290 | 0.3417 | | 0.3371 | 0.3490 | | 0.3366 | 0.3369 |
| | 0.3222 | 0.3243 | | 0.3215 | 0.3350 | | 0.3290 | 0.3417 | | 0.3290 | 0.3300 |
| 2R | 0.3222 | 0.3243 | 2S | 0.3196 | 0.3602 | 2T | 0.3290 | 0.3690 | 2U | 0.3290 | 0.3300 |
| | 0.3290 | 0.3300 | | 0.3290 | 0.3690 | | 0.3381 | 0.3762 | | 0.3366 | 0.3369 |
| | 0.3290 | 0.3180 | | 0.3290 | 0.3538 | | 0.3376 | 0.3616 | | 0.3361 | 0.3245 |
| | 0.3231 | 0.3120 | | 0.3207 | 0.3462 | | 0.3290 | 0.3538 | | 0.3290 | 0.3180 |
| 3A | 0.3371 | 0.3490 | 3B | 0.3376 | 0.3616 | 3C | 0.3463 | 0.3687 | 3D | 0.3451 | 0.3554 |
| | 0.3451 | 0.3554 | | 0.3463 | 0.3687 | | 0.3551 | 0.3760 | | 0.3533 | 0.3620 |
| | 0.3440 | 0.3427 | | 0.3451 | 0.3554 | | 0.3533 | 0.3620 | | 0.3515 | 0.3487 |
| | 0.3366 | 0.3369 | | 0.3371 | 0.3490 | | 0.3451 | 0.3554 | | 0.3440 | 0.3427 |
| 3R | 0.3366 | 0.3369 | 3S | 0.3381 | 0.3762 | | | | | | |
| | 0.3440 | 0.3428 | | 0.3480 | 0.3840 | | | | | | |
| | 0.3429 | 0.3307 | | 0.3463 | 0.3687 | | | | | | |
| | 0.3361 | 0.3245 | | 0.3376 | 0.3616 | | | | | | |
| 4A | 0.3530 | 0.3597 | 4B | 0.3548 | 0.3736 | 4C | 0.3641 | 0.3804 | 4D | 0.3615 | 0.3659 |
| | 0.3615 | 0.3659 | | 0.3641 | 0.3804 | | 0.3736 | 0.3874 | | 0.3702 | 0.3722 |
| | 0.3590 | 0.3521 | | 0.3615 | 0.3659 | | 0.3702 | 0.3722 | | 0.3670 | 0.3578 |
| | 0.3512 | 0.3465 | | 0.3530 | 0.3597 | | 0.3615 | 0.3659 | | 0.3590 | 0.3521 |
| 4R | 0.3512 | 0.3465 | 4S | 0.3571 | 0.3907 | 4T | 0.3668 | 0.3957 | 4U | 0.3590 | 0.3521 |
| | 0.3590 | 0.3521 | | 0.3668 | 0.3957 | | 0.3771 | 0.4034 | | 0.3670 | 0.3578 |
| | 0.3567 | 0.3389 | | 0.3641 | 0.3804 | | 0.3736 | 0.3874 | | 0.3640 | 0.3440 |
| | 0.3495 | 0.3339 | | 0.3548 | 0.3736 | | 0.3641 | 0.3804 | | 0.3567 | 0.3389 |
| 5A1 | 0.3670 | 0.3578 | 5A2 | 0.3686 | 0.3649 | 5A3 | 0.3744 | 0.3685 | 5A4 | 0.3726 | 0.3612 |
| | 0.3686 | 0.3649 | | 0.3702 | 0.3722 | | 0.3763 | 0.3760 | | 0.3744 | 0.3685 |
| | 0.3744 | 0.3685 | | 0.3763 | 0.3760 | | 0.3825 | 0.3798 | | 0.3804 | 0.3721 |
| | 0.3726 | 0.3612 | | 0.3744 | 0.3685 | | 0.3804 | 0.3721 | | 0.3783 | 0.3646 |
| 5B1 | 0.3702 | 0.3722 | 5B2 | 0.3719 | 0.3797 | 5B3 | 0.3782 | 0.3837 | 5B4 | 0.3763 | 0.3760 |
| | 0.3719 | 0.3797 | | 0.3736 | 0.3874 | | 0.3802 | 0.3916 | | 0.3782 | 0.3837 |
| | 0.3782 | 0.3837 | | 0.3802 | 0.3916 | | 0.3869 | 0.3958 | | 0.3847 | 0.3877 |
| | 0.3763 | 0.3760 | | 0.3782 | 0.3837 | | 0.3847 | 0.3877 | | 0.3825 | 0.3798 |
| 5C1 | 0.3825 | 0.3798 | 5C2 | 0.3847 | 0.3877 | 5C3 | 0.3912 | 0.3917 | 5C4 | 0.3887 | 0.3836 |
| | 0.3847 | 0.3877 | | 0.3869 | 0.3958 | | 0.3937 | 0.4001 | | 0.3912 | 0.3917 |
| | 0.3912 | 0.3917 | | 0.3937 | 0.4001 | | 0.4006 | 0.4044 | | 0.3978 | 0.3958 |
| | 0.3887 | 0.3836 | | 0.3912 | 0.3917 | | 0.3978 | 0.3958 | | 0.3950 | 0.3875 |

PERFORMANCE GROUPS - CHROMATICITY (CONTINUED)

| Region | x | y | Region | x | y | Region | x | y | Region | x | y |
|--------|--------|--------|--------|--------|--------|--------|--------|--------|--------|--------|--------|
| 5D1 | 0.3783 | 0.3646 | 5D2 | 0.3804 | 0.3721 | 5D3 | 0.3863 | 0.3758 | 5D4 | 0.3840 | 0.3681 |
| | 0.3804 | 0.3721 | | 0.3825 | 0.3798 | | 0.3887 | 0.3836 | | 0.3863 | 0.3758 |
| | 0.3863 | 0.3758 | | 0.3887 | 0.3836 | | 0.3950 | 0.3875 | | 0.3924 | 0.3794 |
| | 0.3840 | 0.3681 | | 0.3863 | 0.3758 | | 0.3924 | 0.3794 | | 0.3898 | 0.3716 |
| 5R | 0.3670 | 0.3578 | 5S | 0.3771 | 0.4034 | | | | | | |
| | 0.3783 | 0.3646 | | 0.3916 | 0.4127 | | | | | | |
| | 0.3743 | 0.3502 | | 0.3869 | 0.3958 | | | | | | |
| | 0.3640 | 0.3440 | | 0.3736 | 0.3874 | | | | | | |
| 6A1 | 0.3889 | 0.3690 | 6A2 | 0.3915 | 0.3768 | 6A3 | 0.3981 | 0.3800 | 6A4 | 0.4080 | 0.3916 |
| | 0.3915 | 0.3768 | | 0.3941 | 0.3848 | | 0.4010 | 0.3882 | | 0.3981 | 0.3800 |
| | 0.3981 | 0.3800 | | 0.4010 | 0.3882 | | 0.4080 | 0.3916 | | 0.4048 | 0.3832 |
| | 0.3953 | 0.3720 | | 0.3981 | 0.3800 | | 0.4048 | 0.3832 | | 0.4017 | 0.3751 |
| 6B1 | 0.3941 | 0.3848 | 6B2 | 0.3968 | 0.3930 | 6B3 | 0.4040 | 0.3966 | 6B4 | 0.4010 | 0.3882 |
| | 0.3968 | 0.3930 | | 0.3996 | 0.4015 | | 0.4071 | 0.4052 | | 0.4040 | 0.3966 |
| | 0.4040 | 0.3966 | | 0.4071 | 0.4052 | | 0.4146 | 0.4089 | | 0.4113 | 0.4001 |
| | 0.4010 | 0.3882 | | 0.4040 | 0.3966 | | 0.4113 | 0.4001 | | 0.4080 | 0.3916 |
| 6C1 | 0.4080 | 0.3916 | 6C2 | 0.4113 | 0.4001 | 6C3 | 0.4186 | 0.4037 | 6C4 | 0.4150 | 0.3950 |
| | 0.4113 | 0.4001 | | 0.4146 | 0.4089 | | 0.4222 | 0.4127 | | 0.4186 | 0.4037 |
| | 0.4186 | 0.4037 | | 0.4222 | 0.4127 | | 0.4299 | 0.4165 | | 0.4259 | 0.4073 |
| | 0.4150 | 0.3950 | | 0.4186 | 0.4037 | | 0.4259 | 0.4073 | | 0.4221 | 0.3984 |
| 6D1 | 0.4017 | 0.3751 | 6D2 | 0.4048 | 0.3832 | 6D3 | 0.4116 | 0.3865 | 6D4 | 0.4082 | 0.3782 |
| | 0.4048 | 0.3832 | | 0.4080 | 0.3916 | | 0.4150 | 0.3950 | | 0.4116 | 0.3865 |
| | 0.4116 | 0.3865 | | 0.4150 | 0.3950 | | 0.4221 | 0.3984 | | 0.4183 | 0.3898 |
| | 0.4082 | 0.3782 | | 0.4116 | 0.3865 | | 0.4183 | 0.3898 | | 0.4147 | 0.3814 |
| 7A1 | 0.4147 | 0.3814 | 7A2 | 0.4183 | 0.3898 | 7A3 | 0.4242 | 0.3919 | 7A4 | 0.4203 | 0.3833 |
| | 0.4183 | 0.3898 | | 0.4221 | 0.3984 | | 0.4281 | 0.4006 | | 0.4242 | 0.3919 |
| | 0.4242 | 0.3919 | | 0.4281 | 0.4006 | | 0.4342 | 0.4028 | | 0.4300 | 0.3939 |
| | 0.4203 | 0.3833 | | 0.4242 | 0.3919 | | 0.4300 | 0.3939 | | 0.4259 | 0.3853 |
| 7B1 | 0.4221 | 0.3984 | 7B2 | 0.4259 | 0.4073 | 7B3 | 0.4322 | 0.4096 | 7B4 | 0.4281 | 0.4006 |
| | 0.4259 | 0.4073 | | 0.4299 | 0.4165 | | 0.4364 | 0.4188 | | 0.4322 | 0.4096 |
| | 0.4322 | 0.4096 | | 0.4364 | 0.4188 | | 0.4430 | 0.4212 | | 0.4385 | 0.4119 |
| | 0.4281 | 0.4006 | | 0.4322 | 0.4096 | | 0.4385 | 0.4119 | | 0.4342 | 0.4028 |
| 7C1 | 0.4342 | 0.4028 | 7C2 | 0.4385 | 0.4119 | 7C3 | 0.4449 | 0.4141 | 7C4 | 0.4403 | 0.4049 |
| | 0.4385 | 0.4119 | | 0.4430 | 0.4212 | | 0.4496 | 0.4236 | | 0.4449 | 0.4141 |
| | 0.4449 | 0.4141 | | 0.4496 | 0.4236 | | 0.4562 | 0.4260 | | 0.4513 | 0.4164 |
| | 0.4403 | 0.4049 | | 0.4449 | 0.4141 | | 0.4513 | 0.4164 | | 0.4465 | 0.4071 |
| 7D1 | 0.4259 | 0.3853 | 7D2 | 0.4300 | 0.3939 | 7D3 | 0.4359 | 0.3960 | 7D4 | 0.4316 | 0.3873 |
| | 0.4300 | 0.3939 | | 0.4342 | 0.4028 | | 0.4403 | 0.4049 | | 0.4359 | 0.3960 |
| | 0.4359 | 0.3960 | | 0.4403 | 0.4049 | | 0.4465 | 0.4071 | | 0.4418 | 0.3981 |
| | 0.4316 | 0.3873 | | 0.4359 | 0.3960 | | 0.4418 | 0.3981 | | 0.4373 | 0.3893 |

PERFORMANCE GROUPS - CHROMATICITY (CONTINUED)

| Region | x | y | Region | x | y | Region | x | y | Region | x | y |
|--------|--------|--------|--------|--------|--------|--------|--------|--------|--------|--------|--------|
| 8A1 | 0.4373 | 0.3893 | 8A2 | 0.4418 | 0.3981 | 8A3 | 0.4475 | 0.3994 | 8A4 | 0.4428 | 0.3906 |
| | 0.4418 | 0.3981 | | 0.4465 | 0.4071 | | 0.4523 | 0.4085 | | 0.4475 | 0.3994 |
| | 0.4475 | 0.3994 | | 0.4523 | 0.4085 | | 0.4582 | 0.4099 | | 0.4532 | 0.4008 |
| | 0.4428 | 0.3906 | | 0.4475 | 0.3994 | | 0.4532 | 0.4008 | | 0.4483 | 0.3919 |
| 8B1 | 0.4465 | 0.4071 | 8B2 | 0.4513 | 0.4164 | 8B3 | 0.4573 | 0.4178 | 8B4 | 0.4523 | 0.4085 |
| | 0.4513 | 0.4164 | | 0.4562 | 0.4260 | | 0.4624 | 0.4274 | | 0.4573 | 0.4178 |
| | 0.4573 | 0.4178 | | 0.4624 | 0.4274 | | 0.4687 | 0.4289 | | 0.4634 | 0.4193 |
| | 0.4523 | 0.4085 | | 0.4573 | 0.4178 | | 0.4634 | 0.4193 | | 0.4582 | 0.4099 |
| 8C1 | 0.4582 | 0.4158 | 8C2 | 0.4634 | 0.4193 | 8C3 | 0.4695 | 0.4207 | 8C4 | 0.4641 | 0.4112 |
| | 0.4634 | 0.4252 | | 0.4687 | 0.4289 | | 0.4750 | 0.4304 | | 0.4695 | 0.4207 |
| | 0.4695 | 0.4250 | | 0.4750 | 0.4304 | | 0.4813 | 0.4319 | | 0.4756 | 0.4221 |
| | 0.4641 | 0.4156 | | 0.4695 | 0.4207 | | 0.4756 | 0.4221 | | 0.4700 | 0.4126 |
| 8D1 | 0.4483 | 0.3919 | 8D2 | 0.4532 | 0.4008 | 8D3 | 0.4589 | 0.4021 | 8D4 | 0.4538 | 0.3931 |
| | 0.4532 | 0.4008 | | 0.4582 | 0.4099 | | 0.4641 | 0.4112 | | 0.4589 | 0.4021 |
| | 0.4589 | 0.4021 | | 0.4641 | 0.4112 | | 0.4700 | 0.4126 | | 0.4646 | 0.4034 |
| | 0.4538 | 0.3931 | | 0.4589 | 0.4021 | | 0.4646 | 0.4034 | | 0.4593 | 0.3944 |
| AA1 | 0.4822 | 0.3973 | AA2 | 0.4884 | 0.4067 | AA3 | 0.4942 | 0.4066 | AA4 | 0.4879 | 0.3972 |
| | 0.4884 | 0.4067 | | 0.4946 | 0.4162 | | 0.5006 | 0.4160 | | 0.4942 | 0.4066 |
| | 0.4942 | 0.4066 | | 0.5006 | 0.4160 | | 0.5066 | 0.4158 | | 0.5001 | 0.4064 |
| | 0.4879 | 0.3972 | | 0.4942 | 0.4066 | | 0.5001 | 0.4064 | | 0.4936 | 0.3970 |
| AB1 | 0.4946 | 0.4162 | AB2 | 0.5008 | 0.4256 | AB3 | 0.5069 | 0.4254 | AB4 | 0.5006 | 0.4160 |
| | 0.5008 | 0.4256 | | 0.5070 | 0.4350 | | 0.5133 | 0.4348 | | 0.5069 | 0.4254 |
| | 0.5069 | 0.4254 | | 0.5133 | 0.4348 | | 0.5196 | 0.4346 | | 0.5131 | 0.4252 |
| | 0.5006 | 0.4160 | | 0.5069 | 0.4254 | | 0.5131 | 0.4252 | | 0.5066 | 0.4158 |
| AC1 | 0.5066 | 0.4158 | AC2 | 0.5131 | 0.4252 | AC3 | 0.5192 | 0.4250 | AC4 | 0.5126 | 0.4156 |
| | 0.5131 | 0.4252 | | 0.5196 | 0.4346 | | 0.5258 | 0.4343 | | 0.5192 | 0.4250 |
| | 0.5192 | 0.4250 | | 0.5258 | 0.4343 | | 0.5321 | 0.4341 | | 0.5253 | 0.4248 |
| | 0.5126 | 0.4156 | | 0.5192 | 0.4250 | | 0.5253 | 0.4248 | | 0.5186 | 0.4154 |
| AD1 | 0.4936 | 0.3970 | AD2 | 0.5001 | 0.4064 | AD3 | 0.5059 | 0.4062 | AD4 | 0.4993 | 0.3969 |
| | 0.5001 | 0.4064 | | 0.5066 | 0.4158 | | 0.5126 | 0.4156 | | 0.5059 | 0.4062 |
| | 0.5059 | 0.4062 | | 0.5126 | 0.4156 | | 0.5186 | 0.4154 | | 0.5118 | 0.4061 |
| | 0.4993 | 0.3969 | | 0.5059 | 0.4062 | | 0.5118 | 0.4061 | | 0.5050 | 0.3967 |

CREE'S WHITE CHROMATICITY REGIONS PLOTTED ON THE CIE 1931 CURVE

ANSI Cool White

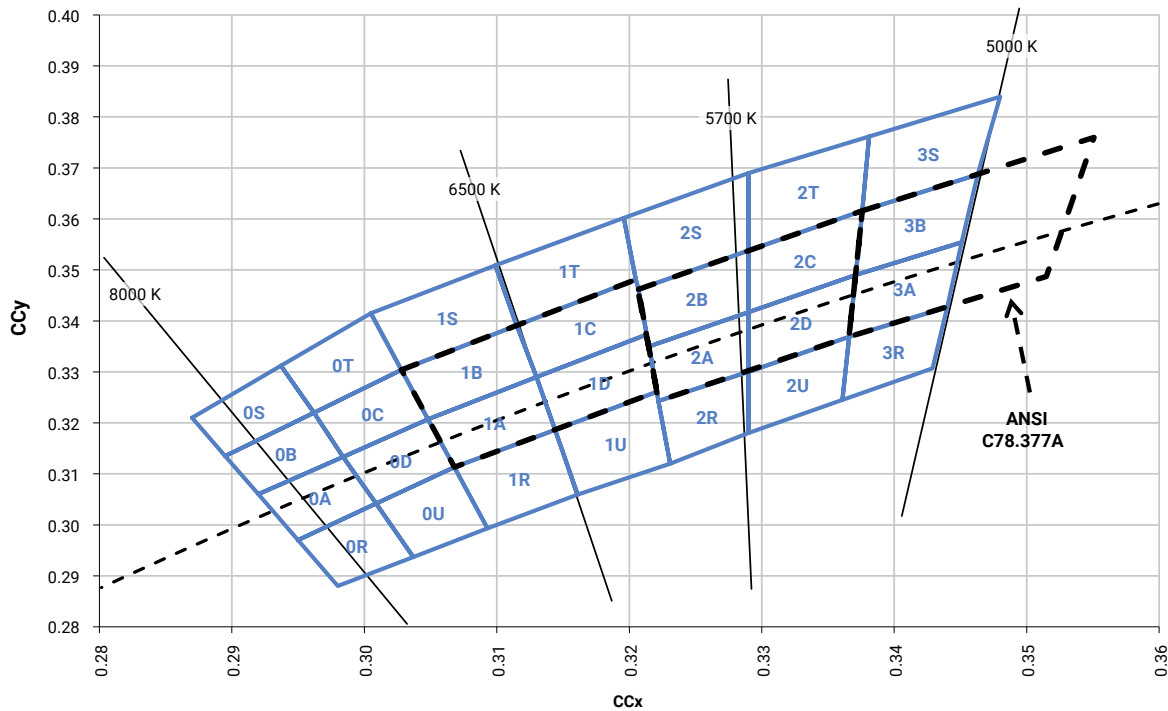

ANSI Neutral White and ANSI Warm White

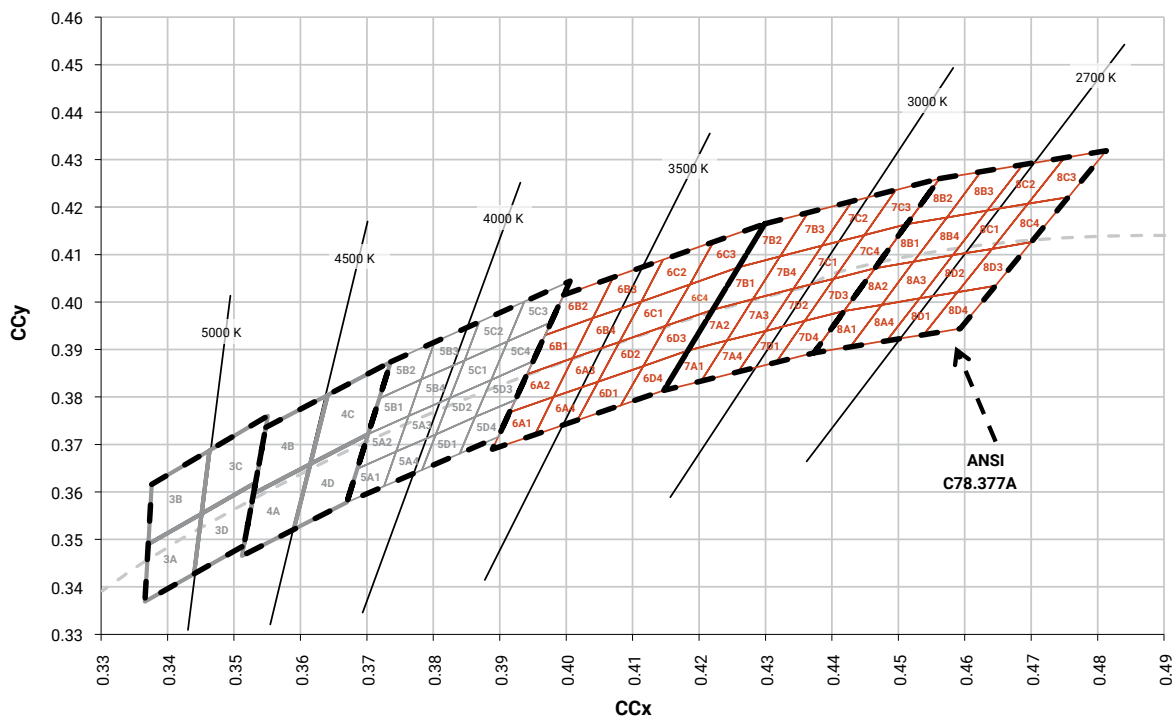

CREE'S COOL WHITE KITS PLOTTED ON ANSI STANDARD CHROMATICITY REGIONS

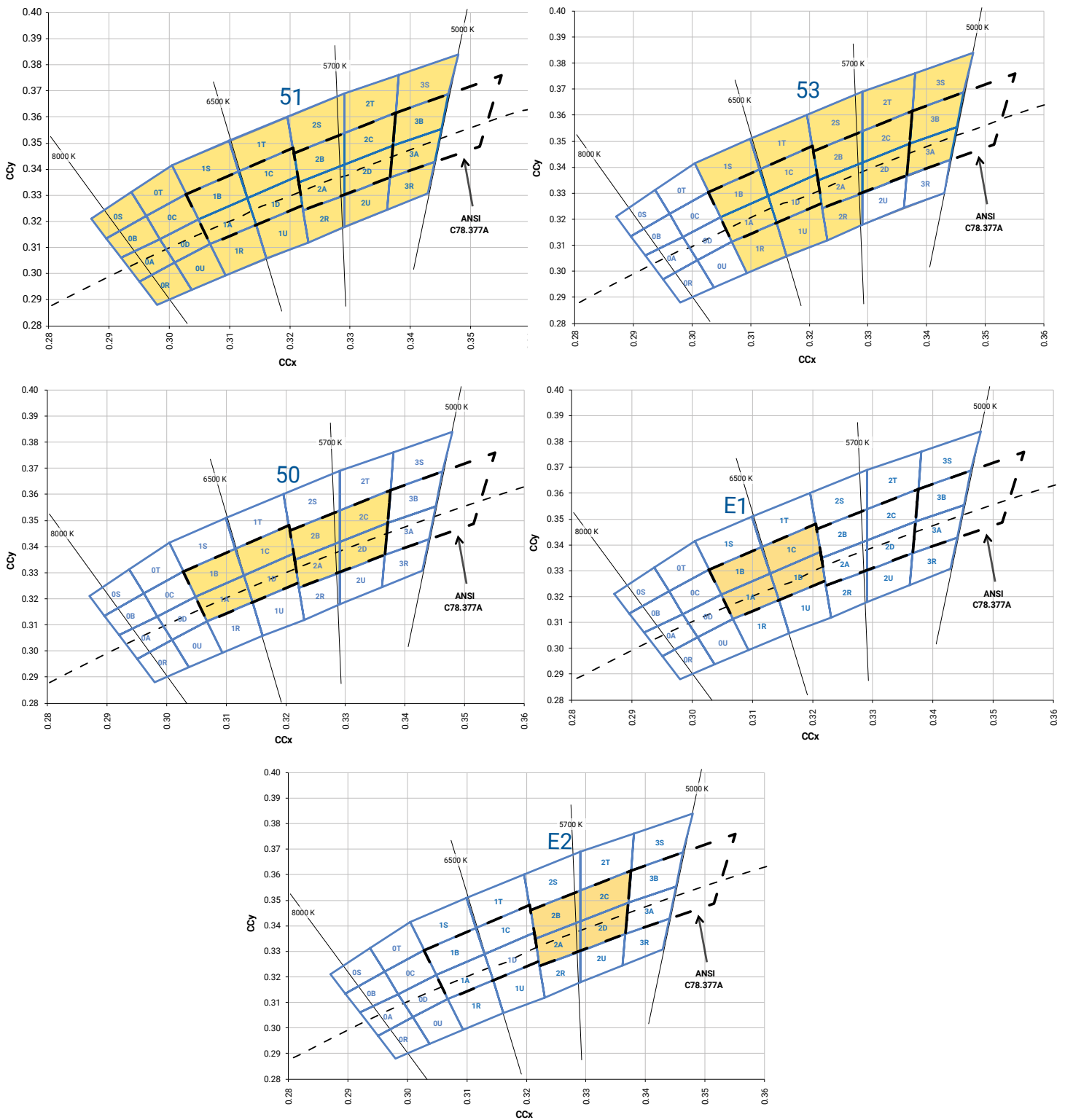

CREE'S WHITE KITS PLOTTED ON ANSI STANDARD CHROMATICITY REGIONS

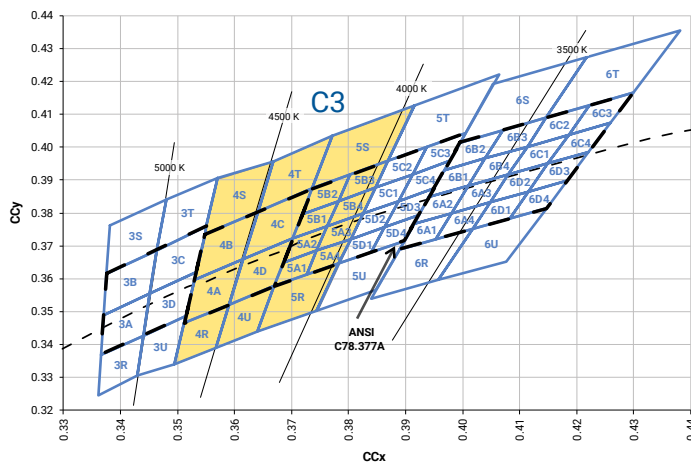
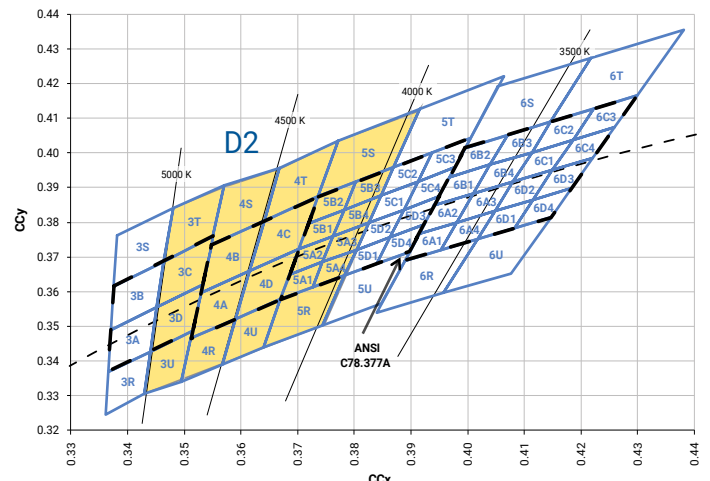
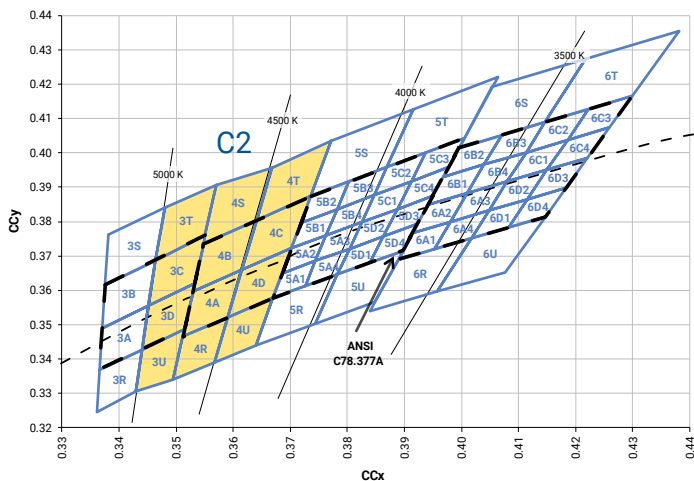
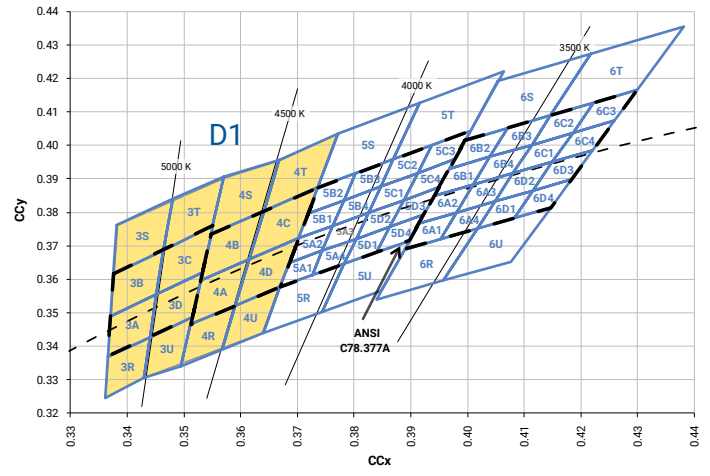
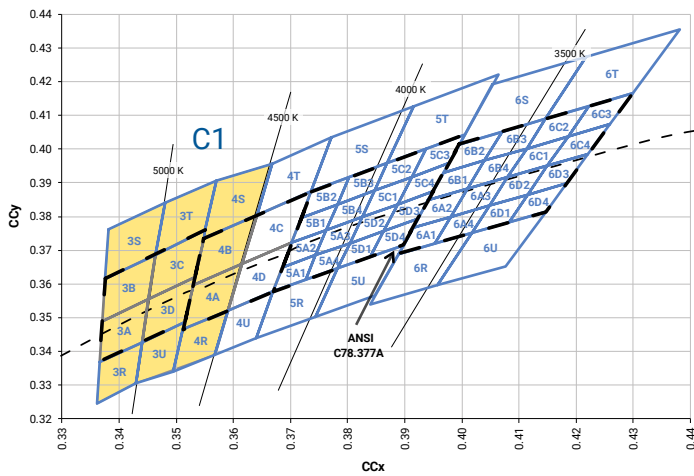

CREE'S WARM AND NEUTRAL WHITE KITS PLOTTED ON ANSI STANDARD CHROMATICITY REGIONS

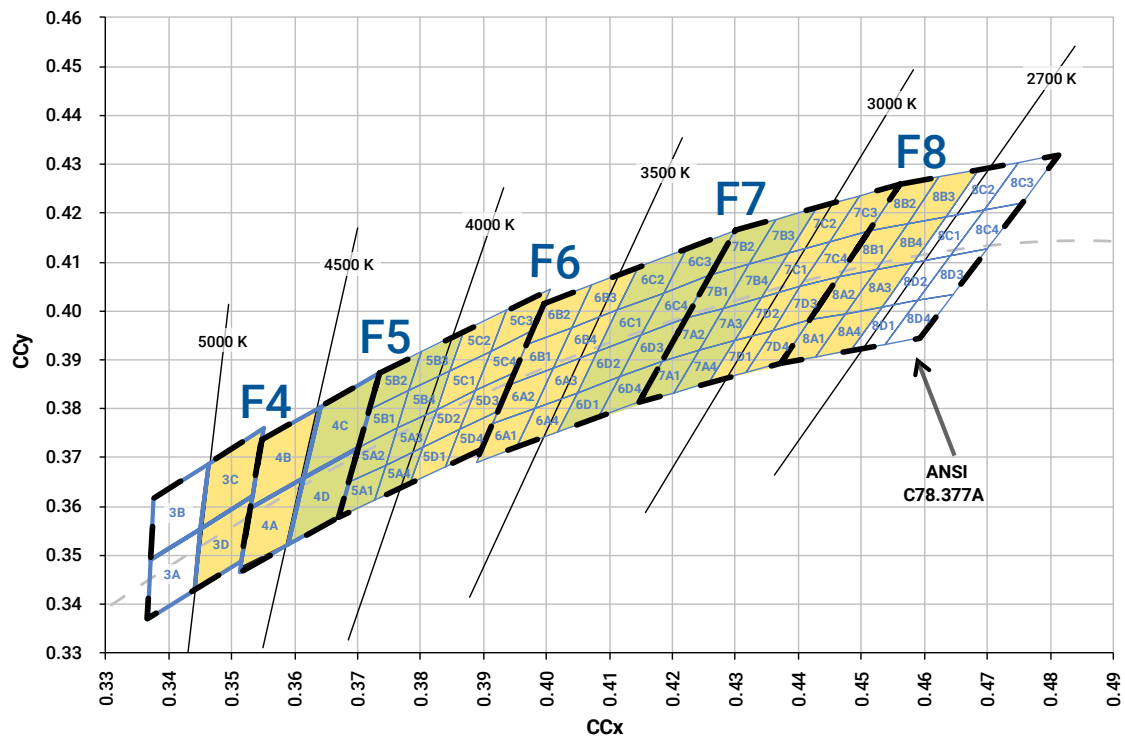
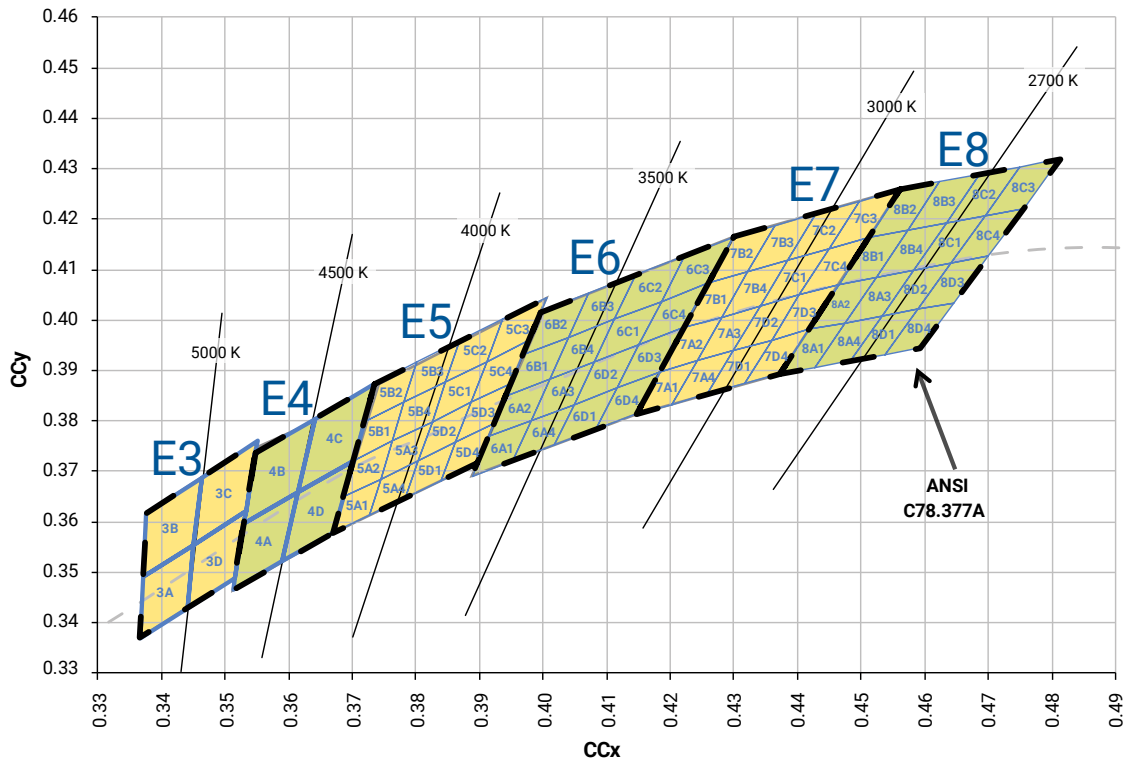

CREE'S 2200 K CCT WHITE KIT PLOTTED ON ANSI STANDARD CHROMATICITY REGIONS

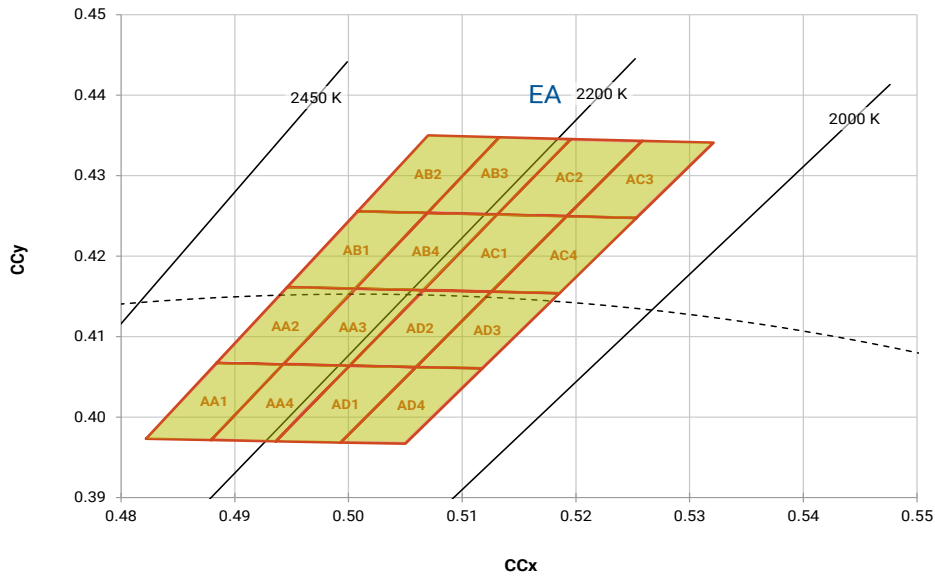

CREE'S STANDARD CHROMATICITY KITS

The following table provides the chromaticity bins associated with chromaticity kits for XT-E White LEDs.

| Color | CCT | Kit | Chromaticity Bins |
|---------------|--------|-----|--|
| Cool White | 6200 K | 51 | 0A, 0B, 0C, 0D, 0R, 0S, 0T, 0U, 1A, 1B, 1C, 1D, 1R, 1S, 1T, 1U, 2A, 2B, 2C, 2D, 2R, 2S, 2T, 2U, 3A, 3B, 3R, 3S |
| | 6000 K | 53 | 1A, 1B, 1C, 1D, 1R, 1S, 1T, 1U, 2A, 2B, 2C, 2D, 2R, 2S, 2T, 3A, 3B, 3S |
| | 6200 K | 50 | 1A, 1B, 1C, 1D, 2A, 2B, 2C, 2D |
| | 6500 K | E1 | 1A, 1B, 1C, 1D |
| | 5700 K | E2 | 2A, 2B, 2C, 2D |
| Neutral White | 5000 K | E3 | 3A, 3B, 3C, 3D |
| | 5000 K | C1 | 3A, 3B, 3C, 3D, 3R, 3S, 3T, 3U, 4A, 4B, 4R, 4S |
| | 4750 K | F4 | 3C, 3D, 4A, 4B |
| | 4750 K | D1 | 3A, 3B, 3C, 3D, 3R, 3S, 3T, 3U, 4A, 4B, 4C, 4D, 4R, 4S, 4T, 4U |
| | 4500 K | E4 | 4A, 4B, 4C, 4D |
| | 4500 K | D2 | 3C, 3D, 3T, 3U, 4A, 4B, 4C, 4D, 4R, 4S, 4T, 4U, 5A1, 5A2, 5A3, 5A4, 5B1, 5B2, 5B3, 5B4, 5R, 5S |
| | 4500 K | C2 | 3C, 3D, 3T, 3U, 4A, 4B, 4C, 4D, 4R, 4S, 4T, 4U |
| | 4300 K | C3 | 4A, 4B, 4C, 4D, 4R, 4S, 4T, 4U, 5A1, 5A2, 5A3, 5A4, 5B1, 5B2, 5B3, 5B4, 5R, 5S |
| | 4250 K | F5 | 4C, 4D, 5A1, 5A2, 5A3, 5A4, 5B1, 5B2, 5B3, 5B4 |
| | 4000 K | E5 | 5A1, 5A2, 5A3, 5A4, 5B1, 5B2, 5B3, 5B4, 5C1, 5C2, 5C3, 5C4, 5D1, 5D2, 5D3, 5D4 |
| Warm White | 3750 K | F6 | 5C1, 5C2, 5C3, 5C4, 5D1, 5D2, 5D3, 5D4, 6A1, 6A2, 6A3, 6A4, 6B1, 6B2, 6B3, 6B4 |
| | 3500 K | E6 | 6A1, 6A2, 6A3, 6A4, 6B1, 6B2, 6B3, 6B4, 6C1, 6C2, 6C3, 6C4, 6D1, 6D2, 6D3, 6D4 |
| | 3250 K | F7 | 6C1, 6C2, 6C3, 6C4, 6D1, 6D2, 6D3, 6D4, 7A1, 7A2, 7A3, 7A4, 7B1, 7B2, 7B3, 7B4 |
| | 3000 K | E7 | 7A1, 7A2, 7A3, 7A4, 7B1, 7B2, 7B3, 7B4, 7C1, 7C2, 7C3, 7C4, 7D1, 7D2, 7D3, 7D4 |
| | 2850 K | F8 | 7C1, 7C2, 7C3, 7C4, 7D1, 7D2, 7D3, 7D4, 8A1, 8A2, 8A3, 8A4, 8B1, 8B2, 8B3, 8B4 |
| | 2700 K | E8 | 8A1, 8A2, 8A3, 8A4, 8B1, 8B2, 8B3, 8B4, 8C1, 8C2, 8C3, 8C4, 8D1, 8D2, 8D3, 8D4 |
| | 2200 K | EA | AA1, AA2, AA3, AA4, AB1, AB2, AB3, AB4, AC1, AC2, AC3, AC4, AD1, AD2, AD3, AD4 |

BIN AND ORDER CODE FORMATS

Bin codes and order codes for XT-E LEDs are configured in the following manner:

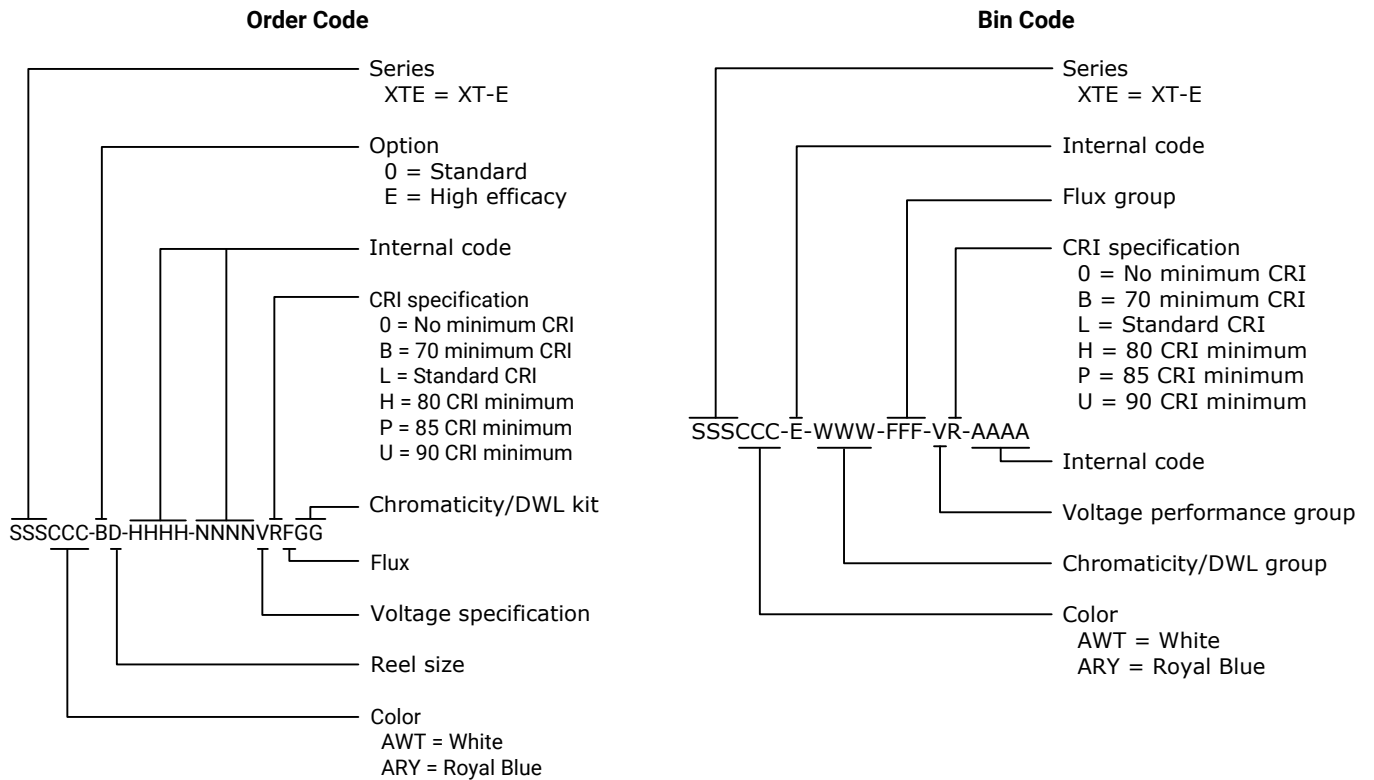

REFLOW SOLDERING CHARACTERISTICS

In testing, Cree has found XLamp XT-E LEDs to be compatible with JEDEC J-STD-020C, using the parameters listed below. As a general guideline, Cree recommends that users follow the recommended soldering profile provided by the manufacturer of the solder paste used, and therefore it is the lamp or luminaire manufacturer’s responsibility to determine applicable soldering requirements.

Note that this general guideline may not apply to all PCB designs and configurations of reflow soldering equipment.

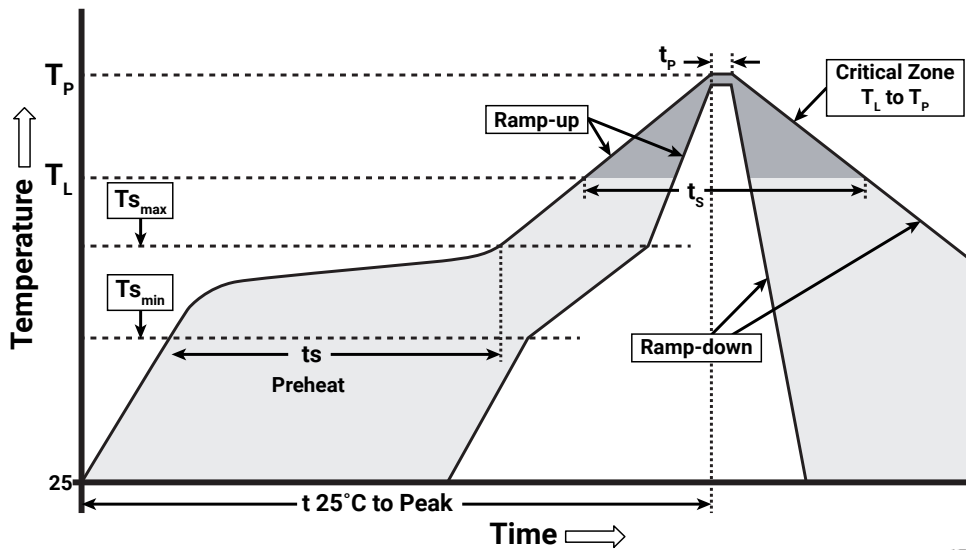

IPC/JEDEC J-STD-020C

| Profile Feature | Lead-Free Solder |
|---|------------------|
| Average Ramp-Up Rate ($T_{s_{max}}$ to T_p) | 1.2 °C/second |
| Preheat: Temperature Min ($T_{s_{min}}$) | 120 °C |
| Preheat: Temperature Max ($T_{s_{max}}$) | 170 °C |
| Preheat: Time ($T_{s_{min}}$ to $T_{s_{max}}$) | 65-150 seconds |
| Time Maintained Above: Temperature (T_l) | 217 °C |
| Time Maintained Above: Time (t_l) | 45-90 seconds |
| Peak/Classification Temperature (T_p) | 235 - 245 °C |
| Time Within 5 °C of Actual Peak Temperature (t_p) | 20-40 seconds |
| Ramp-Down Rate | 1 - 6 °C/second |
| Time 25 °C to Peak Temperature | 4 minutes max. |

Note: All temperatures refer to the topside of the package, measured on the package body surface.

NOTES

Measurements

The luminous flux, radiant power, chromaticity, forward voltage and CRI measurements in this document are binning specifications only and solely represent product measurements as of the date of shipment. These measurements will change over time based on a number of factors that are not within Cree's control and are not intended or provided as operational specifications for the products. Calculated values are provided for informational purposes only and are not intended or provided as specifications.

Pre-Release Qualification Testing

Please read the [LED Reliability Overview](#) for details of the qualification process Cree applies to ensure long-term reliability for XLamp LEDs and details of Cree's pre-release qualification testing for XLamp LEDs.

Lumen Maintenance

Cree now uses standardized IES LM-80-08 and TM-21-11 methods for collecting long-term data and extrapolating LED lumen maintenance. For information on the specific LM-80 data sets available for this LED, refer to the public [LM-80 results document](#).

Please read the [Long-Term Lumen Maintenance application note](#) for more details on Cree's lumen maintenance testing and forecasting. Please read the [Thermal Management application note](#) for details on how thermal design, ambient temperature, and drive current affect the LED junction temperature.

Moisture Sensitivity

Cree recommends keeping XLamp LEDs in the provided, resealable moisture-barrier packaging (MBP) until immediately prior to soldering. Unopened MBPs that contain XLamp LEDs do not need special storage for moisture sensitivity.

Once the MBP is opened, XLamp XT-E LEDs may be stored as MSL 1 per JEDEC J-STD-033, meaning they have unlimited floor life in conditions of ≤ 30 °C/85% relative humidity (RH). Regardless of the storage condition, Cree recommends sealing any unsoldered LEDs in the original MBP.

RoHS Compliance

The levels of RoHS restricted materials in this product are below the maximum concentration values (also referred to as the threshold limits) permitted for such substances, or are used in an exempted application, in accordance with EU Directive 2011/65/EC (RoHS2), as implemented January 2, 2013. RoHS Declarations for this product can be obtained from your Cree representative or from the [Product Ecology](#) section of the Cree website.

REACH Compliance

REACH substances of very high concern (SVHCs) information is available for this product. Since the European Chemical Agency (ECHA) has published notice of their intent to frequently revise the SVHC listing for the foreseeable future, please contact a Cree representative to insure you get the most up-to-date REACH SVHC Declaration. REACH banned substance information (REACH Article 67) is also available upon request.

NOTES - CONTINUED

UL® Recognized Component

This product meets the requirements to be considered a UL Recognized Component with Level 4 enclosure consideration. The LED package or a portion thereof has been investigated as a fire and electrical enclosure per ANSI/UL 8750.

Vision Advisory

WARNING: Do not look at an exposed lamp in operation. Eye injury can result. For more information about LEDs and eye safety, please refer to the [LED Eye Safety application note](#).

MECHANICAL DIMENSIONS

Thermal vias, if present, are not shown on these drawings.
All measurements are ±0.13 mm unless otherwise indicated.

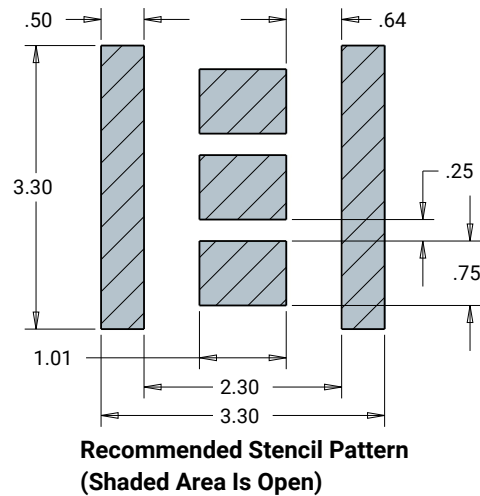
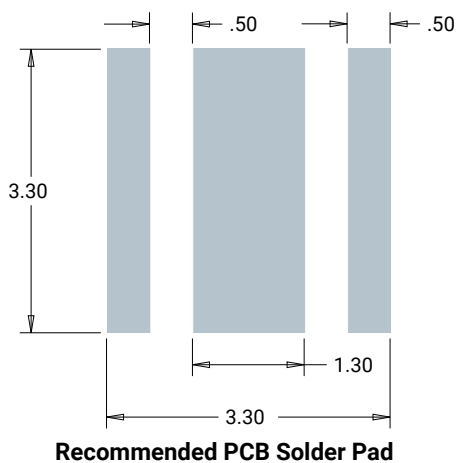
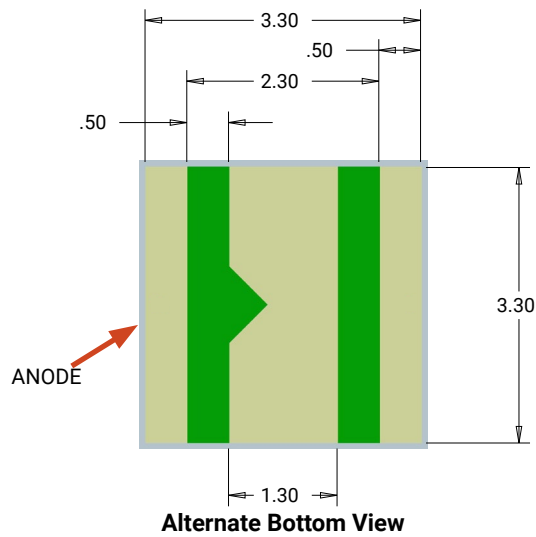
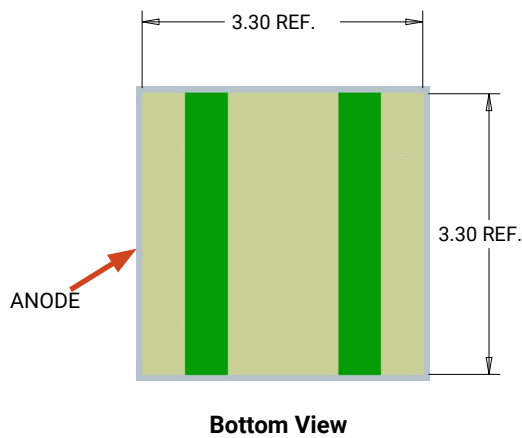
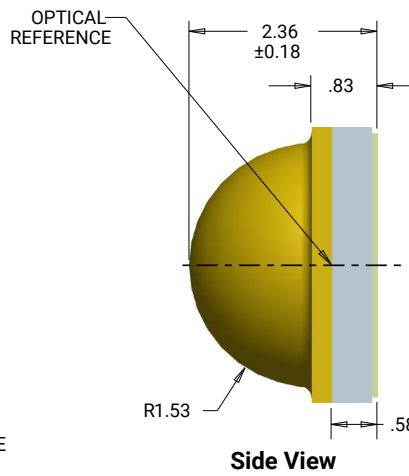
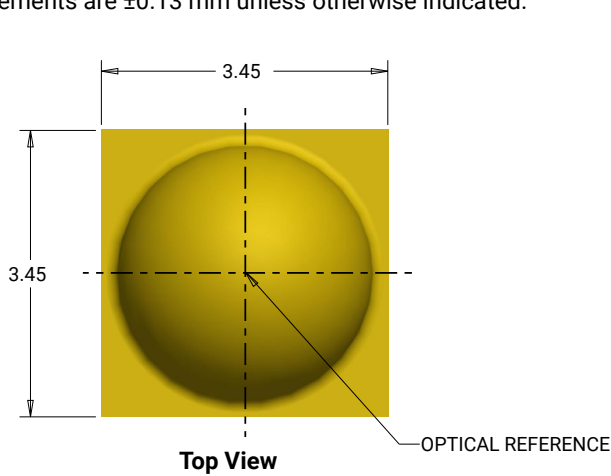

TAPE AND REEL

All Cree carrier tapes conform to EIA-481D, Automated Component Handling Systems Standard.

All dimensions in mm.

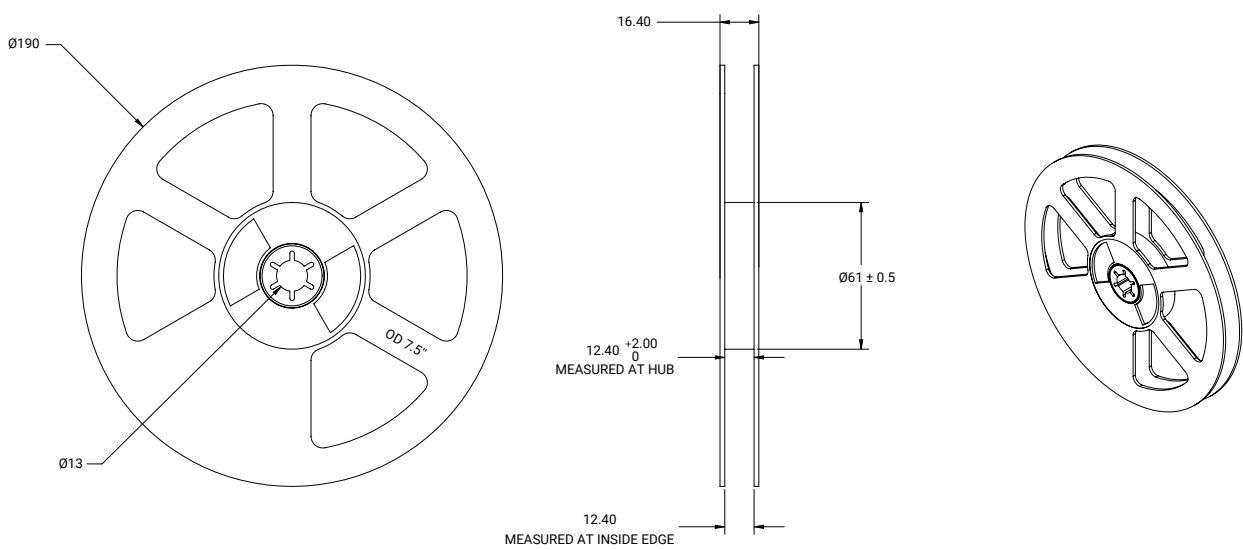
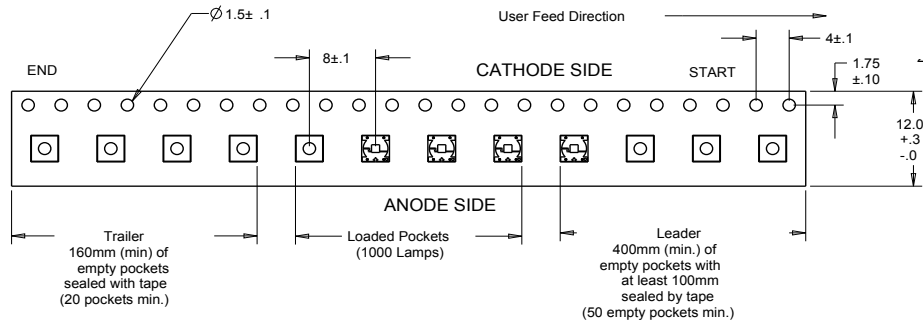
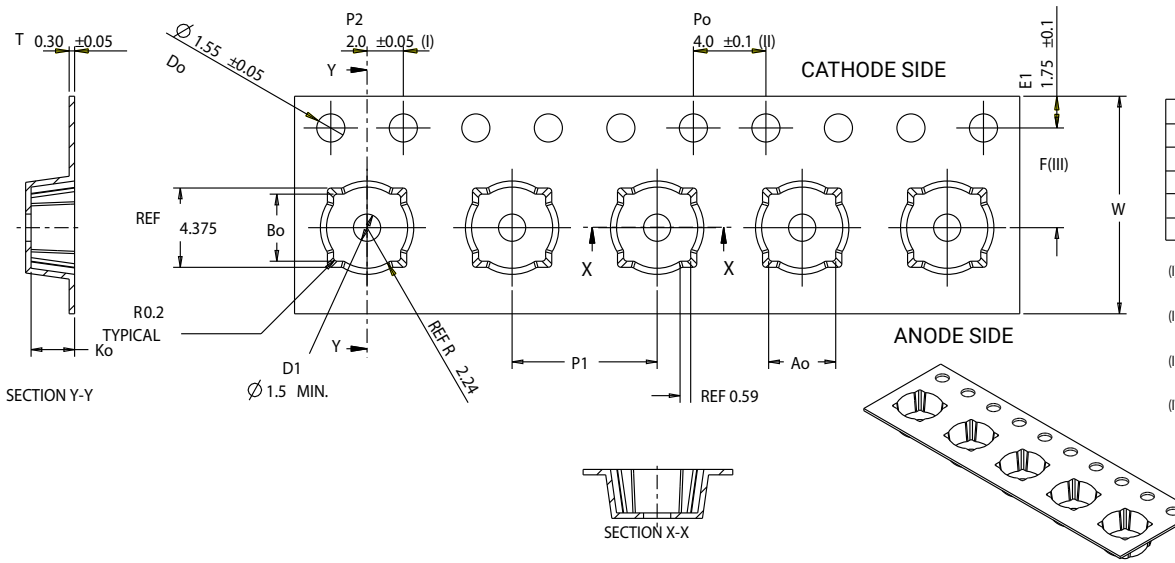

PACKAGING

Unpackaged Reel

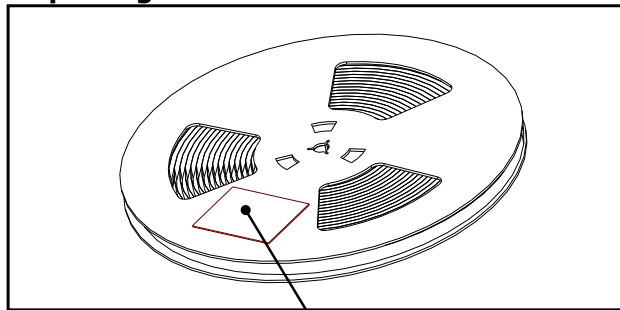

Label with Cree Bin Code,
Quantity, Reel ID

Packaged Reel

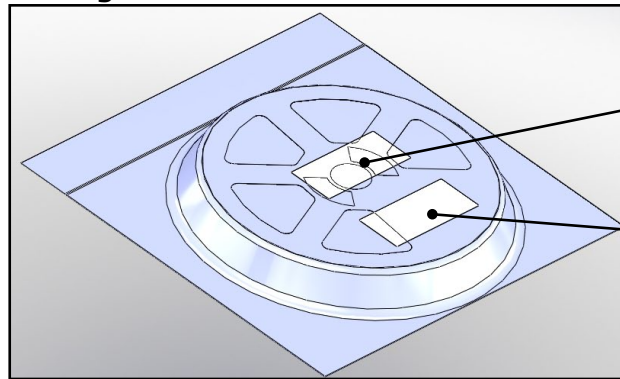

Label with Cree Order Code,
Quantity, Reel ID, PO #

Label with Cree Bin Code,
Quantity, Reel ID

Boxed Reel

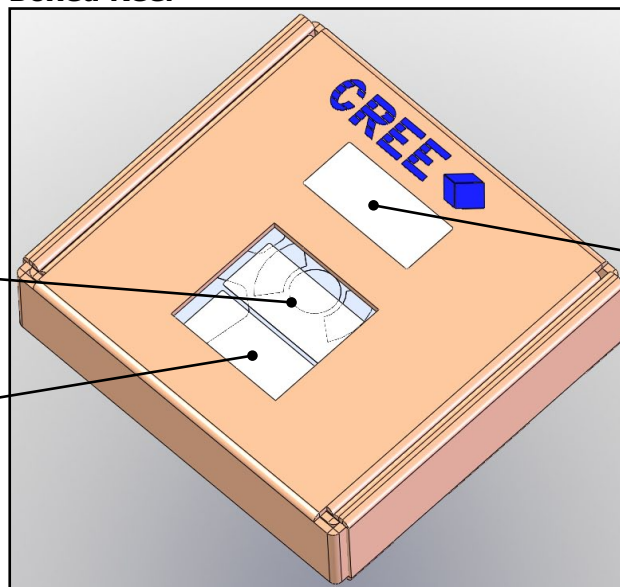

Label with Cree Order Code,
Quantity, Reel ID, PO #

Label with Cree Bin Code,
Quantity, Reel ID

Patent Label

X-ON Electronics

Largest Supplier of Electrical and Electronic Components

Click to view similar products for [High Power LEDs - Single Color](#) category:

Click to view products by [Cree](#) manufacturer:

Other Similar products are found below :

[L135-L567003500000](#) [L1CU-VLT1000000000](#) [GW PSLMS1.EC-GTHP-5J7K-1](#) [LT G5AP-CZEX-36-1](#) [LD G5AP-4M4N-35-1](#) [XPEBRY-L1-0000-00S02](#) [SPHWH2L3D30ED4V0H3](#) [XQEBLU-00-0000-000000202](#) [LUWCQ7P-LPLR-5E8G-1-K](#) [KA-3535SELZ4S](#) [GH CSSPM1.24-4T2U-1](#) [L1SP-DRD0002000000](#) [L1SP-LME0002000000](#) [LHUV-0395-A060](#) [VLMTG1400-GS08](#) [XPGDRY-L1-0000-00601-SB01](#) [XTEARY-00-0000-000000L02](#) [XQEGRN-H0-0000-000000901](#) [XPEEPR-L1-0000-00B01](#) [XPERED-L1-0000-00801](#) [XTEARY-00-0000-000000M04](#) [XPGDRY-L1-0000-00401](#) [XQEEPR-00-0000-000000901](#) [XQEEPR-00-0000-000000A01](#) [15335340AA350](#) [XPCRDO-L1-R250-00701](#) [XPEGRN-L1-0000-00F02](#) [XRCRDO-L1-R250-00K03](#) [15335339AA350](#) [XQERDO-02-0000-000000701](#) [XPEBGR-L1-0000-00E02](#) [XPEROY-L1-R250-00B02](#) [15335338AA350](#) [XPEROY-L1-R250-00903](#) [XPEBRY-L1-R250-00R01](#) [XPCBLU-L1-R250-00Y01](#) [XPEGRN-L1-0000-00F01](#) [XPEBPA-L1-R250-00B01](#) [XPERED-L1-R250-00802](#) [XQEBLU-02-0000-000000305](#) [XTEARY-00-0000-000000K03](#) [XTEARY-02-0000-000000L03](#) [XPEBBL-L1-R250-00302](#) [VLMY71AAAC-GS08](#) [XPCGRN-L1-R250-00601](#) [LS H9PP-HYJY-1-1](#) [XPEROY-L1-0000-00B02](#) [XPERDO-L1-R250-00A03](#) [XPCROY-L1-R250-00803](#) [LST1-01G01-GRN1-00](#)