

2–OsiSense® XS

Inductive proximity sensors

Selection guide page 2/2

■ Applications Overview page 2/8

■ Overview page 2/10

OsiSense® XS, cylindrical

■ Basic Series

□ Increased range, flush mountable page 2/20

□ Standard range, flush and non-flush mountable page 2/24

■ General Purpose

□ Plastic, non-flush mountable page 2/30

□ Miniature, flush and non-flush mountable page 2/32

□ Increased range, flush mountable page 2/34

□ Standard range, flush mountable pages 2/40 and 2/46

□ Increased range, non-flush mountable page 2/42

□ Increased range, semi-flush mountable page 2/54

□ Multi-voltage, flush and non-flush mountable page 2/56

□ Metal and plastic, flush and non-flush mountable page 2/58

■ Sensors for food/beverage and pharmaceutical applications

□ Cylindrical, stainless steel non-flush mountable page 2/62

□ Cylindrical, plastic non-flush mountable page 2/66

OsiSense® XS, surface mountable type

■ Flush mode using teach mode overview page 2/70

■ Cylindrical, adjustable range, flush and non-flush mountable page 2/72

■ Flat form, increased range, flush or non-flush mountable page 2/74

■ Flat form, standard range, flush mountable page 2/76

■ 80 x 80 flat form, DIN rail mounting, flush mountable page 2/80

■ Limit Switch Style, 5-position turret head page 2/82

■ Cubic 40 form, multi-position page 2/86

■ Sensors for assembly, packaging, conveying or light handling applications

..... page 2/88

OsiSense® XS, application

■ Sensors for rotation monitoring: overview page 2/92

□ Sensors for rotation monitoring page 2/93

■ Sensors with analog output

□ 0 to 10 volt or 4 to 20 mA for position, displacement and deformation

control/monitoring page 2/96

□ 0 to 10 volt or 4 to 20 mA page 2/98

□ 0 to 10 volt for position, displacement and deformation

control/monitoring page 2/100

□ 4 to 20 mA for position, displacement and deformation

control/monitoring page 2/102

■ Fixed sensing distance detection for ferrous and non-ferrous materials page 2/104

■ Selective detection of ferrous and non-ferrous materials page 2/108

■ Sensors for welding machine applications page 2/110

■ SG Magnet Actuated Sensors page 2/114

OsiSense® XS

■ Accessories page 2/131

■ Operating curves page 2/135

■ Substitution table page 2/137



OsiSense® XS

Inductive proximity sensors

General Purpose

2

Cylindrical type

Standard range

Flush mountable



Sensing distance Sn, mm (in.)	
Diameter	
Short case	Supply
	3-wire --- (PNP/NPN) Page
	2-wire --- Page
Long case	Supply
	3-wire --- (PNP/NPN) Page
	2-wire --- Page
	2-wire --- Page
Function	NO NC
Connection	Pre-cabled (L = 2 m) (1)
	M8 connector, 3-pin (3-wire ---)
	M12 connector
	Remote connector
Degree of protection	
Special temperatures	- 40 °C, + 70 °C (-40 °F, +158 °F)
	- 25 °C, + 85 °C (-13 °F, +185 °F)
Catalog Number	
Pages	

	1.5 (0.06)	2 (0.08)	5 (0.20)	10 (0.39)
Diameter	Ø 6.5 plain and M8	M12	M18	M30
46				
50				
47				
-	51			
-	-	40		
•		•	•	•
•		•	•	•
•		•	•	•
•		-	-	-
•		•	•	•
Remote connectors available: M8, M12, M18, screw terminal, 7/8", DIN: consult the Sensor Competency Center				
IP 65 and IP 67, IP 68 for pre-cabled version, IP 69K for diameters 12 to 30				
Add the suffix TF to the end of the catalog number (2)				
Add the suffix TT to the end of the catalog number (2)				
XS506	XS508	XS512	XS518	XS530
40-52				

(1) Also available in lengths of 5 and 10 m, depending on model
 (2) Product availability depends on model: consult the Sensor Competency Center

OsiSense® XS

Inductive proximity sensors

General Purpose

Increased range

Flush mountable

Non-flush mountable



2

2.5 (0.10)	4 (0.16)	8 (0.31)	15 (0.59)	7 (0.28)	12 (0.47)	22 (0.87)
Ø 6.5 plain and M8	M12	M18	M30	M12	M18	M30
20 and 32				–		
34				–		
36				42		
34				–	44	
–	38			–		
•	•	•	•	•	•	•
•	•	•	•	•	•	•
•	•	•	•	•	•	•
•	–	–	–	–	–	–
•	•	•	•	•	•	•
–	•	•	•	–	•	•
Remote connectors available: M8, M12, M18, screw terminal, 7/8", DIN: consult the Sensor Competency Center				IP 65 and IP 67, IP 68 for pre-cabled version, IP 69K for diameters 12 to 30		
IP 65 and IP 67, IP 68 for pre-cabled version, IP 69K for diameters 12 to 30				IP 65 and IP 67, IP 68 for pre-cabled version, IP 69K for diameters 12 to 30		
Add the suffix TF to the end of the catalog number (2)						
Add the suffix TT to the end of the catalog number (2)						
XS1•6, XS606	XS108, XS608	XS112, XS612	XS118, XS618	XS130, XS630	XS612	XS618
20, 34		21, 34		42		

(2) Product availability depends on model: consult the Sensor Competency Center

OsiSense® XS

Inductive proximity sensors

General Purpose

2

Block type

Standard range
Flush mountable



Sensing distance Sn, mm (in.)	
Dimensions (mm) (W x H x D)	
Supply	3-wire $\overline{\text{---}}$ (PNP/NPN) Page
	2-wire $\overline{\text{---}}$ Page
	\sim Page
	$\overline{\sim}$ Page
Function	NO
	NC
	NO + NC
	NO/NC
Connection	Pre-cabled (L = 2 m) (1)
	M8 connector, 3-pin (3-wire $\overline{\text{---}}$)
	M12 connector
	1/2"-20UNF connector
	Screw terminals
	Remote connector M8
	M12
	1/2"-20UNF
	Other remote connectors available
Degree of protection	
Special temperatures	- 40 °C, + 70 °C (-40 °F, +158 °F)
	- 25 °C, + 85 °C (-13 °F, +185 °F)
Catalog Number	
Pages	

	2.5 (0.10)	5 (0.20)	10 (0.39)
Dimensions (mm) (W x H x D)	8 x 22 x 8	15 x 32 x 8	26 x 26 x 13
Supply	76		78
	76		78
	-	-	-
	-	-	-
Function	•	•	•
	•	•	•
	-	-	-
	-	-	-
Connection	•	•	•
	-	-	•
	-	-	-
	-	-	-
	-	-	-
	•	•	-
	-	-	•
	-	-	-
	M18, screw terminal, 7/8", DIN: consult the Sensor Competency Center		
Degree of protection	IP 67	IP 67, double insulation ☐ or IP 68, double insulation ☐, depending on model	
Special temperatures	Add the suffix TF to the end of the catalog number (2)		
	Add the suffix TT to the end of the catalog number (2)		
Catalog Number	XS7J	XS7F	XS7E
Pages	76		78

(1) Also available in lengths of 5 and 10 m, depending on model
 (2) Product availability depends on model: consult the Sensor Competency Center

OsiSense® XS

Inductive proximity sensors

General Purpose

Standard range		Increased range	
Flush mountable	Non-flush mountable	Flush or non-flush mountable	Flush or non-flush mountable using teach mode



15 (0.59)	40 (1.57)	15 (0.59)	20 (0.79)	40 (1.57)	15 (0.59)	25 (0.98)	60 (2.36)
40 x 40 x 15	80 x 80 x 26	Limit switch style			26 x 26 x 13	40 x 40 x 15	80 x 80 x 26
78		82			74		
78		82			74		
-	-	•			-		
-	-	84			74		
•	•	•	•	•	•	•	•
•	•	-	-	-	•	•	•
-	-	•	•	•	-	-	-
-	-	•	•	-	-	-	-
•	•	-	-	-	•	•	•
•	-	-	-	-	•	•	-
-	•	-	-	-	-	-	•
-	-	-	-	-	-	-	•
-	-	•	•	•	-	-	-
-	-	-	-	-	-	-	-
•	-	-	-	-	•	•	-
-	-	-	-	-	•	•	-
M18, screw terminal, 7/8", DIN: consult the Sensor Competency Center							
IP 67, double insulation ☐ or IP 68, double insulation ☐, depending on model		IP 65 and IP 67			IP 67, double insulation ☐ or IP 68, double insulation ☐, depending on model		
Add the suffix TF to the end of the catalog number (2)							
Add the suffix TT to the end of the catalog number (2)							
XS7C	XS7D	XS7C40, XS8C40			XS8E	XS8C	XS8D
78		82			74		

(2) Product availability depends on model: consult the Sensor Competency Center

OsiSense® XS

Inductive proximity sensors

General Purpose

2

Sensor type: flush and Non-flush mountable

Multi-voltage sensors Sensors with two complementary outputs

With short-circuit protection	Solid-state PNP or NPN NO + NC outputs	Solid-state PNP + NPN, NO or NC programmable outputs
-------------------------------	---	---



Sensing distance Sn mm (in.)	Flush mountable
	Non-flush mountable
Diameter	

2–10 (0.08–0.39)	1.5–10 (0.06–0.39)	2–10 (0.08–0.39)
4–15 (0.16–0.59)	2.5–15(0.10–0.59)	4–15 (0.016–0.59)
Threaded: M12, M18, M30	Plain: Ø 6.5 Threaded: M8, M12, M18, M30	Threaded: M12, M18, M30

Case material

Nickel-plated brass	Nickel-plated brass or stainless steel or plastic	Nickel-plated brass or plastic
---------------------	---	--------------------------------

Supply

–	•	•
–	–	–
•	–	–

Function

•	–	–
•	–	–
–	•	–
–	–	•

Connection

•	•	•
–	–	–
–	•	•
•	–	–

Remote connectors available:
M8, M12, M18, screw terminal, 7/8", DIN: consult the Sensor Competency Center

Degree of protection

IP 67 or IP 68, depending on model

Special temperatures

Add the suffix **TF** to the end of the catalog number (2)
Add the suffix **TT** to the end of the catalog number (2)

Catalog Number

XS1M XS2M	XS1●●●●C410 XS2●●●●C410	XS1M●●KP340 XS2M●●KP340 XS4P●●KP340
--------------	----------------------------	---

Pages

56	58	60
----	----	----

(1) Also available in lengths of 5 and 10 m, depending on model
(2) Product availability depends on model: consult the Sensor Competency Center
(3) Packed and sold in lots of 20.

OsiSense® XS

Inductive proximity sensors

General Purpose

Plastic case sensors	Basic sensors	Semi-flush mountable sensors	Miniature sensors
For chemical processing, marine applications	For repetitive machines		For robotic, transfer machine, assembly line applications



2

–	1.5–10 (0.06–0.39)	2.5–15 (0.10–0.59)	–	1–2.5 (0.04–0.10)
2.5–15 (0.10–0.59)	2.5–15 (0.10–0.59)	–	2.5–20 (0.10–0.79)	–
Threaded: M8, M12, M18, M30	Plain: Ø 6.5 Threaded: M8, M12, M18, M30	Plain: Ø 6.5 Threaded: M8, M12, M18, M30		Plain: Ø 4 Threaded: M5
Plastic	Nickel-plated brass or plastic	Nickel-plated brass		Nickel-plated brass or stainless steel
•	•	•	•	•
–	•	–	–	–
•	–	–	–	–
–	•	•	•	•
•	•	•	•	•
–	–	–	–	–
–	–	–	–	–
•	•	•	•	•
–	•	•	•	•
–	•	•	•	•
•	–	–	–	–
Remote connectors available: M8, M12, M18, screw terminal, 7/8", DIN: consult the Sensor Competency Center				
IP 67 or IP 68, depending on model	IP 67		IP 67 or IP 68	IP 67
Add the suffix TF to the end of the catalog number (2)				
Add the suffix TT to the end of the catalog number (2)				
XS4P	XS1●●BL● XS2●●AL● XS2●●BL●	XS1●●●B3●●●TQ (3)	XS1N●●349	XS1L XS2L XS1N
30	22	20	54	32

OsiSense® XS

Inductive proximity sensors

Applications

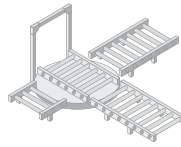

Conveying

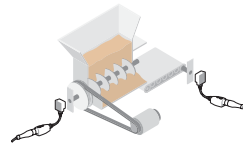

Detection of underspeed, shaft overload

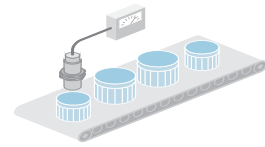

Position, displacement and deformation control/monitoring

2

Sensor type: flush and non-flush mountable

Adjustable range sensors

Sensors for rotation monitoring

Sensors with analog output 0–10 V or 4–20 mA

Developed in accordance with the needs expressed by our customers, these sensors provide a complete solution for specific application functions: rotation monitoring, selective detection, analog control, etc.



Sensing dist. Sn, mm (in.)	Flush mountable
	Non-flush mountable
Form	Cylindrical
Block (W x H x D) dimensions (mm)	
Case material	
Supply	
Function	NO NC NO + NC NO/NC
Connection	Pre-cabled (L = 2 m) (2) M8 connector, 3-pin (3-wire) M12 connector 1/2"-20UNF connector Remote connector Screw terminals
Degree of protection	
Special temperatures	-40 °C, +70 °C (-40 °F, +158 °F) -25 °C, +85 °C (-13 °F, +185 °F)
Catalog Number	
Pages	

	3–11 (0.12–0.43) ⁽¹⁾	10 (0.39)	10–15 (0.39–0.59) ⁽¹⁾	0.2–10 (0.01–0.39) ⁽¹⁾	5–40 (0.20–1.57) ⁽¹⁾
	5–18 (0.20–0.71) ⁽¹⁾			0.4–60 (0.02–2.36) ⁽¹⁾	
	M12 x 54 M18 x 67 M30 x 71	M30 x 81	–	Threaded: M12, M18, M30	–
	–	–	26 x 26 x 13 40 x 40 x 15	–	32 x 15 x 8 26 x 26 x 13 40 x 40 x 15 80 x 80 x 26
	Nickel-plated brass	Metal	PBT	Metal or plastic	PBT
	•	•	•	•	•
	–	–	–	–	–
	–	•	•	–	–
	•	–	–	–	–
	•	•	•	–	–
	–	–	–	–	–
	–	–	–	–	–
	–	•	–	•	•
	–	–	–	–	–
	–	–	–	–	–
	•	–	•	–	•
	–	–	–	–	–
	IP 67, double insulation	IP 67	IP 67, double insulation	IP 67	IP 67 or IP 68 (pre-cabled version)
	Add the suffix TF to the end of the catalog number (3)				
	Add the suffix TT to the end of the catalog number (3)				
	XS612B2 XS618B2 XS630B2	XSAV	XS9•11R	XS1M•••AB1 XS4P•••AB1	XS9••••A
	72	93	95	98	101

(1) Depending on model.
 (2) Also available in lengths of 5 and 10 m, depending on model.
 (3) Product availability depends on model: consult the Sensor Competency Center.

OsiSense® XS

Inductive proximity sensors

Applications

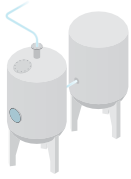

Machine with stainless steel housing

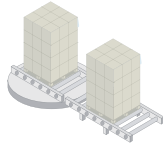

Assembly machines, conveyor systems, material handling

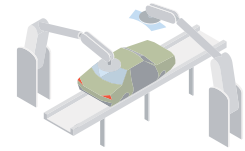
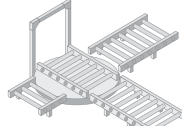

Robotics

Sensors for food/beverage and pharmaceutical applications		Factor 1 (Fe/Nfe) sensors for ferrous and non-ferrous materials		Selective detection sensors for ferrous materials only or non-ferrous materials only	Sensors for conveying and material handling applications			Sensors for welding machine applications
Cylindrical, stainless steel	Cylindrical, plastic				12 x 40 x 26 format	Cubic 40 form	80 x 80 x 40 format, increased range	

2



–	–	5, 10 or 15 (0.20, 0.39 or 0.59) (1)		5, 6 or 10 (0.20, 0.24 or 0.39) (1)	2 (0.08)	15 (0.59)	50 (1.97)	2, 3, 5, 10 (0.08, 0.12, 0.20 or 0.39) (1)
7–22 (0.28–0.87) (1)	7–22(0.28–0.87) (1)	–		–	4 (0.16)	20(0.79)	42 (1.65)	4–10 (0.16–0.39) (1)
Plain: Ø 18 Threaded: M12, M18, M30	Threaded: M12, M18, M30	Threaded: M18, M30	–	Threaded: M18	–	–	–	Threaded: M12, M18, M30
–	–	–	Limit switch style, form C, turret head	–	12 x 40 x 26	40 x 40 x 40	80 x 80 x 40	–
Stainless steel, grade 316 L	Plastic, PPS	Metal	Plastic	Metal	Plastic	Plastic	Plastic	Plastic, PPS
•	•	•	•	•	•	•	•	•
–	–	–	–	–	–	–	–	–
•	•	–	–	–	•	–	–	–
•	•	–	–	•	•	•	•	•
–	–	–	–	–	•	–	–	–
–	–	–	–	–	•	•	–	–
–	–	•	•	–	–	–	–	–
•	•	•	–	•	•	•	–	–
–	–	–	–	–	•	–	–	–
•	•	•	–	–	–	–	•	•
•	•	–	–	–	–	–	–	–
–	–	•	–	–	–	•	–	•
–	–	–	•	–	–	–	–	–
IP 67 (connector version) IP 68 (pre-cabled version), double insulation ☐ IP 69K conforming to DIN 40050		IP 68	IP 67	IP 67 or IP 68 (1)	IP 67	IP 67	IP 67, double insulation ☐	IP 67
Add the suffix TF to the end of the catalog number (3)								
Add the suffix TT to the end of the catalog number (3)								
XS2●●SA	XS2●●AA	XS1M●●●KP	XS7C40	XS1M18PA	XS7G XS8G	XS7T XS8T	XS7D	XS●M XSLC
62	66	108	106	108	88	86	80	110

Standards and certifications Parameters related to the environment

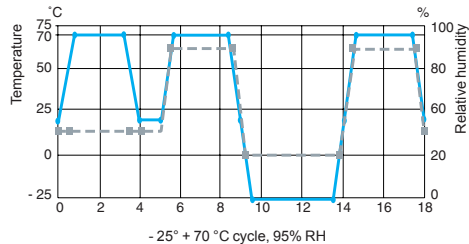

—●— Temperature °C
—■— Humidity as %

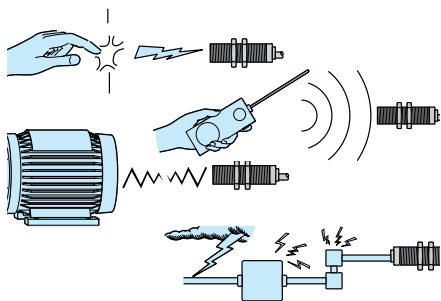

Recommendations

The sensors detailed in this catalog are designed for use in standard industrial applications relating to presence detection. These sensors do not incorporate the required redundant electrical circuit enabling their usage in safety applications. For safety applications, refer to the Preventa™ Machine Safety Products catalog

Quality control

A variety of precautions are taken in order to provide inductive proximity sensors suitable for harsh industrial environments.

■ Qualification

- The product specifications stated in this catalog are subject to a **qualification procedure** carried out in our laboratories.
- In particular, the products are subjected to **climatic cycle** tests for 3,000 hours while powered up to verify their ability to maintain their specifications over time.

■ Production

- The electrical specifications and sensing distances at both ambient temperature and extreme temperatures are 100% checked.
- Products are randomly selected during the course of production and subjected to **monitoring tests** relating to all their qualified specifications.

■ Customer returns

Products that are returned to us and claimed inoperative are subjected to systematic analysis and may result in corrective actions or continuous improvement.

Conformity to standards

All Schneider Electric brand inductive proximity sensors conform to and are tested in accordance with the recommendations of IEC standard 60947-5-2.

Mechanical shock resistance

The sensors are tested in accordance with standard IEC 60068-2-27, 50 gn, duration 11 ms.

Vibration resistance

The sensors are tested in accordance with standard IEC 60068-2-6, amplitude ± 2 mm, 10–55 Hz, 25 gn at 55 Hz.

Resistance to the environment

■ Refer to the specifications pages for the various sensors.

■ IP 67: protection against the effects of immersion.

Test conforming to IEC 60529: sensor immersed for 30 minutes in 1 m (39.37 in.) of water. No deterioration in either operating or insulation specifications is permitted.

■ IP 68: protection against prolonged immersion.

Sensor immersed for 336 hours in 40 meters (131.23 ft) of water at 50 °C (122 °F). No deterioration in either operating or insulation specifications is permitted.

Schneider Electric sensors with an IP 68 degree of protection are ideal for use in the most arduous conditions, such as machine tools and automatic car washes.

■ IP 69K: protection against the effects of high pressure cleaning. Adherence to DIN 40050 which stipulates that the product must withstand a water jet at a pressure of 90 bar (1305 psi) and temperature of +80 °C (176 °F) for 3 minutes.

No deterioration in either operating or insulation specifications is permitted.

Resistance to electromagnetic interference

■ Electrostatic discharges

~ and ~ versions: level 4 immunity (15 kV).
IEC 61000-4-2

■ Radiated electromagnetic fields (electromagnetic waves)

≡, ~ and ~ versions: level 2 (3 V/m) or level 3 (10 V/m) immunity. **IEC 61000-4-3**

■ Fast transients (motor start/stop interference)

≡ version: level 3 immunity (1 kV).
~ and ~ versions: level 4 immunity (2 kV) except Ø 8 mm model (level 2). **IEC 61000-4-4**

■ Impulse voltage

≡, ~ and ~ versions: level 3 immunity (2.5 kV) except Ø 8 mm and smaller models (level 1 kV).
IEC 60947-5-2

Resistance to chemicals in the environment

■ Due to the very wide range of chemicals encountered in industry, it is very difficult to give general guidelines common to all sensors.

■ End users should verify that the application does not subject sensors to chemicals that may damage them.

■ Cylindrical and flat plastic-case sensors offer excellent overall resistance to:

- chemical products such as salts, aliphatic and aromatic oils, petroleum, acids and diluted bases. For alcohols, ketones and phenols, preliminary tests should be made relating to the nature and concentration of the liquid.
- food and beverage industry products such as animal or vegetable based products (vegetable oils, animal fat, fruit juice, dairy proteins, etc.).

The materials selected (see product specifications) provide satisfactory compatibility in most industrial environments (for further information, consult our Customer Information Center).

Insulation

Class 2 devices ☑

Electrical insulation conforms to IEC standards 61140 and NF C 20-030 relating to means of protection against electric shock.

Principle of inductive detection

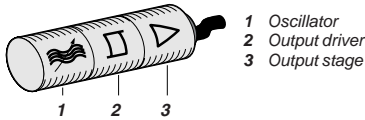

Composition of an inductive proximity sensor

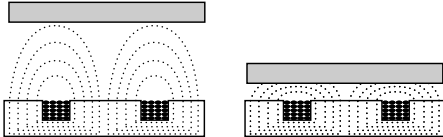

Detection of a metal object

Operating principle

■ An inductive proximity sensor is solely for the detection of metal objects. It essentially comprises an oscillator whose windings constitute the sensing face. An alternating magnetic field is generated in front of these windings.

- When a metal object is placed within the sensor's magnetic field, currents are induced. These currents form an additional load, causing the sensor's oscillations to cease. This cessation causes the output driver to operate: depending on the sensor type, a normally open (NO) or normally closed (NC) output signal is produced.

2

Inductive proximity detection

- Inductive proximity sensors enable the detection, without physical contact, of metal objects.
- Their range of applications is very extensive and includes:
 - monitoring the position of machine parts (cams, end stops, etc.),
 - counting the number of metal objects, etc.

Advantages of inductive detection

- No physical contact with the object to be detected, thus avoiding wear and enabling detection of fragile objects, freshly painted objects, etc.
- High operating rates. Fast response.
- Excellent resistance to industrial environments (robust products, fully encapsulated in resin).
- Solid-state technology: no moving parts, therefore service life of sensor not related to number of operating cycles.

Flush mountable using teach mode sensors

- The flush mountable sensors using teach mode are suitable for all metal environments (flush mountable or non-flush mountable) since they ensure a maximum sensing distance, even if there is a metal background. Precise detection of the position of the object can be obtained using the teach mode. For further information, see page 2/70.

LED indicator

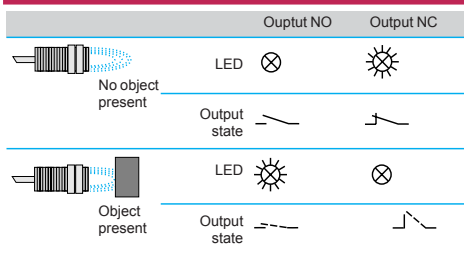

Output LED

All Schneider Electric inductive proximity sensors incorporate an output state LED indicator. The flush mountable sensors using teach mode are fitted with a green LED that indicates "Power on" and also assists the user during setup (teach mode).

Mounting sensors on a metal support

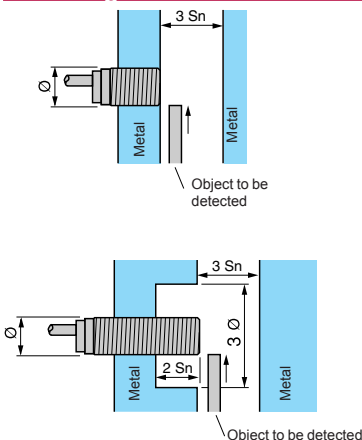

Flush mountable in metal

- No side clearance required.
- All flush mountable sensors using teach mode also enable detection of an object against a metal background. For further information, see page 2/70.

Sensors not suitable for flush mounting in metal

- Side clearance required. Sensing distance greater than that for a standard flush mountable model.
- Flush mountable sensors using teach mode eliminate the need for side clearance. For further information, see page 2/70.

OsiSense® XS Inductive proximity sensors

Mounting sensors on a metal support

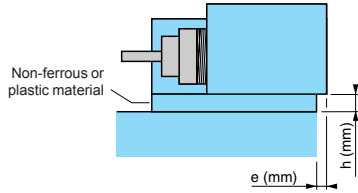

Mounting using mounting clamp

- Standard flush mountable models: $e = 0, h = 0$
- Standard non-flush mountable models
 - $\varnothing 6.5 / 8 / 12$ mm: $e = 0, h = 0$
 - $\varnothing 18$ mm: if $h = 0, e \geq 5; e = 0, h \geq 3$.
 - $\varnothing 30$ mm: if $h = 0, e \geq 8; e = 0, h \geq 4$.
- Flush mountable sensors using teach mode: $e = 0, h = 0$

2

Mounting distance between sensors

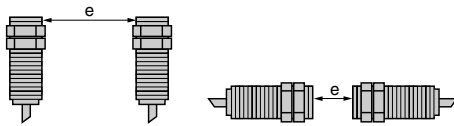

Mounting side by side
 $e \geq 2 S_n$ (mm)

Mounting face to face
 $e \geq 10 S_n$ (mm)

Standard sensors

If two standard sensors are mounted too close to each other they are likely to lock in the "detection state" due to interference between their respective oscillating frequencies. To avoid this condition, the minimum mounting distances stated for the sensors should be adhered to or, alternatively, sensors with staggered oscillating frequencies should be used.

Staggered frequency sensors

For applications where the minimum recommended mounting distances for standard sensors cannot be achieved, it is possible to overcome this restraint by using staggered frequency sensors. consult the Sensor Competency Center. In this case, a staggered frequency sensor is mounted adjacent to or opposite each standard sensor.

Tightening torque for cylindrical type sensors

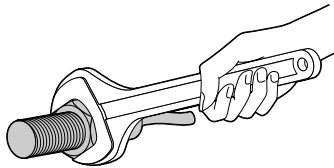

Maximum tightening torque for the various sensor case materials, N*m (lb-in)

Diameter of sensor (mm)	Maximum tightening torque for the various sensor case materials, N*m (lb-in)			
	Brass	Brass	Stainless steel	Plastic
	Short case model	Long case model form A	Long case model form A	All models
	XS5●●B1	XS6●●B1 XS6●●B2 XSAV●	XS1●● XS2●●	XS4P●●
$\varnothing 5$	1.6 (14.16)	1.6 (14.16)	2 (17.70)	–
$\varnothing 8$	5 (44.25)	5 (44.25)	9 (79.66)	1 (8.85)
$\varnothing 12$	6 (53.10)	15 (132.76)	30 (265.52)	2 (17.70)
$\varnothing 18$	15 (132.76)	35 (309.78)	50 (442.54)	5 (44.25)
$\varnothing 30$	40 (354.03)	50 (442.54)	100 (885.07)	20 (177.01)

Sensing distance

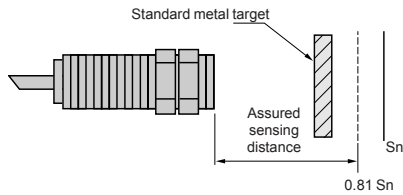
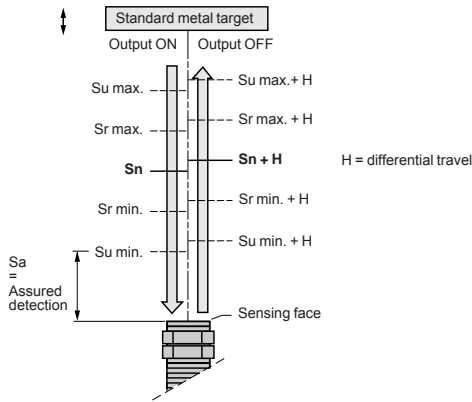

Terminology

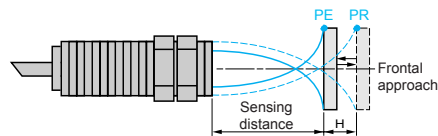

PE = pick-up point, the object is detected
PR = drop-out point, the object is no longer detected

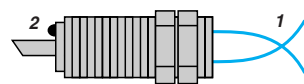
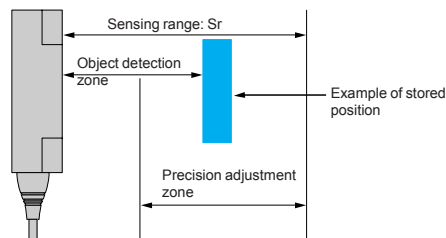

1 Detection threshold curves
2 "Object detected" LED

Definitions

In order to allow customers to make reliable product comparisons and selection, the standard IEC 60947-5-2 defines various sensing distances, such as:

- Nominal sensing distance (Sn)**
 The rated operating distance for which the sensor is designed. It does not take into account any variations (manufacturing tolerances, temperature, voltage).
- Effective sensing distance (Sr)**
 The effective sensing distance is measured at the rated voltage (Un) and the rated ambient temperature (Tn). It must be between 90% and 110% of the nominal sensing distance (Sn):
 $0.9 Sn \leq Sr \leq 1.1 Sn$
- Usable sensing distance (Su)**
 The usable sensing distance is measured at the limits of the permissible variations in the ambient temperature (Ta) and the supply voltage (Ub). It must be between 90% and 110% of the effective sensing distance: $0.9 Sr \leq Su \leq 1.1 Sr$.
- Assured operating distance (Sa).**
 This is the operating zone of the sensor. The assured sensing distance is between 0 and 81% of the nominal sensing distance (Sn): $0 \leq Sa \leq 0.9 \times 0.9 \times Sn$

2

Standard metal target

The standard IEC 60947-5-2 defines the standard metal target as a square mild steel (Fe 360) plate, 1 mm (0.04 in.) thick. The side dimension of the plate is either equal to the diameter of the circle engraved on the sensing face of the sensor or three times the nominal sensing distance (Sn).

Differential travel

The differential travel (H), or hysteresis, is the distance between the operating point, as the standard metal target moves towards the sensor, and the release point, as it moves away. This hysteresis is essential for the stable operation of the sensor.

Repeat accuracy

The repeat accuracy (R) is the repeatability of the sensing distance between successive operations. Readings are taken over a period of time while the sensor is subjected to voltage and temperature variations: 8 hours, 10 to 30 °C (50 to 86 °F), $Un \pm 5\%$. It is expressed as a percentage of the effective sensing distance Sr.

Detection zone and precision adjustment zone

- Flush mountable sensors using teach mode, due to adjustment of sensitivity while teaching, enable the position of an object to be detected as it approaches from the front or side. The teach mode can be used when the object is located in the zone known as the "precision adjustment zone". When the object approaches from the front, the detection zone of the object ranges from the stored position down to zero.

Operating zone

- The operating zone relates to the area in front of the sensing face in which the detection of a metal object is certain. The values stated in the specifications relating to the various types of sensor are for steel objects of a size equal to the sensing face of the sensor. For objects of a different nature (smaller than the sensing face of the sensor, other metals, etc.), it is necessary to apply a correction coefficient.

2

Correction coefficients to apply to the assured operating distance

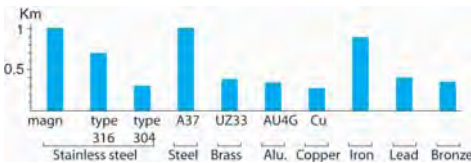
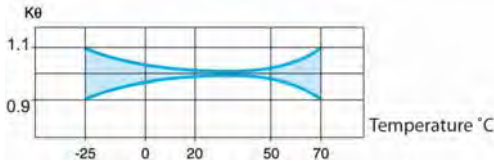

Typical curve for a copper object used with a Ø 18 mm cylindrical sensor

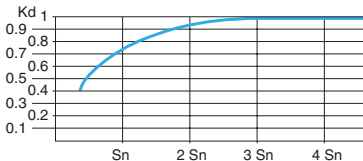

Typical curve for a steel object used with a Ø 18 mm cylindrical sensor

Calculation examples

Assured operating distance of a sensor

In practice, most objects to be detected are generally made of steel and are of a size equal to or greater than the sensing face of the sensor.

For the calculation of the assured operating distance for different operating conditions, you must take into account the correction coefficients that influence it.

The curves indicated are purely representational of typical curves. They are only given as a guide to the approximate usable sensing distance of a proximity sensor for a given application.

Influence of ambient temperature

Apply a correction coefficient K_{θ} , determined from the curve shown opposite.

Material of object to be detected

Apply a correction coefficient K_m , determined from the diagram shown opposite.

The fixed sensing distance models for ferrous/non-ferrous (Fe/NFe) materials enable the detection of different objects at a fixed distance, regardless of the type of material.

Special case of a very thin object made of a non-ferrous material.

Size of object to be detected

Apply a correction coefficient K_d , determined from the curve shown opposite.

When calculating the sensing distance for the selection of a sensor, make the assumption that $K_d = 1$.

Variation of supply voltage

In all cases, apply the correction coefficient $K_t = 0.9$.

Correction of the sensing distance of a sensor

Sensor with nominal sensing distance $S_n = 15$ mm.

Ambient temperature variation 0 to + 20 °C.

Object material and size: steel, 30 x 30 x 1 mm thick.

The assured sensing distance S_a is determined using the formula:

$$S_a = S_n \times K_{\theta} \times K_m \times K_d \times K_t = 15 \times 0.98 \times 1 \times 0.95 \times 0.9$$

i.e. $S_a = 12.5$ mm.

Selecting a sensor for a given application

Application specifications:

- object material and size: iron ($K_m = 0.9$), 30 x 30 mm,
- temperature: 0 to 20 °C ($K_{\theta} = 0.98$),
- object detection distance: 3 mm ± 1.5 mm, i.e. $S_a \text{ max.} = 4.5$ mm,
- assume $K_d = 1$.

A sensor must be selected for which
$$S_n \geq \frac{S_a}{K_{\theta} \times K_m \times K_d \times K_t} = \frac{4.5}{0.98 \times 0.9 \times 1 \times 0.9}$$

i.e. $S_n \geq 5.7$ mm

Specific aspects of electronic sensors

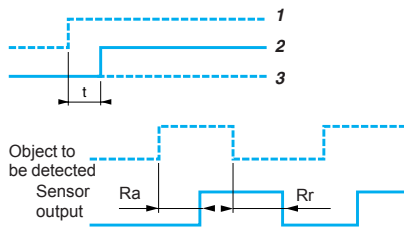
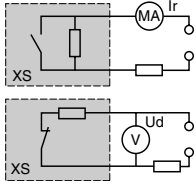

Supply

Terminology

- Residual current (Ir)
- The residual current (Ir) corresponds to the current flowing through the sensor when in the "open" state.
- Characteristic of 2-wire type proximity sensors.

- Voltage drop (Ud)
- The voltage drop (Ud) corresponds to the voltage drop at the sensor's terminals when in the "closed" state (value measured at nominal current rating of sensor).

- First-up delay
- The first-up delay corresponds to the time (t) between the connection of the power supply to the sensor and its fully operational state.

- 1 Supply voltage U on
- 2 Sensor operational at state 1
- 3 Sensor at state 0

- Response time
- Response time (Ra): the time delay between the object to be detected entering the sensor's operating zone and the subsequent change of output state. This parameter limits the speed and size of the object.
- Recovery time (Rr): the time delay between an object to be detected leaving the sensor's operating zone and the subsequent change of output state. This parameter limits the interval between successive objects.

2

Sensors for AC circuits (~ and ~ models)

Check that the voltage limits of the sensor are compatible with the nominal voltage of the AC supply used.

Sensors for DC circuits

- **DC source:** check that the voltage limits of the sensor and the acceptable level of ripple are compatible with the supply used.
- **AC source** (comprising transformer, rectifier, smoothing capacitor): the supply voltage must be within the operating limits specified for the sensor.

Where the voltage is derived from a single-phase AC supply, the voltage must be rectified and smoothed to ensure that:

- the peak voltage of the DC supply is lower than the maximum voltage rating of the sensor.
- the minimum voltage of the supply is greater than the minimum voltage rating of the sensor,

given that :

$$\Delta V = (I \times t) / C$$

ΔV = max. ripple: 10% (V),

I = anticipated load current (mA),

t = period of 1 cycle (10 ms full-wave rectified for a 50 Hz supply frequency),

C = capacitance (μ F).

As a general rule, use a transformer with a lower secondary voltage (Ue) than the required DC voltage (U).

Example:

~ 18 V to obtain --- 24 V,

~ 36 V to obtain --- 48 V.

Outputs

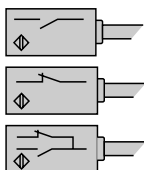

Output signal (contact logic)

- **Normally open (NO)**
Corresponds to a sensor whose output changes to the closed state when an object is present in the operating zone.

- **Normally closed (NC)**
Corresponds to a sensor whose output changes to the open state when an object is present in the operating zone.

- **Complementary outputs (NO + NC)**
Corresponds to a sensor with a normally closed output and a normally open output.

2

Outputs (continued)

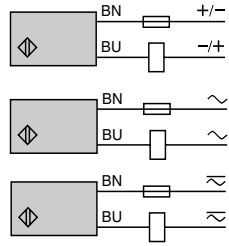

2-wire type, non-polarized NO or NC output

- **Specific aspects**
 - These sensors are wired in series with the load to be switched.
 - As a consequence, they are subject to:
 - a residual current in the open state (current flowing through the sensor in the “open” state)
 - A voltage drop in the closed state (voltage drop across the sensor’s terminals in the “closed” state)
- **Advantages**
 - Only two leads to be wired: these sensors can be wired in series in the same way as mechanical limit switches
 - They can be connected to either positive-logic (PNP) or negative-logic (NPN) PLC inputs
 - Simple, reversible connections
- **Operating precautions**
 - Check the possible effects of residual current and voltage drop on the actuator or input connected.
 - For sensors that do not have overload and short-circuit protection (AC or AC/DC symbol), a 0.4 A fast-acting fuse must be connected in series with the load.

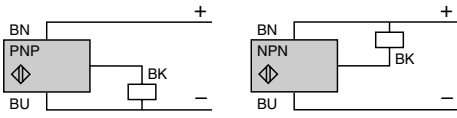

3-wire type, NO or NC output, PNP or NPN

- **Specific aspects**
 - These sensors comprise two wires for the DC supply and a third wire for the output signal.
 - PNP type: switching the positive side to the load
 - NPN type: switching the negative side to the load
- **Advantages**
 - Protection against supply reverse polarity
 - Protection against overload and short-circuit
 - No residual current, low voltage drop

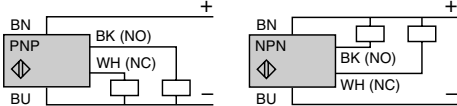

4-wire type, complementary NO and NC outputs, PNP or NPN

- **Advantages**
 - Protection against supply reverse polarity (+/-)
 - Protection against overload and short-circuit

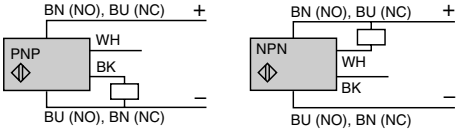

4-wire type, multifunction, programmable NO or NC output, PNP or NPN

- **Advantages**
 - Protection against supply reverse polarity (+/-)
 - Protection against overload and short-circuit

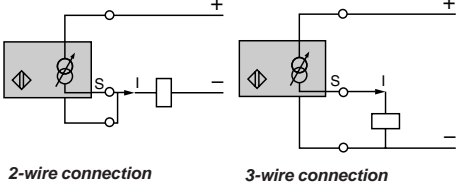

Specific output signals, analog type

- These sensors convert the approach of a metal object towards the sensing face into an output current variation which is proportional to the distance between the object and the sensing face.
- Two models available:
 - 0–10 V (0–10 mA) output for 3-wire connection
 - 4–20 mA output for 2-wire connection

OsiSense® XS Inductive proximity sensors

Features of the various models

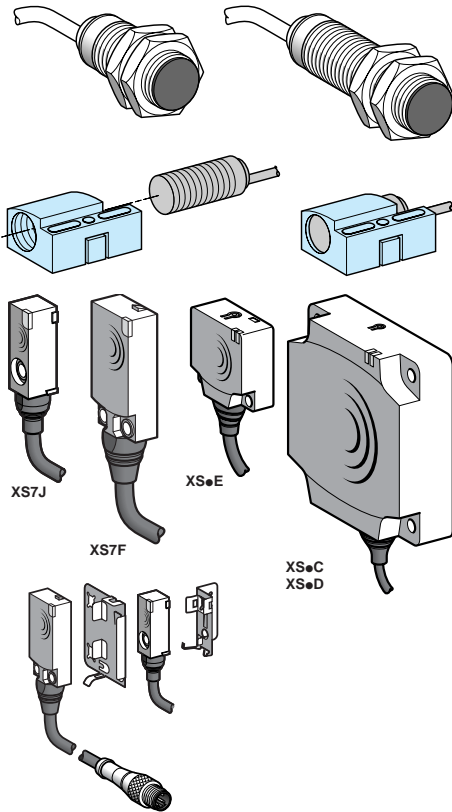

Types of case

- **Cylindrical case**
 - Fast installation and setup.
 - Short case and long case, 2-wire --- and 3-wire --- versions available.
 - Pre-cabled (molded cable) and various integral connector (M8, M12, 7/8", M18) and remote connector (on pigtail connector) versions available.
 - Small size facilitates mounting in locations with restricted access.
 - **Interchangeability**, provided by indexed **mounting clamp**: when assembled, becomes similar to a block type sensor.

- **Flat case**
 - Reduced size (sensor volume divided by 8).
 - Fast installation by mounting using clip-on brackets.
 - Precision detection with the flush mountable sensors using teach mode

Electrical connection

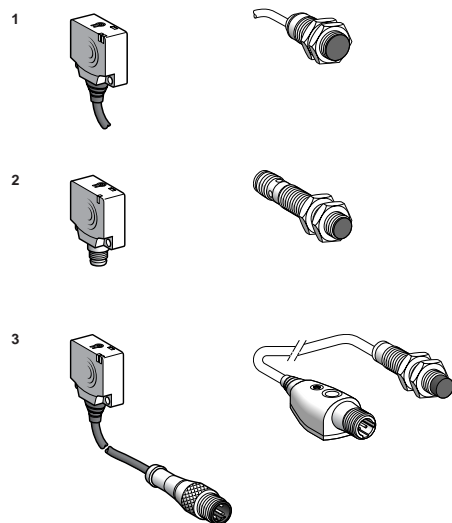

Connection methods

- 1 Pre-cabled:** factory-fitted molded cable, good protection against splashing liquids (IP 68). Example: machine tool.
- 2 Connector:** easy installation and maintenance (IP 67).
- 3 Remote connector:** easy installation and maintenance (IP 68 at sensor level and IP 67 at remote connector level).

Wiring

- **Length of cable**
 - No limitation up to 200 m or up to a line capacitance of < 100 nF (specifications of sensor remain unaffected)
 - In this case, it is important to take into account the voltage drop on the line

- **Separation of control and power circuit wiring**
 - The sensors are immune to electrical interference encountered in normal industrial conditions
 - Where extreme conditions of electrical "noise" could occur (large motors, spot welders, etc.) it is advisable to protect against transients in the normal way:
 - suppress interference at source
 - separate power and control wiring from each other
 - smooth the supply
 - limit the length of cable

- **Connect the sensor with supply switched off.**

2

Setup

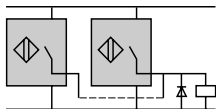
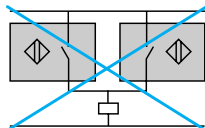
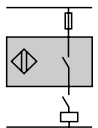
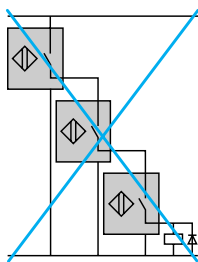

AC supply

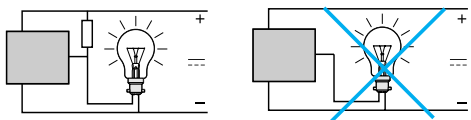
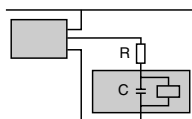

Connection in series

2-wire type sensors

- The following points should be taken into account:
 - Series wiring is only possible using sensors with wide voltage limits. Based on the assumption that each sensor has the same residual current value, each sensor, in the open state, will share the supply voltage, i.e.

$$U_{\text{sensor}} = \frac{U_{\text{supply}}}{n \text{ sensors}}$$

- U sensor and U supply must remain within the sensor's voltage limits.
 - If only one sensor in the circuit is in the open state, it will be supplied at a voltage almost equal to the supply voltage.
 - When in the closed state, a small voltage drop is present across each sensor. The resulting loss of voltage at the load will be the sum of the individual voltage drops and therefore, the load voltage should be selected accordingly.

3-wire type sensors

- This connection method is not recommended.
- Correct operation of the sensors cannot be assured and, if this method is used, tests should be made before installation.
 - The following points should be taken into account:
 - Sensor 1 carries the load current in addition to the no-load current consumption values of the other sensors connected in series. For certain models, this connection method is not possible unless a current limiting resistor is used.
 - When in the closed state, a small voltage drop is present across each sensor. The load should therefore be selected accordingly.
 - As sensor 1 closes, sensor 2 does not operate until a certain time (t) has elapsed (corresponding to the first-up delay) and likewise for the following sensors in the sequence.
 - The use of "flywheel" diodes is recommended when an inductive load is being switched.

Sensors and devices in series with an external mechanical contact

- 2 and 3-wire type sensors**
- The following points should be taken into account:
 - When the mechanical contact is open, the sensor is not supplied.
 - When the contact closes, the sensor does not operate until a certain time (t) has elapsed (corresponding to the first-up delay).

Connection in parallel

2-wire type sensors

- This connection method is not recommended.
- Should one of the sensors be in the closed state, the sensor in parallel will be "shorted-out" and no longer supplied.
 - As the first sensor passes into the open state, the second sensor will become energized and will be subject to its first-up delay.
 - This configuration is only permissible where the sensors will be working alternately.
 - This method of connection can lead to irreversible damage to the units.

3-wire type sensors

- No specific restrictions. The use of "flywheel" diodes is recommended when an inductive load (relay) is being switched.

AC supply

- **2-wire type sensors cannot be connected directly to an AC supply.**
 - Improper installation can result in injury or sensor damage
 - An appropriate load (refer to the instruction sheet supplied with the sensor) must always be connected in series with the sensor.

Capacitive load (C > 0.1 μF)

- On power-up, it is necessary to limit (by resistor) the charging current of the capacitive load C.
- The voltage drop in the sensor can also be taken into account by subtracting it from the supply voltage for the calculation of R.

$$R = \frac{U_{\text{supply}}}{I_{\text{max. (sensor)}}$$

Load comprising an incandescent lamp

- If the load comprises an incandescent lamp, the hot state resistance can be 10 times higher than the cold state resistance. This can cause very high current levels on switching. Fit a pre-heat resistor in parallel with the sensor.

$$R = \frac{U^2}{P} \times 10 \quad , \quad U = \text{supply voltage and } P = \text{lamp power}$$

OsiSense® XS Inductive proximity sensors

2

Fast troubleshooting guide		
Problem	Possible causes	Remedy
The sensor's output will not change state when a metal object enters the detection zone	On a flush mountable sensor using teach mode: setup or programming error.	<ul style="list-style-type: none"> ■ After a RESET, follow the environment teach mode procedure. Refer to instruction sheet supplied with sensor.
	Inoperative sensor or the short circuit protection has been opened	<ul style="list-style-type: none"> ■ Check that the sensor is compatible with the supply being used. ■ Check the load current specifications: <ul style="list-style-type: none"> □ if load current $I \geq$ maximum switching capacity, an auxiliary relay, of the CADN type for example, should be interposed between the sensor and the load, □ if $I \leq$ maximum switching capacity, check for wiring issues (short-circuit). ■ In all cases, a 0.4 A fast-acting fuse should be connected in series with the sensor.
	Wiring error	<ul style="list-style-type: none"> ■ Check that the wiring conforms to the wiring shown on the sensor label or instruction sheet.
	Improper power supply	<ul style="list-style-type: none"> ■ Check that the sensor is compatible with the supply (\sim or ---). ■ Check that the supply voltage is within the voltage limits of the sensor. Remember that with a rectified, smoothed supply, $U_{\text{peak}} = U_{\text{nominal}} \times \sqrt{2}$ with a ripple voltage $\leq 10\%$.
False or erratic operation, with or without the presence of a metal object in the detection zone	On flush mountable sensor using teach mode: setup or programming error.	<ul style="list-style-type: none"> ■ After a RESET, follow the environment teach mode procedure. Refer to instruction sheet supplied with sensor.
	Influence of background or metal environment	<ul style="list-style-type: none"> ■ Refer to the instruction sheet supplied with the sensor. For sensors with adjustable sensitivity, reduce the sensing distance.
	Sensing distance poorly defined for the object to be detected	<ul style="list-style-type: none"> ■ Apply the correction coefficients. ■ Realign the system or run the teach mode again.
	Influence of transient interference on the supply lines	<ul style="list-style-type: none"> ■ Ensure that any DC supplies, when derived from rectified AC, are correctly smoothed ($C > 400 \mu\text{F}$). ■ Separate AC power cables from low-level DC cables (24 V low level). ■ Where very long distances are involved, use suitable cable: screened and twisted pairs of the correct cross-sectional area.
	Equipment prone to emitting electromagnetic interference	<ul style="list-style-type: none"> ■ Position the sensors as far away as possible from any sources of interference.
	Response time of the sensor too slow for the particular object being detected	<ul style="list-style-type: none"> ■ Check the suitability of the sensor for the position or size of the object to be detected. ■ If necessary, select a sensor with a higher switching frequency.
	Influence of high temperature	<ul style="list-style-type: none"> ■ Eliminate sources of radiated heat or protect the sensor casing with a heat shield. ■ Realign, having adjusted the temperature around the mounting support.
No detection following a period of service	Vibration, shock	<ul style="list-style-type: none"> ■ Realign the system. ■ Replace the support or protect the sensor.

OsiSense® XS Inductive proximity sensors

Basic, cylindrical, flush mountable, increased range
Three-wire DC, solid-state output

2

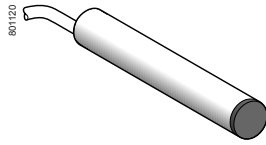

XS106B3●●L2

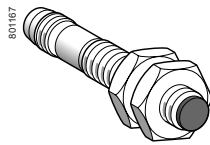

XS108B3●●M8

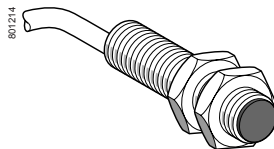

XS112B3●●L2

Sensing distance Sn, mm (in.)	Function	Output	Connection	Sold in lots of	Catalog Number	Weight kg (lb)		
Ø 6.5, plain								
Three-wire 12–24 V \overline{DC}, flush mountable								
2 (0.07)	NO	PNP	Pre-cabled (L = 2 m) (1)	1	XS106B3PAL2	0.060 (0.13)		
			M8 connector	1	XS106B3PAM8	0.030 (0.06)		
			M12 connector	1	XS106B3PAM12	0.050 (0.11)		
		NPN	Pre-cabled (L = 2 m)	20	XS106B3PAL2TQ	0.980 (2.16)		
			M8 connector	20	XS106B3PAM8TQ	0.320 (0.70)		
			M12 connector	20	XS106B3PAM12TQ	0.350 (0.77)		
	NC	PNP	Pre-cabled (L = 2 m) (1)	1	XS106B3PAL2	0.060 (0.13)		
			M8 connector	1	XS106B3PAM8	0.030 (0.06)		
			M12 connector	1	XS106B3PAM12	0.050 (0.11)		
		NPN	Pre-cabled (L = 2 m)	20	XS106B3PAL2TQ	0.980 (2.16)		
			M8 connector	20	XS106B3PAM8TQ	0.320 (0.70)		
			M12 connector	20	XS106B3PAM12TQ	0.350 (0.77)		
Ø 8, threaded M8 x 1								
Three-wire 12–24 V \overline{DC}, flush mountable								
2 (0.07)	NO	PNP	Pre-cabled (L = 2 m) (1)	1	XS108B3PAL2	0.070 (0.15)		
			M8 connector	1	XS108B3PAM8	0.030 (0.06)		
			M12 connector	1	XS108B3PAM12	0.060 (0.13)		
			NPN	Pre-cabled (L = 2 m)	20	XS108B3PAL2TQ	1.120 (2.46)	
				M8 connector	20	XS108B3PAM8TQ	0.460 (1.01)	
				M12 connector	20	XS108B3PAM12TQ	0.940 (2.07)	
		NC	PNP	Pre-cabled (L = 2 m) (1)	1	XS108B3PAL2	0.070 (0.15)	
				M8 connector	1	XS108B3PAM8	0.030 (0.06)	
				M12 connector	1	XS108B3PAM12	0.060 (0.13)	
			NPN	Pre-cabled (L = 2 m)	20	XS108B3PAL2TQ	1.120 (2.46)	
				M8 connector	20	XS108B3PAM8TQ	0.460 (1.01)	
				M12 connector	20	XS108B3PAM12TQ	0.940 (2.07)	
	Ø 12, threaded M12 x 1							
	Three-wire 12–24 V \overline{DC}, flush mountable							
	4 (0.15)	NO	PNP	Pre-cabled (L = 2 m) (1)	1	XS112B3PAL2	0.090 (0.19)	
				M12 connector	1	XS112B3PAM12	0.030 (0.06)	
				Pre-cabled (L = 2 m)	20	XS112B3PAL2TQ	1.600 (3.52)	
				NPN	M12 connector	20	XS112B3PAM12TQ	0.470 (1.03)
					Pre-cabled (L = 2 m) (1)	1	XS112B3PAL2	0.090 (0.19)
					M12 connector	1	XS112B3PAM12	0.030 (0.06)
			NC	PNP	Pre-cabled (L = 2 m)	20	XS112B3PAL2TQ	1.600 (3.52)
					M12 connector	20	XS112B3PAM12TQ	0.470 (1.03)
					Pre-cabled (L = 2 m) (1)	1	XS112B3PAL2	0.090 (0.19)
				NPN	M12 connector	1	XS112B3PAM12	0.030 (0.06)
Pre-cabled (L = 2 m)					20	XS112B3PAL2TQ	1.600 (3.52)	
M12 connector					20	XS112B3PAM12TQ	0.470 (1.03)	

(1) For a 5 m cable replace L2 with L5.
Example: XS106B3PAL2 becomes XS106B3PAL5 with a 5 m cable.

OsiSense® XS Inductive proximity sensors

Basic, cylindrical, flush mountable, increased range
Three-wire DC, solid-state output

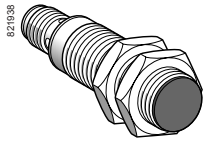

XS118B3●●M12

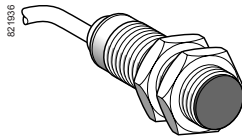

XS118B3●●L2

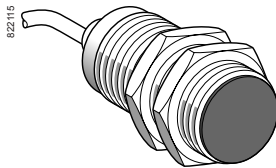

XS130B3●●L2

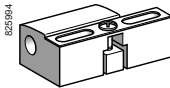

XSZB1●●

Sensing distance Sn, mm (in.)	Function	Output	Connection	Sold in lots of	Catalog Number	Weight kg (lb)	
Ø 18, threaded M18 x 1							
Three-wire 12–24 V \overline{DC}, flush mountable							
8 (0.31)	NO	PNP	Pre-cabled (L = 2 m) (1)	1	XS118B3PAL2	0.110 (0.24)	
			M12 connector	1	XS118B3PAM12	0.060 (0.13)	
			Pre-cabled (L = 2 m)	20	XS118B3PAL2TQ	2.000 (4.40)	
			M12 connector	20	XS118B3PAM12TQ	1.140 (2.51)	
			Pre-cabled (L = 2 m) (1)	1	XS118B3NAL2	0.110 (0.24)	
			M12 connector	1	XS118B3NAM12	0.060 (0.13)	
	NPN	Pre-cabled (L = 2 m)	20	XS118B3NAL2TQ	2.000 (4.40)		
		M12 connector	20	XS118B3NAM12TQ	1.140 (2.51)		
		NC	PNP	Pre-cabled (L = 2 m) (1)	1	XS118B3PBL2	0.110 (0.24)
				M12 connector	1	XS118B3PBM12	0.060 (0.13)
				NPN	Pre-cabled (L = 2 m) (1)	1	XS118B3NBL2
					M12 connector	1	XS118B3NBM12

Ø 30, threaded M30 x 1.5							
Three-wire 12–24 V \overline{DC}, flush mountable							
15 (0.59)	NO	PNP	Pre-cabled (L = 2 m) (1)	1	XS130B3PAL2	0.180 (0.39)	
			M12 connector	1	XS130B3PAM12	0.130 (0.28)	
			Pre-cabled (L = 2 m)	20	XS130B3PAL2TQ	3.360 (7.40)	
			M12 connector	20	XS130B3PAM12TQ	2.000 (4.40)	
			Pre-cabled (L = 2 m) (1)	1	XS130B3NAL2	0.180 (0.39)	
			M12 connector	1	XS130B3NAM12	0.130 (0.28)	
	NPN	Pre-cabled (L = 2 m)	20	XS130B3NAL2TQ	2.000 (4.40)		
		M12 connector	20	XS130B3NAM12TQ	2.000 (4.40)		
		NC	PNP	Pre-cabled (L = 2 m) (1)	1	XS130B3PBL2	0.180 (0.39)
				M12 connector	1	XS130B3PBM12	0.130 (0.28)
				NPN	Pre-cabled (L = 2 m) (1)	1	XS130B3NBL2
					M12 connector	1	XS130B3NBM12

Accessories			
Description	For use with sensors	Catalog Number	Weight kg (lb)
Mounting clamps	Ø = 6.5 (plain)	XSZB165	0.005 (0.01)
	Ø 8 (M8 x 1)	XSZB108	0.006 (0.01)
	Ø 12 (M12 x 1)	XSZB112	0.006 (0.01)
	Ø 18 (M18 x 1)	XSZB118	0.010 (0.02)
	Ø 30 (M30 x 1.5)	XSZB130	0.020 (0.04)

(1) For a 5 m cable replace L2 with L5.
Example: XS118B3PAL2 becomes **XS118B3PAL5** with a 5 m cable.



OsiSense® XS

Inductive proximity sensors

Basic, cylindrical, flush mountable, increased range
Three-wire DC, solid-state output

2

Specifications		XS1●●B3●●M8	XS1●●B3●●M12	XS1●●B3●●L2
Sensor type				
Product certifications		UL, CSA, CE		
Connection	Connector	M8	M12	–
	Pre-cabled	–	–	Length 2 m
Operating zone	Ø 6.5 and Ø 8	mm	0–1.6 (0–0.06 in.)	
	Ø 12	mm	0–3.2 (0–0.12 in.)	
	Ø 18	mm	0–6.4 (0–0.25 in.)	
	Ø 30	mm	0–12 (0–0.47 in.)	
Differential travel		%	1–15 of effective sensing distance (Sr)	
Degree of protection	Conforming to IEC 60529		IP 65 and IP 67	
Storage temperature		°C	–40 to +85 (–40 to +185 °F)	
Operating temperature		°C	–25 to +70 (–13 to +158 °F)	
Materials	Case	Nickel-plated brass		
	Cable	–		PvR 3 x 0.34 mm ² (22 AWG) except Ø 6.5 and 8: 3 x 0.11 mm ² (27 AWG)
Vibration resistance	Conforming to IEC 60068-2-6	25 gn, amplitude ± 2 mm (f = 10 to 55 Hz)		
Shock resistance	Conforming to IEC 60068-2-27	50 gn, duration 11 ms		
Output state indication		Yellow LED, 4 viewing ports at 90°		Yellow LED, annular
Rated supply voltage		V	– 12–24 with protection against reverse polarity	
Voltage limits (including ripple)		V	– 10–36	
Switching capacity		mA	≤ 200 with overload and short-circuit protection	
Voltage drop, closed state		V	≤ 2	
Current consumption, no-load		mA	≤ 10	
Maximum switching frequency	Ø 6.5, Ø 8, and Ø 12	Hz	2500	
	Ø 18	Hz	1000	
	Ø 30	Hz	500	
Delays	First-up	ms	≤ 10	
	Response	ms	≤ 0.2 for Ø 8 and Ø 12, ≤ 0.3 for Ø 18, ≤ 0.6 for Ø 30	
	Recovery	ms	≤ 0.2 for Ø 8 and Ø 12, ≤ 0.7 for Ø 18, ≤ 1.4 for Ø 30	

Wiring diagrams

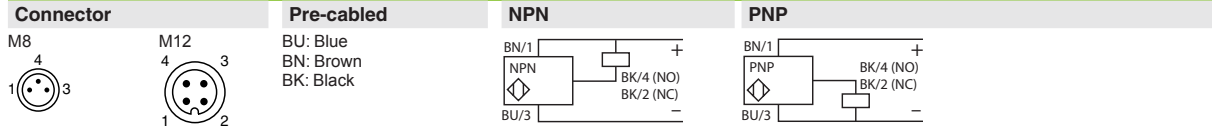

OsiSense® XS

Inductive proximity sensors

Basic, cylindrical, flush mountable, increased range
Three-wire DC, solid-state output

Setup

Minimum mounting distances (mm)

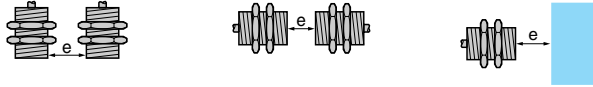

Sensors		Side by side	Face to face	Facing a metal object
Ø 6.5 flush mountable	XS106B3	$e \geq 4$	$e \geq 24$	$e \geq 6$
Ø 8 flush mountable	XS108B3	$e \geq 4$	$e \geq 24$	$e \geq 6$
Ø 12 flush mountable	XS112B3	$e \geq 8$	$e \geq 50$	$e \geq 12$
Ø 18 flush mountable	XS118B3	$e \geq 16$	$e \geq 100$	$e \geq 25$
Ø 30 flush mountable	XS130B3	$e \geq 30$	$e \geq 180$	$e \geq 45$

2

Dimensions (mm)

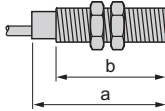

Sensors	Flush mountable in metal					
	Pre-cabled (mm)		M8 connector (mm)		M12 connector (mm)	
	a	b	a	b	a	b
Ø 6.5 XS106B3	33	30	42	34	45	24
Ø 8 XS108B3	33	25	42	26	45	23
Ø 12 XS112B3	35	25	-	-	50	29
Ø 18 XS118B3	38	28	-	-	50.3	28
Ø 30 XS130B3	42.3	32	-	-	54.5	32

OsiSense® XS Inductive proximity sensors

Basic, cylindrical, metal, flush and non-flush mountable
Two-wire, AC supply
Three-wire DC, solid-state output

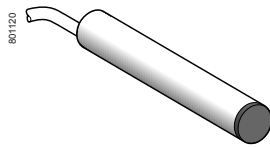

XS106BL●●L2

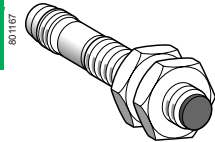

XS108BL●●M8

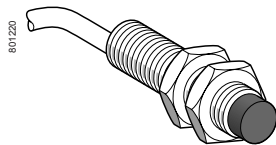

XS208BL●●L2

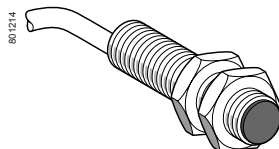

XS112BL●●L2

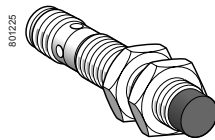

XS212BL●●M12

Sensing distance Sn, mm (in.)	Function	Output	Connection	Catalog Number	Weight	
					kg	(lb)
Ø 6.5, plain						
Three-wire 12–24 V $\overline{\text{---}}$, flush mountable						
1.5 (0.05)	NO	PNP	Pre-cabled (L = 2 m) (1)	XS106BLPAL2	0.030	(0.06)
		NPN	Pre-cabled (L = 2 m) (1)	XS106BLNAL2	0.030	(0.06)
	NC	PNP	Pre-cabled (L = 2 m) (1)	XS106BLPBL2	0.030	(0.06)
		NPN	Pre-cabled (L = 2 m) (1)	XS106BLNBL2	0.030	(0.06)
Ø 8, threaded M8 x 1						
Three-wire 12–24 V $\overline{\text{---}}$, flush mountable						
1.5 (0.05)	NO	PNP	Pre-cabled (L = 2 m) (1)	XS108BLPAL2	0.035	(0.07)
			M8 connector	XS108BLPAM8	0.008	(0.01)
			M12 connector	XS108BLPAM12	0.015	(0.03)
	NPN	PNP	Pre-cabled (L = 2 m) (1)	XS108BLNAL2	0.035	(0.07)
			M8 connector	XS108BLNAM8	0.008	(0.01)
			M12 connector	XS108BLNAM12	0.015	(0.03)
	NC	PNP	Pre-cabled (L = 2 m) (1)	XS108BLPBL2	0.035	(0.07)
			M8 connector	XS108BLPBM8	0.008	(0.01)
			M12 connector	XS108BLPBM12	0.015	(0.03)
	NPN	PNP	Pre-cabled (L = 2 m) (1)	XS108BLNBL2	0.035	(0.07)
			M8 connector	XS108BLNBM8	0.008	(0.01)
			M12 connector	XS108BLNBM12	0.015	(0.03)
Three-wire 12–24 V $\overline{\text{---}}$, non-flush mountable						
2.5 (0.09)	NO	PNP	Pre-cabled (L = 2 m) (1)	XS208BLPAL2	0.035	(0.07)
			M8 connector	XS208BLPAM8	0.008	(0.01)
			M12 connector	XS208BLPAM12	0.015	(0.03)
	NPN	PNP	Pre-cabled (L = 2 m) (1)	XS208BLNAL2	0.035	(0.07)
			M8 connector	XS208BLNAM8	0.008	(0.01)
			M12 connector	XS208BLNAM12	0.015	(0.03)
	NC	PNP	Pre-cabled (L = 2 m) (1)	XS208BLPBL2	0.035	(0.07)
			M8 connector	XS208BLPBM8	0.008	(0.01)
			M12 connector	XS208BLPBM12	0.015	(0.03)
	NPN	PNP	Pre-cabled (L = 2 m) (1)	XS208BLNBL2	0.035	(0.07)
			M8 connector	XS208BLNBM8	0.008	(0.01)
			M12 connector	XS208BLNBM12	0.015	(0.03)
Ø 12, threaded M12 x 1						
Three-wire 12–24 V $\overline{\text{---}}$, flush mountable						
2 (0.07)	NO	PNP	Pre-cabled (L = 2 m) (2)	XS112BLPAL2	0.070	(0.15)
			M12 connector	XS112BLPAM12	0.015	(0.03)
	NPN	PNP	Pre-cabled (L = 2 m) (2)	XS112BLNAL2	0.070	(0.15)
			M12 connector	XS112BLNAM12	0.015	(0.03)
	NC	PNP	Pre-cabled (L = 2 m) (2)	XS112BLPBL2	0.070	(0.15)
			M12 connector	XS112BLPBM12	0.015	(0.03)
NPN	PNP	Pre-cabled (L = 2 m) (2)	XS112BLNBL2	0.070	(0.15)	
		M12 connector	XS112BLNBM12	0.015	(0.03)	
Two-wire 24–240 V \sim, flush mountable						
2 (0.07)	NO		Pre-cabled (L = 2 m) (2)	XS112BLFAL2	0.075	(0.16)
Three-wire 12–24 V $\overline{\text{---}}$, non-flush mountable						
4 (0.15)	NO	PNP	Pre-cabled (L = 2 m) (2)	XS212BLPAL2	0.070	(0.15)
			M12 connector	XS212BLPAM12	0.015	(0.03)
	NPN	PNP	Pre-cabled (L = 2 m) (2)	XS212BLNAL2	0.070	(0.15)
			M12 connector	XS212BLNAM12	0.015	(0.03)
	NC	PNP	Pre-cabled (L = 2 m) (2)	XS212BLPBL2	0.070	(0.15)
			M12 connector	XS212BLPBM12	0.015	(0.03)
NPN	PNP	Pre-cabled (L = 2 m) (2)	XS212BLNBL2	0.070	(0.15)	
		M12 connector	XS212BLNBM12	0.015	(0.03)	

(1) For a 5 m cable replace L2 with L5.

Example: XS106BLPAL2 becomes XS106BLPAL5 with a 5 m cable.

(2) For a 5 m cable replace L2 with L5; for a 10 m cable replace L2 with L10.

Example: XS112BLPAL2 becomes XS112BLPAL5 with a 5 m cable.

OsiSense® XS Inductive proximity sensors

Basic, cylindrical, metal, flush and non-flush mountable
Two-wire, AC supply
Three-wire DC, solid-state output

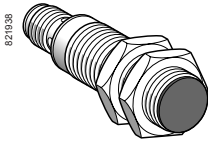

821938

XS118BL●●M12

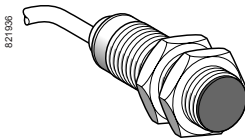

821936

XS118BL●●L2

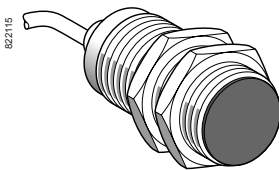

822115

XS130BL●●L2

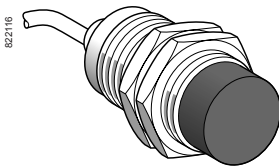

822116

XS230BL●●L2

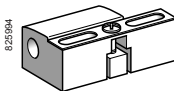

825944

XSZB1●●

2

Sensing distance Sn, mm (in.)	Function	Output	Connection	Catalog Number	Weight	
					kg	(lb)
Ø 18, threaded M18 x 1						
Three-wire 12–24 V DC, flush mountable						
5 (0.19)	NO	PNP	Pre-cabled (L = 2 m) (1)	XS118BLPAL2	0.105	(0.23)
			M12 connector	XS118BLPAM12	0.035	(0.07)
	NPN	PNP	Pre-cabled (L = 2 m) (1)	XS118BLNAL2	0.105	(0.23)
			M12 connector	XS118BLNAM12	0.035	(0.07)
	NC	PNP	Pre-cabled (L = 2 m) (1)	XS118BLPBL2	0.105	(0.23)
			M12 connector	XS118BLPBM12	0.035	(0.07)
NPN	PNP	Pre-cabled (L = 2 m) (1)	XS118BLNBL2	0.105	(0.23)	
		M12 connector	XS118BLNBM12	0.035	(0.07)	
Two-wire 24–240 V AC, flush mountable						
5 (0.19)	NO		Pre-cabled (L = 2 m) (1)	XS118BLFAL2	0.120	(0.26)
Three-wire 12–24 V DC, non-flush mountable						
8 (0.31)	NO	PNP	Pre-cabled (L = 2 m) (1)	XS218BLPAL2	0.105	(0.23)
			M12 connector	XS218BLPAM12	0.035	(0.07)
	NPN	PNP	Pre-cabled (L = 2 m) (1)	XS218BLNAL2	0.105	(0.23)
			M12 connector	XS218BLNAM12	0.035	(0.07)
	NC	PNP	Pre-cabled (L = 2 m) (1)	XS218BLPBL2	0.105	(0.23)
			M12 connector	XS218BLPBM12	0.035	(0.07)
NPN	PNP	Pre-cabled (L = 2 m) (1)	XS218BLNBL2	0.105	(0.23)	
		M12 connector	XS218BLNBM12	0.035	(0.07)	
Ø 30, threaded M30 x 1.5						
Three-wire 12–24 V DC, flush mountable						
10 (0.39)	NO	PNP	Pre-cabled (L = 2 m) (1)	XS130BLPAL2	0.165	(0.36)
			M12 connector	XS130BLPAM12	0.075	(0.16)
	NPN	PNP	Pre-cabled (L = 2 m) (1)	XS130BLNAL2	0.165	(0.36)
			M12 connector	XS130BLNAM12	0.075	(0.16)
	NC	PNP	Pre-cabled (L = 2 m) (1)	XS130BLPBL2	0.165	(0.36)
			M12 connector	XS130BLPBM12	0.075	(0.16)
NPN	PNP	Pre-cabled (L = 2 m) (1)	XS130BLNBL2	0.165	(0.36)	
		M12 connector	XS130BLNBM12	0.075	(0.16)	
Two-wire 24–240 V AC, flush mountable						
10 (0.39)	NO		Pre-cabled (L = 2 m) (1)	XS130BLFAL2	0.205	(0.45)
Three-wire 12–24 V DC, non-flush mountable						
15 (0.59)	NO	PNP	Pre-cabled (L = 2 m) (1)	XS230BLPAL2	0.155	(0.34)
			M12 connector	XS230BLPAM12	0.085	(0.18)
	NPN	PNP	Pre-cabled (L = 2 m) (1)	XS230BLNAL2	0.155	(0.34)
			M12 connector	XS230BLNAM12	0.085	(0.18)
	NC	PNP	Pre-cabled (L = 2 m) (1)	XS230BLPBL2	0.155	(0.34)
			M12 connector	XS230BLPBM12	0.085	(0.18)
NPN	PNP	Pre-cabled (L = 2 m) (1)	XS230BLNBL2	0.155	(0.34)	
		M12 connector	XS230BLNBM12	0.085	(0.18)	
Accessories						
Description			Catalog Number	Weight		
				kg	(lb)	
Mounting clamps			Ø 6.5	XSZB165	0.005	(0.01)
			Ø 8	XSZB108	0.006	(0.01)
			Ø 12	XSZB112	0.006	(0.01)
			Ø 18	XSZB118	0.010	(0.02)
			Ø 30	XSZB130	0.020	(0.04)

(1) For a 5 m cable replace L2 with L5; for a 10 m cable replace L2 with L10.
Example: XS118BLPAL2 becomes XS118BLPAL5 with a 5 m cable.

OsiSense® XS

Inductive proximity sensors

Basic, cylindrical, metal, flush and non-flush mountable
Two-wire, AC supply
Three-wire DC, solid-state output

2

Specifications						
Sensor type		XS1●●BLP●L2	XS1●●BLP●M●	XS2●●BLP●L2	XS2●●BLP●M●	XS1●●BLFAL2
Product certifications		UL, CSA, CcE				
Connection	Pre-cabled	Length 2 m	–	Length 2 m	–	Length 2 m
	Connector	–	M8 on Ø 8 M12 on Ø 8, Ø 12, Ø 18 and Ø 30	–	M8 on Ø 8 M12 on Ø 8, Ø 12, Ø 18 and Ø 30	–
Operating zone	Ø 6.5	mm	0–1.2 (0–0.04 in.)	–	–	–
	Ø 8	mm	0–1.2 (0–0.04 in.)	0–2 (0–0.07 in.)	–	–
	Ø 12	mm	0–1.6 (0–0.06 in.)	0–3.2 (0–0.12 in.)	–	0–1.6 (0–0.06 in.)
	Ø 18	mm	0–4 (0–0.15 in.)	0–6.4 (0–0.25 in.)	–	0–4 (0–0.15 in.)
	Ø 30	mm	0–8 (0–0.31 in.)	0–12 (0–0.47 in.)	–	0–8 (0–0.31 in.)
Differential travel		%	1–15 of real sensing distance (Sr)			
Degree of protection	Conforming to IEC 60529		IP 67			
Storage temperature		°C	– 40 to + 85 (–40 to +185 °F)			
Operating temperature		°C	– 25 to + 70 (–13 to +158 °F)			
Materials	Case		Nickel-plated brass			
	Cable		PVC 3 x 0.34 mm ² (22 AWG) except Ø 6.5 and 8: 3 x 0.11 mm ² (27 AWG)	–	PVC 3 x 0.34 mm ² (22 AWG) except Ø 6.5 and 8: 3 x 0.11 mm ² (27 AWG)	PVC 2 x 0.34 mm ² (22 AWG)
Vibration resistance	Conforming to IEC 60068-2-6		25 gn, amplitude ± 2 mm (f = 10 to 55 Hz)			
Shock resistance	Conforming to IEC 60068-2-27		50 gn, duration 11 ms			
Output state indication			Yellow LED, on rear	Yellow LED: 4 viewing ports at 90°	Yellow LED, on rear	Yellow LED: 4 viewing ports at 90°
Rated supply voltage		V	~ 12–24 with protection against reverse polarity			~ 24–240
Voltage limits (including ripple)		V	~ 10–36			~ 20–264
Switching capacity		mA	≤ 100 (except Ø 6.5 and 8: ≤ 50) with overload and short-circuit protection			5–300 (5–200 for Ø 12) (1)
Voltage drop, closed state		V	≤ 2			≤ 4.5 (≤ 7 for Ø 12)
Current consumption, no-load		mA	≤ 10			–
Residual current, open state		mA	–			≤ 1.5
Maximum switching frequency	Ø 6.5, Ø 8	Hz	3000			–
	Ø 12	Hz	2000		1000	25
	Ø 18	Hz	2000		250	25
	Ø 30	Hz	200		60	25
Delays	First-up	ms	≤ 5 (except Ø 30 ≤ 10)			≤ 40
	Response	ms	≤ 0.5 for Ø 8, Ø 12, ≤ 1 for Ø 18, ≤ 2 for Ø 30			≤ 10
	Recovery	ms	≤ 1 for Ø 8, ≤ 0.5 for Ø 12, ≤ 2 for Ø 18, ≤ 6 for Ø 30			≤ 15

(1) These sensors do not incorporate overload or short-circuit protection. A 0.4 A fast-acting fuse must be connected in series with the load.

Wiring diagrams

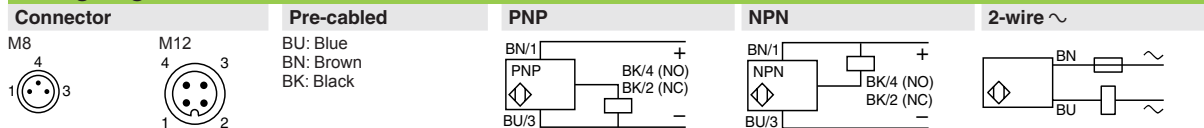

OsiSense® XS Inductive proximity sensors

Basic, cylindrical, metal, flush and non-flush mountable
Two-wire, AC supply
Three-wire DC, solid-state output

Setup

Minimum mounting distances (mm)

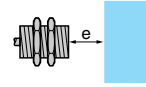
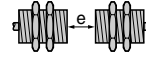
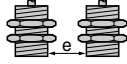

Sensors		Side by side	Face to face	Facing a metal object	Mounted in a metal support
Ø 6.5 flush mountable	XS106	$e \geq 3$	$e \geq 18$	$e \geq 4.5$	$d \geq 6.5$ $h \geq 0$
Ø 8 flush mountable	XS108	$e \geq 3$	$e \geq 18$	$e \geq 4.5$	$d \geq 8$ $h \geq 0$
Ø 8 non-flush mountable	XS208	$e \geq 10$	$e \geq 30$	$e \geq 7.5$	$d \geq 24$ $h \geq 5$
Ø 12 flush mountable	XS112	$e \geq 4$	$e \geq 24$	$e \geq 6$	$d \geq 12$ $h \geq 0$
Ø 12 non-flush mountable	XS212	$e \geq 16$	$e \geq 48$	$e \geq 12$	$d \geq 36$ $h \geq 8$
Ø 18 flush mountable	XS118	$e \geq 10$	$e \geq 60$	$e \geq 15$	$d \geq 18$ $h \geq 0$
Ø 18 non-flush mountable	XS218	$e \geq 16$	$e \geq 96$	$e \geq 24$	$d \geq 54$ $h \geq 16$
Ø 30 flush mountable	XS130	$e \geq 20$	$e \geq 120$	$e \geq 30$	$d \geq 30$ $h \geq 0$
Ø 30 non-flush mountable	XS230	$e \geq 60$	$e \geq 180$	$e \geq 45$	$d \geq 90$ $h \geq 30$

2

Dimensions (mm)

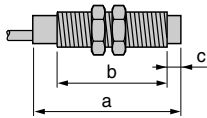

Flush mountable in metal

Sensors		Pre-cabled (mm)		M8 connector (mm)		M12 connector (mm)	
		a	b	a	b	a	b
Ø 6.5	XS106	42	–	–	–	–	–
Ø 8	XS108	42	39.4	52.2	41.3	61.4	39
Ø 12	XS112	41.3	38.7	–	–	53	39
Ø 18	XS118	51.3	48.4	–	–	64	48.5
Ø 30	XS130	51.3	48.4	–	–	64	48.5

Non-flush mountable in metal

Sensors		Pre-cabled (mm)		M8 connector (mm)			M12 connector (mm)		
		a	b	a	b	c	a	b	c
Ø 8	XS208	42	35.8	52.2	37.7	4	61.4	35.4	4
Ø 12	XS212	41.3	34.1	–	–	–	52.6	34	5
Ø 18	XS218	50.6	40.4	–	–	–	63.4	40.5	8
Ø 30	XS230	50.6	35.4	–	–	–	63.4	35.5	13

OsiSense® XS

Inductive proximity sensors

Basic, plastic, cylindrical, non-flush mountable
Three-wire DC, solid-state output

2

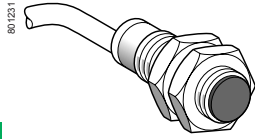

XS2●●AL●●L2



XS2●●AL●●M12

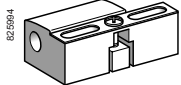

XSZB1●●

Sensing distance Sn, mm (in.)	Function	Output	Connection	Catalog Number	Weight	
					kg	(lb)
Ø 8, threaded M8 x 1						
Three-wire 12–24 V DC, non-flush mountable						
2.5 (0.09)	NO	PNP	Pre-cabled (L = 2 m) (1)	XS208ALPAL2	0.030	(0.06)
		NPN	Pre-cabled (L = 2 m) (1)	XS208ALNAL2	0.030	(0.06)
	NC	PNP	Pre-cabled (L = 2 m) (1)	XS208ALPBL2	0.003	(0.06)
		NPN	Pre-cabled (L = 2 m) (1)	XS208ALNBL2	0.030	(0.06)
Ø 12, threaded M12 x 1						
Three-wire 12–24 V DC, non-flush mountable						
4 (0.15)	NO	PNP	Pre-cabled (L = 2 m) (2)	XS212ALPAL2	0.065	(0.14)
			M12 connector	XS212ALPAM12	0.010	(0.02)
		NPN	Pre-cabled (L = 2 m) (2)	XS212ALNAL2	0.065	(0.14)
			M12 connector	XS212ALNAM12	0.010	(0.02)
	NC	PNP	Pre-cabled (L = 2 m) (2)	XS212ALPBL2	0.065	(0.14)
			M12 connector	XS212ALPBM12	0.010	(0.02)
		NPN	Pre-cabled (L = 2 m) (2)	XS212ALNBL2	0.065	(0.14)
			M12 connector	XS212ALNBM12	0.010	(0.02)
Ø 18, threaded M18 x 1						
Three-wire 12–24 V DC, non-flush mountable						
8 (0.31)	NO	PNP	Pre-cabled (L = 2 m) (2)	XS218ALPAL2	0.095	(0.20)
			M12 connector	XS218ALPAM12	0.025	(0.05)
		NPN	Pre-cabled (L = 2 m) (2)	XS218ALNAL2	0.095	(0.20)
			M12 connector	XS218ALNAM12	0.025	(0.05)
	NC	PNP	Pre-cabled (L = 2 m) (2)	XS218ALPBL2	0.095	(0.20)
			M12 connector	XS218ALPBM12	0.025	(0.05)
		NPN	Pre-cabled (L = 2 m) (2)	XS218ALNBL2	0.095	(0.20)
			M12 connector	XS218ALNBM12	0.025	(0.05)
Ø 30, threaded M30 x 1.5						
Three-wire 12–24 V DC, non-flush mountable						
15 (0.59)	NO	PNP	Pre-cabled (L = 2 m) (2)	XS230ALPAL2	0.135	(0.29)
			M12 connector	XS230ALPAM12	0.065	(0.14)
		NPN	Pre-cabled (L = 2 m) (2)	XS230ALNAL2	0.135	(0.29)
			M12 connector	XS230ALNAM12	0.065	(0.14)
	NC	PNP	Pre-cabled (L = 2 m) (2)	XS230ALPBL2	0.135	(0.29)
			M12 connector	XS230ALPBM12	0.065	(0.14)
		NPN	Pre-cabled (L = 2 m) (2)	XS230ALNBL2	0.135	(0.29)
			M12 connector	XS230ALNBM12	0.065	(0.14)
Accessories						
Description				Catalog Number	Weight	
					kg	(lb)
Mounting clamps			Ø 8	XSZB108	0.006	(0.01)
			Ø 12	XSZB112	0.006	(0.01)
			Ø 18	XSZB118	0.010	(0.02)
			Ø 30	XSZB130	0.020	(0.04)

(1) For a 5 m cable replace L2 with L5.
Example: XS208ALPAL2 becomes XS208ALPAL5 with a 5 m cable.
(2) For a 5 m cable replace L2 with L5; for a 10 m cable replace L2 by L10.
Example: XS218ALPAL2 becomes XS218ALPAL5 with a 5 m cable.

OsiSense® XS

Inductive proximity sensors

Basic, plastic, cylindrical, non-flush mountable
Three-wire DC, solid-state output

2

Specifications			
Sensor type		XS2●●ALP●L2 XS2●●ALN●L2	XS2●●ALP●M12 XS2●●ALN●M12
Product certifications		UL, CSA, CE	
Connection	Pre-cabled	Length: 2 m	–
	Connector	–	M12
Operating zone	Ø 8	mm 0–2 (0–0.07 in.)	
	Ø 12	mm 0–3.2 (0–0.12 in.)	
	Ø 18	mm 0–6.4 (0–0.25 in.)	
	Ø 30	mm 0–12 (0–0.47 in.)	
Differential travel		% 1–15 of real sensing distance (Sr)	
Degree of protection	Conforming to IEC 60529	IP 67	
Storage temperature		°C –40 to +85 (–40 to +185 °F)	
Operating temperature		°C –25 to +70 (–13 to +158 °F)	
Materials	Case	PPS	
	Cable	PVC 3 x 0.34 mm ² (22 AWG) except Ø 8: 3 x 0.11 mm ² (27 AWG)	–
Vibration resistance	Conforming to IEC 60068-2-6	25 gn, amplitude ± 2 mm (f = 10 to 55 Hz)	
Shock resistance	Conforming to IEC 60068-2-27	50 gn, duration 11 ms	
Output state indication		Yellow LED, on rear	Yellow LED: 4 viewing ports at 90°
Rated supply voltage		V --- 12–24 with protection against reverse polarity	
Voltage limits (including ripple)		V --- 10–36	
Switching capacity		mA ≤ 100 (except Ø 8: ≤ 50) with overload and short-circuit protection	
Voltage drop, closed state		V ≤ 2	
Current consumption, no-load		mA ≤ 10	
Maximum switching frequency	Ø 8	Hz 3000	
	Ø 12	Hz 1000	
	Ø 18	Hz 250	
	Ø 30	Hz 60	
Delays	First-up	ms ≤ 5 (except Ø 30: ≤ 10)	
	Response	ms ≤ 0.5 for Ø 8, Ø 12, ≤ 1 for Ø 18, ≤ 2 for Ø 30	
	Recovery	ms ≤ 1 for Ø 8, ≤ 0.5 for Ø 12, ≤ 2 for Ø 18, ≤ 6 for Ø 30	

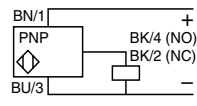
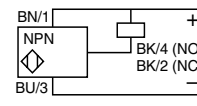
Wiring diagrams			
Connector	Pre-cabled	PNP	NPN
M12 	BU: Blue BN: Brown BK: Black		

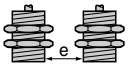
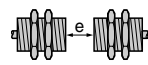
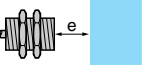
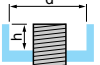
Setup				
Minimum mounting distances (mm)				
				
Sensors	Side by side	Face to face	Facing a metal object	Mounted in a metal support
Ø 8 XS208AL	e > 10	e > 30	e > 7.5	d > 24 h > 5
Ø 12 XS212AL	e > 16	e > 48	e > 12	d > 36 h > 8
Ø 18 XS218AL	e > 16	e > 96	e > 24	d > 54 h > 16
Ø 30 XS230AL	e > 60	e > 180	e > 45	d > 90 h > 30

Dimensions (mm)					
Sensors		Non-flush mountable in metal			
		Pre-cabled (mm)		Connector (mm)	
		a	b	a	b
Ø 8	XS208AL	49	40	–	–
Ø 12	XS212AL	49	42	61	42
Ø 18	XS218AL	58.8	51.5	70.3	51.5
Ø 30	XS230AL	58.8	51.5	70.3	51.5

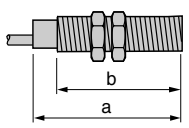

OsiSense® XS

Inductive proximity sensors

General purpose

Plastic, cylindrical, non-flush mountable

Two-wire AC or DC

Three-wire DC, solid-state output

Sensing dist. Sn, mm (in.)	Function	Output	Connection	Catalog Number	Weight kg (lb)
Ø 8, threaded M8 x 1					
Three-wire --- 12-24 V					
2.5 (0.10)	NO	PNP	Pre-cabled (L = 2 m) (1) (2)	XS4P08PA340	0.025 (0.06)
		NPN	Pre-cabled (L = 2 m) (1) (2)	XS4P08NA340	0.025 (0.06)
	NC	PNP	Pre-cabled (L = 2 m) (1) (2)	XS4P08PB340	0.025 (0.06)
		NPN	Pre-cabled (L = 2 m) (1) (2)	XS4P08NB340	0.025 (0.06)
Three-wire --- 12-48 V					
2.5 (0.10)	NO	PNP	Pre-cabled (L = 2 m) (1)	XS4P08PA370	0.030 (0.07)
		NPN	Pre-cabled (L = 2 m)	XS4P08NA370	0.030 (0.07)
	NC	PNP	Pre-cabled (L = 2 m)	XS4P08PB370	0.030 (0.07)
		NPN	Pre-cabled (L = 2 m)	XS4P08NB370	0.030 (0.07)
Two-wire ~ or --- 24-240 V					
2.5 (0.10)	NO		Pre-cabled (L = 2 m) (1)	XS4P08MA230	0.030 (0.07)
			1/2"-20UNF connector	XS4P08MA230K	0.020 (0.04)
	NC		Pre-cabled (L = 2 m) (1)	XS4P08MB230	0.030 (0.07)
			1/2"-20UNF connector	XS4P08MB230K	0.020 (0.04)
Ø 12, threaded M12 x 1					
Three-wire --- 12-24 V					
4 (0.16)	NO	PNP	Pre-cabled (L = 2 m) (1) (3)	XS4P12PA340	0.060 (0.13)
		NPN	Pre-cabled (L = 2 m) (1) (3)	XS4P12NA340	0.060 (0.13)
	NC	PNP	Pre-cabled (L = 2 m) (1) (3)	XS4P12PB340	0.060 (0.13)
		NPN	Pre-cabled (L = 2 m) (1) (3)	XS4P12NB340	0.060 (0.13)
Three-wire --- 12-48 V					
4 (0.16)	NO	PNP	Pre-cabled (L = 2 m) (1) (3)	XS4P12PA370	0.065 (0.14)
		NPN	Pre-cabled (L = 2 m) (1) (3)	XS4P12NA370	0.065 (0.14)
	NC	PNP	Pre-cabled (L = 2 m) (1) (3)	XS4P12PB370	0.065 (0.14)
		NPN	Pre-cabled (L = 2 m) (3)	XS4P12NB370	0.065 (0.14)
Two-wire ~ or --- 24-240 V					
4 (0.16)	NO		Pre-cabled (L = 2 m) (1)	XS4P12MA230	0.065 (0.14)
			1/2"-20UNF connector	XS4P12MA230K	0.030 (0.07)
	NC		Pre-cabled (L = 2 m) (1)	XS4P12MB230	0.065 (0.14)
			1/2"-20UNF connector	XS4P12MB230K	0.030 (0.07)
Ø 18, threaded M18 x 1					
Three-wire --- 12-24 V					
8 (0.31)	NO	PNP	Pre-cabled (L = 2 m) (1) (3)	XS4P18PA340	0.090 (0.20)
		NPN	Pre-cabled (L = 2 m) (1) (3)	XS4P18NA340	0.090 (0.20)
	NC	PNP	Pre-cabled (L = 2 m) (1) (3)	XS4P18PB340	0.090 (0.20)
		NPN	Pre-cabled (L = 2 m) (1) (3)	XS4P18NB340	0.090 (0.20)
Three-wire --- 12-48 V					
8 (0.31)	NO	PNP	Pre-cabled (L = 2 m) (1) (3)	XS4P18PA370	0.100 (0.22)
		NPN	Pre-cabled (L = 2 m) (1) (3)	XS4P18NA370	0.100 (0.22)
	NC	PNP	Pre-cabled (L = 2 m) (1) (3)	XS4P18PB370	0.100 (0.22)
		NPN	Pre-cabled (L = 2 m) (3)	XS4P18NB370	0.100 (0.22)
Two-wire ~ or --- 24-240 V					
8 (0.31)	NO		Pre-cabled (L = 2 m) (1)	XS4P18MA230	0.100 (0.22)
			1/2"-20UNF connector	XS4P18MA230K	0.040 (0.88)
	NC		Pre-cabled (L = 2 m) (1)	XS4P18MB230	0.100 (0.22)
			1/2"-20UNF connector	XS4P18MB230K	0.040 (0.88)
Ø 30, threaded M30 x 1.5					
Three-wire --- 12-24 V					
15 (0.59)	NO	PNP	Pre-cabled (L = 2 m) (1) (3)	XS4P30PA340	0.120 (0.26)
		NPN	Pre-cabled (L = 2 m) (1) (3)	XS4P30NA340	0.120 (0.26)
	NC	PNP	Pre-cabled (L = 2 m) (1) (3)	XS4P30PB340	0.120 (0.26)
		NPN	Pre-cabled (L = 2 m) (1) (3)	XS4P30NB340	0.120 (0.26)
Three-wire --- 12-48 V					
15 (0.59)	NO	PNP	Pre-cabled (L = 2 m) (1) (3)	XS4P30PA370	0.140 (0.31)
		NPN	Pre-cabled (L = 2 m) (1) (3)	XS4P30NA370	0.140 (0.31)
	NC	PNP	Pre-cabled (L = 2 m) (3)	XS4P30PB370	0.140 (0.31)
		NPN	Pre-cabled (L = 2 m) (3)	XS4P30NB370	0.140 (0.31)
Two-wire ~ or ---					
15 (0.59)	NO		Pre-cabled (L = 2 m) (1)	XS4P30MA230	0.140 (0.31)
			1/2"-20UNF connector	XS4P30MA230K	0.080 (0.18)
	NC		Pre-cabled (L = 2 m) (1)	XS4P30MB230	0.140 (0.31)
			1/2"-20UNF connector	XS4P30MB230K	0.080 (0.18)

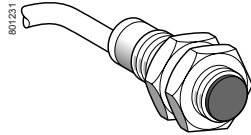

XS4P●●●●340
XS4P●●●●370
XS4P●●●●230

2



XS4P●●●●340D
XS4P●●●●370D
XS4P●●●●230K

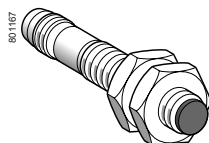

XS4P08●●340S

(1) For a 5 m cable add L1 to the catalog number; for a 10 m cable add L2. Example: XS4P08PA340 becomes XS4P08PA340L1 with a 5 m cable.

(2) For an M8 connector, add S to the catalog number. Example: XS4P08PA340 becomes XS4P08PA340S with an M8 connector.

(3) For an M12 connector, add D to the catalog number. Example: XS4P12PA370 becomes XS4P12PA370D with an M12 connector.

Specifications,
Wiring Diagrams,
Setup,
dimensions

OsiSense® XS

Inductive proximity sensors

General purpose
Plastic, cylindrical, non-flush mountable
Two-wire AC or DC
Three-wire DC, solid-state output

2

Specifications		XS4P●●●●340p	XS4P●●●●370●	XS4P●●●●230●
Sensor type		UL, CSA, CE		
Product certifications		Length: 2 m		
Connection		Pre-cabled		1/2"-20UNF
Connector		M8 on Ø 8 M12 on Ø 12, Ø 18 and Ø 30		
Operating zone		Ø 6.5 and Ø 8	mm 0-2 (0-0.08 in.)	
		Ø 12	mm 0-3.2 (0-0.13 in.)	
		Ø 18	mm 0-6.4 (0-0.25 in.)	
		Ø 30	mm 0-12 (0-0.47 in.)	
Differential travel		% 1-15 of effective sensing distance (Sr)		
Degree of protection		Conforming to IEC 60529 IP 68, double insulation for pre-cabled version (except Ø 8: IP 67) IP 67 for connector version		
Storage temperature		°C -40 to +85 (-40 to +185 °F)		
Operating temperature		°C -25 to +70 (-13 to +158 °F)		
Materials		Case	PPS	
		Cable	PvR 3 x 0.34 mm ² (24 AWG) except Ø 6.5 and 8: 3 x 0.11 mm ² (26 AWG) PvR 2 x 0.34 mm ² (24 AWG) except Ø 8: 2 x 0.11 mm ² (26 AWG)	
Vibration resistance		Conforming to IEC 60068-2-6 25 gn, amplitude ± 2 mm (f = 10 to 55 Hz)		
Shock resistance		Conforming to IEC 60068-2-27 50 gn, duration 11 ms		
Output state indication		Yellow LED: annular on pre-cabled version Yellow LED: 4 viewing ports at 90° on connector version		
Rated supply voltage		V	~ 12-24 with protection against reverse polarity	~ 12-48 with protection against reverse polarity ~ or ~ 24-240 (50/60 Hz)
Voltage limits (including ripple)		V	~ 10-36	~ 10-58 ~ or ~ 20-264
Switching capacity		mA	≤ 200 with overload and short-circuit protection 5-100 for Ø 8, 5-200 for Ø 12, 5-200 ~ and 5-300 ~ for Ø 18 and 30	
Voltage drop, closed state		V	≤ 2 ≤ 5.5	
Residual current, open state		mA	-	
Current consumption, no-load		mA	≤ 10 -	
Maximum switching frequency		Hz	Ø 6.5, Ø 8 and Ø 12: 5000 Ø 18: 2000 Ø 30: 1000	~ 3000, ~ 25 ~ 2000, ~ 25 ~ 1000, ~ 25
Delays		ms	First-up: ≤ 10 Response: ≤ 0.1 for Ø 8 and Ø 12, ≤ 0.15 for Ø 18, ≤ 0.3 for Ø 30 Recovery: ≤ 0.1 for Ø 8 and Ø 12, ≤ 0.35 for Ø 18, ≤ 0.7 for Ø 30	≤ 40 ≤ 0.2 ≤ 0.2 for Ø 8, Ø 12 and Ø 18, ≤ 0.4 for Ø 30

Wiring diagrams

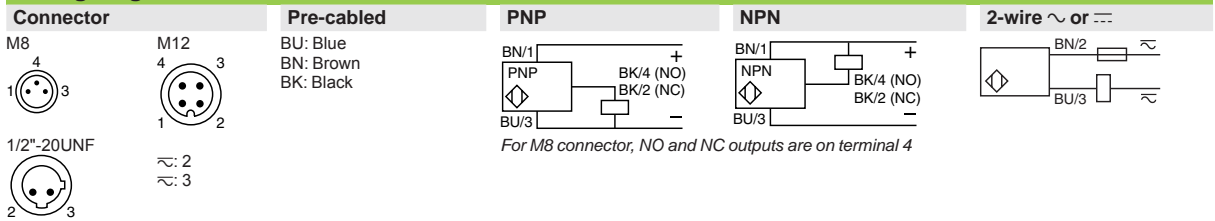

Setup

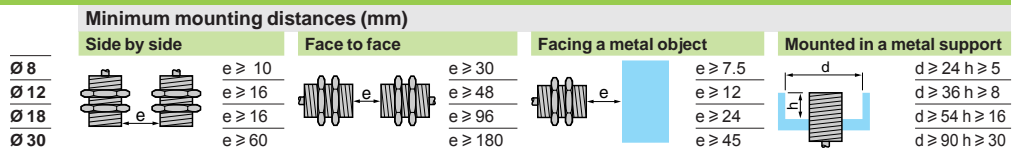

Dimensions (mm)

XS4P	3-wire ~ 12-24 V				3-wire ~ 12-48 V or 2-wire ~/~ 24-240 V			
	Pre-cabled (mm)		Connector (mm)		Pre-cabled (mm)		Connector (mm)	
	a	b	a	b	a	b	a	b
Ø 8	33	26	42	26	50	40	61	40
Ø 12	35	24.6	48	27	52	41.6	61	42
Ø 18	35.3	24.6	48	29	61.8	51.1	70	51.5
Ø 30	42.3	31.6	50	34	61.8	51.1	70	51.5

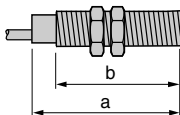

OsiSense® XS

Inductive proximity sensors

General purpose

Miniature, cylindrical, flush and non-flush mountable
Three-wire DC, solid-state output

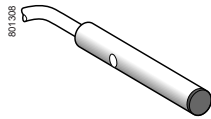

XS1L04●●310

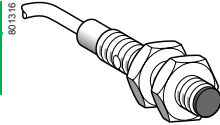

XS1N05●●310

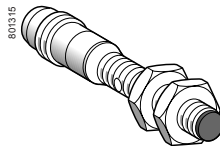

XS1N05●●311S

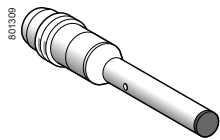

XS1L04●●310S

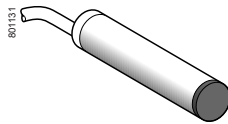

XS●L06●●340

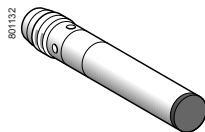

XS●L06●●340S
XS●L06●●349S

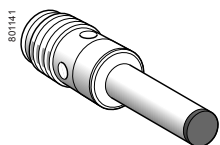

XS●L06●●340D

Ø 4 plain

Sensing distance Sn, mm (in.)	Function	Output	Connection (1)	Catalog Number	Weight kg (lb)
----------------------------------	----------	--------	-------------------	----------------	-------------------

Brass case, flush mountable

1 (0.04)	NO	PNP	Pre-cabled (L = 2 m)	XS1L04PA310	0.025 (0.06)
			M8 connector	XS1L04PA310S	0.010 (0.02)
	NC	NPN	Pre-cabled (L = 2 m)	XS1L04NA310	0.025 (0.06)
			M8 connector	XS1L04NA310S	0.010 (0.02)
	NC	PNP	Pre-cabled (L = 2 m)	XS1L04PB310	0.025 (0.06)
			M8 connector	XS1L04PB310S	0.010 (0.02)
NC	NPN	Pre-cabled (L = 2 m)	XS1L04NB310	0.025 (0.06)	
		M8 connector	XS1L04NB310S	0.010 (0.02)	

Stainless steel case, flush mountable

0.8 (0.03)	NO	PNP	Pre-cabled (L = 2 m)	XS1L04PA311	0.025 (0.06)
			M8 connector	XS1L04PA311S	0.010 (0.02)
	NC	NPN	Pre-cabled (L = 2 m)	XS1L04NA311	0.025 (0.06)
			M8 connector	XS1L04NA311S	0.010 (0.02)
	NC	PNP	Pre-cabled (L = 2 m)	XS1L04PB311	0.025 (0.06)
			M8 connector	XS1L04PB311S	0.010 (0.02)
NC	NPN	Pre-cabled (L = 2 m)	XS1L04NB311	0.025 (0.06)	
		M8 connector	XS1L04NB311S	0.010 (0.02)	

Ø 5, threaded M5 x 0.5

Sensing distance Sn, mm (in.)	Function	Output	Connection (1)	Catalog Number	Weight kg (lb)
----------------------------------	----------	--------	-------------------	----------------	-------------------

Brass case, flush mountable

1 (0.04)	NO	PNP	Pre-cabled (L = 2 m)	XS1N05PA310	0.030 (0.07)
			M8 connector	XS1N05PA310S	0.030 (0.07)
	NC	NPN	Pre-cabled (L = 2 m)	XS1N05PB310	0.030 (0.07)
			M8 connector	XS1N05NB310	0.030 (0.07)

Stainless steel case, flush mountable

0.8 (0.03)	NO	PNP	Pre-cabled (L = 2 m)	XS1N05PA311	0.030 (0.07)
			M8 connector	XS1N05PA311S	0.015 (0.03)
	NC	NPN	Pre-cabled (L = 2 m)	XS1N05NA311	0.030 (0.07)
			M8 connector	XS1N05NA311S	0.015 (0.03)
	NC	PNP	Pre-cabled (L = 2 m)	XS1N05PB311	0.030 (0.07)
			M8 connector	XS1N05PB311S	0.015 (0.03)
NC	NPN	Pre-cabled (L = 2 m)	XS1N05NB311	0.030 (0.07)	
		M8 connector	XS1N05NB311S	0.015 (0.03)	

Ø 6.5 plain

Sensing distance Sn, mm (in.)	Function	Output	Connection (1)	Catalog Number	Weight kg (lb)
----------------------------------	----------	--------	-------------------	----------------	-------------------

Stainless steel case, non-flush mountable

2.5 (0.10)	NO	PNP	Pre-cabled (L = 2 m)	XS2L06PA340	0.025 (0.06)
			M8 connector	XS2L06PA340S	0.010 (0.02)
			M12 connector	XS2L06PA340D	0.015 (0.03)
		NPN	Pre-cabled (L = 2 m)	XS2L06NA340	0.025 (0.06)
			M8 connector	XS2L06NA340S	0.010 (0.02)
			M12 connector	XS2L06NA340D	0.015 (0.03)
	NC	PNP	Pre-cabled (L = 2 m)	XS2L06PB340	0.025 (0.06)
			M8 connector	XS2L06PB340S	0.010 (0.02)
			M12 connector	XS2L06PB340D	0.015 (0.03)
		NPN	Pre-cabled (L = 2 m)	XS2L06NB340	0.025 (0.06)
			M8 connector	XS2L06NB340S	0.010 (0.02)
			M12 connector	XS2L06NB340D	0.015 (0.03)

(1) For a 5 m cable add L1 to the catalog number; for a 10 m cable add L2. Example:
XS1L04PA310 becomes XS1L04PA310L1 with a 5 m cable.

OsiSense® XS

Inductive proximity sensors

General purpose

Miniature, cylindrical, flush and non-flush mountable
Three-wire DC, solid-state output

2

Specifications		
Sensor type		XS1●●●●●●●●S; XS1●●●●●●●●D; XS2L06●A340● XS1●●●●●●●●; XS2L06●A340●
Product certifications		UL, CSA, CE
Connection (1)	Connector	M8 on XS1●●●●●●●●S and M12 on XS1●●●●●●●●D
	Pre-cabled	– Length: 2 m
Operating zone	Ø 4	mm (in.) 0–0.8 (0–0.03) (brass) 0–0.6 (0–0.02) (stainless steel)
	Ø 5	mm (in.) 0–0.8 (0–0.03) (brass), 0–0.6 (0–0.02) (stainless steel)
	Ø 6.5 non-flush mountable	mm (in.) 0–2 (0.08) (stainless steel)
Degree of protection	Conforming to IEC 60529	IP 67
Storage temperature		°C (°F) -40 to +85 (-40 to +185)
Operating temperature		°C (°F) -25 to +70 (-13 to +158)
Materials	Case	Nickel-plated brass or stainless steel, grade 303
	Cable	PvR 3 x 0.11 mm ² (26 AWG) or 4 x 0.08 mm ² (20 AWG)
Vibration resistance	Conforming to IEC 60068-2-6	25 gn, amplitude ± 2 mm (f = 10 to 55 Hz)
Shock resistance	Conforming to IEC 60068-2-27	50 gn, duration 11 ms
Output state indication		Yellow LED, 4 viewing ports at 90° Yellow LED, annular
Rated supply voltage		V ⋯ 5–24 for XS1L04●●●●●●●● and XS1N05●●●●●●●● ⋯ 12–24 for XS●L06●●●●●●●●
Voltage limits (including ripple)		V ⋯ 5–30 for XS1L04●●●●●●●● and XS1N05●●●●●●●● ⋯ 10–38 for XS●L06●●●●●●●●
Current consumption, no-load		mA ≤ 10
Switching capacity	3-wire PNP/NPN	mA ≤ 100 with overload and short-circuit protection ≤ 200 for XS●L06 with overload and short-circuit protection
Voltage drop, closed state		V ≤ 2
Maximum switching frequency		kHz 5
Delays	First-up	ms ≤ 5
	Response	ms ≤ 0.1
	Recovery	ms ≤ 0.1

(1) Detection curves, see page 2/135.

Wiring diagrams

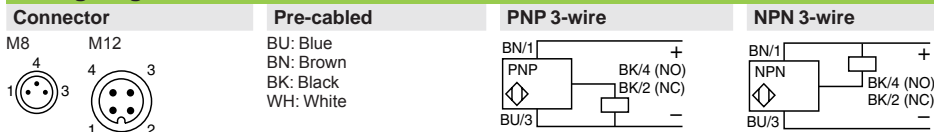

For M8 connector, NO and NC outputs are on terminal 4.

Setup

Minimum mounting distances (mm)

Sensor	Side by side	Face to face	Facing a metal object
Ø 4	e ≥ 2	e ≥ 12	e ≥ 3
Ø 5	e ≥ 2	e ≥ 12	e ≥ 3
Ø 6.5	e ≥ 3	e ≥ 18	e ≥ 4.5
Ø 6.5, XS2L06●A340●	e ≥ 5	e ≥ 30	e ≥ 7.5

For facing a metal object: d1 ≥ 4, h ≥ 0 –
d1 ≥ 5, h ≥ 0 –
d1 ≥ 3, h ≥ 0 –
d1 ≥ 10, h ≥ 1.6 d2 ≥ 6.5, x ≥ 1.3

Tightening torque

Stainless steel: 2.2 N•m (19.47 lb-in)
Brass: 1.6 N•m (14.16 lb-in)

Dimensions (mm)

Sensor	Pre-cabled			M8 connector			M12 connector		
	a	b	c	a	b	c	a	b	c
Ø 4	29	29	–	41	24	–	–	–	–
Ø 5	29	29	–	41	24	–	–	–	–
Ø 6.5	33	30	–	42	34	–	45	24	–
Ø 6.5, XS2L06●A340●	33	27	3	46	35	3	49	25	3

OsiSense® XS

Inductive proximity sensors

General purpose

Cylindrical, increased range, flush mountable

Two-wire DC, solid-state output

Sensors, 2-wire 12-24 V DC, short case model

Sensing dist. Sn, mm (in.)	Function	Connection	Catalog Number	Weight kg (lb)
Ø 6.5, plain				
2.5 (0.10)	NO	Pre-cabled (L = 2 m) (1)	XS606B3CAL2	0.060 (0.13)
		Remote M12 connector	XS606B3CAL01M12	0.070 (0.15)
	NC	Pre-cabled (L = 2 m) (1)	XS606B3CBL2	0.060 (0.13)
Ø 8, threaded M8 x 1				
2.5 (0.10)	NO	Pre-cabled (L = 2 m) (1)	XS608B3CAL2	0.070 (0.15)
		Remote M12 connector	XS608B3CAL01M12	0.070 (0.15)
	NC	Pre-cabled (L = 2 m) (1)	XS608B3CBL2	0.070 (0.15)
		Remote M12 connector	XS608B3CBL01M12	0.070 (0.15)
Ø 12, threaded M12 x 1				
4 (0.16)	NO	Pre-cabled (L = 2 m) (1)	XS612B3DAL2	0.090 (0.20)
		M12 connector	XS612B3DAM12	0.030 (0.07)
	NC	Pre-cabled (L = 2 m) (1)	XS612B3DBL2	0.090 (0.20)
		M12 connector	XS612B3DBM12	0.030 (0.07)
Ø 18, threaded M18 x 1				
8 (0.31)	NO	Pre-cabled (L = 2 m) (1)	XS618B3DAL2	0.110 (0.24)
		M12 connector	XS618B3DAM12	0.060 (0.13)
	NC	Pre-cabled (L = 2 m) (1)	XS618B3DBL2	0.110 (0.24)
		M12 connector	XS618B3DBM12	0.060 (0.13)
Ø 30, threaded M30 x 1.5				
15 (0.59)	NO	Pre-cabled (L = 2 m) (1)	XS630B3DAL2	0.180 (0.40)
		M12 connector	XS630B3DAM12	0.130 (0.29)
	NC	Pre-cabled (L = 2 m) (1)	XS630B3DBL2	0.180 (0.40)
		M12 connector	XS630B3DBM12	0.180 (0.40)

Sensors, 2-wire 12-48 V DC, long case model

Sensing dist. Sn, mm (in.)	Function	Connection	Catalog Number	Weight kg (lb)
Ø 6.5, plain				
2.5 (0.10)	NO	Pre-cabled (L = 2 m) (1)	XS606B1DAL2	0.060 (0.13)
	NC	Pre-cabled (L = 2 m) (1)	XS606B1DBL2	0.060 (0.13)
Ø 8, threaded M8 x 1				
2.5 (0.10)	NO	Pre-cabled (L = 2 m) (1)	XS608B1DAL2	0.035 (0.08)
		M12 connector	XS608B1DAM12	0.015 (0.03)
	NC	Pre-cabled (L = 2 m) (1)	XS608B1DBL2	0.035 (0.08)
		M12 connector	XS608B1DBM12	0.015 (0.03)
Ø 12, threaded M12 x 1				
4 (0.16)	NO	Pre-cabled (L = 2 m) (1)	XS612B1DAL2	0.180 (0.40)
		M12 connector	XS612B1DAM12	0.020 (0.44)
	NC	Pre-cabled (L = 2 m) (1)	XS612B1DBL2	0.075 (0.17)
		M12 connector	XS612B1DBM12	0.020 (0.44)
Ø 18, threaded M18 x 1				
8 (0.31)	NO	Pre-cabled (L = 2 m) (1)	XS618B1DAL2	0.100 (0.22)
		M12 connector	XS618B1DAM12	0.040 (0.09)
	NC	Pre-cabled (L = 2 m) (1)	XS618B1DBL2	0.100 (0.22)
		M12 connector	XS618B1DBM12	0.040 (0.09)
Ø 30, threaded M30 x 1.5				
15 (0.59)	NO	Pre-cabled (L = 2 m) (1)	XS630B1DAL2	0.205 (0.45)
		M12 connector	XS630B1DAM12	0.145 (0.32)
	NC	Pre-cabled (L = 2 m) (1)	XS630B1DBL2	0.205 (0.45)
		M12 connector	XS630B1DBM12	0.145 (0.32)

Accessories

Description	For use with sensors	Catalog Number	Weight kg (lb)
Mounting clamps	Ø 6.5 (plain)	XSZB165	0.005 (0.01)
	Ø 8 (M8 x 1)	XSZB108	0.006 (0.01)
	Ø 12 (M12 x 1)	XSZB112	0.006 (0.01)
	Ø 18 (M18 x 1)	XSZB118	0.010 (0.02)
	Ø 30 (M30 x 1.5)	XSZB130	0.020 (0.04)

(1) For a 5 m cable replace L2 with L5.

Example: XS606B3CAL2 becomes **XS606B3CAL5** with a 5 m cable.

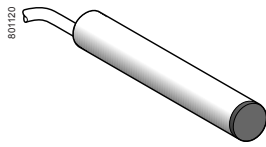

XS606B3●●L2

2

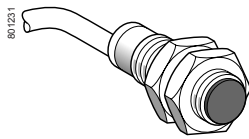

XS612B3●●L2

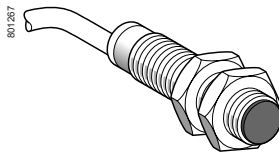

XS6●●B1●●L2

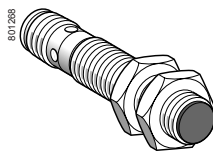

XS6●●B1●●M12

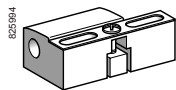

XSZB1●●

Specifications		
Sensor type		XS6●●B3D●M12, XS6●●B1D●M12 XS6●●B3D●L2, XS6●●B1D●L2
Product certifications		UL, CSA, CE
Connection	Connector	M12 or remote M12 connector (L01M12) on 0.15 m pigtail connector
	Pre-cabled	Length 2 m
Operating zone	Ø 6.5 and Ø 8	mm 0–2 (0–0.08 in.)
	Ø 12	mm 0–3.2 (0–0.13 in.)
	Ø 18	mm 0–6.4 (0–0.25 in.)
	Ø 30	mm 0–12 (0–0.47 in.)
Differential travel		% 1–15 of effective sensing distance (Sr)
Degree of protection	Conforming to IEC 60529	IP 65 and IP 67
	Conforming to DIN 40050	IP 69K
Storage temperature		°C -40 to +85 (-40 to +185 °F)
Operating temperature		°C -25 to +70 (-13 to +158 °F)
Materials	Case	Nickel-plated brass (except XS606B1D or XS608B1D: stainless steel, grade 303)
	Sensing face	PPS
	Cable	PvR 2 x 0.34 mm ² (22 AWG) except Ø 6.5 and Ø 8: 2 x 0.11 mm ² (27 AWG)
Vibration resistance	Conforming to IEC 60068-2-6	25 gn, amplitude ± 2 mm (f = 10 to 55 Hz)
Shock resistance	Conforming to IEC 60068-2-27	50 gn, duration 11 ms
Output state indication		Yellow LED, 4 viewing ports at 90°
Rated supply voltage		V --- 12–48 non-polarized for XS6●●B1D, --- 12–24 non-polarized for XS6●●B3D (except Ø 6.5 and Ø 8 short case models: polarized), with protection against reverse polarity
Voltage limits (including ripple)		V --- 10–58 for XS6●●B1D --- 10–36 for XS6●●B3D
Switching capacity		mA ≤ 100 with overload and short-circuit protection
Voltage drop, closed state		V 4
Current consumption, no-load		mA ≤ 0.5 mA
Maximum switching frequency	Ø 6.5, Ø 8	Hz 3000
	Ø 12	Hz 2000
	Ø 18	Hz 1000
	Ø 30	Hz 500
Delays	First-up	ms ≤ 10
	Response	ms ≤ 0.3
	Recovery	ms ≤ 0.3

Wiring diagrams

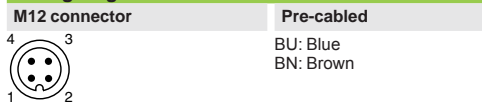

2-wire c non-polarized

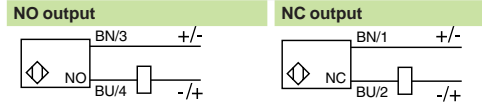

2-wire c polarized

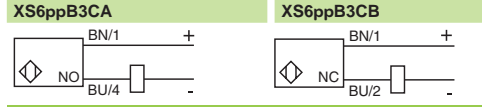

Setup

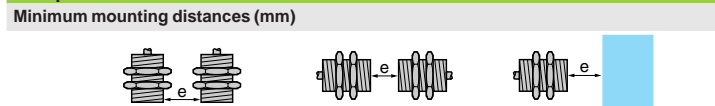

Sensors	Side by side	Face to face	Facing a metal object
Ø 6.5	e ≥ 5	e ≥ 30	e ≥ 8
Ø 8	e ≥ 5	e ≥ 30	e ≥ 8
Ø 12	e ≥ 8	e ≥ 50	e ≥ 12
Ø 18	e ≥ 16	e ≥ 100	e ≥ 25
Ø 30	e ≥ 30	e ≥ 180	e ≥ 45

Dimensions (mm)

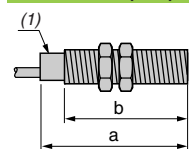

(1) LED

Sensors		Pre-cabled (mm)		M12 connector (mm)	
		a	b	a	b
Short case model					
Ø 6.5	XS606B3D	33	–	–	–
Ø 8	XS608B3D	33	25	–	24
Ø 12	XS612B3D	35	25	50	30
Ø 18	XS618B3D	39	28	50	28
Ø 30	XS630B3D	43	32	55	32
Long case model					
Ø 6.5	XS606B1D	51	–	–	–
Ø 8	XS608B1D	51	42	62	40
Ø 12	XS612B1D	53	42	62	42
Ø 18	XS618B1D	62	52	74	52
Ø 30	XS630B1D	62	52	74	52

OsiSense® XS

Inductive proximity sensors

General purpose
Cylindrical, increased range, flush mountable
Three-wire DC, solid-state output

Sensors, 3-wire 12-48 V \overline{DC} , long case model

Sensing dist. Sn, mm (in.)	Function	Output	Connection	Catalog Number	Weight kg (lb)
Ø 8, threaded M8 x 1					
2.5 (0.10)	NO	PNP	Pre-cabled (L = 2 m) (1)	XS608B1PAL2	0.035 (0.08)
			M12 connector	XS608B1PAM12	0.015 (0.03)
	NPN	PNP	Pre-cabled (L = 2 m) (1)	XS608B1NAL2	0.035 (0.08)
			M12 connector	XS608B1NAM12	0.015 (0.03)
	NC	PNP	Pre-cabled (L = 2 m) (1)	XS608B1PBL2	0.035 (0.08)
			M12 connector	XS608B1PBM12	0.015 (0.03)
NPN	PNP	Pre-cabled (L = 2 m) (1)	XS608B1NBL2	0.035 (0.08)	
		M12 connector	XS608B1NBM12	0.015 (0.03)	
Ø 12, threaded M12 x 1					
4 (0.16)	NO	PNP	Pre-cabled (L = 2 m) (1)	XS612B1PAL2	0.075 (0.17)
			M12 connector	XS612B1PAM12	0.020 (0.04)
	NPN	PNP	Pre-cabled (L = 2 m) (1)	XS612B1NAL2	0.075 (0.17)
			M12 connector	XS612B1NAM12	0.020 (0.04)
	NC	PNP	Pre-cabled (L = 2 m) (1)	XS612B1PBL2	0.075 (0.17)
			M12 connector	XS612B1PBM12	0.020 (0.04)
NPN	PNP	Pre-cabled (L = 2 m) (1)	XS612B1NBL2	0.075 (0.17)	
		M12 connector	XS612B1NBM12	0.020 (0.04)	
Ø 18, threaded M18 x 1					
8 (0.31)	NO	PNP	Pre-cabled (L = 2 m) (1)	XS618B1PAL2	0.100 (0.22)
			M12 connector	XS618B1PAM12	0.040 (0.09)
			Remote screw term. connector	XS618B1PAL01B (2)	0.100 (0.22)
			Remote DIN 43650 connector	XS618B1PAL01C	0.100 (0.22)
			Remote M18 connector	XS618B1PAL01G	0.100 (0.22)
			M12 connector	XS618B1NAM12	0.040 (0.09)
	NPN	PNP	Pre-cabled (L = 2 m) (1)	XS618B1NAL2	0.100 (0.22)
			M12 connector	XS618B1NAM12	0.040 (0.09)
			Remote screw term. connector	XS618B1NAL01B (2)	0.100 (0.22)
			Remote DIN 43650 connector	XS618B1NAL01C	0.100 (0.22)
			Remote M18 connector	XS618B1NAL01G	0.100 (0.22)
			M12 connector	XS618B1NBM12	0.040 (0.09)
	NC	PNP	Pre-cabled (L = 2 m) (1)	XS618B1PBL2	0.100 (0.22)
			M12 connector	XS618B1PBM12	0.040 (0.09)
			Remote screw term. connector	XS618B1PBL01B (2)	0.100 (0.22)
			Remote DIN 43650 connector	XS618B1PBL01C	0.100 (0.22)
			Remote M18 connector	XS618B1PBL01G	0.100 (0.22)
			M12 connector	XS618B1NBL2	0.100 (0.22)
NPN	PNP	Pre-cabled (L = 2 m) (1)	XS618B1NBL2	0.100 (0.22)	
		M12 connector	XS618B1NBM12	0.040 (0.09)	
		Remote screw term. connector	XS618B1NBL01B (2)	0.100 (0.22)	
		Remote DIN 43650 connector	XS618B1NBL01C	0.100 (0.22)	
		Remote M18 connector	XS618B1NBL01G	0.100 (0.22)	
		M12 connector	XS618B1NBM12	0.040 (0.09)	
Ø 30, threaded M30 x 1.5					
15 (0.59)	NO	PNP	Pre-cabled (L = 2 m) (1)	XS630B1PAL2	0.205 (0.45)
			M12 connector	XS630B1PAM12	0.145 (0.32)
			Remote screw term. connector	XS630B1PAL01B (2)	0.205 (0.45)
			Remote DIN 43650 connector	XS630B1PAL01C	0.205 (0.45)
			Remote M18 connector	XS630B1PAL01G	0.205 (0.45)
			M12 connector	XS630B1NAM12	0.145 (0.32)
	NPN	PNP	Pre-cabled (L = 2 m) (1)	XS630B1NAL2	0.205 (0.45)
			M12 connector	XS630B1NAM12	0.145 (0.32)
			Remote screw term. connector	XS630B1NAL01B (2)	0.205 (0.45)
			Remote DIN 43650 connector	XS630B1NAL01C	0.205 (0.45)
			Remote M18 connector	XS630B1NAL01G	0.205 (0.45)
			M12 connector	XS630B1NBM12	0.145 (0.32)
	NC	PNP	Pre-cabled (L = 2 m) (1)	XS630B1PBL2	0.205 (0.45)
			M12 connector	XS630B1PBM12	0.145 (0.32)
			Remote screw term. connector	XS630B1PBL01B (2)	0.205 (0.45)
			Remote DIN 43650 connector	XS630B1PBL01C	0.205 (0.45)
			Remote M18 connector	XS630B1PBL01G	0.205 (0.45)
			M12 connector	XS630B1NBL2	0.205 (0.45)
NPN	PNP	Pre-cabled (L = 2 m) (1)	XS630B1NBL2	0.205 (0.45)	
		M12 connector	XS630B1NBM12	0.145 (0.32)	
		Remote screw term. connector	XS630B1NBL01B (2)	0.205 (0.45)	
		Remote DIN 43650 connector	XS630B1NBL01C	0.205 (0.45)	
		Remote M18 connector	XS630B1NBL01G	0.205 (0.45)	
		M12 connector	XS630B1NBM12	0.145 (0.32)	

Accessories

Description	For use with sensors	Catalog Number	Weight kg (lb)
Mounting clamps	Ø 8	XSZB108	0.006 (0.01)
	Ø 12	XSZB112	0.006 (0.01)
	Ø 18	XSZB118	0.010 (0.02)
	Ø 30	XSZB130	0.020 (0.02)

(1) For a 5 m cable replace L2 with L5; for a 10 m cable replace L2 with L10.

Example: XS608B1PAL2 becomes XS608B1PAL5 with a 5 m cable.

(2) Protective cable gland included with remote screw terminal connector.

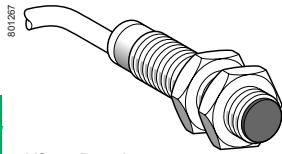

XS6●●B1●●L2

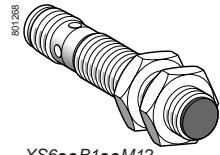

XS6●●B1●●M12

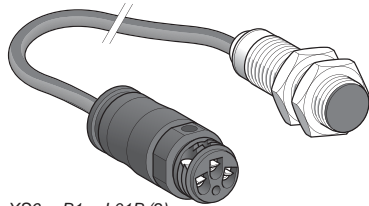

XS6●●B1●●L01B (2)

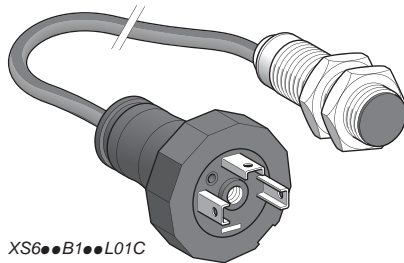

XS6●●B1●●L01C

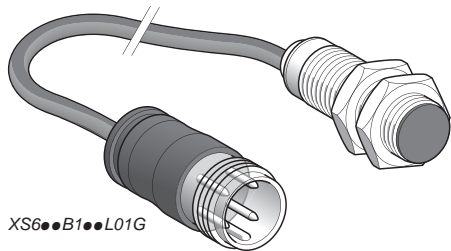

XS6●●B1●●L01G

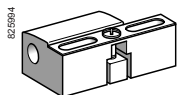

XSZB●●●

2

Specifications		XS1/XS6●●B●●M8	XS1/XS6●●B●●M12	XS1/XS6●●B●●L2
Sensor type		UL, CSA, CE		
Product certifications	Connector	M8	M12	—
	Pre-cabled	—	—	Length 2 m
	Remote connector	Remote screw terminal (L01B), DIN 43650 (L01C) or M18 connector (L01G) on 0.15 m pigtail connector		
Operating zone	Ø 6.5 and Ø 8	mm	0–2 (0–0.08 in.)	
	Ø 12	mm	0–3.2 (0–0.13 in.)	
	Ø 18	mm	0–6.4 (0–0.25 in.)	
	Ø 30	mm	0–12 (0–0.47 in.)	
Differential travel		%	1–15 of effective sensing distance (Sr)	
Degree of protection	Conforming to IEC 60529		IP 65 and IP 67	IP 65 and IP 68, double insulation  except Ø 6.5 and Ø 8: IP 67
	Conforming to DIN 40050		IP 69K for Ø 12, 18 and 30 sensors	
Storage temperature		°C	-40 to +85 (-40 to +185 °F)	
Operating temperature		°C	-25 to +70 (-13 to +158 °F)	
Materials	Case		Nickel-plated brass (except XS608: stainless steel, grade 303)	
	Sensing face		PPS	
	Cable		—	PvR 3 x 0.34 mm ² (22 AWG) except Ø 6.5 and 8: 3 x 0.11 mm (27 AWG) ²
Vibration resistance	Conforming to IEC 60068-2-6		25 gn, amplitude ± 2 mm (f = 10 to 55 Hz)	
Shock resistance	Conforming to IEC 60068-2-27		50 gn, duration 11 ms	
Output state indication			Yellow LED, 4 viewing ports at 90°	Yellow LED, annular
Rated supply voltage		V	XS1: 12–24 with protection against reverse polarity XS6: 12–48 with protection against reverse polarity	
Voltage limits (including ripple)		V	XS1: 10–36; XS6: 10–58	
Switching capacity		mA	≤ 200 with overload and short-circuit protection	
Voltage drop, closed state		V	≤ 2	
Current consumption, no-load		mA	≤ 10	
Maximum switching frequency	Ø 6.5, Ø 8 and Ø 12	Hz	2500	
	Ø 18	Hz	1000	
	Ø 30	Hz	500	
Delays	First-up	ms	≤ 10	
	Response	ms	≤ 0.2 for Ø 6.5, Ø 8 and Ø 12, ≤ 0.3 for Ø 18, ≤ 0.6 for Ø 30	
	Recovery	ms	≤ 0.2 for Ø 6.5, Ø 8 and Ø 12, ≤ 0.7 for Ø 18, ≤ 1.4 for Ø 30	

Wiring diagrams

Connector

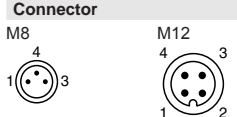

Pre-cabled
BU: Blue
BN: Brown
BK: Black

PNP

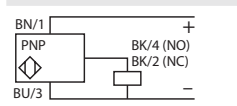

NPN

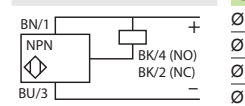

For M8 connector, NO and NC outputs are on terminal 4

Setup

Minimum mounting distances (mm)

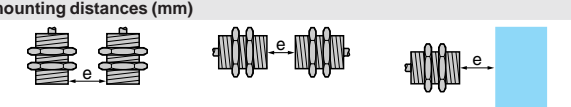

Sensors	Side by side	Face to face	Facing a metal object
Ø 6.5	e ≥ 5	e ≥ 30	e ≥ 8
Ø 8	e ≥ 5	e ≥ 30	e ≥ 8
Ø 12	e ≥ 8	e ≥ 50	e ≥ 12
Ø 18	e ≥ 16	e ≥ 100	e ≥ 24
Ø 30	e ≥ 30	e ≥ 180	e ≥ 45

Dimensions (mm)

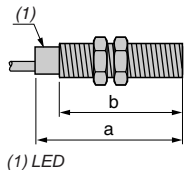

Sensors		Pre-cabled (mm)		M8 connector (mm)		M12 connector (mm)	
Short case model		a	b	a	b	a	b
Ø 6.5	XS106B3	33	—	42	—	45	—
Ø 8	XS108B3	33	25	42	26	45	24
Ø 12	XS112B3	35	25	—	—	50	30
Ø 18	XS118B3	39	28	—	—	50	28
Ø 30	XS130B3	43	32	—	—	55	32
Sensors		Pre-cabled (mm)		M12 connector (mm)			
Long case model		a	b	a	b		
Ø 8	XS6 08B1	51	42	62	40		
Ø 12	XS612B1	53	42	62	42		
Ø 18	XS618B1	62	52	74	52		
Ø 30	XS630B1	62	52	74	52		

OsiSense® XS

Inductive proximity sensors

General purpose
Cylindrical, increased range, flush mountable
Two-wire AC or DC ⁽²⁾

2

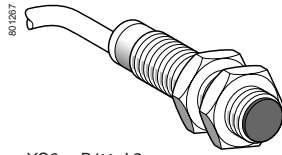

XS6●●B1M●L2

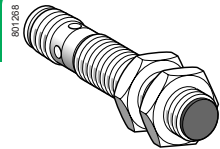

XS6●●B1●●U20

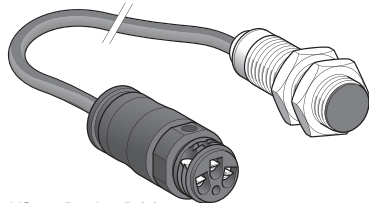

XS6●●B1●L01B (2)

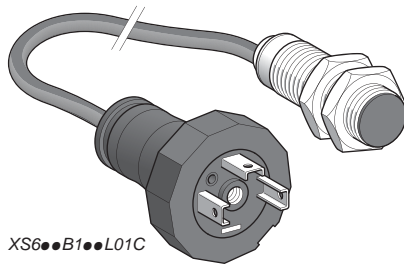

XS6●●B1●●L01C

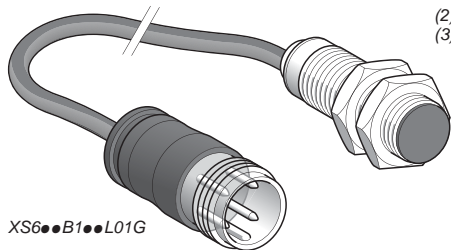

XS6●●B1●●L01G

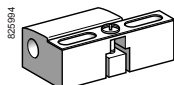

XSZB1●●

Sensors, 2-wire 24-240 V ~, long case model

Sensing distance Sn, mm (in.)	Function	Connection	Catalog Number	Weight kg (lb)
Ø 12, threaded M12 x 1				
4 (0.16)	NO	Pre-cabled (L = 2 m) (1)	XS612B1MAL2	0.075 (0.17)
		1/2"-20UNF connector	XS612B1MAU20	0.025 (0.06)
	NC	Pre-cabled (L = 2 m) (1)	XS612B1MBL2	0.075 (0.17)
		1/2"-20UNF connector	XS612B1MBU20	0.025 (0.06)

Ø 18, threaded M18 x 1				
8 (0.31)	NO	Pre-cabled (L = 2 m) (1)	XS618B1MAL2	0.100 (0.22)
		1/2"-20UNF connector	XS618B1MAU20	0.060 (0.13)
		Remote screw terminal connector	XS618B1MAL01B (3)	0.100 (0.22)
		Remote DIN 43650A connector	XS618B1MAL01C	0.100 (0.22)
		Remote M18 connector	XS618B1MAL01G	0.100 (0.22)
	NC	Pre-cabled (L = 2 m) (1)	XS618B1MBL2	0.100 (0.22)
		1/2"-20UNF connector	XS618B1MBU20	0.060 (0.13)
		Remote screw terminal connector	XS618B1MBL01B (3)	0.100 (0.22)
		Remote DIN 43650A connector	XS618B1MBL01C	0.100 (0.22)
		Remote M18 connector	XS618B1MBL01G	0.100 (0.22)

Ø 30, threaded M30 x 1.5				
15 (0.59)	NO	Pre-cabled (L = 2 m) (2)	XS630B1MAL2	0.205 (0.45)
		1/2"-20UNF connector	XS630B1MAU20	0.145 (0.32)
		Remote screw terminal connector	XS630B1MAL01B (3)	0.205 (0.45)
		Remote DIN 43650A connector	XS630B1MAL01C	0.205 (0.45)
		Remote M18 connector	XS630B1MAL01G	0.205 (0.45)
	NC	Pre-cabled (L = 2 m) (2)	XS630B1MBL2	0.205 (0.45)
		1/2"-20UNF connector	XS630B1MBU20	0.145 (0.32)
		Remote screw terminal connector	XS6 30B1MBL01B (3)	0.205 (0.45)
		Remote DIN 43650A connector	XS6 30B1MBL01C	0.205 (0.45)
		Remote M18 connector	XS6 30B1MBL01G	0.205 (0.45)

Accessories

Description	For use with sensors	Catalog Number	Weight kg (lb)
Mounting clamps	Ø 12	XSZB112	0.006 (0.01)
	Ø 18	XSZB118	0.010 (0.02)
	Ø 30	XSZB130	0.020 (0.04)

(1) For a 5 m cable replace L2 with L5; for a 10 m cable replace L2 with L10.
Example: XS612B1MAL2 becomes **XS612B1MAL5** with a 5 m cable.
(2) Available in ø8 plastic with double insulation, see page 2/30.
(3) Protective cable gland included with remote screw terminal connector.

Specifications		XS6●●B1M●U20	XS6●●B1M●L●
Sensor type			
Product certifications		UL, CSA, CE	
Connection	Connector	1/2" - 20 UNF	–
	Pre-cabled	–	Length 2 m
	Remote connector	Remote screw terminal (L01B), DIN 43650A (L01C) or M18 connector (L01G) on 0.15 m pigtail connector	
Operating zone	Ø 12	mm	0–3.2 (0–0.13 in.)
	Ø 18	mm	0–6.4 (0–0.25 in.)
	Ø 30	mm	0–12 (0–0.47 in.)
Differential travel		%	1–15 of effective sensing distance (Sr)
Degree of protection	Conforming to IEC 60529	IP 65 and IP 67	
	Conforming to DIN 40050	IP 69K	
Storage temperature		°C	–40 to +85 (–40 to +185 °F)
Operating temperature		°C	–25 to +70 (–13 to +158 °F)
Materials	Case	Nickel-plated brass	
	Sensing face	PPS	
	Cable	PvR 2 x 0.34 mm ² (22 AWG)	
Vibration resistance	To IEC 60068-2-6	25 gn, amplitude ± 2 mm (f = 10 to 55 Hz)	
Shock resistance	To IEC 60068-2-27	50 gn, duration 11 ms	
Output state indication		Yellow LED: annular on pre-cabled version Yellow LED with 4 viewing ports at 90° on connector version	
Rated supply voltage		V	≈ 24–240 (~ 50/60 hZ)
Voltage limits (including ripple)		V	≈ 20–264
Switching capacity	XS612B1M●●●	mA	5–200 (2)
	XS618B1M●●●, XS630B1M●●●	mA	~ 5–300 or ~ 5–200 (1)
Voltage drop, closed state		V	≤ 5.5
Current consumption, no-load		mA	≤ 0.8
Maximum switching frequency (a.c./d.c. supply)	Ø 12	Hz	~ 1000 / ~ 25
	Ø 18	Hz	~ 1000 / ~ 25
	Ø 30	Hz	~ 500 / ~ 25
Delays	First-up	ms	≤ 25 for Ø 18 and Ø 30 sensors; ≤ 20 for Ø 12 sensors
	Response	ms	≤ 0.5
	Recovery	ms	≤ 0.2 for Ø 12 sensors; ≤ 0.5 for Ø 18 sensors; ≤ 2 for Ø 30 sensors

(1) A 0.4 A fast-acting fuse must be connected in series with the load.

Wiring diagrams

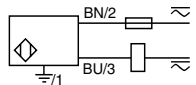
Connector (1) 1/2"-20UNF 	Pre-cabled BU: Blue BN: Brown	2-wire ~ or --- NO or NC output 	⚡ : on connector models only
---	--	---	------------------------------

Setup

Minimum mounting distances (mm)

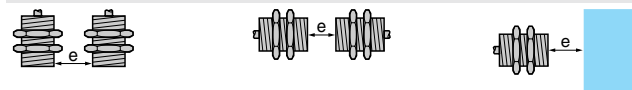

Sensors	Side by side	Face to face	Facing a metal object
Ø 12	e ≥ 8	e ≥ 50	e ≥ 12
Ø 18	e ≥ 16	e ≥ 100	e ≥ 25
Ø 30	e ≥ 30	e ≥ 180	e ≥ 45

Dimensions (mm)

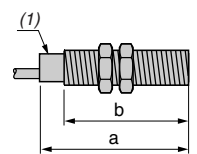

(1) LED

Sensors	Pre-cabled (mm)		Connector (mm)	
	a	b	a	b
Ø 12 XS612B1M●	53	42	62	42
Ø 18 XS618B1M●	62	52	73	52
Ø 30 XS630B1M●	62	52	73	52

OsiSense® XS

Inductive proximity sensors

General purpose
Cylindrical, standard range, flush mountable
Two-wire AC or DC ⁽²⁾

2

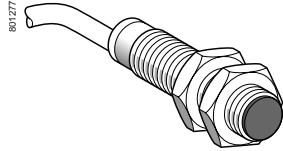

XS512B1MAL2

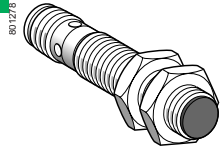

XS518B1MAL2

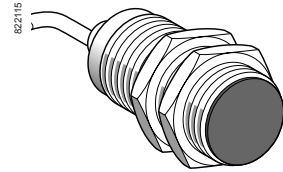

XS530B1MAL2

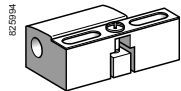

XSZB112

Sensors, 2-wire 24-240 V AC, long case model

Ø 12, threaded M12 x 1					
Sensing distance Sn, mm (in.)	Function	Connection	Catalog Number	kg	Weight (lb)
2 (0.08)	NO	Pre-cabled (L = 2 m) (1)	XS512B1MAL2	0.075	(0.17)
		1/2"-20UNF connector	XS512B1MAU20	0.025	(0.06)
	NC	Pre-cabled (L = 2 m) (1)	XS512B1MBL2	0.075	(0.17)
		1/2"-20UNF connector	XS512B1MBU20	0.025	(0.06)

Ø 18, threaded M18 x 1					
Sensing distance Sn, mm (in.)	Function	Connection	Catalog Number	kg	Weight (lb)
5 (0.20)	NO	Pre-cabled (L = 2 m) (1)	XS518B1MAL2	0.100	(0.22)
		1/2"-20UNF connector	XS518B1MAU20	0.060	(0.13)
	NC	Pre-cabled (L = 2 m) (1)	XS518B1MBL2	0.100	(0.22)
		1/2"-20UNF connector	XS518B1MBU20	0.060	(0.13)

Ø 30, threaded M30 x 1.5					
Sensing distance Sn, mm (in.)	Function	Connection	Catalog Number	kg	Weight (lb)
10 (0.39)	NO	Pre-cabled (L = 2 m) (1)	XS530B1MAL2	0.205	(0.45)
		1/2"-20UNF connector	XS530B1MAU20	0.145	(0.32)
	NC	Pre-cabled (L = 2 m) (1)	XS530B1MBL2	0.205	(0.45)
		1/2"-20UNF connector	XS530B1MBU20	0.145	(0.32)

Accessories					
Description	For use with sensors	Catalog Number	kg	Weight (lb)	
Mounting clamps	Ø 12	XSZB112	0.006	(0.01)	
	Ø 18	XSZB118	0.010	(0.02)	
	Ø 30	XSZB130	0.020	(0.04)	

(1) For a 5 m cable replace L2 with L5; for a 10 m cable replace L2 with L10.
Example: XS512B1MAL2 becomes XS512B1MAL5 with a 5 m cable.
(2) Available in Ø8 plastic with double insulation, see page 2/30.

Specifications			
Sensor type		XS5●●B1M●U20	XS5●●B1M●L2
Product certifications			
Connection		UL, CSA, CE	
Connector		1/2"-20UNF	-
Pre-cabled		-	Length 2 m
Operating zone			
Ø 12	mm	0-1.6 (0-0.05 in.)	
Ø 18	mm	0-4 (0-0.16 in.)	
Ø 30	mm	0-8 (0-0.31 in.)	
Differential travel		%	
		1-15 of effective sensing distance (Sr)	
Degree of protection			
Conforming to IEC 60529		IP 65 and IP 67	
Conforming to DIN 40050		IP 69K	
Storage temperature		°C	
		-40 to +85 (-40 to +185 °F)	
Operating temperature		°C	
		-25 to +70 (-13 to +158 °F)	
Materials			
Case		Nickel-plated brass	
Sensing face		PPS	
Cable		-	PvR 2 x 0.34 mm ² (22 AWG)
Vibration resistance		Conforming to IEC 60068-2-6	
		25 gn, amplitude ± 2 mm (f = 10 to 55 Hz)	
Shock resistance		Conforming to IEC 60068-2-27	
		50 gn, duration 11 ms	
Output state indication			
		Yellow LED: 4 viewing ports at 90°	
		Yellow LED: annular	
Rated supply voltage		V	
		~ or --- 24-240 (~ 50/60 Hz)	
Voltage limits (including ripple)		V	
		~ or --- 20-264	
Switching capacity			
XS512B1M●●●	mA	5-200 (1)	
XS518B1M●●●, XS530B1M●●●	mA	~ 5-300 or --- 5-200 (1)	
Voltage drop, closed state		V	
		≤ 5.5	
Residual current, open state		mA	
		≤ 0.8	
Maximum switching frequency		Hz	
XS512B1●●●, XS518B1M●●●		~ 25 or --- 1000	
XS530B1M●●●		~ 25 or --- 500	
Delays			
First-up	ms	≤ 20 XS512B1M●●●, ≤ 25 XS518B1M●●● and XS530B1M●●●	
Response	ms	≤ 0.5	
Recovery	ms	≤ 0.2 XS512B1M●●●, ≤ 0.5 XS518B1M●●●, ≤ 2 XS530B1M●●●	

(1) A 0.4 A fast-acting fuse must be connected in series with the load.

Wiring diagrams

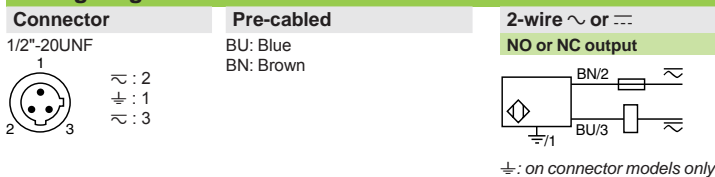

Setup

Minimum mounting distances (mm)

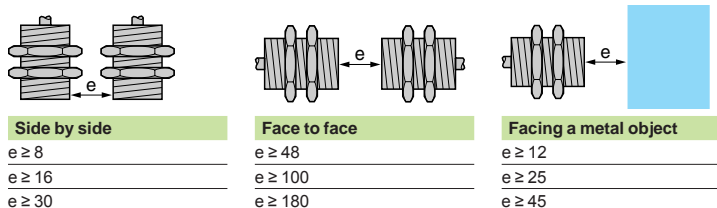

Dimensions (mm)

Sensor	Pre-cabled (mm)		Connector (mm)	
	a	b	a	b
XS512B1M	53	42	62	42
XS518B1M	62	52	73	52
XS530B1M	62	52	73	52

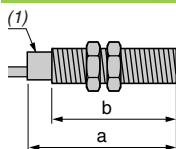

(1) LED

OsiSense® XS

Inductive proximity sensors

General purpose

Cylindrical, increased range, non-flush mountable

Three-wire DC, solid-state output

Sensors, 3-wire 12–48 V, long case model

Ø 12, threaded M12 x 1

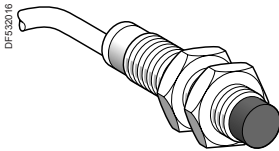

XS612B4●●L2

Sensing distance Sn, mm (in.)	Function	Output	Connection	Catalog Number	kg	Weight (lb)
7 (0.28)	NO	PNP	Pre-cabled (L = 2 m) (1)	XS612B4PAL2	0.075	(0.17)
			M12 connector	XS612B4PAM12	0.020	(0.04)
		NPN	Pre-cabled (L = 2 m) (1)	XS612B4NAL2	0.075	(0.17)
			M12 connector	XS612B4NAM12	0.020	(0.04)
	NC	PNP	Pre-cabled (L = 2 m) (1)	XS612B4PBL2	0.075	(0.17)
			M12 connector	XS612B4PBM12	0.020	(0.04)
		NPN	Pre-cabled (L = 2 m) (1)	XS612B4NBL2	0.075	(0.17)
			M12 connector	XS612B4NBM12	0.020	(0.04)

Ø 18, threaded M18 x 1

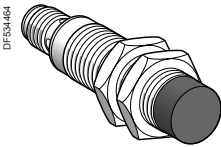

XS618B4●●M12

Sensing distance (Sn) mm	Function	Output	Connection	Catalog Number	kg	Weight (lb)
12 (0.47)	NO	PNP	Pre-cabled (L = 2 m) (1)	XS618B4PAL2	0.100	(0.22)
			M12 connector	XS618B4PAM12	0.040	(0.09)
		NPN	Pre-cabled (L = 2 m) (1)	XS618B4NAL2	0.100	(0.22)
			M12 connector	XS618B4NAM12	0.040	(0.09)
	NC	PNP	Pre-cabled (L = 2 m) (1)	XS618B4PBL2	0.100	(0.22)
			M12 connector	XS618B4PBM12	0.040	(0.09)
		NPN	Pre-cabled (L = 2 m) (1)	XS618B4NBL2	0.100	(0.22)
			M12 connector	XS618B4NBM12	0.040	(0.09)

Ø 30, threaded M30 x 1.5

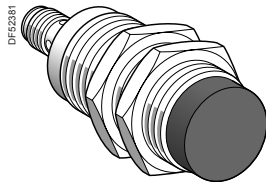

XS630B4●●M12

Sensing distance (Sn) mm	Function	Output	Connection	Catalog Number	kg	Weight (lb)
22 (0.87)	NO	PNP	Pre-cabled (L = 2 m) (1)	XS630B4PAL2	0.205	(0.45)
			M12 connector	XS630B4PAM12	0.145	(0.32)
		NPN	Pre-cabled (L = 2 m) (1)	XS630B4NAL2	0.205	(0.45)
			M12 connector	XS630B4NAM12	0.145	(0.32)
	NC	PNP	Pre-cabled (L = 2 m) (1)	XS630B4PBL2	0.205	(0.45)
			M12 connector	XS630B4PBM12	0.145	(0.32)
		NPN	Pre-cabled (L = 2 m) (1)	XS630B4NBL2	0.205	(0.45)
			M12 connector	XS630B4NBM12	0.145	(0.32)

Accessories

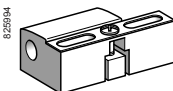

XSZB●●●

Description	For use with sensors	Catalog Number	kg	Weight (lb)
Mounting clamps	Ø 12	XSZB112	0.006	(0.01)
	Ø 18	XSZB118	0.010	(0.02)
	Ø 30	XSZB130	0.020	(0.04)

(1) For a 5 m cable replace L2 with L5; for a 10 m cable replace L2 with L10.
Example: XS612B4PAL2 becomes XS612B4PAL5 with a 5 m cable.

Specifications			
Sensor type		XS6●●B4●●M12	XS6●●B4●●L2
Product certifications			
Connection		UL, CSA, CE	
Connector	Connector	M12	–
	Pre-cabled	–	Length 2 m
Operating zone			
Ø	12	mm	0–5.6 (0–0.22 in.)
	18	mm	0–9.6 (0–0.38 in.)
	30	mm	0–17.6 (0–0.69 in.)
Differential travel		%	1–15 of effective sensing distance (Sr)
Degree of protection		Conforming to IEC 60529	IP 65 and IP 67
Storage temperature		°C	–40 to +85 (–40 to +185 °F)
Operating temperature		°C	–25 to +70 (–13 to +158 °F)
Materials			
Case		Nickel-plated brass	
Sensing face		PPS	
Cable		–	PvR 3 x 0.34 mm ² (22 AWG)
Vibration resistance		Conforming to IEC 60068-2-6	25 gn, amplitude ± 2 mm (f = 10 to 55 Hz)
Shock resistance		Conforming to IEC 60068-2-27	50 gn, duration 11 ms
Output state indication		Yellow LED: 4 viewing ports at 90°	Yellow LED: annular
Rated supply voltage		V	12–48 with protection against reverse polarity
Voltage limits (including ripple)		V	10–58
Switching capacity		mA	≤ 200 with overload and short-circuit protection
Voltage drop, closed state		V	≤ 2
Current consumption, no-load		mA	≤ 10
Maximum switching frequency			
XS612B4●●●●		Hz	2500
XS618B4●●●●		Hz	1000
XS630B4●●●●		Hz	500
Delays			
First-up		ms	≤ 10
Response		ms	≤ 0.2 for Ø 12, ≤ 0.3 for Ø 18, ≤ 0.6 for Ø 30
Recovery		ms	≤ 0.2 for Ø 12, ≤ 0.7 for Ø 18, ≤ 1.4 for Ø 30

Wiring diagrams

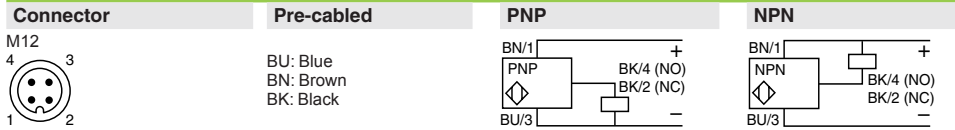

Setup

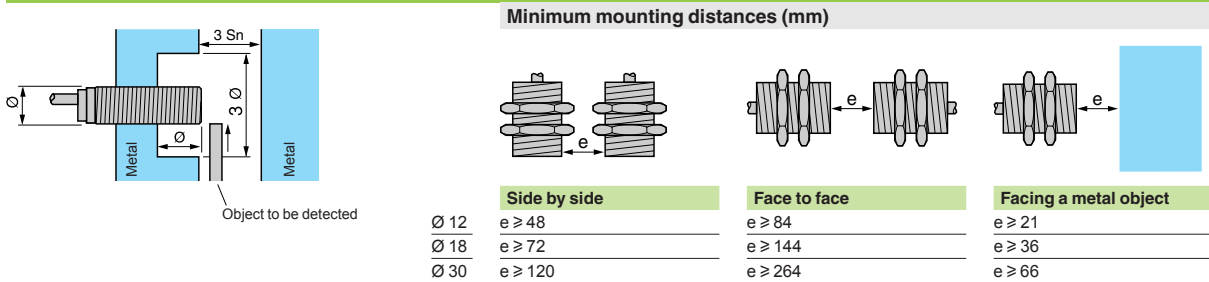

Dimensions (mm)

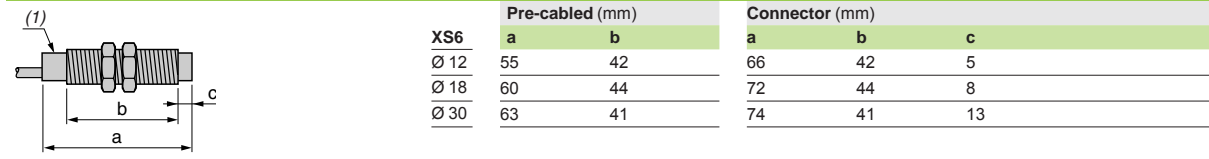

(1) LED

OsiSense® XS Inductive proximity sensors

General purpose
Cylindrical, increased range, non-flush mountable
Two-wire AC or DC

2

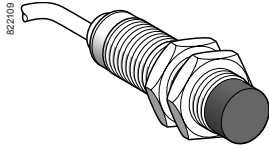

XS6●●B4M●L2

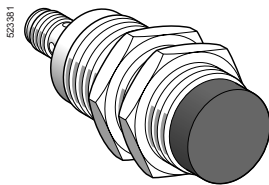

XS6●●B4M●U20

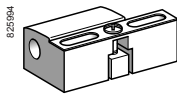

XSZB1●●

Sensors, 2-wire \sim 24–240 V, long case model

Ø 18, threaded M18 x 1

Sensing distance Sn, mm (in.)	Function	Connection	Catalog Number	Weight kg (lb)
12 (0.47)	NO	Pre-cabled (L = 2 m) (1)	XS618B4MAL2	0.120 (0.26)
		1/2"-20UNF connector	XS618B4MAU20	0.060 (0.13)
	NC	Pre-cabled (L = 2 m) (1)	XS618B4MBL2	0.120 (0.26)
		1/2"-20UNF connector	XS618B4MBU20	0.060 (0.13)

Ø 30, threaded M30 x 1.5

Sensing distance Sn, mm (in.)	Function	Connection	Catalog Number	Weight kg (lb)
22 (0.87)	NO	Pre-cabled (L = 2 m) (1)	XS630B4MAL2	0.205 (0.45)
		1/2"-20UNF connector	XS630B4MAU20	0.145 (0.32)
	NC	Pre-cabled (L = 2 m) (1)	XS630B4MBL2	0.205 (0.45)
		1/2"-20UNF connector	XS630B4MBU20	0.145 (0.32)

Accessories

Description	For use with sensors	Catalog Number	Weight kg (lb)
Mounting clamps	Ø 18	XSZB118	0.010 (0.02)
	Ø 30	XSZB130	0.020 (0.04)

(1) For a 5 m cable replace L2 with L5; for a 10 m cable replace L2 with L10.
Example: XS618B4MAL2 becomes **XS618B4MAL5** with a 5 m cable.

Specifications,
Wiring Diagrams,
Setup,
Dimensions

OsiSense® XS

Inductive proximity sensors

General purpose
Cylindrical, increased range, non-flush mountable
Two-wire AC or DC

2

Specifications		XS6●●B4M●U20	XS6●●B4M●L2
Sensor type		XS6●●B4M●U20	XS6●●B4M●L2
Product certifications		UL, CSA, CE	
Connection	Connector	1/2"-20UNF	—
	Pre-cabled	—	Length 2 m
Operating zone	∅ 18	mm 0–9.6 (0–0.38 in.)	
	∅ 30	mm 0–17.6 (0–0.69 in.)	
Differential travel		%	
		1–15 of effective sensing distance (Sr)	
Degree of protection	Conforming to IEC 60529	IP 65 and IP 67	IP 65 and IP 68, double insulation □
Storage temperature		°C - 40 to + 85 (-40 to +185 °F)	
Operating temperature		°C - 25 to + 70 (-13 to +158 °F)	
Materials	Case	Nickel-plated brass	
	Sensing face	PPS	
	Cable	—	PvR 2 x 0.34 mm ² (22 AWG)
Vibration resistance	Conforming to IEC 60068-2-6	25 gn, amplitude ± 2 mm (f = 10 to 55 Hz)	
Shock resistance	Conforming to IEC 60068-2-27	50 gn, duration 11 ms	
Output state indication		Yellow LED: 4 viewing ports at 90°	
Rated supply voltage		V ~ or --- 24–240 (~ 50/60 Hz)	
Voltage limits (including ripple)		V ~ or --- 20–264	
Switching capacity		mA ~ 50300 or --- 5–200 (1)	
Voltage drop, closed state		V ≤ 5.5	
Residual current, open state		mA ≤ 0.8	
Maximum switching frequency	XS618B4M●●●	Hz ~ 25 or --- 1000	
	XS630B4M●●●	Hz ~ 25 or --- 300	
Delays	First-up	ms ≤ 30 XS618B4M●●● and XS630B4M●●●	
	Response	ms ≤ 0.5	
	Recovery	ms ≤ 0.5 XS618B4M●●●, ≤ 2 XS630B4M●●●	

(1) A 0.4 A fast-acting fuse must be connected in series with the load.

Wiring diagrams

Connector	Pre-cabled	2-wire ~ or --- NO or NC output
1/2"-20UNF	BU: Blue BN: Brown	
		⚡: on connector models only

Setup

Minimum mounting distances (mm)

Mounting Type	∅ 18	∅ 30
Side by side	e ≥ 72	e ≥ 120
Face to face	e ≥ 144	e ≥ 264
Facing a metal object	e ≥ 36	e ≥ 66

Dimensions (mm)

(1) LED

XS6	Pre-cabled (mm)		Connector (mm)		
	a	b	a	b	c
∅ 18	60	44	72	44	8
∅ 30	63	41	74	41	13

OsiSense® XS

Inductive proximity sensors

General purpose
Cylindrical, standard range, flush mountable
Three-wire DC, solid-state output

2

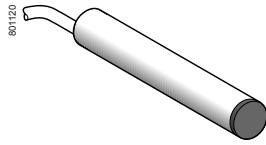

XS506B1●●L2

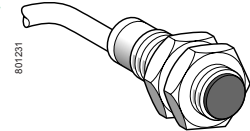

XS508B1●●L2



XS512B1●●M12

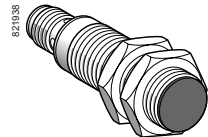

XS518B1●●M12

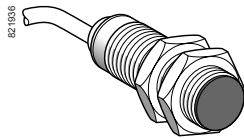

XS518B1●●L2

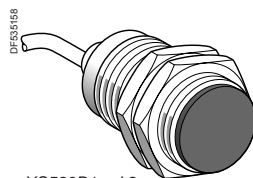

XS530B1●●L2

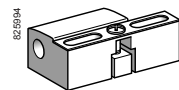

XSZB1●●

Sensors, 3-wire 12-24 V \bar{DC} , short case model

Sensing dist. Sn, mm (in.)	Function	Output	Connection	Catalog Number	Weight kg (lb)
Ø 6.5, plain					
1.5 (0.06)	NO	PNP	Pre-cabled (L = 2 m) (1)	XS506B1PAL2	0.035 (0.08)
			M8 connector	XS506B1PAM8	0.025 (0.06)
			M12 connector	XS506B1PAM12	0.025 (0.06)
	NPN	PNP	Pre-cabled (L = 2 m) (1)	XS506B1NAL2	0.035 (0.08)
			M8 connector	XS506B1NAM8	0.025 (0.06)
			M12 connector	XS506B1NAM12	0.025 (0.06)
NC	PNP	Pre-cabled (L = 2 m) (1)	XS506B1PBL2	0.035 (0.08)	
		M8 connector	XS506B1PBM8	0.025 (0.06)	
		M12 connector	XS506B1PBM12	0.025 (0.06)	
NPN	PNP	Pre-cabled (L = 2 m) (1)	XS506B1NBL2	0.035 (0.08)	
		M8 connector	XS506B1NBM8	0.025 (0.06)	
		M12 connector	XS506B1NBM12	0.025 (0.06)	
Ø 8, threaded M8 x 1					
1.5 (0.06)	NO	PNP	Pre-cabled (L = 2 m) (1)	XS508B1PAL2	0.035 (0.08)
			M8 connector	XS508B1PAM8	0.025 (0.06)
			M12 connector	XS508B1PAM12	0.025 (0.06)
	NPN	PNP	Pre-cabled (L = 2 m) (1)	XS508B1NAL2	0.035 (0.08)
			M8 connector	XS508B1NAM8	0.025 (0.06)
			M12 connector	XS508B1NAM12	0.025 (0.06)
NC	PNP	Pre-cabled (L = 2 m) (1)	XS508B1PBL2	0.035 (0.08)	
		M8 connector	XS508B1PBM8	0.025 (0.06)	
		M12 connector	XS508B1PBM12	0.025 (0.06)	
NPN	PNP	Pre-cabled (L = 2 m) (1)	XS508B1NBL2	0.035 (0.08)	
		M8 connector	XS508B1NBM8	0.025 (0.06)	
		M12 connector	XS508B1NBM12	0.025 (0.06)	
Ø 12, threaded M12 x 1					
2 (0.08)	NO	PNP	Pre-cabled (L = 2 m) (1)	XS512B1PAL2	0.075 (0.17)
			M12 connector	XS512B1PAM12	0.035 (0.08)
			M12 connector	XS512B1PAM12	0.035 (0.08)
	NPN	PNP	Pre-cabled (L = 2 m) (1)	XS512B1NAL2	0.075 (0.17)
			M12 connector	XS512B1NAM12	0.035 (0.08)
			M12 connector	XS512B1NAM12	0.035 (0.08)
NC	PNP	Pre-cabled (L = 2 m) (1)	XS512B1PBL2	0.075 (0.17)	
		M12 connector	XS512B1PBM12	0.035 (0.08)	
		M12 connector	XS512B1PBM12	0.035 (0.08)	
NPN	PNP	Pre-cabled (L = 2 m) (1)	XS512B1NBL2	0.075 (0.17)	
		M12 connector	XS512B1NBM12	0.035 (0.08)	
		M12 connector	XS512B1NBM12	0.035 (0.08)	
Ø 18, threaded M18 x 1					
5 (0.20)	NO	PNP	Pre-cabled (L = 2 m) (1)	XS518B1PAL2	0.120 (0.26)
			M12 connector	XS518B1PAM12	0.060 (0.13)
			M12 connector	XS518B1PAM12	0.060 (0.13)
	NPN	PNP	Pre-cabled (L = 2 m) (1)	XS518B1NAL2	0.120 (0.26)
			M12 connector	XS518B1NAM12	0.060 (0.13)
			M12 connector	XS518B1NAM12	0.060 (0.13)
NC	PNP	Pre-cabled (L = 2 m) (1)	XS518B1PBL2	0.120 (0.26)	
		M12 connector	XS518B1PBM12	0.060 (0.13)	
		M12 connector	XS518B1PBM12	0.060 (0.13)	
NPN	PNP	Pre-cabled (L = 2 m) (1)	XS518B1NBL2	0.120 (0.26)	
		M12 connector	XS518B1NBM12	0.060 (0.13)	
		M12 connector	XS518B1NBM12	0.060 (0.13)	
Ø 30, threaded M30 x 1.5					
10 (0.39)	NO	PNP	Pre-cabled (L = 2 m) (1)	XS530B1PAL2	0.205 (0.45)
			M12 connector	XS530B1PAM12	0.145 (0.32)
			M12 connector	XS530B1PAM12	0.145 (0.32)
	NPN	PNP	Pre-cabled (L = 2 m) (1)	XS530B1NAL2	0.205 (0.45)
			M12 connector	XS530B1NAM12	0.145 (0.32)
			M12 connector	XS530B1NAM12	0.145 (0.32)
NC	PNP	Pre-cabled (L = 2 m) (1)	XS530B1PBL2	0.205 (0.45)	
		M12 connector	XS530B1PBM12	0.145 (0.32)	
		M12 connector	XS530B1PBM12	0.145 (0.32)	
NPN	PNP	Pre-cabled (L = 2 m) (1)	XS530B1NBL2	0.205 (0.45)	
		M12 connector	XS530B1NBM12	0.145 (0.32)	
		M12 connector	XS530B1NBM12	0.145 (0.32)	
Accessories					
Description	For use with sensors	Catalog Number	Weight kg (lb)		
Mounting clamps	Ø 6.5 (plain)	XSZB165	0.005 (0.01)		
	Ø 8	XSZB108	0.006 (0.01)		
	Ø 12	XSZB112	0.006 (0.01)		
	Ø 18	XSZB118	0.010 (0.02)		
	Ø 30	XSZB130	0.020 (0.02)		

(1) For a 5 m cable replace L2 with L5; for a 10 m cable replace L2 with L10.
Example: XS508B1PAL2 becomes XS508B1PAL5 with a 5 m cable.

OsiSense® XS

Inductive proximity sensors

General purpose
Cylindrical, standard range, flush mountable
Three-wire DC, solid-state output

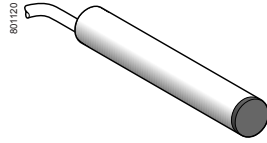

XS506BL●●L2

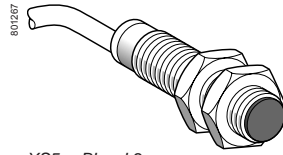

XS5●●BL●●L2

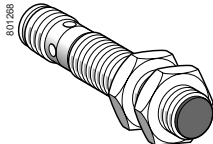

XS5●●BL●●M12

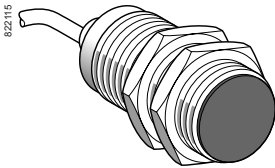

XS5 30BL●●L2

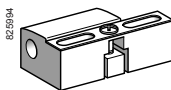

XSZB1●●

Sensors, 3-wire 12-48 V $\overline{\text{DC}}$, long case model

Sensing dist. Sn, mm (in.)	Function	Output	Connection	Catalog Number	kg	Weight (lb)
Ø 6.5, plain						
1.5 (0.06)	NO	PNP	Pre-cabled (L = 2 m) (1)	XS506BLPAL2	0.035	(0.08)
		NPN	Pre-cabled (L = 2 m) (1)	XS506BLNAL2	0.035	(0.08)

Ø 8, threaded M8 x 1

1.5 (0.06)	NO	PNP	Pre-cabled (L = 2 m) (1)	XS508BLPAL2	0.035	(0.08)
			M12 connector	XS508BLPAM12	0.025	(0.06)
	NPN	Pre-cabled (L = 2 m) (1)	XS508BLNAL2	0.035	(0.08)	
		M12 connector	XS508BLNAM12	0.025	(0.06)	
	NC	PNP	Pre-cabled (L = 2 m) (1)	XS508BLPBL2	0.035	(0.08)
			M12 connector	XS508BLPBM12	0.025	(0.06)
NPN	Pre-cabled (L = 2 m) (1)	XS508BLNBL2	0.035	(0.08)		
	M12 connector	XS508BLNBM12	0.025	(0.06)		

Ø 12, threaded M12 x 1

2 (0.08)	NO	PNP	Pre-cabled (L = 2 m) (1)	XS512BLPAL2	0.075	(0.17)
			M12 connector	XS512BLPAM12	0.035	(0.08)
	NPN	Pre-cabled (L = 2 m) (1)	XS512BLNAL2	0.075	(0.17)	
		M12 connector	XS512BLNAM12	0.035	(0.08)	
	NC	PNP	Pre-cabled (L = 2 m) (1)	XS512BLPBL2	0.075	(0.17)
			M12 connector	XS512BLPBM12	0.035	(0.08)
NPN	Pre-cabled (L = 2 m) (1)	XS512BLNBL2	0.075	(0.17)		
	M12 connector	XS512BLNBM12	0.035	(0.08)		

Ø 18, threaded M18 x 1

5 (0.20)	NO	PNP	Pre-cabled (L = 2 m) (1)	XS518BLPAL2	0.120	(0.26)
			M12 connector	XS518BLPAM12	0.060	(0.13)
	NPN	Pre-cabled (L = 2 m) (1)	XS518BLNAL2	0.120	(0.26)	
		M12 connector	XS518BLNAM12	0.060	(0.13)	
	NC	PNP	Pre-cabled (L = 2 m) (1)	XS518BLPBL2	0.120	(0.26)
			M12 connector	XS518BLPBM12	0.060	(0.13)
NPN	Pre-cabled (L = 2 m) (1)	XS518BLNBL2	0.120	(0.26)		
	M12 connector	XS518BLNBM12	0.060	(0.13)		

Ø 30, threaded M30 x 1.5

10 (0.39)	NO	PNP	Pre-cabled (L = 2 m) (1)	XS530BLPAL2	0.205	(0.45)
			M12 connector	XS530BLPAM12	0.145	(0.32)
	NPN	Pre-cabled (L = 2 m) (1)	XS530BLNAL2	0.205	(0.45)	
		M12 connector	XS530BLNAM12	0.145	(0.32)	
	NC	PNP	Pre-cabled (L = 2 m) (1)	XS530BLPBL2	0.205	(0.45)
			M12 connector	XS530BLPBM12	0.145	(0.32)
NPN	Pre-cabled (L = 2 m) (1)	XS530BLNBL2	0.205	(0.45)		
	M12 connector	XS530BLNBM12	0.145	(0.32)		

Accessories

Description	For use with sensors	Catalog Number	kg	Weight (lb)
Mounting clamps	Ø 6.5 (plain)	XSZ B165	0.005	(0.01)
	Ø 8	XSZB108	0.006	(0.01)
	Ø 12	XSZB112	0.006	(0.01)
	Ø 18	XSZB118	0.010	(0.02)
	Ø 30	XSZB130	0.020	(0.04)

(1) For a 5 m cable replace L2 with L5; for a 10 m cable replace L2 with L10.
Example: XS508BLPAL2 becomes **XS508BLPAL5** with a 5 m cable.

2

OsiSense® XS

Inductive proximity sensors

General purpose
Cylindrical, standard range, flush mountable
Three-wire DC, solid-state output

2

Specifications			
Sensor type		XS5●●B1●●M8, XS5●●B1●●M12 XS5●●BL●●M8, XS5●●BL●●M12	XS5●●B1●●L2 XS5●●BL●●L2
Product certifications		UL, CSA, CE	
Connection	Connector	M8 on Ø 6.5 and Ø 8, M12 on Ø 8, Ø 12, Ø 18 and Ø 30	–
	Pre-cabled	–	Length 2 m
Operating zone	Ø 6.5 and Ø 8	mm	0–1.2 (0–0.05 in.)
	Ø 12	mm	0–1.6 (0–0.06 in.)
	Ø 18	mm	0–4 (0–0.28 in.)
	Ø 30	mm	0–8 (0–0.31 in.)
Differential travel		%	1–15 of effective sensing distance (Sr)
Degree of protection	Conforming to IEC 60529		IP 65 and IP 67 IP 65 and IP 68, double insulation ☐ (except Ø 6.5 and Ø 8: IP 67)
	Conforming to DIN 40050		IP 69K for Ø 12 to Ø 30
Storage temperature		°C	-40 to +85 (-40 to +185 °F)
Operating temperature		°C	-25 to +70 (-13 to +158 °F)
Materials	Case		Nickel-plated brass (except XS5 06 and XS5 08BL: stainless steel, grade 303)
	Sensing face		PPS
	Cable		– PvR 3 x 0.34 mm ² (22 AWG) except XS506 and XS508 : 3 x 0.11 mm ² (27 AWG)
Vibration resistance	Conforming to IEC 60068-2-6		25 gn, amplitude ± 2 mm (f = 10 to 50 Hz)
Shock resistance	Conforming to IEC 60068-2-27		50 gn, duration 11 ms
Output state indication			Yellow LED: 4 viewing ports at 90° Yellow LED: annular
Rated supply voltage		V	⋮ 12–48 for XS5●●BL, ⋮ 12–24 for XS5●●B1 with protection against reverse polarity
Voltage limits (including ripple)		V	⋮ 10–58 for XS5●●BL, ⋮ 10–36 for XS5●●B1
Switching capacity		mA	≤ 200 with overload and short-circuit protection
Voltage drop, closed state		V	≤ 2
Current consumption, no-load		mA	≤ 10
Maximum switching frequency	XS506, XS508, XS512	Hz	5000
	XS518	Hz	2000
	XS530	Hz	1000
Delays	First-up	ms	≤ 10
	Response	ms	≤ 0.1 : XS506 , XS508 and XS512 ≤ 0.15 : XS518 ≤ 0.3 : XS530
	Recovery	ms	≤ 0.1 : XS506 , XS508 and XS512 ≤ 0.35 : XS518 ≤ 0.7 : XS530

OsiSense® XS

Inductive proximity sensors

General purpose
Cylindrical, standard range, flush mountable
Three-wire DC, solid-state output

Wiring diagrams

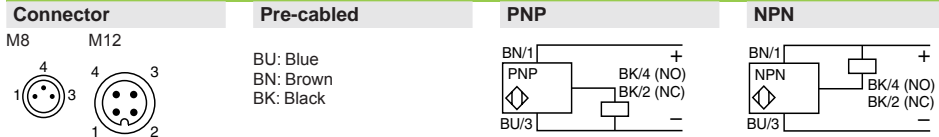

For M8 connector, NO and NC outputs are on terminal 4

Setup

Minimum mounting distances (mm)

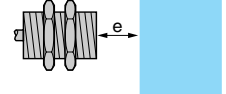
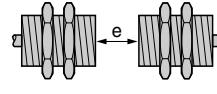
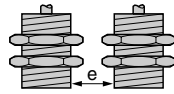

Sensors	Side by side	Face to face	Facing a metal object
Ø 6.5	$e \geq 3$	$e \geq 18$	$e \geq 4.5$
Ø 8	$e \geq 3$	$e \geq 18$	$e \geq 4.5$
Ø 12	$e \geq 4$	$e \geq 24$	$e \geq 6$
Ø 18	$e \geq 10$	$e \geq 60$	$e \geq 15$
Ø 30	$e \geq 20$	$e \geq 120$	$e \geq 30$

Dimensions (mm)

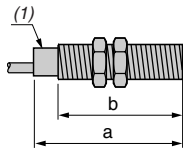

(1) LED

Sensors		Pre-cabled (mm)		M8 connector (mm)		M12 connector (mm)	
		a	b	a	b	a	b
Short case model							
Ø 6.5	XS506B1	33	–	42	–	45	–
Ø 8	XS508B1	33	25	42	26	45	24
Ø 12	XS512B1	35	25	–	–	50	30
Ø 18	XS518B1	39	28	–	–	50	28
Ø 30	XS530B1	43	32	–	–	55	32
Long case model							
Ø 6.5	XS506BL	51	–	–	–	–	–
Ø 8	XS508BL	51	42	62	40	–	–
Ø 12	XS512BL	53	42	62	42	–	–
Ø 18	XS518BL	62	52	74	52	–	–
Ø 30	XS530BL	62	52	74	52	–	–

2

OsiSense® XS

Inductive proximity sensors

General purpose
Cylindrical, standard range, flush mountable
Two-wire DC

2

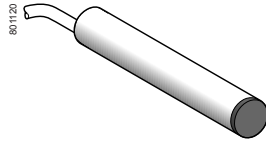

XS506BS●●L2

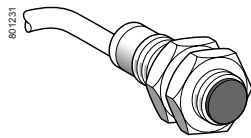

XS512BS●●L2



XS5●●BS●●M12

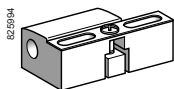

XSZB1●●

Sensors, 2-wire 12-24 V \overline{DC} , short case model

Sensing dist. Sn, mm (in.)	Function	Connection	Catalog Number	Weight kg (lb)
Ø 6.5, plain				
1.5 (0.06)	NO terminals 1 & 4 (2)	Pre-cabled (L = 2 m) (1)	XS506BSCAL2	0.035 (0.08)
		Remote M12 connector	XS506BSCAL01M12	0.050 (0.11)
	NC	Pre-cabled (L = 2 m) (1)	XS506BSCBL2	0.035 (0.08)
Ø 8, threaded M8 x 1				
1.5 (0.06)	NO terminals 1 & 4 (2)	Pre-cabled (L = 2 m) (1)	XS508BSCAL2	0.035 (0.08)
		Remote M12 connector	XS508BSCAL01M12	0.050 (0.11)
	NC	Remote M12 connector	XS508BSCAL08M12	0.050 (0.11)
		Pre-cabled (L = 2 m) (1)	XS508BSCBL2	0.035 (0.08)
		Remote M12 connector	XS508BSCBL01M12	0.050 (0.11)
Ø 12, threaded M12 x 1				
2 (0.08)	NO	Pre-cabled (L = 2 m) (1)	XS512BSDAL2	0.075 (0.17)
		M12 connector	XS512BSDAM12	0.035 (0.08)
	NO terminals 1 & 4 (2)	M12 connector	XS512BSCAM12	0.035 (0.08)
		Remote M12 connector	XS512BSCAL08M12	0.060 (0.13)
	NC	Pre-cabled (L = 2 m) (1)	XS512BSDBL2	0.075 (0.17)
		M12 connector	XS512BSDBM12	0.035 (0.08)
Ø 18, threaded M18 x 1				
5 (0.20)	NO	Pre-cabled (L = 2 m) (1)	XS518BSDAL2	0.120 (0.26)
		M12 connector	XS518BSDAM12	0.060 (0.13)
	NO terminals 1 & 4 (2)	M12 connector	XS518BSCAM12	0.060 (0.13)
		Remote M12 connector	XS518BSCAL08M12	0.085 (0.19)
	NC	Pre-cabled (L = 2 m) (1)	XS518BSDBL2	0.120 (0.26)
		M12 connector	XS518BSDBM12	0.060 (0.13)
Ø 30, threaded M30 x 1.5				
10 (0.39)	NO	Pre-cabled (L = 2 m) (1)	XS530BSDAL2	0.205 (0.45)
		M12 connector	XS530BSDAM12	0.145 (0.32)
	NO terminals 1 & 4 (2)	M12 connector	XS530BSCAM12	0.145 (0.32)
		Remote M12 connector	XS530BSCAL08M12	0.170 (0.37)
	NC	Pre-cabled (L = 2 m) (1)	XS530BSDBL2	0.205 (0.45)
		M12 connector	XS530BSDBM12	0.145 (0.32)
Accessories				
Description	For use with sensors	Catalog Number	Weight kg (lb)	
Mounting clamps	Ø 6.5 (plain)	XSZ B165	0.005 (0.01)	
	Ø 8	XSZB108	0.006 (0.01)	
	Ø 12	XSZB112	0.006 (0.01)	
	Ø 18	XSZB118	0.010 (0.02)	
	Ø 30	XSZB130	0.020 (0.04)	

(1) For a 5 m cable replace L2 with L5; for a 10 m cable replace L2 with L10.
Example: XS508BSCAL2 becomes **XS508BSCAL5** with a 5 m cable.
(2) The NO output is connected to terminals 1 and 4 of the M12 connector.

OsiSense® XS

Inductive proximity sensors

General purpose
Cylindrical, standard range, flush mountable
Two-wire DC

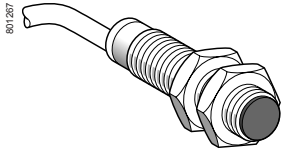

XS500B100L2

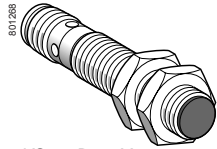

XS500B100M12

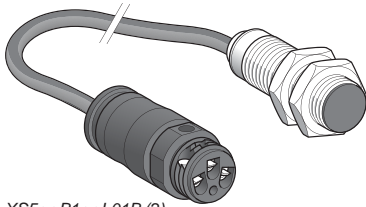

XS500B100L01B (2)

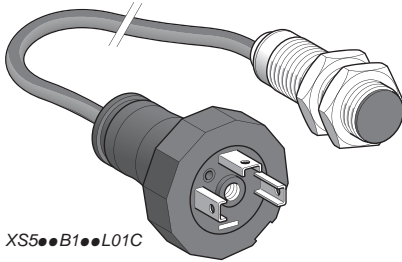

XS500B100L01C

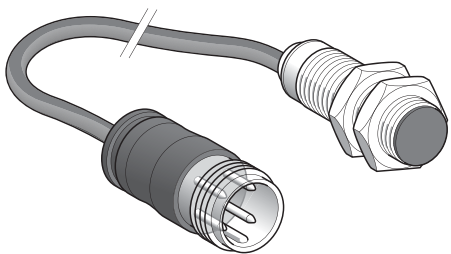

XS500B100L01G

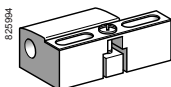

XSZB100

Sensors, 2-wire 12–48 V DC, long case model

Sensing distance Sn, mm (in.)	Function	Connection	Catalog Number	Weight kg (lb)
Ø 8, threaded M8 x 1				
1.5 (0.06)	NO	Pre-cabled (L = 2 m) (1)	XS508B1DAL2	0.035 (0.08)
		Remote M12 connector	XS508B1DAL08M12	0.050 (0.11)
		M12 connector	XS508B1DAM12	0.025 (0.06)
	NO terminals 1 & 4 (3)	M12 connector	XS508B1CAM12	0.025 (0.06)
		Remote M12 connector	XS508B1CAL08M12	0.050 (0.11)
		Pre-cabled (L = 2 m) (1)	XS508B1DBL2	0.035 (0.08)
NC	M12 connector	XS508B1DBM12	0.025 (0.06)	
	Ø 12, threaded M12 x 1			
2 (0.08)	NO	Pre-cabled (L = 2 m) (1)	XS512B1DAL2	0.075 (0.17)
		Remote 7/8" connector	XS512B1DAL08U78	0.050 (0.11)
		M12 connector	XS512B1DAM12	0.035 (0.08)
	NO terminals 1 & 4 (3)	M12 connector	XS512B1CAM12	0.035 (0.08)
		Remote M12 connector	XS512B1CAL08M12	0.060 (0.13)
		Pre-cabled (L = 2 m) (1)	XS512B1DBL2	0.075 (0.17)
NC	M12 connector	XS512B1DBM12	0.035 (0.08)	
	Remote M12 connector	XS512B1DBL08M12	0.060 (0.13)	
Ø 18, threaded M18 x 1				
5 (0.20)	NO	Pre-cabled (L = 2 m) (1)	XS518B1DAL2	0.120 (0.26)
		Low temperature version (-40 °C)	XS518B1DAL2TF (4)	0.120 (0.26)
		Remote screw terminal connector (2)	XS518B1DAL01B	0.085 (0.19)
		Remote DIN 43650A connector	XS518B1DAL01C	0.085 (0.19)
		Remote M18 connector	XS518B1DAL01G	0.085 (0.19)
		M12 connector	XS518B1DAM12	0.060 (0.13)
	NO terminals 1 & 4 (3)	M12 connector	XS518B1CAM12	0.060 (0.13)
		Remote M12 connector	XS518B1CAL08M12	0.085 (0.19)
		Pre-cabled (L = 2 m) (1)	XS518B1DBL2	0.120 (0.26)
	NC	M12 connector	XS518B1DBM12	0.060 (0.13)
		Remote M12 connector	XS518B1DBL08M12	0.085 (0.19)
		Remote screw terminal connector (2)	XS518B1DBL01B	0.120 (0.26)
Ø 30, threaded M30 x 1.5				
10 (0.39)	NO	Pre-cabled (L = 2 m) (1)	XS530B1DAL2	0.205 (0.45)
		Low temperature version (-40 °C)	XS530B1DAL2TF (4)	0.120 (0.26)
		M12 connector	XS530B1DAM12	0.145 (0.32)
		Remote screw terminal connector (2)	XS530B1DAL01B	0.205 (0.45)
		Remote DIN 43650A connector	XS530B1DAL01C	0.205 (0.45)
		Remote M18 connector	XS530B1DAL01G	0.205 (0.45)
	NO terminals 1 & 4 (3)	M12 connector	XS530B1CAM12	0.145 (0.32)
		Remote M12 connector	XS530B1CAL08M12	0.170 (0.37)
		Pre-cabled (L = 2 m) (1)	XS530B1DBL2	0.205 (0.45)
	NC	M12 connector	XS530B1DBM12	0.145 (0.32)
		Remote screw terminal connector (2)	XS530B1DBL01B	0.205 (0.37)
		Accessories		
Description	For use with sensors	Catalog Number	Weight kg (lb)	
Mounting clamps	Ø 8	XSZB108	0.006 (0.01)	
	Ø 12	XSZB112	0.006 (0.01)	
	Ø 18	XSZB118	0.010 (0.02)	
	Ø 30	XSZB130	0.020 (0.04)	

(1) For a 5 m cable replace L2 with L5; for a 10 m cable replace L2 with L10.
Example: XS508B1DAL2 becomes **XS508B1DAL5** with a 5 m cable.

(2) Protective cable gland included with remote screw terminal connector.

(3) The NO output is connected to terminals 1 and 4 of the M12 connector.

(4) For a 5 m cable replace L2 with L5.
Example: XS518B1DAL2TF becomes **XS518B1DAL5TF** with a 5 m cable.
For PUR cable, replace the letter L in the catalog number with P.
Example: XS518B1DAL2TF becomes **XS518B1DAP2TF** with PUR cable.
For a 5 m PUR cable replace P2 with P5.
Example: XS518B1DAP2TF becomes **XS518B1DAP5TF** with a 5 m PUR cable.

2

OsiSense® XS

Inductive proximity sensors

General purpose
Cylindrical, standard range, flush mountable
Two-wire DC

2

Specifications			
Sensor type		XS5●●B1●●M12, XS5●●BS●●M12	XS5●●B1D●L2, XS5●●BSD●L2
Product certifications			
Connection		UL, CSA, CE	
	Connector	M12	–
	Pre-cabled	–	Length 2 m
	Remote connector	Remote M12 connector (L01M12), screw terminal (L01B), DIN 43650A (L01C) and remote M18 connector (L01G) on 0.15 m pigtail connector. Remote M12 (L08M12) or 7/8" (L08U78) connector on 0.80 m pigtail connector.	
Operating zone			
	Ø 6.5	mm	0–1.2 (0–0.05 in.)
	Ø 8	mm	0–1.2 (0–0.05 in.)
	Ø 12	mm	0–1.6 (0–0.06 in.)
	Ø 18	mm	0–4 (0–0.16 in.)
	Ø 30	mm	0–8 (0–0.31 in.)
Differential travel		%	1–15 of effective sensing distance (Sr)
Degree of protection		Conforming to IEC 60529	IP 65 and IP 67 IP 65 and IP 68, double insulation (except Ø 6.5 and Ø 8: IP 67)
Storage temperature		°C	–40 to +85 (–40 to +185 °F)
Operating temperature		°C	–5 to +70 (–13 to +158 °F); TF products: –40 to +70 (–40 to +158 °F)
Materials			
	Case	Nickel-plated brass (except XS5 06 and XS5 08B1: stainless steel, grade 303)	
	Sensing face	PPS	
	Cable	–	PvR 2 x 0.34 mm ² (22 AWG) (except XS5 06 and XS5 08: 2 x 0.11 mm ² (27 AWG) PUR available (1))
Vibration resistance		Conforming to IEC 60068-2-6	25 gn, amplitude ± 2 mm (f = 10 to 55 Hz)
Shock resistance		Conforming to IEC 60068-2-27	50 gn, duration 11 ms
Output state indication			Yellow LED: 4 viewing ports at 90° Yellow LED: annular
Rated supply voltage		V	⋯ 12–48 non-polarized for XS5●●B1D, ⋯ 12–24 non-polarized for XS5●●BS (except Ø 6.5 and Ø 8 short case models: polarized) with protection against reverse polarity
Voltage limits (including ripple)		V	⋯ 10–58 for XS5●●B1D, ⋯ 10–36 for XS5●●BS
Switching capacity		mA	1.5–100 with overload and short-circuit protection
Voltage drop, closed state		V	≤ 4
Residual current, open state		mA	≤ 0.5
Maximum switching frequency		Hz	4000
	XS506, XS508, XS512	Hz	3000
	XS518	Hz	2000
	XS530	Hz	2000
Delays			
	First-up	ms	≤ 10
	Response	ms	≤ 0.2 : XS506, XS508 and XS512 ≤ 0.15 : XS518 ≤ 0.3 : XS530
	Recovery	ms	≤ 0.2 (except XS530B1: ≤ 0.3)

(1) For PUR cable, replace the letter L in the catalog number with P. Example: XS506BSDAL2 becomes XS506BSDAP2 with PUR cable.

OsiSense® XS

Inductive proximity sensors

General purpose
Cylindrical, standard range, flush mountable
Two-wire DC

Wiring diagrams

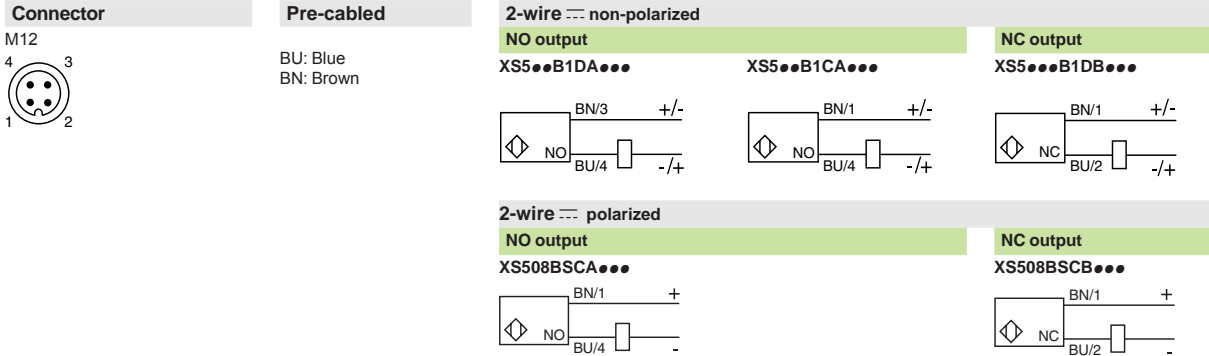

2

Remote connectors LO1B, LO1C, LO1G

Screw terminal (LO1B)

The terminal numbering differs according to the version (--- 2-wire, --- 3-wire, ≈ 2-wire).

DIN 43650 A (LO1C)

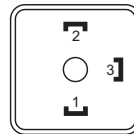

M18 (LO1G)

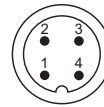

The NO or NC outputs are connected to terminal 2.

Setup

Minimum mounting distances (mm)

	Side by side	Face to face	Facing a metal object
Ø 6.5	e ≥ 3	e ≥ 18	e ≥ 4.5
Ø 8	e ≥ 3	e ≥ 18	e ≥ 4.5
Ø 12	e ≥ 4	e ≥ 24	e ≥ 6
Ø 18	e ≥ 10	e ≥ 60	e ≥ 15
Ø 30	e ≥ 20	e ≥ 120	e ≥ 30

Dimensions (mm)

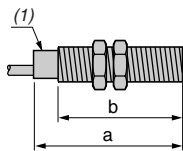

(1) LED

Sensors	Short case model	Pre-cabled (mm)		M8 connector (mm)		M12 connector (mm)	
		a	b	a	b	a	b
Ø 6.5	XS506BS	33	–	42	–	45	–
Ø 8	XS508BS	33	25	42	26	45	24
Ø 12	XS512BS	35	25	–	–	50	30
Ø 18	XS518BS	39	28	–	–	50	28
Ø 30	XS530BS	43	32	–	–	55	32

Sensors	Long case model	Pre-cabled (mm)		M12 connector (mm)	
		a	b	a	b
Ø 8	XS508B1	51	42	62	40
Ø 12	XS512B1	53	42	62	42
Ø 18	XS518B1	62	52	74	52
Ø 30	XS530B1	62	52	74	52

OsiSense® XS

Inductive proximity sensors

General purpose

Cylindrical, semi-flush mountable, increased range

Three-wire DC, solid-state output

Sensing distance Sn, mm (in.)	Function	Output	Connection	Catalog Number	Weight	
					kg	(lb)
Ø 6.5, plain						
2.5 (0.10)	NO	PNP	Pre-cabled (L = 2 m)	XS1L06PA349	0.025	(0.06)
			M8 connector	XS1L06PA349S	0.010	(0.02)
			M12 connector	XS1L06PA349D	0.015	(0.03)
		NPN	Pre-cabled (L = 2 m)	XS1L06NA349	0.025	(0.06)
			M8 connector	XS1L06NA349S	0.010	(0.02)
			M12 connector	XS1L06NA349D	0.015	(0.03)
	NC	PNP	Pre-cabled (L = 2 m)	XS1L06PB349	0.025	(0.06)
			M8 connector	XS1L06PB349S	0.010	(0.02)
			M12 connector	XS1L06PB349D	0.015	(0.03)
		NPN	Pre-cabled (L = 2 m)	XS1L06NB349	0.025	(0.06)
			M8 connector	XS1L06NB349S	0.010	(0.02)
			M12 connector	XS1L06NB349D	0.015	(0.03)

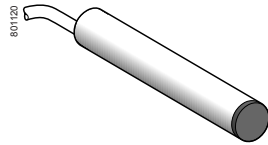

XS1L06●A349

Ø 8, threaded M8 x 1						
2.5 (0.10)	NO	PNP	Pre-cabled (L = 2 m)	XS1N08PA349	0.035	(0.08)
			M8 connector	XS1N08PA349S	0.015	(0.03)
			M12 connector	XS1N08PA349D	0.020	(0.04)
		NPN	Pre-cabled (L = 2 m)	XS1N08NA349	0.035	(0.08)
			M8 connector	XS1N08NA349S	0.015	(0.03)
			M12 connector	XS1N08NA349D	0.020	(0.04)
	NC	PNP	Pre-cabled (L = 2 m)	XS1N08PB349	0.035	(0.08)
			M8 connector	XS1N08PB349S	0.015	(0.03)
			M12 connector	XS1N08PB349D	0.020	(0.04)
		NPN	Pre-cabled (L = 2 m)	XS1N08NB349	0.035	(0.08)
			M8 connector	XS1N08NB349S	0.015	(0.03)
			M12 connector	XS1N08NB349D	0.020	(0.04)

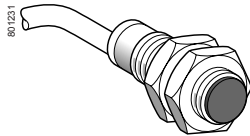

XS1N●●●●349

Ø 12, threaded M12 x 1						
4 (0.16)	NO	PNP	Pre-cabled (L = 2 m)	XS1N12PA349	0.070	(0.15)
			M12 connector	XS1N12PA349D	0.020	(0.04)
			M12 connector	XS1N12PA349D	0.020	(0.04)
		NPN	Pre-cabled (L = 2 m)	XS1N12NA349	0.070	(0.15)
			M12 connector	XS1N12NA349S	0.020	(0.04)
			M12 connector	XS1N12NA349D	0.020	(0.04)
	NC	PNP	Pre-cabled (L = 2 m)	XS1N12PB349	0.070	(0.15)
			M12 connector	XS1N12PB349D	0.020	(0.04)
			M12 connector	XS1N12PB349D	0.020	(0.04)
		NPN	Pre-cabled (L = 2 m)	XS1N12NB349	0.070	(0.15)
			M12 connector	XS1N12NB349S	0.020	(0.04)
			M12 connector	XS1N12NB349D	0.020	(0.04)

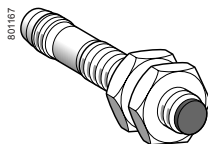

XS1N08●●349S

Ø 18, threaded M18 x 1						
10 (0.39)	NO	PNP	Pre-cabled (L = 2 m)	XS1N18PA349	0.100	(0.22)
			M12 connector	XS1N18PA349D	0.040	(0.09)
			M12 connector	XS1N18PA349D	0.040	(0.09)
		NPN	Pre-cabled (L = 2 m)	XS1N18NA349	0.100	(0.22)
			M12 connector	XS1N18NA349S	0.040	(0.09)
			M12 connector	XS1N18NA349D	0.040	(0.09)
	NC	PNP	Pre-cabled (L = 2 m)	XS1N18PB349	0.100	(0.22)
			M12 connector	XS1N18PB349D	0.040	(0.09)
			M12 connector	XS1N18PB349D	0.040	(0.09)
		NPN	Pre-cabled (L = 2 m)	XS1N18NB349	0.100	(0.22)
			M12 connector	XS1N18NB349S	0.040	(0.09)
			M12 connector	XS1N18NB349D	0.040	(0.09)



XS1N●●●●349D

Ø 30, threaded M30 x 1.5						
20 (0.79)	NO	PNP	Pre-cabled (L = 2 m)	XS1N30PA349	0.160	(0.35)
			M12 connector	XS1N30PA349D	0.100	(0.22)
			M12 connector	XS1N30PA349D	0.100	(0.22)
		NPN	Pre-cabled (L = 2 m)	XS1N30NA349	0.160	(0.35)
			M12 connector	XS1N30NA349S	0.100	(0.22)
			M12 connector	XS1N30NA349D	0.100	(0.22)
	NC	PNP	Pre-cabled (L = 2 m)	XS1N30PB349	0.160	(0.35)
			M12 connector	XS1N30PB349D	0.100	(0.22)
			M12 connector	XS1N30PB349D	0.100	(0.22)
		NPN	Pre-cabled (L = 2 m)	XS1N30NB349	0.160	(0.35)
			M12 connector	XS1N30NB349S	0.100	(0.22)
			M12 connector	XS1N30NB349D	0.100	(0.22)

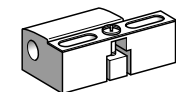

XSZB1●●

Accessories						
Description				Catalog Number	Weight	
mm					kg	(lb)
Mounting clamps	Ø 6.5 (plain)			XSZB165	0.005	(0.01)
	Ø 8			XSZB108	0.006	(0.01)
	Ø 12			XSZB112	0.006	(0.01)
	Ø 18			XSZB118	0.010	(0.02)
	Ø 30			XSZB130	0.020	(0.04)

Specifications			
Sensor type		XS1●●●●●349D	XS1●●●●●349S
Product certifications		UL, CSA, CE	
Connection		M12 connector	Pre-cabled, length: 2 m
Operating zone	Ø 6.5 and Ø 8	mm	0-2 (0-0.08 in.)
	Ø 12	mm	0-3.2 (0-0.13 in.)
	Ø 18	mm	0-8 (0-0.31 in.)
	Ø 30	mm	0-16 (0-0.63 in.)
Differential travel		%	
Degree of protection		1-15 of effective sensing distance (Sr)	
Degree of protection	Conforming to IEC 60529	IP 67	
	Conforming to DIN 40050	IP 68, double insulation (except Ø 6.5 and Ø 8: IP 67)	
Storage temperature		°C	
Operating temperature		°C	
Materials	Case	Nickel-plated brass	
	Cable	-	
Vibration resistance		25 gn, amplitude ± 2 mm (f = 10 to 55 Hz)	
Shock resistance		50 gn, duration 11 ms	
Output state indication		Yellow LED, 4 viewing ports at 90°	
Rated supply voltage		V	
Voltage limits (including ripple)		V	
Switching capacity		mA	
Voltage drop, closed state		V	
Current consumption, no-load		mA	
Maximum switching frequency	Ø 6.5, Ø 8 and Ø 12	Hz	2500
	Ø 18	Hz	1000
	Ø 30	Hz	500
Delays	First-up	ms	≤ 5
	Response	ms	≤ 0.2 for Ø 8 and Ø 12, ≤ 0.3 for Ø 18, ≤ 0.6 for Ø 30
	Recovery	ms	≤ 0.2 for Ø 8 and Ø 12, ≤ 0.7 for Ø 18, ≤ 1.4 for Ø 30

Wiring diagrams

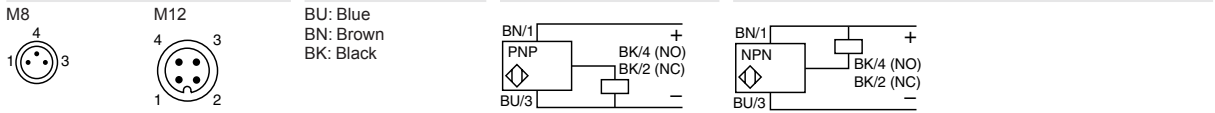

For M8 connector, NO and NC outputs are on terminal 4

Setup

Sensor	Minimum mounting distances (mm)			
	Side by side	Face to face	Facing a metal object	Mounted in a metal support
Ø 6.5	e ≥ 5	e ≥ 30	e ≥ 7.5	d ≥ 10 h ≥ 1.6
Ø 8	e ≥ 5	e ≥ 30	e ≥ 7.5	d ≥ 10 h ≥ 1.6
Ø 12	e ≥ 8	e ≥ 48	e ≥ 12	d ≥ 14 h ≥ 2.4
Ø 18	e ≥ 20	e ≥ 96	e ≥ 30	d ≥ 28 h ≥ 3.6
Ø 30	e ≥ 40	e ≥ 240	e ≥ 60	d ≥ 50 h ≥ 6

Dimensions (mm)

Sensor	Flush mountable in metal					
	Pre-cabled		M8 connector		M12 connector	
	a	b	a	b	a	b
Ø 6.5	33	30	42	34	45	24
Ø 8	33	25	42	26	45	23
Ø 12	35	24.6	-	-	50	30
Ø 18	38.5	27.5	-	-	50	27.5
Ø 30	42.6	31.6	-	-	54.3	31.6

OsiSense® XS

Inductive proximity sensors

General purpose

Multi-voltage sensor, cylindrical, flush mountable and non-flush mountable

Two-wire AC or DC, short-circuit protection

Sensing distance Sn, mm (in.)	Function	Connection	Catalog Number	Weight	
				kg	(lb)

Ø 12, threaded M12 x 1

Flush mountable

2 (0.08)	NO	Pre-cabled (L = 2 m) (1) 1/2"-20UNF connector	XS1M12MA250	0.075	(0.17)
			XS1M12MA250K	0.025	(0.06)
	NC	Pre-cabled (L = 2 m) (1) 1/2"-20UNF connector	XS1M12MB250	0.075	(0.17)
			XS1M12MB250K	0.025	(0.06)

Non-flush mountable

4 (0.16)	NO	Pre-cabled (L = 2 m) (1) 1/2"-20UNF connector	XS2M12MA250	0.075	(0.17)
			XS2M12MA250K	0.025	(0.06)
	NC	Pre-cabled (L = 2 m) (1)	XS2M12MB250	0.075	(0.17)

Ø 18, threaded M18 x 1

Flush mountable

5 (0.20)	NO	Pre-cabled (L = 2 m) (1) 1/2"-20UNF connector	XS1M18MA250	0.120	(0.26)
			XS1M18MA250K	0.060	(0.13)
	NC	Pre-cabled (L = 2 m) (1) 1/2"-20UNF connector	XS1M18MB250	0.120	(0.26)
			XS1M18MB250K	0.060	(0.13)

Non-flush mountable

8 (0.31)	NO	Pre-cabled (L = 2 m) (1) 1/2"-20UNF connector	XS2M18MA250	0.120	(0.26)
			XS2M18MA250K	0.060	(0.13)
	NC	Pre-cabled (L = 2 m) (1) 1/2"-20UNF connector	XS2M18MB250	0.120	(0.26)
			XS2M18MB250K	0.060	(0.13)

Ø 30, threaded M30 x 1.5

Flush mountable

10 (0.39)	NO	Pre-cabled (L = 2 m) (1) 1/2"-20UNF connector	XS1M30MA250	0.205	(0.45)
			XS1M30MA250K	0.145	(0.32)
	NC	Pre-cabled (L = 2 m) (1) 1/2"-20UNF connector	XS1M30MB250	0.205	(0.45)
			XS1M30MB250K	0.145	(0.32)

Non-flush mountable

15 (0.59)	NO	Pre-cabled (L = 2 m) (1) 1/2"-20UNF connector	XS2M30MA250	0.205	(0.45)
			XS2M30MA250K	0.145	(0.32)
	NC	Pre-cabled (L = 2 m) (1) 1/2"-20UNF connector	XS2M30MB250	0.205	(0.45)
			XS2M30MB250K	0.145	(0.32)

Accessories

Description mm		Catalog Number	Weight	
			kg	(lb)
Mounting clamps	Ø 12	XSZB112	0.006	(0.01)
	Ø 18	XSZB118	0.010	(0.02)
	Ø 30	XSZB130	0.020	(0.04)

(1) For a 5 m cable add L1 to the catalog number; for a 10 m cable add L2. Example: **XS1M18MA250** becomes **XS1M18MA250L1** with a 5 m cable.

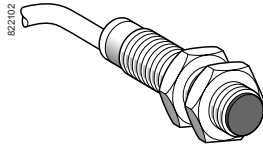

XS1M●●●●250

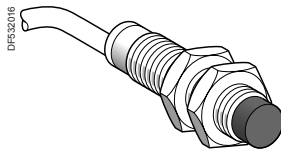

XS2M●●●●250

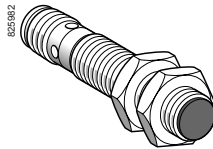

XS1M●●●●250K

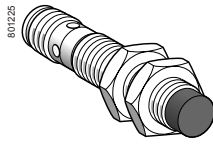

XS2M●●●●250K

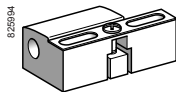

XSZB1●●

2

OsiSense® XS

Inductive proximity sensors

General purpose

Multi-voltage sensor, cylindrical, flush mountable and non-flush mountable

Two-wire AC or DC, short-circuit protection

2

Specifications		XS●M●●M●250K	XS●M●●M●250
Sensor type		UL, CSA, CE	
Product certifications		1/2"-20UNF connector	
Connection		Pre-cabled, length: 2 m	
Operating zone	Ø 12 flush mountable	mm	0-1.6 (0-0.06 in.)
	Ø 12 non-flush mountable	mm	0-3.2 (0-0.13 in.)
	Ø 18 flush mountable	mm	0-4 (0-0.16 in.)
	Ø 18 non-flush mountable	mm	0-6.4 (0-0.25 in.)
	Ø 30 flush mountable	mm	0-8 (0-0.31 in.)
	Ø 30 non-flush mountable	mm	0-12 (0-0.47 in.)
Differential travel		%	1-15 of effective sensing distance (Sr)
Degree of protection		Conforming to IEC 60529	IP 67
Storage temperature		°C	-40 to +85 (-40 to +185 °F)
Operating temperature		°C	-25 to +70 (-13 to +158 °F)
Materials		Case	Nickel-plated brass
		Cable	PvR 2 x 0.34 mm ² (22 AWG)
Vibration resistance		Conforming to IEC 60068-2-6	25 gn, amplitude ± 2 mm (f = 10 to 55 Hz)
Shock resistance		Conforming to IEC 60068-2-27	50 gn, duration 11 ms
Indicators		Output state	Yellow LED, 4 viewing ports at 90°
		Supply on	Yellow LED Green LED (only on Ø 18 and Ø 30)
Rated supply voltage		V	~ 24-240 (50/60 Hz) or ~ 24-210
Voltage limits (including ripple)		V	~ or ~ 20-264
Switching capacity		mA	~ 5-300 or ~ 5-200 (except Ø 12: ~ or ~ 5-200) with overload and short-circuit protection
Voltage drop, closed state		V	≤ 5.5
Current consumption, no-load		mA	-
Residual current, open state		mA	≤ 1.5
Maximum switching frequency		Ø 12	Hz ~ 25 or ~ 4000
		Ø 18	Hz ~ 25 or ~ 2000
		Ø 30 flush mountable	Hz ~ 25 or ~ 2000
		Ø 30 non-flush mountable	Hz ~ 25 or ~ 1000
Delays		First-up	ms ≤ 70
		Response	ms ≤ 0.2 for Ø 12, ≤ 2 for Ø 18 and Ø 30
		Recovery	ms ≤ 0.2 for Ø 12, ≤ 4 for Ø 18, ≤ 5 for Ø 30 flush mountable, ≤ 10 for Ø 30 non-flush mountable

Wiring diagrams

1/2"-20UNF connector

Pre-cabled

BU: Blue
BN: Brown

2-wire ~ or ~

NO or NC output

± : on connector models only.

Setup

Sensor	Minimum mounting distances (mm)			
	Side by side	Face to face	Facing a metal object	Mounted in a metal support
Ø 12 flush mountable	e ≥ 4	e ≥ 24	e ≥ 6	d ≥ 12 h ≥ 0
Ø 12 non-flush mountable	e ≥ 16	e ≥ 48	e ≥ 12	d ≥ 36 h ≥ 8
Ø 18 flush mountable	e ≥ 10	e ≥ 60	e ≥ 15	d ≥ 18 h ≥ 0
Ø 18 non-flush mountable	e ≥ 16	e ≥ 96	e ≥ 24	d ≥ 54 h ≥ 16
Ø 30 flush mountable	e ≥ 20	e ≥ 120	e ≥ 30	d ≥ 30 h ≥ 0
Ø 30 non-flush mountable	e ≥ 60	e ≥ 180	e ≥ 45	d ≥ 90 h ≥ 30

Dimensions (mm)

Sensor	Flush mountable in metal				Non-flush mountable in metal				
	Pre-cabled		Connector		Pre-cabled		c		
	a	b	a	b	a	b			
Ø 12	55	47	66	48	54.6	42	65.6	42	5
Ø 18	60	51	72	51	60	44	72	44	8
Ø 30	60	51	72	51	62.6	41	74.7	41	13

OsiSense® XS

Inductive proximity sensors

General purpose

Cylindrical, metal and plastic, flush mountable and non-flush mountable, 4-wire DC, solid-state NO + NC output

Sensing distance Sn, mm (in.)	Function	Output	Connection	Catalog Number	Weight	
					kg	(lb)

Ø 6.5 plain

Stainless steel case, flush mountable

1.5 (0.06)	NO + NC	PNP	Pre-cabled (L = 2 m) (1)	XS1L06PC410	0.025	(0.06)
		NPN	Pre-cabled (L = 2 m) (1)	XS1L06NC410	0.025	(0.06)

Ø 8, threaded M8 x 1

Stainless steel case, flush mountable

1.5 (0.06)	NO + NC	PNP	Pre-cabled (L = 2 m)	XS1M08PC410	0.035	(0.08)
			M12 connector	XS1M08PC410D	0.025	(0.06)
		NPN	Pre-cabled (L = 2 m)	XS1M08NC410	0.035	(0.08)
			M12 connector	XS1M08NC410D	0.025	(0.06)

Stainless steel case, non-flush mountable

2.5 (0.10)	NO + NC	PNP	Pre-cabled (L = 2 m)	XS2M08PC410	0.035	(0.08)
			M12 connector	XS2M08PC410D	0.025	(0.06)
		NPN	Pre-cabled (L = 2 m)	XS2M08NC410	0.035	(0.08)
			M12 connector	XS2M08NC410D	0.025	(0.06)

Ø 12, threaded M12 x 1

Brass case, flush mountable

2 (0.08)	NO + NC	PNP	Pre-cabled (L = 2 m) (1)	XS1N12PC410	0.070	(0.15)
			M12 connector	XS1N12PC410D	0.020	(0.04)
		NPN	Pre-cabled (L = 2 m) (1)	XS1N12NC410	0.070	(0.15)
			M12 connector	XS1N12NC410D	0.020	(0.04)

Brass case, non-flush mountable (2)

4 (0.16)	NO + NC	PNP	Pre-cabled (L = 2 m) (1)	XS2N12PC410	0.070	(0.15)
			M12 connector	XS2N12PC410D	0.020	(0.04)
		NPN	Pre-cabled (L = 2 m) (1)	XS2N12NC410	0.070	(0.15)
			M12 connector	XS2N12NC410D	0.020	(0.04)

Ø 18, threaded M18 x 1

Brass case, flush mountable

5 (0.20)	NO + NC	PNP	Pre-cabled (L = 2 m) (1)	XS1N18PC410	0.100	(0.22)
			M12 connector	XS1N18PC410D	0.040	(0.09)
		NPN	Pre-cabled (L = 2 m) (1)	XS1N18NC410	0.100	(0.22)
			M12 connector	XS1N18NC410D	0.040	(0.09)

Brass case, non-flush mountable (2)

8 (0.31)	NO + NC	PNP	Pre-cabled (L = 2 m) (1)	XS2N18PC410	0.100	(0.22)
			M12 connector	XS2N18PC410D	0.040	(0.09)
		NPN	Pre-cabled (L = 2 m) (1)	XS2N18NC410	0.100	(0.22)
			M12 connector	XS2N18NC410D	0.040	(0.09)

Ø 30, threaded M30 x 1.5

Brass case, flush mountable

10 (0.39)	NO + NC	PNP	Pre-cabled (L = 2 m) (1)	XS1N30PC410	0.160	(0.35)
			M12 connector	XS1N30PC410D	0.100	(0.22)
		NPN	Pre-cabled (L = 2 m) (1)	XS1N30NC410	0.160	(0.35)
			M12 connector	XS1N30NC410D	0.100	(0.22)

Brass case, non-flush mountable (2)

15 (0.59)	NO + NC	PNP	Pre-cabled (L = 2 m) (1)	XS2N30PC410	0.160	(0.35)
			M12 connector	XS2N30PC410D	0.100	(0.22)
		NPN	Pre-cabled (L = 2 m) (1)	XS2N30NC410	0.160	(0.35)
			M12 connector	XS2N30NC410D	0.100	(0.22)

Accessories

Description mm		Catalog Number	Weight	
			kg	(lb)
Mounting clamps	Ø 8	XSZB108	0.006	(0.01)
	Ø 12	XSZB112	0.006	(0.01)
	Ø 18	XSZB118	0.010	(0.02)
	Ø 30	XSZB130	0.020	(0.04)

(1) For a 5 m cable add L1 to the catalog number; for a 10 m cable add L2. Example: **XS1N12PC410** becomes **XS1N12PC410L1** with a 5 m cable.

(2) For a non-flush mountable sensor with a plastic case, replace 2N by 4P in the catalog number. Example: **XS2N12PC410** becomes **XS4P12PC410** with a plastic case.

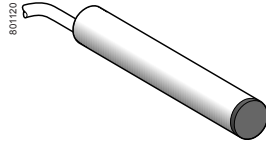

XS1L06●C410

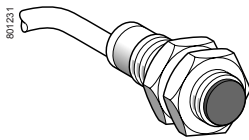

XS1●●●●C410

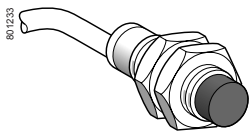

XS2●●●●C410



XS1N●●●C410D

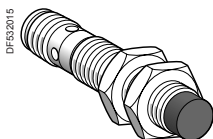

XS2N●●●C410D

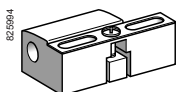

XSZB1●●

2

OsiSense® XS

Inductive proximity sensors

General purpose
Cylindrical, metal and plastic, flush mountable and non-flush mountable, 4-wire DC, solid-state NO + NC output

2

Specifications			
Sensor type		XS●●●●C410D	XS●●●●C410
Product certifications		UL, CSA, CE	
Connection		M12 connector	Pre-cabled, length: 2 m
Operating zone	Ø 6.5 and Ø 8 flush mtble	mm	0–1.2 (0–0.05 in.)
	Ø 8 non-flush mountable	mm	0–2 (0–0.08 in.)
	Ø 12 flush mountable	mm	0–1.6 (0–0.06 in.)
	Ø 12 non-flush mountable	mm	0–3.2 (0–0.13 in.)
	Ø 18 flush mountable	mm	0–4 (0–0.16 in.)
	Ø 18 non-flush mountable	mm	0–6.4 (0–0.25 in.)
	Ø 30 flush mountable	mm	0–8 (0–0.31 in.)
	Ø 30 non-flush mountable	mm	0–12 (0–0.47 in.)
Differential travel		%	
Degree of protection		Conforming to IEC 60529	
Storage temperature		°C	
Operating temperature		°C	
Materials	Case	Nickel-plated brass for XS1N and XS2N Stainless steel, grade 303, for XS1L06, XS1M08 and XS2M08 Plastic, PPS, for XS4 P	
	Cable	–	
Vibration resistance		Conforming to IEC 60068-2-6	
Shock resistance		Conforming to IEC 60068-2-27	
Output state indication		Yellow LED, 4 viewing ports at 90°	
Rated supply voltage		V	
Voltage limits (including ripple)		V	
Switching capacity		mA	
Voltage drop, closed state		V	
Current consumption, no-load		mA	
Maximum switching frequency	Ø 6.5, Ø 8 and Ø 12	Hz	
	Ø 18	Hz	
	Ø 30	Hz	
Delays	First-up	ms	
	Response	ms	
	Recovery	ms	

Wiring diagrams			
M12 connector	Pre-cabled	PNP 4-wire	NPN 4-wire
	BU: Blue BN: Brown BK: Black WH: White		

Setup				
Sensor	Minimum mounting distances (mm)			
	Side by side	Face to face	Facing a metal object	Mounted in a metal support
Ø 6.5 flush mountable XS1L06	e ≥ 3	e ≥ 18	e ≥ 4.5	d ≥ 6.5 h ≥ 0
Ø 8 flush mountable XS1M08	e ≥ 3	e ≥ 18	e ≥ 4.5	d ≥ 8 h ≥ 0
Ø 8 non-flush mountable XS2M08	e ≥ 10	e ≥ 30	e ≥ 7.5	d ≥ 24 h ≥ 5
Ø 12 flush mountable XS1N12	e ≥ 4	e ≥ 24	e ≥ 6	d ≥ 12 h ≥ 0
Ø 12 non-flush mtble XS1N12 or XS4P12	e ≥ 16	e ≥ 48	e ≥ 12	d ≥ 36 h ≥ 8
Ø 18 flush mountable XS1N18	e ≥ 10	e ≥ 60	e ≥ 15	d ≥ 18 h ≥ 0
Ø 18 non-flush mtble XS2N18 or XS4P18	e ≥ 16	e ≥ 96	e ≥ 24	d ≥ 54 h ≥ 16
Ø 30 flush mountable XS1N30	e ≥ 20	e ≥ 120	e ≥ 30	d ≥ 30 h ≥ 0
Ø 30 non-flush mtble XS2N30 or XS4P30	e ≥ 60	e ≥ 180	e ≥ 45	d ≥ 90 h ≥ 30

Dimensions (mm)							
Sensor	Flush mountable in metal				Non-flush mountable in metal		
	Pre-cabled		Connector		Pre-cabled		Connector
	a	b	a	b	a	b	c
Ø 6.5 metal	50	47	–	–	–	–	–
Ø 8 metal	50	42	61	42	50	36	4
Ø 12 metal	33	25	48	29	37.6	25	5
Ø 12 plastic	–	–	–	–	33	25	0
Ø 18 metal	36.5	28	48.6	28	36.5	20	8
Ø 18 plastic	–	–	–	–	33.5	26	0
Ø 30 metal	40.6	32	52.7	32	40.5	19	13
Ø 30 plastic	–	–	–	–	40.5	33	0

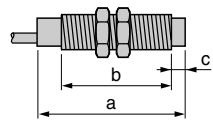

OsiSense® XS

Inductive proximity sensors

General purpose

Cylindrical, metal and plastic, flush and non-flush mountable, 4-wire DC, solid-state PNP + NPN NO/NC programmable output

2

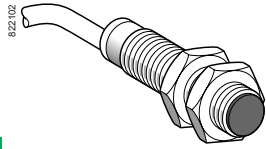

XS1M●●KP340
XS4P●●KP340

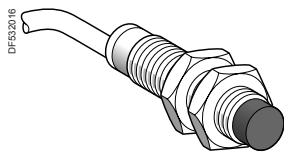

XS2M●●KP340

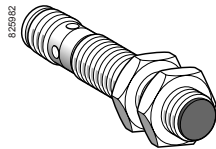

XS1M●●KP340D
XS4P●●KP340D

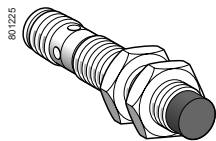

XS2M●●KP340D

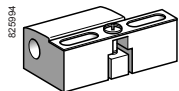

XSZB1●●

Sensing distance Sn, mm (in.)	Function	Output	Connection	Catalog Number	Weight	
					kg	(lb)

Ø 12, threaded M12 x 1

Metal case, flush mountable

2 (0.08)	NO/NC programmable	PNP + NPN	Pre-cabled (L = 2 m) (1)	XS1M12KP340	0.075	(0.17)
			M12 connector	XS1M12KP340D	0.025	(0.06)

Metal case, non-flush mountable

4 (0.16)	NO/NC programmable	PNP + NPN	Pre-cabled (L = 2 m) (1)	XS2M12KP340	0.075	(0.17)
			M12 connector	XS2M12KP340D	0.025	(0.06)

Plastic case, non-flush mountable

4 (0.16)	NO/NC programmable	PNP + NPN	Pre-cabled (L = 2 m) (1)	XS4P12KP340	0.075	(0.17)
			M12 connector	XS4P12KP340D	0.025	(0.06)

Ø 18, threaded M18 x 1

Metal case, flush mountable

5 (0.20)	NO/NC programmable	PNP + NPN	Pre-cabled (L = 2 m) (1)	XS1M18KP340	0.120	(0.12)
			M12 connector	XS1M18KP340D	0.060	(0.13)

Metal case, non-flush mountable

8 (0.31)	NO/NC programmable	PNP + NPN	Pre-cabled (L = 2 m) (1)	XS2M18KP340	0.120	(0.12)
			M12 connector	XS2M18KP340D	0.060	(0.13)

Plastic case, non-flush mountable

8 (0.31)	NO/NC programmable	PNP + NPN	Pre-cabled (L = 2 m) (1)	XS4P18KP340	0.120	(0.12)
			M12 connector	XS4P18KP340D	0.060	(0.13)

Ø 30, threaded M30 x 1.5

Metal case, flush mountable

10 (0.39)	NO/NC programmable	PNP + NPN	Pre-cabled (L = 2 m) (1)	XS1M30KP340	0.205	(0.45)
			M12 connector	XS1M30KP340D	0.145	(0.32)

Metal case, non-flush mountable

15 (0.59)	NO/NC programmable	PNP + NPN	Pre-cabled (L = 2 m) (1)	XS2M30KP340	0.205	(0.45)
			M12 connector	XS2M30KP340D	0.145	(0.32)

Plastic case, non-flush mountable

15 (0.59)	NO/NC programmable	PNP + NPN	Pre-cabled (L = 2 m) (1)	XS4P30KP340	0.205	(0.45)
			M12 connector	XS4P30KP340D	0.145	(0.32)

Accessories

Description		Catalog Number	Weight	
			kg	(lb)
Mounting clamps	Ø 12 mm	XSZB112	0.006	(0.01)
	Ø 18 mm	XSZB118	0.010	(0.02)
	Ø 30 mm	XSZB130	0.020	(0.02)

(1) For a 5 m cable add L1 to the catalog number; for a 10 m cable add L2. Example: **XS1M12KP340** becomes **XS1M12KP340L1** with a 5 m cable.

Specifications,
Wiring Diagrams,
Setup,
Dimensions

OsiSense® XS

Inductive proximity sensors

General purpose
Cylindrical, metal and plastic, flush and non-flush mountable, 4-wire DC, solid-state PNP + NPN NO/NC programmable output

2

Specifications		XS●M●●KP340D	XS●M●●KP340
Sensor type			
Product certifications		UL, CSA, CE	
Connection		M12 connector	Pre-cabled, length: 2 m
Operating zone	Ø 12 flush mountable	mm	0–1.6 (0–0.06 in.)
	Ø 12 non-flush mountable	mm	0–3.2 (0–0.13 in.)
	Ø 18 flush mountable	mm	0–4 (0–0.16 in.)
	Ø 18 non-flush mountable	mm	0–6.4 (0–0.25 in.)
	Ø 30 flush mountable	mm	0–8 (0–0.31 in.)
	Ø 30 non-flush mountable	mm	0–12 (0–0.47 in.)
Differential travel		%	
Degree of protection		Conforming to IEC 60529	IP 67
Storage temperature		°C	
Operating temperature		°C	
Materials	Case	Nickel-plated brass for XS1M and XS2M, PPS for XS4P	
	Cable	PvR 4 x 0.34 mm ² (22 AWG)	
Vibration resistance		Conforming to IEC 60068-2-6	
Shock resistance		Conforming to IEC 60068-2-27	
Output state indication		Yellow LED, 4 viewing ports at 90°	
Rated supply voltage		V	
Voltage limits (including ripple)		V	
Switching capacity		mA	
Voltage drop, closed state		V	
Current consumption, no-load		mA	
Maximum switching frequency	Ø 12	Hz	5000
	Ø 18	Hz	2000
	Ø 30 flush mountable	Hz	1000
	Ø 30 non-flush mountable	Hz	1000
	Delays		ms
First-up		ms	
Response		ms	
Recovery		ms	

Wiring diagrams

M12 connector **Pre-cabled** **PNP + NPN**

BU: Blue
BN: Brown
BK: Black
WH: White

4-wire programmable, NO or NC output

Setup

Sensor	Minimum mounting distances (mm)			
	Side by side	Face to face	Facing a metal object	Mounted in a metal support
Ø 12 flush mountable XS1M12	e ≥ 4	e ≥ 24	e ≥ 6	d ≥ 12 h ≥ 0
Ø 12 non-flush mountable XS2M12 and XS4P12	e ≥ 16	e ≥ 48	e ≥ 12	d ≥ 36 h ≥ 8
Ø 18 flush mountable XS1M18	e ≥ 10	e ≥ 60	e ≥ 15	d ≥ 18 h ≥ 0
Ø 18 non-flush mountable XS2M18 and XS4P18	e ≥ 16	e ≥ 96	e ≥ 24	d ≥ 54 h ≥ 16
Ø 30 flush mountable XS1M30	e ≥ 20	e ≥ 120	e ≥ 30	d ≥ 30 h ≥ 0
Ø 30 non-flush mountable XS2M30 and XS4P30	e ≥ 60	e ≥ 180	e ≥ 45	d ≥ 90 h ≥ 30

Dimensions (mm)

Sensor	Flush mountable in metal				Non-flush mountable in metal				
	Pre-cabled		Connector		Pre-cabled		Connector		c
	a	b	a	b	a	b	a	b	
Ø 12 metal	50	42	61	42	54.6	42	65.6	42	5
Ø 12 plastic	–	–	–	–	50	42	61	42	0
Ø 18 metal	60	51	72	51	60	44	72	44	8
Ø 18 plastic	–	–	–	–	60	51	70	51	0
Ø 30 metal	60	51	72	51	62.6	41	74.7	41	13
Ø 30 plastic	–	–	–	–	60	51	70	51	0

OsiSense® XS

Inductive proximity sensors

Application, food and beverage processing series • Cylindrical, stainless steel, non-flush mountable, three-wire DC, solid-state output

2

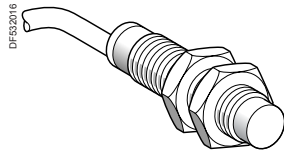

XS2●●SA●●L2

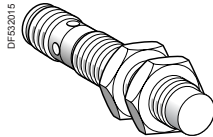

XS2●●SA●●M12

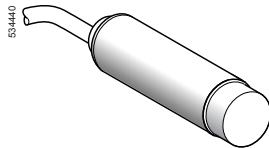

XS2L2SA●●L2

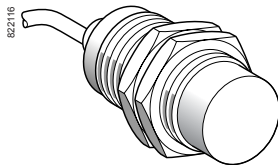

XS230SA●●L2

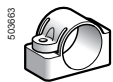

XUZB2005



XSZBS12



XUZA118



XSZBS30

Ø 12, threaded M12 x 1						
Sensing distance Sn, mm (in.)	Function	Output	Connection	Catalog Number	Weight kg (lb)	
7 (0.28)	NO	PNP	Pre-cabled (L = 2 m) (1)	XS212SAPAL2	0.075	(0.17)
			M12 connector	XS212SAPAM12	0.035	(0.08)
	NPN	PNP	Pre-cabled (L = 2 m) (1)	XS212SANAL2	0.075	(0.17)
			M12 connector	XS212SANAM12	0.035	(0.08)

Ø 18, threaded M18 x 1						
Sensing distance Sn, mm (in.)	Function	Output	Connection	Catalog Number	Weight kg (lb)	
12 (0.47)	NO	PNP	Pre-cabled (L = 2 m) (1)	XS218SAPAL2	0.120	(0.26)
			M12 connector	XS218SAPAM12	0.060	(0.13)
	NPN	PNP	Pre-cabled (L = 2 m) (1)	XS218SANAL2	0.120	(0.26)
			M12 connector	XS218SANAM12	0.060	(0.13)

Ø 18, plain						
Sensing distance Sn, mm (in.)	Function	Output	Connection	Catalog Number	Weight kg (lb)	
12 (0.47)	NO	PNP	Pre-cabled (L = 2 m) (1)	XS2L2SAPAL2	0.120	(0.26)
			M12 connector	XS2L2SAPAM12	0.060	(0.13)
	NPN	PNP	Pre-cabled (L = 2 m) (1)	XS2L2SANAL2	0.120	(0.26)
			M12 connector	XS2L2SANAM12	0.060	(0.13)

Ø 30, threaded M30 x 1.5						
Sensing distance Sn, mm (in.)	Function	Output	Connection	Catalog Number	Weight kg (lb)	
22 (0.87)	NO	PNP	Pre-cabled (L = 2 m) (1)	XS230SAPAL2	0.205	(0.45)
			M12 connector	XS230SAPAM12	0.145	(0.32)
	NPN	PNP	Pre-cabled (L = 2 m) (1)	XS230SANAL2	0.205	(0.45)
			M12 connector	XS230SANAM12	0.145	(0.32)

Accessories			
Description	For use with	Catalog Number	Weight kg (lb)
Plastic mounting clamp, 24.1 mm centers, with locking screw	Ø 18 sensor, plain case	XUZB2005	0.007 (0.02)
Stainless steel mounting bracket	Ø 12 sensor	XSZBS12	0.060 (0.13)
	Ø 18 sensor	XUZA118	0.045 (0.10)
	Ø 30 sensor	XSZBS30	0.080 (0.18)

Connecting cables (2)					
Description	Type	Length m	Catalog Number	Weight kg (lb)	
Pre-wired M12 connectors Female, 4-pin, stainless steel clamping ring	Straight	2	XZCPA1141L2	0.090	(0.20)
		5	XZCPA1141L5	0.210	(0.46)
		10	XZCPA1141L10	0.410	(0.90)
	Elbowed	2	XZCPA1241L2	0.090	(0.20)
		5	XZCPA1241L5	0.210	(0.46)
		10	XZCPA1241L10	0.410	(0.90)
M12 jumper cable Male, 3-pin, stainless steel clamping ring	Straight	2	XZCRA151140A2	0.095	(0.21)
		5	XZCRA151140A5	0.200	(0.44)

(1) For a 5 m cable replace L2 with L5; for a 10 m cable replace L2 by L10.
Example: XS212SAPAL2 becomes XS212SAPAL5 with a 5 m cable.
(2) For further information, see Machine Cabling section.

Specifications		XS2●●SA●●M12	XS2●●SA●●L2
Sensor type		XS2●●SA●●M12	
Product certifications/approvals		UL, CSA, CE	
Connection	Connector	M12	—
	Pre-cabled	—	Length: 2 m
Operating zone	Ø 12	mm	0–5.6 (0–0.22 in.)
	Ø 18	mm	0–9.6 (0–0.38 in.)
	Ø 30	mm	0–17.6 (0–0.69 in.)
Differential travel		%	
Degree of protection		IP 67	
Storage temperature		°C	
Operating temperature		°C	
Materials	Case	Stainless steel, grade 316 L	
	Cable	—	
Vibration resistance		25 gn, amplitude ± 2 mm (f = 10 to 55 Hz)	
Shock resistance		50 gn, duration 11 ms	
Output state indication		Yellow LED: 4 viewing ports at 90°	
Rated supply voltage		V	
Voltage limits (including ripple)		V	
Switching capacity		mA	
Voltage drop, closed state		V	
Current consumption, no-load		mA	
Maximum switching frequency	XS212SA●●●●	Hz	
	XS218SA●●●● and XS2L2●●●●	Hz	
	XS230SA●●●●	Hz	
Delays	First-up	ms	
	Response	ms	
	Recovery	ms	

(1) + 100 °C (+212 °F) for cleaning and sterilization phases while not in service.

Wiring diagrams

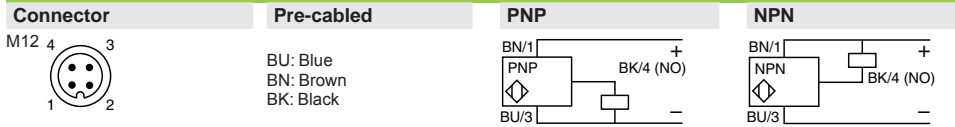

Setup

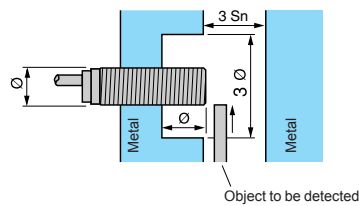

Minimum mounting distances (mm)

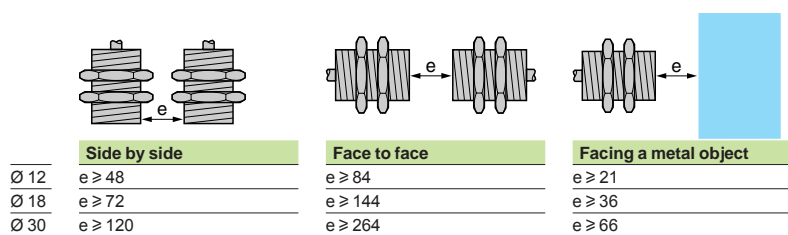

Dimensions (mm)

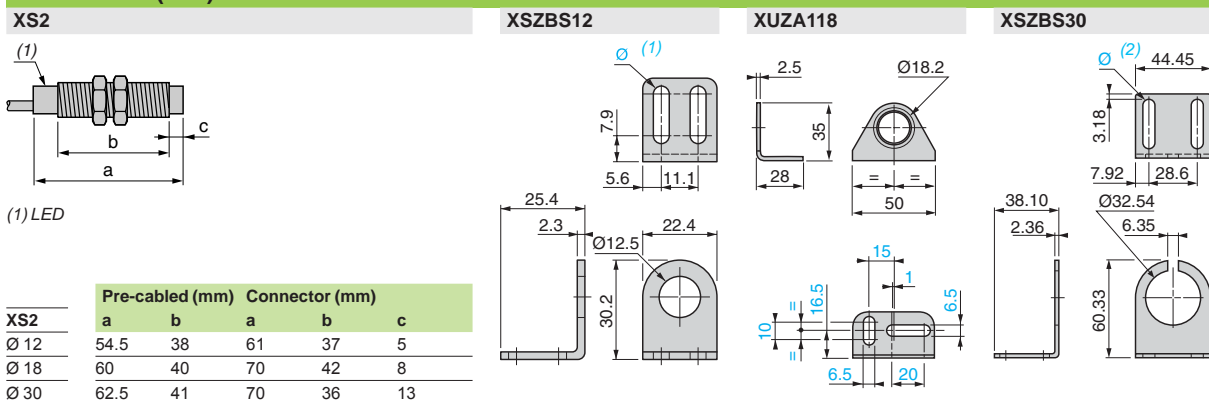

OsiSense® XS

Inductive proximity sensors

Application, food and beverage processing series • Cylindrical, stainless steel, non-flush mountable, two-wire AC or DC

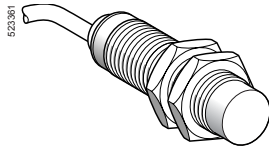

XS218SAM●L2

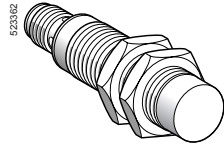

XS218SAM●U20

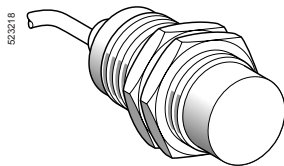

XS230SAM●L2

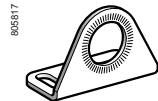

XUZA118



XSZBS30

2

Ø 18, threaded M18 x 1

Sensing distance Sn, mm (in.)	Function	Connection	Catalog Number	Weight kg (lb)
12 (0.47)	NO	Pre-cabled (L = 2 m) (1)	XS218SAMAL2	0.120 (0.26)
		1/2"-20UNF connector	XS218SAMAU20	0.060 (0.13)

Ø 30, threaded M30 x 1.5

Sensing distance Sn, mm (in.)	Function	Connection	Catalog Number	Weight kg (lb)
22 (0.87)	NO	Pre-cabled (L = 2 m) (1)	XS230SAMAL2	0.205 (0.45)
		1/2"-20UNF connector	XS230SAMAU20	0.145 (0.32)

Connecting cables (2)

Description	Type	Length m	Catalog Number	Weight kg (lb)
Pre-wired connectors 1/2"-20UNF 3-pin female, stainless steel clamping ring	Straight	5	XZCPA1865L5	0.210 (0.46)
		10	XZCPA1865L10	0.410 (0.90)
	Elbowed	5	XZCPA1965L5	0.250 (0.55)
		10	XZCPA1965L10	0.485 (1.07)

Accessories

Description	For use with	Catalog Number	Weight kg (lb)
Stainless steel mounting bracket	Ø 18 sensor	XUZA118	0.045 (0.10)
	Ø 30 sensor	XSZBS30	0.080 (0.18)

(1) For a 5 m cable replace L2 with L5; for a 10 m cable replace L2 by L10.
Example: XS218SAMAL2 becomes XS218SAMAL5 with a 5 m cable.

Specifications		XS2●●SAM●U20	XS2●●SAM●L2
Sensor type			
Product certifications/approvals		UL, CSA, CE	
Connection	Connector	1/2"-20UNF	-
	Pre-cabled	-	Length: 2 m
Operating zone	∅ 18	mm 0-9.6 (0-0.38)	
	∅ 30	mm 0-17.6 (0-0.69)	
Differential travel		%	
Degree of protection		%	
Storage temperature	Conforming to IEC 60529	IP 67	IP 68, double insulation □
	DIN 40050	IP 69K	
Operating temperature		°C	
Materials		°C	
Case		Stainless steel, grade 316 L	
Cable		-	
Vibration resistance		Non-poisonous PVC, 2 x 0.34 mm² (22 AWG)	
Conforming to IEC 60068-2-6		25 gn, amplitude ± 2 mm (f = 10 to 55 Hz)	
Shock resistance		50 gn, duration 11 ms	
Conforming to IEC 60068-2-27		50 gn, duration 11 ms	
Output state indication		Yellow LED: 4 viewing ports at 90°	
Rated supply voltage		Yellow LED: annular	
Voltage limits (including ripple)		V	
Switching capacity		V	
Voltage drop, closed state		mA	
Residual current, open state		ms	
Maximum switching frequency		ms	
Delays		ms	

(1) + 100 °C (+212 °F) for cleaning and sterilization processes while not in service.
(2) A 0.4 A fast-acting fuse must be connected in series with the load.

Wiring diagrams

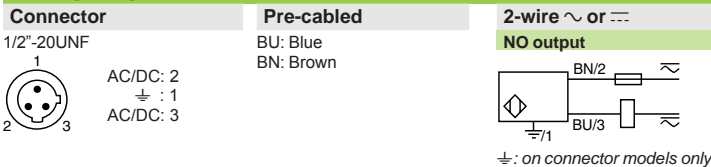

Setup

Minimum mounting distances (mm)

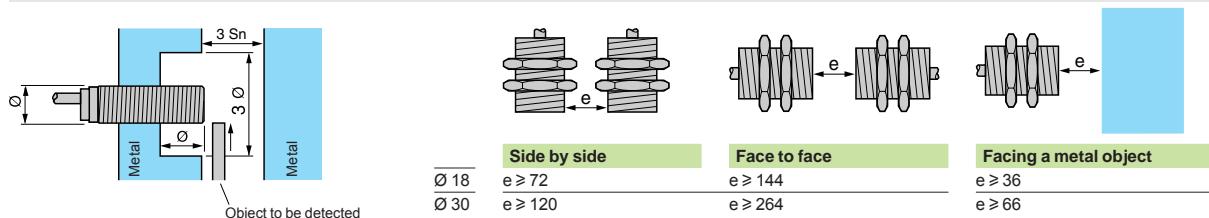

Dimensions (mm)

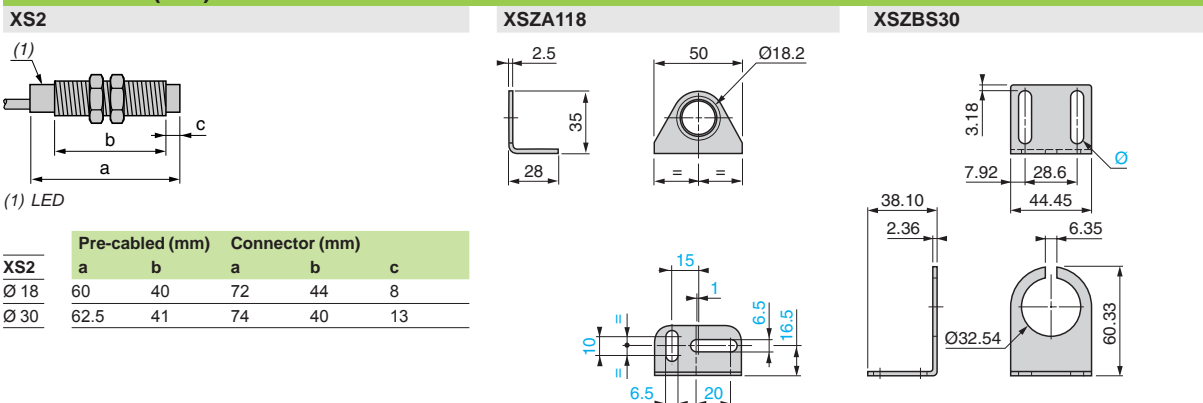

XS2	Pre-cabled (mm)		Connector (mm)		
	a	b	a	b	c
∅ 18	60	40	72	44	8
∅ 30	62.5	41	74	40	13

OsiSense® XS

Inductive proximity sensors

Application, food and beverage processing series • Cylindrical, plastic, non-flush mountable
Three-wire DC, solid-state output

2

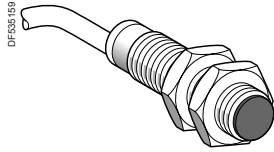

XS2●●AA●●L2

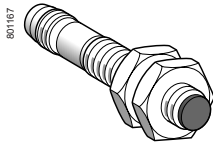

XS2●●AA●●M12

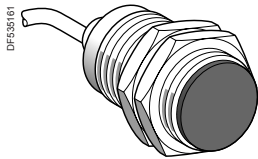

XS230AA●●L2

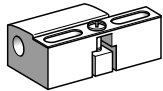

XSZB●●●

Ø 12, threaded M12 x 1

Sensing distance Sn, mm (in.)	Function	Output	Connection	Catalog Number	Weight kg (lb)
7 (0.28)	NO	PNP	Pre-cabled (L = 2 m) (1)	XS212AAPAL2	0.065 (0.14)
			M12 connector	XS212AAPAM12	0.030 (0.07)
	NPN	Pre-cabled (L = 2 m) (1)	XS212AANAL2	0.065 (0.14)	
			M12 connector	XS212AANAM12	0.030 (0.07)

Ø 18, threaded M18 x 1

Sensing distance Sn, mm (in.)	Function	Output	Connection	Catalog Number	Weight kg (lb)
12 (0.47)	NO	PNP	Pre-cabled (L = 2 m) (1)	XS218AAPAL2	0.100 (0.22)
			M12 connector	XS218AAPAM12	0.040 (0.09)
	NPN	Pre-cabled (L = 2 m) (1)	XS218AANAL2	0.100 (0.22)	
			M12 connector	XS218AANAM12	0.040 (0.09)

Ø 30, threaded M30 x 1.5

Sensing distance Sn, mm (in.)	Function	Output	Connection	Catalog Number	Weight kg (lb)
22 (0.87)	NO	PNP	Pre-cabled (L = 2 m) (1)	XS230AAPAL2	0.140 (0.31)
			M12 connector	XS230AAPAM12	0.080 (1.76)
	NPN	Pre-cabled (L = 2 m) (1)	XS230AANAL2	0.140 (0.31)	
			M12 connector	XS230AANAM12	0.080 (1.76)

Accessories

Description		Catalog Number	Weight kg (lb)
Mounting clamps	Ø 12	XSZB112	0.006 (0.01)
	Ø 18	XSZB118	0.010 (0.02)
	Ø 30	XSZB130	0.020 (0.04)

Connecting cables

Description	Type	Length m	Catalog Number	Weight kg (lb)
Pre-wired M12 connectors Female, 4-pin, stainless steel clamping ring	Straight	2	XZCPA1141L2	0.090 (0.20)
		5	XZCPA1141L5	0.190 (0.42)
		10	XZCPA1141L10	0.370 (0.82)
	Elbowed	2	XZCPA1241L2	0.090 (0.20)
		5	XZCPA1241L5	0.190 (0.42)
		10	XZCPA1241L10	0.370 (0.82)
M12 jumper cable Male, 3-pin, stainless steel clamping ring	Straight	2	XZCRA151140A2	0.090 (0.20)
		5	XZCRA151140A5	0.190 (0.42)

(1) For a 5 m cable replace L2 with L5; for a 10 m cable replace L2 by L10.
Example: XS212AAPAL2 becomes XS212AAPAL5 with a 5 m cable.

Specifications			
Sensor type		XS2●●AA●●M12	XS2●●AA●●L2
Product certifications/approvals		UL, CSA, CE	
Connection	Connector	M12	–
	Pre-cabled	–	Length: 2 m
Operating zone	∅ 12	mm	0–5.6 (0–0.22 in.)
	∅ 18	mm	0–9.6 (0–0.38 in.)
	∅ 30	mm	0–17.6 (0–0.69 in.)
Differential travel		%	1–15 of effective sensing distance (Sr)
Degree of protection	Conforming to IEC 60529	IP 67	IP 68, double insulation □
	DIN 40050	IP 69K	
Storage temperature		°C	-40 to +85 (-40 to +185 °F)
Operating temperature		°C	-25 to +85 (-13 to + 185 °F)
Materials	Case	PPS	
	Cable	–	PvR and 3 x 0.34 mm ² (24 AWG)
Vibration resistance	Conforming to IEC 60068-2-6	25 gn, amplitude ± 2 mm (f = 10 to 55 Hz)	
Shock resistance	Conforming to IEC 60068-2-27	50 gn, duration 11 ms	
Output state indication		Yellow LED: annular	
Rated supply voltage		Vdc	12–48 for T - 25 to + 85 °C (-13 to + 185 °F)
Voltage limits (including ripple)		Vdc	10–58 for T - 25 to + 85 °C (-13 to +185 °F)
Switching capacity		mA	≤ 200 with overload and short-circuit protection
Voltage drop, closed state		V	≤ 2
Current consumption, no-load		mA	≤ 10
Maximum switching frequency	XS212AA●●●●	Hz	2500
	XS218AA●●●●	Hz	1000
	XS230AA●●●●	Hz	500
Delays	First-up	ms	≤ 10
	Response	ms	≤ 0.2 ∅ 12, ≤ 0.3 ∅ 18, ≤ 0.6 ∅ 30
	Recovery	ms	≤ 0.2 ∅ 12, ≤ 0.7 ∅ 18, ≤ 1.4 ∅ 30

Wiring diagrams

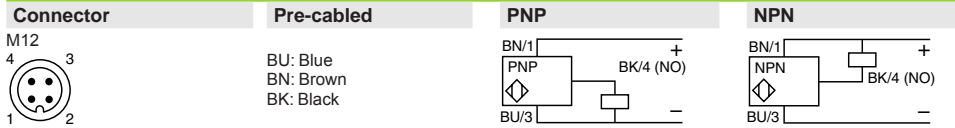

Setup

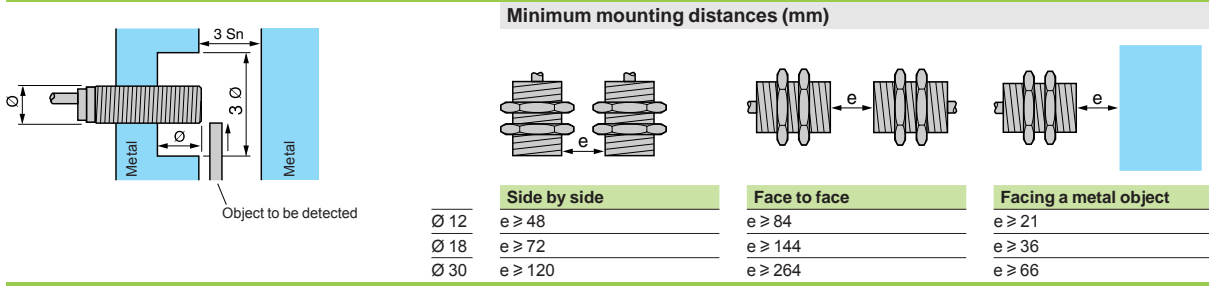

Dimensions (mm)

XS2	Pre-cabled (mm)		Connector (mm)	
	a	b	a	b
∅ 12	50	42	61	43
∅ 18	60	51	70	52
∅ 30	60	51	70	52

OsiSense® XS

Inductive proximity sensors

Application, food and beverage processing series • Cylindrical, plastic, non-flush mountable
Two-wire AC or DC

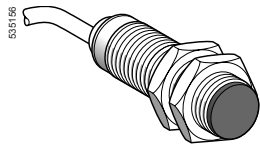

XS2●●AAM●L2

Ø 18, threaded M18 x 1				
Sensing distance Sn, mm (in.)	Function	Connection	Catalog Number	Weight kg (lb)
12 (0.47)	NO	Pre-cabled (L = 2 m) (1)	XS218AAMAL2	0.100 (0.22)
		1/2"-20UNF connector	XS218AAMAU20	0.040 (0.09)

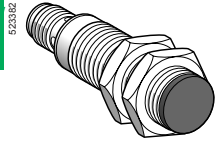

XS2●●AAM●U20

Ø 30, threaded M30 x 1.5				
Sensing distance Sn, mm (in.)	Function	Connection	Catalog Number	Weight kg (lb)
22 (0.87)	NO	Pre-cabled (L = 2 m) (1)	XS230AAMAL2	0.140 (0.31)
		1/2"-20UNF connector	XS230AAMAU20	0.080 (0.18)

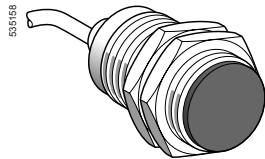

XS230AAM●L2

Accessories			
Description		Catalog Number	Weight kg (lb)
Mounting clamps	Ø 18	XSZB118	0.010 (0.02)
	Ø 30	XSZB130	0.020 (0.04)

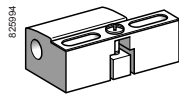

XSZB1●●

Connecting cables				
Description	Type	Length m	Catalog Number	Weight kg (lb)
Pre-wired connectors 1/2"-20UNF 3-pin female, stainless steel 316 L clamping ring	Straight	5	XZCPA1865L5	0.180 (0.40)
		10	XZCPA1865L10	0.350 (0.77)
	Elbowed	5	XZCPA1965L5	0.180 (0.40)
		10	XZCPA1965L10	0.350 (0.77)

(1) For a 5 m cable replace L2 with L5; for a 10 m cable replace L2 by L10.
Example: XS218AAMAL2 becomes XS218AAMAL5 with a 5 m cable..

Specifications		XS2●●AAM●U20	XS2●●AAM●L2
Sensor type		UL, CSA, CE	
Product certifications/approvals		UL, CSA, CE	
Connection	Connector	1/2"-20UNF	–
	Pre-cabled	–	Length: 2 m
Operating zone	∅ 18	mm 0–9.6	
	∅ 30	mm 0–17.6	
Differential travel		%	
		1–15 of effective sensing distance (Sr)	
Degree of protection	Conforming to IEC 60529	IP 67	IP 68, double insulation □
	DIN 40050	IP 69K	
Storage temperature		°C	
		–40 to +85 (–40 to 185 °F)	
Operating temperature		°C	
		–25 to +85 (–13 to 185 °F)	
Materials	Case	PPS	
	Cable	–	PvR and 2 x 0.34 mm ² (24 AWG)
Vibration resistance	Conforming to IEC 60068-2-6	25 gn, amplitude ± 2 mm (f = 10 to 55 Hz)	
Shock resistance	Conforming to IEC 60068-2-27	50 gn, duration 11 ms	
Output state indication		Yellow LED: annular	
Rated supply voltage		V	
		~ or --- 24–240 (~ 50/60 Hz)	
Voltage limits (including ripple)		V	
		~ or --- 200/264	
Switching capacity		mA	
		~ 5–300 or --- 5–200 (1)	
Voltage drop, closed state		V	
		≤ 5.5	
Residual current, open state		mA	
		≤ 0.8	
Maximum switching frequency	XS218AAM●●●	Hz	
	XS230AAM●●●	~ 25 or --- 1000	
Delays	First-up	ms	
	Response	ms	
		≤ 30	
Recovery		ms	
		≤ 0.5	
		ms	
		≤ 0.5 XS218AAM●●●, ≤ 2 XS230AAM●●●	

(1) A 0.4 A fast-acting fuse must be connected in series with the load.

Wiring diagrams

Connector	Pre-cabled	2-wire ~ or ---
1/2"-20UNF	BU: Blue BN: Brown	NO output

Setup

Minimum mounting distances (mm)

Mounting Type	∅ 18	∅ 30
Side by side	e ≥ 72	e ≥ 120
Face to face	e ≥ 144	e ≥ 264
Facing a metal object	e ≥ 36	e ≥ 66

Dimensions (mm)

XS2

(1) LED

XS2	Pre-cabled (mm)		Connector (mm)	
	a	b	a	b
∅ 18	60	51	70	52
∅ 30	60	51	70	52

OsiSense® XS

Inductive proximity sensors

Flush mountable using teach mode

2

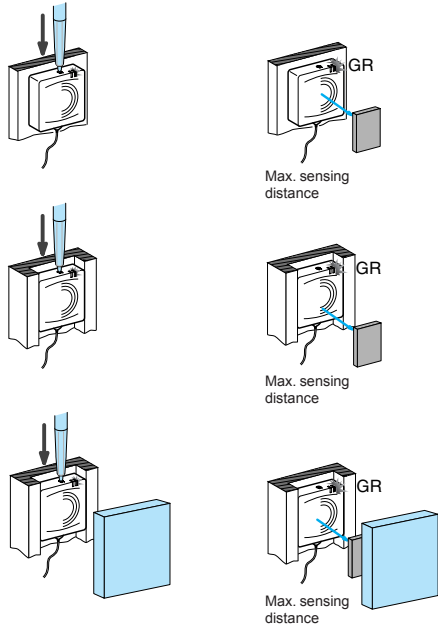

Operating principle

Schneider Electric's flush mountable sensors using teach mode offer simplicity through innovation.

- A single product enables flush mounting using teach mode and meets all the requirements for inductive sensing of metal objects. Simply press the "Teach mode" button, and the sensor automatically acquires optimum configuration for all sensing, flush mounting and environment requirements.
- Other advantages of flush mountable sensors using teach mode
 - Increased performance:
 - sensing distance optimized regardless of the mounting method, object, environment or background,
 - suitable for all metal environments.
 - Simplified use provided by:
 - the flush mountability using teach mode technology, associated with the availability of the flattest and most compact sensors on the market, simplifies integration in the machine and limits the risks of mechanical damage,
 - mechanical adjustments no longer necessary due to teach mode.
 - Lower costs due to:
 - the elimination of adjustment times and complex supports
 - the elimination of flush mountable and non-flush mountable versions, which decreases the number of catalog numbers,
 - much easier and much quicker product selection.

Precision position detection

All flush mountable inductive proximity sensors using teach mode benefit from ultra-precise adjustment, which is very quick regardless of the metal environment.

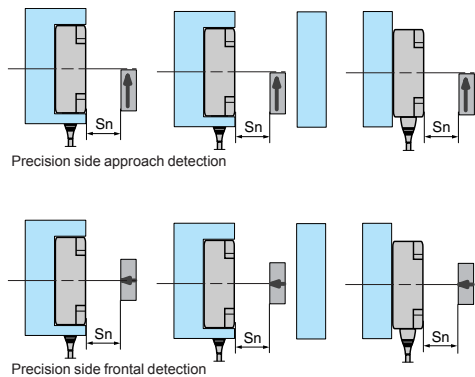

- Precision side approach detection makes it possible to accurately define the distance at which the object will be detected as it passes the sensor. On flush mountable sensors using teach mode, the desired detection position can be stored in memory by simply pressing the teach button.
- Precision frontal approach detection makes it possible to accurately define the distance at which the object will be detected as it approaches the sensor. On flush mountable sensors using teach mode, the desired detection position can be stored in memory by simply pressing the teach button.

Mounting accessories

Schneider Electric offers a complete, inexpensive range of mounting accessories (clamps, plates, brackets, etc.) that provide solutions for all installation problems.

- Mounting kits for quick installation or replacement of sensors
- No adjustment is required. Simple clip-in enables the sensor to be mounted into position and ready for operation.

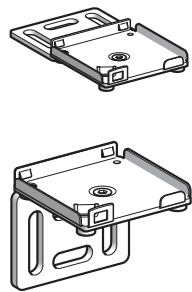

OsiSense® XS

Inductive proximity sensors

Flush mountable using teach mode



Block type				
Dimensions (mm)		26 x 26 x 13	40 x 40 x 15	80 x 80 x 26
Sensing distance mm (in.)	Flush mounted use	0–10 (0–0.39)	0–15 (0–0.59)	0–40 (0–1.57)
	Non-flush mounted use	0–15 (0–0.59)	0–25 (0–0.98)	0–60 (0–2.36)
Sensor type		XS8E1A1	XS8C1A1	XS8D1A1
Page		76		

Cylindrical type				
Dimensions (mm)		ø12	ø18	ø30
Sensing distance (mm)	Flush mounted use	0–3.4 (0–0.13)	0–6 (0–0.24)	0–11 (0–0.43)
	Non-flush mounted use	0–5 (0–0.20)	0–9 (0–0.35)	0–18 (0–0.71)
Sensor type		XS612B2	XS618B2	XS630B2
Page		74		

OsiSense® XS Inductive proximity sensors

Application

Adjustable range sensors

Cylindrical, flush mountable and non-flush mountable

Three-wire DC, solid-state output

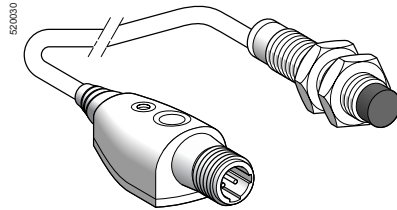

XS6...B2...L01M12

Ø 12, threaded M12 x 1

Sensing distance Sn, mm (in.)	Function	Output	Connection	Catalog Number	Weight kg (lb)
5 (0.20)	NO	PNP	Remote M12 connector on 0.15 m pigtail connector	XS612B2PAL01M12	0.100 (0.22)
		NPN	Remote M12 connector on 0.15 m pigtail connector	XS612B2NAL01M12	0.100 (0.22)
	NC	PNP	Remote M12 connector on 0.15 m pigtail connector	XS612B2PBL01M12	0.100 (0.22)
		NPN	Remote M12 connector on 0.15 m pigtail connector	XS612B2NBL01M12	0.100 (0.22)

Ø 18, threaded M18 x 1

Sensing distance Sn, mm (in.)	Function	Output	Connection	Catalog Number	Weight kg (lb)
9 (0.35)	NO	PNP	Remote M12 connector on 0.15 m pigtail connector	XS618B2PAL01M12	0.140 (0.31)
		NPN	Remote M12 connector on 0.15 m pigtail connector	XS618B2NAL01M12	0.140 (0.31)
	NC	PNP	Remote M12 connector on 0.15 m pigtail connector	XS618B2PBL01M12	0.140 (0.31)
		NPN	Remote M12 connector on 0.15 m pigtail connector	XS618B2NBL01M12	0.140 (0.31)

Ø 30, threaded M30 x 1.5

Sensing distance Sn, mm (in.)	Function	Output	Connection	Catalog Number	Weight kg (lb)
18 (0.71)	NO	PNP	Remote M12 connector on 0.15 m pigtail connector	XS630B2PAL01M12	0.220 (0.49)
		NPN	Remote M12 connector on 0.15 m pigtail connector	XS630B2NAL01M12	0.220 (0.49)
	NC	PNP	Remote M12 connector on 0.15 m pigtail connector	XS630B2PBL01M12	0.220 (0.49)
		NPN	Remote M12 connector on 0.15 m pigtail connector	XS630B2NBL01M12	0.220 (0.49)

Accessories

Description	Catalog Number	Weight kg (lb)
Remote control mounting clamp	XSZBPM12	0.015 (0.03)
Sensor mounting clamps	Ø 12	XSZB112 0.006 (0.01)
	Ø 18	XSZB118 0.010 (0.02)
	Ø 30	XSZB130 0.020 (0.04)

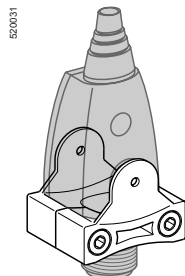

XSZBPM12

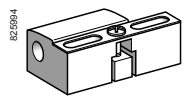

XSZB...

Specifications			
Sensor type		XS6●●B2●●L01M12	
Product certifications		UL, CSA, CE	
Connection	Connector	Remote M12 connector on 0.15 m pigtail connector	
Sensing distance and adjustment zone	Ø 12	Nominal sensing distance (Sn)	mm (in.) 0–5 (0–0.20) non-flush mounted / 0–3.4 (0–0.13) flush mounted
		Precision adjustment zone	mm (in.) 1.7–5 (0.07–0.20) non-flush mounted / 1.7–3.4 (0.07–0.20) flush mounted
	Ø 18	Nominal sensing distance (Sn)	mm (in.) 0–9 (0–0.35) non-flush mounted / 0–6 (0–0.24) flush mounted
		Precision adjustment zone	mm (in.) 3–9 (0.12–0.35) non-flush mounted / 3–6 (0.12–0.24) flush mounted
	Ø 30	Nominal sensing distance (Sn)	mm (in.) 0–18 (0–0.71) non-flush mounted / 0–11 (0–0.43) flush mounted
		Precision adjustment zone	mm (in.) 6–18 (0.24–0.71) non-flush mounted / 6–11 (0.24–0.43) flush mounted
Differential travel		% 1–15 of effective sensing distance (Sr)	
Degree of protection	Conforming to IEC 60529	IP 67, □	
Storage temperature		°C (°F) -40 to +85 (-40 to +185)	
Operating temperature		°C (°F) -25 to +70 (-13 to +158)	
Materials	Case	Nickel-plated brass	
	Remote control	PBT	
	Cable	PvR - Ø 4.2 mm	
Vibration resistance	Conforming to IEC 60068-2-6	25 gn, amplitude ± 2 mm (f = 10 to 55 Hz)	
Shock resistance	Conforming to IEC 60068-2-27	50 gn, duration 11 ms	
Indicators	Output state	Yellow LED	
	Supply on and teach mode	Green LED	
Rated supply voltage		V --- 12–24 with protection against reverse polarity	
Voltage limits (including ripple)		V --- 10–36	
Switching capacity		mA ≤ 100 with overload and short-circuit protection	
Voltage drop, closed state		V ≤ 2	
Current consumption, no-load		mA ≤ 10	
Maximum switching frequency		Hz 1000	
Delays	First-up	ms ≤ 10	
	Response	ms ≤ 0.3	
	Recovery	ms ≤ 0.7	

Wiring diagrams

Connector

M12



PNP

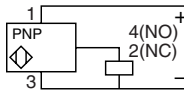

NPN

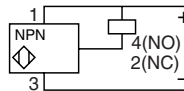

Setup

Minimum mounting distances (mm)

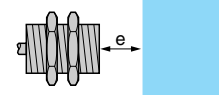
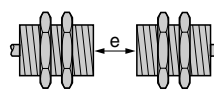
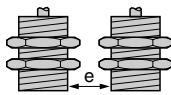

Side by side

	flush mounted	non-flush mounted
Ø 12	e ≥ 14	50
Ø 18	e ≥ 28	100
Ø 30	e ≥ 48	180

Face to face

	flush mounted	non-flush mounted
Ø 12	e ≥ 50	100
Ø 18	e ≥ 100	200
Ø 30	e ≥ 180	360

Facing a metal object

	flush mounted	non-flush mounted
Ø 12	e ≥ 3.4	
Ø 18	e ≥ 6	
Ø 30	e ≥ 11	

Dimensions (mm)

XS6

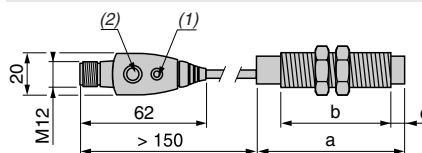

- (1) LED
(2) Teach mode button

Connector (mm)

	a	b	c
Ø 12	54.6	42	5
Ø 18	60	44	8
Ø 30	62.6	41	13

OsiSense® XS

Inductive proximity sensors

General Purpose with increased range

Flat, flush mountable/non-flush mountable + teach mode (1)

Two-wire AC or DC

Three-wire DC, solid-state output

Flat, 26 x 26 x 13 mm format

Sensing distance Sn, mm (in.)	Function	Output	Connection	Catalog Number	Weight kg (lb)
Three-wire $\overline{\text{---}}$ with overload and short-circuit protection					
15 (0.59)	NO	PNP	Pre-cabled (L = 2 m) (2)	XS8E1A1PAL2	0.075 (0.17)
			M8 connector	XS8E1A1PAM8	0.040 (0.09)
			Remote M12 connector	XS8E1A1PAL01M12	0.040 (0.09)
	NPN	PNP	Pre-cabled (L = 2 m) (2)	XS8E1A1NAL2	0.075 (0.17)
			M8 connector	XS8E1A1NAM8	0.040 (0.09)
			Remote M12 connector	XS8E1A1NAL01M12	0.040 (0.09)
NC	PNP	Pre-cabled (L = 2 m) (2)	XS8E1A1PBL2	0.075 (0.17)	
		M8 connector	XS8E1A1PBM8	0.040 (0.09)	
		Remote M12 connector	XS8E1A1PBL01M12	0.040 (0.09)	
NPN	PNP	Pre-cabled (L = 2 m) (2)	XS8E1A1NBL2	0.075 (0.17)	
		M8 connector	XS8E1A1NBM8	0.040 (0.09)	
		Remote M12 connector	XS8E1A1NBL01M12	0.040 (0.09)	
Two-wire \sim or $\overline{\text{---}}$ unprotected (3)					
15 (0.59)	NO	-	Pre-cabled (L = 2 m) (2)	XS8E1A1MAL2	0.070 (0.15)
			Remote 1/2"-20UNF connector	XS8E1A1MAL01U20	0.040 (0.09)
	NC	-	Pre-cabled (L = 2 m) (2)	XS8E1A1MBL2	0.070 (0.15)
			Remote 1/2"-20UNF connector	XS8E1A1MBL01U20	0.040 (0.09)

Flat, 40 x 40 x 15 mm format

Sensing distance Sn, mm (in.)	Function	Output	Connection	Catalog Number	Weight kg (lb)
Three-wire $\overline{\text{---}}$ with overload and short-circuit protection					
25 (0.98)	NO	PNP	Pre-cabled (L = 2 m) (3)	XS8C1A1PAL2	0.095 (0.21)
			M8 connector	XS8C1A1PAM8	0.060 (0.13)
			Remote M12 connector	XS8C1A1PAL01M12	0.060 (0.13)
			NPN	PNP	Pre-cabled (L = 2 m) (3)
	M8 connector	XS8C1A1NAM8	0.060 (0.13)		
	Remote M12 connector	XS8C1A1NAL01M12	0.060 (0.13)		
	NC	PNP	Pre-cabled (L = 2 m) (3)		XS8C1A1PBL2
			M8 connector	XS8C1A1PBM8	0.060 (0.13)
			Remote M12 connector	XS8C1A1PBL01M12	0.060 (0.13)
			NPN	PNP	Pre-cabled (L = 2 m) (3)
	M8 connector	XS8C1A1NBM8			0.060 (0.13)
	Remote M12 connector	XS8C1A1NBL01M12			0.060 (0.13)
Two-wire \sim or $\overline{\text{---}}$ unprotected (4)					
25 (0.98)	NO	-	Pre-cabled (L = 2 m) (3)	XS8C1A1MAL2	0.090 (0.20)
			Remote 1/2"-20UNF connector	XS8C1A1MAL01U20	0.060 (0.13)
	NC	-	Pre-cabled (L = 2 m) (3)	XS8C1A1MBL2	0.090 (0.20)
			Remote 1/2"-20UNF connector	XS8C1A1MBL01U20	0.060 (0.13)

Flat, 80 x 80 x 26 mm format

Sensing distance Sn, mm (in.)	Function	Output	Connection	Catalog Number	Weight kg (lb)			
Three-wire $\overline{\text{---}}$ with overload and short-circuit protection								
60 (2.36)	NO	PNP	Pre-cabled (L = 2 m) (2)	XS8D1A1PAL2 (4)	0.390 (0.86)			
			M12 connector	XS8D1A1PAM12 (4)	0.340 (0.75)			
			NPN	PNP	Pre-cabled (L = 2 m) (2)	XS8D1A1NAL2 (4)	0.390 (0.86)	
			M12 connector		XS8D1A1NAM12 (4)	0.340 (0.75)		
	NC	PNP	Pre-cabled (L = 2 m) (2)		XS8D1A1PBL2 (4)	0.390 (0.86)		
			M12 connector		XS8D1A1PBM12 (4)	0.340 (0.75)		
			NPN	PNP	Pre-cabled (L = 2 m) (2)	XS8D1A1NBL2 (4)	0.390 (0.86)	
					M12 connector	XS8D1A1NBM12 (4)	0.340 (0.75)	
	Two-wire \sim or $\overline{\text{---}}$ unprotected (4)							
	60 (2.36)	NO			-	Pre-cabled (L = 2 m) (2)	XS8D1A1MAL2 (4)	0.390 (0.86)
			1/2"-20UNF connector	XS8D1A1MAU20 (4)		0.340 (0.75)		
		NC	-	Pre-cabled (L = 2 m) (2)	XS8D1A1MBL2 (4)	0.390 (0.86)		
1/2"-20UNF connector				XS8D1A1MBU20 (4)	0.340 (0.75)			

(1) For further information on flush or non-flush mountable sensors using teach mode, see page 2/70.

(2) For a 5 m cable replace L2 with L5; for a 10 m cable replace L2 by L10.

(3) A 0.4 A fast-acting fuse must be connected in series with the load.

(4) For clipping onto 35 mm omega rail or 80 x 80 x 40 mm format, add DIN to the end of the catalog number. Example: **XS8D1A1PAL2DIN**.

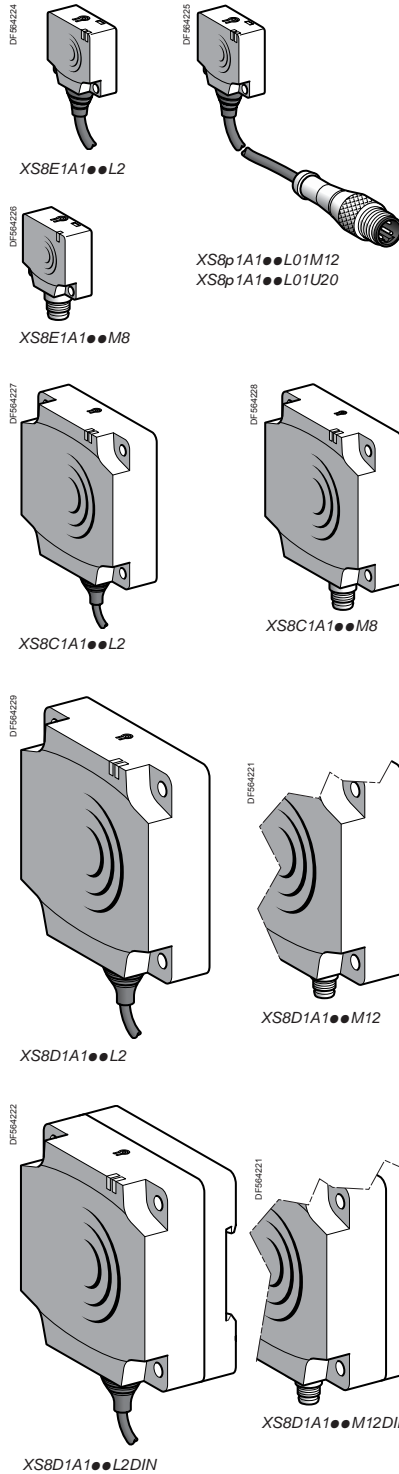

2

Specifications,
Wiring Diagrams,
Setup,
Dimensions

OsiSense® XS

Inductive proximity sensors

General Purpose with increased range
Flat, flush mountable/non-flush mountable + teach mode (1)
Two-wire AC or DC
Three-wire DC, solid-state output

2

Specifications		XS8E●●●●●M8, XS8C●●●●●M8, XS8D●●●●●M12, XS8D●●●●●U20	XS8E●●●●●L01M12, XS8E●●●●●L01U20, XS8C●●●●●L01M12, XS8C●●●●●L01U20	XS8E●●●●●L2, XS8C●●●●●L2, XS8D●●●●●L2
Sensor type				
Product certifications		UL, CSA, CE		
Connection	Connector	M8 except XS8●●●●●M12: M12 XS8●●●●●U20: 1/2"-20UNF	Remote on 0.15 m pigtail connector XS8●●●●●L01M12: M12 XS8●●●●●L01U20: 1/2"-20UNF	–
	Pre-cabled	–	–	Length: 2 m
Sensing distance and adjustment zone	XS8E	Nominal sensing dist. Sn	mm (in.) 0–15 (0–0.59) non-flush mounted / 0–10 (0–0.39) flush mounted	
		Fine adjustment zone	mm (in.) 5–15 (0.20–0.59) non-flush mounted / 5–10 (0.20–0.39) flush mounted	
	XS8C	Nominal sensing dist. Sn	mm (in.) 0–25 (0–0.98) non-flush mounted / 0–15 (0–0.59) flush mounted	
		Fine adjustment zone	mm (in.) 8–25 (0.31–0.98) non-flush mounted / 8–15 (0.31–0.59) flush mounted	
XS8D	Nominal sensing dist. Sn	mm (in.) 0–60 (0–2.36) non-flush mounted / 0–40 (0–1.57) flush mounted		
	Fine adjustment zone	mm (in.) 0–60 (0–2.36) non-flush mounted / 20–40 (0.79–1.57) flush mounted		
Differential travel		%	1–15 of effective sensing distance (Sr)	
Degree of protection		Conforming to IEC 60529	IP 67, double insulation □ (except M8 connector: IP 67) IP 68, □	
Storage temperature		°C (°F)	–40 to +85 (–40 to +185)	
Operating temperature		°C (°F)	–25 to +70 (–13 to +158)	
Materials	Case	PBT		
	Cable	–	PvR 3 x 0.34 mm ² (24 AWG) ∴ and PvR 2 x 0.34 mm ² (24 AWG) ∽	
Vibration resistance		Conforming to IEC 60068-2-6	25 gn, amplitude ± 2 mm (f = 10 to 55 Hz)	
Shock resistance		Conforming to IEC 60068-2-27	50 gn, duration 11 ms	
Indicators	Output state	Yellow LED		
	Supply on and teach mode	Green LED		
Rated supply voltage	3-wire	V	12–24 with protection against reverse polarity	
	2-wire	V	~ or ∴ 24–240 (~ 50/60 Hz)	
Voltage limits (including ripple)	3-wire	V	10–36	
	2-wire	V	~ or ∴ 20–264	
Current consumption, no-load		3-wire	mA ≤ 10	
Residual current, open state		2-wire	mA ≤ 1.5	
Switching capacity		3-wire	mA ≤ 100 XS8E, ≤ 200 XS8C and XS8D, with overload and short-circuit protection	
	2-wire	mA 5–200 ∽ XS8E, 5–300 ∽ XS8C and XS8D, 5–200 ∴ XS8C and XS8D		
Voltage drop, closed state		3-wire	V ≤ 2	
	2-wire	V ≤ 5.5		
Maximum switching frequency			Hz 2,000 XS8E, 1,000 XS8C, 150 XS8D	
Delays	First-up	ms	≤ 10 XS8E, XS8C and XS8D (3-wire), ≤ 10 XS8E and XS8C, ≤ 15 XS8D (2-wire)	
	Response	ms	≤ 0.3	
	Recovery	ms	≤ 0.8 XS8E and XS8C, ≤ 6 XS8D	

Wiring diagrams

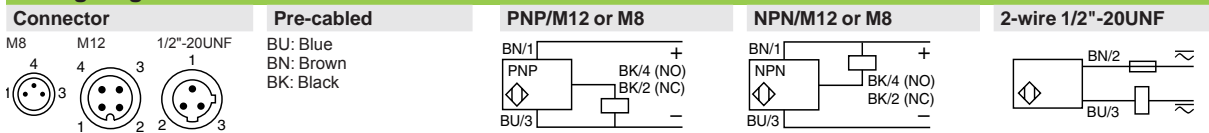

Setup

Minimum mounting distances (mm)		XS8E	XS8C	XS8D
Side by side	$e \geq$			
	Flush mounted	40	60	200
	Non-flush mounted	150	125	600
Face to face	$e \geq$			
	Flush mounted	80	120	400
	Non-flush mounted	300	250	–
Facing a metal object	$e \geq$			
		10	15	40

Dimensions (mm)

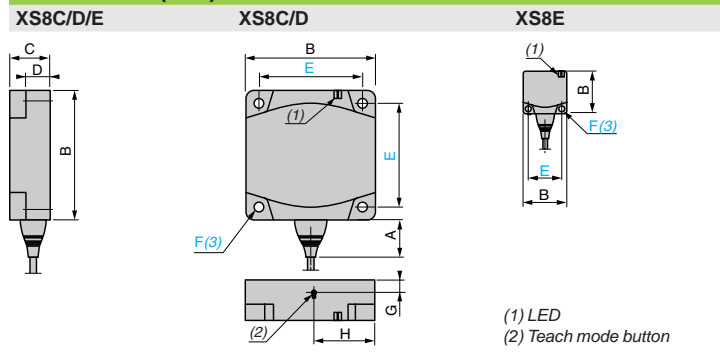

Sensor	A (cable)	A (connector)	B	C	D	E	F	G	H
XS8E	14	11	26	13	8.8	20	3.5	6.8	6.6
XS8C	14	11	40	15	9.8	33	4.5	8.3	13.6
XS8D	23	18	80	26	16	65	5.5	8.5	37.8
XS8D●●DIN	23	18	80	40	30	65	5.1	22.5	37.8

OsiSense® XS

Inductive proximity sensors

General Purpose, standard range
Flat format, flush mountable
Two-wire DC
Three-wire DC, solid-state output

Flat, 8 x 22 x 8 mm format ⁽¹⁾

Three-wire ---

Sensing distance Sn, mm (in.)	Function	Output	Connection	Catalog Number	Weight kg (lb)
2.5 (0.10)	NO	PNP	Pre-cabled (L = 2 m) (2)	XS7J1A1PAL2	0.060 (0.13)
			Remote M8 connector on 0.15 m pigtail connector	XS7J1A1PAL01M8	0.040 (0.09)
	NPN	Pre-cabled (L = 2 m) (2)	XS7J1A1NAL2	0.060 (0.13)	
		Remote M8 connector on 0.15 m pigtail connector	XS7J1A1NAL01M8	0.040 (0.09)	
	NC	PNP	Pre-cabled (L = 2 m) (2)	XS7J1A1PBL2	0.060 (0.13)
			Remote M8 connector on 0.15 m pigtail connector	XS7J1A1PBL01M8	0.040 (0.09)
	NPN	Pre-cabled (L = 2 m) (2)	XS7J1A1NBL2	0.060 (0.13)	
		Remote M8 connector on 0.15 m pigtail connector	XS7J1A1NBL01M8	0.040 (0.09)	

Two-wire ---

Sensing distance Sn, mm (in.)	Function	Connection	Catalog Number	Weight kg (lb)
2.5 (0.10)	NO	Pre-cabled (L = 2 m) (2)	XS7J1A1DAL2	0.050 (0.11)
		Remote M8 connector on 0.15 m pigtail connector	XS7J1A1DAL01M8	0.035 (0.08)
	NC	Pre-cabled (L = 2 m) (2)	XS7J1A1DBL2	0.050 (0.11)
		Remote M8 connector on 0.15 m pigtail connector	XS7J1A1DBL01M8	0.035 (0.08)

Flat, 15 x 32 x 8 mm format

Three-wire ---

Sensing distance Sn, mm (in.)	Function	Output	Connection	Catalog Number	Weight kg (lb)
5 (0.20)	NO	PNP	Pre-cabled (L = 2 m) (2)	XS7F1A1PAL2	0.065 (0.14)
			Remote M8 connector on 0.15 m pigtail connector	XS7F1A1PAL01M8	0.045 (0.10)
	NPN	Pre-cabled (L = 2 m) (2)	XS7F1A1NAL2	0.065 (0.14)	
		Remote M8 connector on 0.15 m pigtail connector	XS7F1A1NAL01M8	0.045 (0.10)	
	NC	PNP	Pre-cabled (L = 2 m) (2)	XS7F1A1PBL2	0.065 (0.14)
			Remote M8 connector on 0.15 m pigtail connector	XS7F1A1PBL01M8	0.045 (0.10)
	NPN	Pre-cabled (L = 2 m) (2)	XS7F1A1NBL2	0.065 (0.14)	
		Remote M8 connector on 0.15 m pigtail connector	XS7F1A1NBL01M8	0.045 (0.10)	

Two-wire ---

Sensing distance Sn, mm (in.)	Function	Connection	Catalog Number	Weight kg (lb)
5 (0.20)	NO	Pre-cabled (L = 2 m) (2)	XS7F1A1DAL2	0.055 (0.12)
		Remote M8 connector on 0.15 m pigtail connector	XS7F1A1DAL01M8	0.045 (0.10)
	NC	Pre-cabled (L = 2 m) (2)	XS7F1A1DBL2	0.055 (0.12)
		Remote M8 connector on 0.15 m pigtail connector	XS7F1A1DBL01M8	0.045 (0.10)

(1) Sensors **XS7J** include a mounting clamp with screw.

(2) For a 5 m cable replace L2 with L5; for a 10 m cable replace L2 by L10.

Example: **XS7J1A1PAL2** becomes **XS7J1A1PAL5** with a 5 m cable.

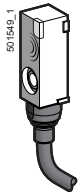

XS7J1A1●●L2

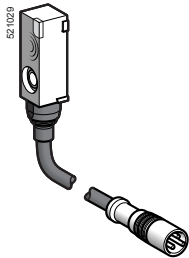

XS7J1A1●●L01M8

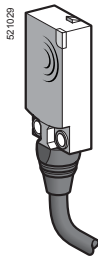

XS7F1A1●●L2

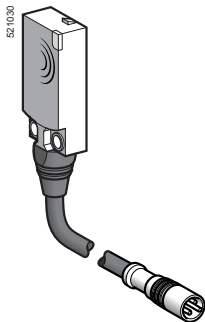

XS7F1A1●●L01M8

2

Specifications,
Wiring Diagrams,
Setup,
Dimensions

OsiSense® XS

Inductive proximity sensors

General Purpose, standard range
Flat format, flush mountable
Two-wire DC
Three-wire DC, solid-state output

2

Specifications		XS7J●●●●●L01M8	XS7F●●●●●L01M8	XS7J●●●●●L2, XS7F●●●●●L2
Sensor type		CE	UL, CSA, CE	
Product certifications				
Connection	Connector	Remote M8 connector on 0.15 m pigtail connector		–
	Pre-cabled	–		Length: 2 m
Operating zone	XS7J	mm	0–2 (0–0.08 in.)	
	XS7F	mm	0–4 (0–0.16 in.)	
Differential travel		%	1–15 of effective sensing distance (Sr)	
Degree of protection	Conforming to IEC 60529		IP 67 (XS7J), IP 68 (XS7F)	
Storage temperature		°C	–40 to +85 (–40 to +185 °F)	
Operating temperature		°C	–25 to +70 (–13 to +158 °F)	
Materials	Case		PBT	
	Cable		PvR 3 x 0.11 mm ² (26 AWG) or 2 x 0.11 mm ² (26 AWG) (XS7 F: 2 or 3 x 0.34 mm ² [24 AWG])	
Vibration resistance	Conforming to IEC 60068-2-6		25 gn, amplitude ± 2 mm (f = 10 to 55 Hz)	
Shock resistance	Conforming to IEC 60068-2-27		50 gn, duration 11 ms	
Output state indication			Yellow LED	
Rated supply voltage		V	– 12–24 with protection against reverse polarity	
Voltage limits (including ripple)		V	– 10–36	
Current consumption, no-load	3-wire	mA	≤ 10	
Residual current, open state	2-wire	mA	≤ 0.5	
Switching capacity	3-wire	mA	100 with overload and short-circuit protection	
	2-wire	mA	1.5–100 with overload and short-circuit protection	
Voltage drop, closed state	3-wire	V	≤ 2	
	2-wire	V	≤ 4	
Maximum switching frequency	3-wire	kHz	2	
	2-wire	kHz	4 for XS7J, 5 for XS7F	
Delays	First-up	ms	3-wire: 5	
		ms	2-wire: 10 XS7J, 5 XS7F	
	Response	ms	3-wire: 0.1	
		ms	2-wire: 0.5 XS7J, 5 XS7F	
Recovery	ms	3-wire: 0.1		
	ms	2-wire: 1 XS7J, 5 XS7F		

Wiring diagrams

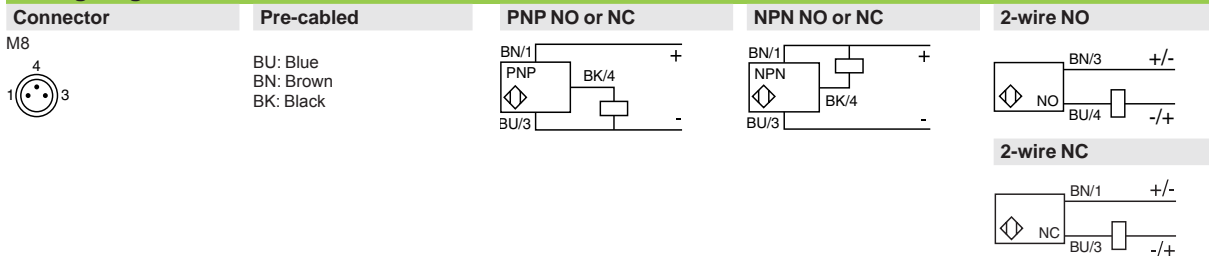

Setup

Minimum mounting distances (mm)

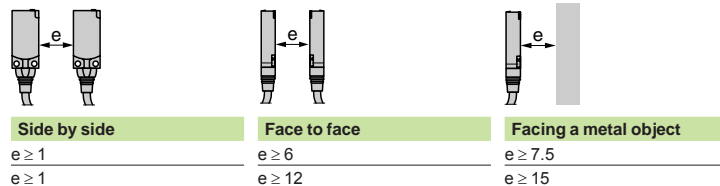

Dimensions (mm)

XS7F

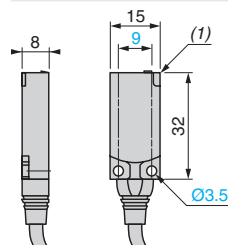

XS7J

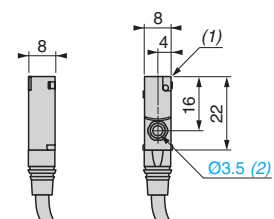

(1) LED
(2) For CHC type screws

OsiSense® XS

Inductive proximity sensors

General Purpose, standard range
Flat format, flush mountable
Two-wire DC
Three-wire DC, solid-state output

2

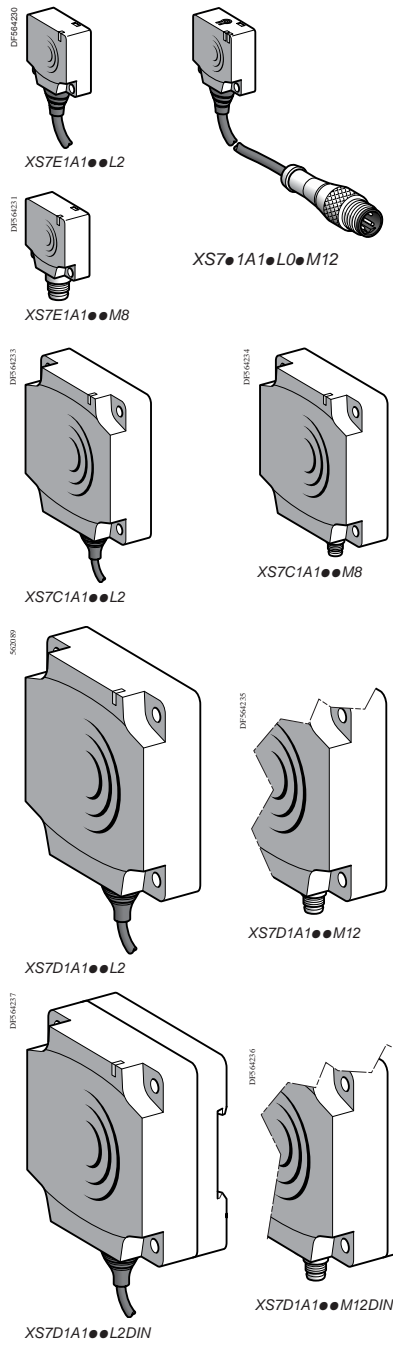

Sens. dist. Sn, mm (in.)	Function	Output	Connection	Catalog Number
--------------------------	----------	--------	------------	----------------

Flat, 26 x 26 x 13 mm format

				Weight	
Three-wire ---				kg	(lb)
10 (0.39)	NO	PNP	Pre-cabled (L = 2 m) (3)	XS7E1A1PAL2	0.075 (0.17)
			M8 connector	XS7E1A1PAM8	0.040 (0.09)
			Remote M12 connector	XS7E1A1PAL01M12	0.040 (0.09)
		NPN	Pre-cabled (L = 2 m) (3)	XS7E1A1NAL2	0.075 (0.17)
			M8 connector	XS7E1A1NAM8	0.075 (0.17)
			Remote M12 connector	XS7E1A1NAL01M12	0.040 (0.09)
	NC	PNP	Pre-cabled (L = 2 m) (3)	XS7E1A1PBL2	0.075 (0.17)
			M8 connector	XS7E1A1PBM8	0.040 (0.09)
			Remote M12 connector	XS7E1A1PBL01M12	0.040 (0.09)
		NPN	Pre-cabled (L = 2 m) (3)	XS7E1A1NBL2	0.075 (0.17)
			M8 connector	XS7E1A1NBM8	0.040 (0.09)
			Remote M12 connector	XS7E1A1NBL01M12	0.040 (0.09)

Two-wire ---

10 (0.39)	NO		Pre-cabled (L = 2 m) (3)	XS7E1A1DAL2	0.070 (0.15)
			M8 connector	XS7E1A1DAM8	0.040 (0.09)
			Remote M12 connector	XS7E1A1DAL01M12	0.040 (0.09)
		NO terminals 1 and 4 (1)	Remote M12 connector	XS7E1A1CAL01M12	0.040 (0.09)
			Remote M12 connector (2)	XS7E1A1CAL08M12	0.065 (0.14)
			NC	Pre-cabled (L = 2 m) (3)	XS7E1A1DBL2
	M8 connector	XS7E1A1DBM8		0.040 (0.09)	
	Remote M12 connector	XS7E1A1DBL01M12		0.040 (0.09)	

Flat, 40 x 40 x 15 mm format

				Weight	
Three-wire ---				kg	(lb)
15 (0.59)	NO	PNP	Pre-cabled (L = 2 m) (3)	XS7C1A1PAL2	0.095 (0.21)
			M8 connector	XS7C1A1PAM8	0.060 (0.13)
			Remote M12 connector	XS7C1A1PAL01M12	0.060 (0.13)
		NPN	Pre-cabled (L = 2 m) (3)	XS7C1A1NAL2	0.095 (0.21)
			M8 connector	XS7C1A1NAM8	0.060 (0.13)
			Remote M12 connector	XS7C1A1NAL01M12	0.060 (0.13)
	NC	PNP	Pre-cabled (L = 2 m) (3)	XS7C1A1PBL2	0.095 (0.21)
			M8 connector	XS7C1A1PBM8	0.060 (0.13)
			Remote M12 connector	XS7C1A1PBL01M12	0.060 (0.13)
		NPN	Pre-cabled (L = 2 m) (3)	XS7C1A1NBL2	0.095 (0.21)
			M8 connector	XS7C1A1NBM8	0.060 (0.13)
			Remote M12 connector	XS7C1A1NBL01M12	0.060 (0.13)

Two-wire ---

15 (0.59)	NO		Pre-cabled (L = 2 m) (3)	XS7C1A1DAL2	0.090 (0.20)
			M8 connector	XS7C1A1DAM8	0.060 (0.13)
			Remote M12 connector	XS7C1A1DAL01M12	0.060 (0.13)
		NO terminals 1 and 4 (1)	Remote M12 connector	XS7C1A1CAL01M12	0.060 (0.13)
			Remote M12 connector (2)	XS7C1A1CAL08M12	0.090 (0.20)
			NC	Pre-cabled (L = 2 m) (3)	XS7C1A1DBL2
	M8 connector	XS7C1A1DBM8		0.060 (0.13)	
	Remote M12 connector	XS7C1A1DBL01M12		0.060 (0.13)	

Flat, 80 x 80 x 26 mm format

				Weight	
Three-wire ---				kg	(lb)
40 (1.57)	NO	PNP	Pre-cabled (L = 2 m) (3)	XS7D1A1PAL2 (4)	0.340 (0.75)
			M12 connector	XS7D1A1PAM12 (4)	0.290 (0.64)
			NPN	Pre-cabled (L = 2 m) (3)	XS7D1A1NAL2 (4)
		M12 connector		XS7D1A1NAM12 (4)	0.290 (0.64)
		NC		Pre-cabled (L = 2 m) (3)	XS7D1A1PBL2 (4)
			M12 connector	XS7D1A1PBM12 (4)	0.290 (0.64)
	NPN		Pre-cabled (L = 2 m) (3)	XS7D1A1NBL2 (4)	0.340 (0.75)
		M12 connector	XS7D1A1NBM12 (4)	0.290 (0.64)	

Two-wire ---

40 (1.57)	NO		Pre-cabled (L = 2 m) (3)	XS7D1A1DAL2 (4)	0.340 (0.75)	
			M12 connector	XS7D1A1DAM12 (4)	0.290 (0.64)	
			NO terminals 1 and 4 (1)	M12 connector	XS7D1A1CAM12 (4)	0.290 (0.64)
		NC		Pre-cabled (L = 2 m) (3)	XS7D1A1DBL2 (4)	0.340 (0.75)
				M12 connector	XS7D1A1DBM12 (4)	0.290 (0.64)

(1) The NO output is connected to terminals 1 and 4 of the M12 connector.
 (2) Remote connector on 0.8 m pigtail connector.
 (3) For a 5 m cable replace L2 with L5; for a 10 m cable replace L2 by L10. Example: **XS7J1A1PAL2** becomes **XS7J1A1PAL5** with a 5 m cable.
 (4) For clipping onto 35 mm omega rail or 80 x 80 x 40 mm format, add DIN to the end of the catalog number. Example: **XS7D1A1PAL2** becomes **XS7D1A1PAL2DIN**.

Specifications,
Wiring Diagrams,
Setup,
Dimensions

OsiSense® XS

Inductive proximity sensors

General Purpose, standard range
Flat format, flush mountable
Two-wire DC
Three-wire DC, solid-state output

2

Specifications			XS7E●●●●M8, XS7C●●●●M8, XS7D●●●●M12	XS7E●●●●L01M12, XS7C●●●●L01M12	XS7E●●●●L2, XS7C●●●●L2, XS7D●●●●L2
Sensor type					
Product certifications			UL, CSA, CE		
Connection	Connector		M8 except M12 on XS7D●●●●M12	M12 on 0.15 m pigtail connector for XS7●●●●L01M12	–
	Pre-cabled		–	–	Length: 2 m
Operating zone	XS7E	mm	0–8 (0–0.31 in.)		
	XS7C	mm	0–12 (0–0.47 in.)		
	XS7D	mm	0–32 (0–1.26)		
Differential travel		%	1–15 of effective sensing distance (Sr)		
Degree of protection	Conforming to IEC 60529		IP 67, double insulation □ (except for M8 connector: IP 67)		IP 68, □
Storage temperature		°C	–40 to +85 (–40 to +185 °F)		
Operating temperature		°C	–25 to +70 (–13 to +158 °F)		
Materials	Case		PBT		
	Cable		–	PvR 3 x 0.34 mm ² (24 AWG) or 2 x 0.34 mm ² (24 AWG)	
Vibration resistance	Conforming to IEC 60068-2-6		25 gn, amplitude ± 2 mm (f = 10 to 55 Hz)		
Shock resistance	Conforming to IEC 60068-2-27		50 gn, duration 11 ms		
Output state indication			Yellow LED		
Rated supply voltage		V	12–24 with protection against reverse polarity		
Voltage limits (including ripple)		V	10–36		
Current consumption, no-load	3-wire	mA	≤ 10		
Residual current, open state	2-wire	mA	≤ 0.5		
Switching capacity	3-wire	mA	≤ 100 with overload and short-circuit protection		
	2-wire	mA	1.5–100 with overload and short-circuit protection		
Voltage drop, closed state	3-wire	V	≤ 2		
	2-wire	V	≤ 4		
Maximum switching frequency	XS7E, XS7C	kHz	1		
	XS7D	Hz	100		
Delays	First-up	3-wire	10 XS7E and XS7C , 30 XS7D		
		2-wire	5 XS7E and XS7D , 10 XS7D		
	Response	3-wire	2 XS7E and XS7C , 5 XS7D		
		2-wire	0.3 XS7E and XS7D , 10 XS7D		
	Recovery	3-wire	6 XS7E , 5 XS7C , 35 XS7D		
		2-wire	0.7 XS7E and XS7D , 10 XS7D		

Wiring diagrams

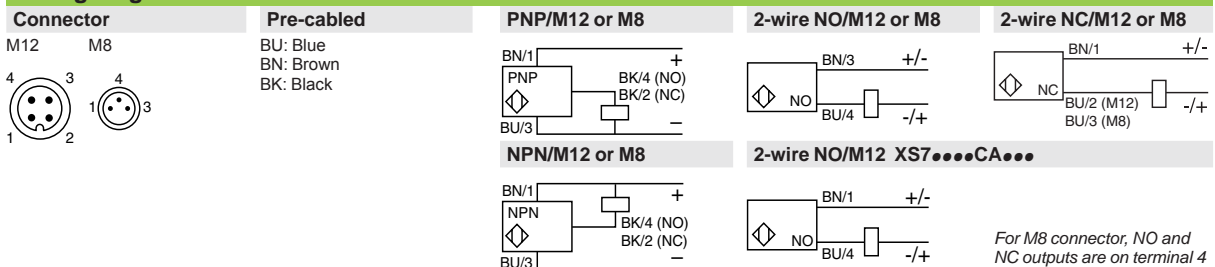

Setup

Minimum mounting distances (mm)			XS7E	XS7C	XS7D
Side by side		e ≥	4	5	40
Face to face		e ≥	72	110	300
Facing a metal object		e ≥	30	45	120

Dimensions (mm)

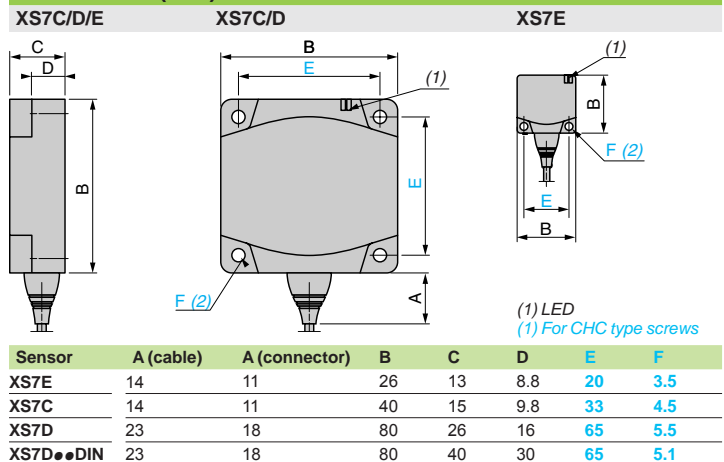

OsiSense® XS Inductive proximity sensors

Application

Flat sensor, flush mountable, increased range,
switching capacity 300 mA

80 x 80 x 40 format, DIN rail mounting, solid-state output

Sensor | Flush mountable in metal

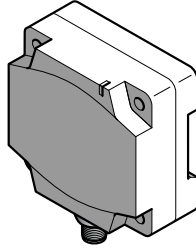

2

Dimensions (mm)	80 x 80 x 40	
Nominal sensing distance S _n , mm (in.)	50 (1.97) (non-flush mounted: 42 [1.65])	
Catalog Numbers		
2-wire ∴ (non-polarized)	NO	XS7D1A3CAM12DIN
Weight, kg (lb)	0.374 (0.82)	
Specifications		
Product certifications	CE; CSA, UL: pending	
Degree of protection	Conforming to IEC 60529	IP 67, double insulation □
Temperature	Operating	-25 to + 70 °C (-13 to +158 °F)
	Storage	- 40 to + 85 °C (-40 to +185 °F)
Vibration resistance	Conforming to IEC 60068-2-6	25 gn, amplitude ± 2 mm (f = 10 to 55 Hz)
Shock resistance	Conforming to IEC 60068-2-27	50 gn, duration 11 ms
Connection	M12 connector	
Operating zone, mm (in.)	0–40 (0–1.57) (non-flush mounted: 0–35 [0–1.35])	
Repeat accuracy	3% of S _r	
Differential travel	1–15% of S _r	
Output state indication	Yellow LED	
Rated supply voltage	∴ 12–48 V with protection against reverse polarity	
Voltage limits (including ripple)	∴ 10–58 V	
Residual current, open state	≤ 0.5 mA	
Switching capacity	1.5–300 mA with overload and short-circuit protection	
Voltage drop, closed state	≤ 4.5 V	
Maximum switching frequency	100 Hz	
Delays	First-up	≤ 10 ms
	Response	≤ 2 ms
	Recovery	≤ 5 ms

Dimensions, Setup, Wiring Diagrams

OsiSense® XS Inductive proximity sensors

Application

Flat sensor, flush mountable, increased range,
switching capacity 300 mA

80 x 80 x 40 format, DIN rail mounting, solid-state output

Dimensions (mm)

XS7D1A3CAM12DIN

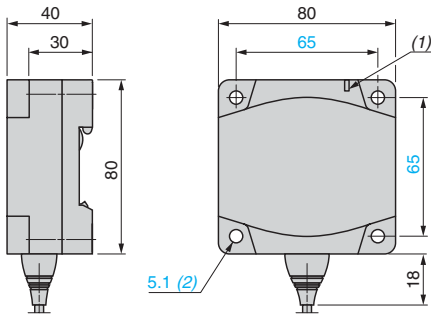

(1) Output LED
(2) For CHC type screws

2

Setup

Minimum mounting distances (mm)

	Face to face	Side by side	Back to back	Facing a metal object
Flush mounted	450	140	90	150
Non-flush mounted	450	180	180	150

Flush/non-flush conditions

In A37 steel



Sn	Su	Sn	Su
42 mm	35 mm	50 mm	40 mm

Wiring diagrams

2-wire NO/M12 XS7D1A3CAM12DIN



OsiSense® XS

Inductive proximity sensors

General Purpose
Plastic case, limit switch style
5-position turret head. DC supply

2

Sensor	Flush mountable in metal			Non-flush mountable in metal		
--------	--------------------------	--	--	------------------------------	--	--



Nominal sensing distance Sn, mm (in.)	15 (0.59)	Increased range 20 (0.79)	15 (0.59)	20 (0.79)	Increased range 40 (1.57)	20 (0.79)	
Catalog Numbers							
4-wire $\overline{\text{---}}$ (complementary outputs)	PNP NO + NC	XS7C40PC440H7	XS7C40PC449H7	–	XS8C40PC440H7	XS8C40PC449H7	–
	NPN NO + NC	XS7C40NC440H7	XS7C40NC449H7	–	XS8C40NC440H7	XS8C40NC449H7	–
2-wire $\overline{\text{---}}$ (non-polarized)	NO	–	–	XS7C40DA210H7	–	–	XS8C40DA210H7
	NO or NC programmable	–	–	XS7C40DP210H7	–	–	XS8C40DP210H7
Weight, kg (lb)	0.220 (0.49)	0.220 (0.49)	0.220 (0.49)	0.220 (0.49)	0.220 (0.49)	0.220 (0.49)	
Specifications							
Product certifications	UL, CSA, CE						
Degree of protection conforming to IEC 60529	IP 67						
Operating temperature	-25 to +70 °C (-13 to +158 °F)						
Connection (1)	Screw terminals, clamping capacity: 2 or 4 x 1.5 mm ² (16 AWG) (2)						
Operating zone, mm (in.)	0–12 (0–0.47)	0–16 (0–0.63)	0–12 (0–0.47)	0–16 (0–0.63)	0–32 (0–1.26)	0–16 (0–0.63)	
Repeat accuracy	≤ 3% of effective sensing distance (Sr)						
Differential travel	3–20% of effective sensing distance (Sr)						
Status indication	Output	Yellow LED		Yellow LED	Yellow LED	Yellow LED	
	Supply on	Green LED		–	Green LED	–	
Rated supply voltage	$\overline{\text{---}}$ 12–48 V with protection against reverse polarity						
Voltage limits (including ripple)	$\overline{\text{---}}$ 10–58 V						
Current consumption, no-load	≤ 10 mA		–	≤ 10 mA		–	
Switching capacity	0–200 mA		1.5–100 mA		0–200 mA		
	With overload and short-circuit protection						
Residual current, open state	–		≤ 0.5 mA		–		
Voltage drop, closed state	≤ 2 V		≤ 4 V		≤ 2 V		
Maximum switching frequency	1000 Hz		1500 Hz		1000 Hz		
					500 Hz		
Delays	First-up	≤ 5 ms		≤ 5 ms		≤ 5 ms	
	Response	≤ 0.3 ms		≤ 2 ms		≤ 0.3 ms	
	Recovery	≤ 0.7 ms		≤ 5 ms		≤ 0.7 ms	

(1) Delete "H7" suffix for PG13 conduit entry.
(2) Cable gland not included with sensor. For suitable metric version PG13 cable gland (XSZPE13), see page 2/131.

Dimensions, Setup, Wiring Diagram

OsiSense® XS Inductive proximity sensors

General Purpose

Plastic case, limit switch style, 5-position turret head,
DC supply

Dimensions (mm)

XS7C40D●210, XS8C40D●210

XS7C40●C44●, XS8C40●C44●

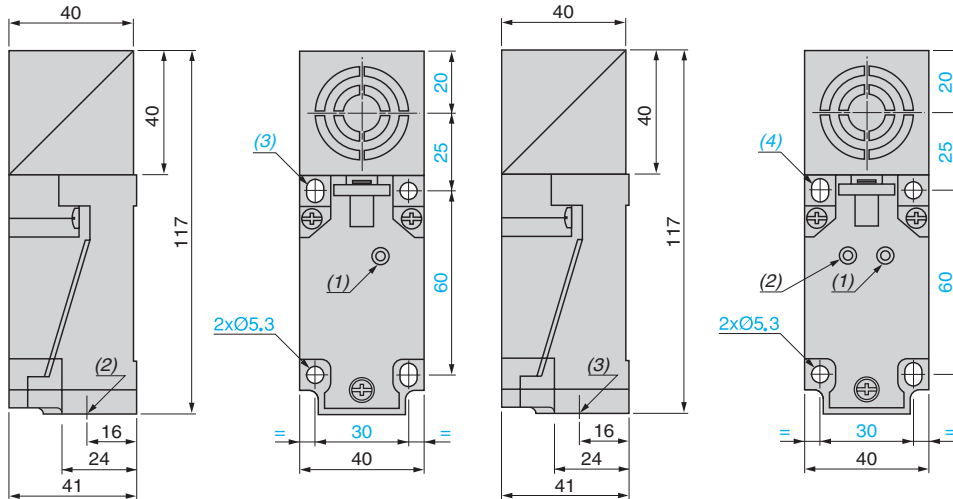

(1) Output LED.
(2) 1 tapped entry for 1/2" NPT conduit entry.
(3) 2 elongated holes Ø 5.3 x 7.

(1) Output LED.
(2) Supply LED.
(3) 1 tapped entry for 1/2" NPT conduit entry.
(4) 2 elongated holes Ø 5.3 x 7.

2

Setup

Minimum mounting distances (mm)

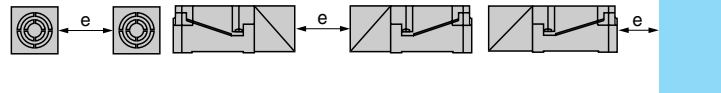

		Side by side	Face to face	Facing a metal object
Sensors flush mountable in metal	XS7	$e \geq 40$	$e \geq 120$	$e \geq 45$
	XS7 increased range model	$e \geq 80$	$e \geq 240$	$e \geq 60$
Sensors non-flush mountable in metal	XS8	$e \geq 80$	$e \geq 160$	$e \geq 60$
	XS8 increased range model	$e \geq 160$	$e \geq 320$	$e \geq 120$

Tightening torque of cover mounting screws and clamp screws: $< 1.2 \text{ N}\cdot\text{m}$ (10.62 lb-in)

Wiring diagrams

2-wire --- (non-polarized), NO or NC output depending on position of link

4-wire --- , NO + NC output

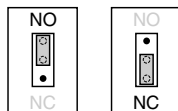
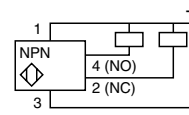
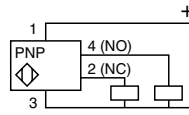
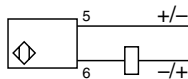

OsiSense® XS

Inductive proximity sensors

General Purpose
Plastic case, limit switch style, plug-in
5-position turret head, AC or DC supply

2

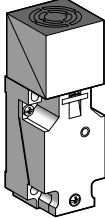
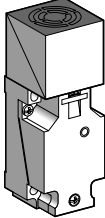
Sensor		Flush mountable in metal		Non-flush mountable in metal	
					
		AC	AC/DC	AC	AC/DC
Nominal sensing distance S_n , mm (in.)		15 (0.59)		20 (0.79)	
Catalog Numbers					
2-wire ~	NO or NC programmable	XS7C40FP260H7	–	XS8C40FP260H7	–
2-wire ~ or ☰ universal model	NO or NC programmable	–	XS7C40MP230H7	–	XS8C40MP230H7
Weight, kg (lb)		0.220 (0.49)	0.220 (0.49)	0.220 (0.49)	0.220 (0.49)
Specifications					
Product certifications		UL, CSA, CE			
Degree of protection conforming to IEC 60529		IP 67			
Operating temperature		-25 to +70 °C (-13 to +158 °F)			
Connection		Screw terminals, clamping capacity 2 x 1.5 mm ² (16 AWG) (1) (2)			
Operating zone, mm (in.)		0–12 (0–0.47)		0–16 (0–0.63)	
Repeat accuracy		≤ 3% of effective sensing distance (Sr)			
Differential travel		3–20% of effective sensing distance (Sr)			
Output state indication		Yellow LED			
Rated supply voltage with protection against reverse polarity		~ 24–240 V, 50/60 Hz	~ 24–240 V, 50/60 Hz or ☰ 24–210 V	~ 24–240 V, 50/60 Hz	~ 24–240 V, 50/60 Hz or ☰ 24–210 V
Voltage limits (including ripple)		~ 20–264 V	~ or ☰ 20–264 V	~ 20–264 V	~ or ☰ 20–264 V
Current consumption, no-load		–			
Switching capacity (3)		5–500 mA (2) (2 A inrush)	~ 5–300 mA or ☰ 5–200 mA (2)	5–500 mA (2) (2 A inrush)	~ 5–300 mA or ☰ 5–200 mA (2)
Residual current, open state		≤ 1.5 mA	0.8 mA on 24 V 1.5 mA on 120 V	≤ 1.5 mA	0.8 mA on 24 V 1.5 mA on 120 V
Voltage drop, closed state		≤ 5.5 V			
Maximum switching frequency		25 Hz	~ 25 Hz, ☰ 50 Hz	25 Hz	~ 25 Hz, ☰ 50 Hz
Delays					
		First-up	≤ 120 ms		
		Response	≤ 30 ms		
		Recovery	≤ 20 ms		

(1) Delete H7 suffix for PG13 conduit entrance
 (2) Cable gland not included with sensor. For suitable metric version PG13 cable gland (XSZPE13), see page 2/131.
 (3) These sensors do not incorporate overload or short-circuit protection. A fast-acting fuse must be connected in series with the load.

Dimensions, Setup, Wiring Diagram

OsiSense® XS Inductive proximity sensors

General Purpose

Plastic case, limit switch style, plug-in
5-position turret head, AC or DC supply

Dimensions (mm)

XS7C40FP260H7, XS7C40MP230H7, XS8C40FP260H7, XS8C40MP230H7

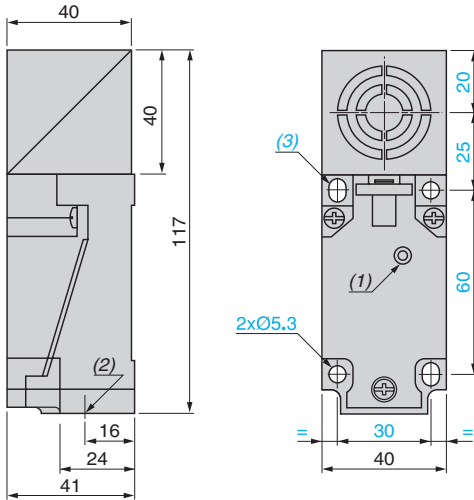

- (1) Output LED.
- (2) 1 tapped entry for 1/2" NPT conduit entry.
- (3) 2 elongated holes \varnothing 5.3 x 7.

2

Setup

Minimum mounting distances (mm)

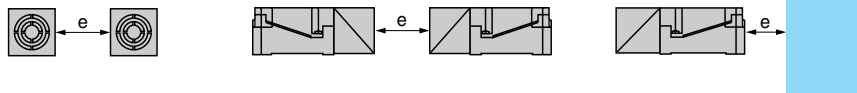

	Side by side	Face to face	Facing a metal object
XS7 flush mountable	$e \geq 40$	$e \geq 120$	$e \geq 45$
XS8 non-flush mountable	$e \geq 80$	$e \geq 160$	$e \geq 60$

Tightening torque of cover mounting screws and clamp screws: $< 1.2 \text{ N}\cdot\text{m}$ (10.62 lb-in)

Wiring diagrams

2-wire a programmable, NO or NC output depending on position of link

2-wire \sim or --- programmable, NO or NC output depending on position of link

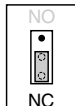
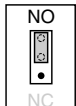
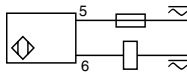
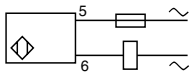

OsiSense® XS Inductive proximity sensors

Application

For conveying and material handling applications
Plastic case, cubic 40 form, multi-position, DC supply

Sensor	Flush mountable in metal	Non-flush mountable in metal
--------	--------------------------	------------------------------

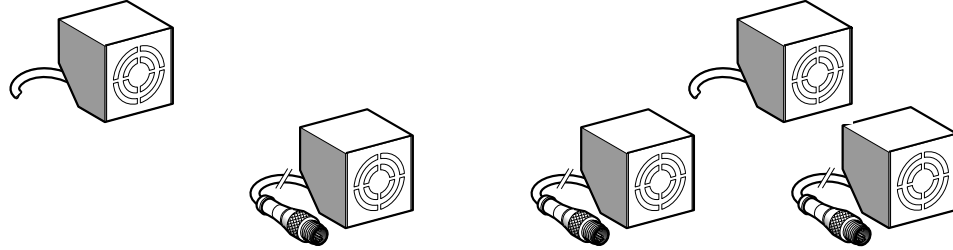

2

Nominal sensing distance S_n , mm (in.)	15 (0.59)	20 (0.79)
---	-----------	-----------

Catalog Numbers							
2-wire $\overline{\text{---}}$ (non-polarized)	NO	XS7T4DA210	–	XS7T4DA214LD	–	XS7T4DA214LD01	–
4-wire $\overline{\text{---}}$ (complementary outputs)	PNP NO + NC	–	XS7T4PC440	–	XS7T4PC440LD	–	XS8T4PC440 XS8T4PC440LD
	NPN NO + NC	–	XS7T4NC440	–	XS7T4NC440LD	–	XS8T4NC440 XS8T4NC440LD
Weight, kg (lb)		0.265 (0.01)	0.265 (0.01)	0.220 (0.01)	0.220 (0.01)	0.200 (0.01)	0.265 (0.01) 0.220 (0.01)

Specifications							
Product certifications	UL, CSA, CE						
Degree of protection Conforming to IEC 60529	IP 67						
Operating temperature	- 25 to + 70 °C (-13 to 158 °F)						
Connection	Pre-cabled	2 x 0.5 mm ² (22 AWG) length 2 m (1)	4 x 0.34 mm ² (22 AWG) length 2 m (1)	–	–	4 x 0.34 mm ² (22 AWG) length 2 m (1)	–
	Connector Remote M12	–	–	0.8 m pigtail connector	0.15 m pigtail connector	–	0.8 m pigtail connector
Operating zone, mm (in.)	0–12 (0–0.47)					0–16 (0–0.63)	
Repeat accuracy	≤ 3% of S_r (effective sensing distance)						
Differential travel	3–20% of S_r (effective sensing distance)						
Output state indication	Yellow LED, on rear						
Rated supply voltage	$\overline{\text{---}}$ 12–48 V with protection against reverse polarity						
Voltage limits (including ripple)	$\overline{\text{---}}$ 10–58 V						
Current consumption, no-load	–	≤ 10 mA	–	≤ 10 mA	–	≤ 10 mA	–
Switching capacity	1.5–100 mA	0–200 mA	1.5–100 mA	0–200 mA	1.5–100 mA	0–200 mA	–
With overload and short-circuit protection							
Residual current, open state	≤ 0.7 mA	≤ 0.1 mA	≤ 0.7 mA	≤ 0.1 mA	≤ 0.7 mA	≤ 0.1 mA	–
Voltage drop, closed state	≤ 5.2 V	≤ 2 V	≤ 5.2 V	≤ 2 V	≤ 5.2 V	≤ 2 V	–
Maximum switching frequency	150 Hz	1000 Hz	150 Hz	1000 Hz	150 Hz	1000 Hz	–
Delays	First-up	≤ 5 ms	≤ 7 ms	≤ 5 ms	≤ 7 ms	≤ 5 ms	≤ 7 ms
	Response	≤ 2 ms	≤ 0.3 ms	≤ 2 ms	≤ 0.3 ms	≤ 2 ms	≤ 0.3 ms
	Recovery	≤ 5 ms	≤ 0.7 ms	≤ 5 ms	≤ 0.7 ms	≤ 5 ms	≤ 0.7 ms

(1) Sensors available with other cable lengths:

Length of cable	Suffix to be added to catalog numbers stated above for 2 m pre-cabled sensors	Weight increase, kg (lb)
5 m	L1	0.120 (0.01)
10 m	L2	0.320 (0.01)

Example: sensor XS7T4DA210 with 5 m cable becomes XS7T4DA210L1

Other versions Sensors specifically designed for other operating temperatures. consult the Sensor Competency Center.

Dimensions, Setup, Wiring Diagrams

OsiSense® XS Inductive proximity sensors

Application

For conveying and material handling applications
Plastic case, cubic 40 form, multi-position, DC supply

Dimensions (mm)

XS7T4●●●●●, XS7T4●●●●●LD, XS7T4●●●●●LD01

Plate mounted

Bracket mounted

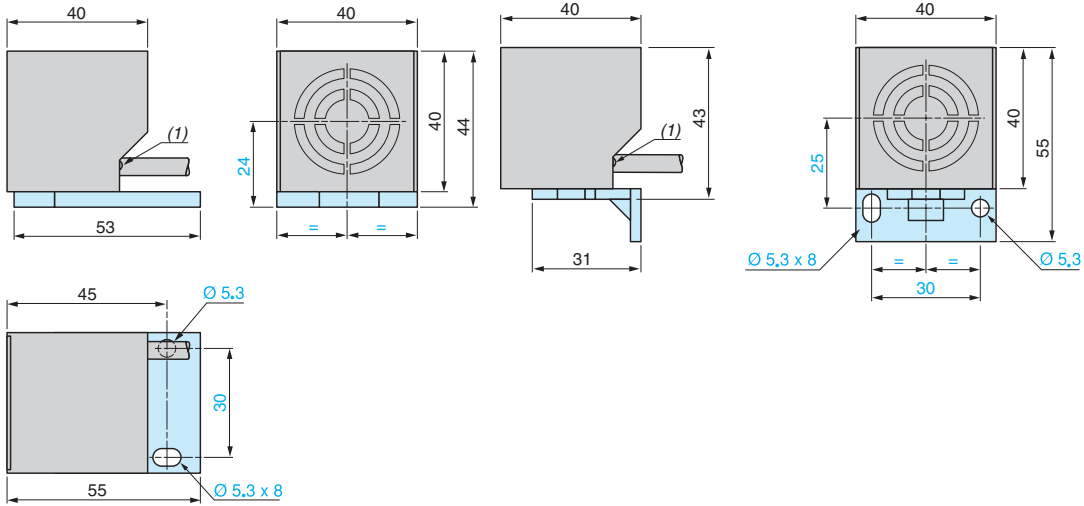

(1) LED.

Alternative positions of head

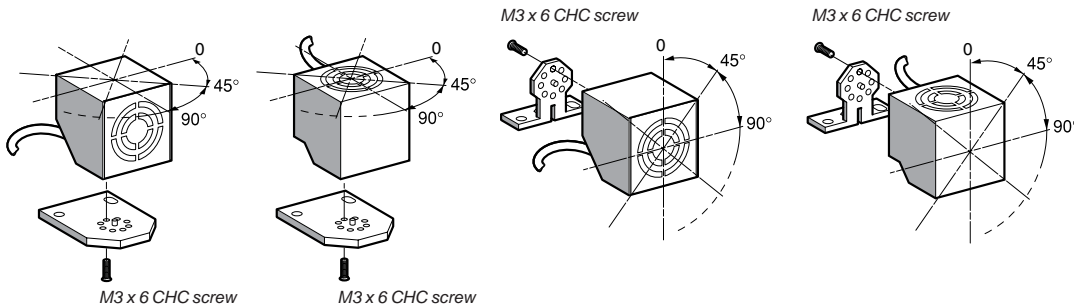

Setup

Minimum mounting distances (mm)

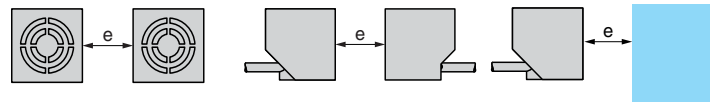

		Side by side	Face to face	Facing a metal object
Sensors flush mountable in metal	XS7T, 2-wire	$e \geq 40$	$e \geq 120$	$e \geq 45$
	XS7T, 4-wire	$e \geq 40$	$e \geq 120$	$e \geq 45$
Sensors non-flush mountable in metal	XS8T, 4-wire	$e \geq 60$	$e \geq 160$	$e \geq 60$

Wiring diagrams

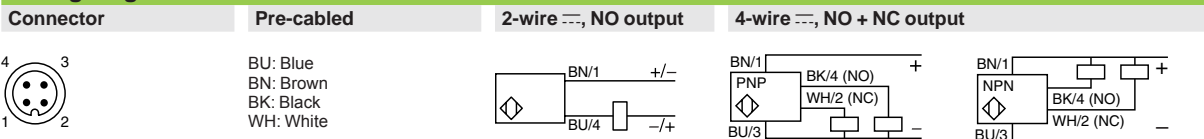

2

OsiSense® XS

Inductive proximity sensors

Application

For assembly, packaging and light material handling

Plastic case, 12 x 26 x 40 mm

DC supply, solid-state output

Sensor	Flush mountable in metal	Non-flush mountable in metal
--------	--------------------------	------------------------------

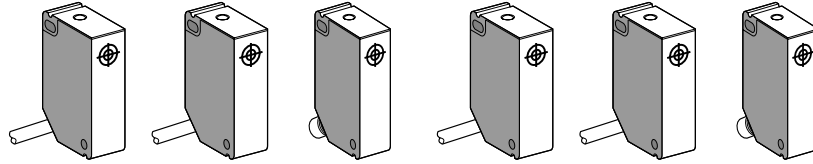

Nominal sensing distance S_n , mm (in.)	2 (0.08)	4 (0.16)
---	----------	----------

Catalog Numbers

3-wire ---	PNP NO	XS7G12PA140	–	XS7G12PA140S	XS8G12PA140	–	XS8G12PA140S
	NPN NO	XS7G12NA140	–	XS7G12NA140S	XS8G12NA140	–	XS8G12NA140S
4-wire ---	PNP NO + NC	–	XS7G12PC440	–	–	XS8G12PC440	–
	NPN NO + NC	–	XS7G12NC440	–	–	XS8G12NC440	–
Weight, kg (lb)		0.100 (0.22)	0.100 (0.22)	0.030 (0.07)	0.100 (0.22)	0.100 (0.22)	0.030 (0.07)

Specifications

Product certifications	CSA, UL, CE						
Connection	Pre-cabled	3 x 0.34 mm ² (24 AWG), length 2 m (1)	4 x 0.34 mm ² (24 AWG), length 2 m (1)	–	3 x 0.34 mm ² (24 AWG), length 2 m (1)	4 x 0.34 mm ² (24 AWG), length 2 m (1)	–
	Connector	–	–	M8	–	–	M8
Operating zone, mm (in.)	0–1.6 (0–0.06)			0–3.2 (0–0.13)			
Repeat accuracy	≤ 10% of S_r						
Differential travel	3–20% of S_r						
Degree of protection	IP 67						
Storage temperature	–40 to +85 °C (–40 to +185 °F)						
Operating temperature	–25 to +70 °C (–13 to +158 °F)						
Materials	Case: PBT, cable: PVC						
Vibration resistance	25 gn, amplitude ± 2 mm (f = 10 to 55 Hz)						
Shock resistance	50 gn, duration 11 ms						
Output state indication	Yellow LED (on top of case)						
Rated supply voltage	--- 12–24 V	--- 12–48 V	--- 12–24 V	--- 12–24 V	--- 12–48 V	--- 12–24 V	
Voltage limits (including ripple)	--- 10–30 V	--- 10–58 V	--- 10–30 V	--- 10–30 V	--- 10–58 V	--- 10–30 V	
Current consumption, no-load	≤ 10 mA						
Switching capacity	0–100 mA (2)	0–200 mA (2)	0–100 mA (2)	0–100 mA (2)	0–200 mA (2)	0–100 mA (2)	
Voltage drop, closed state	≤ 1.8 V	≤ 2.6 V	≤ 1.8 V	≤ 1.8 V	≤ 2.6 V	≤ 1.8 V	
Maximum switching frequency	≤ 2 kHz			≤ 1 kHz			
Delays	First-up	≤ 4 ms					
	Response	≤ 0.5 ms					
	Recovery	≤ 1 ms					

(1) Sensors available with other cable lengths:

Length of cable	Suffix to be added to catalog numbers stated above for 2 m pre-cabled sensors	Weight increase
5 m	L1	0.120 kg (0.26 lb)
10 m	L2	0.320 kg (0.71 lb)

Example: sensor XS7G12PA140 with 5 m cable becomes XS7G12PA140L1.

(2) With overload and short-circuit protection

Dimensions, Setup, Wiring Diagram

OsiSense® XS Inductive proximity sensors

Application

For assembly, packaging and light material handling

Plastic case, 12 x 26 x 40 mm

DC supply, solid-state output

Dimensions (mm)

XS●G12●A140, XS●G12●C440

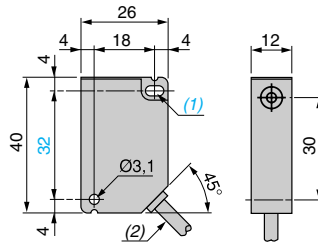

Rear view

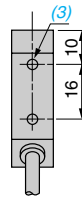

(1) 1 elongated hole $\varnothing 3.1 \times 5.1$.

(2) Cable L = 2 m.

(3) 2 holes M3 x 5.

XS●G12●A140S

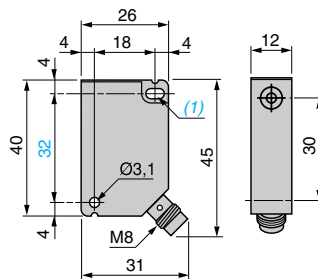

Rear view

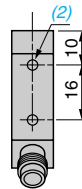

(1) 1 elongated hole $\varnothing 3.1 \times 5.1$.

(2) 2 holes M3 x 5.

Setup

Minimum mounting distances (mm)

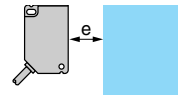
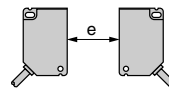
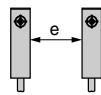

Side by side

Face to face

Facing a metal object and mounted in a metal support

XS7G flush mountable

$e \geq 0$

$e \geq 15$

$e \geq 6$

XS8G non-flush mountable

$e \geq 10$

$e \geq 60$

$e \geq 12$

Wiring diagrams

3-wire ---, NO output

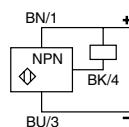
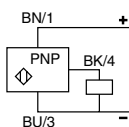

4-wire ---, NO + NC output

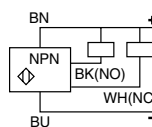
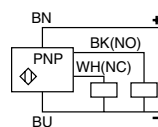

Connector

M8



2

OsiSense® XS Inductive proximity sensors

Application

For assembly, packaging and light material handling

Plastic case, 12 x 26 x 40 mm

AC or DC supply

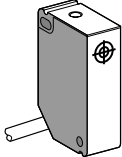
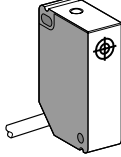
Sensor	Flush mountable in metal	Non-flush mountable in metal
		

2

Nominal sensing distance S_n , mm (in.)	2 (0.04)	4 (0.08)
---	----------	----------

Catalog Numbers

2-wire $\overline{\text{---}}$ or \sim	NO	XS7G12MA230	XS8G12MA230
	NC	XS7G12MB230	XS8G12MB230
Weight, kg (lb)	0.100 (0.22)		0.100 (0.22)

Specifications

Product certifications	CSA, UL, Cc	
Connection	Pre-cabled, 2 x 0.34 mm ² (24 AWG), length 2 m (1)	
Operating zone, mm (in.)	0–1.6 (0–0.06)	0–3.2 (0–0.13)
Repeat accuracy	≤ 10% of S_r	
Differential travel	3–20% of S_r	
Degree of protection	IP 67	
Storage temperature	-40 to +85 °C (-40 to +185 °F)	
Operating temperature	-25 to +70 °C (-13 to +158 °F)	
Materials	Case: PBT, cable: PVC	
Vibration resistance Conforming to IEC 60068-2-6	25 gn, amplitude ± 2 mm (f = 10 to 55 Hz)	
Shock resistance Conforming to IEC 60068-2-27	50 gn, duration 11 ms	
Output state indication	Yellow LED (on top of case)	
Rated supply voltage	\sim 24–240 V (50/60 Hz) or $\overline{\text{---}}$ 24–210 V	
Voltage limits (including ripple)	\sim or $\overline{\text{---}}$ 20–264 V	
Switching capacity	5–200 mA (2)	
Voltage drop, closed state	≤ 5.5 V	
Residual current, open state	≤ 0.8 mA/24 V, 1.5 mA/120 V	
Maximum switching frequency	\sim 25 Hz or $\overline{\text{---}}$ 250 Hz	
Delays	First-up	≤ 40 ms
	Response	≤ 1 ms
	Recovery	≤ 2 ms

(1) Sensors available with other cable lengths:

Length of cable	Suffix to be added to catalog numbers stated above for 2 m pre-cabled sensors	Weight increase
5 m	L1	0.120 kg (0.26 lb)
10 m	L2	0.320 kg (0.71 lb)

Example: sensor **XS7G12MA230** with 5 m cable becomes **XS7G12MA230L1**.

(2) These sensors do not incorporate overload or short-circuit protection and therefore, a 0.4 A fast-acting fuse must be connected in series with the load.

Dimensions,
Setup,
Wiring Diagram

OsiSense® XS

Inductive proximity sensors

Application

For assembly, packaging and light material handling

Plastic case, 12 x 26 x 40 mm

AC or DC supply

Dimensions (mm)

XS●G12M●230

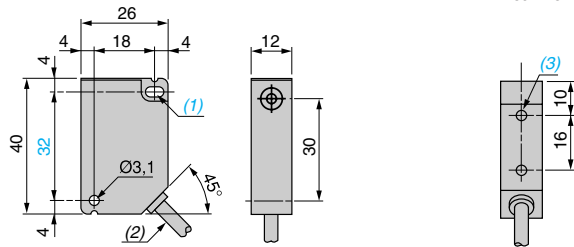

Rear view

(1) 1 elongated hole $\varnothing 3.1 \times 5.1$.

(2) Cable L = 2 m.

2

Setup

Minimum mounting distances (mm)

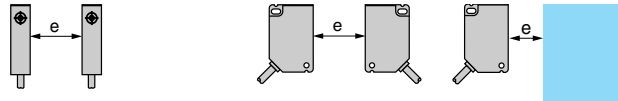

	Side by side	Face to face	Facing a metal object and mounted in a metal support
XS7G flush mountable	$e \geq 0$	$e \geq 15$	$e \geq 6$
XS8G non-flush mountable	$e \geq 10$	$e \geq 60$	$e \geq 12$

Wiring diagrams

2-wire \sim or --- , NO or NC output

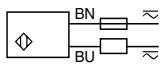

OsiSense® XS Inductive proximity sensors

Application

Sensors for rotation monitoring, slip detection, shaft overload detection, Cylindrical form

Example:
Coupling breakage monitoring

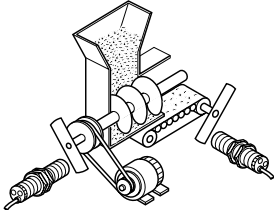
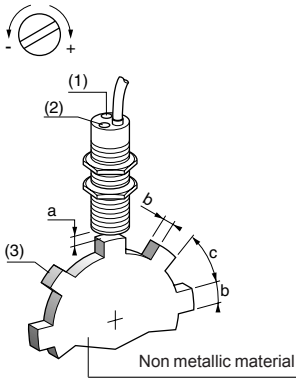

Figure 1



2

Functions

As a special feature, these self-contained rotation speed monitoring sensors incorporate, in the same case, the pulse sensing and processing electronics with the output switching amplifier, which are required to establish an integrated rotation monitoring device.

The unit provides an economical solution for detecting slip, belt breakage, drive shaft shear and overloading, etc., in the following applications: conveyor belts, bucket elevators, Archimedian screws, grinders, crushers, pumps, centrifugal driers, mixers, etc.

Operating principle

The output signal of this type of sensor is processed by an impulse comparator in the sensor. The impulse frequency F_c generated by the moving part to be monitored is compared to the frequency F_r preset on the sensor. The output switching circuit of the sensor is in the closed state for $F_c > F_r$ and the open state for $F_c < F_r$.

Sensors XSA-V are particularly suitable for the detection of underspeed: when the speed of the moving part F_c falls below a preset threshold F_r , this causes the output circuit of the sensor to switch off.

Note: Following power-up, the operational status of the sensor is subject to a delay of 9 seconds so the moving part being monitored and run up to its nominal speed. During this time, the output of the sensor remains in the closed state.

Adjustment of frequency threshold

- Adjustment of sensor's frequency threshold: using potentiometer, 15 turns approximately.
- To increase the frequency threshold: turn the adjustment screw clockwise (+).
- To decrease the frequency threshold: turn the adjustment screw counter clockwise (-).

Figure 1

	Diameter of sensor: $\varnothing 30$ mm			
	Distance	a	b	c
1. Potentiometer				
2. LED	mm (in.)	4-6 (0.16-0.24)	30 (1.18)	60 (2.36)
3. Metal target				

Potentiometer adjustment curves (for XSAV1●801, 2-wire ~ or --- sensors)

Low speed version (6-150 impulses/minute)

High speed version (120-3000 impulses/minute)

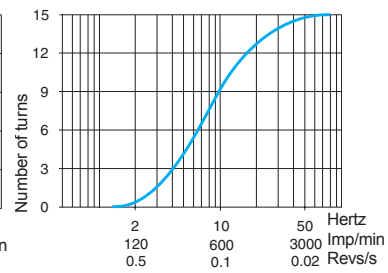
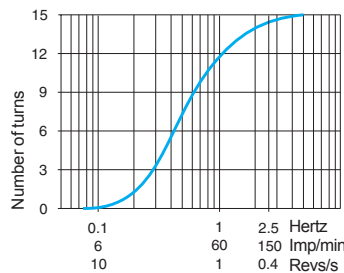

Setup

Minimum distances (mm)

Side by side

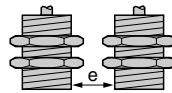

$e \geq 20$

Facing a metal object

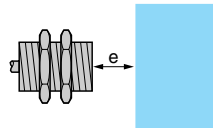

$e \geq 30$

Face to face

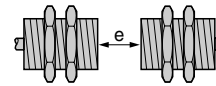

$e \geq 120$

Mounted in a metal support

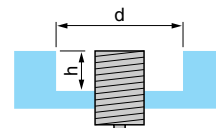

$d \geq 30, h \geq 0$

Mounting nut tightening torque: $< 50 \text{ N}\cdot\text{m}$ (442.54 lb-in)

OsiSense® XS Inductive proximity sensors

Application

Sensors for rotation monitoring, slip detection, shaft overload detection, Cylindrical form

Flush mountable in metal

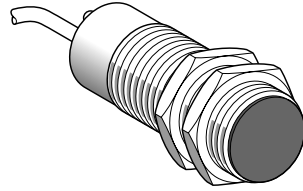
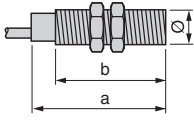

Lengths (mm):
a = Overall
b = Threaded section

	DC	DC	AC/DC	AC/DC
Nominal sensing distance (Sn)	10 mm (0.39 in.)	10 mm (0.39 in.)	10 mm (0.39 in.)	10 mm (0.39 in.)
Adjustable frequency range	6–150 impulses/min	120–3000 impulses/min	6–150 impulses/min	120–3000 impulses/min

Catalog Numbers

3-wire PNP / NC	XSAV11373	XSAV12373	–	–
2-wire ~ or ~ / NC	–	–	XSAV11801	XSAV12801
Weight, kg (lb)	0.300 (0.66)			

Specifications

Connection	Pre-cabled, 3 x 0.34 mm ² (22 AWG), length 2 m (1)	Pre-cabled, 2 x 0.34 mm ² (22 AWG), length 2 m (1)
Degree of protection conforming to IEC 60529	IP 67	
Operating zone, mm (in.)	0–8 mm (0–0.31)	
Repeat accuracy	3% of Sr	
Differential travel	3–15% of Fr	
Operating temperature	-25 to +70 °C (-13 to +158 °F)	
Output state indication	Red LED	
Rated supply voltage	~ 12–48 V with protection against reverse polarity	~ 24–240 V (50/60 Hz) or ~ 24–210 V
Voltage limits (including ripple)	~ 10–58 V	~ or ~ 20–264 V
Switching capacity	≤ 200 mA with overload and short-circuit protection	~ 5–350 mA or ~ 5–200 mA (2)
Voltage drop, closed state	≤ 1.8 V	≤ 5.7 V
Residual current, open state	≤ 15 mA	≤ 1.5 mA
Current consumption, no-load	≤ 15 mA	–
Maximum switching frequency	6000 impulses/min (for XSAV11●●●); 48,000 impulses/min (for XSAV12●●●)	
Run-up delay following power-up	9 seconds ± 20% + 1/Fr (3)	

Wiring diagrams

3-wire ~
XSAV1●373

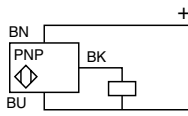

2-wire ~ or ~
XSAV1●801

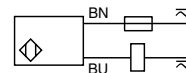

(1) For a 5 m cable add L05 to the catalog number, for a 10 m cable add L10.

Example: XSA V11373 becomes XSAV11373L05 with a 5 m cable.

(2) These sensors do not incorporate overload or short-circuit protection and therefore, it is essential to connect a 0.4 A fast-acting fuse in series with the load, see page 2/131.

(3) For a sensor without a run-up delay following power-up, replace XSA V1 in the catalog number by XSAV0. Example: XSA V11801 becomes XSAV01801 without a run-up delay. For a reduced run-up delay of 3 s, replace XSAV1 in the catalog number with XSAV3.

OsiSense® XS

Inductive proximity sensors

Application

Sensors for rotation monitoring, slip detection and shaft overload detection, with teach mode

Operating principle and applications

2

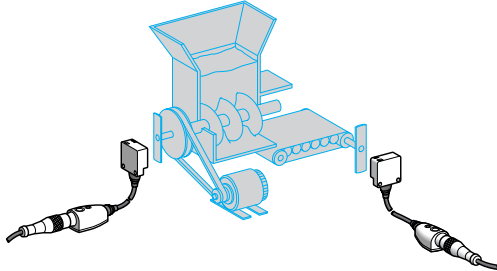

- These inductive proximity sensors are designed for monitoring rotational speed or the speed of the flow of objects to be protected or monitored. They operate on the principle of comparing a speed threshold preset by the operator against the instantaneous measurement of the speed of the moving object to be protected.

- They provide a simple, economical solution for detecting slip, belt breakage, coupling breakage and overload, etc.

- They are widely used in grinder/crusher, mixer, pump, centrifugal driver, conveyor belt, bucket elevator, Archimedean screw, etc. type applications.

Installation and setup

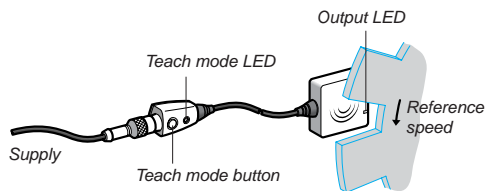

Setup and positioning the sensor

- In the positioning phase, the XS9 sensor can operate as a standard inductive sensor (Schneider Electric patent pending). Operation in inductive mode enables validation of reliable detection of all the moving objects to be monitored.

- Using this system, the positioning is reliable and can be checked at any time without altering the settings of the sensor.

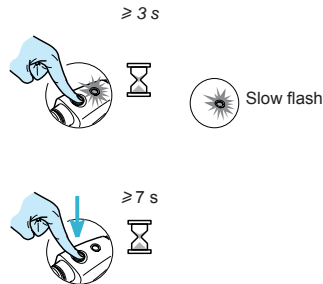

Speed adjustment in teach mode

- The normal or reference speed of the moving object (1) to be monitored is adjusted by simply pressing the teach mode button (2) and is then validated by the display LED.

□ If in doubt, the sensor can be reset at any time to the factory settings.

(1) To allow the moving object to reach its normal speed (machine inertia), the sensor holds its output closed for 9 seconds.

(2) The sensor's default drop-out underspeed corresponds to the preset speed - 30%.

Example: If the preset speed is 1000 rpm, the sensor drops out on underspeed when the speed of the moving object drops below 700 rpm [1000 - (1000 x 0.3)].

- 20%, - 11% and - 6% thresholds can be obtained by pressing the teach mode button.

Setup

Minimum mounting distances (mm)

Type	Side by side	Face to face
XS9E	e ≥ 40	e ≥ 80
XS9C	e ≥ 60	e ≥ 120

Dimensions (mm)

XS9E, XS9C

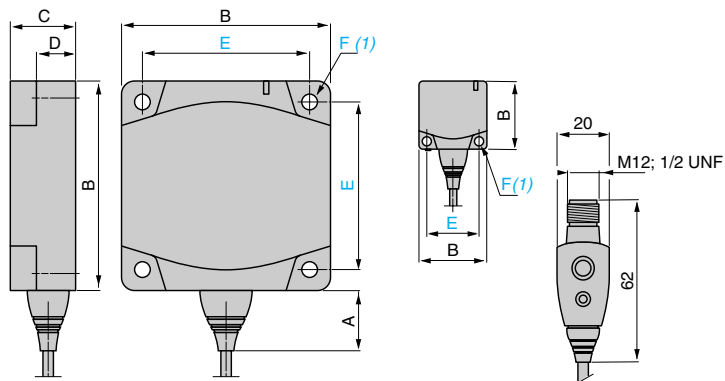

(1) For CHC type screws

Type	A	B	C	D	E	F
XS9E	14	26	13	8.8	20	3.5
XS9C	14	40	15	9.8	33	4.5

OsiSense® XS Inductive proximity sensors

Application

Sensors for rotation monitoring, slip detection and shaft overload detection, with teach mode

Flush mountable in metal

PBT case

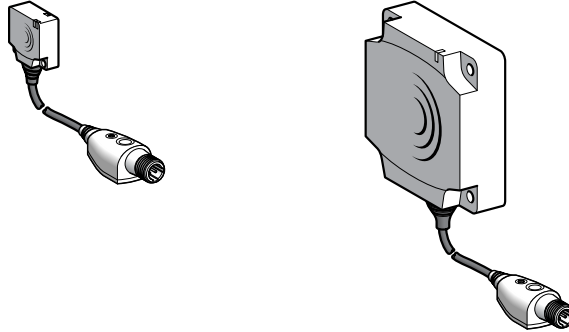

2

Nominal sensing distance S_n , mm (in.)	10 (0.39)	15 (0.59)	10 (0.39)	15 (0.59)
Adjustable frequency range	6 to 6000 impulses/min			

Catalog Numbers

3-wire	PNP / NC	XS9E11RPBL01M12	XS9C11RPBL01M12	–	–
2-wire	⋯ or ~ / NC	–	–	XS9E11RMBL01U20	XS9C11RMBL01U20
Weight, kg (lb)		0.040 (0.09)	0.060 (0.13)	0.040 (0.09)	0.060 (0.13)

Specifications

Product certifications	UL, CSA, CE				
Connection	Remote M12 connector on 0.15 m pigtail connector		Remote 1/2"-20UNF connector on 0.15 m pigtail connector		
Operating zone, mm (in.)	0-8 (0-0.31)		0-12 (0-0.47)		0-12 (0-0.47)
Degree of protection	Conforming to IEC 60529	IP 67, double insulation			
Storage temperature	-40 to +85 °C (-40 to +185 °F)				
Operating temperature	-25 to +70 °C (-13 to +158 °F)				
Vibration resistance	Conforming to IEC 60068-2-6	25 gn, amplitude ± 2 mm (f = 10 to 55 Hz)			
Shock resistance	Conforming to IEC 60068-2-27	50 gn, duration 11 ms			
Indicators	Output state	Yellow LED			
	Supply on	Green LED			
Rated supply voltage	⋯ 12-24 V			~ or ⋯ 24-240 V (50/60 Hz)	
Voltage limits (including ripple)	⋯ 10-36 V			~ or ⋯ 20-264 V	
Switching capacity		≤ 100 mA (1)	≤ 200 mA (1)	~ or ⋯ 5-100 mA (2)	⋯ 5-200 mA, ~ 5-300 mA(2)
	Voltage drop, closed state	≤ 2 V		≤ 5.5 V	
Residual current, open state	≤ 100 mA		≤ 1.5 mA		
Current consumption, no-load	≤ 10 mA		–		
Maximum switching frequency	48,000 impulses/min				
Run-up delay following power-up	9 seconds + 1/Fr				

(1) With overload and short-circuit protection.

(2) A 0.4 A fast-acting fuse must be connected in series with the load.

Wiring diagrams

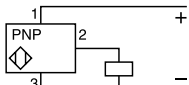
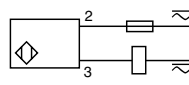
Connector		3-wire ⋯	2-wire ~ or ⋯
M12	1/2"-20UNF	XS9E11RPBL01M12	XS9E11RMBL01U20
			

Accessory

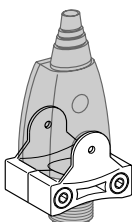

XSZBPM12

Description	Catalog Number	Weight kg
Remote control mounting clamp	XSZBPM12	0.015

OsiSense® XS Inductive proximity sensors

Application

Sensors with analog output signal 0–10 V ⁽¹⁾
or 4–20 mA

For position, displacement and deformation control/monitoring

Functions

Example:
Sorting parts

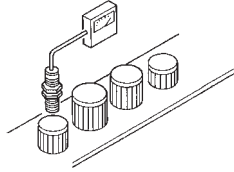

These analog output proximity sensors are solid-state sensors designed for monitoring displacement. They are not measuring sensors. They are suitable for use in many sectors, particularly for applications involving:

- deformation and displacement monitoring,
- vibration amplitude and frequency monitoring,
- control of dimensional tolerances,
- position control,
- concentricity or eccentricity monitoring.

2

Operating principle

The operating principle of the sensor is that of a damped oscillator. The degree of damping will depend on the distance of an object from the sensing face. The sensor will sense the distance and produce an output current with a value directly proportional to this distance.

Operating curves 4–20 mA, 2-wire connection

XS1M12AB120

Sn = 0.2–2 mm (0.02–0.08 in.)

Ø 12 mm

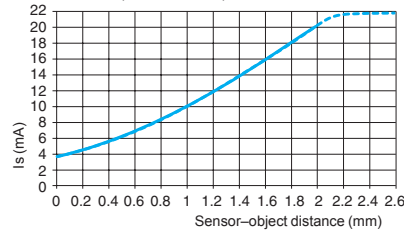

XS1M18AB120

Sn = 0.5–5 mm (0.02–0.20 in.)

Ø 18 mm

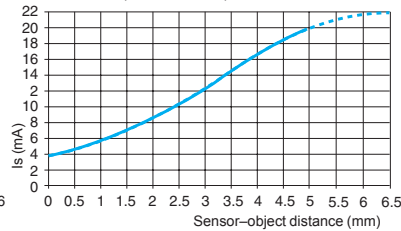

XS1M30AB120

Sn = 1–10 mm (0.04–0.39 in.)

Ø 30 mm

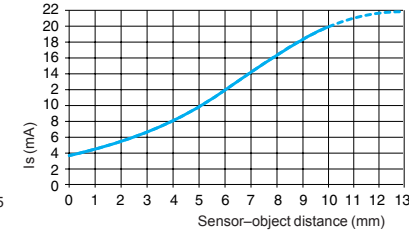

XS4P12AB120

Sn = 0.4–4 mm (0.02–0.16 in.)

Ø 12 mm

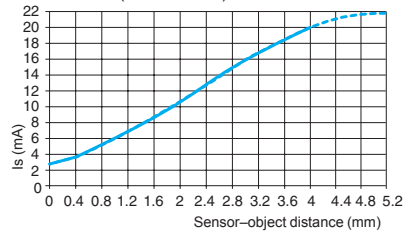

XS4P18AB120

Sn = 0.8–8 mm (0.03–0.31 in.)

Ø 18 mm

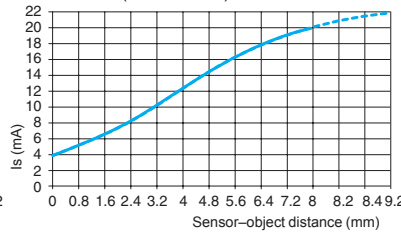

XS4P30AB120

Sn = 1.5–15 mm (0.06–0.59 in.)

Ø 30 mm

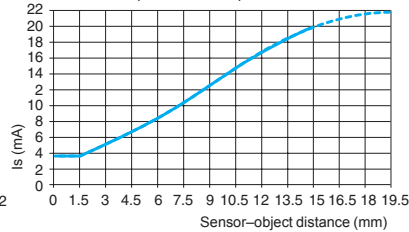

Operating curves 0–10 V, 3-wire connection

XS4P12AB110

Sn = 0.4–4 mm (0.02–0.16 in.)

Ø 12 mm

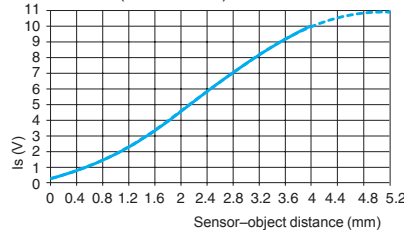

XS4P18AB110

Sn = 0.4–4 mm (0.02–0.16 in.)

Ø 18 mm

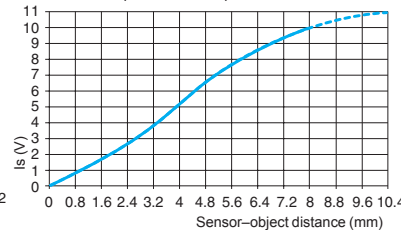

XS4P30AB110

Sn = 0.4–4 mm (0.02–0.16 in.)

Ø 30 mm

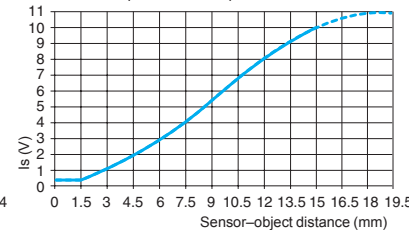

Wiring diagrams

2-wire connection

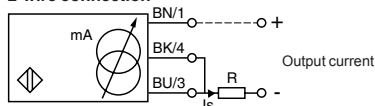

Output current	Load impedance value
12 V	4–20 mA
	$R \leq 8.2 \Omega$
24 V	4–20 mA
	$R \leq 470 \Omega$

Ensure a minimum of 10 V between the + and the - (terminal 3) of the sensor.

(1) Voltage range only obtained with a load impedance of 1000 Ω .

3-wire connection

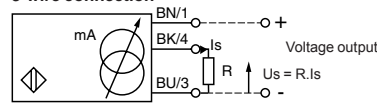

Output current	Load impedance value	Output voltage	Load impedance value
24 V	0–10 mA	0–10 V	$R = 1000 \Omega$
48 V	0–10 mA	0–10 V	$R = 1000 \Omega$
			$R \leq 1500 \Omega$
			$R \leq 3300 \Omega$

Ensure a minimum of 5 V between the + and the sensor output (terminal 4).

OsiSense® XS Inductive proximity sensors

Application

Sensors with analog output signal 0–10 V ⁽¹⁾
or 4–20 mA

For position, displacement and deformation control/monitoring

Sensor	Flush mountable in metal	Non-flush mountable in metal	
--------	--------------------------	------------------------------	--

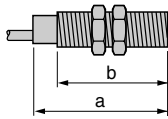

Lengths (mm):
a = Overall
b = Threaded section

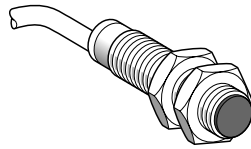

a = 50
b = 42

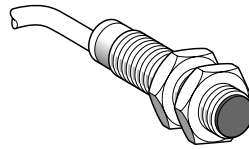

a = 50
b = 42

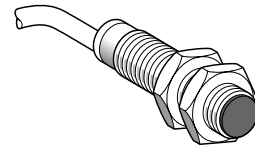

a = 50
b = 42

Nominal sensing distance S_n ,
mm (in.)

Metal case	Plastic case	Plastic case
2 (0.08)	4 (0.16)	4 (0.16)

Catalog Numbers

3-wire --- Output 0–10 V (2)	–	–	XS4P12AB110
2-wire --- Output 4–20 mA (2)	XS1M12AB120	XS4P12AB120	–
Weight, kg (lb)	0.075 (0.17)	0.065 (0.14)	0.065 (0.14)

Specifications

Product certifications	CE, UL, CSA		
Connection	Pre-cabled, PvR 3 x 0.34 mm ² (24 AWG), length 2 m		
Degree of protection Conforming to IEC 60529	IP 67		
Operating zone, mm (in.)	0.2–2 (0.01–0.08)	0.4–4 (0.02–0.16)	0.4–4 (0.02–0.16)
Repeat accuracy	± 3%		
Linearity error	± 2 mA	± 1 V	
Ambient air temperature	For operation: -25 to +70 °C (-13 to +158 °F)		
Rated supply voltage	--- 12–24 V	--- 12–24 V	--- 24–48 V
Voltage limits (including ripple)	--- 10–36 V	--- 10–36 V	--- 15–58 V
Output current drift Ambient temperature: -25 to +70 °C (-13 to +158 °F)	≤ 10%		
Current consumption, no-load	4 mA		
Maximum operating rate	1500 Hz		

(1) Voltage range only obtained with a load impedance of 1000 Ω.

(2) Output current range (Is)

Setup

Minimum mounting distances (mm) Side by side Face to face Facing a metal object Mounted in a metal support

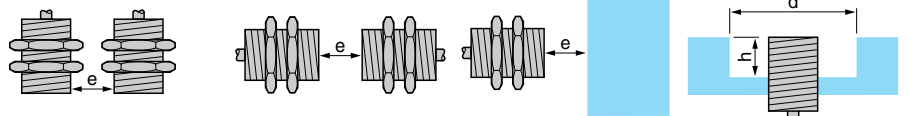

XS1M12AB120 flush mountable	$e \geq 4$	$e \geq 24$	$e \geq 6$	$d \geq 12, h \geq 0$
XS4P12AB110 non-flush mountable	$e \geq 16$	$e \geq 48$	$e \geq 12$	$d \geq 36, h \geq 8$
XS4P12AB120 non-flush mountable	$e \geq 16$	$e \geq 48$	$e \geq 12$	$d \geq 36, h \geq 8$

Mounting nut tightening torque < 6 N•m (53.10 lb-in) (metal case), < 2 N•m (17.70 lb-in) (plastic case)

Other versions Consult the Sensor Competency Center.

2

OsiSense[®] XS

Inductive proximity sensors

Application
Sensors with analog output signal 0–10 V ⁽¹⁾
or 4–20 mA

2

Sensor	Flush mountable in metal	Non-flush mountable in metal	
--------	--------------------------	------------------------------	--

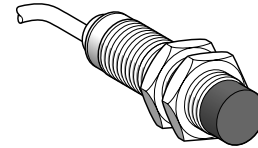
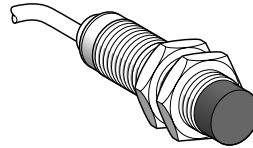
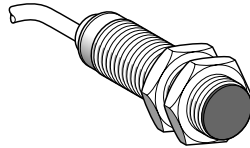
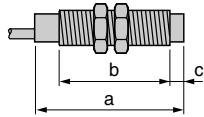

Lengths (mm):
a = Overall
b = Threaded section
c = For non-flush mountable sensors

a = 52.5
b = 44
c = 0

a = 40.6
b = 26
c = 8

a = 40.6
b = 26
c = 8

Nominal sensing distance S _n , mm (in.)	Metal case	Plastic case	Plastic case
	5 (0.20)	8 (0.31)	8 (0.31)

Catalog Numbers

3-wire $\overline{\text{---}}$ Output 0–10 V ⁽²⁾	–	–	XS4P18AB110
2-wire $\overline{\text{---}}$ Output 4–20 mA ⁽²⁾	XS1M18AB120	XS4P18AB120	–
Weight (kg)	0.120 (0.26)	0.080 (0.18)	0.080 (0.18)

Specifications

Product certifications	CE, UL, CSA		
Connection	Pre-cabled, PVR 3 x 0.34 mm ² (24 AWG), length 2 m		
Degree of protection Conforming to IEC 60529	IP 67		
Operating zone, mm (in.)	0.5–5 (0.02–0.20)	0.8–8 (0.03–0.31)	0.8–8 (0.03–0.31)
Repeat accuracy	± 3%		
Linearity error	± 2 mA		± 1 V
Ambient air temperature	For operation: -25 to +70 °C (-13 to +158 °F)		
Rated supply voltage	$\overline{\text{---}}$ 12–24 V	$\overline{\text{---}}$ 12–24 V	$\overline{\text{---}}$ 24–48 V
Voltage limits (including ripple)	$\overline{\text{---}}$ 10–36 V	$\overline{\text{---}}$ 10–36 V	$\overline{\text{---}}$ 15–58 V
Output current drift Ambient temperature: -25 to +70 °C (-13 to +158 °F)	≤ 10%		
Current consumption, no-load	4 mA		
Maximum operating rate	500 Hz		

⁽¹⁾ Voltage range only obtained with a load impedance of 1000 Ω.
⁽²⁾ Output current range I_s, see page 2/96.

Setup

Minimum mounting distances (mm)	Side by side	Face to face	Facing a metal object	Mounted in a metal support
XS1M18AB120 flush mountable	e ≥ 10	e ≥ 60	e ≥ 15	d ≥ 18, h ≥ 0
XS4P18AB110 non-flush mountable	e ≥ 32	e ≥ 96	e ≥ 24	d ≥ 54, h ≥ 16
XS4P18AB120 non-flush mountable	e ≥ 32	e ≥ 96	e ≥ 24	d ≥ 54, h ≥ 16

Mounting nut tightening torque < 15 N·m (132.76 lb-in) (metal case), < 5 N·m (44.25 lb-in) (plastic case)

Other versions Consult the Sensor Competency Center.

OsiSense® XS

Inductive proximity sensors

Application
Sensors with analog output signal 0–10 V ⁽¹⁾
or 4–20 mA

2

Sensor	Flush mountable in metal	Non-flush mountable in metal	
--------	--------------------------	------------------------------	--

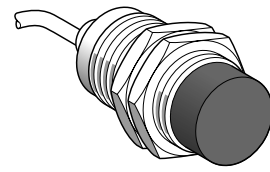
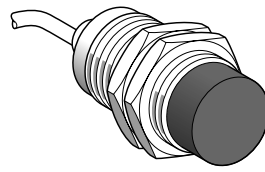
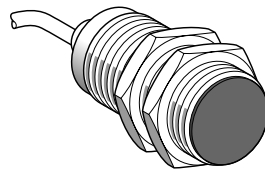
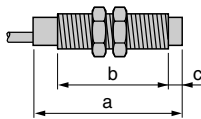

Lengths (mm):
a = Overall
b = Threaded section
c = For non-flush mountable sensors

a = 50
b = 42
c = 0

a = 52.6
b = 32
c = 13

a = 52.6
b = 32
c = 13

	Metal case	Plastic case	Plastic case
Nominal sensing distance S_n , mm (in.)	10 (0.39)	15 (0.59)	15 (0.59)

Catalog Numbers

3-wire --- Output 0–10 V (2)	–	–	XS4P30AB110
2-wire --- Output 4–20 mA (2)	XS1M30AB120	XS4P30AB120	–
Weight, kg (lb)	0.200 (0.44)	0.100 (0.22)	0.100 (0.22)

Specifications

Product certifications	CE, UL, CSA		
Connection	Pre-cabled, PvR 3 x 0.34 mm ² (22 AWG), length 2 m		
Degree of protection Conforming to IEC 60529	IP 67		
Operating zone, mm (in.)	1–10 (0.04–0.39)	1.5–15 (0.06–0.59)	1.5–5 (0.06–0.20)
Repeat accuracy	± 3%		
Linearity error	± 2 mA		± 1 V
Ambient air temperature	For operation: - 25 to + 70 °C (-13 to +158 °F)		
Rated supply voltage	--- 12–24 V	--- 12–24 V	--- 24–48 V
Voltage limits (including ripple)	--- 10–36 V	--- 10–36 V	--- 15–58 V
Output current drift Ambient temperature: - 25 to + 70 °C (-13 to +158 °F)	≤ 10%		
Current consumption, no-load	4 mA		
Maximum operating rate	300 Hz		

(1) Voltage range only obtained with a load impedance of 1000 Ω.

(2) Output current range I_s , see page 2/96.

Setup

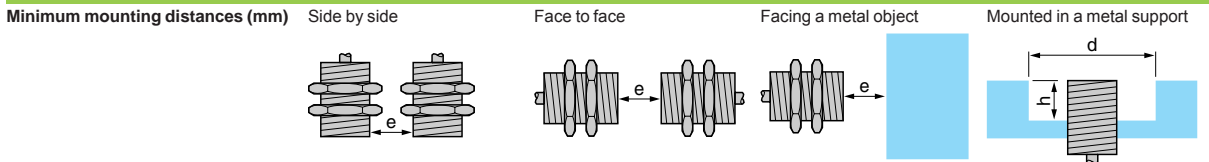

XS1M30AB120 flush mountable	$e \geq 20$	$e \geq 120$	$e \geq 30$	$d \geq 30, h \geq 0$
XS4P30AB110 non-flush mountable	$e \geq 60$	$e \geq 180$	$e \geq 45$	$d \geq 90, h \geq 30$
XS4P30AB120 non-flush mountable	$e \geq 60$	$e \geq 180$	$e \geq 45$	$d \geq 90, h \geq 30$

Mounting nut tightening torque < 40 N·m (354.03 lb-in) (metal case) , < 20 N·m (177.01 lb-in) (plastic case)

Other versions Consult the Sensor Competency Center.

OsiSense® XS Inductive proximity sensors

Application

Sensors with analog output signal 0–10 V ⁽¹⁾
For position, displacement and deformation
control/monitoring

Functions

These analog output proximity sensors are solid-state sensors designed for monitoring displacement. They are not measuring sensors.

They are suitable for use in many sectors, particularly for applications involving:

- deformation and displacement monitoring,
- vibration amplitude and frequency monitoring,
- control of dimensional tolerances,
- position control,
- concentricity or eccentricity monitoring.

2

Operating principle

The operating principle of the sensor is that of a damped oscillator. The degree of damping will depend on the distance of an object from the sensing face. The sensor will sense the distance and produce an output current with a value directly proportional to this distance.

Operating curves 0–10 V, 3-wire connection

XS9F

Sn = 1–5 mm (0.04–0.20 in.)

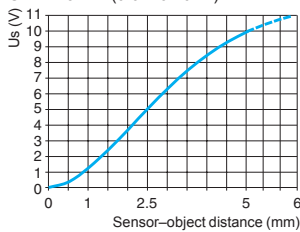

XS9E

Sn = 1–10 mm (0.04–0.39 in.)

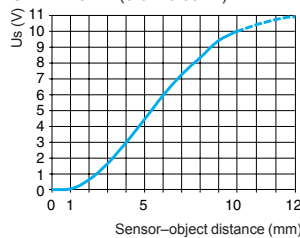

XS9C

Sn = 2–15 mm (0.04–0.59 in.)

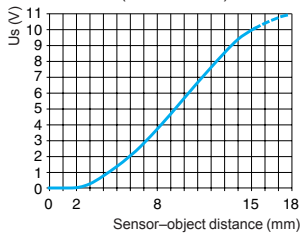

XS9D

Sn = 5–40 mm (0.20–1.57 in.)

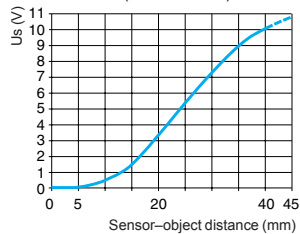

Wiring diagrams

Connector

M8



M12



Pre-cabled

BN: Brown
BU: Blue
BK: Black

3-wire connection

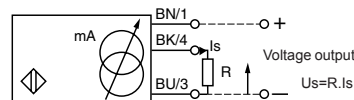

	Output current	Load impedance value	Output voltage	Load impedance value
24 V	0–10 mA	$R \leq 1400 \Omega$	0–10 V	$R = 1000 \Omega$

Note: Ensure a minimum of 5 V between the + (terminal 1) and the sensor output (terminal 4).

⁽¹⁾ Voltage range only obtained with a load impedance of 1000 Ω .

OsiSense® XS

Inductive proximity sensors

Application

Sensors with analog output signal 0–10 V ⁽¹⁾
For position, displacement and deformation
control/monitoring

Flush mountable in metal

PBT case

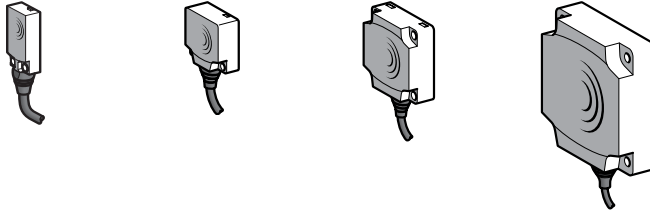

2

Nominal sensing distance S_n , mm (in.)	5 (0.20)	10 (0.39)	15 (0.59)	40 (1.57)
---	----------	-----------	-----------	-----------

Catalog Numbers

3-wire $\overline{\text{---}}$ 0–10 V	Pre-cabled (L = 2 m) (2)	XS9F111A1L2	XS9E111A1L2	XS9C111A1L2	XS9D111A1L2
	Connector	XS9F111A1L01M8	XS9E111A1L01M12	XS9C111A1L01M12	XS9D111A1M12
Weight, kg (lb)	Pre-cabled (L = 2 m) (2)	0.060 (0.13)	0.075 (0.17)	0.095 (0.21)	0.340 (0.75)
	Connector	0.040 (0.09)	0.055 (0.12)	0.075 (0.17)	0.320 (0.71)

Specifications

Product certifications		UL, CSA, CE			
Connection	Pre-cabled	PvR 3 x 0.34 mm ² (22 AWG), length 2 m for XS9●111A●L2			
	Connector	0.15 m pigtail connector with M8 connector	0.15 m pigtail connector with M12 connector	M12	
Operating zone, mm (in.)		1–5 (0.04–0.20)	1–10 (0.04–0.39)	2–15 (0.08–0.59)	5–40 (0.20–1.57)
Degree of protection Conforming to IEC 60529	Pre-cabled	IP 68	IP 68, double insulation \square		
	Connector	IP 67	IP 67, double insulation \square		
Storage temperature		-40 to +85 °C (-40 to +185 °F)			
Operating temperature		-25 to +70 °C (-13 to +158 °F)			
Materials		PBT case			
Vibration resistance	Conforming to IEC 60068-2-6	25 gn, amplitude \pm 2 mm (f = 10 to 55 Hz)			
Shock resistance	Conforming to IEC 60068-2-27	50 gn, duration 11 ms			
Output state indication		No			
Rated supply voltage		$\overline{\text{---}}$ 24 V			
Voltage limits (including ripple)		$\overline{\text{---}}$ 15–36 V			
Repeat accuracy		\pm 3%			
Linearity error		\pm 1 V			
Current consumption, no-load		\leq 4 mA with overload and short-circuit protection			
Maximum operating frequency		2000 Hz	1000 Hz	100 Hz	
Output current drift		\leq 10% (throughout the operating temperature range)			

Dimensions (mm)

XS9F	XS9E/C/D		XS9C/D				XS9E
				<i>(2) For CHC type screws</i>			
Type	A (L2)	A (M12)	B	C	D	E	F
XS9E	14	–	26	13	8.8	20	3.5
XS9C	14	–	40	15	9.8	33	4.5
XS9D	23	14	80	26	16	65	5.5

Setup (Minimum mounting distances (mm))

Type	Side by side	Face to face	Facing a metal object
XS9F			
XS9E	$e \geq 15$	$e \geq 36$	$e \geq 15$
XS9C	$e \geq 30$	$e \geq 72$	$e \geq 30$
XS9D	$e \geq 45$	$e \geq 110$	$e \geq 45$
	$e \geq 120$	$e \geq 300$	$e \geq 120$

(1) Voltage range only obtained with a load impedance of 1000 Ω .

(2) For a 5 m cable replace L2 by L5, for a 10 m cable replace L2 by L10.

Example: XS9C111A1L2 becomes **XS9C111A1L5** with a 5 m cable.

OsiSense® XS

Inductive proximity sensors

Application

Sensors with analog output signal 4–20 mA
For position, displacement and deformation control/monitoring

Functions

These analog output proximity sensors are solid-state sensors designed for monitoring displacement. They are not measuring sensors.

They are suitable for use in many sectors, particularly for applications involving:

- deformation and displacement monitoring,
- vibration amplitude and frequency monitoring,
- control of dimensional tolerances,
- position control,
- concentricity or eccentricity monitoring.

2

Operating principle

The operating principle of the sensor is that of a damped oscillator. The degree of damping will depend on the distance of an object from the sensing face. The sensor will sense the distance and produce an output current with a value directly proportional to this distance.

Operating curves 4–20 mA, 2-wire connection

XS9F

Sn = 1–5 mm (0.04–0.20 in.)

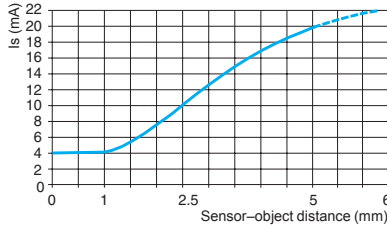

XS9E

Sn = 1–10 mm (0.04–0.10 in.)

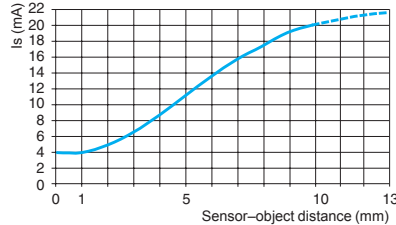

XS9C

Sn = 2–15 mm (0.04–0.59 in.)

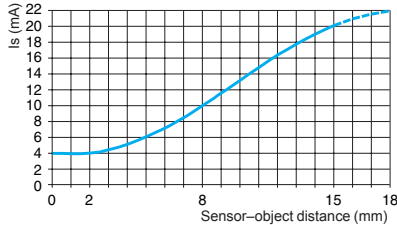

XS9D

Sn = 5–40 mm (0.20–1.57 in.)

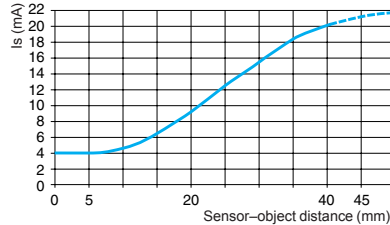

Wiring diagrams

Connector

M8



M12



Pre-cabled

BN: Brown
BU: Blue
BK: Black

2-wire connection

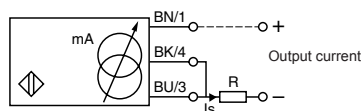

	Output current	Load impedance value
12 V	4–20 mA	$R \leq 8.2 \Omega$
24 V	4–20 mA	$R \leq 470 \Omega$

Note: Ensure a minimum of 10 V between the + (terminal 1) and - (terminal 3) of the sensor.

OsiSense® XS

Inductive proximity sensors

Application

Sensors with analog output signal 4–20 mA
For position, displacement and deformation
control/monitoring

Flush mountable in metal

PBT case

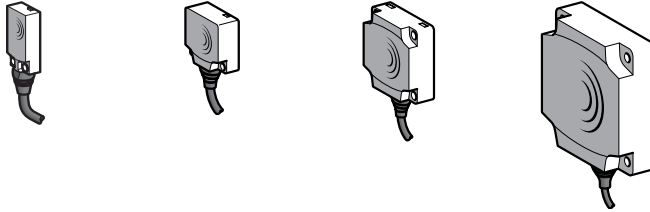

2

Nominal sensing distance S_n , mm (in.)	5 (0.20)	10 (0.39)	15 (0.59)	40 (1.57)
---	----------	-----------	-----------	-----------

Catalog Numbers

2-wire $\overline{\text{---}}$ 4–20 mA	Pre-cabled (L = 2 m) (1)	XS9F111A2L2	XS9E111A2L2	XS9C111A2L2	XS9D111A2L2
	Connector	XS9F111A2L01M8	XS9E111A2L01M12	XS9C111A2L01M12	XS9D111A2M12
Weight, kg (lb)	Pre-cabled (L = 2 m)	0.060 (0.13)	0.075 (0.17)	0.095 (0.21)	0.340 (0.75)
	Connector	0.040 (0.09)	0.055 (0.12)	0.075 (0.17)	0.320 (0.71)

Specifications

Product certifications		UL, CSA, CE			
Connection	Pre-cabled	PvR 3 x 0.34 mm ² (22 AWG), length 2 m for XS9•111A•L2			
	Connector	0.15 m pigtail connector with M8 connector	0.15 m pigtail connector with M12 connector	M12	
Operating zone, mm (in.)		1–5 (0.04–0.20)	1–10 (0.04–0.39)	2–15 (0.08–0.59)	5–40 (0.20–1.57)
Degree of protection Conforming to IEC 60529	Pre-cabled	IP 68	IP 68, double insulation \square		
	Connector	IP 67	IP 67, double insulation \square		
Storage temperature		-40 to +85 °C (-40 to +185 °F)			
Operating temperature		-25 to +70 °C (-13 to +158 °F)			
Materials		PBT case			
Vibration resistance	Conforming to IEC 60068-2-6	25 gn, amplitude \pm 2 mm (f = 10 to 55 Hz)			
Shock resistance	Conforming to IEC 60068-2-27	50 gn, duration 11 ms			
Output state indication		No			
Rated supply voltage		$\overline{\text{---}}$ 12–24 V			
Voltage limits (including ripple)		$\overline{\text{---}}$ 10–36 V			
Repeat accuracy		\pm 3%			
Linearity error		\pm 2 mA			
Current consumption, no-load		\leq 4 mA with overload and short-circuit protection			
Maximum operating frequency		2000 Hz	1000 Hz	100 Hz	
	Output current drift	\leq 10% (throughout the operating temperature range)			

Dimensions (mm)

XS9F	XS9E/C/D	XS9C/D	XS9E
------	----------	--------	------

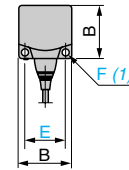
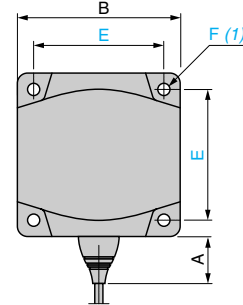
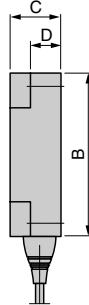
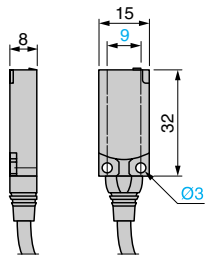

(1) For CHC type screws

Type	A (L2)	A (M12)	B	C	D	E	F
XS9E	14	–	26	13	8.8	20	3.5
XS9C	14	–	40	15	9.8	33	4.5
XS9D	23	14	80	26	16	65	5.5

Setup (Minimum mounting distances (mm))

Type	Side by side	Face to face	Facing a metal object
XS9F			
XS9E	$e \geq 15$	$e \geq 36$	$e \geq 15$
XS9C	$e \geq 30$	$e \geq 72$	$e \geq 30$
XS9D	$e \geq 45$	$e \geq 110$	$e \geq 45$
	$e \geq 120$	$e \geq 300$	$e \geq 120$

(1) For a 5 m cable replace L2 with L5; for a 10 m cable replace L2 by L10.
Example: XS9F111A2L2 becomes XS9F111A2L5 with a 5 m cable.

OsiSense® XS

Inductive proximity sensors

Detection at fixed sensing distance. factor 1 (Fe/Nfe) sensors (1) for ferrous and non-ferrous materials
Solid-state output

Flush mountable in metal

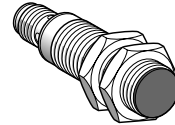
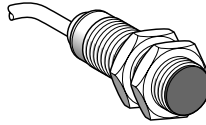
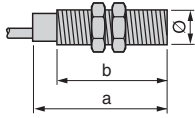

2

Lengths (mm):
a = Overall
b = Threaded section

a = 60
b = 51.5
Ø = M18 x 1

a = 70
b = 51.5
Ø = M18 x 1

	Brass case	Brass case
Nominal sensing distance Sn, mm (in.)	5 (0.20)	5 (0.20)

Catalog Numbers

4-wire ---	PNP/PNP programmable NO/NC	XS1M18KPM40	XS1M18KPM40D
Weight, kg (lb)		0.120 (0.26)	0.060 (0.13)

Specifications

Product certifications	CE, UL, CSA		
Connection	Pre-cabled, PvR 4 x 0.34 mm ² (22 AWG), length 2 m (2)		M12 connector
Degree of protection	Conforming to IEC 60529	IP 68	IP 67
Operating zone, mm (in.)	0–4 (0–0.16)		
Repeat accuracy	3% of Sr		
Differential travel	1–15% of Sr		
Operating temperature	0 to +50 °C (32 to +122 °F)		
Output state indication	Yellow LED, annular		Yellow LED, 4 viewing ports at 90°
Rated supply voltage	--- 12–24 V with protection against reverse polarity		
Voltage limits (including ripple)	--- 10–38 V		
Switching capacity	0–200 mA with overload and short-circuit protection		
Voltage drop, closed state	≤ 2.6 V		
Current consumption, no-load	≤ 15 mA		
Maximum switching frequency	1000 Hz		
Delays	First-up	≤ 10 ms	
	Response	≤ 0.3 ms	
	Recovery	≤ 0.7 ms	

Wiring diagrams

M12 connector	Pre-cabled	4-wire ---, PNP/NPN, NO or NC output	
		NO	NC
	BN: brown BU: blue BK: black WH: white		

(1) The variation in sensing distance between ferrous and non-ferrous materials is typically less than 5%.
(2) Sensors available with other cable lengths: consult the Sensor Competency Center.

OsiSense® XS

Inductive proximity sensors

Detection at fixed sensing distance. factor 1 (Fe/Nfe) sensors (1) for ferrous and non-ferrous materials
Solid-state output

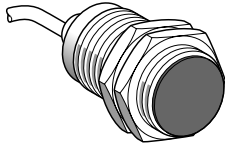

a = 60
b = 51.5
Ø = M30 x 1.5

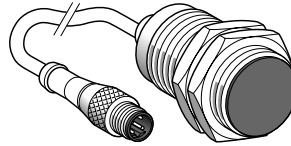

a = 70
b = 51.5
Ø = M12 x 1

2

Stainless steel case 10 (0.39)	Stainless steel case 10 (0.39)
XS1M30KPM40	XS1M30KPM40LD
0.205 (0.45)	0.145 (0.32)
CE, UL, CSA	
Pre-cabled, PvR 4 x 0.34 mm ² (22 AWG), length 2 m (2)	M12 connector on 0.8 m pigtail connector
IP 68	IP 67
0-8 (0-0.31)	
3% of Sr	
1-15% of Sr	
0 to + 50 °C (32 to +122 °F)	
Yellow LED, annular	
--- 12-24 V with protection against reverse polarity	
--- 10-38 V	
0-200 mA with overload and short-circuit protection	
≤ 2.6 V	
≤ 15 mA	
1000 Hz	
≤ 5 ms	
≤ 0.3 ms	
≤ 0.7 ms	

Setup

Minimum mounting distances (mm)	Side by side	Face to face	Facing a metal object	Mounted in a metal support
XS1M18 flush mountable	e ≥ 10	e ≥ 60	e ≥ 15	d ≥ 18, h ≥ 0
XS1M30 flush mountable	e ≥ 20	e ≥ 120	e ≥ 30	d ≥ 30, h ≥ 0
Mounting nut tightening torque: XS1M18: < 35 N*m (309.78 lb-in), XS1M30: < 100 N*m (885.07 lb-in)				

(1) The variation in sensing distance between ferrous and non-ferrous materials is typically less than 5%.
(2) Sensors available with other cable lengths: consult the Sensor Competency Center.

OsiSense® XS Inductive proximity sensors

Application

Fixed sensing distance detection, Factor 1 (Fe/Nfe) sensors ⁽¹⁾ for ferrous and non-ferrous materials

Solid-state output

Sensor | Flush mountable in metal

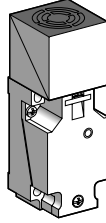

2

Nominal sensing distance S_n , mm (in.)	15 (0.59)	
Catalog Numbers		
4-wire $\overline{---}$	PNP/NPN/NO/NC programmable	XS7C40KPM40H7
Weight, kg (lb)	0.220 (0.49)	
Specifications		
Product certifications	CE, CSA, UL	
Degree of protection	Conforming to IEC 60529	IP 67
Operating temperature	0 to +50 °C (+32 to +122 °F)	
Connection	Screw terminals, clamping capacity 4 x 0.34 mm ² (24 AWG) (2)	
Operating zone, mm (in.)	0–12 (0.47)	
Repeat accuracy	3% of S_r	
Differential travel	1–15% of S_r	
Output state indication	Yellow LED	
Rated supply voltage	$\overline{---}$ 12–24 V with protection against reverse polarity	
Voltage limits (including ripple)	$\overline{---}$ 10–38 V	
Current consumption, no-load	≤ 15 mA	
Switching capacity	0–200 mA with overload and short-circuit protection	
Voltage drop, closed state	≤ 2.6 V	
Maximum switching frequency	1000 Hz	
Delays	First-up	≤ 5 ms
	Response	≤ 0.3 ms
	Recovery	≤ 0.7 ms

(1) The variation in sensing distance between ferrous and non-ferrous materials is typically less than 5%.

(2) Cable gland not included with sensor. For suitable Pg 13 cable gland (XSZPE13), see page 2/131.

Dimensions,
Detup,
Wiring Diagrams

OsiSense® XS Inductive proximity sensors

Application

Fixed sensing distance detection, Factor 1 (Fe/Nfe) sensors (1) for ferrous and non-ferrous materials
Solid-state output

Dimensions (mm)

XS7C40KPM40

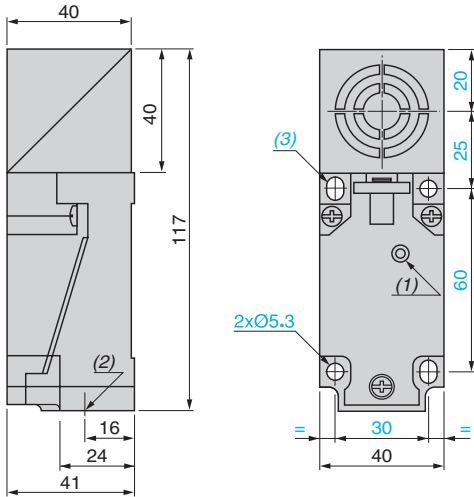

- (1) Output LED.
- (2) 1 tapped entry for Pg 13 cable gland.
- (3) 2 elongated holes \varnothing 5.3 x 7.

2

Setup

Minimum mounting distances (mm)

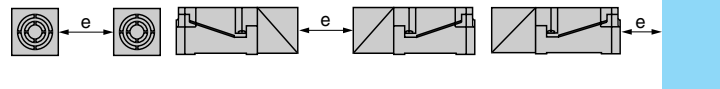

Sensor flush mountable in metal	XS7C40KPM40	Side by side $e \geq 40$	Face to face $e \geq 120$	Facing a metal object $e \geq 45$
---------------------------------	-------------	-----------------------------	------------------------------	--------------------------------------

Tightening torque of cover mounting screws and clamp screws: $< 1.2 \text{ N}\cdot\text{m}$ (10.62 lb-in)

Wiring diagrams

PNP/NPN

4-wire c programmable, NO or NC output

NO output

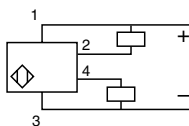

NC output

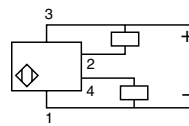

OsiSense® XS

Inductive proximity sensors

Application

Selective detection of ferrous materials
Selective detection of non-ferrous materials
Cylindrical type, solid-state output

Flush mountable

Stainless steel case

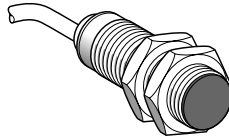

2

Nominal sensing distance (Sn)	5 mm
-------------------------------	------

Catalog Numbers

3-wire, ferrous version Insensitive to non-ferrous materials	PNP NO	XS1M18PAS40
3-wire, non-ferrous version Insensitive to ferrous materials	PNP NO	XS1M18PAS20
Weight, kg (lb)		0.120 (0.26)

Specifications

Product certifications	UL, CSA, CE	
Connection	Pre-cabled, PvR, 3 x 0.34 mm ² (24 AWG), length 2 m (1)	
Operating zone, mm (in.)	0–4 (0–0.16)	
Degree of protection conforming to IEC 60529	IP 68	
Operating temperature	-25 to +70 °C (-13 to +158 °F)	
Output state indication	Yellow LED, annular	
Rated supply voltage	⎓ 12–24 V with protection against reverse polarity	
Voltage limits (including ripple)	⎓ 10–38 V	
Switching capacity	0–200 mA with overload and short-circuit protection	
Voltage drop, closed state	≤ 2.6 V	
Residual current, open state	–	
Current consumption, no-load	≤ 15 mA	
Maximum switching frequency	1000 Hz	
Delays	First-up	≤ 10 ms
	Response	≤ 0.3 ms
	Recovery	≤ 0.7 ms

(1) Sensors available with other cable lengths: consult the Sensor Competency Center.

Wiring diagrams

3-wire ⎓ PNP

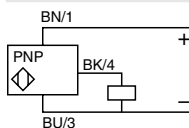

Dimensions (mm)

XS1M

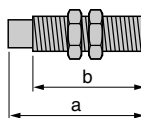

a (mm)	b (mm)
60	51.5

Setup

Minimum mounting distances (mm)

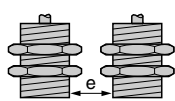

Side by side

XS1M18

$e \geq 10$

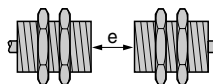

Face to face

$e \geq 60$

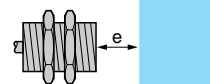

Facing a metal object

$e \geq 15$

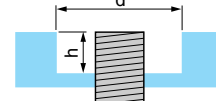

Mounted in a metal support

$d \geq 18, h \geq 0$ (ferrous metal)
 $d \geq 18, h \geq 5$ (non-ferrous metal)

OsiSense® XS Inductive proximity sensors

Application

Selective detection of ferrous materials
Selective detection of non-ferrous materials
Cylindrical type, solid-state output

Flush mountable

Stainless steel case

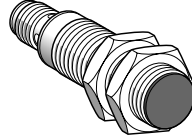

Nominal sensing distance S_n , mm (in.)	5 (0.20)
---	----------

Catalog Numbers

3-wire, ferrous version Insensitive to non-ferrous materials	PNP NO	XS1M18PAS40D
3-wire, non-ferrous version Insensitive to ferrous materials	PNP NO	XS1M18PAS20D
Weight, kg (lb)		0.060 (0.13)

Specifications

Product certifications	UL, CSA, CE
Connection	M12 connector
Degree of protection conforming to IEC 60529	IP 67
Operating zone, mm (in.)	0–4 (0–0.08)
Operating temperature	-25 to +70 °C (-13 to +158 °F)
Output state indication	Yellow LED, 4 viewing ports at 90°
Rated supply voltage	--- 12–24 V with protection against reverse polarity
Voltage limits (including ripple)	--- 10–38 V
Switching capacity	0–200 mA with overload and short-circuit protection
Voltage drop, closed state	≤ 2.6 V
Residual current, open state	–
Current consumption, no-load	≤ 15 mA
Maximum switching frequency	1000 Hz
Delays	First-up ≤ 10 ms Response ≤ 0.3 ms Recovery ≤ 0.7 ms

Wiring diagrams

M12 connector



3-wire --- PNP

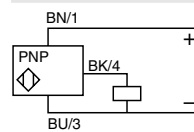

Dimensions (mm)

XS1M

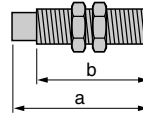

a (mm)	b (mm)
70	51.5

Setup

Minimum mounting distances (mm)

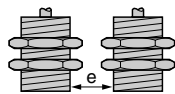

Side by side

$e \geq 10$

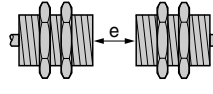

Face to face

$e \geq 60$

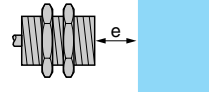

Facing a metal object

$e \geq 15$

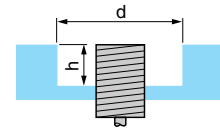

Mounted in a metal support

$d \geq 18, h \geq 0$ (ferrous metal)
 $d \geq 18, h \geq 5$ (non-ferrous metal)

XS1M18

2

OsiSense® XS Inductive proximity sensors

Application

Sensors for welding machine applications (1)

Cylindrical type. metal case, Teflon® coated steel, threaded

Sensors flush mountable in metal

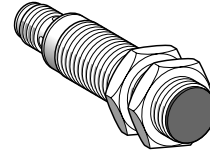
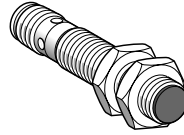
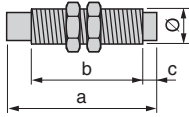

2

Lengths (mm):
a = Overall
b = Threaded section
c = For non-flush mountable sensors

a = 60
b = 40
Ø = M12 x 1

a = 60
b = 40
Ø = M18 x 1

	Teflon front face	Teflon front face
Nominal sensing distance S_n , mm (in.)	2 (0.08)	5 (0.20)

Catalog Numbers

3-wire ---	PNP, NO	XS1M12PAW01D	XS1M18PAW01D
Weight, kg (lb)		0.025 (0.06)	0.060 (0.13)

Specifications

Product certifications	CE, UL, CSA	
Connection	M12 connector	
Degree of protection	Conforming to IEC 60529	IP 67
Operating zone, mm (in.)	0-1.6 (0-0.06)	0-4 (0-0.16)
Repeat accuracy	3% of S_r	
Differential travel	1-20% of S_r	
Operating temperature	-25 to +70 °C (-13 to +158 °F)	
Output state indication	Yellow LED, 4 viewing ports at 90°	
Rated supply voltage	--- 12-24 V with protection against reverse polarity	
Voltage limits (including ripple)	--- 10-36 V	
Switching capacity	0-250 mA with overload and short-circuit protection	
Voltage drop, closed state	≤ 2.5 V	
Current consumption, no-load	≤ 15 mA	
Immunity to electromagnetic fields	≤ 140 mT	
Maximum switching frequency	1000 Hz	500 Hz
Delays	First-up	≤ 10 ms
	Response	≤ 0.1 ms
	Recovery	≤ 0.4 ms
		≤ 0.6 ms

Wiring diagrams

M12 connector



3-wire ---, PNP, NO output

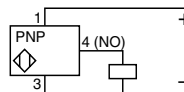

(1) Sensors particularly resistant to welding machine electromagnetic fields.

OsiSense® XS Inductive proximity sensors

Application

Sensors for welding machine applications (1)

Cylindrical type. metal case, Teflon® coated steel, threaded

Sensors non-flush mountable in metal

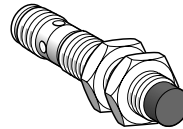
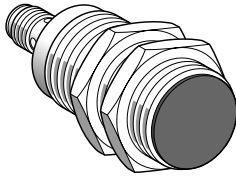

a = 60
b = 40
Ø = M30 x 1.5

a = 60
b = 36
c = 4
Ø = M12 x 1

2

Teflon front face 10 (0.39)	Teflon front face 4 (0.16)
XS1M30PAW01D	XS2M12PAW01D
0.145 (0.32)	0.025 (0.06)
CE, UL, CSA	
M12 connector	
IP 67	
0-8 (0-0.31)	0-3.2 (0-0.13)
3% of Sr	
1-20% of Sr	
-25 to +70 °C (-13 to +158 °C)	
Yellow LED, 4 viewing ports at 90°	
--- 12-24 V with protection against reverse polarity	
--- 10-36 V	
0-250 mA with overload and short-circuit protection	
≤ 2.5 V	
≤ 15 mA	
≤ 140 mT	
250 Hz	1000 Hz
≤ 10 ms	≤ 10 ms
≤ 0.7 ms	≤ 0.2 ms
≤ 5 ms	≤ 0.4 ms

Setup

Minimum mounting distances (mm)	Side by side	Face to face	Facing a metal object	Mounted in a metal support
---------------------------------	--------------	--------------	-----------------------	----------------------------

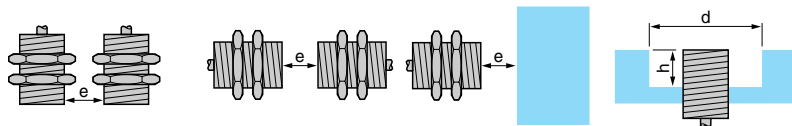

XS1M12 flush mountable	$e \geq 0$	$e \geq 7$	$e \geq 6$	$d \geq 12, h \geq 0$
XS1M18 flush mountable	$e \geq 0$	$e \geq 16$	$e \geq 9$	$d \geq 18, h \geq 0$
XS1M30 flush mountable	$e \geq 0$	$e \geq 20$	$e \geq 20$	$d \geq 30, h \geq 0$
XS2M12 non-flush mountable	$e \geq 15$	$e \geq 9$	$e \geq 11$	$d \geq 36, h \geq 8$

Mounting nut tightening torque: **XS1M12, XS2M12:** < 15 N•m (13.28 lb-in), **XS1M18:** < 35 N•m (309.78 lb-in), **XS1M30:** < 50 N•m (442.54 lb-in)

Catalog Numbers,
Specifications,
Dimensions,
Wiring Diagram

OsiSense® XS

Inductive proximity sensors

Application

For welding machine applications

Cylindrical type. metal case, plain, with shoulder

Flush mountable in metal

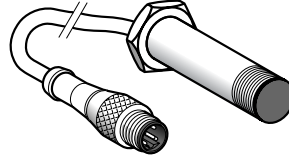
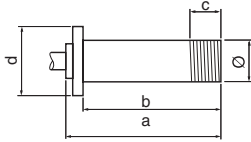

2

Lengths (mm):
a = Overall
b = To shoulder
c = Removal
d = Shoulder

Ø = 12
a = 55
b = 50
c = 9 (threaded end)
d = 15 hexagonal

Nominal sensing distance Sn, mm (in.)	3 (0.12)	3 (0.12)	3 (0.12)
---------------------------------------	----------	----------	----------

Catalog Numbers

2-wire $\overline{\text{---}}$ (non-polarized) Terminal connections	1-4	NO	XSLC1401393L1	XSLC1401393L3	XSLC1401393L4
Weight, kg (lb)			0.050 (0.11)	0.065 (0.14)	0.050 (0.11)

Specifications

Connection	Remote M12 connector on 1.2 m pigtail connector	Remote M12 connector on 0.8 m pigtail connector	Remote M12 connector on 0.15 m pigtail connector
Degree of protection conforming to IEC 60529	IP 67		
Operating zone, mm (in.)	0–2.4 (0–0.09)		
Repeat accuracy	≤ 3% of Sr		
Differential travel	1–15% of Sr		
Operating temperature	-25 to +80 °C (-13 to +176 °F)		
Output state indication	Yellow LED, annular		
Rated supply voltage	$\overline{\text{---}}$ 12–48 V		
Voltage limits (including ripple)	$\overline{\text{---}}$ 10–58 V		
Switching capacity	1.5–100 mA with overload and short-circuit protection		
Voltage drop, closed state	≤ 4 V		
Residual current, open state	≤ 0.5 mA		
Current consumption, no-load	–		
Maximum switching frequency	800 Hz		
Delays	First-up: ≤ 5 ms; response: ≤ 05 ms; recovery: ≤ 0.5 ms		

Wiring diagrams

2-wire $\overline{\text{---}}$, non-polarized, NO output

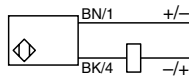

OsiSense® XS

Inductive proximity sensors

Application

For welding machine applications

Cylindrical type. metal case, plain, with shoulder

Flush mountable in metal

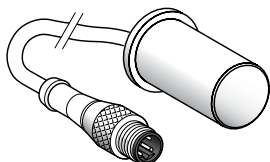

Ø = 18
a = 40
b = 35
c = 0 (PPS front face)
d = Ø 22

Non-flush mountable in metal

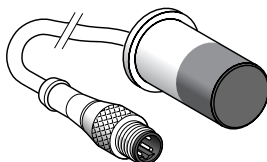

Ø = 18
a = 45
b = 35
c = 20 (Teflon front face and case)
d = Ø 22

2

6.3 mm (0.25)	10 (0.39)	10 (0.39)
XSLC1401392L1	XSLC1401405L3	XSLC1401405L4
0.100 (0.22)	0.065 (0.14)	0.050 (0.11)
Remote M12 connector on 1.2 m pigtail connector	Remote M12 connector on 0.8 m pigtail connector	Remote M12 connector on 0.15 m pigtail connector
IP 67		
0–5 (0–0.20)	0–8 (0–0.31)	
3% of Sr		
1–15% of Sr		
-25 to +70 °C (-13 to +158 °F)		
Yellow LED, annular		
~ 12–48 V		
~ 10–58 V		
1.5–100 mA with overload and short-circuit protection		
≤ 4 V		
≤ 0.5 mA		
–		
100 Hz		
First-up: ≤ 10 ms; response: ≤ 10 ms; recovery: ≤ 2 ms		

Setup

Minimum mounting distances (mm)

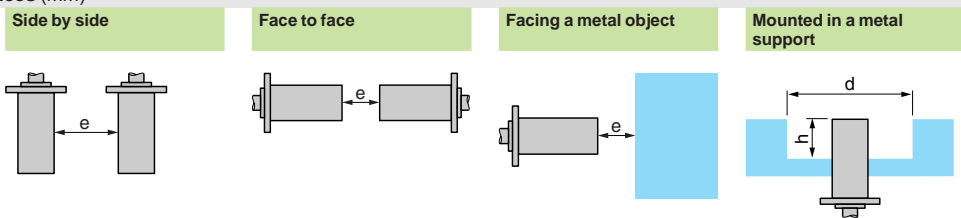

		Side by side	Face to face	Facing a metal object	Mounted in a metal support
XSLC	Ø 12 (flush mountable)	$e \geq 10$	$e \geq 60$	$e \geq 15$	$d = 12, h = 0$
	Ø 18 (non-flush mountable)	$e \geq 16$	$e \geq 96$	$e \geq 24$	$d = 54, h = 16$

OsiSense® XS

Inductive proximity sensors

SG magnet actuated sensors

Surface mounted style

2

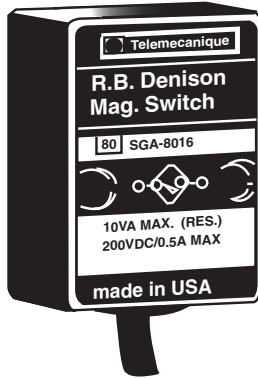

Surface-mounted, magnet-actuated sensors for industrial applications

- Sensing is independent of magnet polarity.
- Typical applications: security systems (gate interlocks), high-speed rotational counting, identification of metal bins with magnet-coded labels, sensing through non-magnetic walls.

Features

- Housing: aluminum except SG08168 and SG28195 are plastic (PBT)
- Completely encapsulated in epoxy
- Very fast response time (reed output only)
- PLC-compatible AC models (triac output)
- High transients protection (AC models)
- No bouncing

Magnet-actuated proximity sensors

Circuit Type	AC ratings			DC ratings			Leakage (mA)	Dim. Figure	Wiring Figure	Catalog Number
	VA (max.)	Voltage (4)	Current (max.)	VA (max.)	Voltage (max.)	Current (max.)				
Reed output—DC only										
N.O.	—	—	—	10	200	0.5 A	0	1	A	SGA8016
N.O.	—	—	—	10	200	0.5 A	0	2	A	SGA8031
Reed output—DC only—Built-in resistor protection										
N.O.	—	—	—	10	200	0.5 A	0	1	A	SGA8182
Reed output—DC only—High temperature -40 to 300 °F										
N.O.	—	—	—	10	200	0.5 A	0	1	A	SGA8053
Reed output—AC and DC—Built-in RC protection										
N.C.	3	130	0.25 A	3	100	0.25 A	6 (1)(3)	2	B	SGB8175
N.O.	10	130	0.5 A	10	200	0.5 A	6 (1)(3)	2	A	SGA8176
N.O.	10	130	0.5 A	10	200	0.5 A	6 (1)(3)	1	A	SGA8177
Triac output—AC only (inductive PLC)										
N.O.	240	120	2.0 A	—	—	—	1.7 (1)(2)	3	A	SG08168 (5)
N.O./N.C.	50	240	0.5 A	—	—	—	1.7 (1)(2)	3	C	SG28195 (5)
N.O.	50	130	0.5 A	—	—	—	1.7 (1)(2)	1	A	SG08239

- (1) PLC applications.
 (2) PLC compatible.
 (4) Bleeder resistor required.
 (3) For reed output: maximum voltage. For triac output: nominal voltage.
 (5) UL Recognized

Magnet actuators

Description	Sensing distance		Catalog Number
	All (6)	SG2 8195	
Tubular	33 mm 1.3 in. ()	25.4 mm (1 in.)	7046
Flat bracket, center	South pole	17.7 mm (0.7 in.)	7093
Flat bracket, side	South pole	12.7 mm (0.5 in.)	7063
90° bracket	South pole	12.7 mm (0.5 in.)	7062
Block type		12.7 mm (0.5 in.)	7099
Flexible tape, 1 ft (305 mm) long		7.6 mm (0.3 in.)	7096

(6) All block sensors except SG28195.

OsiSense® XS

Inductive proximity sensors

SG magnet actuated sensors
Surface mounted style

2

Mechanical Specifications

Standard temperature range	-40 to +60 °C (-40 to +140 °F); to 149 °C (300 °F) for SGA8053
Enclosure ratings	NEMA Types 1, 4, 13
Vibration resistance	20 G (10 to 2,000 Hz)
Shock resistance	50 G for 11 ms
Differential	Maximum 75%
Repeatability	0.08 mm (0.003 in.)

Wiring

Figure A (N/O)

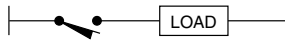

Figure B (N/C)

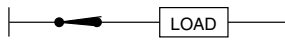
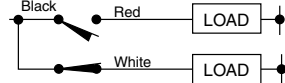

Figure C (N/O or N/C)



Electrical Specifications

	AC (triac)	DC
Voltage drop (across switch)	2 V	0 V (IR for SGA8182) (1)
Minimum load current	15 mA	—
On delay (ms)	1 ms	0.75 ms
Off delay (ms)	8 ms	0.75 ms
Cable, 3 ft (0.9 m)	0.31 mm ² (22 AWG) vinyl, except: 1.2 mm ² (16 AWG) SJTO for SGO8168 ; 2 individual fluorinated hydrocarbon coated 1.2 mm ² (22 AWG) for SGA8053	
Agency listings	E 42259 CCN NKCR2 (SGO8168 and SG28195 only)	

(1) Voltage drop = IR, where I = load current, R = 150 Ω

Options

Description	Cable Type	Suffix
2 m (6.6 ft) of individual wires	Fluorinated hydrocarbon coated GA8053	L02
5 m (16.4 ft) of individual wires	Fluorinated hydrocarbon coated (SGA8053)	L05
5 m (16.4 ft) of cable	Vinyl	L05
	SJTO (SGO8168)	L05
10 m (32.8 ft) of cable for triac and models with built-in resistor	Vinyl	L10
	SJTO (SGO8168)	L10

Ex: SGO8168L05

Dimensions

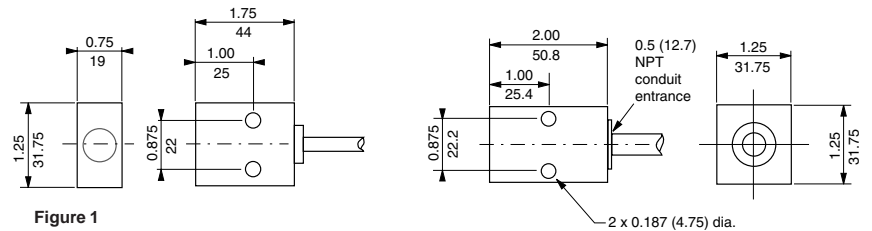

Figure 1

SGA8016
SGA8177
SGA8182
SGA8053
SGO8239

Figure 2

SGA8031
SGA8175
SGA8176

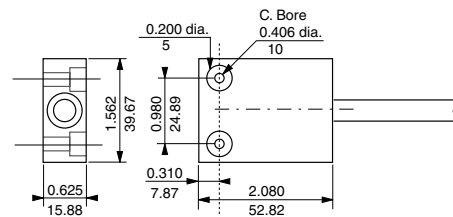

Figure 3

SGO8168
SG28195

in.
(mm)

OsiSense® XS

Inductive proximity sensors

SG magnet actuated sensors

Limit switch style

2



Non-plug-in

Limit-switch style, magnet-actuated proximity sensors for heavy-duty industrial applications

- Sensing independent of magnet polarity
- Typical applications: security systems (gate interlocks), high-speed rotational countings, identification

Features

- Diecast zinc housing
- Completely encapsulated in epoxy
- Plug-in models for fast replacement
- Very fast response time (reed output only)
- PLC-compatible AC models
- High transient protection
- Overload and short protection (transistor models)
- No bouncing
- 12.7 mm (0.5 in.) NPT conduit entrance
- UL recognized (except where indicated)

Circuit Type	AC ratings (inductive or resistive)			VA (max.)	DC ratings (resistive only)		Leakage (mA)	Dim. Figure	Wiring Figure	Catalog Number
	VA (max.)	Voltage (nom.)	Current (max.)		Voltage (max.)	Current (max.)				
AC triac output, non-plug-in										
N.O.	360	120	3.0 A	—	—	—	1.7 (1)	1	A	SG08003
N.C.	360	120	3.0 A	—	—	—	1.7 (1)	1	B	SG18004
Non-plug-in with light indicator										
N.O.	360	120	3.0 A	—	—	—	1.7 (1)	1	A	SG0L8003
N.C.	360	120	3.0 A	—	—	—	1.7 (1)	1	B	SG1L8004
DC, transistor output, non-plug-in										
N.O.	—	—	—	7.5	30	0.25 A	0	1	D	SG08079
N.C.	—	—	—	7.5	30	0.25 A	0	1	E	SG18056
Reed output, non-plug-in (AC model has built-in surge RC protection)										
N.O.	—	—	—	10	200	0.5 A	0	1	A	SGA8005
N.O.	15	120	1.0 A	15	250	1.0 A	6 (1)(2)	1	A	SGA8040
N.O./N.C.	—	—	—	3	200	0.25 A	0	1	C	SGC8027
N.O./N.C.	—	—	—	20	500	1.5 A	0	3	C	SGC8025

(1) PLC compatible. (2) Bleeder resistor required for PLC compatibility.

Magnet actuators, mm (in.)

Description	Sensing distance					Catalog Number	
	8079	8040	8027	8025	All others		
Tubular	30.5 (1.2)	20.3 (0.8)	23 (0.9)	25.4 (1.0)	33 (1.3)	7046	
Flat bracket, center	South pole	12.7 (0.5)	10.0 (0.4)	10.0 (0.4)	10.0 (0.4)	17.7 (0.7)	7093
Flat bracket, side	South pole	10.0 (0.4)	5.1 (0.2)	5.1 (0.2)	5.1 (0.2)	12.7 (0.5)	7063
90° bracket	South pole	10.0 (0.4)	5.1 (0.2)	5.1 (0.2)	5.1 (0.2)	12.7 (0.5)	7062
Block type		5.1 (0.2)	5.1 (0.2)	7.6 (0.3)	5.1 (0.2)	12.7 (0.5)	7099
Flexible type—305 mm (1 ft) long		2.5 (0.1)	—	5.1 (0.2)	0.1 (2.5)	7.6 (0.3)	7096

OsiSense® XS

Inductive proximity sensors

SG magnet actuated sensors
Limit switch style

Wiring

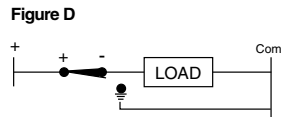
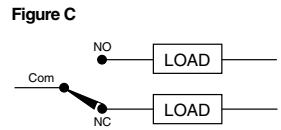
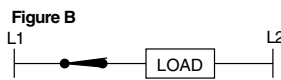
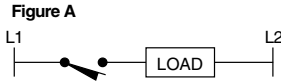

SG18056 is normally closed. Connect the red terminal (+) to the power source. Connect the minus terminal (-) to the load. The housing must be connected to minus.

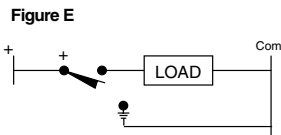

Specifications

General specifications						
Temperature range	-40 to 60 °C (-40 to 140 °F) -40 to 52 °C (-40 to 125 °F) for transistor models					
Enclosure ratings	NEMA Types 1, 4, 13					
Vibration resistance	20 G (10 to 2,000 Hz)					
Shock resistance	50 G for 11 ms					
Differential	Maximum 75%					
Repeatability	0.08 mm (0.003 in.)					
	AC triac	Transistor	Reed			
Voltage drop (across switch)	2 V	—	—			
Minimum load current (maximum)	15 mA	—	—			
			SGA8005	SGA8040	SGS8027	SGC8025
On delay (maximum)	1 ms	0.75 ms	0.75	2 ms	1 ms N.O./ 1.5 ms N.C.	2 ms N.O./ 4 ms N.C.
Off delay (maximum)	—	0.75 ms	0.75	2 ms	11 ms N.O./ 1.5 ms N.C.	2 ms N.O./ 4 ms N.C.
Cable—screw terminals	1.5 mm ² (16 AWG)	—				
Agency listings except where noted	E 42259 CCN NKCR2					

Options—triac models only

Description	Figure	Suffix adder
3 ft (0.9 m) 16-3 SJTO vinyl cable, epoxy sealed	A, B	320
3 ft (0.9 m) 16-3 SJTO vinyl cable, cord connector	A, B	321
3 ft (0.9 m) 16-4 SJTO vinyl cable, epoxy sealed	C, D, E	420
3-pin mini-style receptacle	—	347

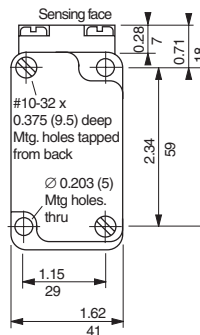

Figure 1
non-plug-in
SGA8005
SGO8003
SGC8027
SGI8056
SGO8056
SGI8004
SGO8040
SGO8079

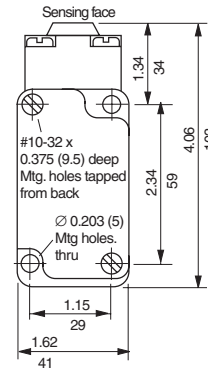
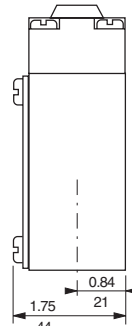
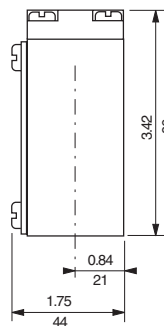

Figure 2
Style C
SGC8025



in.
(mm)

OsiSense[®] XS

Inductive proximity sensors

SG magnet actuated sensors

Tubular style

Dimensions

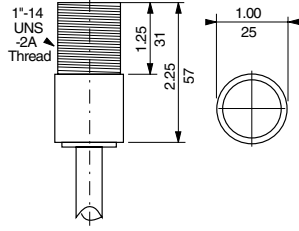

Figure 1
SGA8057
(Aluminum)
SGC8058 (PVC)
SGA8072 (PVC)
SGA8189 (Brass)

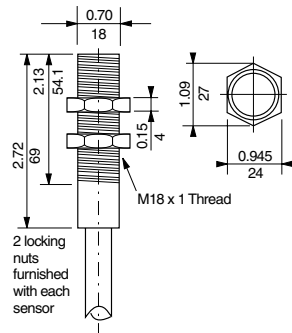

Figure 2
SGA8179
SGA8180
SGC8181

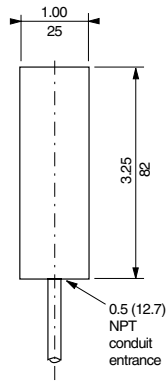

Figure 3
SGA8038

in.
(mm)

Tubular, magnet-actuated proximity sensors for heavy-duty applications such as:

- High-speed rotational counting
- Identification of metal bins with magnet-coded labels
- Sensing through non-magnetic walls

Sensing is independent of magnet polarity.

Features

- Housings: aluminum for SGA8057; plastic (PVC) for SGC8058, SGA8072, SGA8039; polyimide for SGA8179, SGA8180, SGA8181
- Completely encapsulated in epoxy
- High transient protection
- Threaded and smooth housings
- High voltage versions
- SPST and SPDT models
- No bouncing
- UL recognized (except where noted with #).

Circuit type	AC ratings (inductive or resistive)			DC ratings (resistive only)			Leakage (mA)	Dim. Figure	Wiring Figure	Catalog Number
	VA (max.)	Voltage nominal	Current (max.)	VA (max.)	Voltage (max.)	Current (max.)				
Reed output AC and DC switching (built-in RC protection), threaded										
N.O.	15	120	1.0A	12	48	0.25 A	6 (1)	1	A	SGA8057
N.O./N.C.	15	120	1.0A	15	100	1.0A	6 (1)	1	C	SGC8058
N.O.	15	120	1.0A	15	250	1.0A	6 (1)	1	A	SGA8072
N.O.	25	480	1.0A	25	480	1.0A	.16	2	A	SGA8179 (3)
Reed output—DC, threaded, resistor built-in for long cable runs (2)										
N.O.	—	—	—	10	200	0.5 A	0	2	A	SGA8180 (3)
N.O./N.C.	—	—	—	3	100	0.25 A	0	2	C	SGC8181 (3)
Reed output—AC and DC (built-in RC protection), smooth										
1 N.O.	15	120	1.0A	15	250	1.0A	6 (1)	3	A	SGA8038(3)

(1) Bleeder resistor required for PLC AC switching compatibility.
(2) 150 Ω for SGA8180 and 470 Ω for SGC8181.
(3) Not UL

Magnet actuators, mm (in.)

Description	Sensing distance		Catalog Number	
	SGA8180	All Others		
Tubular	33 (1.3)	20.3 (0.8)	7046	
Flat bracket, center	South pole	17.8 (0.7)	10.0 (0.4)	7093
Flat bracket, side	South pole	5.1 (0.2)	5.1 (0.2)	7063
90° bracket	South pole	5.1 (0.2)	5.1 (0.2)	7062
Block type	5.1 (0.2)	5.1 (0.2)	5.1 (0.2)	7099
Flexible tape—1 ft (305 mm) long	2.5 (0.1)	2.5 (0.1)	2.5 (0.1)	7096

OsiSense® XS

Inductive proximity sensors

SG magnet actuated sensors
Tubular style

Wiring

Figure A



Figure C

SGC8058 and SGC8181
Black—Com
Blue—N.O.
Brown—N.C.

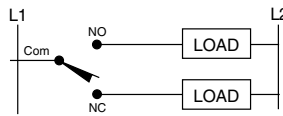

Specifications

General specifications			
Temperature range	-40 to 60 °C (-40 to 140 °F)		
Enclosure ratings	NEMA Types 1, 4, 13		
Vibration resistance	20 G (10 to 1000 Hz)		
Shock resistance	50 G for 11 ms		
Differential	Maximum 75% (except SGA8179 = 1.06 in. maximum)		
Repeatability	Maximum 0.08 mm (0.003 in.)		
	Reed AC and DC	SGA8180 Built-in resistor (DC)	SGC8181 Built-in resistor (DC)
Voltage drop (1)	25 mV	IR	IR
On delay (maximum)	2 ms	0.75 ms	2.5 ms N.O. 3.5 ms N.C.
Cable, 3 ft (0.9 m)	22-2 vinyl: SGA8038, 8180; 23-2 vinyl SGC 8181; 16-2 SJTO: SGA8057, 8072. SO cable for SGA8179		
Agency listings except where noted	 E 42259 CCN NKCR2		

2

(1) Voltage drop = IR, where I is the load current and R the built-in resistor.

Options

Description		Suffix
5 m (16.4 ft) of cable	Vinyl	L05
	SJTO (8057, 8072, 8179)	L05
10 m (32.8 ft) of cable (for models with built-in resistor)	Vinyl	L10
	SJTO (8057, 8072, 8179)	L10

OsiSense® XS

Inductive proximity sensors

SG magnet actuated sensors

Maintained contact

Dimensions

2

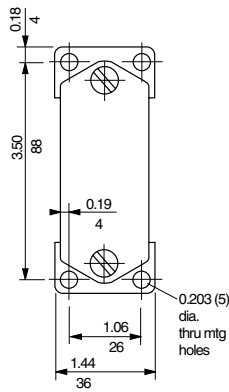
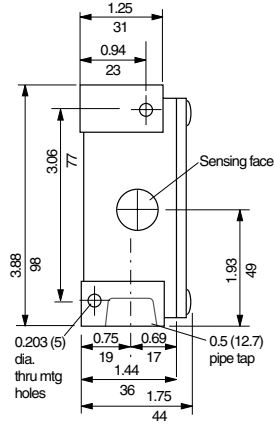

Figure 1
SGA8018
SGO8026
SGO8110
SGO8141

in.
(mm)

Maintained contact model—A highly reliable, magnet-actuated proximity limit switch designed to maintain contact for high-speed stacker cranes, slow-down, and memory applications. Eliminates the camming required for mechanically operated limit switches. **Maintains the information even if power is down.**

Features

- Diecast zinc housing
- PLC compatibility
- High transient protection
- No bouncing
- 12.7 mm (0.5 in.) NPT conduit entrance
- UL recognized

When the north or south pole of a magnet actuator moves past the blue-dot sensitive area within the specified range along the switch, the contact position changes from open to closed. Once latched, the movement of the same magnetic pole in the opposite direction—or the movement of the opposite magnetic pole in the same direction—unlatches the switch.

NOTE: If during this procedure the switch closes and then opens again (pulses), reverse the polarity of the magnet and repeat the above procedure. If the desired direction of operation is opposite to that established above, reverse the polarity of the magnet.

Circuit Type	AC ratings (inductive or resistive)			DC ratings (resistive only)			Leakage (mA)	Wiring Figure	Catalog Number
	VA (max.)	Voltage (nom.)	Current (max.)	VA (max.)	Voltage (max.)	Current (max.)			

Reed, DC									
1 N.O.	—	—	—	15	250	1.0 A	0	A	SGA8018
Triac, AC									
1 N.O.	360	120	3.0 A	—	—	—	1.7	A	SGO8026
Triac, AC low temperature: -34 to +29° C (-30 to 85° F)									
1 N.O.	360	120	3.0 A	—	—	—	1.7	B	SGO8110

Magnet actuators, mm (in.)

Description	Sensing Distance, mm (in.)	Catalog Number
Tubular	33 (1.3)	7046
Flat bracket, center	South pole	7093
	North pole	7547
Flat bracket, side	South pole	7063
	North pole	70631
90° bracket	South pole	7062
	North pole	70621
Block type	13 (0.5)	7099
Flexible tape—305 mm (1 ft) long	13 (0.5)	7096

OsiSense® XS

Inductive proximity sensors

SG magnet actuated sensors
Magnet actuators

Features

- Industrial grade magnet is recommended for magnet-actuated proximity sensors.
- Alnico is used as magnet material for all rigid models.
- Aramid fiber is used for the flexible magnetic tape.
- The rigid models come mounted on one of several types of standard brackets for convenience (except the tubular high-power version).
- Both south and north poles are accessible and marked. The south pole version is the standard. North pole versions may be required in conjunction with the maintained magnetic switch.
- For comparison, an average magnetic strength rating is listed below. Measurements were made with a Gaussmeter at 3.3 mm (0.13 in.) from the sensing surface.

2

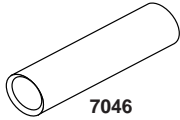

7046

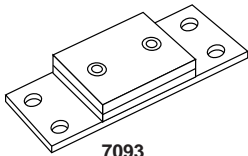

7093

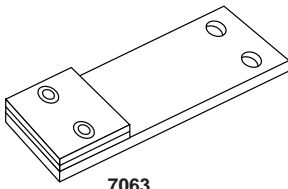

7063

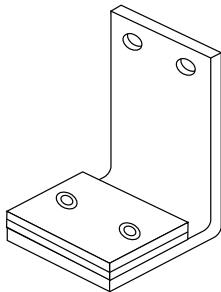

7062

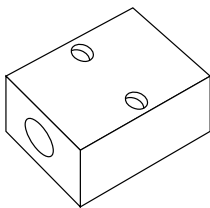

7099

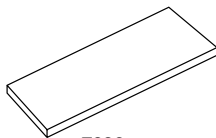

7096

Description		Magnetic Strength	Catalog Number
Tubular		700 Gauss	7046
Flat bracket, center	South pole	330 Gauss	7093
	North pole	330 Gauss	7547
Flat bracket, side	South pole	240 Gauss	7063
	North pole	240 Gauss	70631
90° bracket	South pole	260 Gauss	7062
	North pole	260 Gauss	70621
Block type		340 Gauss	7099
Flexible tape	1 ft long	180 Gauss	7096* (1)

(1) For longer tape, specify the total length in feet. Example: 70966 = 6 ft.

OsiSense[®] XS

Inductive proximity sensors

SG magnet actuated sensors
Magnet actuators

2

Magnet actuator dimensions, mm

Tubular magnet actuator 7046

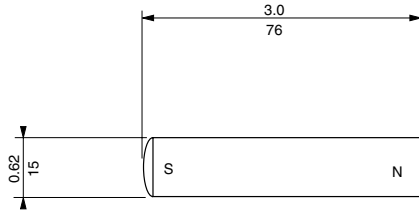

**Magnet actuator 7093 (south pole)
Magnet actuator 7597 (north pole)**

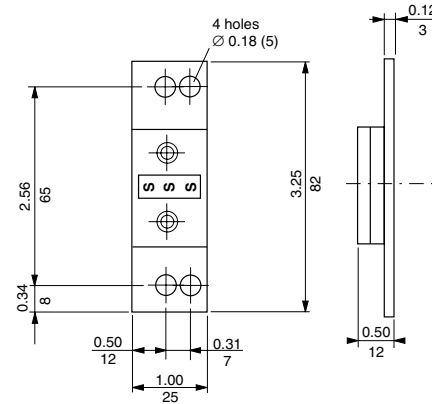

**Magnetic actuator 7063 (south pole)
Magnet actuator 70631 (north pole)**

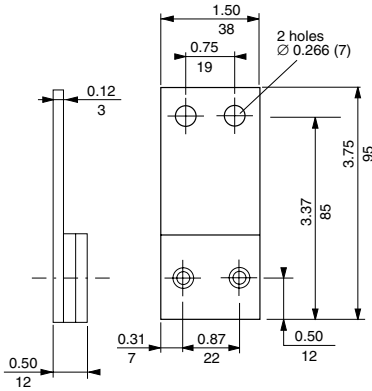

**Magnet actuator 7062 (south pole)
Magnet actuator 70621 (north pole)**

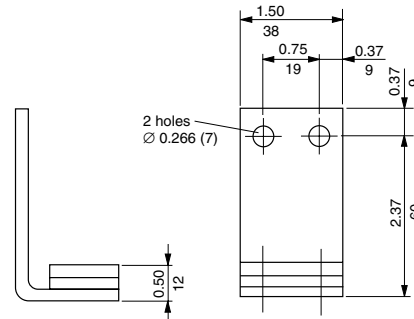

in.
(mm)

in.
(mm)

Block type magnet actuator 7099

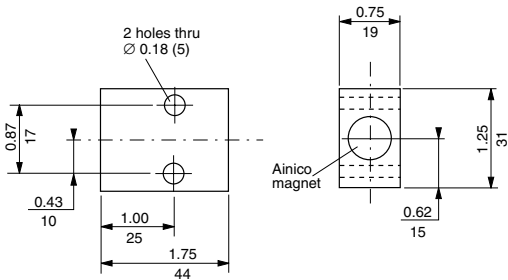

Flexible magnetic tape 7096• (1 ft)

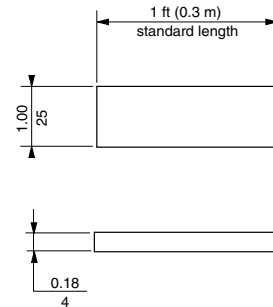

in.
(mm)

OsiSense® XS

Inductive proximity sensors

ST grounded probe switch

Dimensions

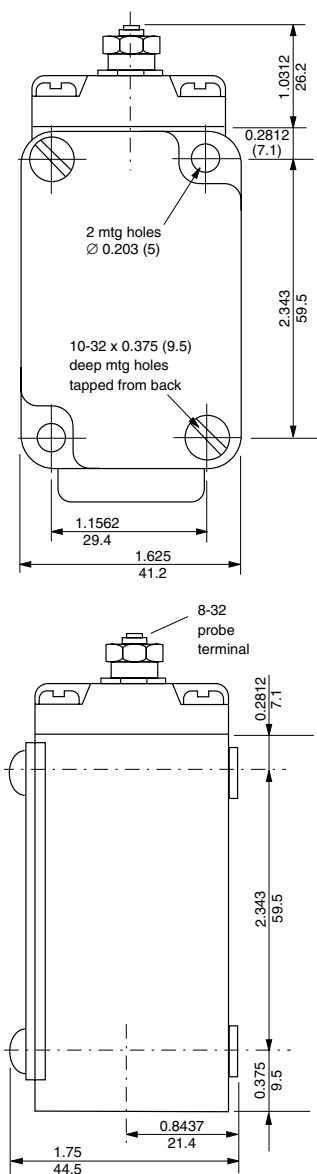

in.
(mm)

The touch switch is a highly reliable AC solid-state presence sensor designed for precise conductivity sensing. Applications include high temperature, light conductive, aggressive mechanical, and chemical environments that target positive end-point sensing. All models have a visible neon pilot light to indicate operation of the switch.

Features

- Diecast zinc housing
- Solid state—no moving parts
- 115 Vac, completely self-contained
- Probes up to 10 ft (3 m) long
- High current output—no relay required for most applications
- Fast response—no warm-up time
- 12.7 mm (0.5 in.) NPT conduit entrance
- UL Recognized

Operation

The switch is actuated when a conductive path is established between the probe terminal and ground (1 MΩ or less). The electrical contact to ground operates the switching thyristor. Internal RC snubber and varistor provide effective protection from typical transients. Normal open models have a 10 ms (maximum) turn on time. Different off-delay times are offered to permit compensation for relay chatter when the probe is subjected to bounce from irregular contact with the grounded metal point of contact.

NOTE: For isolated circuits where the ground is not common, the ground terminal of the switch should be connected to the neutral. The metal target to be detected by the probe should also then be wired to the neutral.

Probe characteristics

The probe terminal is an 8-32 stud protruding from the center of the head. Extensions may be any electrically conductive wire or material suitably insulated from grounded surface and limited in length to 3 m (10 ft) or less.

- Open voltage: 12 Vdc
- Peak current: 1 mA

Switch models

Circuit type	Voltage (nominal)	Current load (maximum)	Leakage current (maximum)	On delay	Off delay	Catalog Number
--------------	-------------------	------------------------	---------------------------	----------	-----------	----------------

Terminal screws

N.O.	120 Vac	3 A	1.7 mA	10 ms	100 ms	STO8164
N.C.	120 Vac	3 A	1.7 mA	100 ms	30 m s	ST18165
N.O.	120 Vac	3 A	1.7 mA	10 ms	400 ms	STO8166
N.O.	120 Vac	3 A	1.7 mA	10 ms	20 ms	STO8167

Pre-wired with 0.9 m (3 ft) of cable

N.O.	120 Vac	3 A	1.7 mA	10 ms	100 ms	STO8001
N.C.	120 Vac	3 A	1.7 mA	100 ms	30 ms	ST18002
N.O.	120 Vac	3 A	1.7 mA	10 ms	400 ms	STO8036
N.O.	120 Vac	3 A	1.7 mA	10 ms	20 ms	STO8042



OsiSense® XS

Inductive proximity sensors

ST grounded probe switch

Wiring

Cable wiring

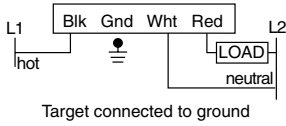

Terminal strip wiring

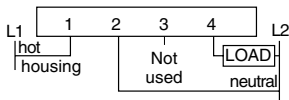

Target connected to ground.
Housing must be grounded for proper operation.

Model ST switches may be wired in series or parallel. Connect the red lead to the black lead of other switch (terminal 4 to terminal 1 of the other switch) for series operation. The voltage drop across each switch (in the closed state) does not exceed 2 Vac.

Specifications

General characteristics	
Temperature range	-40 to 70 °C (-40 to 158 °F)
Enclosure ratings	NEMA Types 1, 4, 13
Voltage drop	2 V
Maximum inrush current	10 A
Minimum load current	15 mA
Power supply current (no load)	30 mA
Cable	0.9 m (3 ft) 16-4 SJTO or terminal screws 1.2 mm ² (16 AWG)

2

OsiSense® XS

Inductive proximity sensors

Mounting brackets

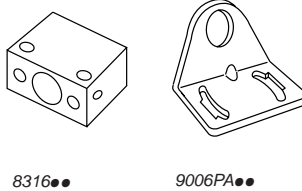

Mounting brackets

Description	Sensor Diameter	For use with	Catalog Number
Steel mounting bracket, 90° for tubular inductive proximity sensors	12 (M12 x 1)	XS1, XS2, XS4	9006PA12
	18 (M18 x 1)	XS1, XS2, XS4	9006PA18
	30 (M30 x 1.5)	XS1, XS2, XS4	9006PA30
Diecast zinc mounting bracket for tubular sensors, 4–12 mm dia.	4 mm	XS1L04	831604
	5 mm	XS1L05	831605
	6 mm	XS1L06, XS2L06	831606
	8 mm	XS1, XS2, XS4	831608
	12 mm	XS1, XS2, XS4	831612



Approximate Dimensions

9006PA**

8316 Bracket

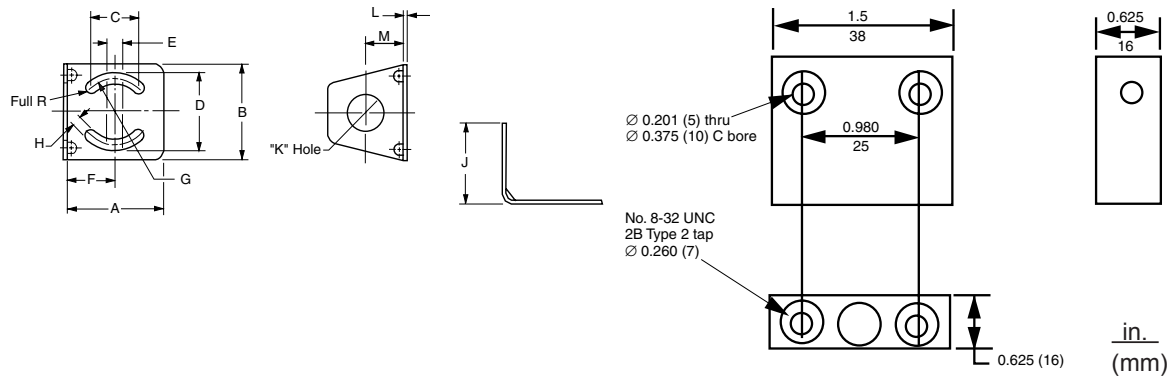

Type	A		B		C		D		E		F		G		H		J		K		L		M	
	in.	mm	in.	mm	in.	mm	in.	mm	in.	mm	in.	mm	in.	mm	in.	mm	in.	mm	in.	mm	in.	mm	in.	mm
PA30	2.64	67	2.56	65	1.39	35	1.99	51	0.39	10	1.28	33	1.97	50	0.21	5	2.05	52	1.20	31	0.08	2	0.98	25
PA18	2.05	52	1.97	50	0.97	25	1.60	41	0.39	10	0.98	25	1.38	35	0.21	5	1.65	42	0.73	19	0.08	2	0.79	20
PA12	1.38	35	1.57	40	0.69	18	1.20	31	0.39	10	0.69	18	0.98	25	0.21	5	1.28	33	0.49	13	0.08	3	0.71	18

OsiSense® XS

Inductive proximity sensors

Face caps for tubular proximity sensors

2

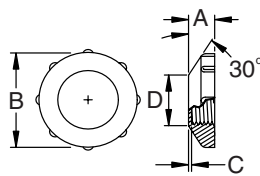

XSZEN●●

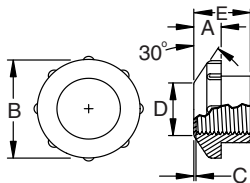

XSZENN●●

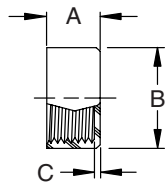

XSZSC●●●●

Features

- Shielded and non-shielded caps available
- Different versions available (beveled or non-beveled)
- Helps to provide sensor face protection with no effect on operation

Description

Protection in harsh applications, helps to prevent abrasions, cracks, and other possible damage to the sensor face. Available in several different materials: Ceramic, acetal resin, and Fluorinated hydrocarbon coated material. Helps provide the sensor with protection and a longer life without the additional charge of a stainless steel face option.

Beveled caps (30° chamfer), mm (in.)

A mm (in.)	B mm (in.)	C mm (in.)	D mm (in.)	E mm (in.)	Catalog Number
8 mm diameter shielded					
5.1 (0.20)	15.1 (0.59)	0.38 (0.15)	7.00 (0.28)	—	XSZEN08
12 mm diameter shielded					
6.2 (0.26)	24.1 (0.95)	0.76 (0.03)	12.2 (0.48)	—	XSZEN12
18 mm diameter shielded					
8.2 (0.32)	31.2 (1.23)	0.76 (0.03)	17.0 (0.67)	—	XSZEN18
30 mm diameter shielded					
7.6 (0.30)	44.5 (1.75)	1.01 (0.04)	29.0 (1.19)	—	XSZEN30
8 mm diameter non-shielded					
5.1 (0.20)	14.1 (0.56)	0.38 (0.15)	7.00 (2.76)	9.60 (0.37)	XSZENN08
12 mm diameter non-shielded					
6.5 (0.26)	22.9 (0.90)	0.76 (0.03)	12.9 (0.51)	17.3 (0.68)	XSZENN12
18 mm diameter non-shielded					
8.2 (0.32)	34.0 (1.34)	0.76 (0.03)	16.6 (0.65)	17.8 (0.70)	XSZENN18
30 mm diameter non-shielded					
7.5 (0.30)	44.5 (1.75)	1.01 (0.04)	30.0 (1.18)	22.8 (0.90)	XSZENN30

Non-beveled caps, mm (in.)

A	B	C	Catalog Number
12 mm diameter shielded			
8.90 (0.35)	16.1 (0.63)	1.26 (0.05)	XSZSC12C
8.90 (0.35)	16.1 (0.63)	0.76 (0.03)	XSZSC12D
8.90 (0.35)	16.1 (0.63)	0.76 (0.03)	XSZSC12T
18 mm diameter shielded			
8.80 (0.35)	24.4 (0.96)	1.27 (0.05)	XSZSC18D
8.80 (0.35)	24.4 (0.96)	1.27 (0.05)	XSZSC18T
12 mm diameter non-shielded			
15.2 (0.60)	16.1 (0.63)	0.76 (0.03)	XSZSC12ND
15.2 (0.60)	16.1 (0.63)	0.76 (0.03)	XSZSC12NT
18 mm diameter non-shielded			
18.0 (0.59)	24.4 (0.96)	1.27 (0.05)	XSZSC18ND
18.0 (0.59)	24.4 (0.96)	1.27 (0.05)	XSZSC18NT

OsiSense® XS Inductive proximity sensors Plunger screw adapters

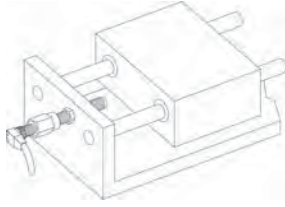

Features

- Accepts 8, 12, or 18 mm shielded sensor
- Heat-treated alloy steel construction
- Rugged stop with solid-state output

Description

Plunger screw adapters allow a shielded inductive proximity sensor to be used as a mechanical stop switch in applications requiring a precise end-of-travel signal or a hard stop. The spring requires a force of 252 g (9 oz) to actuate the sensor.

A	B mm (in.)	C	D mm (in.)	E (dia.) mm (in.)	F mm (in.)	G mm (in.)	Impact Force (Maximum)	Catalog Number
8 mm diameter shielded sensors								
M8x1	25 (1)	M8x1	3.16 (0.12)	5.84 (0.23)	6.26 (0.24)	11.0 (0.43)	2,000 N (450 lbf)	XSZB0825
M8x1	50 (2)	M8x1	3.16 (0.12)	5.84 (0.23)	6.26 (0.24)	11.0 (0.43)	2,000 N (450 lbf)	XSZB0850
12 mm diameter shielded sensors								
M12x1	25 (1)	M12x1	4.32 (0.17)	9.40 (0.37)	4.22 (0.17)	15.7 (0.62)	20,500 N (4,609 lbf)	XSZB1225
M12x1	50 (2)	M12x1	4.32 (0.17)	9.40 (0.37)	4.22 (0.17)	15.7 (0.62)	20,500 N (4,609 lbf)	XSZB1250
M12x1	75 (3)	M12x1	4.32 (0.17)	9.40 (0.37)	4.22 (0.17)	15.7 (0.62)	20,500 N (4,609 lbf)	XSZB1275
M12x1	100 (4)	M12x1	4.32 (0.17)	9.40 (0.37)	4.22 (0.17)	15.7 (0.62)	20,500 N (4,609 lbf)	XSZB1210
18 mm diameter shielded sensors								
M18x1	25 (1)	M18x1	4.32 (0.17)	14.2 (0.56)	4.22 (0.17)	22.1 (0.87)	45,000 N (10,116 lbf)	XSZB1825
M18x1	50 (2)	M18x1	4.32 (0.17)	14.2 (0.56)	4.22 (0.17)	22.1 (0.87)	45,000 N (10,116 lbf)	XSZB1850
M18x1	75 (3)	M18x1	4.32 (0.17)	14.2 (0.56)	4.22 (0.17)	22.1 (0.87)	45,000 N (10,116 lbf)	XSZB1875
M18x1	100 (4)	M18x1	4.32 (0.17)	14.2 (0.56)	4.22 (0.17)	22.1 (0.87)	45,000 N (10,116 lbf)	XSZB1810

2

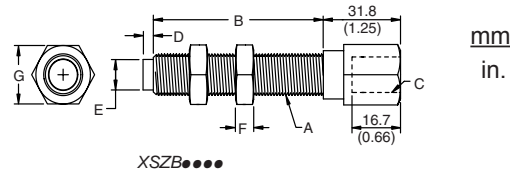

OsiSense® XS

Inductive proximity sensors

Proximity probe adapters, conduit adapters for tubular sensors

Features

- Accepts any 8 or 12 mm shielded sensor
- Accurate and compact switching in confined areas
- Large variety of stand probe lengths and diameters

Description

Proximity probes are spring-loaded actuators designed to work with 8 mm or 12 mm tubular inductive proximity sensors. The probe and sensor combination offers increased flexibility in applications that require tight positioning.

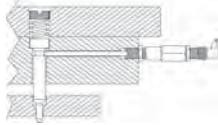

2

Dimensions: mm (in.)

A mm (in.)	B mm (in.)	C mm (in.)	D mm (in.)	E (Dia.) mm (in.)	F mm (in.)	Catalog Number
8 mm Diameter Shielded Sensor						
75.6 (2.98)	25.0 (1.00)	M8 x 1 to depth of 21.8 (0.86)	M8 x 1	3.18 (0.125)	11.1 (0.436)	XSZPP0825
99.6 (3.92)	50.0 (2.00)	M8 x 1 to depth of 21.8 (0.86)	M8 x 1	3.18 (0.125)	11.1 (0.436)	XSZPP0850
126 (4.96)	75.0 (3.00)	M8 x 1 to depth of 21.8 (0.86)	M8 x 1	3.18 (0.125)	11.1 (0.436)	XSZPP0875
150 (5.91)	100 (4.00)	M8 x 1 to depth of 21.8 (0.86)	M8 x 1	3.18 (0.125)	11.1 (0.436)	XSZPP0810
12 mm Diameter Shielded Sensor						
75.6 (2.98)	25.0 (1.00)	M12 x 1 to depth of 18.0 (0.71)	M12 x 1	6.35 (0.25)	15.8 (0.623)	XSZPP1225
99.6 (3.92)	50.0 (2.00)	M12 x 1 to depth of 18.0 (0.71)	M12 x 1	6.35 (0.25)	15.8 (0.623)	XSZPP1250
126 (4.96)	75.0 (3.00)	M12 x 1 to depth of 18.0 (0.71)	M12 x 1	6.35 (0.25)	15.8 (0.623)	XSZPP1275
150 (5.91)	100 (4.00)	M12 x 1 to depth of 18.0 (0.71)	M12 x 1	6.35 (0.25)	15.8 (0.623)	XSZPP1210

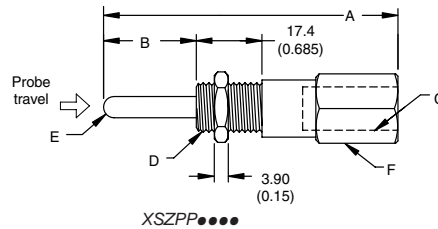

Conduit Adapters for Tubular Sensors

Features

- Available for 12, 18, and 30 mm tubular sensors
- 1/2 in. NPT inside thread
- Nickel-plated brass

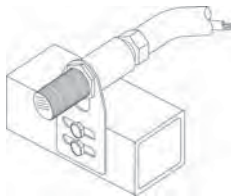

XSZCAR●●

Tube Diameter	Tube Thread Size	Dimensions, mm (in.)	Catalog Number
12 mm (0.47 in.)	M12 x 1		XSZCAR12
18 mm (0.71 in.)	M18 x 1		XSZCAR18
30 mm (1.18)	M30 x 1.5		XSZCAR30

OsiSense® XS Inductive proximity sensors

Quick change mounting tube

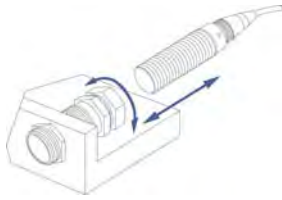

Features

- Quick change mounting available for 8, 12, 18, and 30 mm sensors
- Short and long barrel lengths available
- One-time adjustment simplifies sensor replacement
- Helps protect the sensor from impact and damage
- Fluorinated hydrocarbon coated caps available for quick change mounts (shown below)

Description

The quick change mounting tube reduces sensor maintenance and helps prevent downtime. An internal shoulder stop and collet-style locknut precisely hold the sensor in place—helping maintain a precise sensing distance and simplifying sensor installation.

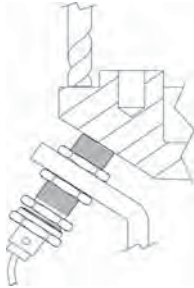

Dimensions: mm (in.)

A	B	C	D	E mm (in.)	F mm (in.)	Catalog Number
8 mm diameter shielded sensors						
8.18 (0.32)	32.4 (1.28)	17.5 (0.69)	M12x1	3.85 (0.15)	16.9 (0.67)	XSZQT08
8.18 (0.32)	48.0 (1.90)	34.0 (1.34)	M12x1	3.85 (0.15)	16.9 (0.67)	XSZQTL08
12 mm diameter shielded sensors						
12.1 (0.48)	33.7 (1.34)	19.5 (0.77)	M16.5x1.5	4.01 (0.16)	21.8 (0.86)	XSZQT12
12.1 (0.48)	44.8 (1.76)	30.0 (1.18)	M16.5x1.5	4.01 (0.16)	21.8 (0.86)	XSZQTL12
18 mm diameter shielded sensor						
18.1 (0.71)	38.5 (1.52)	20.0 (0.79)	M24 x 1.5	4.95 (0.19)	30.0 (1.18)	XSZQT18
18.1 (0.71)	58.0 (2.28)	40.0 (1.57)	M24 x 1.5	4.95 (0.19)	30.0 (1.18)	XSZQTL18
30 mm diameter shielded sensors						
30.1 (1.19)	35.0 (1.50)	20.0 (0.79)	M36 x 1.5	6.13 (0.24)	41.0 (1.61)	XSZQT30
30.1 (1.19)	58.0 (2.28)	40.0 (1.57)	M36 x 1.5	6.13 (0.24)	41.0 (1.61)	XSZQTL30

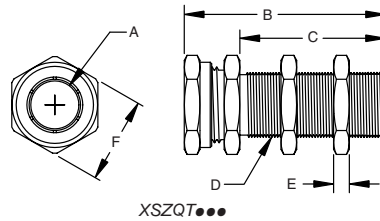

Fluorinated hydrocarbon coated caps for quick change mounting tubes

A mm (in.)	B mm (in.)	C mm (in.)	D mm (in.)	Catalog Number
8.84 (0.35)	14.8 (0.59)	0.76 (0.03)	M12x1	XSZQTC08
7.24 (0.29)	19.9 (0.75)	0.76 (0.03)	M16x1	XSZQTC12
9.00 (0.35)	28.7 (1.13)	0.76 (0.03)	M24x1.5	XSZQTC18
9.00 (0.35)	41.4 (1.63)	1.26 (0.05)	M36x1.5	XSZQTC30

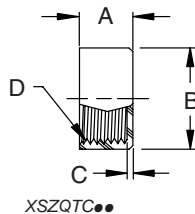

OsiSense® XS

Inductive proximity sensors

Spring-loaded tubular sensor mount

Features

- Accepts 8, 12, 18, and 30 mm shielded or non-shielded sensors
- Shocked is absorbed so sensors can possibly be unaffected by accidental impact
- Shielded and non-shielded caps available (see page 2/126)

Description

Spring-loaded sensor mount for tubular body styles helps prevent impact damage to the sensor from target overtravel. The mount is designed to be threaded onto a tubular sensor and held in place with one of the mounting nuts provided with the sensor. Caps are available to help protect the face of the sensor from lateral and axial impacts (see page 2/126).

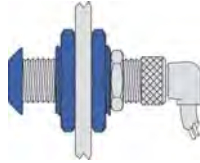

2

Dimensions: mm (in.)

A Inside Thread	B Outside Thread	C Maximum mm (in.)	D Across Flats mm (in.)	E Maximum Overtravel	F mm (in.)	G mm (in.)	Catalog Number
8 mm Diameter Sensors							
M8 x 1	M16 x 1.5	12.2 (0.481)	22.2 (0.875)	9.22 (0.363)	22.0 (0.867)	3.10 (0.155)	XSZSN08
12 mm Diameter Sensors							
M12 x 1	M18 x 1	10.0 (0.394)	23.9 (0.943)	12.1 (0.476)	21.3 (0.840)	3.94 (0.156)	XSZSN12LP
M12 x 1	M22 x 1.5	11.5 (0.454)	28.4 (1.12)	10.5 (0.413)	22.1 (0.871)	3.88 (0.153)	XSZSN12
18 mm Diameter Sensors							
M18 x 1	M30 x 1.5	16.1 (0.634)	34.8 (1.37)	13.3 (0.523)	29.7 (1.17)	5.08 (0.20)	XSZSN18
30 mm Diameter Sensors							
M30 x 1.5	M47 x 1.5	24.6 (0.972)	50.8 (2.00)	15.6 (0.615)	37.0 (1.37)	4.98 (0.196)	XSZSN30

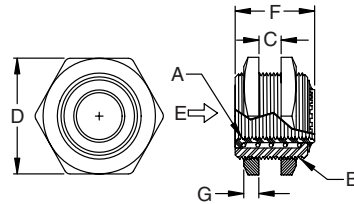

XSZSN●●

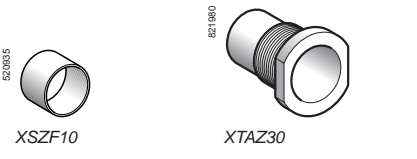
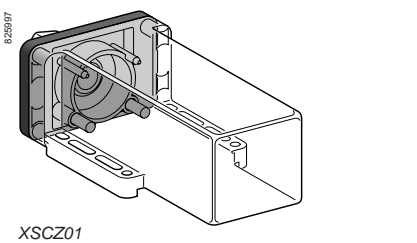
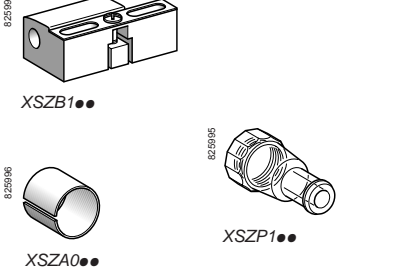
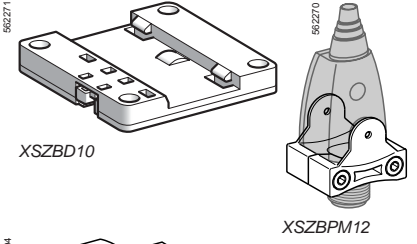
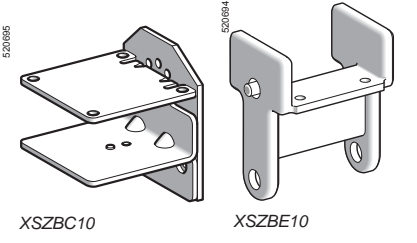
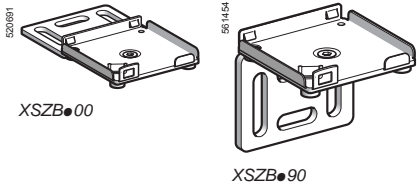

Mounting and mounting accessories

Description	For use with sensor Type	Diameter (mm)	Catalog Number	Weight kg (lb)	
Clip mounting plate Can be mounted without clip-on threaded holes	XS●J	–	XSZBJ00	0.003 (0.01)	
	XS●F	–	XSZBF00	0.005 (0.01)	
	XS●E	–	XSZBE00	0.025 (0.06)	
	XS●C	–	XSZBC00	0.060 (0.13)	
Clip 90° mounting bracket Can be mounted without clip-on threaded holes	XS●J	–	XSZBJ90	0.003 (0.01)	
	XS●F	–	XSZBF90	0.005 (0.01)	
	XS●E	–	XSZBE90	0.025 (0.06)	
	XS●C	–	XSZBC90	0.060 (0.13)	
Replacement bracket Replaces: XS7 T2, XS8T2, XSE	XS●E	–	XSZBE10	0.060 (0.13)	
	XS●C	–	XSZBC10	0.110 (0.24)	
	XS●D (for XSD) (1)	–	XSZBD10	0.065 (0.14)	
	XS9, XS6●●●B2	–	XSZBPM12	0.015 (0.03)	
Mounting clamp for remote control	XS1	4 (plain)	XSZB104	0.005 (0.01)	
		5 (M5 x 0.5)	XSZB105	0.005 (0.01)	
	XS1, XS2	6.5 (plain)	XSZB165	0.005 (0.01)	
	XS1, XS2, XS4, XS5, XS6	8 (M8 x 1)	XSZB108	0.006 (0.01)	
	XS1, XS2, XS4, XS5, XS6, XT1	12 (M12 x 1)	XSZB112	0.006 (0.01)	
		18 (M18 x 1)	XSZB118	0.010 (0.02)	
		30 (M30 x 1.5)	XSZB130	0.020 (0.04)	
Mounting clamps	XT1	32 (plain)	XUZB32	0.050 (0.11)	
	Set of 2 metal mounting nuts, nickel plated	XS1	5 (M5 x 0.5)	XSZE105	0.010 (0.02)
		XS1, XS2, XS5, XS6	8 (M8 x 1)	XSZE108	0.015 (0.03)
		XS1, XS2, XT1, XS5, XS6	12 (M12 x 1)	XSZE112	0.015 (0.03)
		18 (M18 x 1)	XSZE118	0.020 (0.04)	
Set of 2 stainless steel mounting nuts		30 (M30 x 1.5)	XSZE130	0.050 (0.11)	
	XS1, XS2, XS5, XS6	8 (M8 x 1)	XSZE308	0.015 (0.03)	
	XS1, XS2, XT1, XS5, XS6	12 (M12 x 1)	XSZE312	0.015 (0.03)	
		18 (M18 x 1)	XSZE318	0.020 (0.04)	
Set of 2 plastic mounting nuts		30 (M30 x 1.5)	XSZE330	0.050 (0.11)	
	XS4	8 (M8 x 1)	XSZE208	0.002 (0.01)	
		12 (M12 x 1)	XSZE212	0.003 (0.01)	
	XS4	18 (M18 x 1)	XSZE218	0.004 (0.01)	
Adapter collar		30 (M30 x 1.5)	XSZE230	0.005 (0.01)	
	∅ 20 XS●, XT●	18 (M18 x 1)	XSZA020	0.005 (0.01)	
	∅ 34 XS●, XT●	30 (M30 x 1.5)	XSZA034	0.005 (0.01)	

Protection accessories

Cable sleeve adapter (CNOMO type)	XS●, XT●	12 (M12 x 1)	XSZP112	0.005 (0.01)
		18 (M18 x 1)	XSZP118	0.005 (0.01)
		30 (M30 x 1.5)	XSZP130	0.010 (0.02)
Outer cover (IP 68)	XT7C	–	XSCZ01	0.100 (0.22)
Thread adapter	XS●, XT●	30 (M30 x 1.5)	XTAZ30	0.035 (0.08)
Pg 13 cable gland	Clamping capacity ∅ 9 to 12 mm		XSZPE13	0.010 (0.02)
Protective cover	M12 universal connectors		XSZF10	0.020 (0.04)

Mounting

Threaded inserts for rear mounting	XS● E	M3	XSZVF03	0.002 (0.01)
	XS● C	M4	XSZVF04	0.005 (0.01)
	XS● D	M5	XSZVF05	0.006 (0.01)

Fuses (for unprotected 2-wire ~ sensors)

Description	Type	Sold in lots of	Catalog Number	Weight kg (lb)
Cartridge fuses 5 x 20	0.4 A fast-acting	10	XUZE04	0.001 (0.01)
	0.63 A fast-acting	10	XUZE06	0.001 (0.01)
	0.8 A fast-acting	10	XUZE08	0.001 (0.01)
Fuse terminal block for XUZE0●		50	AB1FU10135U	0.040 (0.09)

(1) Depth adjustment shim for converting 80 x 80 x 26 mm format to 80 x 80 x 40 mm format. Also enables clipping onto 35 mm omega rail.

2

XSZBJ00

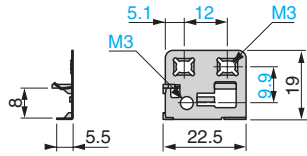

XSZBF00

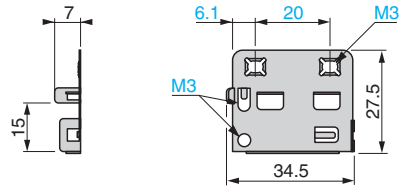

XSZBE00

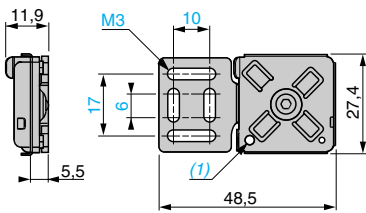

XSZBC00

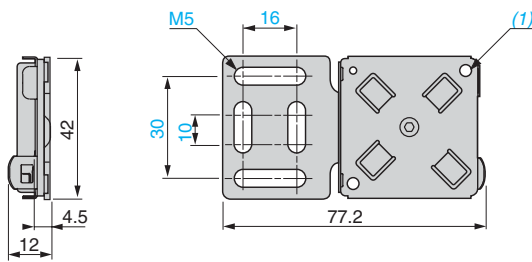

(1) 2 screws M3 x 12 (included).

(1) 4 screws M4 x 14 (included).

XSZBJ90

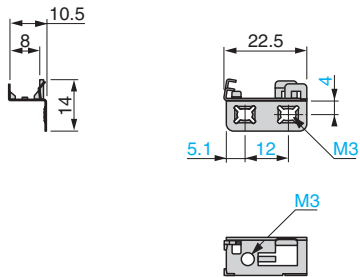

XSZBF90

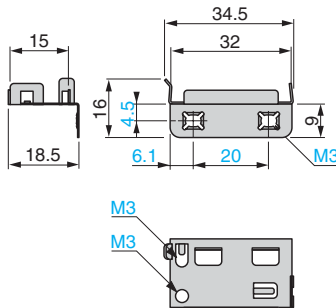

XSZBE90

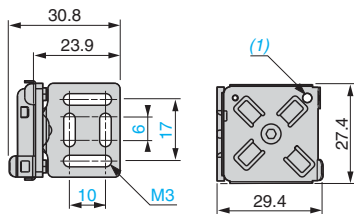

XSZBC90

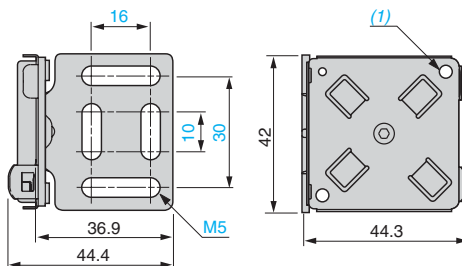

(1) 2 screws M3 x 12 (included).

(1) 4 screws M4 x 14 (included).

XSZBE10

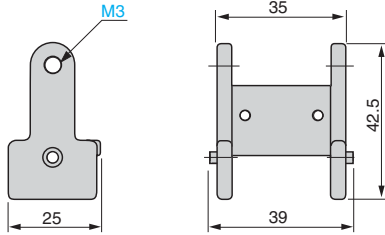

XSZBC10

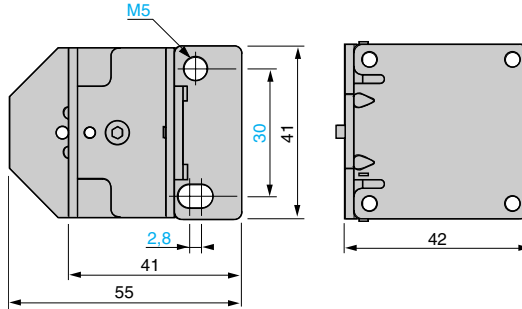

2

XSZBD10 (for mounting on XS•D•••••)

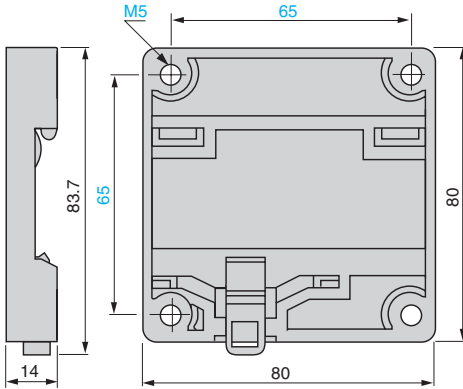

XSZBPM12

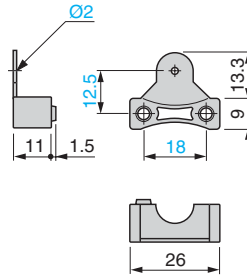

XSZB104, B105

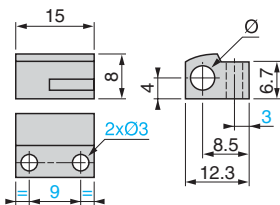

XSZB108, B112, B118, B130, B165

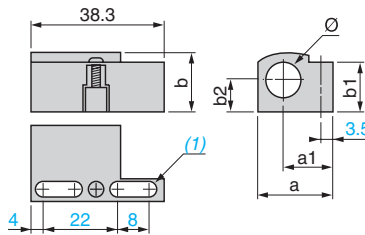

XSZ	a	a1	b	b1	b2	Ø
B108	19.9	14.5	14	12.5	7.5	8
B112	21.9	14.5	16	15.5	8.5	12
B118	26	15.7	22.3	20.1	11.5	18
B130	39	21.7	35.5	31	18.5	30
B165	19.9	14.5	14	12.5	7.5	6.5

(1) 2 elongated holes 4 x 8 mm.

XSZ	Ø
B104	4
B105	5

Note: for mounting clamps XSZB118 and XSZB130, see mounting recommendations, page 13

2

XUZB32

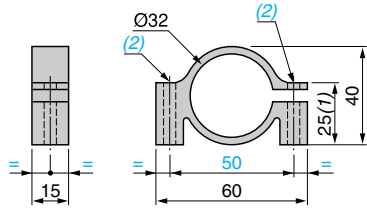

(1) Maximum value
 (2) 2 holes Ø 5.5
 2 x M5 screws, HM head, included with mounting clamp

XSZA0..

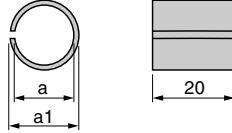

XSZ	a	a1
A020	Ø18	Ø20
A034	Ø30	Ø34

XSZP112, P118, P130

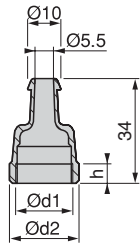

XSZ	h	Ø d1	Ø d2
P112	7	12	16.8
P118	6.2	18	23
P130	6.2	30	34.4

XSCZ01

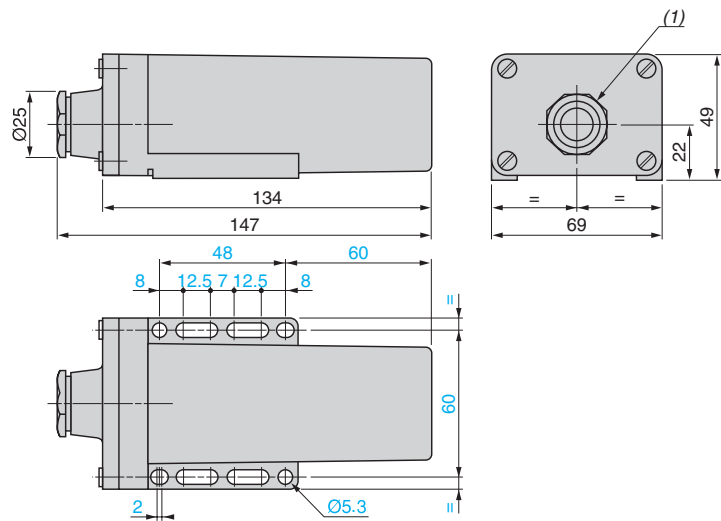

(1) Pg 13 cable gland

XTAZ30

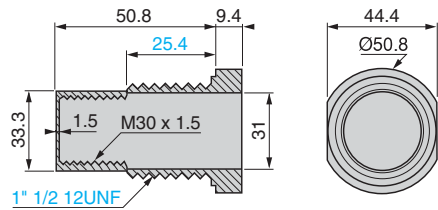

Cylindrical type sensors

Flush mountable in metal

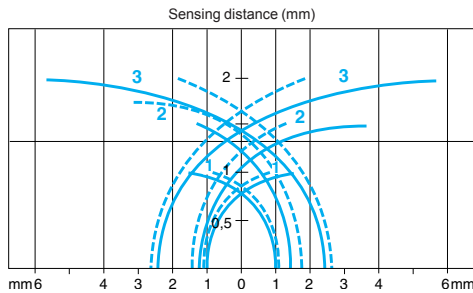

Sensor (mm)	Standard steel target (mm)	Operating zone, mm (in.)
Ø 4	5 x 5 x 1	0–0.8 (0–0.03)
Ø 5	5 x 5 x 1	0–0.8 (0–0.03)
Ø 6.5	8 x 8 x 1	0–1.2 (0–0.05)
Ø 8	8 x 8 x 1	0–1.2 (0–0.05)
Ø 12	12 x 12 x 1	0–1.6 (0–0.06)

- pick-up points
- - - drop-out points (object approaching from the side)
- 1 Ø 4 (plain) XS1 and Ø 5 (M5 x 0.5) XS1
- 2 Ø 6.5 (plain) XS1 and Ø 8 (M8 x 1) XS5
- 3 Ø 12 (M12 x 1) XS5

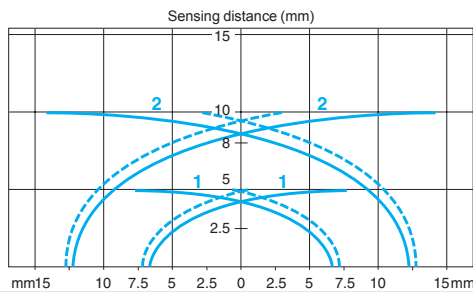

Sensor (mm)	Standard steel target (mm)	Operating zone, mm (in.)
Ø 18	18 x 18 x 1	0–4 (0–0.16)
Ø 30	30 x 30 x 1	0–8 (0–0.31)

- pick-up points
- - - drop-out points (object approaching from the side)
- 1 Ø 18 (M18 x 1) XS5
- 2 Ø 30 (M30 x 1.5) XS5

Non-flush mountable in metal

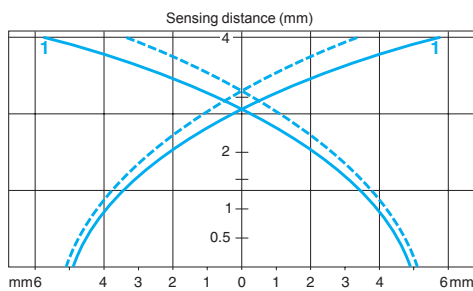

Sensor (mm)	Standard steel target (mm)	Operating zone, mm (in.)
Ø 12	12 x 12 x 1	0–3.2 (0–0.13)

- pick-up points
- - - drop-out points (object approaching from the side)
- 1 Ø 12 (M12 x 1) XS4

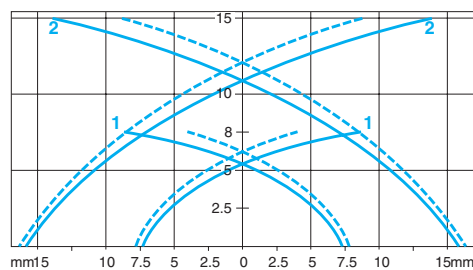

Sensor (mm)	Standard steel target (mm)	Operating zone, mm (in.)
Ø 18	24 x 24 x 1	0–6.4 (0–0.25)
Ø 30	45 x 45 x 1	0–12 (0–0.47)

- pick-up points
- - - drop-out points (object approaching from the side)
- 1 Ø 18 (M18 x 1), XS4
- 2 Ø 30 (M30 x 1.5), XS4

Cylindrical type sensors, increased range

Flush mountable in metal

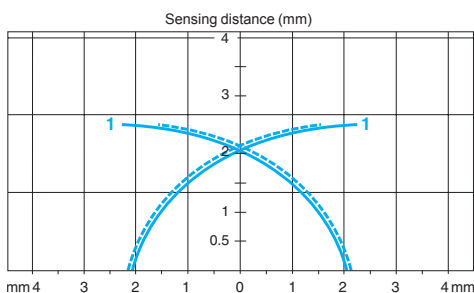

Sensor (mm)	Standard steel target (mm)	Operating zone, mm (in.)
Ø 6.5	8 x 8 x 1	0–2 (0–0.08)

- pick-up points
- - - drop-out points (object approaching from the side)
- 1 Ø 6.5 (plain) XS1L06pp349

2

Flat type sensors

Flush mountable in metal

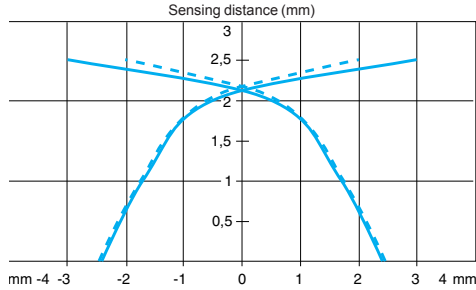

Sensor (mm)	Standard steel target (mm)	Operating zone, mm (in.)
XS7J1A1D	5 x 5 x 1	0–2 (0–0.08)

— pick-up points
- - - drop-out points (object approaching from the side)

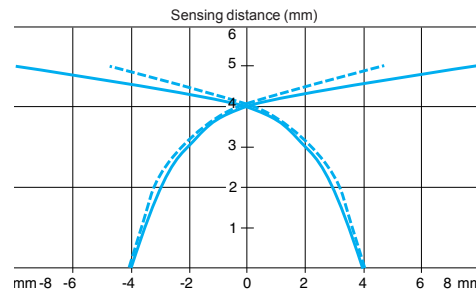

Sensor (mm)	Standard steel target (mm)	Operating zone, mm (in.)
XS7F1A1D	5 x 5 x 1	0–4 (0–0.16)

— pick-up points
- - - drop-out points (object approaching from the side)

Non-flush mountable in metal

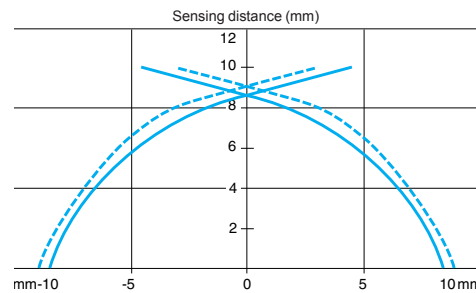

Sensor (mm)	Standard steel target (mm)	Operating zone, mm (in.)
XS7E1A1D	8 x 8 x 1	0–8 (0–0.31)
XS7E1A1C	8 x 8 x 1	0–8 (0–0.31)

— pick-up points
- - - drop-out points (object approaching from the side)

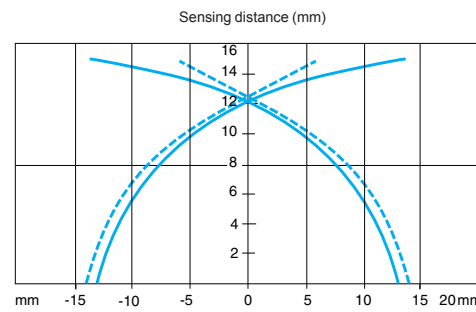

Sensor (mm)	Standard steel target (mm)	Operating zone, mm (in.)
XS7C1A1D	18 x 18 x 1	0–12 (0–0.47)
XS7C1A1C	18 x 18 x 1	0–12 (0–0.47)

— pick-up points
- - - drop-out points (object approaching from the side)

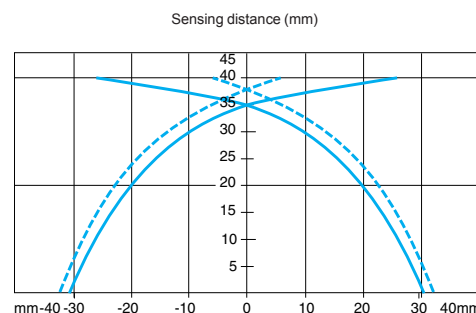

Sensor (mm)	Standard steel target (mm)	Operating zone, mm (in.)
XS7D1A1D	30 x 30 x 1	0–32 (0–1.26)
XS7D1A1C	30 x 30 x 1	0–32 (0–1.26)

— pick-up points
- - - drop-out points (object approaching from the side)

2

Old sensor	New OsiSense® XS sensor	Old sensor	New OsiSense® XS sensor	Old sensor	New OsiSense® XS sensor
Cylindrical type, DC (continued)					
Diameter 12 mm					
XS1					
XS1D12NA140	XS112BLNAL2	XS1N12NB340D	XS512B1NBM12	XS2N12NA340	XS112B3NAL2
XS1D12NA140D	XS112BLNAM12	XS1N12PA340	XS512B1PAL2	XS2N12NA340D	XS112B3NAM12
XS1D12PA140	XS112BLPAL2	XS1N12PA340D	XS512B1PAM12	XS2N12NA340L1	XS112B3NAL5
XS1D12PA140D	XS112BLPAM12	XS1N12PA340L1	XS512B1PAL5	XS2N12NA340L2	XS112B3NAL10
XS1D12PA140L1	XS112BLPAL5	XS1N12PA340L2	XS512B1PAL10	XS2N12NB340	XS112B3NBL2
		XS1N12PA340LD	XS512B1PAM12 (1)	XS2N12NB340D	XS112B3NBM12
		XS1N12PA340S	XS512B1PAM12 (2)	XS2N12PA340	XS112B3PAL2
		XS1N12PB340	XS512B1PBL2	XS2N12PA340D	XS112B3PAM12
		XS1N12PB340D	XS512B1PBM12	XS2N12PA340L1	XS112B3PAL5
		XS1N12PB340L1	XS512B1PBL5	XS2N12PA340L2	XS112B3PAL10
				XS2N12PB340	XS112B3PBL2
XS1M12DA210	XS512B1DAL2	XS1M12PA349D	XS612B1PAM12	XS2N12PB340D	XS112B3PBM12
XS1M12DA210D	XS512B1DAM12	XS1N12NA349	XS112B3NAL2	XS2N12PB340L1	XS112B3PBL5
XS1M12DA210L1	XS512B1DAL5	XS1N12NA349L1	XS112B3NAL5		
XS1M12DA210L2	XS512B1DAL10	XS1N12NA349D	XS112B3NAM12	XS3	
XS1M12DA210LA	XS512B1DAL08U78	XS1N12NB349	XS112B3NBL2	XS3P12NA340	XS512B1NAL2 (3)
XS1M12DA210LD	XS512B1DAL08M12	XS1N12NB349L1	XS112B3NBL5	XS3P12NA340D	XS512B1NAM12 (3)
XS1M12DB210	XS512B1DBL2	XS1N12NB349D	XS112B3NBM12	XS3P12NA340L1	XS512B1NAL5 (3)
XS1M12DB210D	XS512B1DBM12	XS1N12PA349	XS112B3PAL2	XS3P12PA340	XS512B1PAL2 (3)
XS1M12DB210L1	XS512B1DBL5	XS1N12PA349L1	XS112B3PAL5	XS3P12PA340D	XS512B1PAM12 (3)
XS1M12DB210L2	XS512B1DBL10	XS1N12PA349D	XS112B3PAM12	XS3P12PA340L1	XS512B1PAL5 (3)
XS1M12DB210LD	XS512B1DBL08M12	XS1N12PB349	XS112B3PBL2		
		XS1N12PB349L1	XS112B3PBL5	XS3P12NA370	XS512BLNAL2 (3)
XS1M12DA214D	XS512B1CAM12	XS1N12PB349D	XS112B3PBM12	XS3P12NA370L1	XS512BLNAL5 (3)
XS1M12DA214LD	XS512B1CAL08M12			XS3P12PA370	XS512BLPAL2 (3)
				XS3P12PA370L1	XS512BLPAL5 (3)
		XS2			
XS1M12NA370	XS512BLNAL2	XS2D12NA140	XS212BLNAL2		
XS1M12NA370D	XS512BLNAM12	XS2D12NA140D	XS212BLNAM12		
XS1M12NA370L1	XS512BLNAL5	XS2D12NA140L1	XS212BLNAL5		
XS1M12NA370L2	XS512BLNAL10	XS2D12PA140	XS212BLPAL2		
XS1M12NA370S	XS612B1NAM12 (2)	XS2D12PA140D	XS212BLPAM12		
XS1M12NB370	XS512BLNBL2	XS2D12PA140L1	XS212BLPAL5		
XS1M12NB370D	XS512BLNBM12				
XS1M12PA370	XS512BLPAL2	XS2M12NA370	XS612B1NAL2		
XS1M12PA370D	XS512BLPAM12	XS2M12NA370D	XS612B1NAM12		
XS1M12PA370L1	XS512BLPAL5	XS2M12NA370L1	XS612B1NAL5		
XS1M12PA370L2	XS512BLPAL10	XS2M12NA370L2	XS612B1NAL10		
XS1M12PA370LA	XS612B1PAL08U78	XS2M12NB370	XS612B1NBL2		
XS1M12PA370LD	XS612B1PAL08M12	XS2M12NB370D	XS612B1NBM12		
XS1M12PB370	XS512BLPBL2	XS2M12PA370	XS612B1PAL2		
XS1M12PB370D	XS512BLPBM12	XS2M12PA370D	XS612B1PAM12		
XS1M12PB370L1	XS512BLPBL5	XS2M12PA370L1	XS612B1PAL5		
XS1M12PB370L2	XS512BLPBL10	XS2M12PA370L2	XS612B1PAL10		
XS1M12PB370LD	XS612B1PAM12 (1)	XS2M12PA370LA	XS612B1PAL08U78		
		XS2M12PA370LD	XS612B1PAL08M12		
XS1N12NA340	XS512B1NAL2	XS2M12PB370	XS612B1PBL2		
XS1N12NA340D	XS512B1NAM12	XS2M12PB370D	XS612B1PBM12		
XS1N12NA340L1	XS512B1NAL5	XS2M12PB370L1	XS612B1PBL5		
XS1N12NA340L2	XS512B1NAL10	XS2M12PB370S	XS612B1PBM12 (2)		
XS1N12NB340	XS512B1NBL2				

(1) For the new sensor an integral M12 connector replaces the remote M12 connector on a 0.80 m pigtail connector.
 (2) For the new sensor an M12 connector replaces the M8 connector.
 (3) For the new OsiSense XS sensor, the metal case replaces the plastic case.



Old sensor	New OsiSense® XS sensor	Old sensor	New OsiSense® XS sensor	Old sensor	New OsiSense® XS sensor
Cylindrical type, DC (continued)					
Diameter 30 mm					
XS1					
XS1D30NA140	XS130BLNAL2	XS1M30PA370D	XS530BLPAM12	XS2M30NB370L2	XS630B1NBL10
XS1D30NA140D	XS130BLNAM12	XS1M30PA370G	XS630B1PAL01G (4)	XS2M30PA370	XS630B1PAL2
XS1D30PA140	XS130BLPAL2	XS1M30PA370L1	XS530BLPAL5	XS2M30PA370A	XS630B1PAL01U78 (4)
XS1D30PA140D	XS130BLPAM12	XS1M30PA370L2	XS530BLPAL10	XS2M30PA370B	XS630B1PAL01B (4)
XS1D30PA140L1	XS130BLPAL5	XS1M30PB370	XS530BLPBL2	XS2M30PA370C	XS630B1PAL01C (4)
XS2D30NA140	XS230BLNAL2	XS1M30PB370B	XS630B1PBL01B (4)	XS2M30PA370D	XS630B1PAM12
XS2D30NA140D	XS230BLNAM12	XS1M30PB370C	XS630B1PBL01C (4)	XS2M30PA370G	XS630B1PAL01G (4)
XS2D30PA140	XS230BLPAL2	XS1M30PB370D	XS530BLPBM12	XS2M30PA370L1	XS630B1PAL5
XS2D30PA140D	XS230BLPAM12	XS1M30PB370G	XS630B1PBL01G (4)	XS2M30PB370	XS630B1PBL2
		XS1M30PB370L1	XS530BLPBL5	XS2M30PB370B	XS630B1PBL01B (4)
		XS1M30PB370L2	XS530BLPBL10	XS2M30PB370C	XS630B1PBL01C (4)
				XS2M30PB370D	XS630B1PBM12
		XS1N30NA340	XS530B1NAL2	XS2M30PB370G	XS630B1PBL01G (4)
		XS1N30NA340D	XS530B1NAM12	XS2M30PB370L1	XS630B1PBL5
		XS1N30NA340L1	XS530B1NAL5	XS2M30PB370L2	XS630B1PBL10
		XS1N30NA340L2	XS530B1NAL10		
		XS1N30NB340	XS530B1NBL2	XS3	
		XS1N30NB340D	XS530B1NBL5	XS3P30NA340	XS530B1NAL2 (3)
		XS1N30NB340L1	XS530B1NBL10	XS3P30NA340D	XS530B1NAM12 (3)
		XS1N30NB340L2	XS530B1NBM12	XS3P30NA340L1	XS530B1NAL5 (3)
		XS1N30PA340	XS530B1PAL2	XS3P30PA340	XS530B1PAL2 (3)
		XS1N30PA340D	XS530B1PAL5	XS3P30PA340D	XS530B1PAM12 (3)
		XS1N30PA340L1	XS530B1PAL10	XS3P30PA340L1	XS530B1PAL5 (3)
		XS1N30PA340L2	XS530B1PBL2	XS3P30PA340L2	XS530B1PAL10 (3)
		XS1N30PB340	XS530B1PBL5		
		XS1N30PB340D	XS530B1PBM12		
		XS2			
		XS2N30NA340	XS130B3NAL2	XS3P30PA370	XS530BLPAL2 (3)
		XS2N30NA340D	XS130B3NAM12	XS3P30PA370L1	XS530BLPAL5 (3)
		XS2N30NA340L1	XS130B3NAL5	XS3P30PA370L2	XS530BLPAL10 (3)
		XS2N30NA340L2	XS130B3NAL10	XS3P30NA370	XS530BLNAL2 (3)
		XS2N30NB340	XS130B3NBL2	XS3P30NA370L1	XS530BLNAL5 (3)
		XS2N30NB340D	XS130B3NBL5		
		XS2N30NB340L1	XS130B3NBM12	XS4	
		XS2N30NB340L2	XS130B3PAL2	XS4P30NA370B	XS4P30NA370L01B (4)
		XS2N30PA340	XS130B3PAL5	XS4P30NB370B	XS4P30NB370L01B (4)
		XS2N30PA340D	XS130B3PAL10	XS4P30PA370B	XS4P30PA370L01B (4)
		XS2N30PA340L1	XS130B3PBL2	XS4P30PB370B	XS4P30PB370L01B (4)
		XS2N30PA340L2	XS130B3PBL5		
		XS2N30PB340	XS130B3PBM12		
		XS2N30PB340D			
		XS2M30NA370	XS630B1NAL2		
		XS2M30NA370B	XS630B1NAL01B (4)		
		XS2M30NA370C	XS630B1NAL01C (4)		
		XS2M30NA370D	XS630B1NAM12		
		XS2M30NA370L1	XS630B1NAL5		
		XS2M30NA370L2	XS630B1NAL10		
		XS2M30NB370	XS630B1NBL2		
		XS2M30NB370B	XS630B1NBL01B (4)		
		XS2M30NB370C	XS630B1NBL01C (4)		
		XS2M30NB370D	XS630B1NBL10		
		XS2M30NB370L1			
		XS2M30NB370L2			
		XS2M30PA370	XS530BLPAL2		
		XS2M30PA370A	XS630B1PAL01U78 (4)		
		XS2M30PA370B	XS630B1PAL01B (4)		
		XS2M30PA370C	XS630B1PAL01C (4)		
		XS2M30PA370D	XS630B1PAL01G (4)		

(1) For the new sensor an integral M12 connector replaces the remote M12 connector on a 0.80 m pigtail connector.
 (3) For the new OsiSense XS sensor, the metal case replaces the plastic case.
 (4) For the new sensor, connectors A, B, C and G on 0.1 m pigtail connector replace integral connectors A, B, C and G.
 (5) For the new sensor, Sn = 15 mm (0.59 in.) instead of 20 mm (0.79 in.)

Old sensor	New OsiSense® XS sensor	Old sensor	New OsiSense® XS sensor	Old sensor	New OsiSense® XS sensor
Cylindrical type, AC or DC		Diameter 18 mm		XS3	
Diameter 12 mm		XS1		XS3P18MA230 XS618B1MAL2 (3)	
XS1		XS1M18FA264 XS118BLFAL2		XS3P18MA230K XS618B1MAU20 (3)	
XS1M12FA264	XS112BLFAL2			XS3P18MA230L1 XS618B1MAL5 (3)	
XS1M12FA264L2	XS112BLFAL10			XS3P18MA230L2 XS618B1MAL10 (3)	
		XS1M18MA230	XS518B1MAL2	XS3P18MB230 XS618B1MBL2 (3)	
		XS1M18MA230A	XS618B1MAL01U78 (4)	XS3P18MB230A XS618B1MBU20 (3)	
XS1M12MA230	XS512B1MAL2	XS1M18MA230B	XS618B1MAL01B (4)	XS3P18MB230K XS618B1MBU20 (3)	
XS1M12MA230K	XS512B1MAU20	XS1M18MA230C	XS618B1MAL01C (4)	XS3P18MB230L1 XS618B1MBL5 (3)	
XS1M12MA230L1	XS512B1MAL5	XS1M18MA230G	XS618B1MAL01G (4)	XS3P18MB230L2 XS618B1MBL5 (3)	
XS1M12MA230L2	XS512B1MAL10	XS1M18MA230K	XS518B1MAU20		
XS1M12MB230	XS512B1MBL2	XS1M18MA230L1	XS518B1MAL5	XS4	
XS1M12MB230K	XS512B1MBU20	XS1M18MA230L2	XS518B1MAL10	XS4P18MA230B XS4P18MA230L01B (4)	
XS1M12MB230L1	XS512B1MBL5	XS1M18MB230	XS518B1MBL2	XS4P18MA230C XS4P18MA230L01C (4)	
XS1M12MB230L2	XS512B1MBL10	XS1M18MB230A	XS618B1MBL01U78 (4)	XS4P18MA230G XS4P18MA230L01G (4)	
		XS1M18MB230B	XS618B1MBL01B (4)	XS4P18MB230B XS4P18MB230L01B (4)	
		XS1M18MB230C	XS618B1MBL01C (4)	XS4P18MB230C XS4P18MB230L01C (4)	
XS1M12MA239	XS612B1MAL2	XS1M18MB230G	XS618B1MBL01G (4)		
XS1M12MA239K	XS612B1MAU20	XS1M18MB230K	XS518B1MBU20		
		XS1M18MB230L1	XS518B1MBL5		
		XS1M18MB230L2	XS518B1MBL10		
XS2					
XS2M12MA230	XS612B1MAL2	XS1M18MA239	XS618B1MAL2 (5)		
XS2M12MA230K	XS612B1MAU20	XS1M18MA239A	XS1M18MA239L01A (4)		
XS2M12MA230L1	XS612B1MAL5	XS1M18MA239K	XS618B1MAU20 (5)		
XS2M12MA230L2	XS612B1MAL10				
XS2M12MB230	XS612B1MBL2				
XS2M12MB230K	XS612B1MBU20				
XS2M12MB230L1	XS612B1MBL5				
XS2M12MB230L2	XS612B1MBL10				
		XS2			
XS3		XS2M18MA230	XS618B1MAL2		
XS3P12MA230	XS612B1MAL2 (3)	XS2M18MA230A	XS618B1MAL01U78 (4)		
XS3P12MA230K	XS612B1MAU20 (3)	XS2M18MA230B	XS618B1MAL01B (4)		
XS3P12MA230L1	XS612B1MAL5 (3)	XS2M18MA230C	XS618B1MAL01C (4)		
XS3P12MA230L2	XS612B1MAL10 (3)	XS2M18MA230G	XS618B1MAL01G (4)		
XS3P12MB230	XS612B1MBL2 (3)	XS2M18MA230K	XS618B1MAU20		
XS3P12MB230K	XS612B1MBU20 (3)	XS2M18MA230L1	XS618B1MAL5		
XS3P12MB230L1	XS612B1MBL5 (3)	XS2M18MA230L2	XS618B1MAL10		
		XS2M18MB230	XS618B1MBL2		
		XS2M18MB230A	XS618B1MBL01U78 (4)		
		XS2M18MB230B	XS618B1MBL01B (4)		
		XS2M18MB230C	XS618B1MBL01C (4)		
		XS2M18MB230G	XS618B1MBL01G (4)		
		XS2M18MB230K	XS618B1MBU20		
		XS2M18MB230L1	XS618B1MBL5		
		XS2M18MB230L2	XS618B1MBL10		



(3) For the new OsiSense XS sensor, the metal case replaces the plastic case.
 (4) For the new sensor, connectors A, B, C and G on 0.1 m pigtail connector replace integral connectors A, B, C and G.
 (5) For the new sensor, Sn = 8 mm (0.31 in.) instead of 10 mm (0.39 in.).

2

Old sensor	New OsiSense® XS sensor
Cylindrical type, AC or DC (continued)	
Diameter 30 mm	
XS1	
XS1M30FA264	XS130BLFAL2
XS1M30MA230	XS530B1MAL2
XS1M30MA230A	XS630B1MAL01U78 (4)
XS1M30MA230B	XS630B1MAL01B (4)
XS1M30MA230C	XS630B1MAL01C (4)
XS1M30MA230G	XS630B1MAL01G (4)
XS1M30MA230K	XS530B1MAU20
XS1M30MA230L1	XS530B1MAL5
XS1M30MA230L2	XS530B1MAL10
XS1M30MB230	XS530B1MBL2
XS1M30MB230A	XS630B1MBL01U78 (4)
XS1M30MB230B	XS630B1MBL01B (4)
XS1M30MB230C	XS630B1MBL01C (4)
XS1M30MB230G	XS630B1MBL01G (4)
XS1M30MB230K	XS530B1MBU20
XS1M30MB230L1	XS530B1MBL5
XS1M30MB230L2	XS530B1MBL10
XS1M30MA239	XS630B1MAL2 (5)
XS1M30MA239A	XS1M30MA239L01A (4)
XS2	
XS2M30MA230	XS630B1MAL2
XS2M30MA230A	XS630B1MAL01U78 (4)
XS2M30MA230B	XS630B1MAL01B (4)
XS2M30MA230C	XS630B1MAL01C (4)
XS2M30MA230G	XS630B1MAL01G (4)
XS2M30MA230K	XS630B1MAU20
XS2M30MA230L1	XS630B1MAL5
XS2M30MA230L2	XS630B1MAL10
XS2M30MB230	XS630B1MBL2
XS2M30MB230A	XS630B1MBL01U78 (4)
XS2M30MB230B	XS630B1MBL01B (4)
XS2M30MB230C	XS630B1MBL01C (4)
XS2M30MB230G	XS630B1MBL01G (4)
XS2M30MB230K	XS630B1MBU20
XS2M30MB230L1	XS630B1MBL5
XS2M30MB230L2	XS630B1MBL10

Old sensor	New OsiSense® XS sensor
XS3	
XS3P30MA230	XS630B1MAL2 (3)
XS3P30MA230K	XS630B1MAU20 (3)
XS3P30MA230L1	XS630B1MAL5 (3)
XS3P30MA230L2	XS630B1MAL10 (3)
XS3P30MB230	XS630B1MBL2 (3)
XS3P30MB230K	XS630B1MBU20 (3)
XS3P30MB230L1	XS630B1MBL5 (3)
XS4	
XS4P30MA230B	XS4P30MA230L01B (4)
XS4P30MA230C	XS4P30MA230L01C (4)
XS4P30MA230G	XS4P30MA230L01G (4)
XS4P30MB230B	XS4P30MB230L01B (4)
XS4P30MB230C	XS4P30MB230L01C (4)

(3) For the new OsiSense XS sensor, the metal case replaces the plastic case.

(4) For the new sensor, connectors A, B, C and G on 0.1 m pigtail connector replace integral connectors A, B, C and G.

(5) For the new sensor, Sn = 15 mm (0.59 in.) instead of 20 mm (0.79 in.).

X-ON Electronics

Largest Supplier of Electrical and Electronic Components

Click to view similar products for [Proximity Sensors](#) category:

Click to view products by [Schneider](#) manufacturer:

Other Similar products are found below :

[01.001.5653.1](#) [70.340.1028.0](#) [70.360.2428.0](#) [70.364.4828.0](#) [70.810.1053.0](#) [72.360.1628.0](#) [73.363.6428.0](#) [9221350022](#) [980659-1](#) [QT-12](#)
[E2EX10D1NN](#) [E2E-X14MD1-G](#) [E2E-X2D1-G](#) [E2EX2ME2N](#) [E2E-X3D1-N 10M](#) [E2E-X4MD1-G](#) [E2FMX1R5D12M](#) [E2K-F10MC1 5M](#)
[EI1204TBOSL-6](#) [EI5515NPAP](#) [BSA-08-25-08](#) [IC08ANC15PO-K](#) [IMM2582C](#) [25.161.3253.0](#) [25.332.0653.1](#) [25.352.0653.0](#) [25.352.0753.0](#)
[25.523.3253.0](#) [9151710023](#) [922FS1.5C-A4P-Z774](#) [SC606ABV0S30](#) [SM952A126100LE](#) [A1220EUA-T](#) [F3S-A162-U](#) [CL18](#) [QT-08L](#)
[34.110.0010.0](#) [TL-C2MF1-M3-E4](#) [IA08BLF15NOM5](#) [IA08BSF15NOM5](#) [IA12ASF04DOM1](#) [IMM32188C](#) [IS2](#) [IS31SE5000-UTLS2-TR](#)
[34.110.0021.0](#) [34.110.0022.0](#) [CA150-120VACDC](#) [VM18VA3000Q](#) [XS508BSCBL2](#) [XS512BLNAM12](#)