

Part Number: L-7679C1SURC-G

Technical Data



Features:

- *High luminance output.
- *Design for high current operation.
- *Uniform color.
- *Low power consumption.
- *Low thermal resistance.
- *Low profile.
- *Packaged in tubes for use with automatic insertion equipment.
- *Soldering methods: wave soldering.
- *RoHS Compliant.

Benefits:

- *Outstanding Material Efficiency.
- *Electricity savings.
- *Maintenance savings.
- *Reliable and Rugged.

Typical Applications:

- *Automotive Exterior Lighting.
- *Electronic Signs and Signals.
- *Specialty Lighting.



Outline Drawings

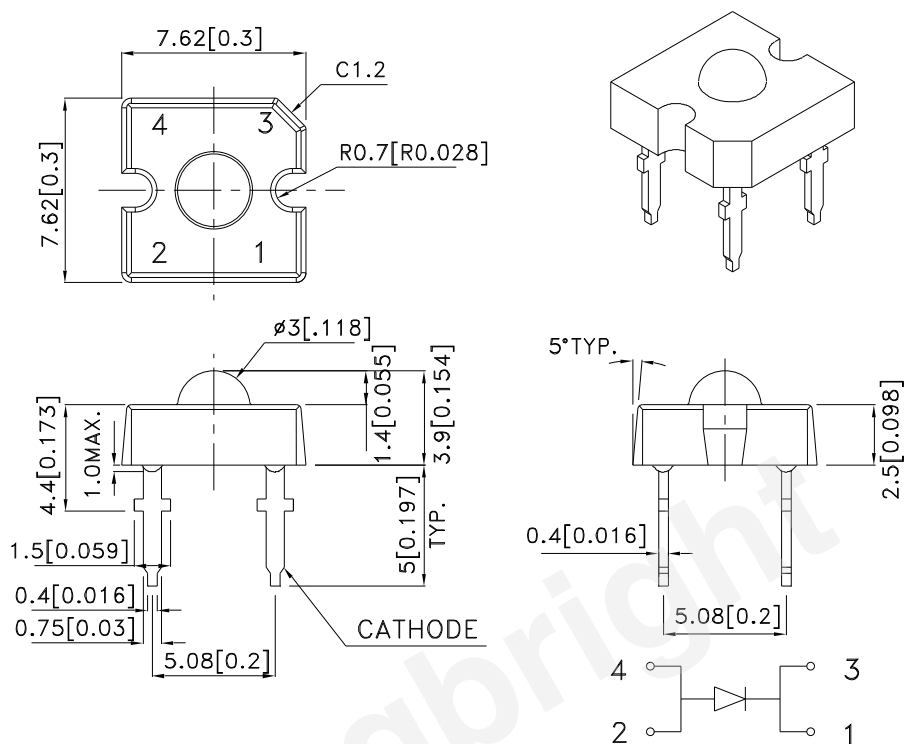

Notes:

1. All dimensions are in millimeters (inches).
2. Tolerance is $\pm 0.25(0.01")$ unless otherwise noted.
3. Lead spacing is measured where the leads emerge from the package.
4. The specifications, characteristics and technical data described in the datasheet are subject to change without prior notice.

Absolute Maximum Ratings at $T_A=25^\circ\text{C}$

PARAMETER	SUR-G	UNITS
DC Forward Current	70	mA
Power dissipation	182	mW
Reverse Voltage	5	V
Operating Temperature	-40 To +85	$^\circ\text{C}$
Storage Temperature	-55 To +85	$^\circ\text{C}$
Lead Solder Temperature[1]	260 $^\circ\text{C}$ For 5 Seconds	

1. 1.5mm[0.06inch]below seating plane.
NO Reflow soldering .

Selection Guide

Part No.	LED COLOR	Iv(cd)[1] @70mA		Φv(lm)[1] @70mA	Viewing Angle[2] 2θ1/2
		Min.	Typ.	Typ.	Typ.
L-7679C1SURC-G	Hyper Red (AlGaInP)	2.3	3.2	*1.2	70°
		*0.5	*1		

Notes:

1.Luminous intensity is measured with an integrating sphere after the device has stabilized; Luminous Intensity / luminous flux: +/-15%.

2.θ1/2 is the angle from optical centerline where the luminous intensity is 1/2 of the optical peak value.

*Luminous Intensity / luminous flux value is traceable to the CIE127-2007 compliant national standards.

Optical Characteristics at TA=25°C If=70mA Rθj-a=200°C/W

DEVICE TYPE	PEAK WAVELENGTH λPEAK (nm) TYP.	DOMINANT[1] WAVELENGTH λDOM (nm) TYP.	SPECTRAL LINE WAVELENGTH Δλ1/2(nm) TYP.
SUR-G	645	630	22

Note:

1.The dominant wavelength is derived from the CIE Chromaticity Diagram and represents the perceived color of the device; Wavelength: +/-1nm.

2.Wavelength value is traceable to the CIE127-2007 compliant national standards.

Electrical Characteristics at TA=25°C

DEVICE TYPE	FORWARD VOLTAGE [1] VF (VOLTS) @ If=70mA			REVERSE CURRENT IR (uA) @ VR=5V	CAPACITANCE C (pF) @ VF=0V F=1MHZ	THERMAL RESISTANCE Rθj -pin °C/W
	MIN.	TYP.	MAX.	MAX.	TYP.	TYP.
SUR-G	2.1	2.3	2.6	10	45	125

Note:

1. Forward Voltage: +/-0.1V.

Figures

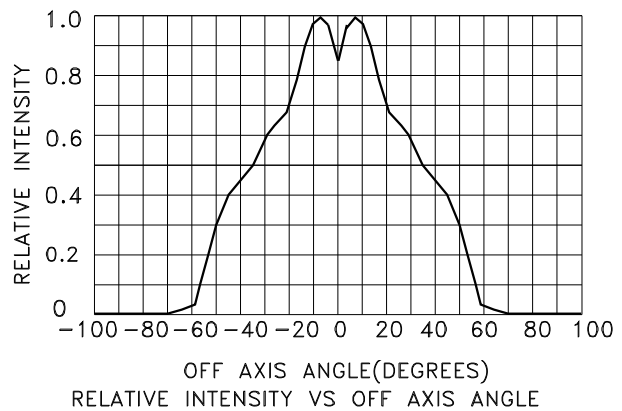
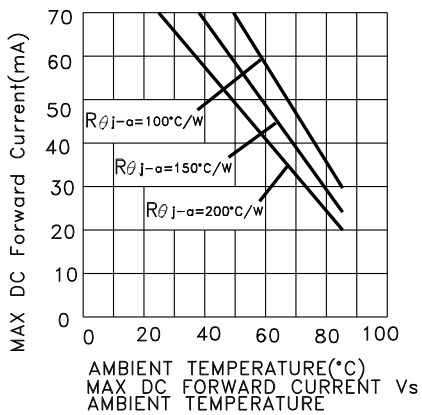
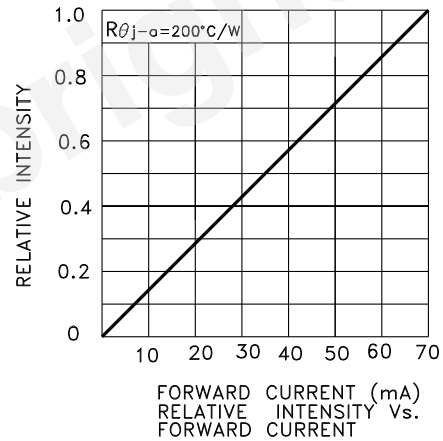
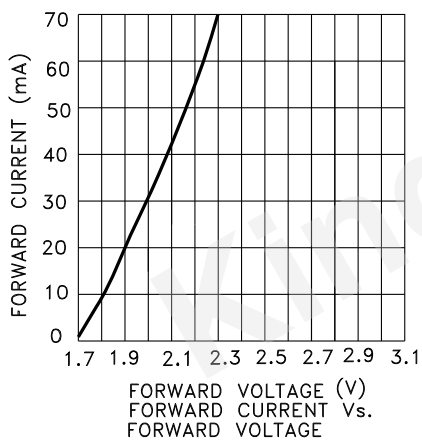
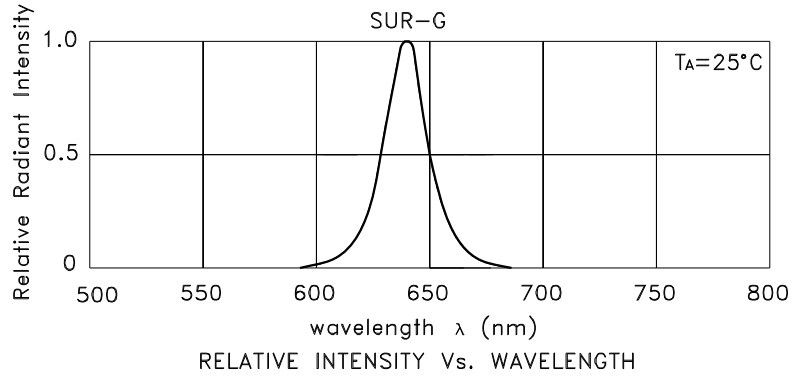

PACKING & LABEL SPECIFICATIONS

L-7679C1SURC-G

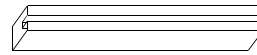
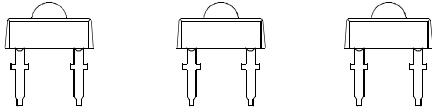

75PCS / IC TUBE(520x8.3x15mm)

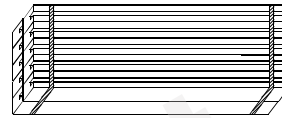

750pcs / 10pcs IC TUBE



OUTSIDE LABEL



7.5K / 6# BOX

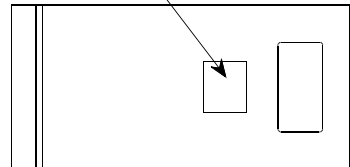

LABEL

10pcs IC TUBE / BAG

Kingbright	
P/NO: L-7679C1xxx	
QTY: 750 pcs	Q.C. Q C XX XX XXXX PASSED
S/N: XXXX	
CODE: XXX	
LOT NO:	
 XXXXXXXXXXXX	
RoHS Compliant	

PRECAUTIONS

1. The lead pitch of the LED must match the pitch of the mounting holes on the PCB during component placement. Lead-forming may be required to insure the lead pitch matches the hole pitch. Refer to the figure below for proper lead forming procedures. (Fig. 1)

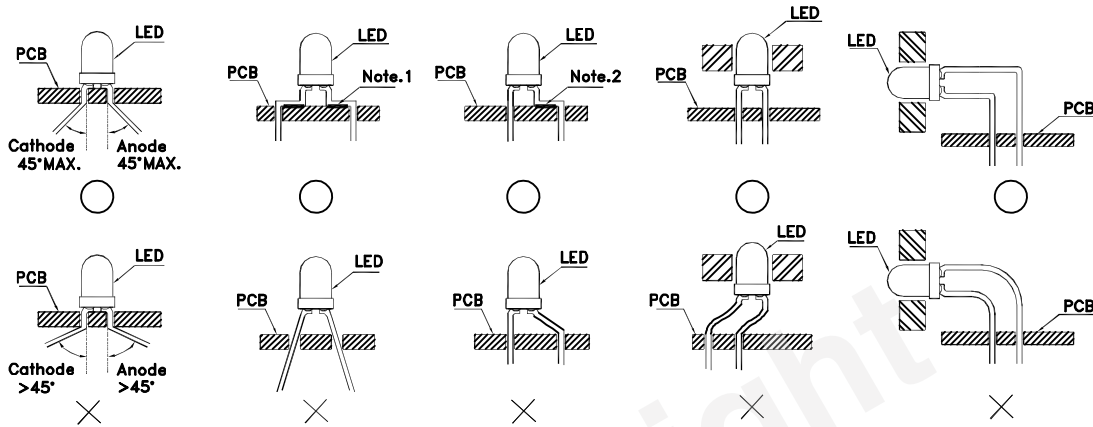

Fig.1

”○” Correct mounting method ”×” Incorrect mounting method

2. When soldering wire to the LED, use individual heat-shrink tubing to insulate the exposed leads to prevent accidental contact short-circuit. (Fig.2)

3. Use stand-offs (Fig.3) or spacers (Fig.4) to securely position the LED above the PCB.

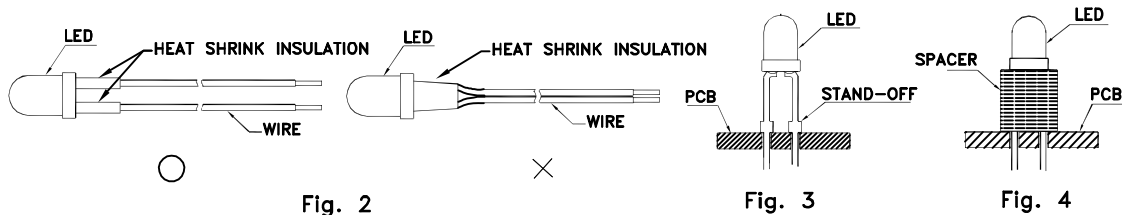

Fig. 2

Fig. 3

Fig. 4

4. Maintain a minimum of 2mm clearance between the base of the LED lens and the first lead bend. (Fig. 5 and 6)
5. During lead forming, use tools or jigs to hold the leads securely so that the bending force will not be transmitted to the LED lens and its internal structures. Do not perform lead forming once the component has been mounted onto the PCB. (Fig. 7)

6. Do not bend the leads more than twice. (Fig. 8)

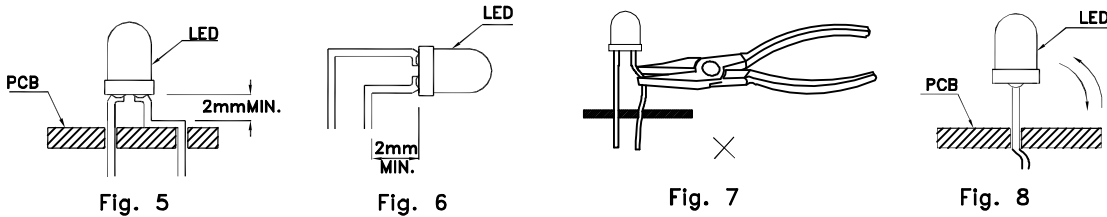

7. During soldering, component covers and holders should leave clearance to avoid placing damaging stress on the LED during soldering.

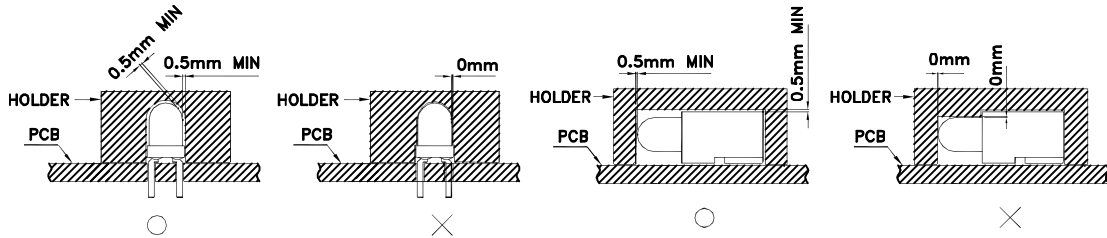

- 8. The tip of the soldering iron should never touch the lens epoxy.
- 9. Through-hole LEDs are incompatible with reflow soldering.
- 10. If the LED will undergo multiple soldering passes or face other processes where the part may be subjected to intense heat, please check with Kingbright for compatibility.
- 11. Recommended Wave Soldering Profiles:

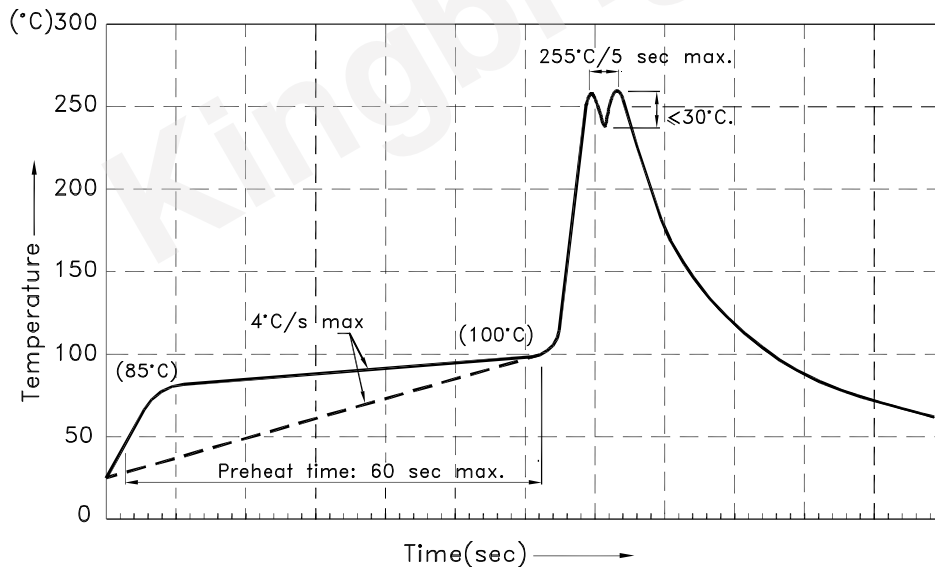

Notes:

- 1. Recommend pre-heat temperature of 105°C or less (as measured with a thermocouple attached to the LED pins) prior to immersion in the solder wave with a maximum solder bath temperature of 260°C
- 2. Peak wave soldering temperature between 245°C ~ 255°C for 3 sec (5 sec max).
- 3. Do not apply stress to the epoxy resin while the temperature is above 85°C.
- 4. Fixtures should not incur stress on the component when mounting and during soldering process.
- 5. SAC 305 solder alloy is recommended.
- 6. No more than one wave soldering pass.

Detailed application notes are listed on our website.
http://www.kingbright.com/application_notes

X-ON Electronics

Largest Supplier of Electrical and Electronic Components

Click to view similar products for [Standard LEDs - Through Hole category](#):

Click to view products by [Kingbright manufacturer](#):

Other Similar products are found below :

[LTL-10254W](#) [LTL-1214A](#) [LTL-1BEDJ](#) [LTL-2231AT](#) [LTL-3251A](#) [LTL-4262N](#) [LTL-5234](#) [LTL87HTBK](#) [LTL-87HD4B](#) [7383/V7C3-BSTA-L/PR3/MS](#) [HLMP-AG64-X10ZZ](#) [HLMP-EG1A-Z10DV](#) [HLMP-EL3B-WXKDD](#) [HLMP-HB74-UVBDD](#) [HLMP-HG65-VY0DD](#) [HLMP-HM74-34CDD](#) [HLMP-HM75-34CDD](#) [1L0532V23G0TD001](#) [NSPW500CS](#) [C4SMA-BGF-CQ34Q3C2](#) [L53GC13](#) [264-7SURTS530-A3](#) [L-C150JRCT](#) [S4SMS-BJF-CQ42QGF2](#) [S4SMS-GJF-CW12QMF2](#) [LD CQDP-1U3U-W5-1-K](#) [LO566UHR3-70G-A3](#) [SLA560WBD2PT3](#) [LP379PPG1C0G0300001](#) [SLR-322MCT32](#) [SLR-342DUT32](#) [SLR-342MC3F](#) [SLR343BC7TT32](#) [SLR343BCTT32](#) [SLX-LX3044GD](#) [SLX-LX3044ID](#) [SLX-LX3044YD](#) [1.90690.3330000](#) [SSL-LX20483ID](#) [SSL-LX3034YD](#) [SSL-LX5093LGT-11](#) [SSL-LX5093PGC](#) [SSL-LX5093SRC/F](#) [SSL-LX5093SYT](#) [SSL-LX509E3SIT](#) [SSL-LX509FT3ID](#) [SSL-LX50FT3GD](#) [SSS-LX4673ID-410B](#) [1L0532Y24I0TD001](#) [264-7SYGD/S530-E2](#)