

HD

D-Sub connectors - Stamped and Formed Contacts

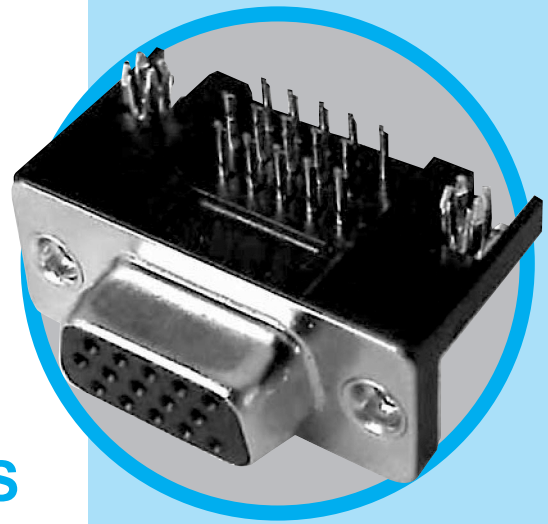

RIGHT ANGLE HIGH DENSITY CONNECTORS

MAIN CHARACTERISTICS

Specifications

- Connectors according to: MIL C24308

Materials and Platings	
Shells	Steel with nickel plating
Body	Glass filled thermoplastic, UL 94V-0
Contacts	Copper alloy, selective gold plating
Rear insert	Brass with nickel plating
Screwlock	Brass with nickel plating
Grounding clip	Copper alloy with tin plating

Electrical Data	
Current rating	5A
Voltage rating	600V AC/rms 50Hz
Withstanding voltage	1000V AC/rms 50HZ for one minute
Insulation resistance	5000MΩ
Contact resistance	10mΩ Max.

Climatic Data	
Operating temperature	-55°C to +125°C

Mechanical Data		
Mating and unmating force		
Unit: kg (lb)		
No. of Cts	Mate (max)	Unmate (min)
15	3.81 (8.42)	0.52 (1.14)
26	5.95 (13.16)	1.05 (2.32)
44	9.26 (20.46)	1.37 (3.02)
62	13.48 (29.78)	1.76 (3.88)
Standard plating thickness		
<ul style="list-style-type: none"> • gold flash • 0.4µm (15µ") gold • 0.76µm (30µ") gold 		

DESCRIPTION

Amphenol's high density D-Sub connectors complement Amphenol's extensive D-Sub connector line. This line offers many superior features, high performance level and low installation cost.

The decreased contact spacing accommodates greater signal density in comparison to conventional D-Sub connectors.

*Economical
right angle PCB*

APPLICATIONS

- Industrial
- Telecom
- Any industry standard I/O connections



Amphenol

HD / E19

P.C.B. Layout



15 PIN

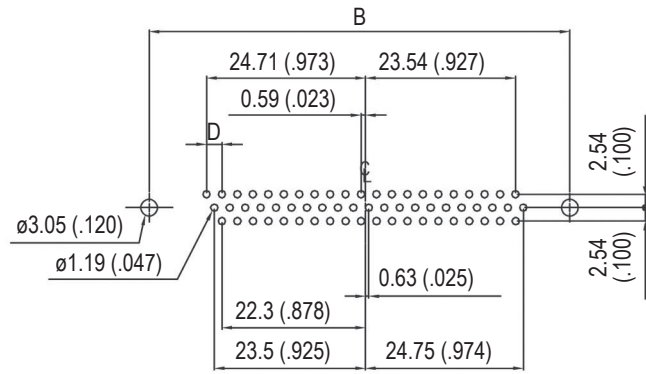

62 PIN

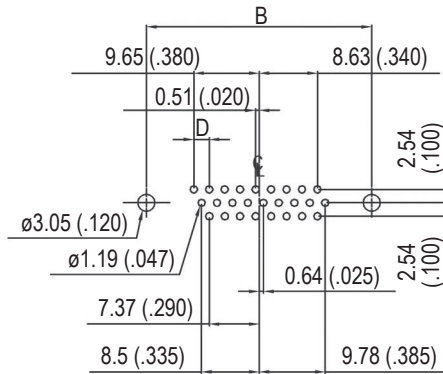

26 PIN

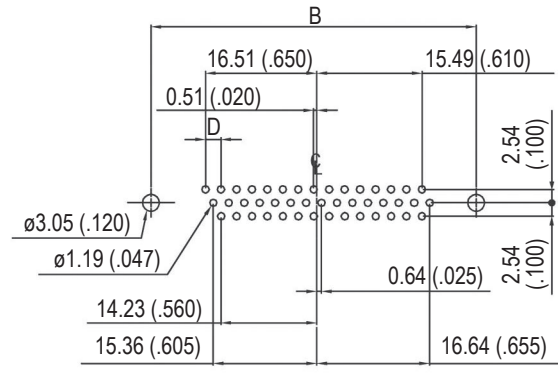

44 PIN

Panel mounting option

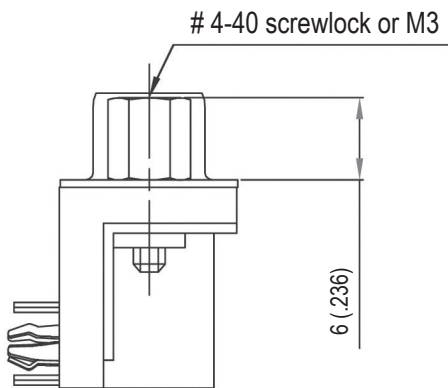

Front female screwlock
4F / 3F



Threaded rear insert
4R / 3R

Shell size dimensions

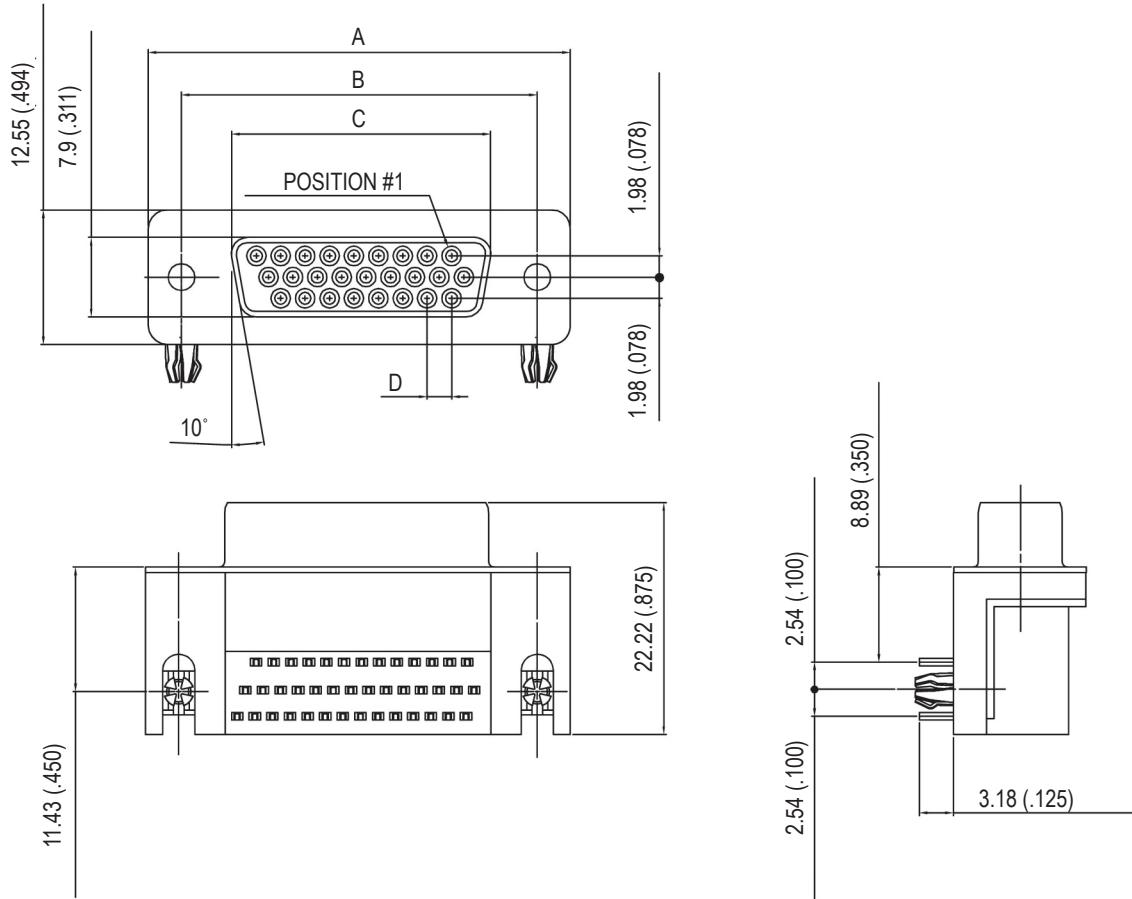

NB OF CONTACTS	DIMENSIONS mm (inch)			
	A	B	C	D
15	30.84 (1.214)	24.99 (.984)	16.26 (.640)	2.29 (.090)
26	39.24 (1.545)	33.32 (1.312)	24.56 (.967)	2.29 (.090)
44	53.04 (2.088)	47.04 (1.852)	38.30 (1.508)	2.29 (.090)
62	69.34 (2.730)	63.50 (2.500)	54.76 (2.156)	2.41 (.095)

How to order

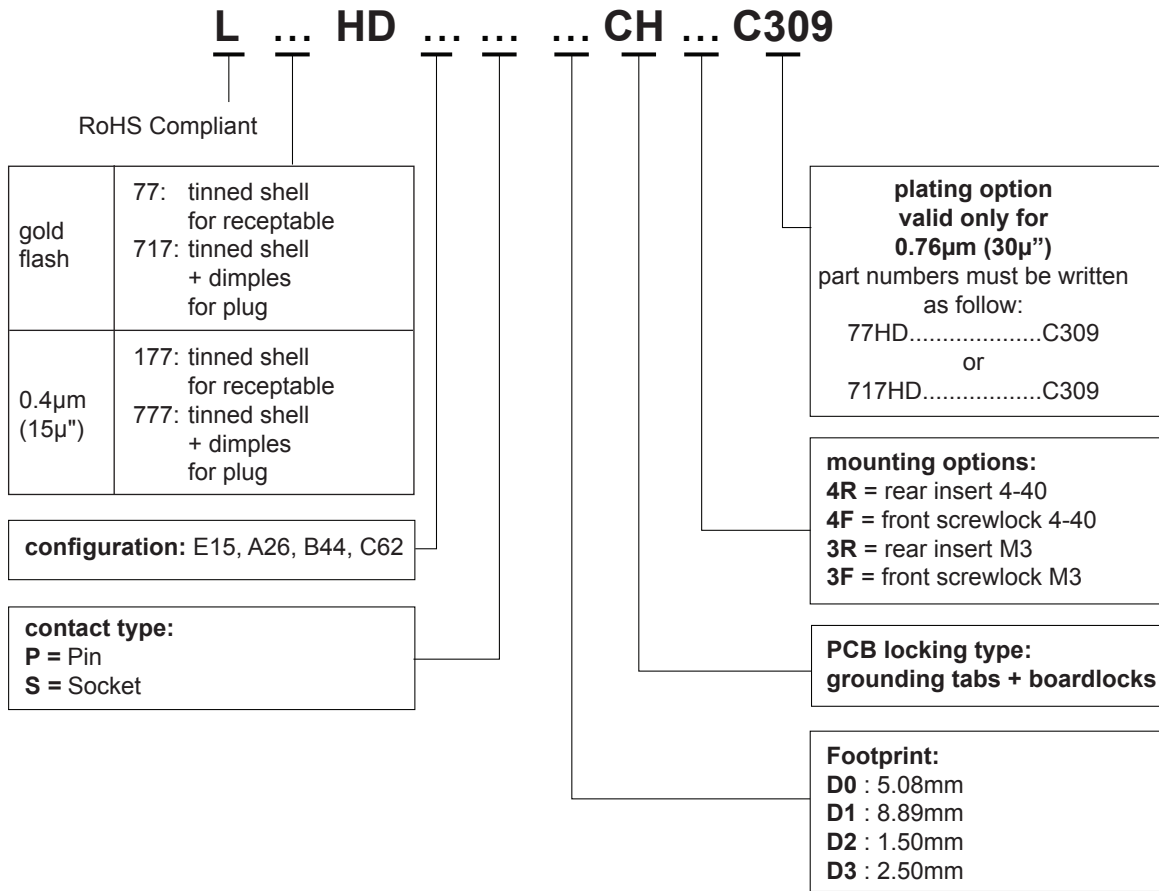

For special request, please consult factory

Do not hesitate to contact us for further information

Amphenol

Amphenol IT & Communication Products

Block A3/A4, The 4th Industrial District of
Industrial Headquarters, Dong Keng Road
Gong Ming Town, Shen Zhen China
Fax: +86(0)755 2754 9955

Technical Support

Tel: +86(0)755 2717 7945
Info-dsub@amphenol.com.cn
<http://www.dsubconnector.com>

X-ON Electronics

Largest Supplier of Electrical and Electronic Components

Click to view similar products for [D-Sub High Density Connectors](#) category:

Click to view products by [Amphenol](#) manufacturer:

Other Similar products are found below :

[1484349-1](#) [163A16769X](#) [163A16809X](#) [163A17089X](#) [164A17199X](#) [164A17209X](#) [164A17479X](#) [164A18209X](#) [17BH-044S-AA110](#) [K86X-AD-26S](#) [KF66X-A26P-NJ](#) [KF66X-E15P-N](#) [241A17320X](#) [242A18390X](#) [242A25740X](#) [L717HDB44POL2R210](#) [L717HDCH62POL2RM5](#) [L717HDEH15POL2](#) [L777HDE15P](#) [L77HDC62S](#) [L77HDE15SC309](#) [163A16779X](#) [163A16839X](#) [163A17049X](#) [163A17079X](#) [164A17309X](#) [164A17329X](#) [164A18219X](#) [241A16440X](#) [241A16550X](#) [241A16680X](#) [241A17390X](#) [241A20810X](#) [241A25740X](#) [CT25-44P](#) [K66X-E15S-N30](#) [K86X-BA-44S](#) [K86X-ED-15S-BR15](#) [K86X-ED-15SK](#) [L177HDE15SOL2RM23](#) [L177HRC62S](#) [L177HRC62SVFM](#) [L177HRCG62S](#) [L717HDBH44POL2RM5](#) [L717HDEG15POL2RM5](#) [L77HDA26SVF](#) [L77HDE15SD1CO](#) [L77HDEH15SOL2RM832](#) [DAMA-15S-WS](#)
[443895-3](#)