

Isolators 69 Series



- 3 and 4 pole
- On load 20A - 100A
- Red/yellow or black handles
- 3 padlock positions
- IP65
- Enclosed, DIN rail, base or panel mount versions
- Lightweight ext shafts 100-400mm
- Side mounted auxiliary contacts
- UL approval



Options and ordering codes

PM69		-	30	20	RY64
IP65 enclosed	PE69		3 pole	30	RY48 Direct red/yellow 48mm handle
Base mount door interlock	LB69		4 pole	40	RY64 Direct red/yellow 64mm handle
Front panel mount	PM69		6 pole	60	B48 Direct black 48mm handle
Direct handle base mounted	DM69		8 pole	80	B64 Direct black 64mm handle
					Enclosed/door interlocked vertical
				Rating @ 400V AC21/Amps AC23/kW	
				20	5.5
				25	7.5
				32	11
				40	15
				63	18.5
				80	22
				100	37

Accessories

Description	Part ref
Red/yellow handle 64 x 64mm	H69-0001
Black handle 64 x 64mm	H69-0002
Red/yellow handle 48 x 48mm	H69-0003
Black handle 48 x 48mm	H69-0004
Door handle mounting tool	J7049
Extension shaft – 100mm	E69-0001
Extension shaft – 200mm	E69-0002
Extension shaft – 300mm	E69-0003
Extension shaft – 400mm	E69-0004
Auxiliary contacts 1 n/o + 1 n/c	A69-0001
Auxiliary contacts 2 n/o	A69-0002
Solid neutral block	SN69-0001
Add on neutral switching pole 20-40A	SP69-0001
Auxiliary contacts 1 n/o + 1 n/c	A69-0001
Auxiliary contacts 2 n/o only	A69-0002



Technical Data

Data according to IEC 947-3, IEC 947-5-1, VDE 0660, EN 60947-3, EN 60947-5-1

Type	..69..20	..69..25	..69..32	..69..40	..69..63	..69..80	..69..100	
Main contacts								
Rated thermal current I_{th} open	A	20	25	32	40	63	80	100
Rated thermal current I_{th} enclosed	A	20	25	32	40	63	80	100
Rated insulation voltage U_i 1)	V	690	690	690	690	690	690	1000 ⁵⁾
Rated operational current I_e AC21A	A	20	25	32	40	63	80	100
Making capacity I_{eff} 3x220-440V	A	160	190	220	300	370	440	725
Breaking capacity 3x380-440V 3x660-690V	A	160	180	200	250	330	380	580
	A	160	180	200	250	330	380	580
	A	80	110	140	170	190	220	330
Disconnection property performed up to	V	690	690	690	690	690	690	1000
Motor Switch AC3 3x400V	A	12	16	23	30	37	37	60
Motor Switch AC3 3x220-240V	kW	3	4	5,5	7,5	11	11	18,5
Direct switching of single motors 3x380-440V 3x660-690V	kW	5,5	7,5	11	15	18,5	18,5	30
	kW	5,5	7,5	11	15	18,5	18,5	22
	kW	5,5	7,5	11	15	18,5	18,5	22
Main Switch AC23 3x400V	A	16	20	25	32	45	45	72
Motor Switch, AC23A 3x220-240V	kW	4	5,5	7,5	9	15	15	22
Main Switch, AC23B 3x380-440V	kW	7,5	10	12,5	16	22	22	37
Safety Switch 3x660-690V	kW	5,5	7,5	11	15	18,5	18,5	30
Rated conditional short-circuit current	kA _{eff}	10	10	10	10	10	10	10
Max. fuse size gL (gG)	A	25	35	40	50	63	80	100
Mechanical life	x10 ³	200	200	200	200	100	100	100
Rated short-time withstand current (1 sec. current)	A	250	300	400	500	600	850	1200
Maximum ambient temperature								
Operation	Open							-40°C to +60°C
	enclosed							-40°C to +40°C
	storage							-50°C to +90°C
Cable cross sections								
solid or standard	mm ²	0,5 - 10			1 - 25		4 - 50	
	AWG	20 - 8 (10)			16 - 4 (10)		10 - 0 (10)	
flexible	mm ²	0,5 - 6			4 - 16		10 - 35	
	AWG	20 - 10			16 - 6		8 - 2	
flexible (+ multicore cable end)	mm ²	0,5 - 6			0,75 - 16		6 - 35	
	AWG	20 - 10			16 - 6		8 - 2	
Size of terminal screw		M3,5			M5		M6	
Tightening torque	Nm	0,8 - 1,7			2 - 4		3,5 - 4,5	
Auxiliary contacts								
Rated insulation voltage U_i 1)	V	690			690		690	
Rated thermal current I_{th} , I_{the}	A	10			10		10	
Switching capacity AC15 220-240V	A	2,5			2,5		2,5	
	A	1,5			1,5		1,5	
Rated conditional short-circuit current	kA _{eff}	3			3		3	
	A	10			10		10	
Max. short circuit protection gL (gG)								
Cable cross sections								
Solid or standard	mm ²	0,75 - 2,5			0,75 - 2,5		0,75 - 2,5	
	AWG	14 - 12			14 - 12		14 - 12	
flexible (+ multicore cable end)	mm ²	0,75 - 2,5 (1,5)			0,75 - 2,5 (1,5)		0,75 - 2,5 (1,5)	
	AWG	18 - 14			18 - 14		18 - 14	

Data according to UL and cUL

Type	..69..20	..69..25	..69..32	..69..40	..69..63	..69..80	..69..100	
Rated voltage	V	600	600	600	600	600	600	
Ampere-Rating "General use"	A	20	25	32	40	63	80	100
DOL-Rating 3-phase 110-120V	HP	1	1,5	2	2	3	5	10
	HP	3	5	5	5	10	10	25
	HP	7,5	10	10	10	20	20	50
	HP	10	10	15	15	25	25	60
DOL-Rating 1-Phase 110-120V	HP	1	1	1	1	2	2	5
	HP	1	2	2	2	3	3	10
	HP	2	2	3	3	5	5	15
Fuse size (RK5) Manual Motor Controller 5kA / 600V	A	40	50	50	70	90	110	125
	A	40	50	50	50	70	70	125
Tightening torque Motor Disconnect	Nm	1,2 - 2,3	1,2 - 2,3	1,2 - 2,3	1,2 - 2,3	2,8 - 4	2,8 - 4	1,7 - 4,5
	lb.inch	11 - 20	11 - 20	11 - 20	11 - 20	24 - 35	24 - 35	15 - 40

1) Suitable for: earthed-neutral systems, overvoltage category I to III, pollution degree 3 (standard-industry); Uimp = 6kV. Data for other conditions on request

Dimensions (mm)

Base mount door interlock LB69..

ON-OFF Switches 3-pole, 4-pole

L = X - 40±3 for LB69..20-80

L = X - 44±3 for LB69..100

6-pole
for LB69..20-40
L = X - 40±3

ON-OFF Switches 6-pole, 8-pole

L = X - 60±3

Mounting
holes

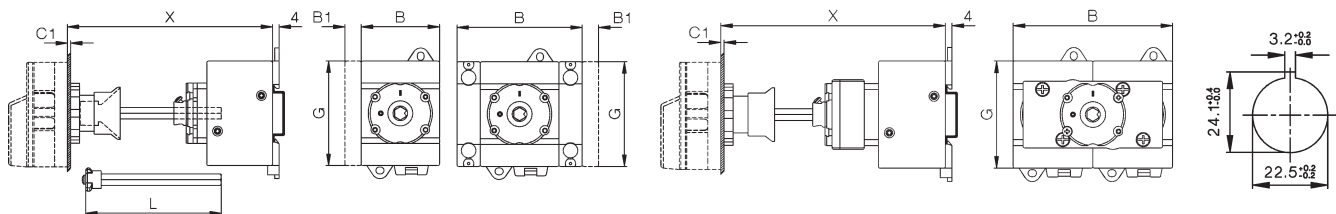

Type	3-pole		4-pole		6-pole		8-pole		aux. contact		4.Pole N		C1	D1	D2	D3	E	G	K	K1	J
	A	B	B	B	B	B	B1	B2	B1	B2											
LB69..20-40	64	48	48	77	97	10	14,5	1-5	9	5	M4	48	64	25	48	70					
LB69..63-80	64	48	62,5	97	126	10	14,5	1-5	9	5	M4	48	64	25	48	70					
LB69..100	64	78	78	-	-	10	-	1-5	9	5	ME	48	85	38	-	90					

Base mount door interlock LB69..

ON-OFF Switches LB69..20-80

3-pole, 4-pole
6-pole LB69..20-40

6-pole, 8-pole

LB69..100
3-pole, 4-pole

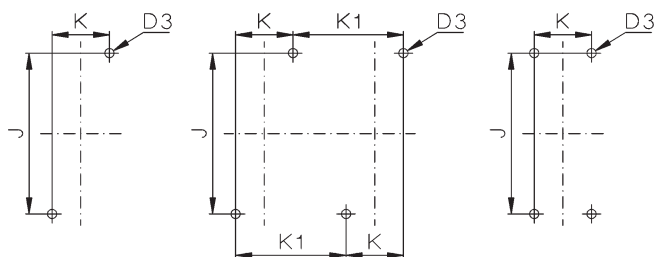

Mounting of Accessories LB69..20-80
Base mounting, for distribution boards

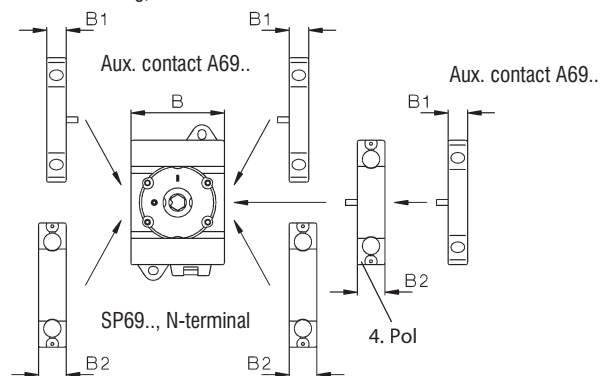

Main Switches, Switches Disconnectors DM69..

Direct handle base mount DM69..
ON-OFF Switches 3-pole, 4-pole

ON-OFF Switches 6-pole
for DM69..20-40

ON-OFF Switches 6-pole, 8-pole

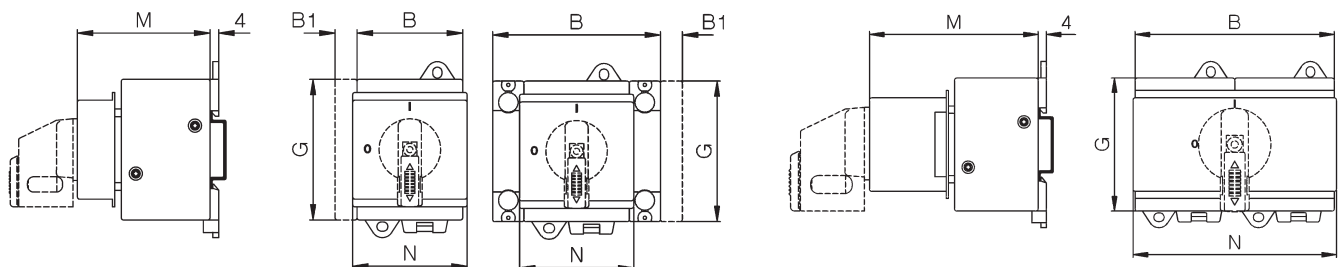

Type	padlock device	3-pole		4-pole		6-pole		8-pole		aux. contact		4.Pole N		3-pole 4-pole		6-pole		8-pole	
		B	B	B	B	B	B	B1	B2	B1	B2	M	M	M	N	N	N	N	
DM69..20-40	B48,RY48	48	48	77	96	10	14,5	64	60	60	74	52	52	97					
DM69..63-80	B48,RY48	48	62,5	96	125	10	14,5	64	60	74	74	52	97	126					
DM69..100	RY48	78	78	-	-	10	-	85	60	-	-	78	-	-					

Dimensions (mm)

IP65 Enclosed PE69

Type	Pole	A	B	C	D1	D2	E	F	H
PE69..20-40	3, 4	130	98	121	2x25,5/20,5	-	75	100	77
PE69..63-100	3, 4	200	120	-	40,5/32,5 + 16,5	-	95	165	86
PE69..20-40	6	200	120	-	40,5/32,5 + 16,5	-	95	165	86
PE69..20-40	8	240	160	-	40,5/32,5	-	130	228	120
PE69..63-80	6, 8	240	160	-	40,5/32,5	-	130	228	120

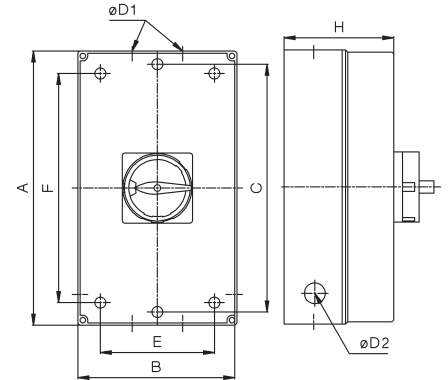

Main Switches, Switch Disconnectors PM69..

Panel mounting PM69..
ON-OFF Switches 3-pole, 4-pole

ON-OFF Switches 6-pole, 8-pole

Mounting holes

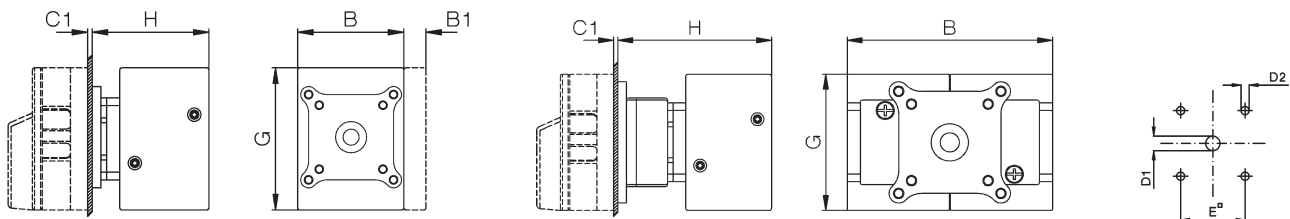

Type	ON-OFF Escutch. plate or padlock device	3-pole		4-pole	6-pole	8-pole	aux. contact	4.Pole N			D2	E	F	3-pole		6-pole	H
		A	B	B	B	B	B1	B2	C1	D1				G	H	H	
PM69..	B48, RY48	48	48	62,5	-	-	10	14,5	1-5	9	5	36	-	64	54	-	
PM69..	B64, RY64	64	48	62,5	97	126	10	14,5	1-5	9	5	48	-	64	54	74	
PM69..100	B64, RY64	64	78	78	-	-	10	14,5	1-5	9	5	48	-	85	60	-	

Handles

H69-0001 / RY64
H69-0002 / B64

H69-0003 / RY48
H69-0004 / B48

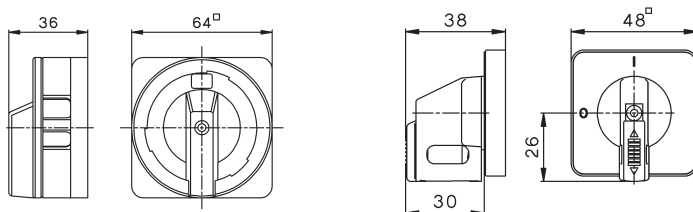

X-ON Electronics

Largest Supplier of Electrical and Electronic Components

Click to view similar products for imo manufacturer:

Other Similar products are found below :

[20.155MV/12-E](#) [MC14N-S-10110AC](#) [MB09-S-10=24](#) [DPS-1-030-24](#) [SRF-1C-SL-12VDC](#) [MB09-S-1024](#) [LDC18RRS](#) [SFSYE0111](#)
[21.1500M/6-E](#) [20.3304M/2-E](#) [21.910M/5-E](#) [20.95MA/2-E](#) [21.95MHF/2-E](#) [PE69-4032](#) [DPS-1-060-24](#) [CS20A-A2](#) [CS20A-U1](#) [VFC02](#)
[MSSTC11DA06](#) [20.95MHF/3-E](#) [B3T10](#) [XKL-040-21](#) [20.3304M/4-E](#) [SRDH-1A-SL-24VDC](#) [20.2500M/5-E](#) [21.155MH/12](#) [SRRHN-2CN-](#)
[SL-12VDC](#) [20.920M/5-E](#) [MC10N-S-10110AC](#) [21.1550MF/8-E](#) [20.910M/6-E](#) [20.95MH/3-E](#) [21.95MV/3](#) [MA05-S-01230AC](#) [SRRHN-2CN-](#)
[SL-5VDC](#) [LB69-4040](#) [20.3001M/6](#) [21.1500M/3-E](#) [SFSYE0311](#) [21.95MHF/6-E](#) [20.95MV/2-E](#) [20.155MV/4-E](#) [20.155MH/4-E](#) [20.950M/2-E](#)
[MT5 1-50-FAR](#) [BS3P3REDO](#) [MB12-S-10=24](#) [MA05-S-1024DC](#) [20.155MVF/8-E](#) [20.2500MV/8-E](#)