

Dimensions

TeSys contactors

Model d contactors
Control circuit: a.c.

2

LC1-D09...D18 (3-pole)

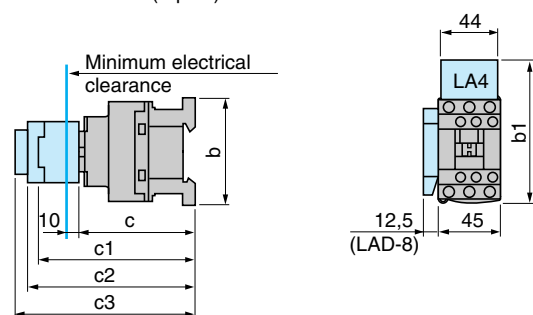

LC1-D25...D38 (3-pole)
LC1-DT20...DT60 (4-pole)

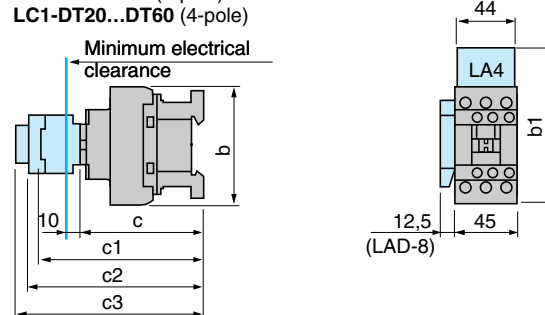

LC1-	D09... D18	D093... D183	D099... D189	D25... D38	D253 & D323	DT20 & DT25	DT203 & DT253	DT32... DT60	DT323 & DT603
b without add-on blocks	77	99	80	85	99	85	99	91	105
b1 with LAD-4BB	94	107	95.5	98	107	98	-	-	-
with LA4-D2	110 (1)	123 (1)	111.5 (1)	114 (1)	123 (1)	114	-	-	-
with LA4-DF, DT	119 (1)	132 (1)	120.5 (1)	123 (1)	132 (1)	129	-	-	-
with LA4-DR, DW, DL	126 (1)	139 (1)	127.5 (1)	130 (1)	139 (1)	190	-	-	-
c without cover or add-on blocks	84	84	84	90	90	90	90	98	98
with cover, without add-on blocks	86	86	86	92	92	92	92	100	100
c1 with LAD-N or C (2 or 4 contacts)	117	117	117	123	123	123	123	131	131
c2 with LA6-DK10, LAD-6K10	129	129	129	135	135	135	135	143	143
c3 with LAD-T, R, S	137	137	137	143	143	143	143	151	151
with LAD-T, R, S and sealing cover	141	141	141	147	147	147	147	155	155

2.3

(1) Including LAD-4BB

LC1-D40...D65 (3-pole)

LC1-D65004, D40008 and D65008 (4-pole)

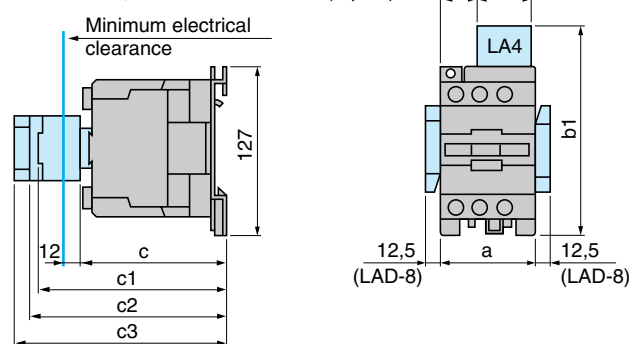

LC1-D80 and D95 (3-pole)

LC1-D80004 and D80008 (4-pole)

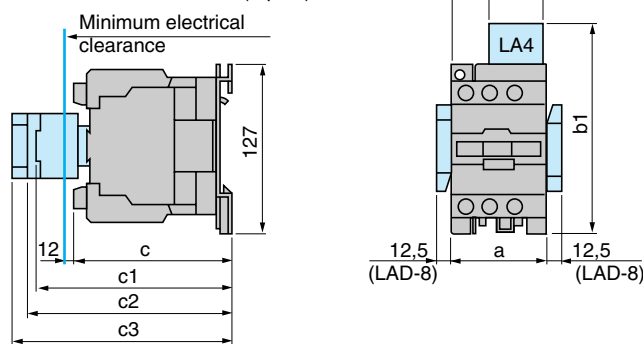

LC1-	D40...D65	D40008	D80 D65004	D95 D65008	D80004	D80008
a	75	85	85	85	96	96
b1 with LA4-D2	135	135	135	135	135	135
with LA4-DB3	-	-	135	-	-	-
with LA4-DF, DT	142	142	142	142	142	142
with LA4-DM, DR, DW, DL	150	150	150	150	150	150
c without cover or add-on blocks	114	125	125	125	125	140
with cover, without add-on blocks	119	-	130	130	-	-
c1 with LAD-N (1 contact)	139	139	150	150	150	150
with LAD-N or C (2 or 4 contacts)	147	147	158	158	158	158
c2 with LA6-DK	159	159	170	170	170	170
c3 with LAD-T, R, S	167	167	178	178	178	178
with LAD-T, R, S and sealing cover	171	171	182	182	182	182

LC1-D115 and D150 (3-pole)

LC1-D115004 (4-pole)

LC1-	D115 D150	D115004	D115006	D150006	D1150046
a	120	150	120	120	155
b1 with LA4-DA2	174	174	174	174	174
with LA4-DF, DT	185	185	185	185	185
with LA4-DM, DR, DL	188	188	188	188	188
with LA4-DW	188	188	188	-	188
c without cover or add-on blocks	132	132	115	115	115
with cover, without add-on blocks	136	-	-	-	-
c1 with LAD-N or C (2 or 4 contacts)	150	150	150	150	150
c2 with LA6-DK20	155	155	155	155	155
c3 with LAD-T, R, S	168	168	168	168	168
with LAD-T, R, S and sealing cover	172	172	172	172	172

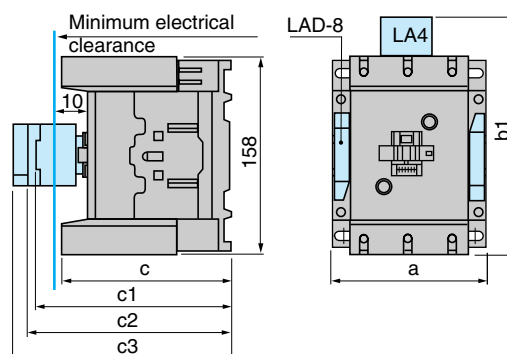

Selection:
pages 1/12 to 1/35

Characteristics:
pages 2/62 to 2/67

References:
pages 2/74 to 2/77

Schemes:
pages 2/98 and 2/99



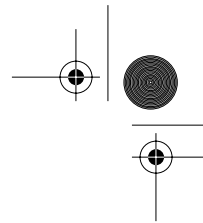

Mounting

TeSys contactors

Model d contactors

2

On mounting rail AM1-DP200, DR200 or AM1-DE200 (width 35 mm)
LC1-D09...D38, DT20...DT60

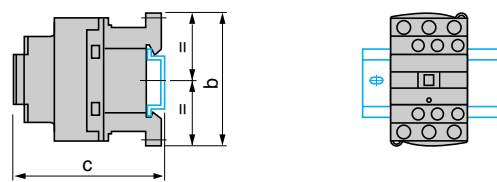

LC1-	D09...D18	D25...D38	DT20 & DT25	DT32... DT60
b	77	85	85	100
c (AM1-DP200 or DR200) (1)	88	94	94	109
c (AM1-DE200) (1)	96	102	102	117

2.3

d.c. control circuit

LC1-	D09...D18	D25...D38	DT20 & DT25	DT32... DT60
b	77	85	94	109
c (AM1-DP200 or DR200) (1)	97	103	103	118
c (AM1-DE200) (1)	105	110	111	1236

On mounting rail AM1-DL200 or DL201 (width 75 mm)
 On mounting rail AM1-ED●●● or AM1-DE200 (width 35 mm)
LC1-D40 to D95, LP1-D40 to D80

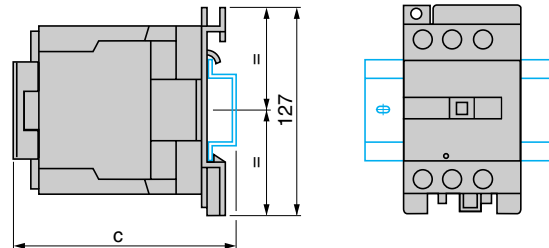

a.c. control circuit

LC1-	D40...D65	D80 & D95
c (AM1-DL200) (1)	136	147
c (AM1-DL201) (1)	126	137
c (AM1-ED●●● or DE200) (1)	126	137

d.c. control circuit

LC1-	D40...D65	D80 & D95
c (AM1-DL200) (1)	193	203
c (AM1-DL201) (1)	183	203

LP1-

LP1-	D40	D65	D80
c (AM1-DL200)	188	188	198
c (AM1-DL201)	178	178	198

(1) with safety cover
 On 2 mounting rails DZ5-MB at 120 mm centres
LC1-D115, D150

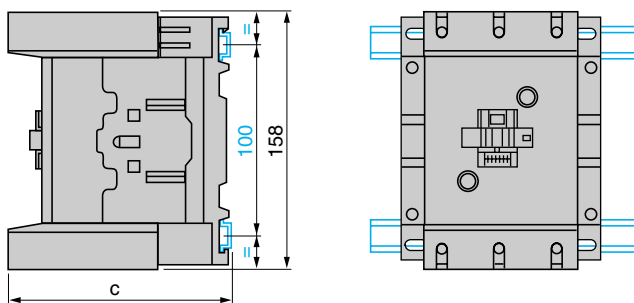

(1) with safety cover

a.c. or d.c. control circuit

LC1-	D115 & D150	D1156 & D1506
c (AM1-DP200 or DR200)	134.5	117.5
c (AM1-DE200 or ED●●●)	142.5	125.5

On 2 mounting rails DZ5-MB at 120 mm centres
LC1-D40...D95, LP1-D40...D80

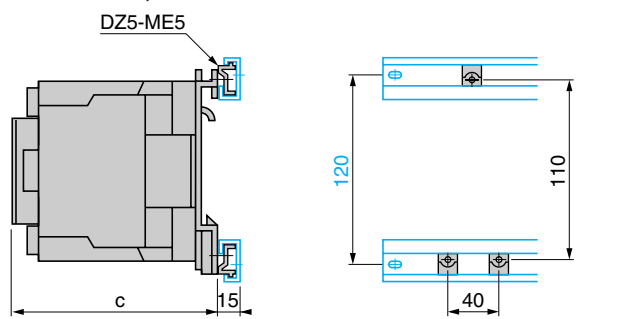

a.c. control circuit

LC1-	D40...D65	D80 & D95
c with cover	119	130

d.c. control circuit

LC1-	D40...D65	D80 & D95
c with cover	176	186
LP1-	D40 & D65	D80
c	171	181

Selection:
[pages 1/12 to 1/35](#)

Characteristics:
[pages 2/62 to 2/67](#)

References:
[pages 2/74 to 2/77](#)

Schemes:
[pages 2/98 and 2/99](#)

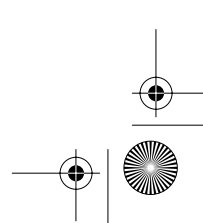

Mounting

TeSys contactors

Model d contactors

LC1-D09 to D38 and LC1-DT20...DT60 On 2 mounting rails DZ5-MB

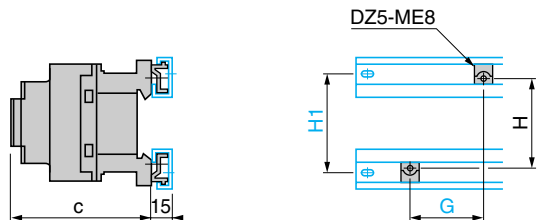

Control circuit:		a.c.		d.c.	
LC1-	D09...D18	D25...D38	D09...D18	D25...D38	D09...D18
c with cover	86	92	95	101	
G	35	35	35	35	
H	60	60	60	60	
H1	70	70	70	70	
4-pole contactors					
LC1-	DT20 & DT25	DT32 ...DT60	DT20 & DT25	DT32 ...DT60	
c	92	100	101	109	
G	135	40/50	35	35	
H	60	60	60	60	
H1	70	70	70	70	

LC1-D09...D38 and LC1-DT20...DT60 On pre-slotted mounting plate AM1-PA, PB, PC



Control circuit:		a.c.		d.c.	
LC1-	D09...D18	D25...D38	D09...D18	D25...D38	
c with cover	86	92	95	101	
G	35	35	35	35	
c with cover	86	92	95	101	
4-pole contactors					
LC1-	DT20 & DT25	DT32 ...DT60	DT20 & DT25	DT32 ...DT60	
c	80	93	118	132	
G	35	35	35	35	
H	60	60	60	60	

LC1-D40...D95, LP1-D40...D80 On pre-slotted mounting plate AM1-PA, PB, PC

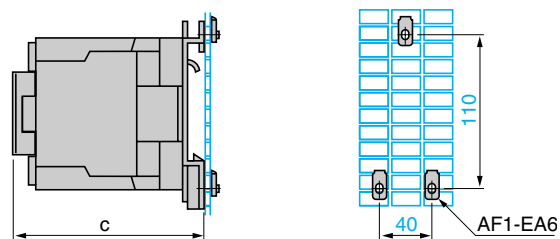

Control circuit:		a.c.		d.c.	
LC1-	D40...D65	D80 & D95	D40...D65	D80 & D95	
c with cover	119	130	176	186	
LP1-	-	-	D40 & D65	D80	
c without cover	-	-	171	181	

LC1-D09...D38 Panel mounted

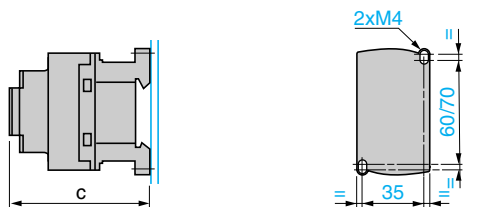

Control circuit:		a.c.		d.c.	
LC1-	D09...D18	D25...D38	D09...D18	D25...D38	
c with cover	86	92	95	101	
4-pole contactors					
LC1-	DT20 & DT25	DT32 ...DT60	DT20 & DT25	DT32 ...DT60	
c with cover	90	98	90	98	

LC1-D40...D95, LP1-D40 to D80 Panel mounted

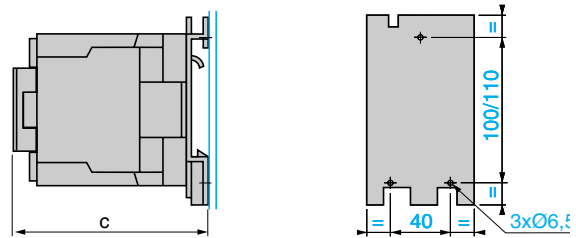

Control circuit:		a.c.		d.c.	
LC1-	D40...D65	D80 & D95	D4...D65	D80 & D95	
c with cover	119	130	176	186	
LP1-	-	-	D40 & D65	D80	
c without cover	-	-	171	181	

LC1-D115, D150 Panel mounted

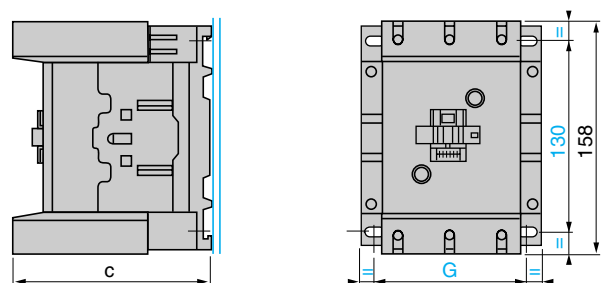

LC1-	D115	D1156	D150	D1506
c	132	115	132	115
G (3-pole)	96/110	96/110	96/110	96/110
G (4-pole)	130/144	130/144	-	-

Selection:
pages 1/12 to 1/35

Characteristics:
pages 2/62 to 2/67

References:
pages 2/74 to 2/77

Schemes:
pages 2/98 and 2/99

2

2.3

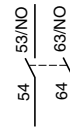
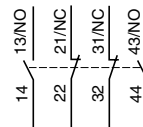
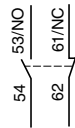
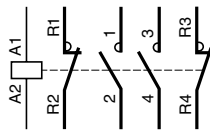
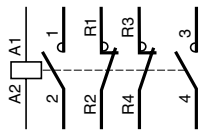
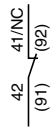
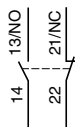
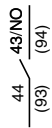
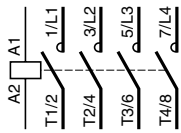
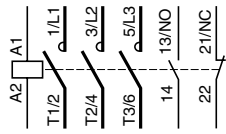

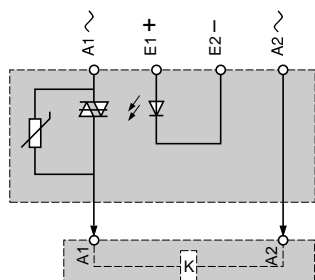
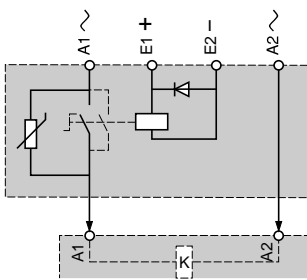
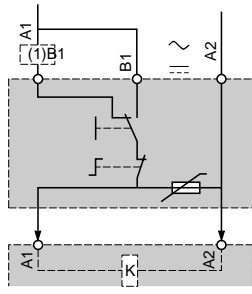
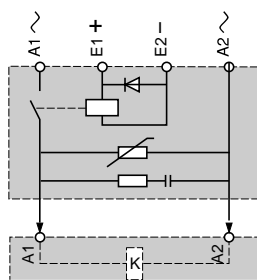
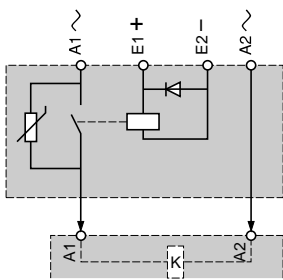
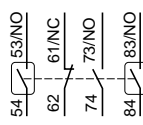
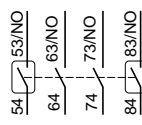
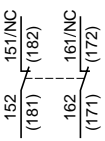
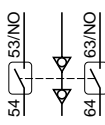
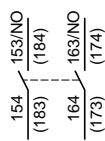
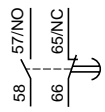
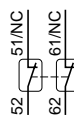
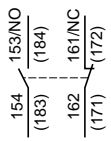
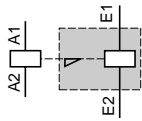
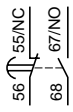
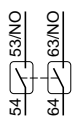

2

2.3

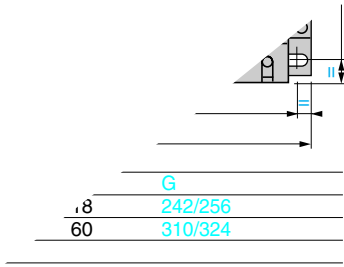
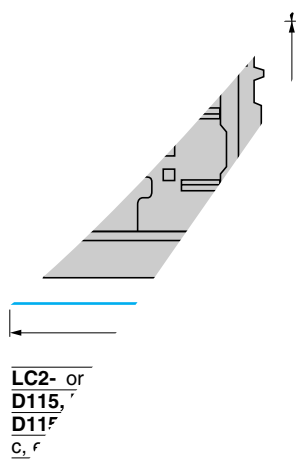

67 **References:** pages 2/74 to 2/83 **Schemes:** page 2/101

Telemecanique

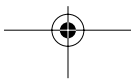
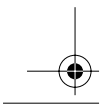

Schemes

TeSys contactors
Model d reversing contactors

Reversing contactors for motor control, horizontally mounted
LC2-D09...D150

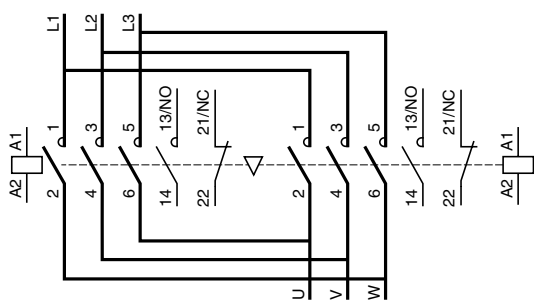

Reversing contactors for motor control with integral electrical interlocking (LAD-9R1V)

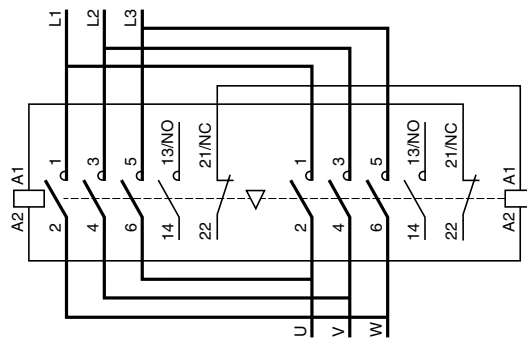

Changeover contactor pairs, horizontally mounted
LC2-DT20...DT60

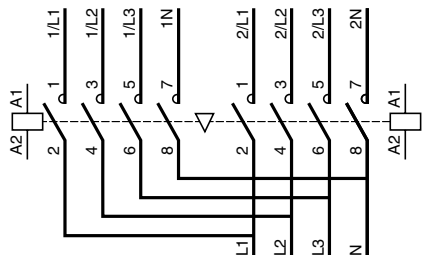

Electrical interlocking of reversing contactors fitted with:
mechanical interlock with integral electrical contacts
LA9-D...02

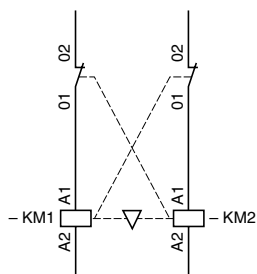
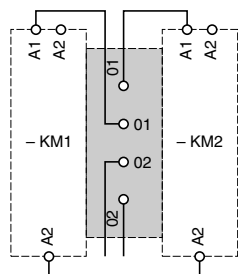

mechanical interlock without integral electrical contacts
LA9-D...78, LAD-9R1

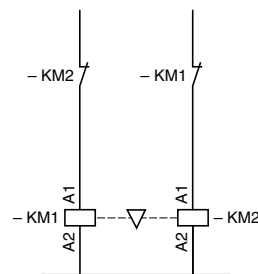

Low speed - High speed cabling kit

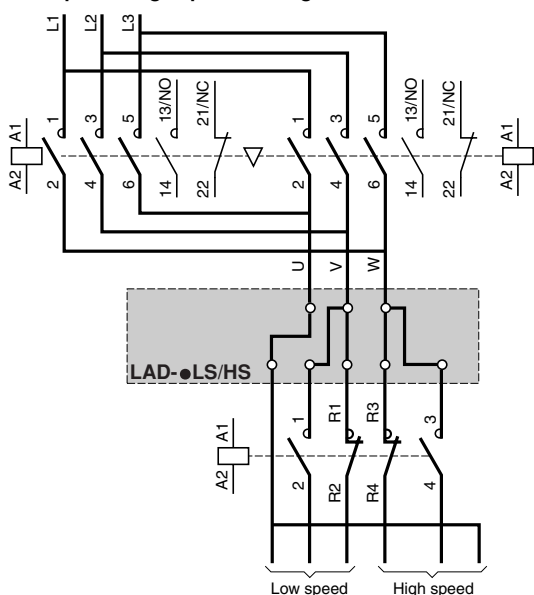

Selection:
pages 1/12 to 1/35

Characteristics:
pages 2/62 to 3/67

References:
pages 2/74 to 2/83

Dimensions:
page 2/100

2

2.3

X-ON Electronics

Authorized Distributor

Click to view similar products for [Solid State Relays - Industrial Mount](#) category.

Click to view products by [Schneider](#) manufacturer.

Other Similar products are found below :

[D1D12K](#) [G3F203SLNDC24](#) [G3J205BLAC100240](#) [LVD75A100](#) [G3PE545B3HDC1224](#) [SLR1610A](#) [SSM1A120BD](#)

[G3JT217BLCAC100240](#) [G3NA250BUTUDC524](#) [G3J211BLDC1224](#) [G3PA210BLVDDC524](#) [2297387](#) [84140000](#)

[G3RVD03SLDC48](#) [SSP1A150M7](#) [HDC60D160H](#) [G3NA450B2DC524](#) [SSM2A16BDR](#) [SSM2A16BD](#) [SSM1A312P7R](#)

[SSM1A312F7R](#) [SSM1A312F7](#) [SSM1A112F7R](#) [SSM1A112B7R](#) [G3NE205TUSDC5](#)