

Cree® XLamp® XHP70 LEDs

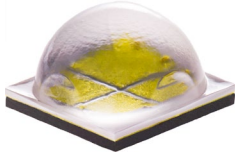

PRODUCT DESCRIPTION

Powered by Cree’s groundbreaking SC5 Technology™ Platform, the XLamp XHP70 LED is a member of Cree’s Extreme High Power (XHP) class of LEDs that redefines lumen density and reliability to radically reduce system costs by up to 40 percent. At its maximum current, the XHP70 LED delivers twice the light output of the XLamp MK-R LED, with similar lumens per watt and without increasing the package footprint. The XHP70 LED also achieves longer lifetime at higher operating temperatures than previous LED technology. The result is significantly lower thermal, mechanical and optical costs at the system level.

FEATURES

- Available in white, configurable to 6 V or 12 V by PCB layout
- Available in 5-step EasyWhite® bins at 3000 K to 5000 K CCT, 3-step EasyWhite bins at 2700 K to 5000 K and 2-step EasyWhite bins at 2700 K to 4000 K CCT
- Available in ANSI white bins at 3000 K to 7000 K CCT
- Available in standard, 70-, 80-, and 90-minimum CRI options
- Binned at 85 °C
- Maximum drive current: 4800 mA (6 V), 2400 mA (12 V)
- Low thermal resistance: 0.9 °C/W
- Wide viewing angle: 120°
- Unlimited floor life at ≤ 30 °C/85% RH
- Reflow solderable - JEDEC J-STD-020C
- RoHS and REACH compliant
- UL® recognized component (E349212)

TABLE OF CONTENTS

Characteristics	2
Flux Characteristics, EasyWhite® Order Codes and Bins	3
Flux Characteristics, ANSI White Order Codes and Bins	6
Relative Spectral Power Distribution	9
Relative Flux vs. Junction Temperature.....	9
Electrical Characteristics.....	10
Relative Flux vs. Current	11
Relative Chromaticity vs Current.....	12
Relative Chromaticity vs Temperature.....	13
Typical Spatial Distribution.....	13
Thermal Design	14
Performance Groups – Luminous Flux.....	15
Performance Groups – Chromaticity.....	15
Cree’s Standard White Chromaticity Regions Plotted on the CIE 1931 Curve....	19
Cree’s Standard Cool White Kits Plotted on ANSI Standard Chromaticity Regions..	22
Cree’s Standard Warm and Neutral White Kits Plotted on ANSI Standard Chromaticity Regions	23
Bin and Order-Code Format.....	24
Reflow Soldering Characteristics.....	25
Notes	26
Mechanical Dimensions	28
Electrical Configuration	30
Tape and Reel.....	30
Packaging.....	31



CHARACTERISTICS

XHP70 LEDs are tested and binned in the 12-V configuration. See the Mechanical Dimensions section on page 23 for pad layout options.

Characteristics	Unit	Minimum	Typical	Maximum
Thermal resistance, junction to solder point	°C/W		0.9	
Viewing angle (FWHM)	degrees		120	
Temperature coefficient of voltage (6 V)*	mV/°C		-4.25	
Temperature coefficient of voltage (12 V)	mV/°C		-8.5	
ESD withstand voltage (HBM per Mil-Std-883D)	V			8000
DC forward current (6 V)*	mA			4800
DC forward current (12 V)	mA			2400
Reverse voltage	V			-5
Forward voltage (6 V, @ 2100 mA, 85 °C)*	V		5.8	6.2
Forward voltage (12 V, @ 1050 mA, 85 °C)	V		11.6	12.4
LED junction temperature	°C			150

Note:

* Data for the 6-V configuration is calculated and for reference only.

FLUX CHARACTERISTICS, EASYWHITE® ORDER CODES AND BINS

The following table provides order codes for XLamp XHP70 LEDs. For a complete description of how the flux and chromaticity groups are reflected in the bin code and order code nomenclature, please see the Bin and Order Code Formats section (page 24).

Binning condition: $T_j = 85\text{ °C}$; 12 V, $I_F = 1050\text{ mA}$

Reference condition: $T_j = 85\text{ °C}$; 6 V, $I_F = 2100\text{ mA}$

Nominal CCT	CRI		Minimum Luminous Flux			2-Step		3-Step		5-Step	
	Min	Typ	Group	Flux (lm) @ 85 °C	Flux (lm) @ 25 °C*	Group	Order Code	Group	Order Code	Group	Order Code
5000 K	70		N4	1710	1965					50E	XHP70A-00-0000-0D0BN450E
			N2	1590	1827						XHP70A-00-0000-0D0BN250E
	80		N2	1590	1827			50G	XHP70A-00-0000-0D0HN250G		
			M4	1485	1707				XHP70A-00-0000-0D0HM450G		
			M2	1380	1586				XHP70A-00-0000-0D0HM250G		
	90		K4	1290	1482			50G	XHP70A-00-0000-0D0UK450G		
			K2	1200	1379				XHP70A-00-0000-0D0UK250G		
			J4	1120	1287				XHP70A-00-0000-0D0UJ450G		
	4500 K	70		N2	1590	1827					45E
			M4	1485	1707					XHP70A-00-0000-0D0BM445E	
80			M4	1485	1707			45G	XHP70A-00-0000-0D0HM445G		
			M2	1380	1586				XHP70A-00-0000-0D0HM245G		
90			K4	1290	1482			45G	XHP70A-00-0000-0D0UK445G		
			K2	1200	1379				XHP70A-00-0000-0D0UK245G		
			J4	1120	1287				XHP70A-00-0000-0D0UJ445G		

Notes

- Cree maintains a tolerance of $\pm 7\%$ on flux and power measurements, ± 0.005 on chromaticity (CCx, CCy) measurements and a tolerance of ± 2 on CRI measurements. See the Measurements section (page 26).
- Cree XLamp XHP70 LED order codes specify only a minimum flux bin and not a maximum. Cree may ship reels in flux bins higher than the minimum specified by the order code without advance notice. Shipments will always adhere to the chromaticity bin restrictions specified by the order code.
- * Flux values @ 25 °C are calculated and for reference only.

FLUX CHARACTERISTICS, EASYWHITE® ORDER CODES AND BINS - CONTINUED

Nominal CCT	CRI		Minimum Luminous Flux			2-Step		3-Step		5-Step		
	Min	Typ	Group	Flux (lm) @ 85 °C	Flux (lm) @ 25 °C*	Group	Order Code	Group	Order Code	Group	Order Code	
4000 K	70		N2	1590	1827					40E	XHP70A-00-0000-0D0BN240E	
			M4	1485	1707						XHP70A-00-0000-0D0BM440E	
	80		M4	1485	1707	40H	XHP70A-00-0000-0D0HM440H	40G	XHP70A-00-0000-0D0HM440G			
			M2	1380	1586		XHP70A-00-0000-0D0HM240H		XHP70A-00-0000-0D0HM240G			
	90		K4	1290	1482	40H	XHP70A-00-0000-0D0UK440H	40G	XHP70A-00-0000-0D0UK40G			
			K2	1200	1379		XHP70A-00-0000-0D0UK240H		XHP70A-00-0000-0D0UK240G			
			J4	1120	1287		XHP70A-00-0000-0D0UJ440H		XHP70A-00-0000-0D0UJ440G			
	3500 K	70		N2	1590	1827					35E	XHP70A-00-0000-0D0BN235E
				M4	1485	1707						XHP70A-00-0000-0D0BM435E
80			M4	1485	1707	35H	XHP70A-00-0000-0D0HM435H	35G	XHP70A-00-0000-0D0HM435G			
			M2	1380	1586		XHP70A-00-0000-0D0HM235H		XHP70A-00-0000-0D0HM235G			
			K4	1290	1482		XHP70A-00-0000-0D0HK435H		XHP70A-00-0000-0D0HK435G			
90			K4	1290	1482	35H	XHP70A-00-0000-0D0UK435H	35G	XHP70A-00-0000-0D0UK435G			
			K2	1200	1379		XHP70A-00-0000-0D0UK235H		XHP70A-00-0000-0D0UK235G			
			J4	1120	1287		XHP70A-00-0000-0D0UJ435H		XHP70A-00-0000-0D0UJ435G			
			J2	1040	1195		XHP70A-00-0000-0D0UJ235H		XHP70A-00-0000-0D0UJ235G			

- Notes**
- Cree maintains a tolerance of $\pm 7\%$ on flux and power measurements, ± 0.005 on chromaticity (CCx, CCy) measurements and a tolerance of ± 2 on CRI measurements. See the Measurements section (page 26).
 - Cree XLamp XHP70 LED order codes specify only a minimum flux bin and not a maximum. Cree may ship reels in flux bins higher than the minimum specified by the order code without advance notice. Shipments will always adhere to the chromaticity bin restrictions specified by the order code.
 - * Flux values @ 25 °C are calculated and for reference only.

FLUX CHARACTERISTICS, EASYWHITE® ORDER CODES AND BINS - CONTINUED

Nominal CCT	CRI		Minimum Luminous Flux			2-Step		3-Step		5-Step	
	Min	Typ	Group	Flux (lm) @ 85 °C	Flux (lm) @ 25 °C*	Group	Order Code	Group	Order Code	Group	Order Code
3000 K	70		M4	1485	1707					30E	XHP70A-00-0000-0D0BM430E
			M2	1380	1586		XHP70A-00-0000-0D0BM230E				
	80		M4	1485	1707	30H	XHP70A-00-0000-0D0HM430H	30G	XHP70A-00-0000-0D0HM430G		
			M2	1380	1586		XHP70A-00-0000-0D0HM230H		XHP70A-00-0000-0D0HM230G		
			K4	1290	1482		XHP70A-00-0000-0D0HK430H		XHP70A-00-0000-0D0HK430G		
	90		K2	1200	1379	30H	XHP70A-00-0000-0D0UK230H	30G	XHP70A-00-0000-0D0UK230G		
			J4	1120	1287		XHP70A-00-0000-0D0UJ430H		XHP70A-00-0000-0D0UJ430G		
			J2	1040	1195		XHP70A-00-0000-0D0UJ230H		XHP70A-00-0000-0D0UJ230G		
	2700 K	80		M2	1380	1586	27H	XHP70A-00-0000-0D0HM227H	27G	XHP70A-00-0000-0D0HM227G	
K4				1290	1482	XHP70A-00-0000-0D0HK427H		XHP70A-00-0000-0D0HK427G			
K2				1200	1379	XHP70A-00-0000-0D0HK227H		XHP70A-00-0000-0D0HK227G			
90			J4	1120	1287	27H	XHP70A-00-0000-0D0UJ427H	27G	XHP70A-00-0000-0D0UJ427G		
			J2	1040	1195		XHP70A-00-0000-0D0UJ227H		XHP70A-00-0000-0D0UJ227G		
			H4	970	1115		XHP70A-00-0000-0D0UH427H		XHP70A-00-0000-0D0UH427G		

- Notes
- Cree maintains a tolerance of $\pm 7\%$ on flux and power measurements, ± 0.005 on chromaticity (CCx, CCy) measurements and a tolerance of ± 2 on CRI measurements. See the Measurements section (page 26).
 - Cree XLamp XHP70 LED order codes specify only a minimum flux bin and not a maximum. Cree may ship reels in flux bins higher than the minimum specified by the order code without advance notice. Shipments will always adhere to the chromaticity bin restrictions specified by the order code.
 - * Flux values @ 25 °C are calculated and for reference only.

FLUX CHARACTERISTICS, ANSI WHITE ORDER CODES AND BINS

The following table provides order codes for XLamp XHP70 LEDs. For a complete description of how the flux and chromaticity groups are reflected in the bin code and order code nomenclature, please see the Bin and Order Code Formats section (page 24).

Binning condition: $T_j = 85\text{ }^\circ\text{C}$; 12 V, $I_F = 1050\text{ mA}$

Reference condition: $T_j = 85\text{ }^\circ\text{C}$; 6 V, $I_F = 2100\text{ mA}$

Nominal CCT	Chromaticity Regions	CRI		Minimum Luminous Flux			Order Code		
		Min	Typ	Group	Flux (lm) @ 85 °C	Flux (lm) @ 25 °C*			
7000 K	0A, 0B, 0C, 0D, 0R, 0S, 0T, 0U, 1A, 1B, 1C, 1D, 1R, 1S, 1T, 1U	0	68	N4	1710	1965	XHP70A-00-0000-0D00N40DT		
				N2	1590	1827	XHP70A-00-0000-0D00N20DT		
		70		N4	1710	1965	XHP70A-00-0000-0D0BN40DT		
				N2	1590	1827	XHP70A-00-0000-0D0BN20DT		
		80		N2	1590	1827	XHP70A-00-0000-0D0HN20DT		
				M4	1485	1707	XHP70A-00-0000-0D0HM40DT		
		90			M2	1380	1586	XHP70A-00-0000-0D0UM20DT	
					K4	1290	1482	XHP70A-00-0000-0D0UK40DT	
					K2	1200	1379	XHP70A-00-0000-0D0UK20DT	
		6500 K	0A, 0B, 0C, 0D, 0R, 0S, 0T, 0U, 1A, 1B, 1C, 1D, 1R, 1S, 1T, 1U, 2A, 2B, 2C, 2D, 2R, 2S, 2T, 2U	0	68	N4	1710	1965	XHP70A-00-0000-0D00N40CB
						N2	1590	1827	XHP70A-00-0000-0D00N20CB
70				N4	1710	1965	XHP70A-00-0000-0D0BN40CB		
				N2	1590	1827	XHP70A-00-0000-0D0BN20CB		
80				N2	1590	1827	XHP70A-00-0000-0D0HN20CB		
				M4	1485	1707	XHP70A-00-0000-0D0HM40CB		
90					M2	1380	1586	XHP70A-00-0000-0D0UM20CB	
					K4	1290	1482	XHP70A-00-0000-0D0UK40CB	
					K2	1200	1379	XHP70A-00-0000-0D0UK20CB	
6500 K	1A, 1B, 1C, 1D			0	68	N4	1710	1965	XHP70A-00-0000-0D00N40E1
						N2	1590	1827	XHP70A-00-0000-0D00N20E1
		70		N4	1710	1965	XHP70A-00-0000-0D0BN40E1		
				N2	1590	1827	XHP70A-00-0000-0D0BN20E1		
		80		N2	1590	1827	XHP70A-00-0000-0D0HN20E1		
				M4	1485	1707	XHP70A-00-0000-0D0HM40E1		
		90			M2	1380	1586	XHP70A-00-0000-0D0UM20E1	
					K4	1290	1482	XHP70A-00-0000-0D0UK40E1	
					K2	1200	1379	XHP70A-00-0000-0D0UK20E1	

Notes

- Cree maintains a tolerance of $\pm 7\%$ on flux and power measurements, ± 0.005 on chromaticity (CCx, CCy) measurements and a tolerance of ± 2 on CRI measurements. See the Measurements section (page 26).
- Cree XLamp XHP70 LED order codes specify only a minimum flux bin and not a maximum. Cree may ship reels in flux bins higher than the minimum specified by the order code without advance notice. Shipments will always adhere to the chromaticity bin restrictions specified by the order code.
- * Flux values @ 25 °C are calculated and for reference only.

FLUX CHARACTERISTICS, ANSI WHITE ORDER CODES AND BINS - CONTINUED

Nominal CCT	Chromaticity Regions	CRI		Minimum Luminous Flux			Order Code		
		Min	Typ	Group	Flux (lm) @ 85 °C	Flux (lm) @ 25 °C*			
6000 K	1A, 1B, 1C, 1D, 1R, 1S, 1T, 1U, 2A, 2B, 2C, 2D, 2R, 2S, 2T, 2U	0	68	N4	1710	1965	XHP70A-00-0000-0D00N40DV		
				N2	1590	1827	XHP70A-00-0000-0D00N20DV		
		70		N4	1710	1965	XHP70A-00-0000-0D0BN40DV		
				N2	1590	1827	XHP70A-00-0000-0D0BN20DV		
		80		N2	1590	1827	XHP70A-00-0000-0D0HN20DV		
				M4	1485	1707	XHP70A-00-0000-0D0HM40DV		
		90		M2	1380	1586	XHP70A-00-0000-0D0UM20DV		
				K4	1290	1482	XHP70A-00-0000-0D0UK40DV		
				K2	1200	1379	XHP70A-00-0000-0D0UK20DV		
		5700 K	2A, 2B, 2C, 2D	0	68	N4	1710	1965	XHP70A-00-0000-0D00N40E2
						N2	1590	1827	XHP70A-00-0000-0D00N20E2
				70		N4	1710	1965	XHP70A-00-0000-0D0BN40E2
N2	1590					1827	XHP70A-00-0000-0D0BN20E2		
80				N2	1590	1827	XHP70A-00-0000-0D0HN20E2		
				M4	1485	1707	XHP70A-00-0000-0D0HM40E2		
90				M2	1380	1586	XHP70A-00-0000-0D0UM20E2		
				K4	1290	1482	XHP70A-00-0000-0D0UK40E2		
				K2	1200	1379	XHP70A-00-0000-0D0UK20E2		
5000 K	3A, 3B, 3C, 3D			0	68	N4	1710	1965	XHP70A-00-0000-0D00N40E3
						N2	1590	1827	XHP70A-00-0000-0D00N20E3
				70		N4	1710	1965	XHP70A-00-0000-0D0BN40E3
		N2	1590			1827	XHP70A-00-0000-0D0BN20E3		
		80		N2	1590	1827	XHP70A-00-0000-0D0HN20E3		
				M4	1485	1707	XHP70A-00-0000-0D0HM40E3		
		90		M2	1380	1586	XHP70A-00-0000-0D0HM20E3		
				K4	1290	1482	XHP70A-00-0000-0D0UK40E3		
				K2	1200	1379	XHP70A-00-0000-0D0UK20E3		
		4500 K	4A, 4B, 4C, 4D	0	68	N2	1590	1827	XHP70A-00-0000-0D00N20E4
						M4	1485	1707	XHP70A-00-0000-0D00M40E4
				70		N2	1590	1827	XHP70A-00-0000-0D0BN20E4
M4	1485					1707	XHP70A-00-0000-0D0BM40E4		
80				M4	1485	1707	XHP70A-00-0000-0D0HM40E4		
				M2	1380	1586	XHP70A-00-0000-0D0HM20E4		
90		K4	1290	1482	XHP70A-00-0000-0D0UK40E4				
		K2	1200	1379	XHP70A-00-0000-0D0UK20E4				
		J4	1120	1287	XHP70A-00-0000-0D0UJ40E4				

- Notes
- Cree maintains a tolerance of $\pm 7\%$ on flux and power measurements, ± 0.005 on chromaticity (CCx, CCy) measurements and a tolerance of ± 2 on CRI measurements. See the Measurements section (page 26).
 - Cree XLamp XHP70 LED order codes specify only a minimum flux bin and not a maximum. Cree may ship reels in flux bins higher than the minimum specified by the order code without advance notice. Shipments will always adhere to the chromaticity bin restrictions specified by the order code.
 - * Flux values @ 25 °C are calculated and for reference only.

FLUX CHARACTERISTICS, ANSI WHITE ORDER CODES AND BINS - CONTINUED

Nominal CCT	Chromaticity Regions	CRI		Minimum Luminous Flux			Order Code
		Min	Typ	Group	Flux (lm) @ 85 °C	Flux (lm) @ 25 °C*	
4000 K	5A, 5B, 5C, 5D	0	68	N2	1590	1827	XHP70A-00-0000-0D00N20E5
				M4	1485	1707	XHP70A-00-0000-0D00M40E5
		70		N2	1590	1827	XHP70A-00-0000-0D0BN20E5
				M4	1485	1707	XHP70A-00-0000-0D0BM40E5
		80		M4	1485	1707	XHP70A-00-0000-0D0HM40E5
				M2	1380	1586	XHP70A-00-0000-0D0HM20E5
		90		K4	1290	1482	XHP70A-00-0000-0D0UK40E5
				K2	1200	1379	XHP70A-00-0000-0D0UK20E5
				J4	1120	1287	XHP70A-00-0000-0D0UJ40E5
3500 K	6A, 6B, 6C, 6D	70		N2	1590	1827	XHP70A-00-0000-0D0BN20E6
				M4	1485	1707	XHP70A-00-0000-0D0BM40E6
3000 K	7A, 7B, 7C, 7D	70		M4	1485	1707	XHP70A-00-0000-0D0BM40E7
				M2	1380	1586	XHP70A-00-0000-0D0BM20E7

RELATIVE SPECTRAL POWER DISTRIBUTION

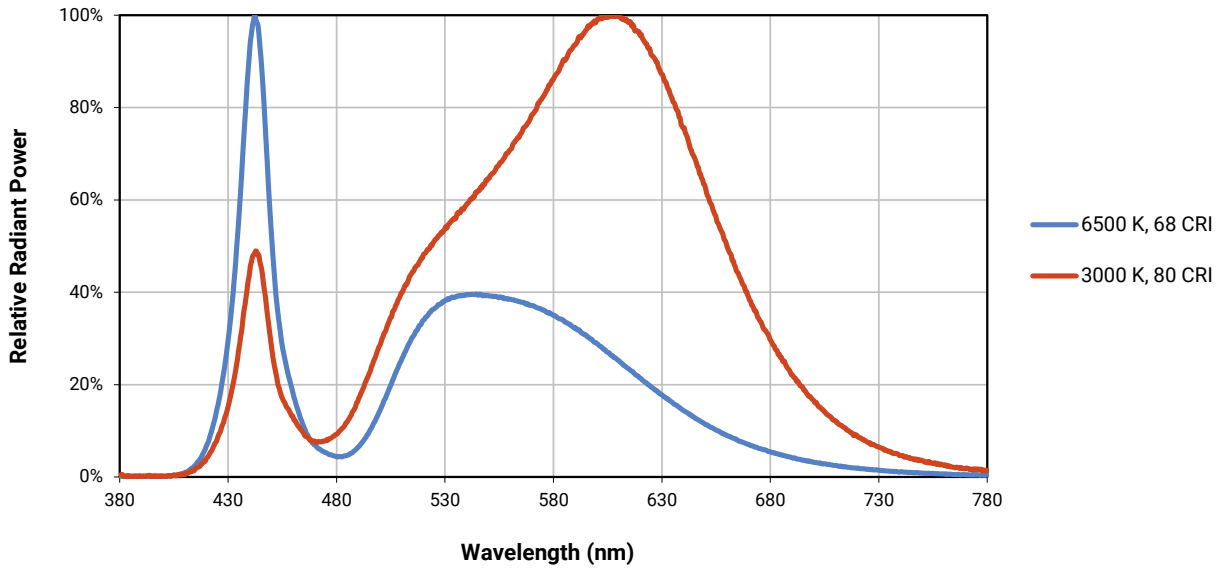

RELATIVE FLUX VS. JUNCTION TEMPERATURE

Reference condition: 6 V, $I_F = 2100$ mA; 12 V, $I_F = 1050$ mA

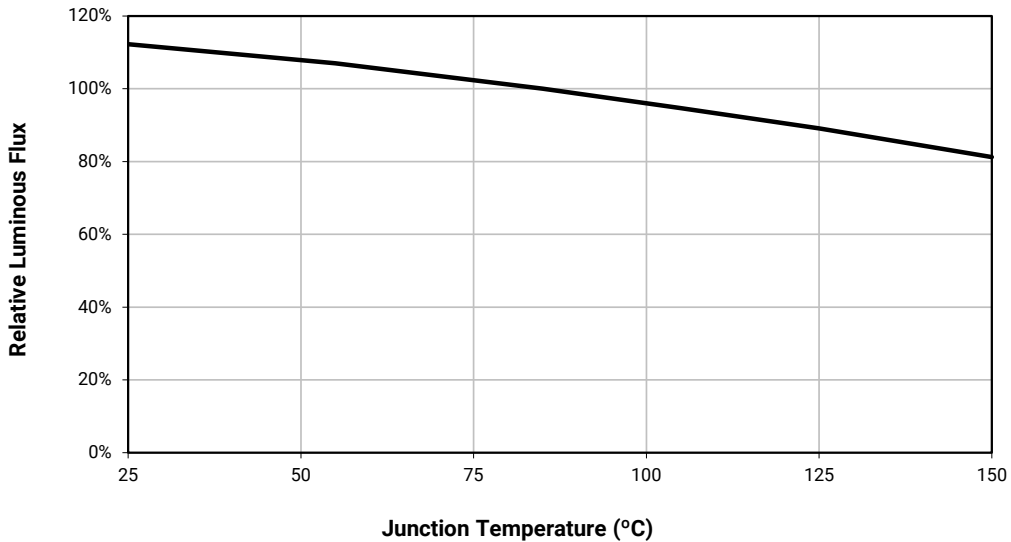

ELECTRICAL CHARACTERISTICS ($T_j = 85^\circ\text{C}$)

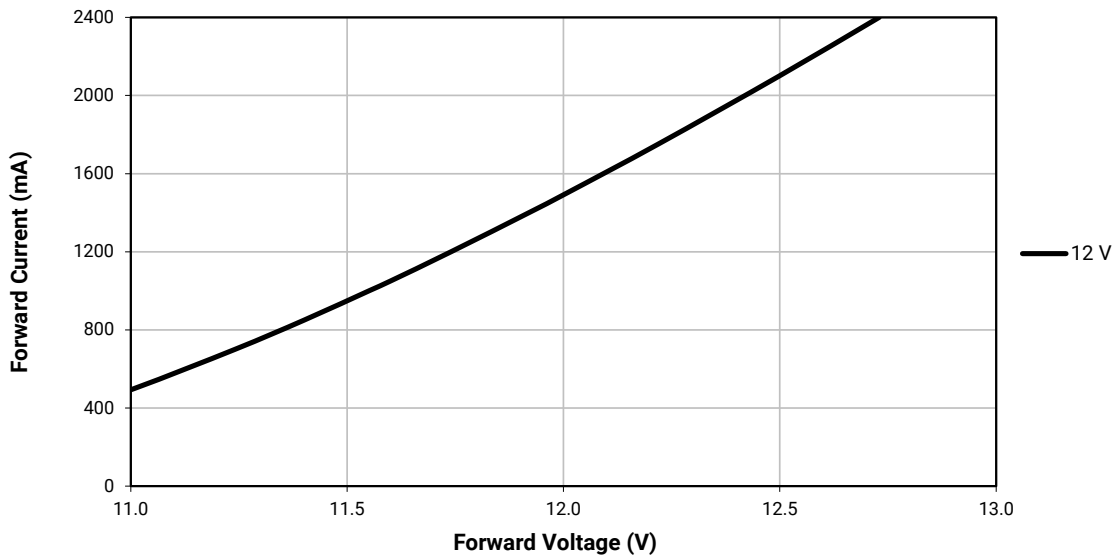
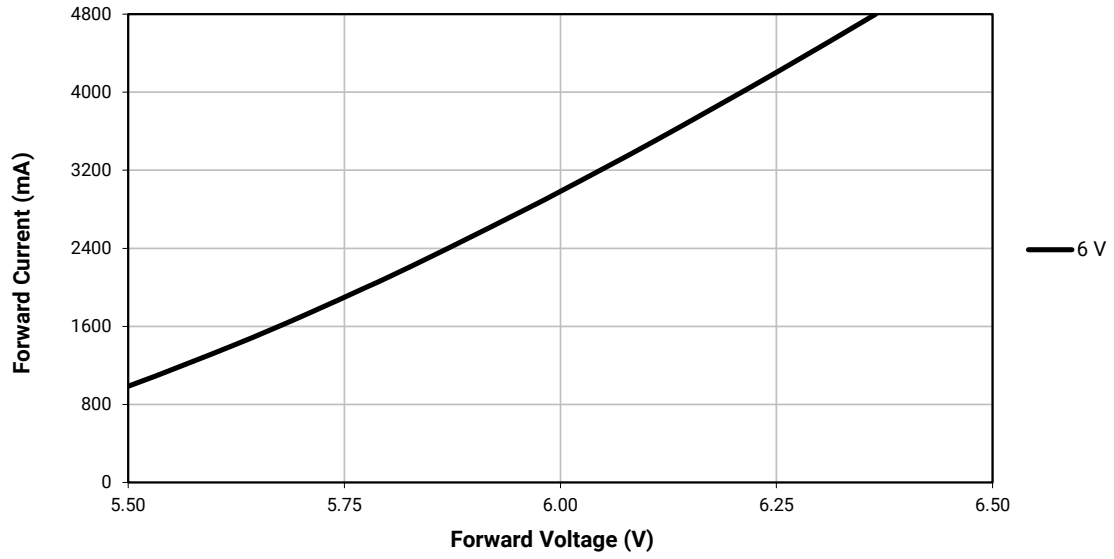

RELATIVE FLUX VS. CURRENT ($T_j = 85\text{ }^\circ\text{C}$)

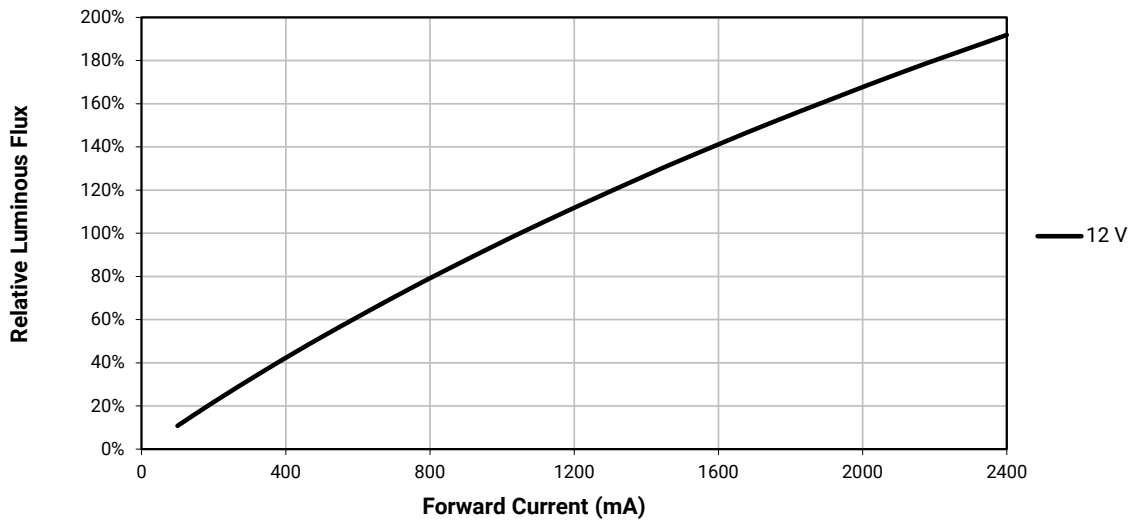
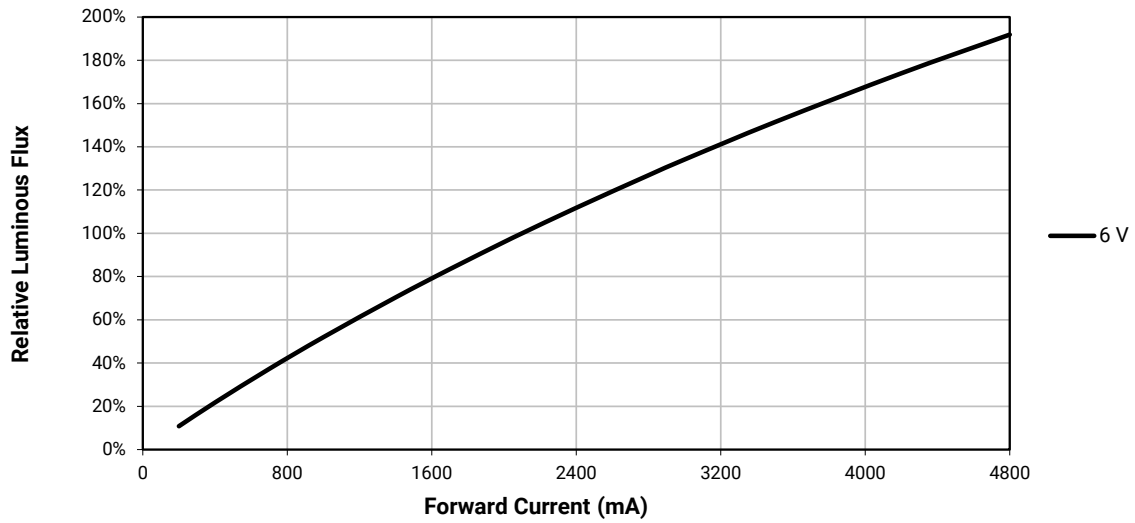

RELATIVE CHROMATICITY VS CURRENT (WARM WHITE)

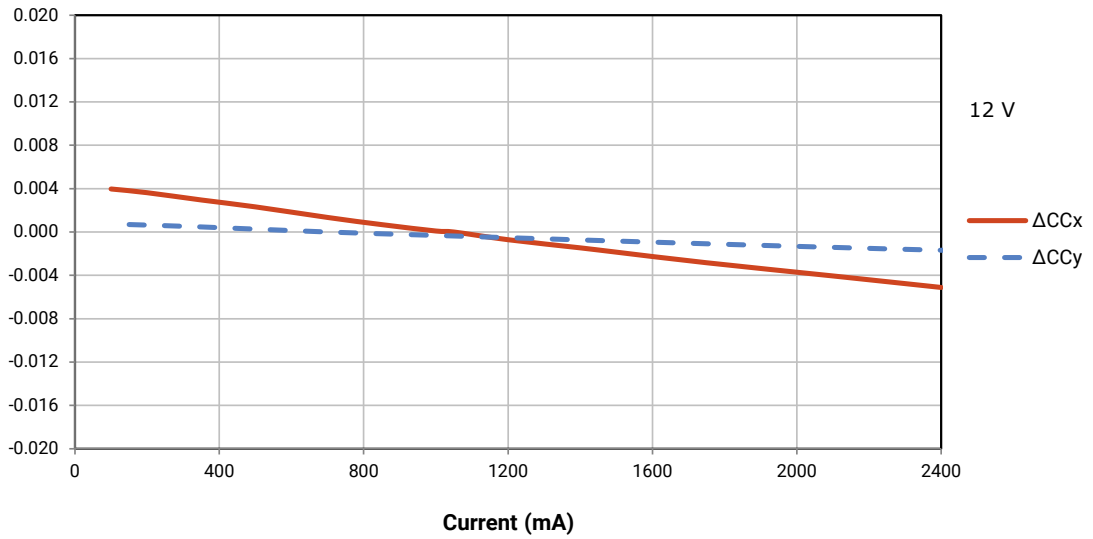
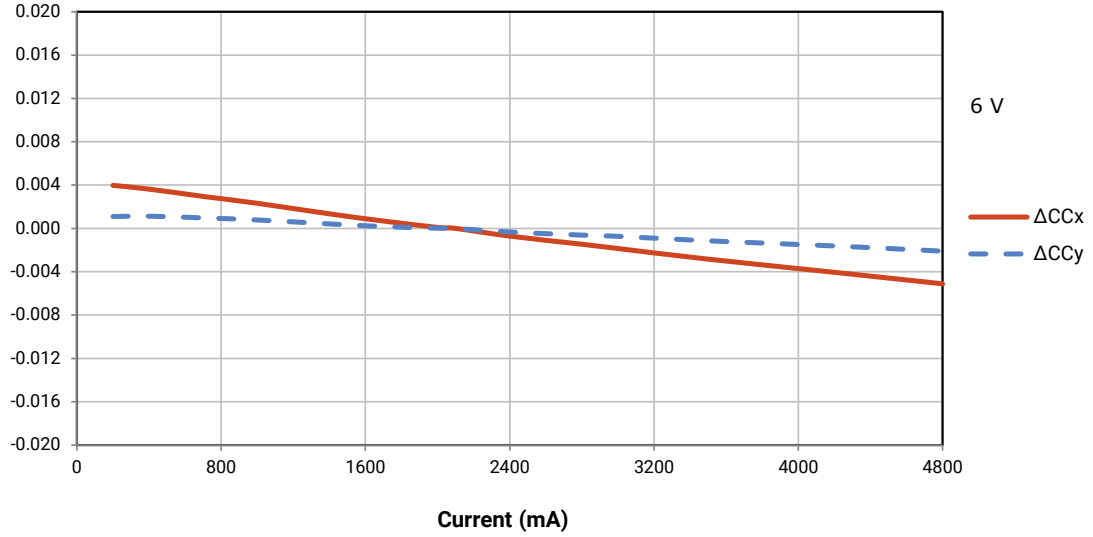

RELATIVE CHROMATICITY VS TEMPERATURE (WARM WHITE)

Reference condition: 6 V, $I_F = 2100$ mA; 12 V, $I_F = 1050$ mA

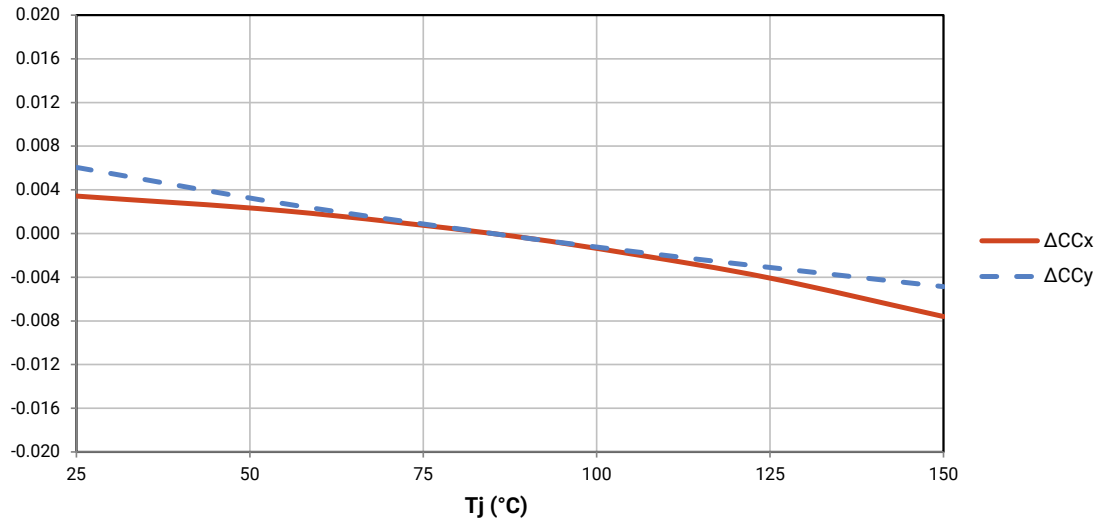

TYPICAL SPATIAL DISTRIBUTION

Reference condition: $T_j = 85$ °C; 6 V, $I_F = 2100$ mA; 12 V, $I_F = 1050$ mA

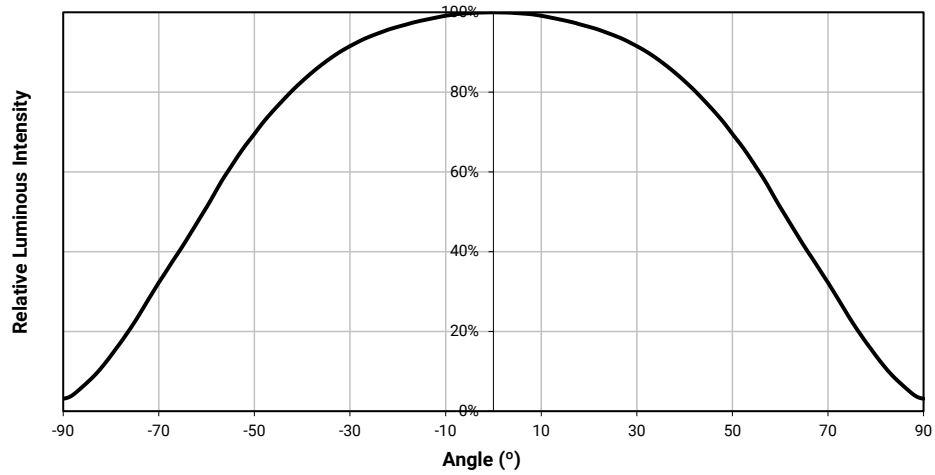

THERMAL DESIGN

The maximum forward current is determined by the thermal resistance between the LED junction and ambient. It is crucial for the end product to be designed in a manner that minimizes the thermal resistance from the solder point to ambient in order to optimize lamp life and optical characteristics.

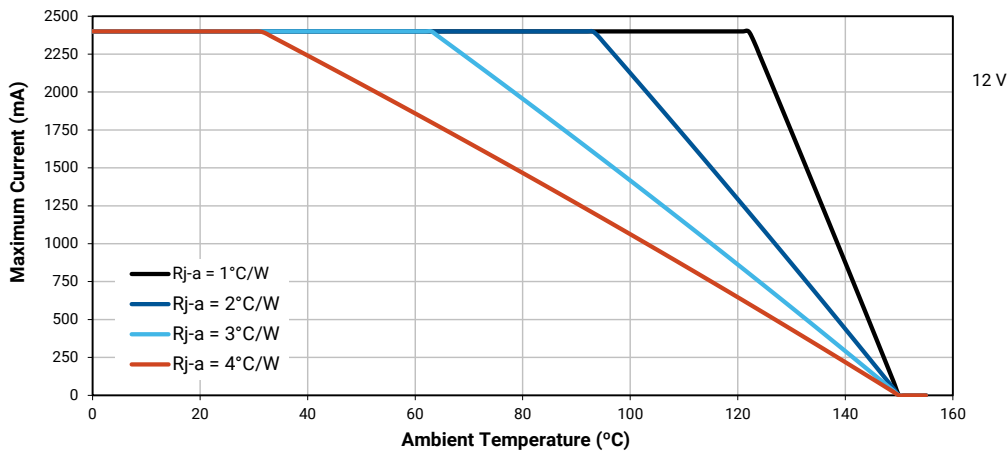
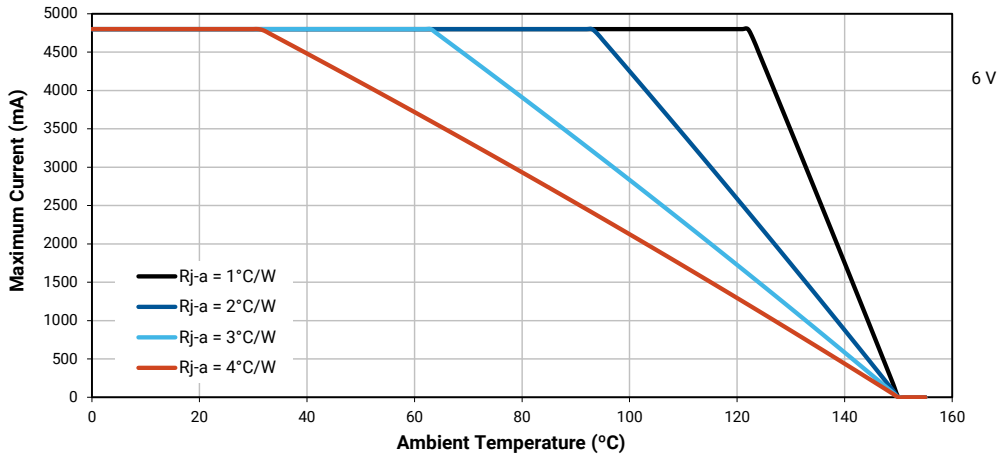

PERFORMANCE GROUPS – LUMINOUS FLUX ($T_j = 85\text{ }^\circ\text{C}$)

XLamp XHP70 LEDs are tested for luminous flux and placed into one of the following luminous-flux groups.

Group Code	Minimum Luminous Flux	Maximum Luminous Flux
H4	970	1040
J2	1040	1120
J4	1120	1200
K2	1200	1290
K4	1290	1380
M2	1380	1485
M4	1485	1590
N2	1590	1710
N4	1710	1830
P2	1830	1965

PERFORMANCE GROUPS – CHROMATICITY

XLamp XHP70 LEDs are tested for chromaticity and placed into one of the regions defined by the following bounding coordinates.

EasyWhite Color Temperatures – 2-Step			
Bin Code	CCT	x	y
40H	4000 K	0.3777	0.3739
		0.3797	0.3816
		0.3861	0.3855
		0.3838	0.3777
35H	3500 K	0.4022	0.3858
		0.4053	0.3942
		0.4125	0.3977
		0.4091	0.3891
30H	3000 K	0.4287	0.3975
		0.4328	0.4064
		0.4390	0.4086
		0.4347	0.3996
27H	2700 K	0.4524	0.4048
		0.4574	0.4140
		0.4633	0.4154
		0.4581	0.4062

PERFORMANCE GROUPS – CHROMATICITY (CONTINUED)

EasyWhite Color Temperatures – 3-Step Ellipse						
Bin Code	CCT	Center Point		Major Axis	Minor Axis	Rotation Angle (°)
		x	y	a	b	
50G	5000 K	0.3447	0.3553	0.00840	0.00312	65.0
45G	4500 K	0.3611	0.3658	0.00852	0.00330	61.5
40G	4000 K	0.3818	0.3797	0.00939	0.00402	53.7
35G	3500 K	0.4073	0.3917	0.00927	0.00414	54.0
30G	3000 K	0.4338	0.4030	0.00834	0.00408	53.2
27G	2700 K	0.4577	0.4099	0.00834	0.00420	48.5

EasyWhite Color Temperatures – 5-Step Ellipse						
Bin Code	CCT	Center Point		Major Axis	Minor Axis	Rotation Angle (°)
		x	y	a	b	
50E	5000 K	0.3447	0.3553	0.01400	0.00520	65.0
45E	4500 K	0.3611	0.3658	0.01420	0.00550	61.5
40E	4000 K	0.3818	0.3797	0.01565	0.00670	53.7
35E	3500 K	0.4073	0.3917	0.01545	0.00690	54.0
30E	3000 K	0.4338	0.4030	0.01390	0.00680	53.2

ANSI White Bins			
CCT	Bin Code	x	y
7000 K	0A0	0.2950	0.2970
		0.2920	0.3060
		0.2984	0.3133
		0.3009	0.3042
	0B0	0.2920	0.3060
		0.2895	0.3135
		0.2962	0.3220
		0.2984	0.3133
	0C0	0.2984	0.3133
		0.2962	0.3220
		0.3028	0.3304
		0.3048	0.3207
	0D0	0.2984	0.3133
		0.3048	0.3207
		0.3068	0.3113
		0.3009	0.3042

ANSI White Bins			
CCT	Bin Code	x	y
7000 K	0R0	0.2980	0.2880
		0.2950	0.2970
		0.3009	0.3042
		0.3037	0.2937
	0S0	0.2895	0.3135
		0.2870	0.3210
		0.2937	0.3312
		0.2962	0.3220
	0T0	0.2962	0.3220
		0.2937	0.3312
		0.3005	0.3415
		0.3028	0.3304
	0U0	0.3037	0.2937
		0.3009	0.3042
		0.3068	0.3113
		0.3093	0.2993

ANSI White Bins			
CCT	Bin Code	x	y
7000 K	1A0	0.3048	0.3207
		0.3130	0.3290
		0.3144	0.3186
		0.3068	0.3113
	1B0	0.3028	0.3304
		0.3115	0.3391
		0.3130	0.3290
		0.3048	0.3207
	1C0	0.3115	0.3391
		0.3205	0.3481
		0.3213	0.3373
		0.3130	0.3290
	1D0	0.3130	0.3290
		0.3213	0.3373
		0.3221	0.3261
		0.3144	0.3186

PERFORMANCE GROUPS – CHROMATICITY (CONTINUED)

ANSI White Bins			
CCT	Bin Code	x	y
7000 K	1R0	0.3068	0.3113
		0.3144	0.3186
		0.3161	0.3059
		0.3093	0.2993
	1S0	0.3005	0.3415
		0.3099	0.3509
		0.3115	0.3391
		0.3028	0.3304
	1T0	0.3099	0.3509
		0.3196	0.3602
		0.3205	0.3481
		0.3115	0.3391
	1U0	0.3144	0.3186
		0.3221	0.3261
		0.3231	0.3120
		0.3161	0.3059

ANSI White Bins			
CCT	Bin Code	x	y
6000 K	2A0	0.3215	0.3350
		0.3290	0.3417
		0.3290	0.3300
		0.3222	0.3243
	2B0	0.3207	0.3462
		0.3290	0.3538
		0.3290	0.3417
		0.3215	0.3350
	2C0	0.3290	0.3538
		0.3376	0.3616
		0.3371	0.3490
		0.3290	0.3417
	2D0	0.3290	0.3417
		0.3371	0.3490
		0.3366	0.3369
		0.3290	0.3300

ANSI White Bins			
CCT	Bin Code	x	y
6000 K	2R0	0.3222	0.3243
		0.3290	0.3300
		0.3290	0.3180
		0.3231	0.3120
	2S0	0.3196	0.3602
		0.3290	0.3690
		0.3290	0.3538
		0.3207	0.3462
	2T0	0.3290	0.3690
		0.3381	0.3762
		0.3376	0.3616
		0.3290	0.3538
	2U0	0.3290	0.3300
		0.3366	0.3369
		0.3361	0.3245
		0.3290	0.3180

ANSI White Bins			
CCT	Bin Code	x	y
5000 K	3A0	0.3371	0.3490
		0.3451	0.3554
		0.3440	0.3427
		0.3366	0.3369
	3B0	0.3376	0.3616
		0.3463	0.3687
		0.3451	0.3554
		0.3371	0.3490
	3C0	0.3463	0.3687
		0.3551	0.3760
		0.3533	0.3620
		0.3451	0.3554
	3D0	0.3451	0.3554
		0.3533	0.3620
		0.3515	0.3487
		0.3440	0.3427

ANSI White Bins			
CCT	Bin Code	x	y
4500 K	4A0	0.3530	0.3597
		0.3615	0.3659
		0.3512	0.3465
		0.3515	0.3487
	4B0	0.3548	0.3736
		0.3641	0.3804
		0.3530	0.3597
		0.3533	0.362
	4C0	0.3641	0.3804
		0.3736	0.3874
		0.3702	0.3722
		0.3615	0.3659
	4D0	0.3615	0.3659
		0.3702	0.3722
		0.3670	0.3578
		0.3590	0.3521

PERFORMANCE GROUPS – CHROMATICITY (CONTINUED)

ANSI White Bins			
CCT	Bin Code	x	y
4000 K	5A0	0.3670	0.3578
		0.3702	0.3722
		0.3825	0.3798
		0.3783	0.3646
	5B0	0.3702	0.3722
		0.3736	0.3874
		0.3869	0.3958
		0.3825	0.3798
	5C0	0.3825	0.3798
		0.3869	0.3958
		0.4006	0.4044
		0.3950	0.3875
	5D0	0.3783	0.3646
		0.3825	0.3798
		0.3950	0.3875
		0.3898	0.3716

ANSI White Bins			
CCT	Bin Code	x	y
3500 K	6A0	0.3889	0.3690
		0.3941	0.3848
		0.4080	0.3916
		0.4017	0.3751
	6B0	0.3941	0.3848
		0.3996	0.4015
		0.4146	0.4089
		0.4080	0.3916
	6C0	0.4080	0.3916
		0.4146	0.4089
		0.4299	0.4165
		0.4221	0.3984
	6D0	0.4017	0.3751
		0.4080	0.3916
		0.4221	0.3984
		0.4147	0.3814

ANSI White Bins			
CCT	Bin Code	x	y
3000 K	7A0	0.4147	0.3814
		0.4221	0.3984
		0.4342	0.4028
		0.4259	0.3853
	7B0	0.4221	0.3984
		0.4299	0.4165
		0.4430	0.4212
		0.4342	0.4028
	7C0	0.4342	0.4028
		0.4430	0.4212
		0.4562	0.4260
		0.4465	0.4071
	7D0	0.4259	0.3853
		0.4342	0.4028
		0.4465	0.4071
		0.4373	0.3893

CREE'S STANDARD WHITE CHROMATICITY REGIONS PLOTTED ON THE CIE 1931 CURVE

ANSI Cool White

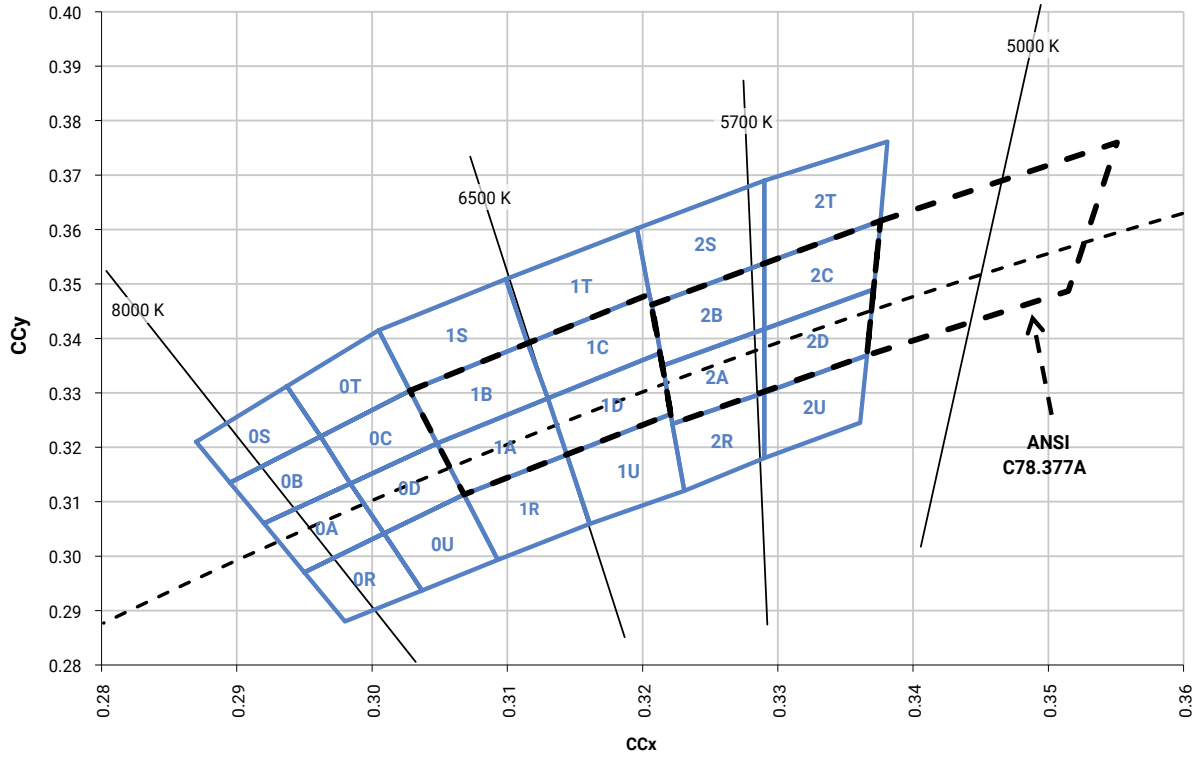

CREE'S STANDARD WHITE CHROMATICITY REGIONS PLOTTED ON THE CIE 1931 CURVE - CONTINUED

ANSI Neutral White and ANSI Warm White

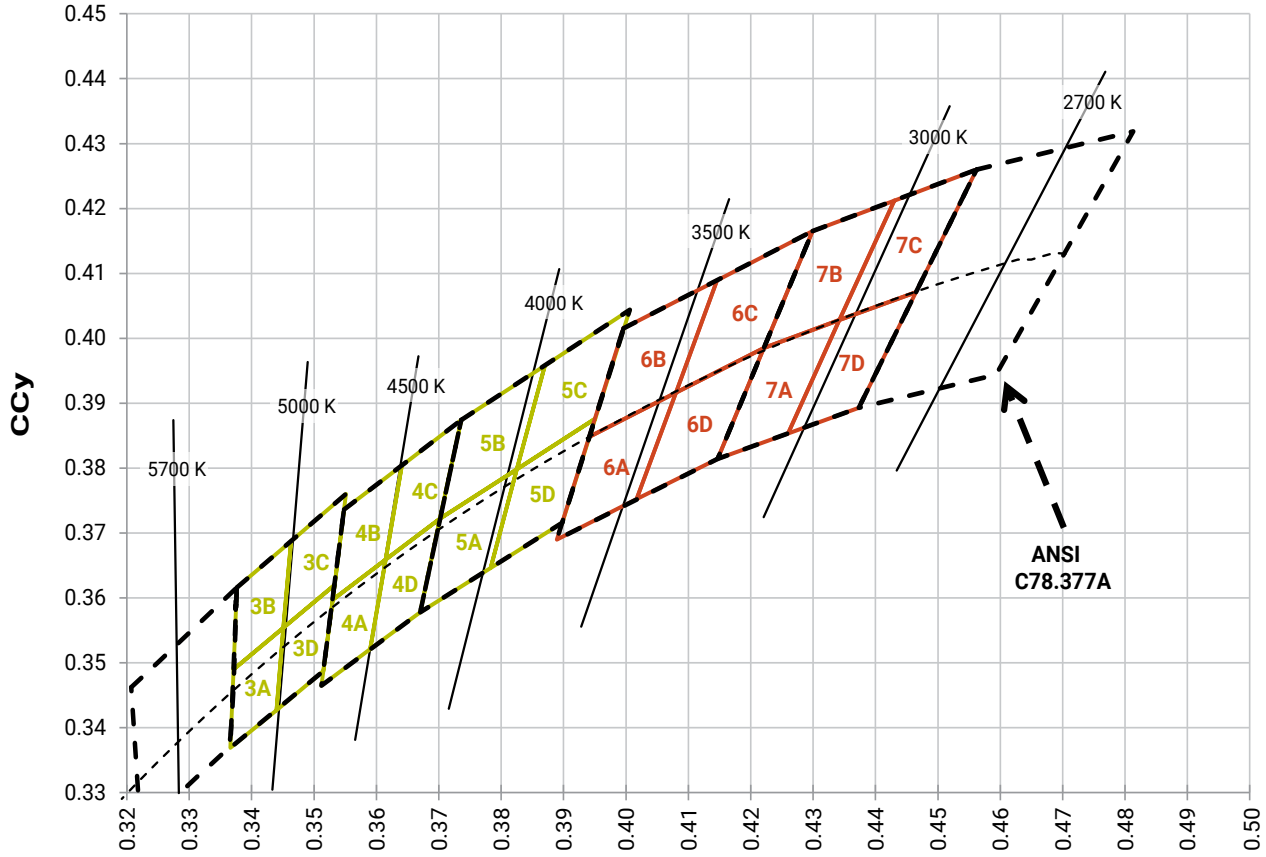

CREE'S STANDARD WHITE CHROMATICITY REGIONS PLOTTED ON THE CIE 1931 CURVE - CONTINUED

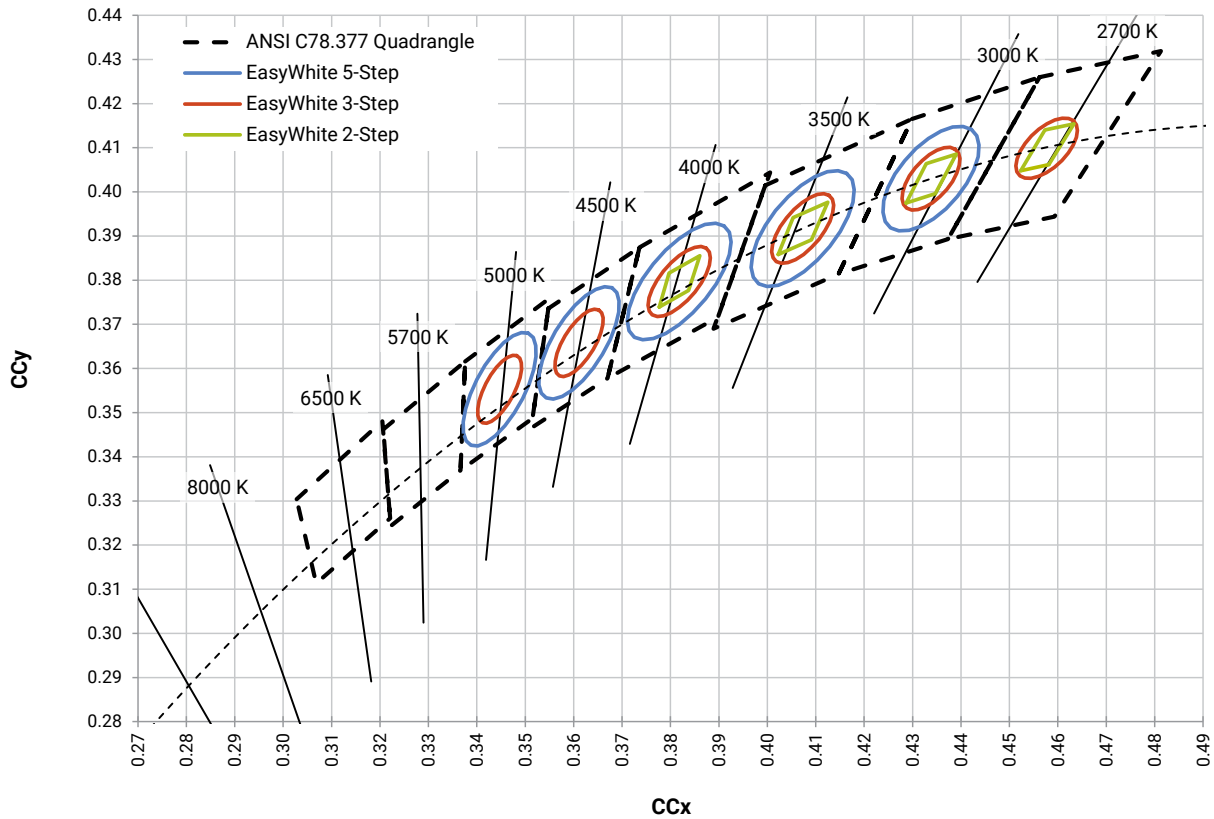

CREE'S STANDARD COOL WHITE KITS PLOTTED ON ANSI STANDARD CHROMATICITY REGIONS

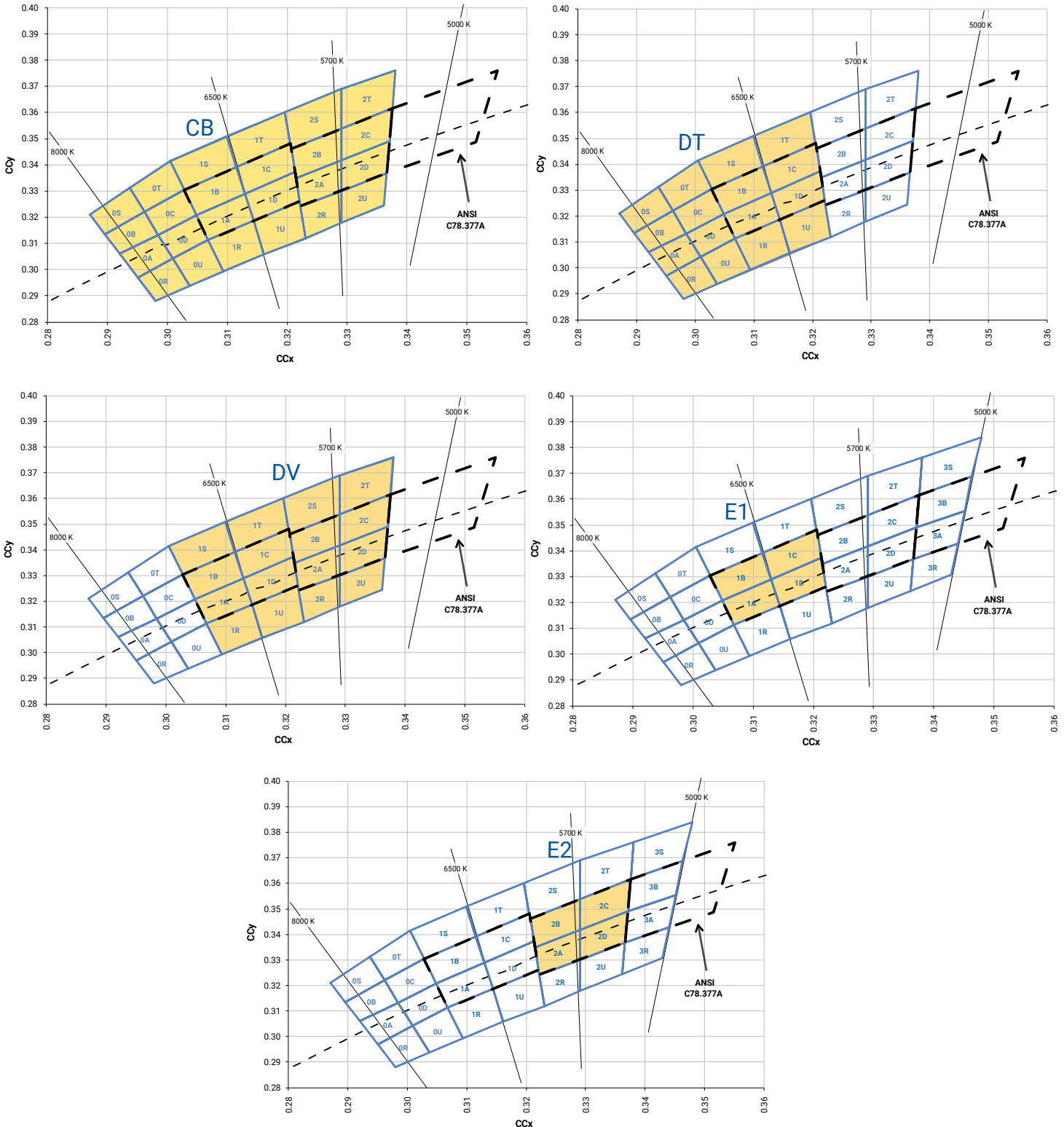

CREE'S STANDARD WARM AND NEUTRAL WHITE KITS PLOTTED ON ANSI STANDARD CHROMATICITY REGIONS

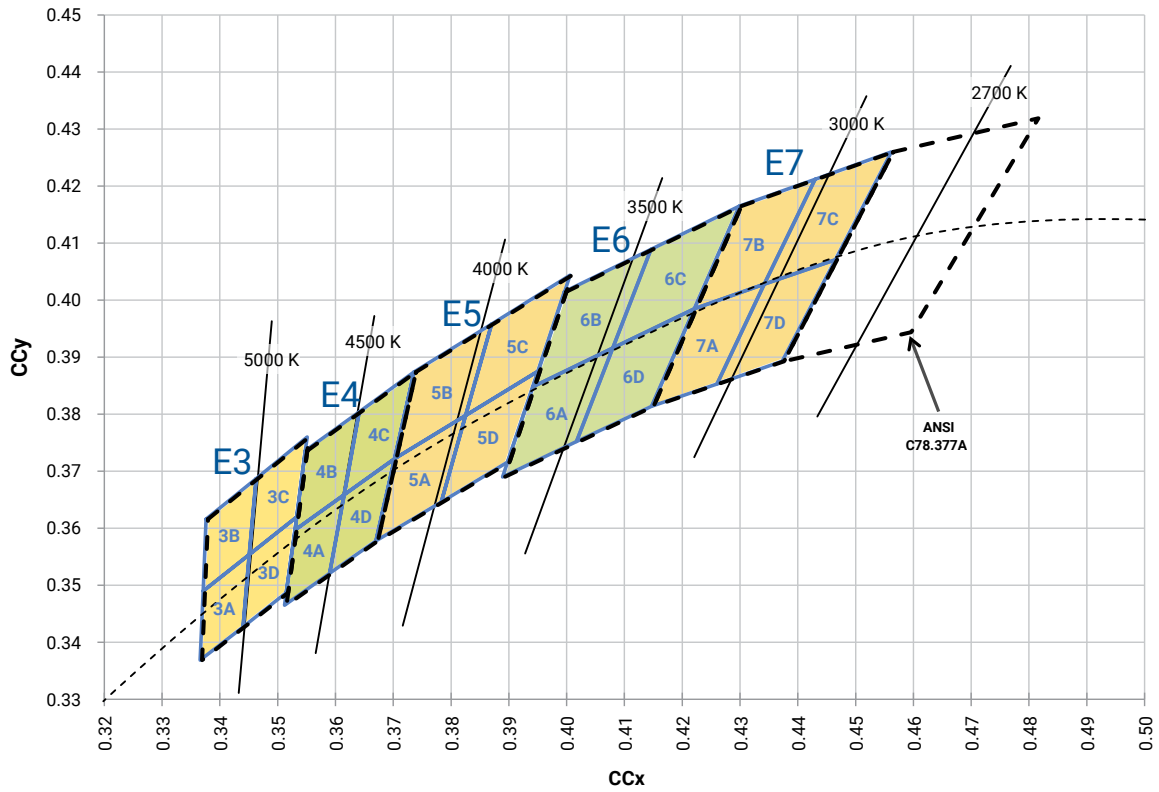

BIN AND ORDER-CODE FORMAT

Bin codes and order codes for XHP70 LEDs are configured in the following manner:

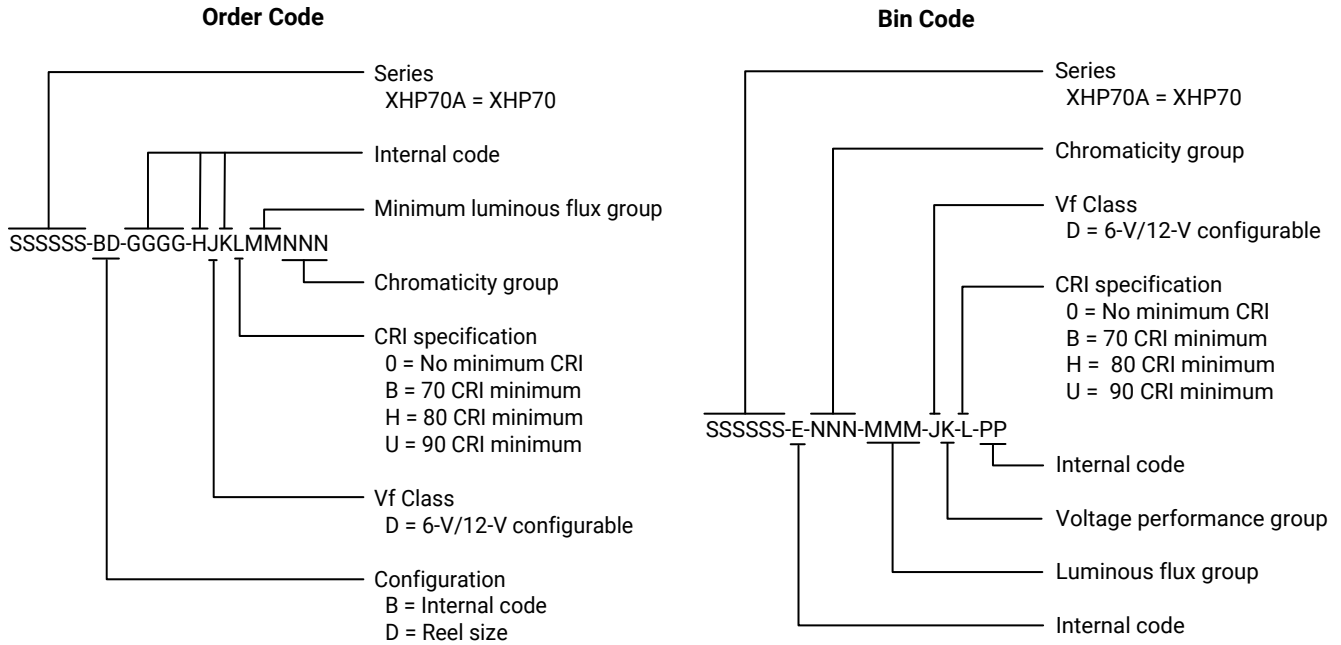

REFLOW SOLDERING CHARACTERISTICS

In testing, Cree has found XLamp XHP70 LEDs to be compatible with JEDEC J-STD-020C, using the parameters listed below. As a general guideline, Cree recommends that users follow the recommended soldering profile provided by the manufacturer of the solder paste used, and therefore it is the lamp or luminaire manufacturer’s responsibility to determine applicable soldering requirements.

Note that this general guideline may not apply to all PCB designs and configurations of reflow soldering equipment.

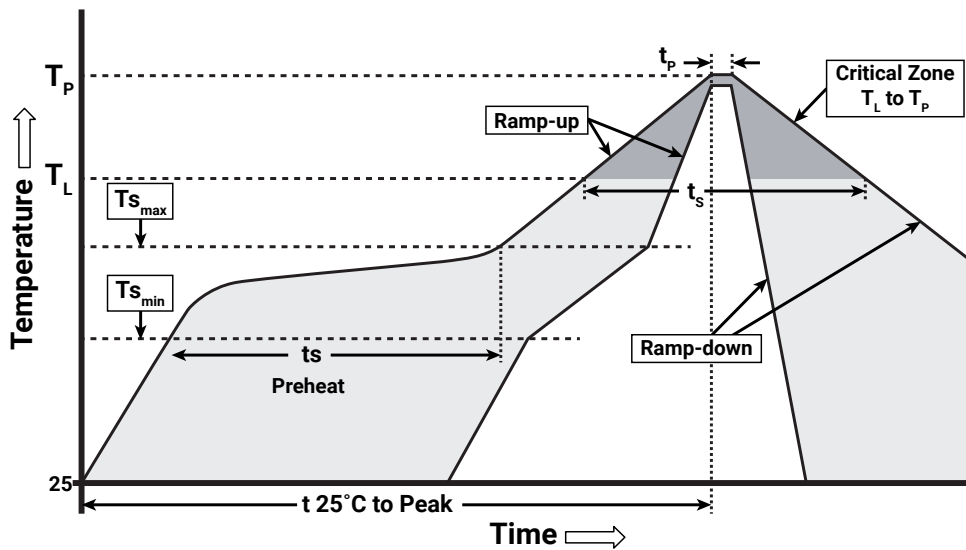

IPC/JEDEC J-STD-020C

Profile Feature	Lead-Free Solder
Average Ramp-Up Rate ($T_{s_{max}}$ to T_p)	1.2 °C/second
Preheat: Temperature Min ($T_{s_{min}}$)	120 °C
Preheat: Temperature Max ($T_{s_{max}}$)	170 °C
Preheat: Time ($t_{s_{min}}$ to $t_{s_{max}}$)	65-150 seconds
Time Maintained Above: Temperature (T_L)	217 °C
Time Maintained Above: Time (t_s)	45-90 seconds
Peak/Classification Temperature (T_p)	235 - 245 °C
Time Within 5 °C of Actual Peak Temperature (t_p)	20-40 seconds
Ramp-Down Rate	1 - 6 °C/second
Time 25 °C to Peak Temperature	4 minutes max.

Note: All temperatures refer to the topside of the package, measured on the package body surface.

NOTES

Measurements

The luminous flux, radiant power, chromaticity, forward voltage and CRI measurements in this document are binning specifications only and solely represent product measurements as of the date of shipment. These measurements will change over time based on a number of factors that are not within Cree's control and are not intended or provided as operational specifications for the products. Calculated values are provided for informational purposes only and are not intended or provided as specifications.

Pre-Release Qualification Testing

Please read the [LED Reliability Overview](#) for details of the qualification process Cree applies to ensure long-term reliability for XLamp LEDs and details of Cree's pre-release qualification testing for XLamp LEDs.

Lumen Maintenance

Cree now uses standardized IES LM-80-08 and TM-21-11 methods for collecting long-term data and extrapolating LED lumen maintenance. For information on the specific LM-80 data sets available for this LED, refer to the public [LM-80 results document](#).

Please read the [Long-Term Lumen Maintenance application note](#) for more details on Cree's lumen maintenance testing and forecasting. Please read the [Thermal Management application note](#) for details on how thermal design, ambient temperature, and drive current affect the LED junction temperature.

Moisture Sensitivity

Cree recommends keeping XLamp LEDs in the provided, resealable moisture-barrier packaging (MBP) until immediately prior to soldering. Unopened MBPs that contain XLamp LEDs do not need special storage for moisture sensitivity.

Once the MBP is opened, XLamp XHP70 LEDs may be stored as MSL 1 per JEDEC J-STD-033, meaning they have unlimited floor life in conditions of ≤ 30 °C/85% relative humidity (RH). Regardless of the storage condition, Cree recommends sealing any unsoldered LEDs in the original MBP.

RoHS Compliance

The levels of RoHS restricted materials in this product are below the maximum concentration values (also referred to as the threshold limits) permitted for such substances, or are used in an exempted application, in accordance with EU Directive 2011/65/EC (RoHS2), as implemented January 2, 2013. RoHS Declarations for this product can be obtained from your Cree representative or from the [Product Ecology](#) section of the Cree website.

REACH Compliance

REACH substances of very high concern (SVHCs) information is available for this product. Since the European Chemical Agency (ECHA) has published notice of their intent to frequently revise the SVHC listing for the foreseeable future, please contact a Cree representative to insure you get the most up-to-date REACH SVHC Declaration. REACH banned substance information (REACH Article 67) is also available upon request.

NOTES - CONTINUED

UL® Recognized Component

This product meets the requirements to be considered a UL Recognized Component with Level 4 enclosure consideration. The LED package or a portion thereof has been investigated as a fire and electrical enclosure per ANSI/UL 8750.

Vision Advisory

WARNING: Do not look at an exposed lamp in operation. Eye injury can result. For more information about LEDs and eye safety, please refer to the [LED Eye Safety application note](#).

MECHANICAL DIMENSIONS

Thermal vias, if present, are not shown on these drawings.

All dimensions are ± 0.13 mm unless otherwise indicated.

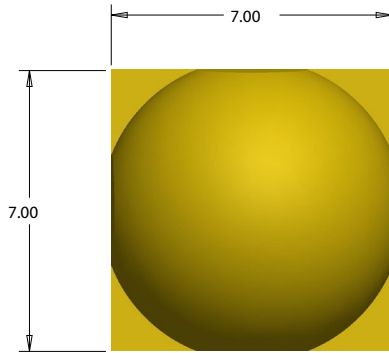

Top View

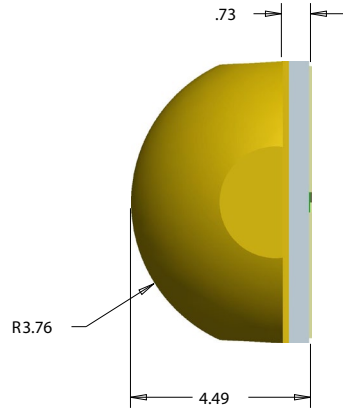

Side View

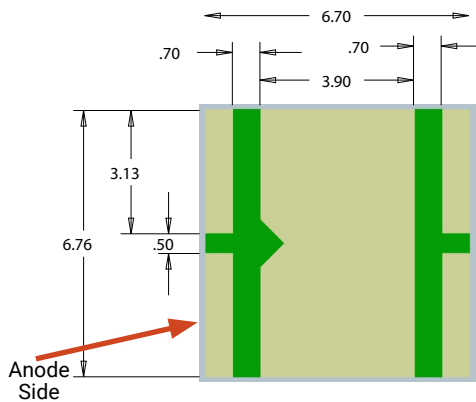

Bottom View

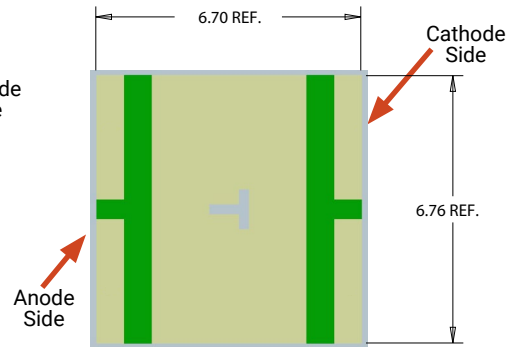

Alternate Bottom View

As shown in these bottom views, thermal pad is electrically isolated

MECHANICAL DIMENSIONS - CONTINUED

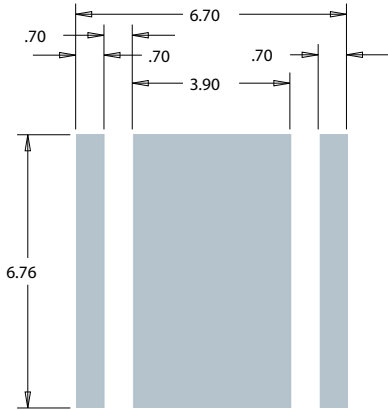

Recommended PCB Solder Pad 6 V Configuration
(thermal pad is electrically isolated)

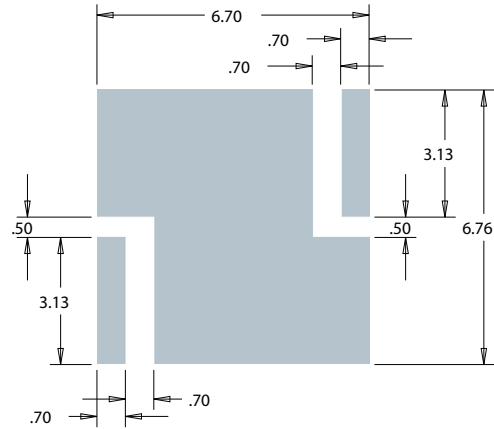

Recommended PCB Solder Pad 12 V Configuration
(thermal pad is connected to anode and cathode and is not electrically isolated)

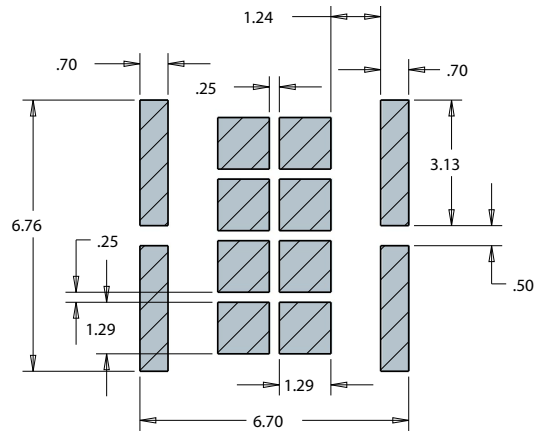

Recommended Stencil Pattern
6 V & 12 V Configurations
(shaded area is open)

ELECTRICAL CONFIGURATION

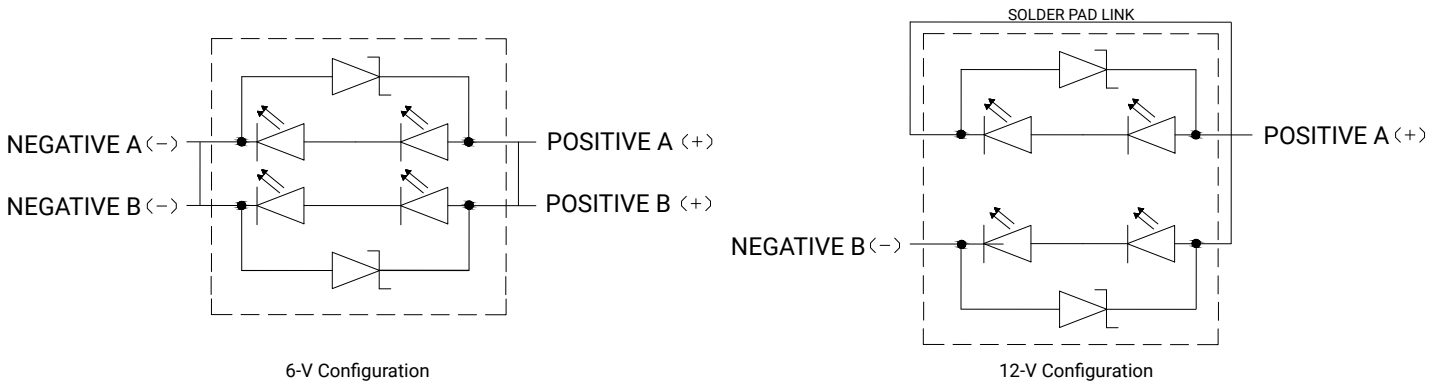

TAPE AND REEL

All Cree carrier tapes conform to EIA-481D, Automated Component Handling Systems Standard.
All dimensions are ±.13 mm unless otherwise indicated.

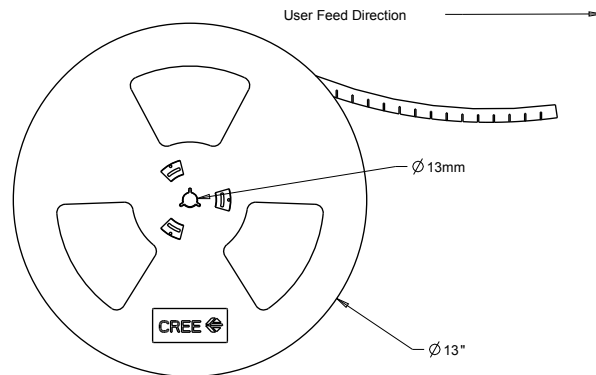
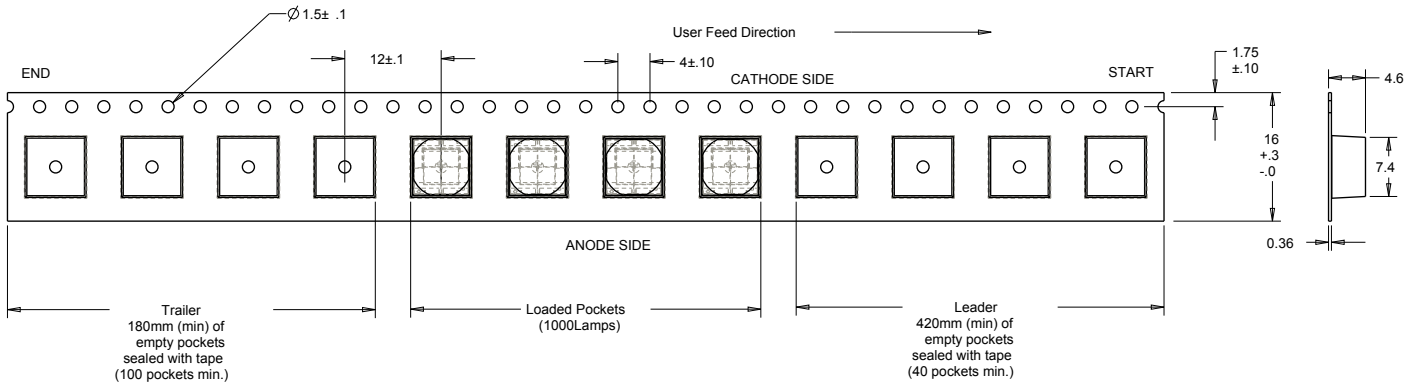

PACKAGING

Unpackaged Reel

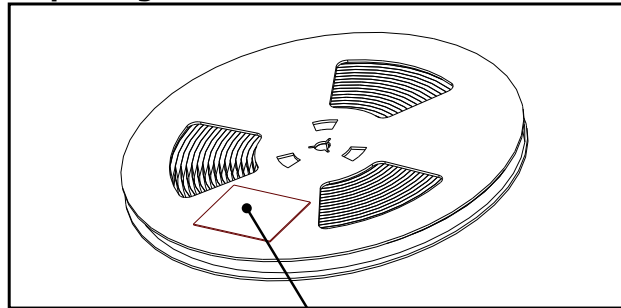

Label with Cree Bin Code,
Quantity, Reel ID

Packaged Reel

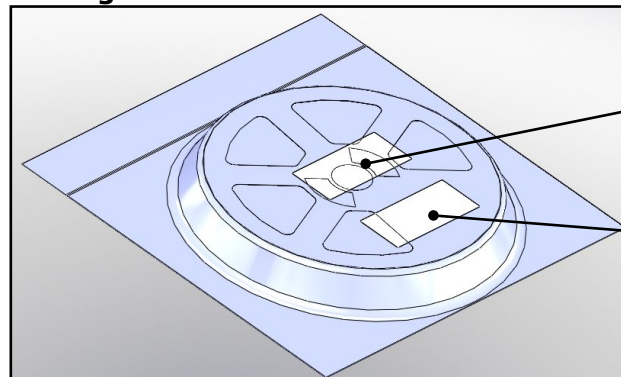

Label with Cree Order Code,
Quantity, Reel ID, PO #

Label with Cree Bin Code,
Quantity, Reel ID

Boxed Reel

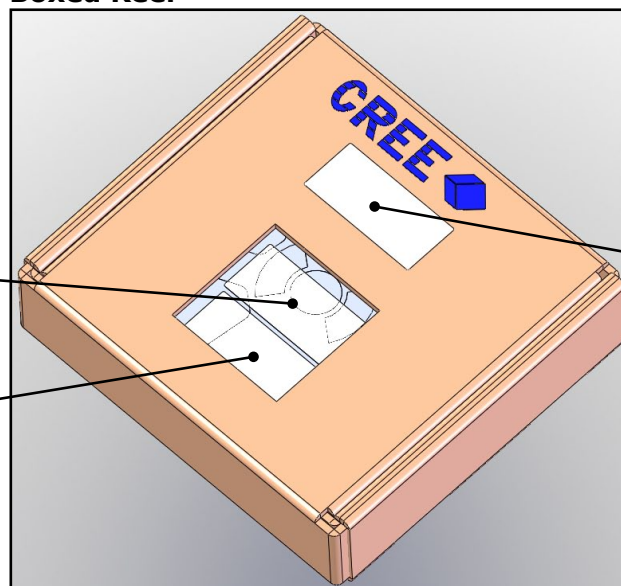

Label with Cree Order Code,
Quantity, Reel ID, PO #

Label with Cree Bin Code,
Quantity, Reel ID

Patent Label

X-ON Electronics

Largest Supplier of Electrical and Electronic Components

Click to view similar products for [High Power LEDs - White category:](#)

Click to view products by [Cree manufacturer:](#)

Other Similar products are found below :

[G42180-08](#) [B42180-08](#) [STW8Q2PA-R5-HA](#) [SZ5-M1-W0-00-V3/W2-AA](#) [LTPL-P00DWS57](#) [LZP-D0WW00-0000](#) [CLM-9-30-90-36-AC32-F4-3](#) [SZ5-M1-WW-C8-V1/V3-FA](#) [BXRC-27E2000-D-73](#) [BXRC-27G2000-D-73](#) [BXRC-30E1000-D-73](#) [BXRC-30G2000-D-73](#) [BXRC-40E1000-D-73](#) [BXRE-30G2000-B-73](#) [BXRE-30G2000-C-73](#) [BXRE-50C2001-C-74](#) [CXM-22-27-80-54-AC30-F4-3](#) [XHP50B-00-0000-0D0UH245G](#) [XHP50B-00-0000-0D0UH240G](#) [XHP50B-00-0000-0D0HJ245G](#) [MP-5050-8100-27-80](#) [MP-5050-6100-65-80](#) [MP-5050-6100-50-80](#) [MP-5050-6100-40-80](#) [MP-5050-6100-30-80](#) [CXM-22-30-80-54-AC30-F4-3](#) [LTW-2835SZK57](#) [BXEM-50C0000-0-000](#) [WW-WNA30TS-U1\(M1\)](#) [KW CSLPM2.CC-8L8M-4L8N](#) [KW CSLPM2.CC-8L8M-4O9Q](#) [KW DPLS32.SB-6H6J-E5P7-EG-Z264](#) [L1V1-507003V500000](#) [CXM-22-35-80-36-AC10-F3-3](#) [KW3 CGLNM1.TG-Z6QF6-EBVFFCBB46-DFGA](#) [JB5630AWT-H-H65EA0000-NZ000001](#) [XHP50B-00-0000-0D0UG430H](#) [CXM-22-35-90-54-AC40-F5-3](#) [CXM-22-35-80-54-AC40-F5-3](#) [OSM51206E1N-0.8T](#) [OSW43020C1C](#) [MP161611032290](#) [MP-1616-2103-50-90](#) [KW CULPM1.TG-Z6RF7-ebvFfcbB46-65G5](#) [KW DMLS33.SG-Z6M7-EBVFFCBB46-8E8G-700-S](#) [XPGDWT-B1-0000-00EEA](#) [XHP70B-00-0000-0D0BP450E](#) [KW DMLN33.SG-7J7K-EBVFFCBB46-8E8G-200-S](#) [ASMT-MW05-NMNS1](#)
[ASMT-MW06-NMNZ1](#)