

Cree® XLamp® XHP50 LEDs

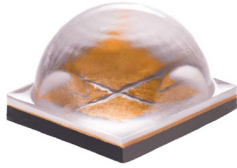

PRODUCT DESCRIPTION

Powered by Cree’s groundbreaking SC5 Technology™ Platform, the XLamp® XHP50 LED is a member of Cree’s Extreme High Power (XHP) class of LEDs that redefines lumen density and reliability to radically reduce system costs by up to 40 percent. At its maximum current, the XHP50 LED delivers twice the light output of the industry’s brightest single-die LED, the XLamp XM-L2 LED, with similar lumens per watt and without increasing the package footprint. The XHP50 LED also achieves longer lifetime at higher operating temperatures than previous LED technology. The result is significantly lower thermal, mechanical and optical costs at the system level.

FEATURES

- Available in white, configurable to 6 V or 12 V by PCB layout
- Available in 5-step EasyWhite® bins at 3000 K to 5000 K CCT, 3-step EasyWhite bins at 2700 K to 5000 K and 2-step EasyWhite bins at 2700 K to 4000 K CCT
- Available in ANSI white bins at 3000 K to 7000 K CCT
- Available in standard, 70-, 80-, and 90-minimum CRI options
- Binned at 85 °C
- Maximum drive current: 3000 mA (6 V), 1500 mA (12 V)
- Low thermal resistance: 1.2 °C/W
- Wide viewing angle: 120°
- Unlimited floor life at ≤ 30 °C/85% RH
- Reflow solderable - JEDEC J-STD-020C
- RoHS and REACH compliant
- UL® recognized component (E349212)

TABLE OF CONTENTS

Characteristics	2
Flux Characteristics, EasyWhite® Order Codes and Bins	3
Flux Characteristics, ANSI White Order Codes and Bins	7
Relative Spectral Power Distribution	11
Relative Flux vs. Junction Temperature....	11
Electrical Characteristics.....	12
Relative Flux vs. Current.....	13
Relative Chromaticity vs Current.....	14
Relative Chromaticity vs Temperature.....	15
Typical Spatial Distribution.....	15
Thermal Design.....	16
Performance Groups – Luminous Flux.....	17
Performance Groups – Chromaticity.....	17
Cree’s Standard White Chromaticity Regions Plotted on the 1931 CIE Curve....	21
Cree’s Standard Cool White Kits Plotted on ANSI Standard Chromaticity Regions..	24
Cree’s Standard Warm and Neutral White Kits Plotted on ANSI Standard Chromaticity Regions	25
Bin and Order-Code Formats.....	26
Reflow Soldering Characteristics.....	27
Notes	28
Mechanical Dimensions	30
Electrical Configuration	32
Tape and Reel.....	32
Packaging.....	33



CHARACTERISTICS

XHP50 LEDs are tested and binned in production in the 12-V configuration. See the Mechanical Dimensions section on page 30 for pad layout options.

Characteristics	Unit	Minimum	Typical	Maximum
Thermal resistance, junction to solder point	°C/W		1.2	
Viewing angle (FWHM)	degrees		120	
Temperature coefficient of voltage (6 V)*	mV/°C		-4.5	
Temperature coefficient of voltage (12 V)	mV/°C		-9	
ESD withstand voltage (HBM per Mil-Std-883D)	V			8000
DC forward current (6 V)*	mA			3000
DC forward current (12 V)	mA			1500
Reverse voltage	V			-5
Forward voltage (6 V, @ 1400 mA, 85 °C)*	V		5.75	6.3
Forward voltage (12 V, @ 700 mA, 85 °C)	V		11.5	12.6
LED junction temperature	°C			150

Note:

* Data for the 6-V configuration is calculated and for reference only.

FLUX CHARACTERISTICS, EASYWHITE® ORDER CODES AND BINS

The following table provides order codes for XLamp XHP50 LEDs. For a complete description of how the flux and chromaticity groups are reflected in the bin code and order code nomenclature, please see the Bin and Order Code Formats section (page 26).

Binning condition: $T_j = 85\text{ }^\circ\text{C}$; 12 V, $I_F = 700\text{ mA}$

Reference condition: $T_j = 85\text{ }^\circ\text{C}$; 6 V, $I_F = 1400\text{ mA}$

Nominal CCT	CRI		Minimum Luminous Flux			2-Step		3-Step		5-Step	
	Min	Typ	Group	Flux (lm) @ 85 °C	Flux (lm) @ 25 °C*	Group	Order Code	Group	Order Code	Group	Order Code
5000 K	70		J4	1120	1284					50E	XHP50A-00-0000-0D0BJ450E
			J2	1040	1192						XHP50A-00-0000-0D0BJ250E
			H4	970	1112						XHP50A-00-0000-0D0BH450E
	80		J2	1040	1192			50G	XHP50A-00-0000-0D0HJ250G		
			H4	970	1112				XHP50A-00-0000-0D0HH450G		
			H2	900	1032				XHP50A-00-0000-0D0HH250G		
	90		H2	900	1032			50G	XHP50A-00-0000-0D0UH250G		
			G4	840	963				XHP50A-00-0000-0D0UG450G		
			G2	780	894				XHP50A-00-0000-0D0UG250G		
			F4	730	837				XHP50A-00-0000-0D0UF450G		
			F2	680	780				XHP50A-00-0000-0D0UF250G		

Notes

- Cree maintains a tolerance of $\pm 7\%$ on flux and power measurements, ± 0.005 on chromaticity (CCx, CCy) measurements and a tolerance of ± 2 on CRI measurements. See the Measurements section (page 28).
- Cree XLamp XHP50 LED order codes specify only a minimum flux bin and not a maximum. Cree may ship reels in flux bins higher than the minimum specified by the order code without advance notice. Shipments will always adhere to the chromaticity bin restrictions specified by the order code.
- * Flux values @ 25 °C are calculated and for reference only.

FLUX CHARACTERISTICS, EASYWHITE® ORDER CODES AND BINS - CONTINUED

Nominal CCT	CRI		Minimum Luminous Flux			2-Step		3-Step		5-Step		
	Min	Typ	Group	Flux (lm) @ 85 °C	Flux (lm) @ 25 °C*	Group	Order Code	Group	Order Code	Group	Order Code	
4500 K	70		J4	1120	1284					45E	XHP50A-00-0000-0D0BJ445E	
			J2	1040	1192						XHP50A-00-0000-0D0BJ245E	
			H4	970	1112						XHP50A-00-0000-0D0BH445E	
	80		H4	970	1112			45G	XHP50A-00-0000-0D0HH445G			
			H2	900	1032				XHP50A-00-0000-0D0HH245G			
			G4	840	963				XHP50A-00-0000-0D0HG445G			
	90		G4	840	963			45G	XHP50A-00-0000-0D0UG445G			
			G2	780	894				XHP50A-00-0000-0D0UG245G			
			F4	730	837				XHP50A-00-0000-0D0UF445G			
			F2	680	780				XHP50A-00-0000-0D0UF245G			
	4000 K	70		J4	1120	1284					40E	XHP50A-00-0000-0D0BJ440E
				J2	1040	1192						XHP50A-00-0000-0D0BJ240E
H4				970	1112	XHP50A-00-0000-0D0BH440E						
80			H4	970	1112	40H	XHP50A-00-0000-0D0HH440H	40G	XHP50A-00-0000-0D0HH440G			
			H2	900	1032	XHP50A-00-0000-0D0HH240H	XHP50A-00-0000-0D0HH240G					
			G4	840	963	XHP50A-00-0000-0D0HG440H	XHP50A-00-0000-0D0HG440G					
90			G4	840	963	40H	XHP50A-00-0000-0D0UG440H	40G	XHP50A-00-0000-0D0UG440G			
			G2	780	894	XHP50A-00-0000-0D0UG240H	XHP50A-00-0000-0D0UG240G					
			F4	730	837	XHP50A-00-0000-0D0UF440H	XHP50A-00-0000-0D0UF440G					
			F2	680	780	XHP50A-00-0000-0D0UF240H	XHP50A-00-0000-0D0UF240G					

- Notes**
- Cree maintains a tolerance of ±7% on flux and power measurements, ±0.005 on chromaticity (CCx, CCy) measurements and a tolerance of ±2 on CRI measurements. See the Measurements section (page 28).
 - Cree XLamp XHP50 LED order codes specify only a minimum flux bin and not a maximum. Cree may ship reels in flux bins higher than the minimum specified by the order code without advance notice. Shipments will always adhere to the chromaticity bin restrictions specified by the order code.
 - * Flux values @ 25 °C are calculated and for reference only.

FLUX CHARACTERISTICS, EASYWHITE® ORDER CODES AND BINS - CONTINUED

Nominal CCT	CRI		Minimum Luminous Flux			2-Step		3-Step		5-Step		
	Min	Typ	Group	Flux (lm) @ 85 °C	Flux (lm) @ 25 °C*	Group	Order Code	Group	Order Code	Group	Order Code	
3500 K	70		H4	970	1112					35E	XHP50A-00-0000-0D0BH435E	
			H2	900	1032						XHP50A-00-0000-0D0BH235E	
	80		H4	970	1112	35H	XHP50A-00-0000-0D0HH435H	35G	XHP50A-00-0000-0D0HH435G			
			H2	900	1032		XHP50A-00-0000-0D0HH235H		XHP50A-00-0000-0D0HH235G			
			G4	840	963		XHP50A-00-0000-0D0HG435H		XHP50A-00-0000-0D0HG435G			
	90		G4	840	963	35H	XHP50A-00-0000-0D0UG435H	35G	XHP50A-00-0000-0D0UG435G			
			G2	780	894		XHP50A-00-0000-0D0UG235H		XHP50A-00-0000-0D0UG235G			
			F4	730	837		XHP50A-00-0000-0D0UF435H		XHP50A-00-0000-0D0UF435G			
			F2	680	780		XHP50A-00-0000-0D0UF235H		XHP50A-00-0000-0D0UF235G			
	3000 K	70		H4	970	1112					30E	XHP50A-00-0000-0D0BH430E
				H2	900	1032						XHP50A-00-0000-0D0BH230E
				G4	840	963						XHP50A-00-0000-0D0BG430E
80			H4	970	1112	30H	XHP50A-00-0000-0D0HH430H	30G	XHP50A-00-0000-0D0HH430G			
			H2	900	1032		XHP50A-00-0000-0D0HH230H		XHP50A-00-0000-0D0HH230G			
			G4	840	963		XHP50A-00-0000-0D0HG430H		XHP50A-00-0000-0D0HG430G			
			G2	780	894		XHP50A-00-0000-0D0HG230H		XHP50A-00-0000-0D0HG230G			
90			G2	780	894	30H	XHP50A-00-0000-0D0UG230H	30G	XHP50A-00-0000-0D0UG230G			
			F4	730	837		XHP50A-00-0000-0D0UF430H		XHP50A-00-0000-0D0UF430G			
			F2	680	780		XHP50A-00-0000-0D0UF230H		XHP50A-00-0000-0D0UF230G			
			E4	635	728		XHP50A-00-0000-0D0UE430H		XHP50A-00-0000-0D0UE430G			

- Notes**
- Cree maintains a tolerance of ±7% on flux and power measurements, ±0.005 on chromaticity (CCx, CCy) measurements and a tolerance of ±2 on CRI measurements. See the Measurements section (page 28).
 - Cree XLamp XHP50 LED order codes specify only a minimum flux bin and not a maximum. Cree may ship reels in flux bins higher than the minimum specified by the order code without advance notice. Shipments will always adhere to the chromaticity bin restrictions specified by the order code.
 - * Flux values @ 25 °C are calculated and for reference only.

FLUX CHARACTERISTICS, EASYWHITE® ORDER CODES AND BINS - CONTINUED

Nominal CCT	CRI		Minimum Luminous Flux			2-Step		3-Step		5-Step	
	Min	Typ	Group	Flux (lm) @ 85 °C	Flux (lm) @ 25 °C*	Group	Order Code	Group	Order Code	Group	Order Code
2700 K	80		H2	900	1032	27H	XHP50A-00-0000-0D0HH227H	27G	XHP50A-00-0000-0D0HH227G		
			G4	840	963		XHP50A-00-0000-0D0HG427H		XHP50A-00-0000-0D0HG427G		
			G2	780	894		XHP50A-00-0000-0D0HG227H		XHP50A-00-0000-0D0HG227G		
	90		F4	730	837	27H	XHP50A-00-0000-0D0UF427H	27G	XHP50A-00-0000-0D0UF427G		
			F2	680	780		XHP50A-00-0000-0D0UF227H		XHP50A-00-0000-0D0UF227G		
			E4	635	728		XHP50A-00-0000-0D0UE427H		XHP50A-00-0000-0D0UE427G		

Notes

- Cree maintains a tolerance of $\pm 7\%$ on flux and power measurements, ± 0.005 on chromaticity (CCx, CCy) measurements and a tolerance of ± 2 on CRI measurements. See the Measurements section (page 28).
- Cree XLamp XHP50 LED order codes specify only a minimum flux bin and not a maximum. Cree may ship reels in flux bins higher than the minimum specified by the order code without advance notice. Shipments will always adhere to the chromaticity bin restrictions specified by the order code.
- * Flux values @ 25 °C are calculated and for reference only.

FLUX CHARACTERISTICS, ANSI WHITE ORDER CODES AND BINS

The following table provides order codes for XLamp XHP50 LEDs. For a complete description of how the flux and chromaticity groups are reflected in the bin code and order code nomenclature, please see the Bin and Order Code Formats section (page 26).

Binning condition: $T_j = 85\text{ °C}$; 12 V, $I_f = 700\text{ mA}$

Reference condition: $T_j = 85\text{ °C}$; 6 V, $I_f = 1400\text{ mA}$

Nominal CCT	Chromaticity Regions	CRI		Minimum Luminous Flux			Order Code		
		Min	Typ	Group	Flux (lm) @ 85 °C	Flux (lm) @ 25 °C*			
7000 K	0A, 0B, 0C, 0D, 0R, 0S, 0T, 0U, 1A, 1B, 1C, 1D, 1R, 1S, 1T, 1U	0	68	J4	1120	1284	XHP50A-00-0000-0D00J40DT		
				J2	1040	1192	XHP50A-00-0000-0D00J20DT		
		70		J4	1120	1284	XHP50A-00-0000-0D00BJ40DT		
				J2	1040	1192	XHP50A-00-0000-0D00BJ20DT		
		80			J2	1040	1192	XHP50A-00-0000-0D00HJ20DT	
					H4	970	1112	XHP50A-00-0000-0D00HH40DT	
					H2	900	1032	XHP50A-00-0000-0D00HH20DT	
		90				H2	900	1032	XHP50A-00-0000-0D00UH20DT
						G4	840	963	XHP50A-00-0000-0D00UG40DT
						G2	780	894	XHP50A-00-0000-0D00UG20DT
						F4	730	837	XHP50A-00-0000-0D00UF40DT
		6500 K	0A, 0B, 0C, 0D, 0R, 0S, 0T, 0U, 1A, 1B, 1C, 1D, 1R, 1S, 1T, 1U, 2A, 2B, 2C, 2D, 2R, 2S, 2T, 2U	0	68	J4	1120	1284	XHP50A-00-0000-0D00J40CB
J2	1040					1192	XHP50A-00-0000-0D00J20CB		
70					J4	1120	1284	XHP50A-00-0000-0D00BJ40CB	
					J2	1040	1192	XHP50A-00-0000-0D00BJ20CB	
80					J2	1040	1192	XHP50A-00-0000-0D00HJ20CB	
					H4	970	1112	XHP50A-00-0000-0D00HH40CB	
					H2	900	1032	XHP50A-00-0000-0D00HH20CB	
90						H2	900	1032	XHP50A-00-0000-0D00UH20CB
						G4	840	963	XHP50A-00-0000-0D00UG40CB
						G2	780	894	XHP50A-00-0000-0D00UG20CB
						F4	730	837	XHP50A-00-0000-0D00UF40CB

Notes

- Cree maintains a tolerance of $\pm 7\%$ on flux and power measurements, ± 0.005 on chromaticity (CCx, CCy) measurements and a tolerance of ± 2 on CRI measurements. See the Measurements section (page 28).
- Cree XLamp XHP50 LED order codes specify only a minimum flux bin and not a maximum. Cree may ship reels in flux bins higher than the minimum specified by the order code without advance notice. Shipments will always adhere to the chromaticity bin restrictions specified by the order code.
- * Flux values @ 25 °C are calculated and for reference only.

FLUX CHARACTERISTICS, ANSI WHITE ORDER CODES AND BINS - CONTINUED

Nominal CCT	Chromaticity Regions	CRI		Minimum Luminous Flux			Order Code
		Min	Typ	Group	Flux (lm) @ 85 °C	Flux (lm) @ 25 °C*	
6500 K	1A, 1B, 1C, 1D	0	68	J4	1120	1284	XHP50A-00-0000-0D00J40E1
				J2	1040	1192	XHP50A-00-0000-0D00J20E1
		70		J4	1120	1284	XHP50A-00-0000-0D0BJ40E1
				J2	1040	1192	XHP50A-00-0000-0D0BJ20E1
		80		J2	1040	1192	XHP50A-00-0000-0D0HJ20E1
				H4	970	1112	XHP50A-00-0000-0D0HH40E1
				H2	900	1032	XHP50A-00-0000-0D0HH20E1
		90		H2	900	1032	XHP50A-00-0000-0D0UH20E1
				G4	840	963	XHP50A-00-0000-0D0UG40E1
				G2	780	894	XHP50A-00-0000-0D0UG20E1
				F4	730	837	XHP50A-00-0000-0D0UF40E1
		6000 K	1A, 1B, 1C, 1D, 1R, 1S, 1T, 1U, 2A, 2B, 2C, 2D, 2R, 2S, 2T, 2U	0	68	J4	1120
J2	1040					1192	XHP50A-00-0000-0D00J20DV
70				J4	1120	1284	XHP50A-00-0000-0D0BJ40DV
				J2	1040	1192	XHP50A-00-0000-0D0BJ20DV
80				J2	1040	1192	XHP50A-00-0000-0D0HJ20DV
				H4	970	1112	XHP50A-00-0000-0D0HH40DV
				H2	900	1032	XHP50A-00-0000-0D0HH20DV
90				H2	900	1032	XHP50A-00-0000-0D0UH20DV
				G4	840	963	XHP50A-00-0000-0D0UG40DV
				G2	780	894	XHP50A-00-0000-0D0UG20DV
				F4	730	837	XHP50A-00-0000-0D0UF40DV
5700 K	2A, 2B, 2C, 2D			0	68	J4	1120
		J2	1040			1192	XHP50A-00-0000-0D00J20E2
		70		J4	1120	1284	XHP50A-00-0000-0D0BJ40E2
				J2	1040	1192	XHP50A-00-0000-0D0BJ20E2
		80		J2	1040	1192	XHP50A-00-0000-0D0HJ20E2
				H4	970	1112	XHP50A-00-0000-0D0HH40E2
				H2	900	1032	XHP50A-00-0000-0D0HH20E2
		90		H2	900	1032	XHP50A-00-0000-0D0UH20E2
				G4	840	963	XHP50A-00-0000-0D0UG40E2
				G2	780	894	XHP50A-00-0000-0D0UG20E2
				F4	730	837	XHP50A-00-0000-0D0UF40E2

FLUX CHARACTERISTICS, ANSI WHITE ORDER CODES AND BINS - CONTINUED

Nominal CCT	Chromaticity Regions	CRI		Minimum Luminous Flux			Order Code		
		Min	Typ	Group	Flux (lm) @ 85 °C	Flux (lm) @ 25 °C*			
5000 K	3A, 3B, 3C, 3D	0	68	J4	1120	1284	XHP50A-00-0000-0D00J40E3		
				J2	1040	1192	HP50A-00-0000-0D00J20E3		
				H4	970	1112	XHP50A-00-0000-0D00H40E3		
		70				J4	1120	1284	XHP50A-00-0000-0D0BJ40E3
						J2	1040	1192	XHP50A-00-0000-0D0BJ20E3
						H4	970	1112	XHP50A-00-0000-0D0BH40E3
		80				J2	1040	1192	XHP50A-00-0000-0D0HJ20E3
						H4	970	1112	XHP50A-00-0000-0D0HH40E3
						H2	900	1032	XHP50A-00-0000-0D0HH20E3
		90				H2	900	1032	XHP50A-00-0000-0D0UH20E3
						G4	840	963	XHP50A-00-0000-0D0UG40E3
						G2	780	894	XHP50A-00-0000-0D0UG20E3
						F4	730	837	XHP50A-00-0000-0D0UF40E3
						F2	680	780	XHP50A-00-0000-0D0UF20E3
		4500 K	4A, 4B, 4C, 4D	0	68	J4	1120	1284	XHP50A-00-0000-0D00J40E4
J2	1040					1192	XHP50A-00-0000-0D00J20E4		
H4	970					1112	XHP50A-00-0000-0D00H40E4		
70						J4	1120	1284	XHP50A-00-0000-0D0BJ40E4
						J2	1040	1192	XHP50A-00-0000-0D0BJ20E4
						H4	970	1112	XHP50A-00-0000-0D0BH40E4
80						H4	970	1112	XHP50A-00-0000-0D0HH40E4
						H2	900	1032	XHP50A-00-0000-0D0HH20E4
						G4	840	963	XHP50A-00-0000-0D0HG40E4
90						G4	840	963	XHP50A-00-0000-0D0UG40E4
						G2	780	894	XHP50A-00-0000-0D0UG20E4
						F4	730	837	XHP50A-00-0000-0D0UF40E4
						F2	680	780	XHP50A-00-0000-0D0UF20E4

- Notes**
- Cree maintains a tolerance of ±7% on flux and power measurements, ±0.005 on chromaticity (CCx, CCy) measurements and a tolerance of ±2 on CRI measurements. See the Measurements section (page 28).
 - Cree XLamp XHP50 LED order codes specify only a minimum flux bin and not a maximum. Cree may ship reels in flux bins higher than the minimum specified by the order code without advance notice. Shipments will always adhere to the chromaticity bin restrictions specified by the order code.
 - * Flux values @ 25 °C are calculated and for reference only.

FLUX CHARACTERISTICS, ANSI WHITE ORDER CODES AND BINS - CONTINUED

Nominal CCT	Chromaticity Regions	CRI		Minimum Luminous Flux			Order Code	
		Min	Typ	Group	Flux (lm) @ 85 °C	Flux (lm) @ 25 °C*		
4000 K	5A, 5B, 5C, 5D	0	68	J2	1040	1192	XHP50A-00-0000-0D00J20E5	
				H4	970	1112	XHP50A-00-0000-0D00H40E5	
		70		J2	1040	1192	XHP50A-00-0000-0D00J20E5	
				H4	970	1112	XHP50A-00-0000-0D00H40E5	
		80			H4	970	1112	XHP50A-00-0000-0D00H40E5
					H2	900	1032	XHP50A-00-0000-0D00H20E5
					G4	840	963	XHP50A-00-0000-0D00G40E5
		90			G4	840	963	XHP50A-00-0000-0D00G40E5
					G2	780	894	XHP50A-00-0000-0D00G20E5
					F4	730	837	XHP50A-00-0000-0D00F40E5
					F2	680	780	XHP50A-00-0000-0D00F20E5
		3500 K	6A, 6B, 6C, 6D	70		J2	1040	1192
H4	970					1112	XHP50A-00-0000-0D00H40E6	
H2	900					1032	XHP50A-00-0000-0D00H20E6	
3000 K	7A, 7B, 7C, 7D	70		J2	1040	1192	XHP50A-00-0000-0D00J20E7	
				H4	970	1112	XHP50A-00-0000-0D00H40E7	
				H2	900	1032	XHP50A-00-0000-0D00H20E7	
				G4	840	963	XHP50A-00-0000-0D00G40E7	

- Notes**
- Cree maintains a tolerance of ±7% on flux and power measurements, ±0.005 on chromaticity (CCx, CCy) measurements and a tolerance of ±2 on CRI measurements. See the Measurements section (page 28).
 - Cree XLamp XHP50 LED order codes specify only a minimum flux bin and not a maximum. Cree may ship reels in flux bins higher than the minimum specified by the order code without advance notice. Shipments will always adhere to the chromaticity bin restrictions specified by the order code.
 - * Flux values @ 25 °C are calculated and for reference only.

RELATIVE SPECTRAL POWER DISTRIBUTION

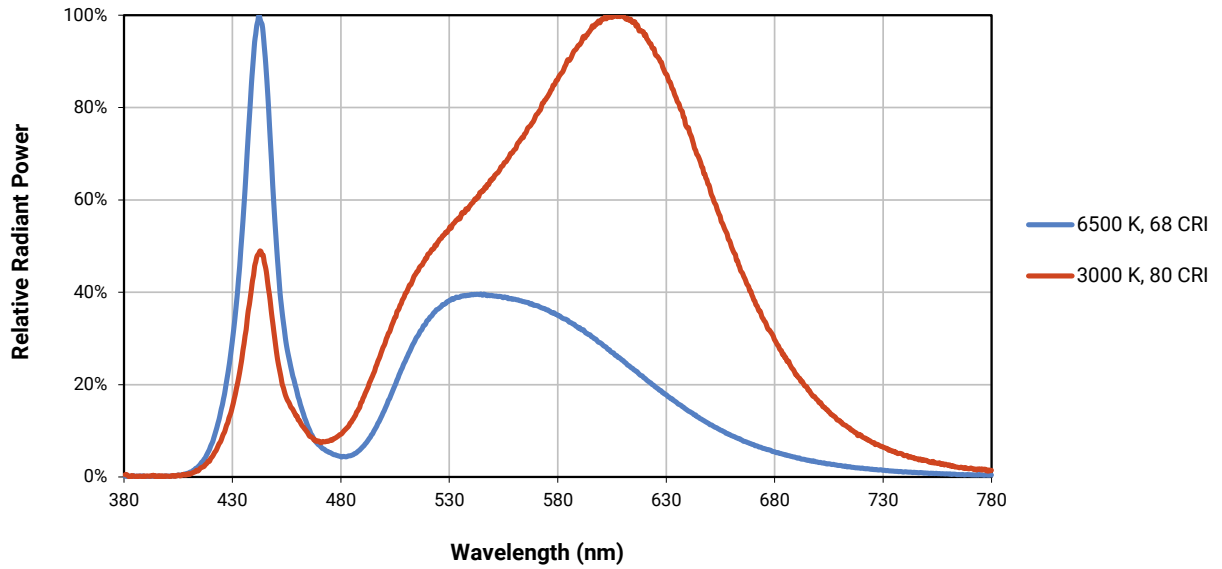

RELATIVE FLUX VS. JUNCTION TEMPERATURE

Reference condition: 6 V, $I_F = 1400$ mA; 12 V, $I_F = 700$ mA

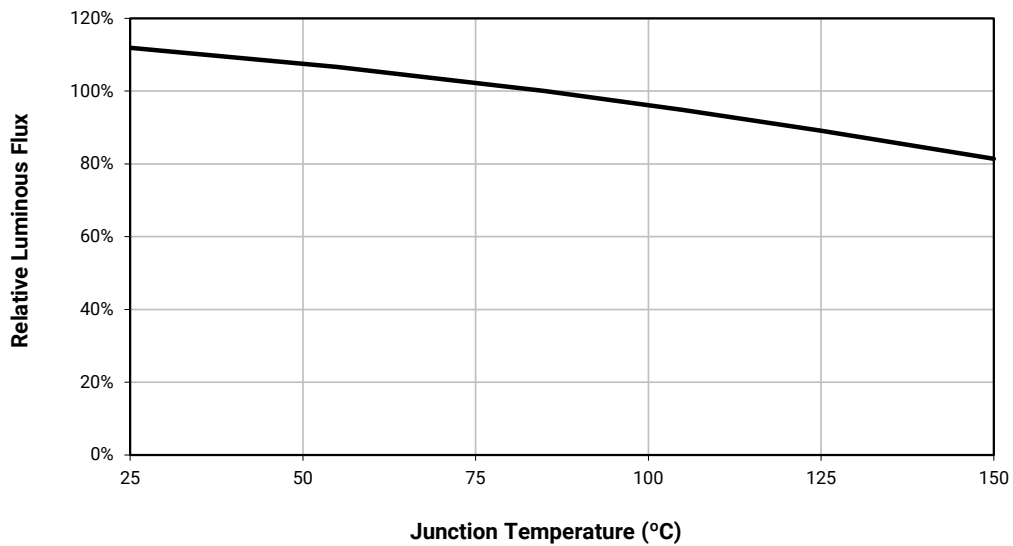

ELECTRICAL CHARACTERISTICS ($T_j = 85^\circ\text{C}$)

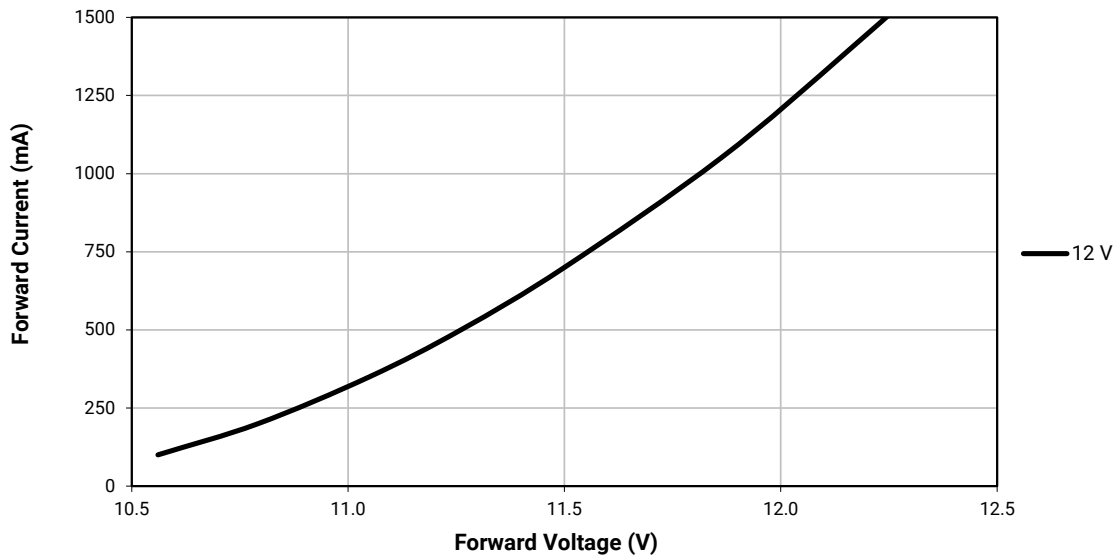
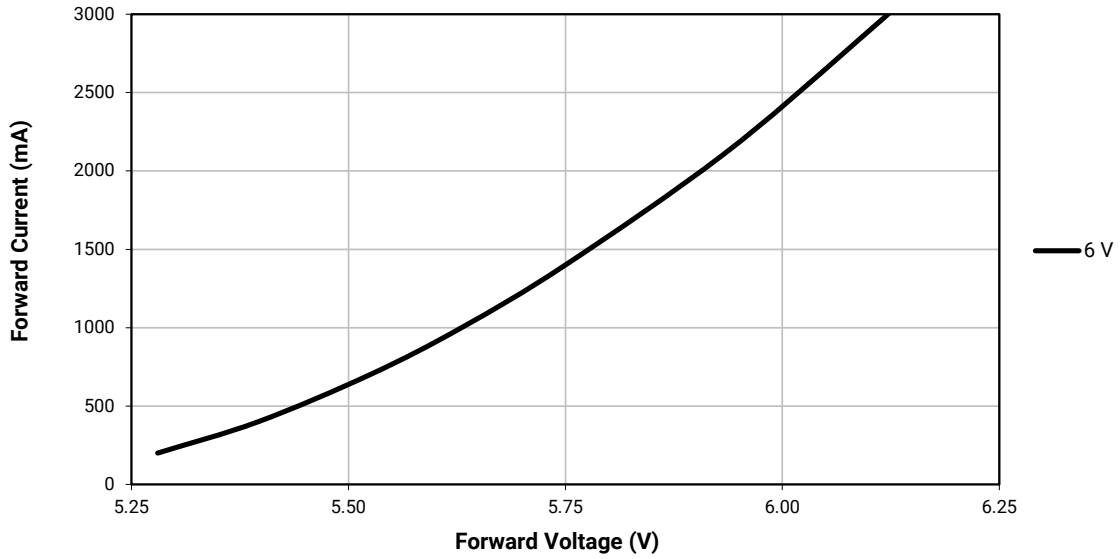

RELATIVE FLUX VS. CURRENT ($T_j = 85\text{ }^\circ\text{C}$)

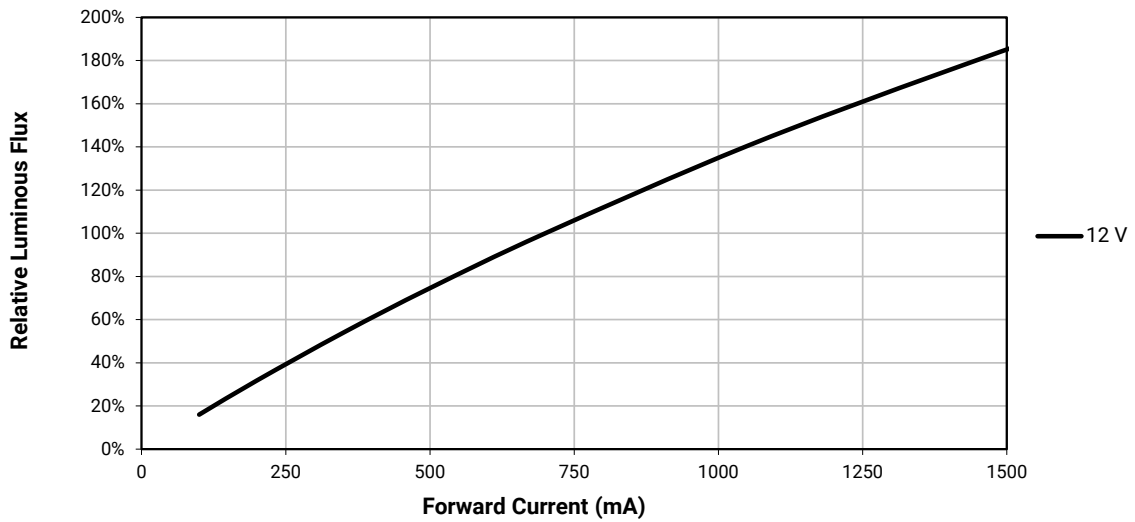
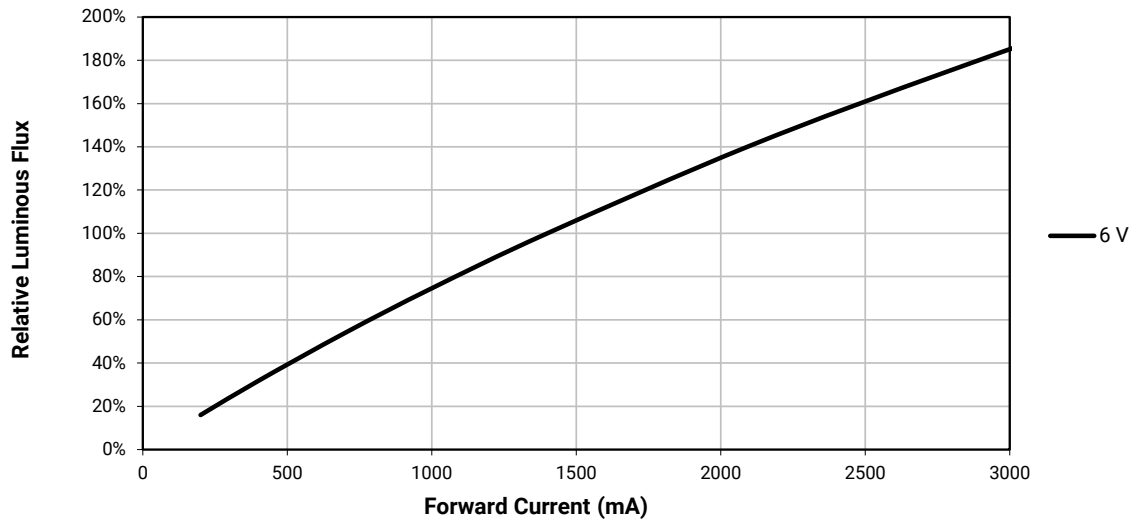

RELATIVE CHROMATICITY VS CURRENT (WARM WHITE)

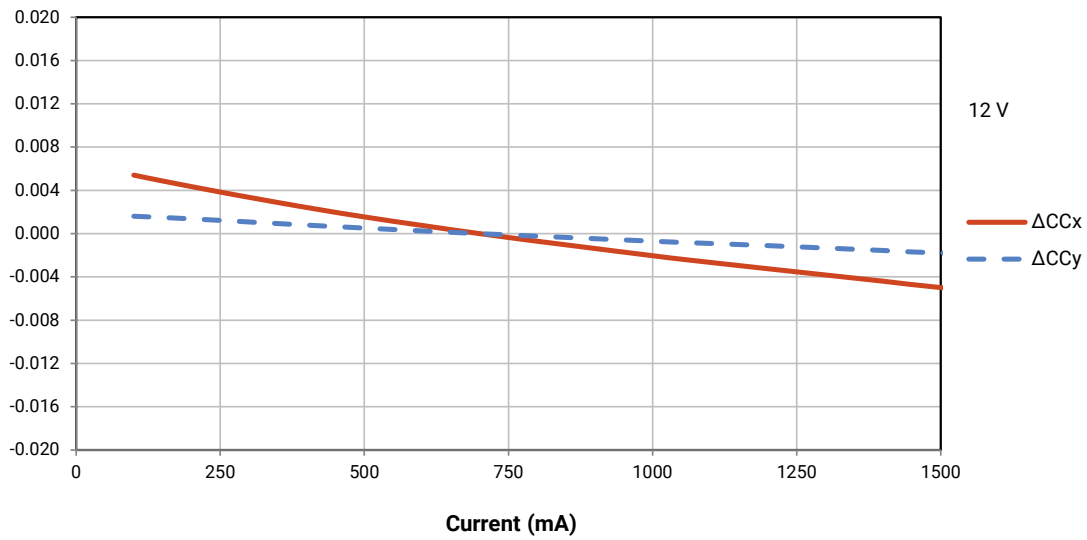
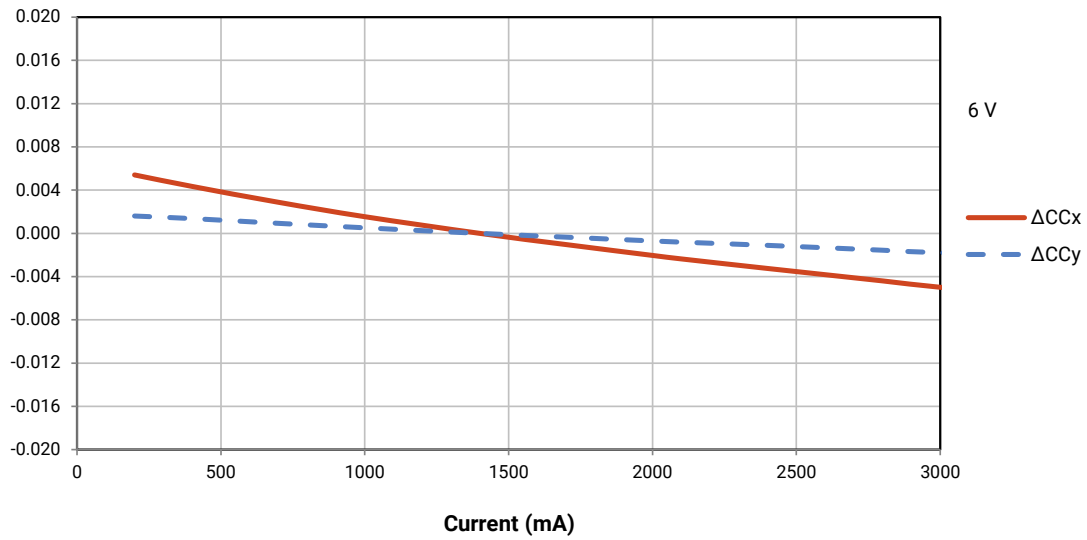

RELATIVE CHROMATICITY VS TEMPERATURE (WARM WHITE)

Reference condition: 6 V, $I_F = 1400$ mA; 12 V, $I_F = 700$ mA

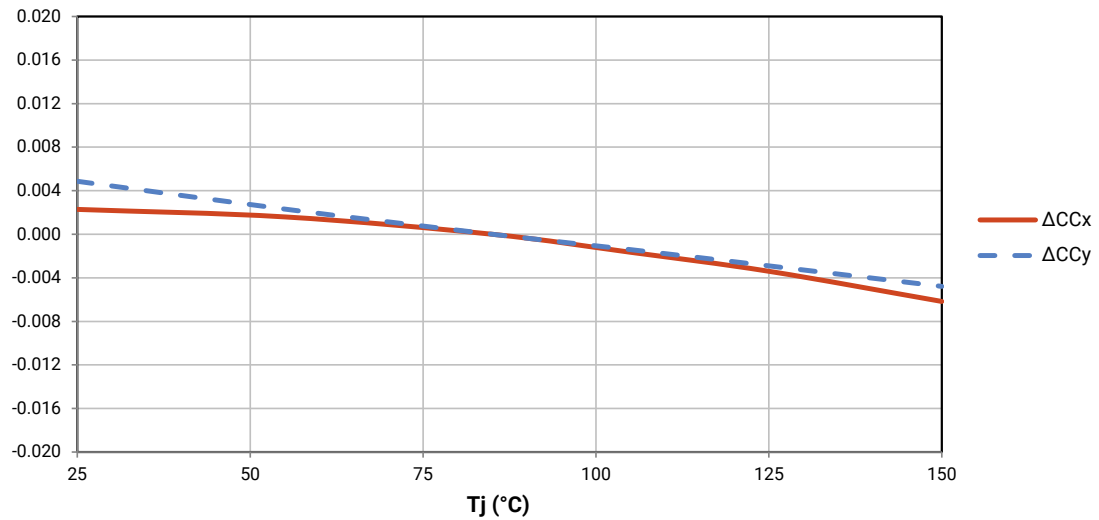

TYPICAL SPATIAL DISTRIBUTION

Reference condition: $T_J = 85$ °C; 6 V, $I_F = 1400$ mA; 12 V, $I_F = 700$ mA

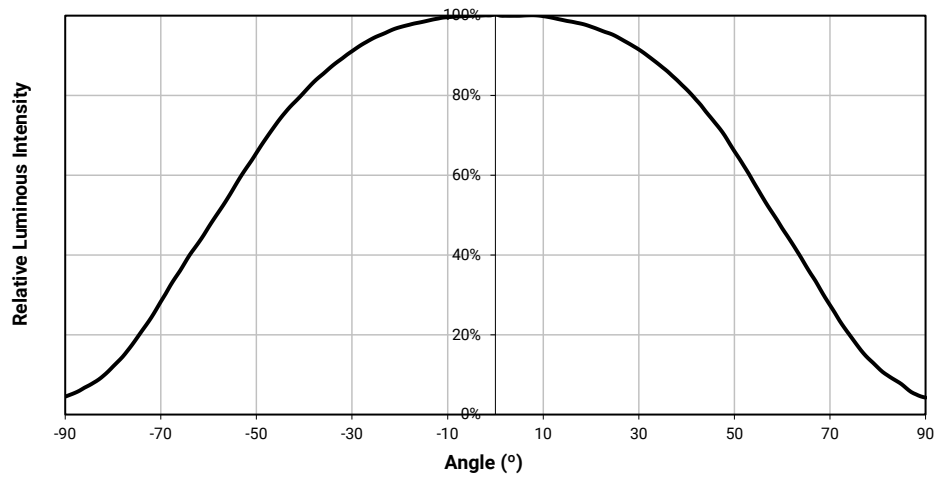

THERMAL DESIGN

The maximum forward current is determined by the thermal resistance between the LED junction and ambient. It is crucial for the end product to be designed in a manner that minimizes the thermal resistance from the solder point to ambient in order to optimize lamp life and optical characteristics.

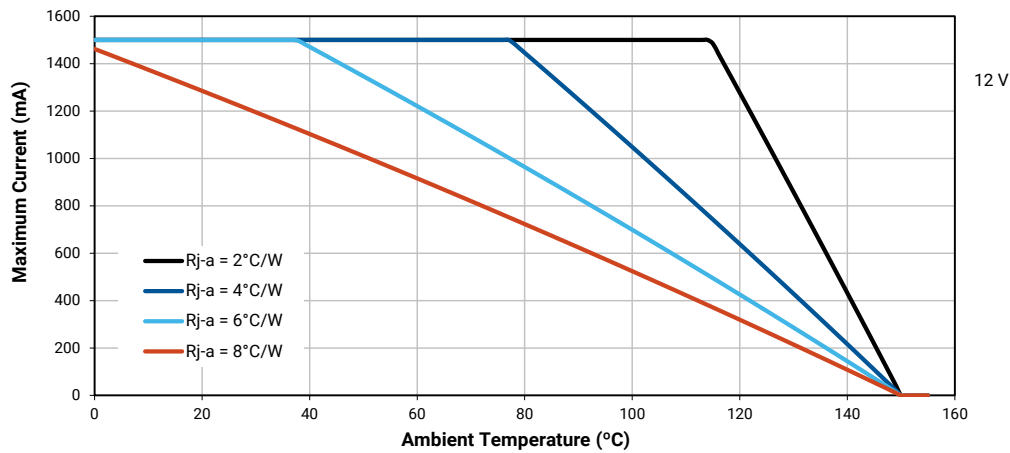
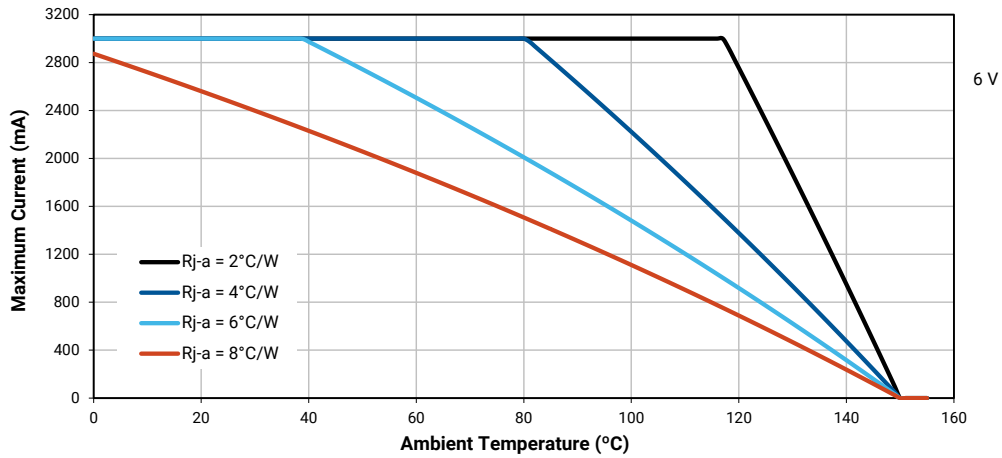

PERFORMANCE GROUPS – LUMINOUS FLUX ($T_j = 85\text{ °C}$)

XLamp XHP50 LEDs are tested for luminous flux and placed into one of the following luminous-flux groups.

Group Code	Minimum Luminous Flux	Maximum Luminous Flux
E4	635	680
F2	680	730
F4	730	780
G2	780	840
G4	840	900
H2	900	970
H4	970	1040
J2	1040	1120
J4	1120	1200

PERFORMANCE GROUPS – CHROMATICITY

XLamp XHP50 LEDs are tested for chromaticity and placed into one of the regions defined by the following bounding coordinates.

EasyWhite Color Temperatures – 2-Step			
Bin Code	CCT	x	y
40H	4000 K	0.3777	0.3739
		0.3797	0.3816
		0.3861	0.3855
		0.3838	0.3777
35H	3500 K	0.4022	0.3858
		0.4053	0.3942
		0.4125	0.3977
		0.4091	0.3891
30H	3000 K	0.4287	0.3975
		0.4328	0.4064
		0.4390	0.4086
		0.4347	0.3996
27H	2700 K	0.4524	0.4048
		0.4574	0.4140
		0.4633	0.4154
		0.4581	0.4062

PERFORMANCE GROUPS – CHROMATICITY (CONTINUED)

EasyWhite Color Temperatures – 3-Step Ellipse						
Bin Code	CCT	Center Point		Major Axis	Minor Axis	Rotation Angle (°)
		x	y	a	b	
50G	5000 K	0.3447	0.3553	0.00840	0.00312	65.0
45G	4500 K	0.3611	0.3658	0.00852	0.00330	61.5
40G	4000 K	0.3818	0.3797	0.00939	0.00402	53.7
35G	3500 K	0.4073	0.3917	0.00927	0.00414	54.0
30G	3000 K	0.4338	0.4030	0.00834	0.00408	53.2
27G	2700 K	0.4577	0.4099	0.00834	0.00420	48.5

EasyWhite Color Temperatures – 5-Step Ellipse						
Bin Code	CCT	Center Point		Major Axis	Minor Axis	Rotation Angle (°)
		x	y	a	b	
50E	5000 K	0.3447	0.3553	0.01400	0.00520	65.0
45E	4500 K	0.3611	0.3658	0.01420	0.00550	61.5
40E	4000 K	0.3818	0.3797	0.01565	0.00670	53.7
35E	3500 K	0.4073	0.3917	0.01545	0.00690	54.0
30E	3000 K	0.4338	0.4030	0.01390	0.00680	53.2

ANSI White Bins			
CCT	Bin Code	x	y
7000 K	0A0	0.2950	0.2970
		0.2920	0.3060
		0.2984	0.3133
		0.3009	0.3042
	0B0	0.2920	0.3060
		0.2895	0.3135
		0.2962	0.3220
		0.2984	0.3133
	0C0	0.2984	0.3133
		0.2962	0.3220
		0.3028	0.3304
		0.3048	0.3207
	0D0	0.2984	0.3133
		0.3048	0.3207
		0.3068	0.3113
		0.3009	0.3042

ANSI White Bins			
CCT	Bin Code	x	y
7000 K	0R0	0.2980	0.2880
		0.2950	0.2970
		0.3009	0.3042
		0.3037	0.2937
	0S0	0.2895	0.3135
		0.2870	0.3210
		0.2937	0.3312
		0.2962	0.3220
	0T0	0.2962	0.3220
		0.2937	0.3312
		0.3005	0.3415
		0.3028	0.3304
	0U0	0.3037	0.2937
		0.3009	0.3042
		0.3068	0.3113
		0.3093	0.2993

ANSI White Bins			
CCT	Bin Code	x	y
7000 K	1A0	0.3048	0.3207
		0.3130	0.3290
		0.3144	0.3186
		0.3068	0.3113
	1B0	0.3028	0.3304
		0.3115	0.3391
		0.3130	0.3290
		0.3048	0.3207
	1C0	0.3115	0.3391
		0.3205	0.3481
		0.3213	0.3373
		0.3130	0.3290
	1D0	0.3130	0.3290
		0.3213	0.3373
		0.3221	0.3261
		0.3144	0.3186

PERFORMANCE GROUPS – CHROMATICITY (CONTINUED)

ANSI White Bins			
CCT	Bin Code	x	y
7000 K	1R0	0.3068	0.3113
		0.3144	0.3186
		0.3161	0.3059
		0.3093	0.2993
	1S0	0.3005	0.3415
		0.3099	0.3509
		0.3115	0.3391
		0.3028	0.3304
	1T0	0.3099	0.3509
		0.3196	0.3602
		0.3205	0.3481
		0.3115	0.3391
	1U0	0.3144	0.3186
		0.3221	0.3261
		0.3231	0.3120
		0.3161	0.3059

ANSI White Bins			
CCT	Bin Code	x	y
6000 K	2A0	0.3215	0.3350
		0.3290	0.3417
		0.3290	0.3300
		0.3222	0.3243
	2B0	0.3207	0.3462
		0.3290	0.3538
		0.3290	0.3417
		0.3215	0.3350
	2C0	0.3290	0.3538
		0.3376	0.3616
		0.3371	0.3490
		0.3290	0.3417
	2D0	0.3290	0.3417
		0.3371	0.3490
		0.3366	0.3369
		0.3290	0.3300

ANSI White Bins			
CCT	Bin Code	x	y
6000 K	2R0	0.3222	0.3243
		0.3290	0.3300
		0.3290	0.3180
		0.3231	0.3120
	2S0	0.3196	0.3602
		0.3290	0.3690
		0.3290	0.3538
		0.3207	0.3462
	2T0	0.3290	0.3690
		0.3381	0.3762
		0.3376	0.3616
		0.3290	0.3538
	2U0	0.3290	0.3300
		0.3366	0.3369
		0.3361	0.3245
		0.3290	0.3180

ANSI White Bins			
CCT	Bin Code	x	y
5000 K	3A0	0.3371	0.3490
		0.3451	0.3554
		0.3440	0.3427
		0.3366	0.3369
	3B0	0.3376	0.3616
		0.3463	0.3687
		0.3451	0.3554
		0.3371	0.3490
	3C0	0.3463	0.3687
		0.3551	0.3760
		0.3533	0.3620
		0.3451	0.3554
	3D0	0.3451	0.3554
		0.3533	0.3620
		0.3515	0.3487
		0.3440	0.3427

ANSI White Bins			
CCT	Bin Code	x	y
4500 K	4A0	0.3530	0.3597
		0.3615	0.3659
		0.3512	0.3465
		0.3515	0.3487
	4B0	0.3548	0.3736
		0.3641	0.3804
		0.3530	0.3597
		0.3533	0.362
	4C0	0.3641	0.3804
		0.3736	0.3874
		0.3702	0.3722
		0.3615	0.3659
	4D0	0.3615	0.3659
		0.3702	0.3722
		0.3670	0.3578
		0.3590	0.3521

PERFORMANCE GROUPS – CHROMATICITY (CONTINUED)

ANSI White Bins			
CCT	Bin Code	x	y
4000 K	5A0	0.3670	0.3578
		0.3702	0.3722
		0.3825	0.3798
		0.3783	0.3646
	5B0	0.3702	0.3722
		0.3736	0.3874
		0.3869	0.3958
		0.3825	0.3798
	5C0	0.3825	0.3798
		0.3869	0.3958
		0.4006	0.4044
		0.3950	0.3875
	5D0	0.3783	0.3646
		0.3825	0.3798
		0.3950	0.3875
		0.3898	0.3716

ANSI White Bins			
CCT	Bin Code	x	y
3500 K	6A0	0.3889	0.3690
		0.3941	0.3848
		0.4080	0.3916
		0.4017	0.3751
	6B0	0.3941	0.3848
		0.3996	0.4015
		0.4146	0.4089
		0.4080	0.3916
	6C0	0.4080	0.3916
		0.4146	0.4089
		0.4299	0.4165
		0.4221	0.3984
	6D0	0.4017	0.3751
		0.4080	0.3916
		0.4221	0.3984
		0.4147	0.3814

ANSI White Bins			
CCT	Bin Code	x	y
3000 K	7A0	0.4147	0.3814
		0.4221	0.3984
		0.4342	0.4028
		0.4259	0.3853
	7B0	0.4221	0.3984
		0.4299	0.4165
		0.4430	0.4212
		0.4342	0.4028
	7C0	0.4342	0.4028
		0.4430	0.4212
		0.4562	0.4260
		0.4465	0.4071
	7D0	0.4259	0.3853
		0.4342	0.4028
		0.4465	0.4071
		0.4373	0.3893

CREE'S STANDARD WHITE CHROMATICITY REGIONS PLOTTED ON THE 1931 CIE CURVE

ANSI Cool White

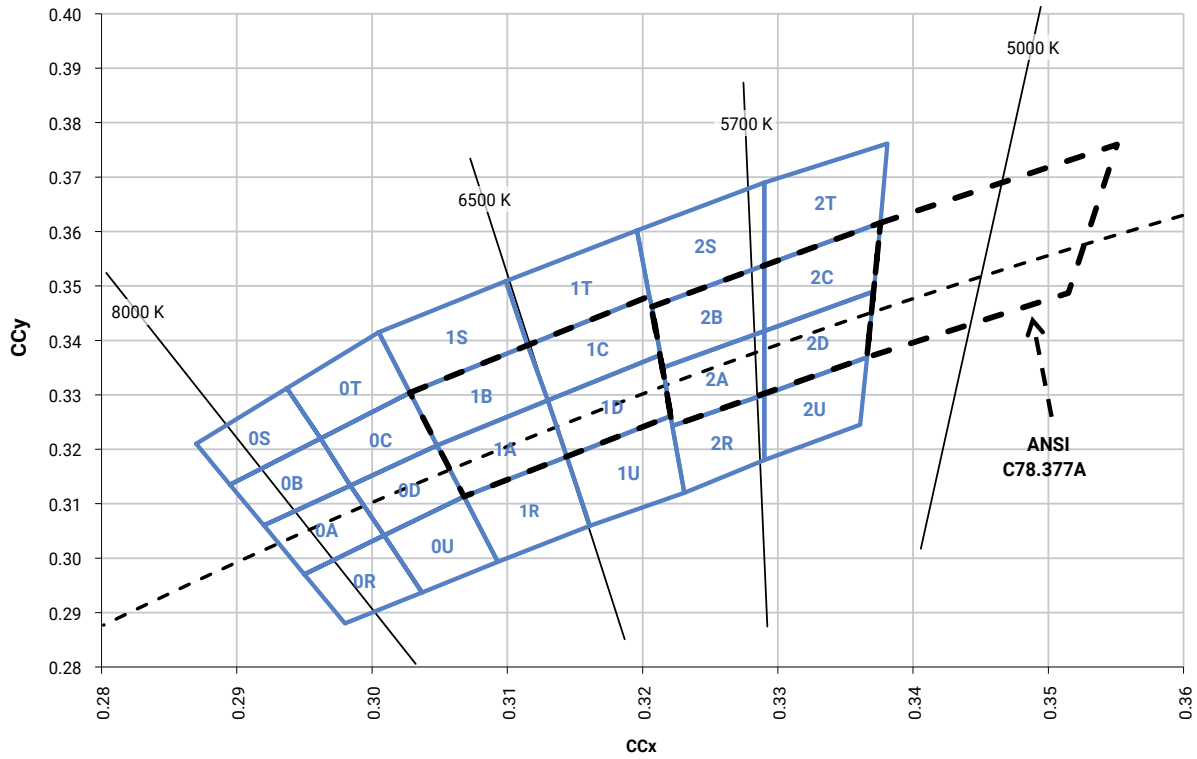

CREE'S STANDARD WHITE CHROMATICITY REGIONS PLOTTED ON THE 1931 CIE CURVE - CONTINUED

ANSI Neutral White and ANSI Warm White

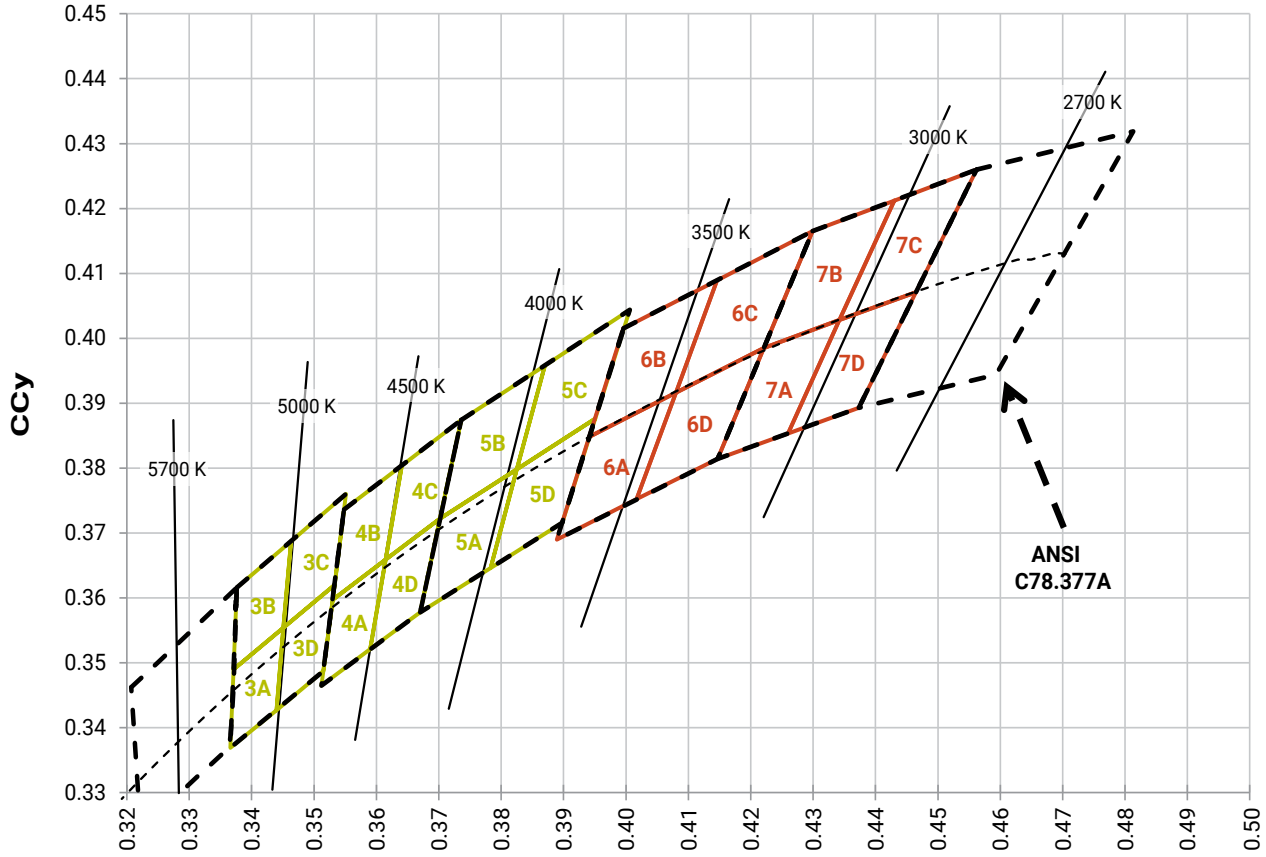

CREE'S STANDARD WHITE CHROMATICITY REGIONS PLOTTED ON THE 1931 CIE CURVE - CONTINUED

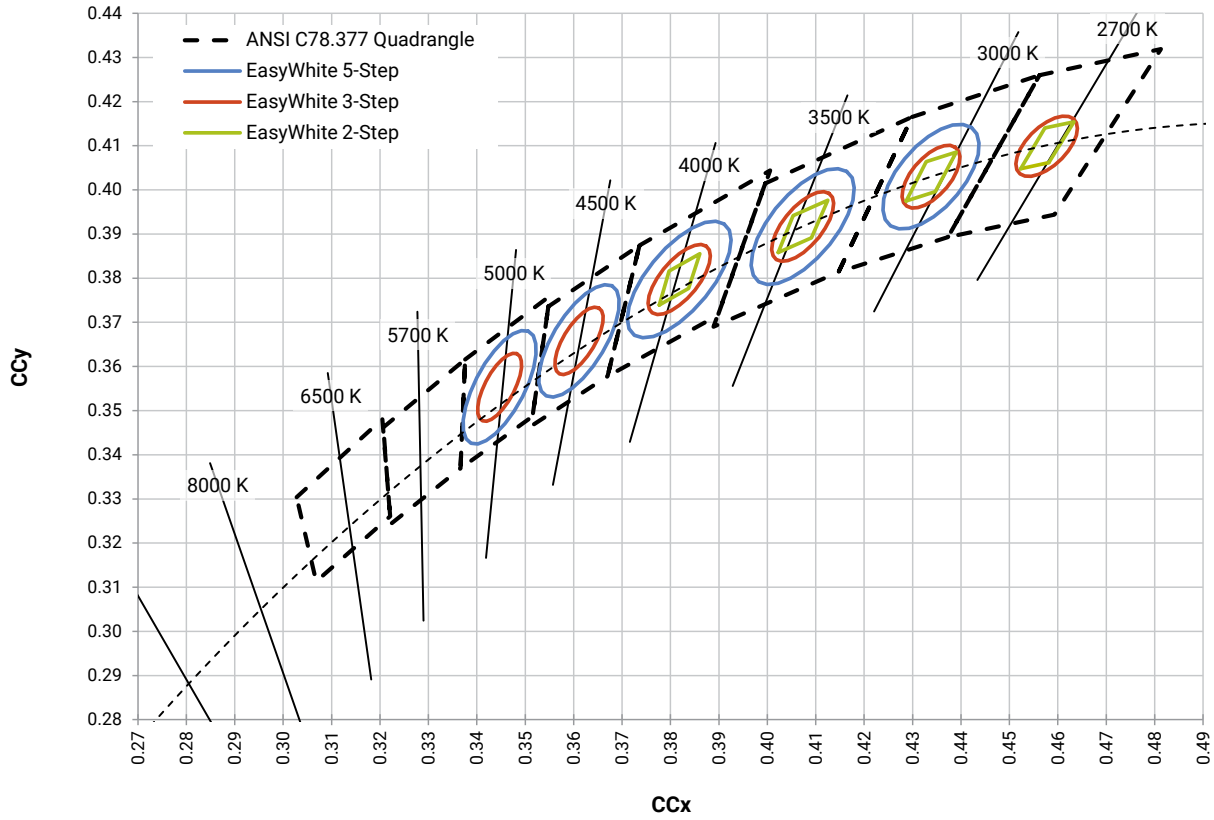

CREE'S STANDARD COOL WHITE KITS PLOTTED ON ANSI STANDARD CHROMATICITY REGIONS

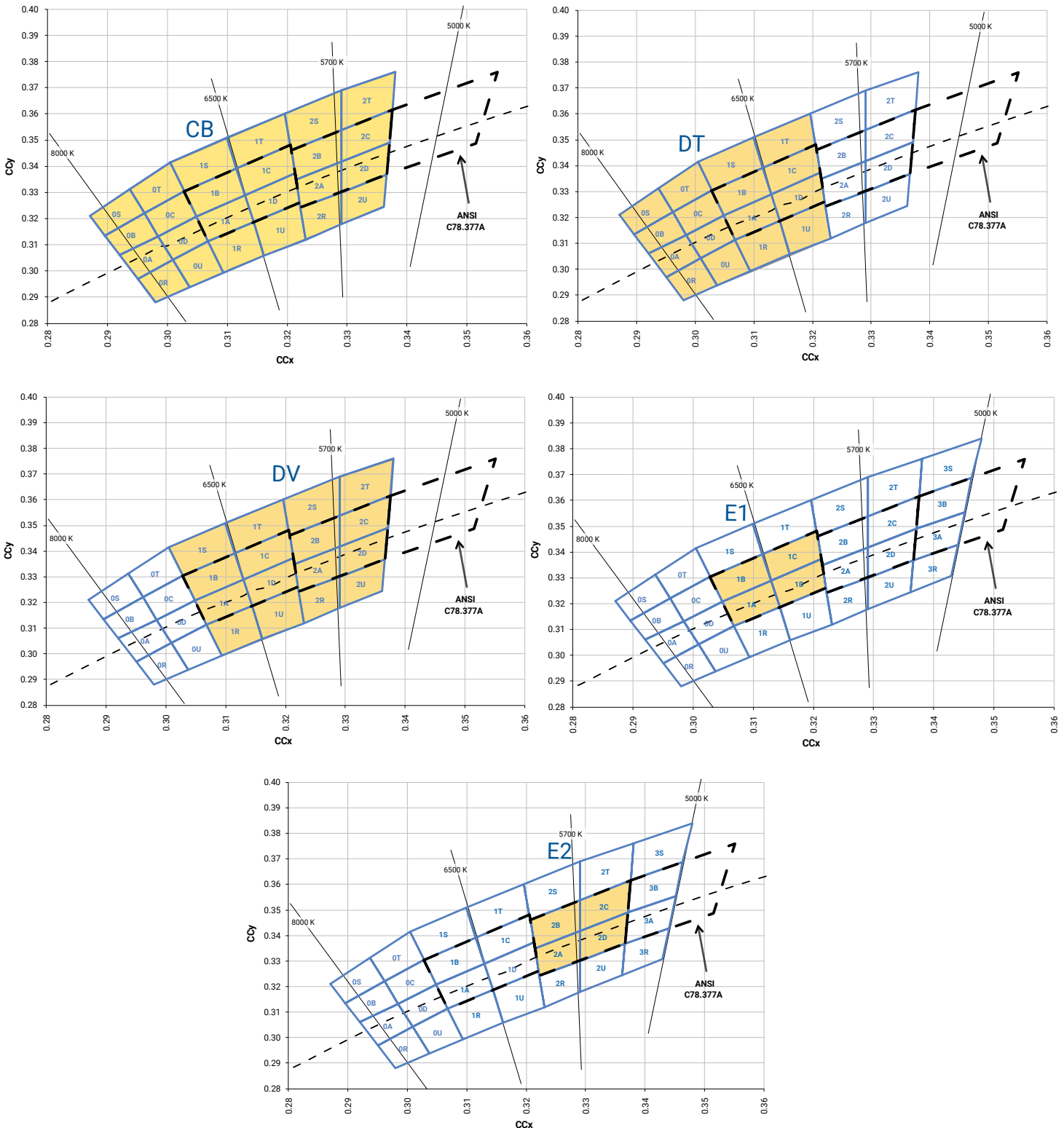

CREE'S STANDARD WARM AND NEUTRAL WHITE KITS PLOTTED ON ANSI STANDARD CHROMATICITY REGIONS

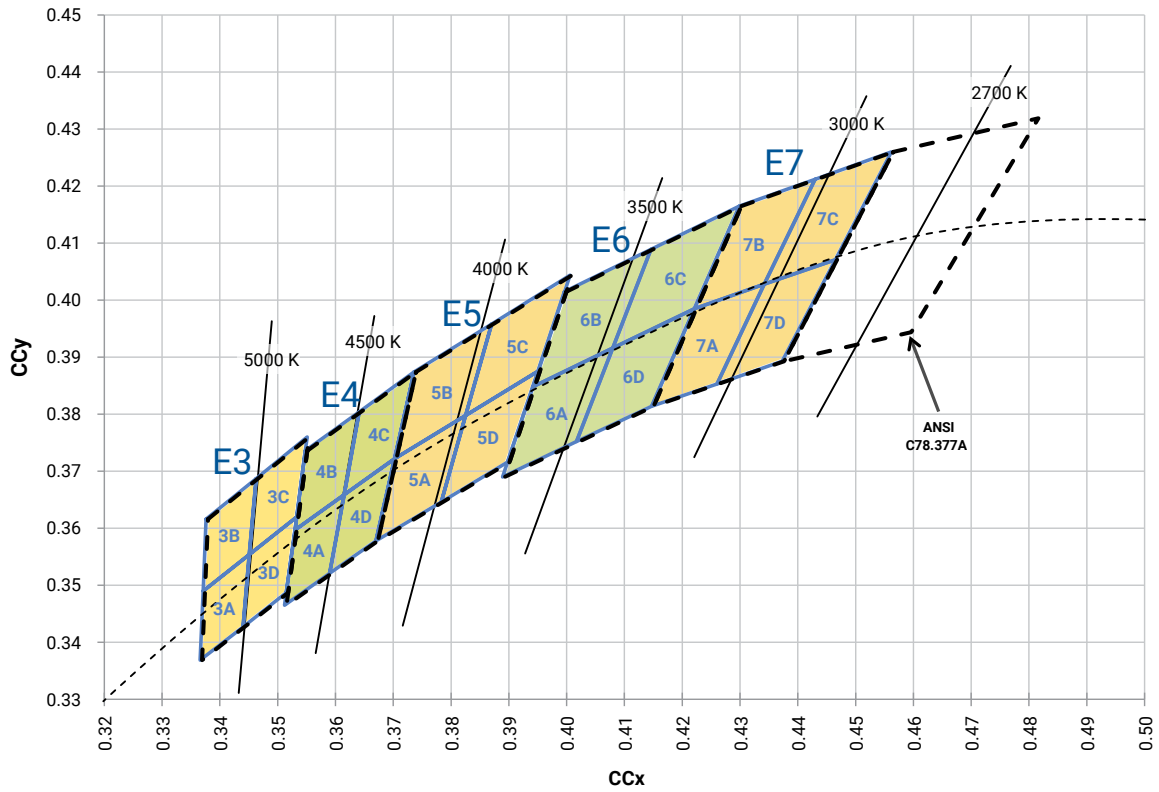

BIN AND ORDER-CODE FORMATS

Bin codes and order codes for XHP50 LEDs are configured in the following manner:

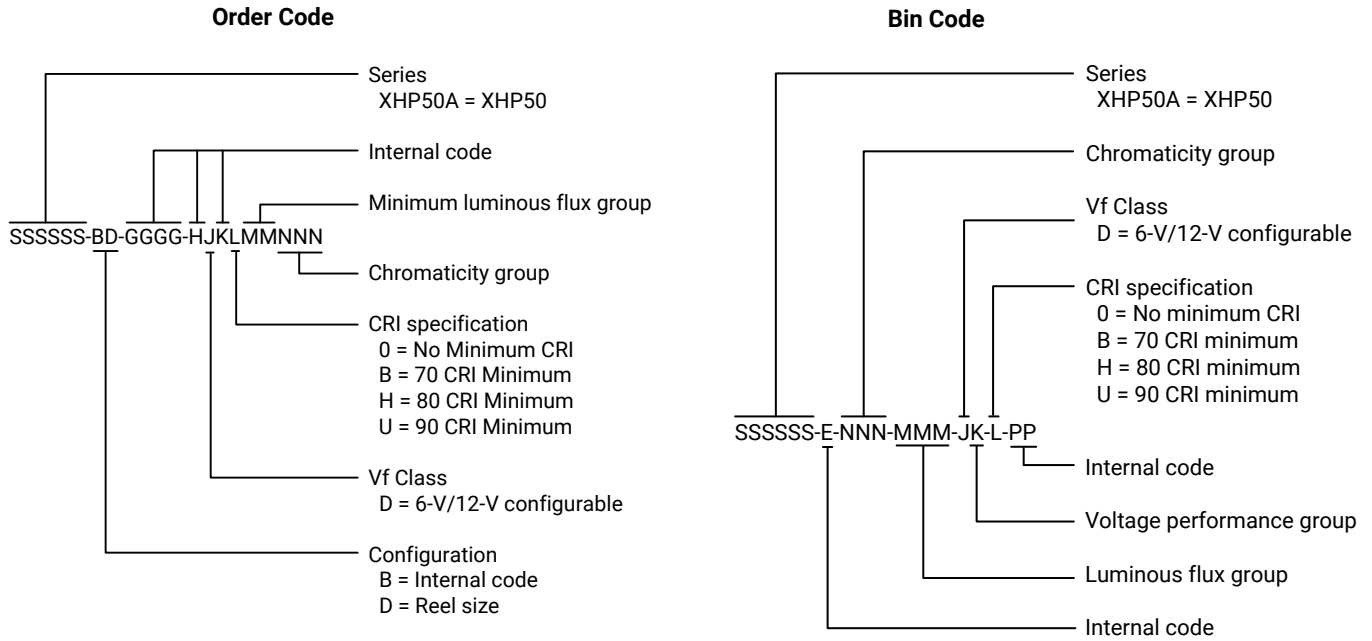

REFLOW SOLDERING CHARACTERISTICS

In testing, Cree has found XLamp XHP50 LEDs to be compatible with JEDEC J-STD-020C, using the parameters listed below. As a general guideline, Cree recommends that users follow the recommended soldering profile provided by the manufacturer of the solder paste used, and therefore it is the lamp or luminaire manufacturer’s responsibility to determine applicable soldering requirements.

Note that this general guideline may not apply to all PCB designs and configurations of reflow soldering equipment.

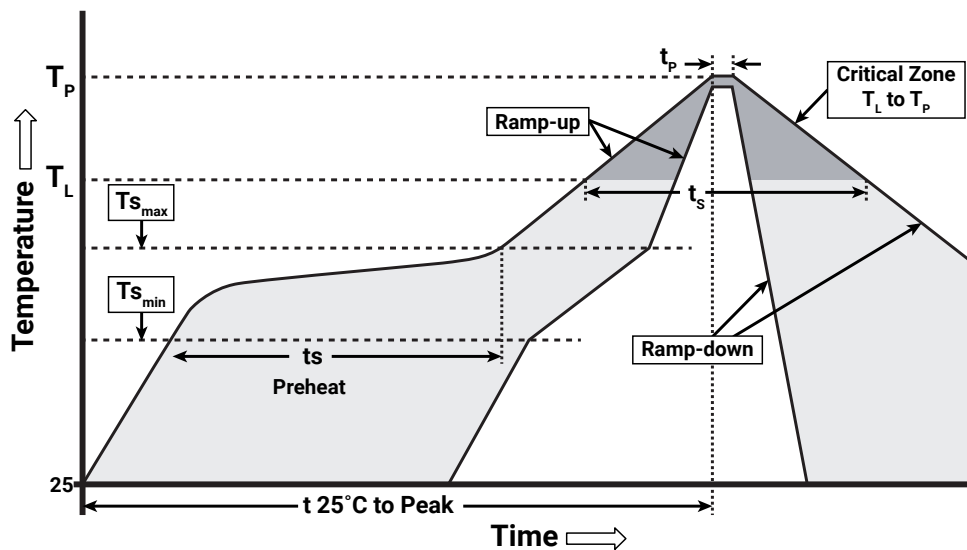

IPC/JEDEC J-STD-020C

Profile Feature	Lead-Free Solder
Average Ramp-Up Rate ($T_{s_{max}}$ to T_P)	1.2 °C/second
Preheat: Temperature Min ($T_{s_{min}}$)	120 °C
Preheat: Temperature Max ($T_{s_{max}}$)	170 °C
Preheat: Time ($t_{s_{min}}$ to $t_{s_{max}}$)	65-150 seconds
Time Maintained Above: Temperature (T_L)	217 °C
Time Maintained Above: Time (t_p)	45-90 seconds
Peak/Classification Temperature (T_P)	235 - 245 °C
Time Within 5 °C of Actual Peak Temperature (t_p)	20-40 seconds
Ramp-Down Rate	1 - 6 °C/second
Time 25 °C to Peak Temperature	4 minutes max.

Note: All temperatures refer to the topside of the package, measured on the package body surface.

NOTES

Measurements

The luminous flux, radiant power, chromaticity, forward voltage and CRI measurements in this document are binning specifications only and solely represent product measurements as of the date of shipment. These measurements will change over time based on a number of factors that are not within Cree's control and are not intended or provided as operational specifications for the products. Calculated values are provided for informational purposes only and are not intended or provided as specifications.

Pre-Release Qualification Testing

Please read the [LED Reliability Overview](#) for details of the qualification process Cree applies to ensure long-term reliability for XLamp LEDs and details of Cree's pre-release qualification testing for XLamp LEDs.

Lumen Maintenance

Cree now uses standardized IES LM-80-08 and TM-21-11 methods for collecting long-term data and extrapolating LED lumen maintenance. For information on the specific LM-80 data sets available for this LED, refer to the public [LM-80 results document](#).

Please read the [Long-Term Lumen Maintenance application note](#) for more details on Cree's lumen maintenance testing and forecasting. Please read the [Thermal Management application note](#) for details on how thermal design, ambient temperature, and drive current affect the LED junction temperature.

Moisture Sensitivity

Cree recommends keeping XLamp LEDs in the provided, resealable moisture-barrier packaging (MBP) until immediately prior to soldering. Unopened MBPs that contain XLamp LEDs do not need special storage for moisture sensitivity.

Once the MBP is opened, XLamp XHP50 LEDs may be stored as MSL 1 per JEDEC J-STD-033, meaning they have unlimited floor life in conditions of ≤ 30 °C/85% relative humidity (RH). Regardless of the storage condition, Cree recommends sealing any unsoldered LEDs in the original MBP.

RoHS Compliance

The levels of RoHS restricted materials in this product are below the maximum concentration values (also referred to as the threshold limits) permitted for such substances, or are used in an exempted application, in accordance with EU Directive 2011/65/EC (RoHS2), as implemented January 2, 2013. RoHS Declarations for this product can be obtained from your Cree representative or from the [Product Ecology](#) section of the Cree website.

REACH Compliance

REACH substances of very high concern (SVHCs) information is available for this product. Since the European Chemical Agency (ECHA) has published notice of their intent to frequently revise the SVHC listing for the foreseeable future, please contact a Cree representative to insure you get the most up-to-date REACH SVHC Declaration. REACH banned substance information (REACH Article 67) is also available upon request.

NOTES - CONTINUED

UL® Recognized Component

This product meets the requirements to be considered a UL Recognized Component with Level 4 enclosure consideration. The LED package or a portion thereof has been investigated as a fire and electrical enclosure per ANSI/UL 8750.

Vision Advisory

WARNING: Do not look at an exposed lamp in operation. Eye injury can result. For more information about LEDs and eye safety, please refer to the [LED Eye Safety application note](#).

MECHANICAL DIMENSIONS

Thermal vias, if present, are not shown on these drawings.

All dimensions are ± 0.13 mm unless otherwise indicated.

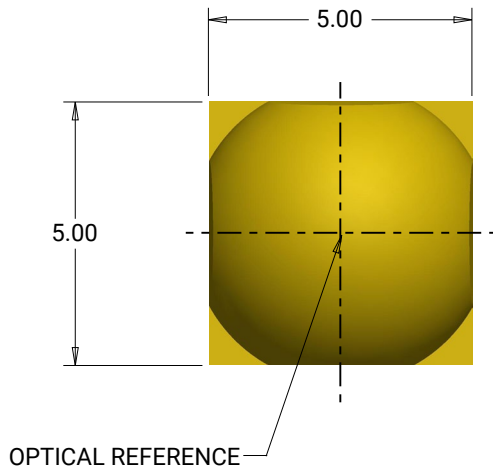

Top View

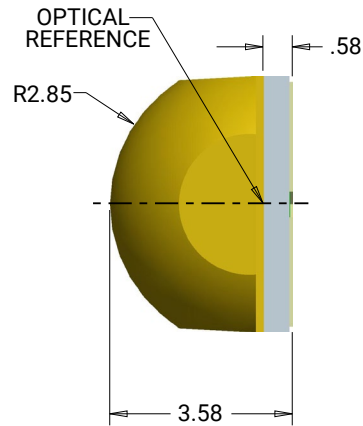

Side View

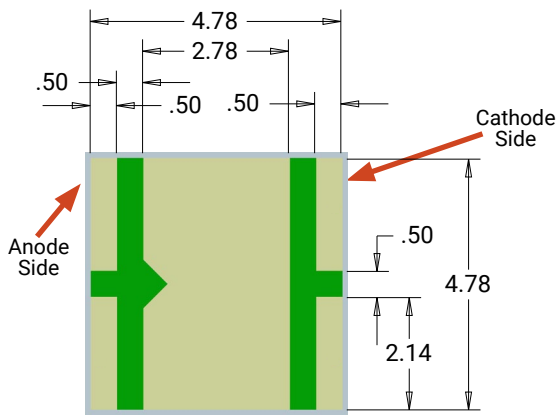

Bottom View

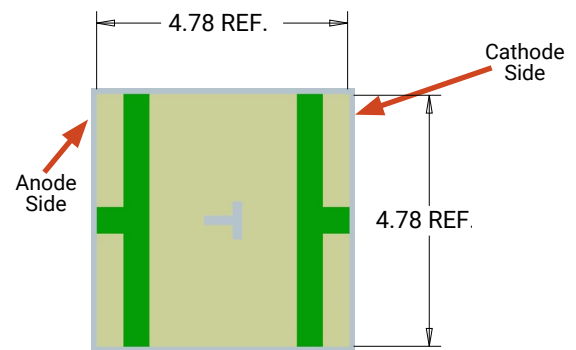

Alternate Bottom View

As shown in these bottom views, thermal pad is electrically isolated

MECHANICAL DIMENSIONS - CONTINUED

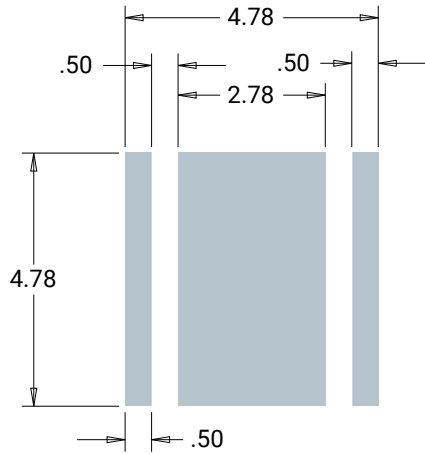

Recommended PCB Solder Pad 6 V Configuration
(thermal pad is electrically isolated)

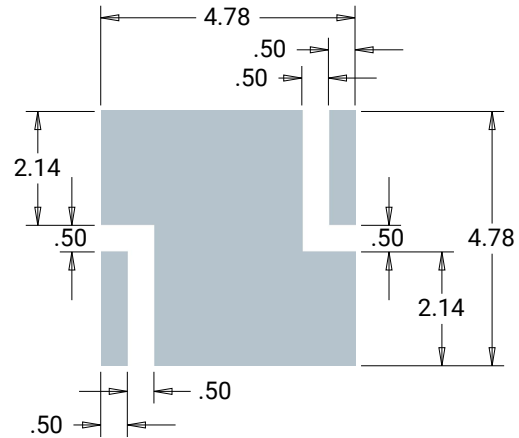

Recommended PCB Solder Pad 12 V Configuration
(thermal pad is connected to anode and cathode and is not electrically isolated)

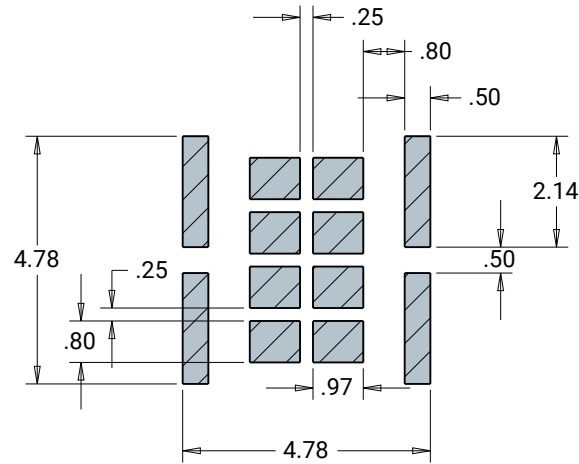

Recommended Stencil Pattern
6 V & 12 V Configurations
(shaded area is open)

ELECTRICAL CONFIGURATION

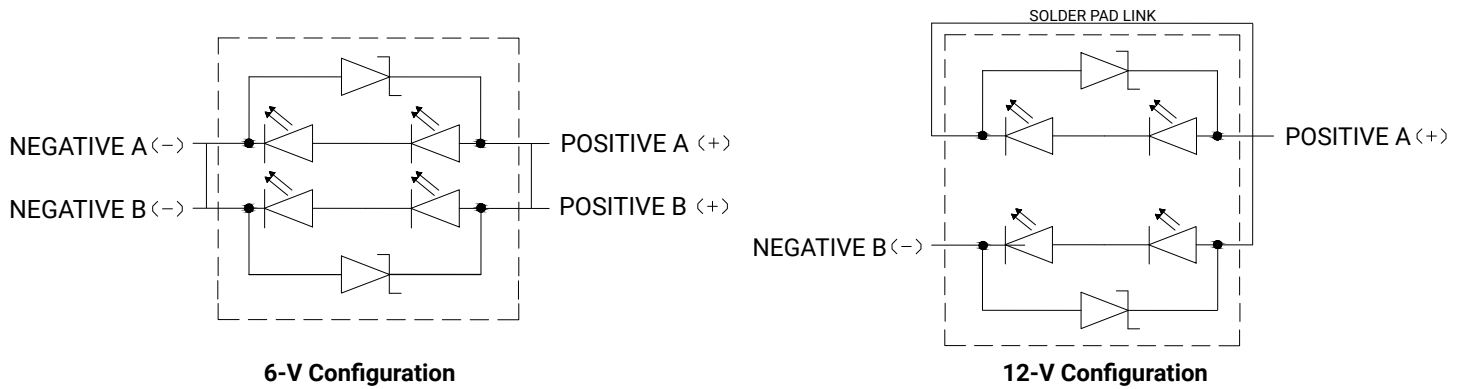

TAPE AND REEL

All Cree carrier tapes conform to EIA-481D, Automated Component Handling Systems Standard.
All dimensions are ± 0.13 mm unless otherwise indicated.

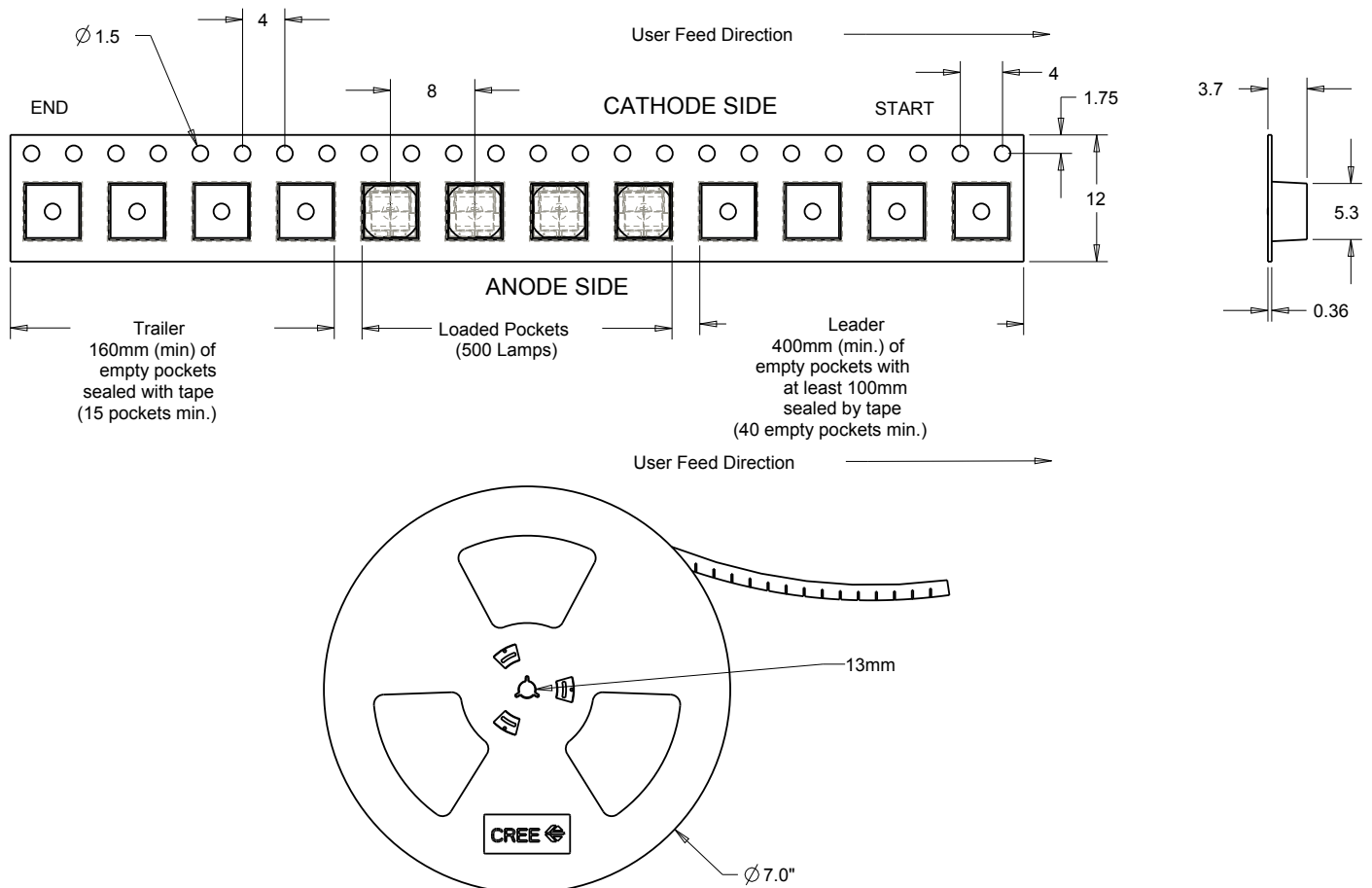

PACKAGING

Unpackaged Reel

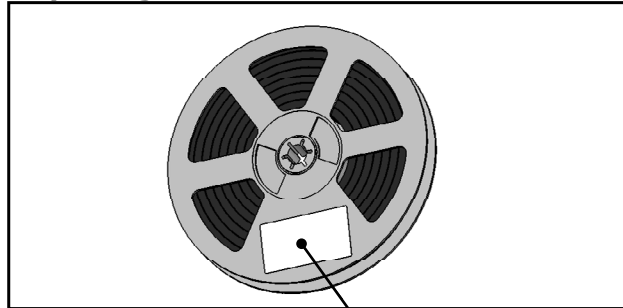

Label with Cree Bin Code,
Quantity, Reel ID

Packaged Reel

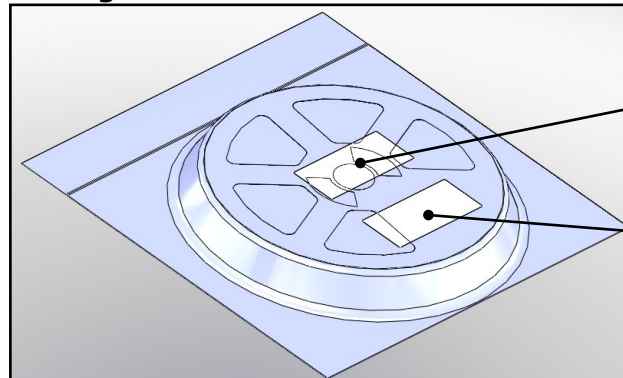

Label with Cree Order Code,
Quantity, Reel ID, PO #

Label with Cree Bin Code,
Quantity, Reel ID

Boxed Reel

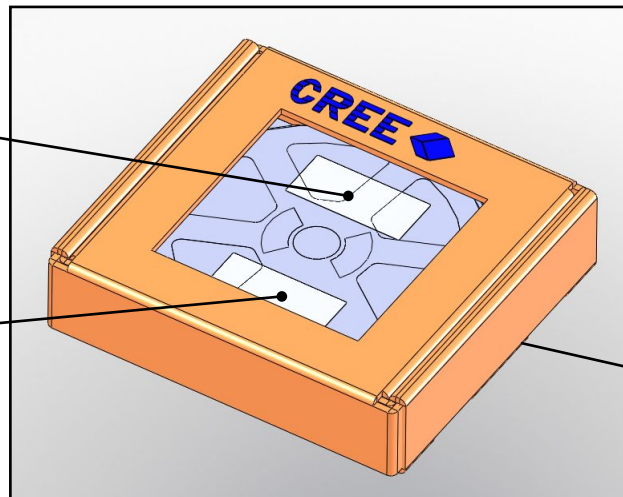

Label with Cree Order Code,
Quantity, Reel ID, PO #

Label with Cree Bin Code,
Quantity, Reel ID

Patent Label
(on bottom of box)

X-ON Electronics

Largest Supplier of Electrical and Electronic Components

Click to view similar products for [High Power LEDs - White category:](#)

Click to view products by [Cree manufacturer:](#)

Other Similar products are found below :

[G42180-08](#) [B42180-08](#) [STW8Q2PA-R5-HA](#) [SZ5-M1-W0-00-V3/W2-AA](#) [LTPL-P00DWS57](#) [LZP-D0WW00-0000](#) [CLM-9-30-90-36-AC32-F4-3](#) [SZ5-M1-WW-C8-V1/V3-FA](#) [BXRC-27E2000-D-73](#) [BXRC-27G2000-D-73](#) [BXRC-30E1000-D-73](#) [BXRC-30G2000-D-73](#) [BXRC-40E1000-D-73](#) [BXRE-30G2000-B-73](#) [BXRE-30G2000-C-73](#) [BXRE-50C2001-C-74](#) [CXM-22-27-80-54-AC30-F4-3](#) [XHP50B-00-0000-0D0UH245G](#) [XHP50B-00-0000-0D0UH240G](#) [XHP50B-00-0000-0D0HJ245G](#) [MP-5050-8100-27-80](#) [MP-5050-6100-65-80](#) [MP-5050-6100-50-80](#) [MP-5050-6100-40-80](#) [MP-5050-6100-30-80](#) [CXM-22-30-80-54-AC30-F4-3](#) [LTW-2835SZK57](#) [BXEM-50C0000-0-000](#) [WW-WNA30TS-U1\(M1\)](#) [KW CSLPM2.CC-8L8M-4L8N](#) [KW CSLPM2.CC-8L8M-4O9Q](#) [KW DPLS32.SB-6H6J-E5P7-EG-Z264](#) [L1V1-507003V500000](#) [CXM-22-35-80-36-AC10-F3-3](#) [KW3 CGLNM1.TG-Z6QF6-EBVFFCBB46-DFGA](#) [JB5630AWT-H-H65EA0000-NZ000001](#) [XHP50B-00-0000-0D0UG430H](#) [CXM-22-35-90-54-AC40-F5-3](#) [CXM-22-35-80-54-AC40-F5-3](#) [OSM51206E1N-0.8T](#) [OSW43020C1C](#) [MP161611032290](#) [MP-1616-2103-50-90](#) [KW CULPM1.TG-Z6RF7-ebvFfcbB46-65G5](#) [KW DMLS33.SG-Z6M7-EBVFFCBB46-8E8G-700-S](#) [XPGDWT-B1-0000-00EEA](#) [XHP70B-00-0000-0D0BP450E](#) [KW DMLN33.SG-7J7K-EBVFFCBB46-8E8G-200-S](#) [ASMT-MW05-NMNS1](#)
[ASMT-MW06-NMNZ1](#)