

Thin-Film Directional Couplers



CP0805 SMD Type

GENERAL DESCRIPTION ITF (Integrated Thin-Film) TECHNOLOGY

The ITF SMD Coupler is based on thin-film multilayer technology. The technology provides a miniature part with excellent high frequency performance and rugged construction for reliable automatic assembly. The ITF Coupler is offered in a variety of frequency bands compatible with various types of high frequency wireless systems.

FEATURES

- Small Size: 0805
- Frequency Range: 800MHz - 3GHz
- Characteristic Impedance: 50Ω
- Operating / Storage Temp.: -40°C to +85°C
- Power Rating: 3W Continuous
- Low Profile
- Rugged Construction
- Taped and Reeled

APPLICATIONS

- Mobile Communications
- Satellite TV Receivers
- GPS
- Vehicle Location Systems
- Wireless LAN's

DIMENSIONS: (Top View) millimeters (inches)



	0805
L	2.03±0.1 (0.080±0.004)
W	1.55±0.1 (0.061±0.004)
T	0.98±0.1 (0.039±0.004)
A	0.56±0.25 (0.022±0.010)
B	0.35±0.15 (0.014±0.006)

HOW TO ORDER

CP ↓ Style Directional Coupler	0805 ↓ Size 0805	A ↓ Layout Type (see layout types)	0902 ↓ Frequency MHz	A ↓ Sub Type (see layout sub-types)	S ↓ Termination Code W = Nickel/Solder (Sn/Pb) **S = Nickel / Lead Free Solder (Sn100)	TR ↓ Packaging Code TR = Tape and Reel
---	---	---	---	--	--	---

Not RoHS Compliant



LEAD-FREE
LEAD-FREE COMPATIBLE
COMPONENT



RoHS
COMPLIANT

For RoHS compliant products, please select correct termination style.

**RoHS compliant

QUALITY INSPECTION

Finished parts are 100% tested for electrical parameters and visual characteristics. Each production lot is evaluated on a sample basis for:

- Static Humidity: 85°C, 85% RH, 160 hours
- Endurance: 125°C, I_R, 4 hours

TERMINATION

Nickel/Solder coating (Sn, Pb) compatible with automatic soldering technologies: reflow, wave soldering, vapor phase and manual.

Recommended Pad Layout Dimensions mm (inches)

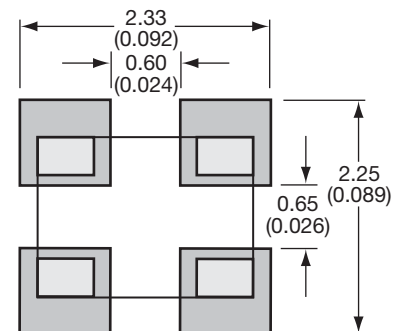

NOTE: Components must be mounted on the board with the white (Alumina) side DOWN.

Thin-Film Directional Couplers



CP0805 Layout Types

LAYOUT



Sn100 LAYOUT



Type: A
Sub-Type: A

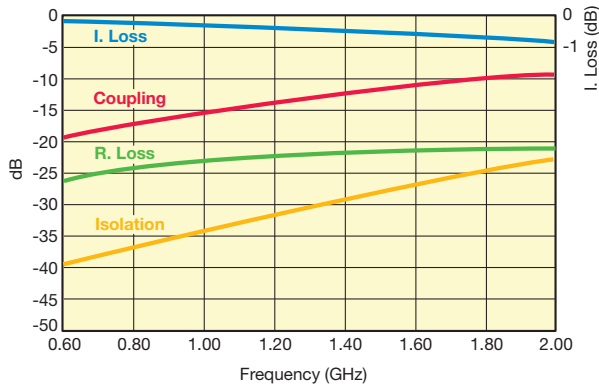

LAYOUT



Sn100 LAYOUT



Type: A
Sub-Type: B

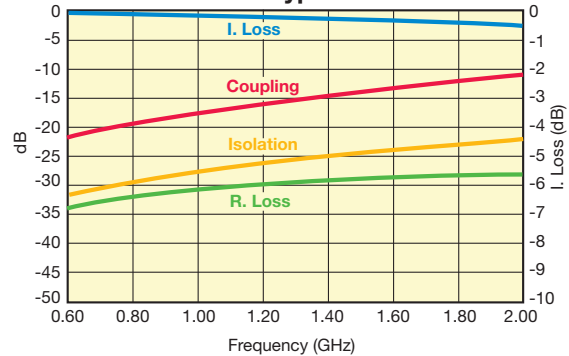

Application	P/N Examples	Frequency Band [MHz]	Coupling [dB]	I. Loss max	VSWR max
AMPS	CP0805A0836AW	824 - 849	16.5±1	0.25	1.2
	CP0805A0881AW	869 - 894	16±1		
GSM	CP0805A0902AW	890 - 915	16±1		
	CP0805A0947AW	935 - 960	15.5±1		
E-GSM	CP0805A0897AW	880 - 915	16±1		
	CP0805A0942AW	925 - 960	15.5±1		
PDC	CP0805A1441AW	1429 - 1453	12±1	0.5	1.3
PCN	CP0805A1747AW	1710 - 1785	10.5±1	0.8	1.4
	CP0805A1842AW	1805 - 1880	10±1		
PCS	CP0805A1880AW	1850 - 1910	9.5±1	0.7	1.4
	CP0805A1960AW	1930 - 1990	9.5±1		
PHP	CP0805A1907AW	1895 - 1920	9.5±1	0.6	1.4
DECT	CP0805A1890AW	1880 - 1900	9.5±1	0.6	1.4
Wireless LAN	CP0805A2442BW	2400 - 2484	10±1	0.9	1.4

Application	P/N Examples	Frequency Band [MHz]	Coupling [dB]	I. Loss max	VSWR max
AMPS	CP0805A0836BW	824 - 849	19±1	0.25	1.2
	CP0805A0881BW	869 - 894	18.5±1		
GSM	CP0805A0902BW	890 - 915	18±1		
	CP0805A0947BW	935 - 960	18±1		
E-GSM	CP0805A0897BW	880 - 915	18.5±1		
	CP0805A0942BW	925 - 960	18±1		
PDC	CP0805A1441BW	1429 - 1453	14.5±1	0.35	1.3
PCN	CP0805A1747BW	1710 - 1785	12.5±1	0.5	1.4
	CP0805A1842BW	1805 - 1880	12.5±1		
PCS	CP0805A1880BW	1850 - 1910	12±1	0.6	1.4
	CP0805A1960BW	1930 - 1990	11.5±1		
PHP	CP0805A1907BW	1895 - 1920	12±1	0.6	1.4
DECT	CP0805A1890BW	1880 - 1900	12±1	0.6	1.4
Wireless LAN	CP0805A2442BW	2400 - 2484	10±1	0.9	1.4

LAYOUT

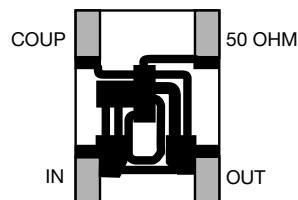

Sn100 LAYOUT



Type: A
Sub-Type: C

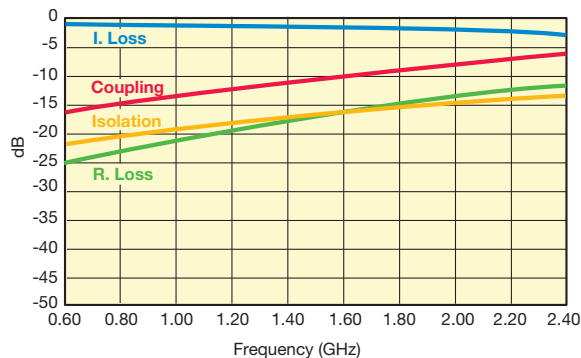

Application	P/N Examples	Frequency Band [MHz]	Coupling [dB]	I. Loss max	VSWR max
AMPS	CP0805A0836CW	824 - 849	14±1	0.5	1.4
	CP0805A0881CW	869 - 894	13.5±1		
GSM	CP0805A0902CW	890 - 915	13.5±1		
	CP0805A0947CW	935 - 960	13±1		
E-GSM	CP0805A0897CW	880 - 915	13.5±1		
	CP0805A0942CW	925 - 960	13±1		
PDC	CP0805A1441CW	1429 - 1453	9.5±1	1.15	1.8
PCN	CP0805A1747CW	1710 - 1785	8±1	1.6	2.2
	CP0805A1842CW	1805 - 1880	8±1		
PCS	CP0805A1880CW	1850 - 1910	7.5±1	1.75	2.2
	CP0805A1960CW	1930 - 1990	7.5±1		
PHP	CP0805A1907CW	1895 - 1920	7.5±1	2.5	2.2
DECT	CP0805A1890CW	1880 - 1900	7.5±1	2.5	2.2
Wireless LAN	CP0805A2442CW	2400 - 2484	6±1	2.5	2.2

Important: Couplers can be used at any frequency within the indicated range.

Thin-Film Directional Couplers



CP0805 Layout Types

LAYOUT



Sn100 LAYOUT

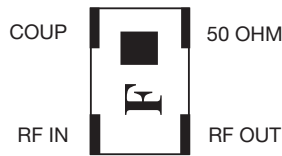

Type: A
Sub-Type: D



LAYOUT



Sn100 LAYOUT



Type: A
Sub-Type: E



3

Application	P/N Examples	Frequency Band [MHz]	Coupling [dB]	I. Loss max	VSWR max
AMPS	CP0805A0836DW	824 - 849	13.0±1	0.5	1.4
	CP0805A0881DW	869 - 894	12.5±1		
GSM	CP0805A0902DW	890 - 915	12.5±1	1.85	1.8
	CP0805A0947DW	935 - 960	12±1		
E-GSM	CP0805A0897DW	880 - 915	12.5±1	2.15	2.1
	CP0805A0942DW	925 - 960	12±1		
PDC	CP0805A1441DW	1429 - 1453	8.5±1	1.25	1.8
PCN	CP0805A1747DW	1710 - 1785	7±1	1.85	2.2
	CP0805A1842DW	1805 - 1880	7±1		
PCS	CP0805A1880DW	1850 - 1910	7±1	2.4	2.4
	CP0805A1960DW	1930 - 1990	6.5±1		
PHP	CP0805A1907DW	1895 - 1920	6.5±1	1.85	1.8
DECT	CP0805A1890DW	1880 - 1900	7±1	2.4	2.1
Wireless LAN	CP0805A2442DW	2400 - 2484	5.5±1	2.4	2.1

Application	P/N Examples	Frequency Band [MHz]	Coupling [dB]	I. Loss max	VSWR max
AMPS	CP0805A0836EW	824 - 849	11±1	0.85	1.4
	CP0805A0881EW	869 - 894	10.5±1		
GSM	CP0805A0902EW	890 - 915	10.5±1	1.8	1.8
	CP0805A0947EW	935 - 960	10±1		
E-GSM	CP0805A0897EW	880 - 915	10.5±1	2.7	2.2
	CP0805A0942EW	925 - 960	10±1		
PDC	CP0805A1441EW	1429 - 1453	7±1	1.8	1.8
PCN	CP0805A1747EW	1710 - 1785	5.5±1	3.15	2.4
	CP0805A1842EW	1805 - 1880	5.5±1		
PCS	CP0805A1880EW	1850 - 1910	5±1	4.2	2.4
	CP0805A1960EW	1930 - 1990	5±1		
PHP	CP0805A1907EW	1895 - 1920	5±1	2.7	2.2
DECT	CP0805A1890EW	1880 - 1900	5±1	3.15	2.4
Wireless LAN	CP0805A2442EW	2400 - 2484	4±1	4.2	2.4

Type: B
Sub-Type: A



LAYOUT

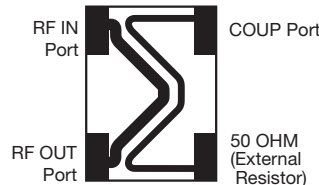

Sn100 LAYOUT

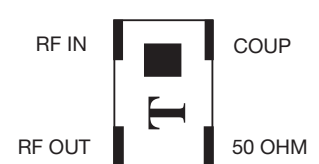

Application	P/N Examples	Frequency Band [MHz]	Coupling [dB]	I. Loss max	VSWR max
AMPS	CP0805B0836AW	824 - 849	21.5±1	0.25	1.2
	CP0805B0881AW	869 - 894	21±1		
GSM	CP0805B0902AW	890 - 915	21±1	0.3	1.2
	CP0805B0947AW	935 - 960	20.5±1		
E-GSM	CP0805B0897AW	880 - 915	21±1	0.4	1.2
	CP0805B0942AW	925 - 960	20.5±1		
PDC	CP0805B1441AW	1429 - 1453	17±1	0.3	1.2
PCN	CP0805B1747AW	1710 - 1785	15.5±1	0.3	1.2
	CP0805B1842AW	1805 - 1880	15.5±1		
PCS	CP0805B1880AW	1850 - 1910	15±1	0.4	1.2
	CP0805B1960AW	1930 - 1990	14.5±1		
PHP	CP0805B1907AW	1895 - 1920	15±1	0.3	1.2
DECT	CP0805B1890AW	1880 - 1900	15±1	0.4	1.2
Wireless LAN	CP0805B2442AW	2400 - 2484	13±1	0.4	1.2

Important: Couplers can be used at any frequency within the indicated range.



Thin-Film Directional Couplers



CP0805 Layout Types



Type: B
Sub-Type: B



Type: B
Sub-Type: C



Application	P/N Examples	Frequency Band [MHz]	Coupling [dB]	I. Loss max	VSWR max
AMPS	CP0805B0836BW	824 - 849	23.5±1	0.25	1.2
	CP0805B0881BW	869 - 894	23±1		
GSM	CP0805B0902BW	890 - 915	22.5±1		
	CP0805B0947BW	935 - 960	22±1		
E-GSM	CP0805B0897BW	880 - 915	23±1		
	CP0805B0942BW	925 - 960	22±1		
PDC	CP0805B1441BW	1429 - 1453	18.5±1		
PCN	CP0805B1747BW	1710 - 1785	17±1		
	CP0805B1842BW	1805 - 1880	16.5±1		
PCS	CP0805B1880BW	1850 - 1910	16.5±1		
	CP0805B1960BW	1930 - 1990	16±1		
PHP	CP0805B1907BW	1895 - 1920	16±1		
DECT	CP0805B1890BW	1880 - 1900	16±1		
Wireless LAN	CP0805B2442BW	2400 - 2484	14±1	0.4	

Application	P/N Examples	Frequency Band [MHz]	Coupling [dB]	I. Loss max	VSWR max
AMPS	CP0805B0836CW	824 - 849	25±1	0.25	1.2
	CP0805B0881CW	869 - 894	24.5±1		
GSM	CP0805B0902CW	890 - 915	24±1		
	CP0805B0947CW	935 - 960	24±1		
E-GSM	CP0805B0897CW	880 - 915	24.5±1		
	CP0805B0942CW	925 - 960	24±1		
PDC	CP0805B1441CW	1429 - 1453	20±1		
PCN	CP0805B1747CW	1710 - 1785	18.5±1		
	CP0805B1842CW	1805 - 1880	18.5±1		
PCS	CP0805B1880CW	1850 - 1910	18±1		
	CP0805B1960CW	1930 - 1990	17.5±1		
PHP	CP0805B1907CW	1895 - 1920	18±1		
DECT	CP0805B1890CW	1880 - 1900	18±1		
Wireless LAN	CP0805B2442CW	2400 - 2484	16±1	0.4	

Important: Couplers can be used at any frequency within the indicated range.



Thin-Film Directional Couplers



CP0805 Layout Types

VHF DIRECTIONAL COUPLER

CP0805L0155ASTR

Sn100 LAYOUT



P/N	Frequency [MHz]	Coupling [dB]	R. Loss [dB]	I. Loss max [dB]	Directivity [dB]
CP0805L0155ASTR	155	17.1±1	24	0.35	22



UHF DIRECTIONAL COUPLER

CP0805L0436BSTR

Sn100 LAYOUT



P/N	Frequency [MHz]	Coupling [dB]	R. Loss [dB]	I. Loss max [dB]	Directivity [dB]
CP0805L0436BSTR	403-470	15.85±1	35	0.25	22



Important: Couplers can be used at any frequency within the indicated range.

Thin-Film Directional Couplers



CP0805 and CP0603 Test Jig

ITF TEST JIG FOR COUPLER TYPES 0805 AND 0603 SMD

GENERAL DESCRIPTION

This jig is designed for the testing of CP0805 and CP0603 series Directional Couplers using a vector network analyzer. It consists of a FR4 multi-layer substrate, having 50Ω microstrips as conducting lines and a ground plane in the middle layer, located at a distance of 0.2mm from the microstrips.

The connectors are SMA type (female), 'Johnson Components Inc.' Product P/N: 142-0701-881.

The jig is designed for a full 2-port calibration. LOAD calibration can be done either by a 50Ω SMA termination, or by soldering a 50Ω chip resistor at the 50Ω ports.

MEASUREMENT PROCEDURE

When measuring a component, it can be either soldered or pressed by a non-metallic stick until all four ports touch the appropriate pads. To measure the coupling (and the R. Loss) place the component on the Port 1 & Port 2 pads. Use two SMA 50Ω terminations (male) to terminate the ports, which are not connected to the network analyzer, and connect the network analyzer to the two ports. A 90° rotation of the component on its pads allows measuring a second parameter (I. Loss).



CP0805 SERIES DIRECTIONAL COUPLERS

Orientation and Tape and Reel Packaging Specification

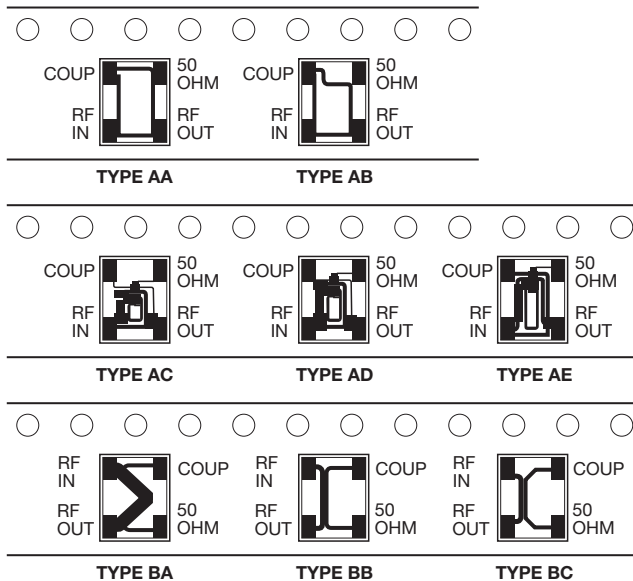

The parts should be mounted on the PCB with White (Alumina) side down and the "dark" side up.

CP0805xxxxxxSTR (Sn100)

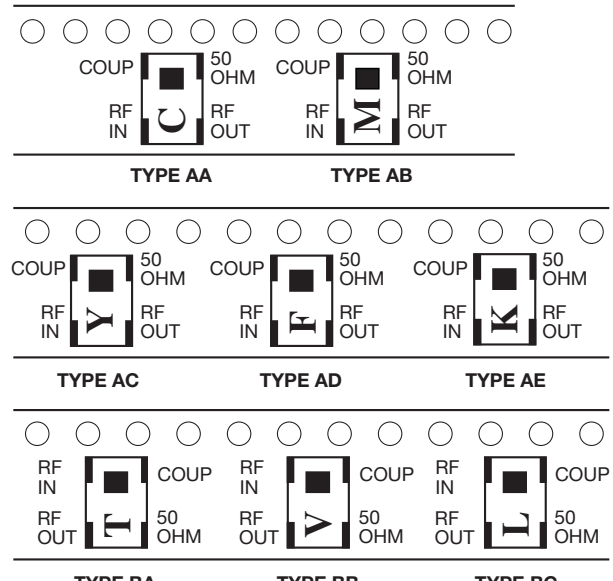

The parts should be mounted on the PCB with printed side up.



X-ON Electronics

Largest Supplier of Electrical and Electronic Components

Click to view similar products for [Signal Conditioning](#) category:

Click to view products by [AVX](#) manufacturer:

Other Similar products are found below :

[MAPDCC0004](#) [PD0409J5050S2HF](#) [880157](#) [HHS-109-PIN](#) [DC1417J5005AHF](#) [DC4859J5005AHF](#) [AFS14A30-2185.00-T3](#) [AFS14A35-1591.50-T3](#) [DS-323-PIN](#) [DSS-313-PIN](#) [B39321R801H210](#) [B39321R821H210](#) [B39921B4317P810](#) [1A0220-3](#) [2089-6207-00](#) [JP510S](#) [LFB212G45SG8C341](#) [LFB322G45SN1A504](#) [LFL182G45TC3B746](#) [SF2159E](#) [30057](#) [1P510S](#) [CER0813B](#) [3A325](#) [40287](#) [41180](#) [ATB3225-75032NCT](#) [B69842N5807A150](#) [BD0810N50100AHF](#) [BD2326L50200AHF](#) [BD2425J50200AHF](#) [HMC189AMS8TR](#) [C5060J5003AHF](#) [JHS-114-PIN](#) [JP503AS](#) [DC0710J5005AHF](#) [DC2327J5005AHF](#) [DC3338J5005AHF](#) [43020](#) [LFB2H2G60BB1C106](#) [LFL15869MTC1B787](#) [X3C19F1-20S](#) [XC3500P-20S](#) [10013-20](#) [SF2081E](#) [SF2194E](#) [SF2238E](#) [CDBLB455KCAX39-B0](#) [RF1353C](#) [PD0922J5050D2HF](#)