

# Thin-Film Directional Couplers



## CP0603 High Directivity LGA Termination

### GENERAL DESCRIPTION ITF (Integrated Thin-Film) TECHNOLOGY

The ITF LGA Coupler is based on thin-film multilayer technology. The technology provides a miniature part with excellent high frequency performance and rugged construction for reliable automatic assembly. The ITF Coupler is offered in a variety of frequency bands compatible with various types of high frequency wireless systems.

### APPLICATIONS

- Mobile Communications
- Satellite TV Receivers
- GPS
- Vehicle Location Systems
- Wireless LAN's

### FEATURES

- Inherent Low Profile
- Self Alignment during Reflow
- Excellent Solderability
- Low Parasitics
- Better Heat Dissipation
- Operating/Storage Temp -40°C to +85°C
- Power Rating 3W RF Cont

### DIMENSIONS: (Bottom View)

millimeters (inches)

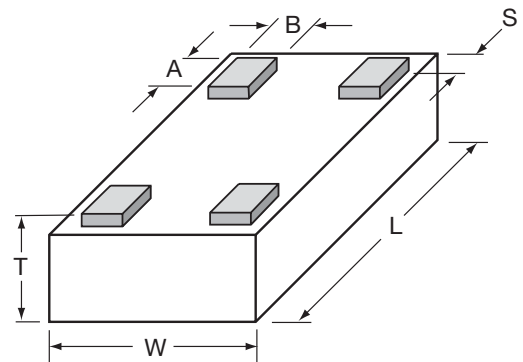

<b>L</b>	1.60±0.10 (0.063±0.004)	<b>A</b>	0.25±0.05 (0.010±0.002)
<b>W</b>	0.84±0.10 (0.033±0.004)	<b>B</b>	0.20±0.05 (0.008±0.002)
<b>T</b>	0.60±0.10 (0.024±0.004)	<b>S</b>	0.05±0.05 (0.002±0.002)

3

### HOW TO ORDER

<b>CP</b> T <b>Style</b> Directional Coupler	<b>0603</b> T <b>Size</b> 0603	<b>A</b> T <b>Type</b>	<b>****</b> T <b>Frequency</b> (MHz)	<b>X</b> T <b>Sub Type</b>	<b>N</b> T <b>Termination Code</b> L = LGA Sn90, Pb10 **N = LGA Sn100  **RoHS Compliant	<b>TR</b> T <b>Packaging Code</b> TR = Tape and Reel
---	---	------------------------------	---	----------------------------------	---	---

### QUALITY INSPECTION

Finished parts are 100% tested for electrical parameters and visual characteristics. Each production lot is evaluated on a sample basis for:

- Static Humidity: 85°C, 85% RH, 160 hours
- Endurance: 125°C, I<sub>R</sub>, 4 hours

### TERMINATION

Sn90Pb10 or Lead-Free Sn100 Nickel/Solder coating compatible with automatic soldering technologies: reflow, wave soldering, vapor phase and manual.

### TERMINALS (Top View)

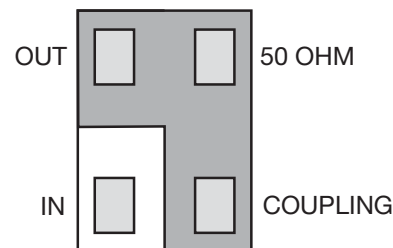

### ORIENTATION IN TAPE

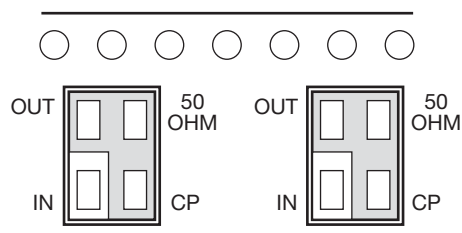

### Recommended Pad Layout Dimensions

mm (inches)

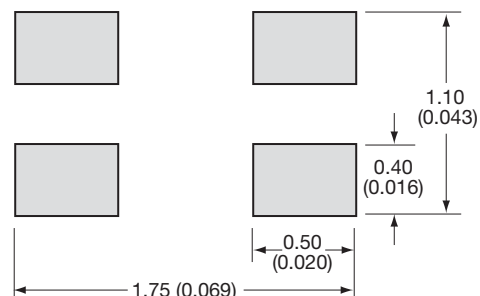

\*The recommended distance to the PCB Ground Plane is 0.254mm (0.010")

# Thin-Film Directional Couplers

## CP0603 High Directivity LGA Termination



### COUPLER TYPE SELECTION GRAPH

### Coupling vs. Frequency

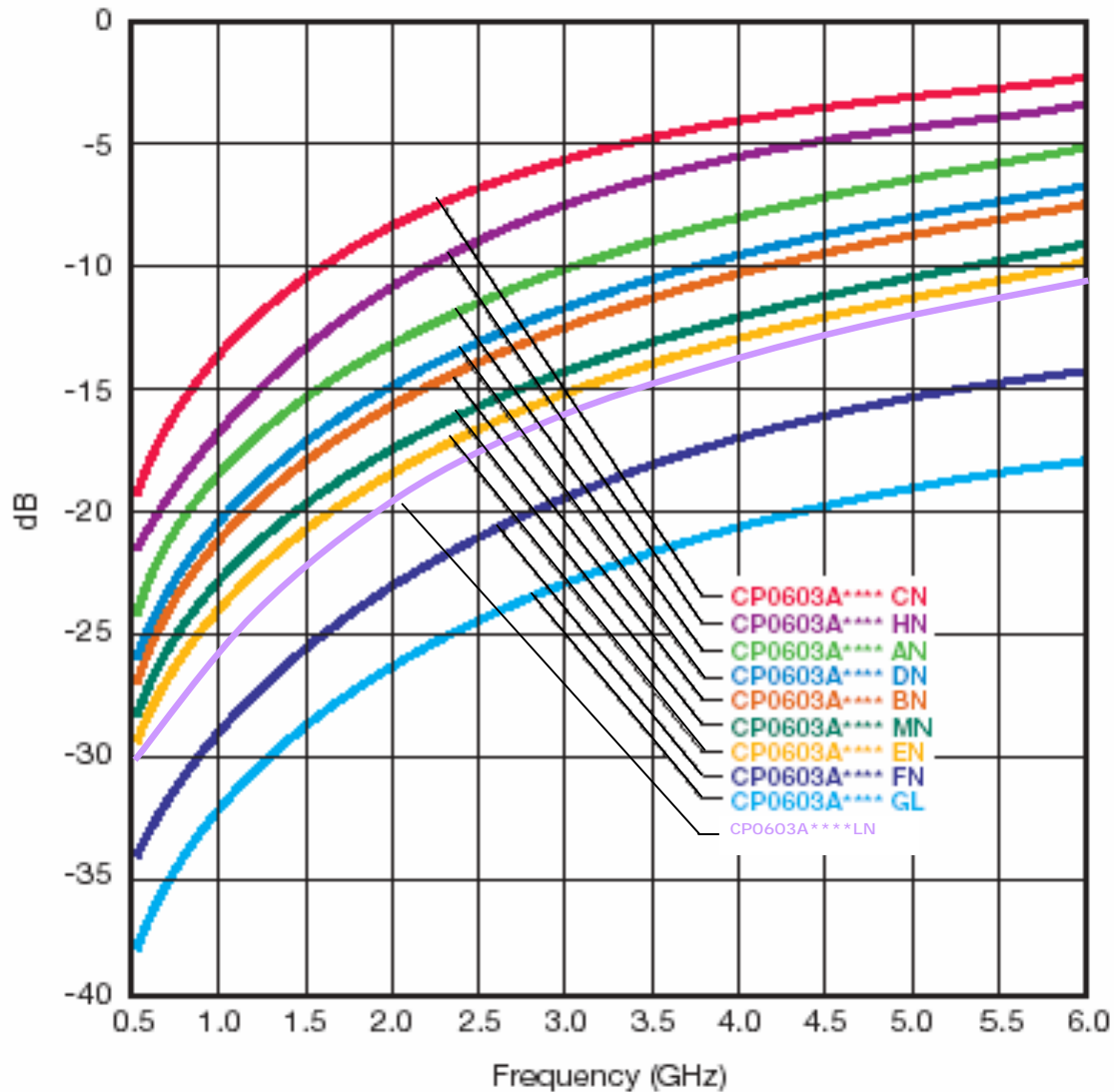

Intermediate coupling factors are readily available.  
Please contact factory.



# Thin-Film Directional Couplers



## CP0603 High Directivity LGA Type

Farnell Stock Code 1343815 AVX P/N CP0603AxxxxAN

Application	P/N Examples	Frequency Band [MHz]	Coupling [dB]	I. Loss max. [dB]	Return Loss [dB]	Directivity [dB]	
AMPS	CP0603A0836AN	824 - 849	20.0	0.25	28	22	
	CP0603A0881AN	869 - 894	19.7				
GSM	CP0603A0902AN	890 - 915	19.4				
	CP0603A0947AN	935 - 960	19.0				
E-GSM	CP0603A0897AN	880 - 915	19.4				
	CP0603A0942AN	925 - 960	19.0				
PDC	CP0603A1441AN	1429 - 1453	15.5		0.40		24
PCN	CP0603A1747AN	1710 - 1785	14.0		0.50		22
	CP0603A1842AN	1805 - 1880	13.5				
PCS	CP0603A1880AN	1850 - 1910	13.2		0.55		21
	CP0603A1960AN	1930 - 1990	13.0				
PHP	CP0603A1907AN	1895 - 1920	13.2	0.50	22		
DECT	CP0603A1890AN	1880 - 1900	13.2	0.50	22		
Wireless LAN	CP0603A2442AN	2400 - 2484	11.5	0.75	20		

Farnell Stock Code 1343815 AVX P/N CP0603AxxxxAN

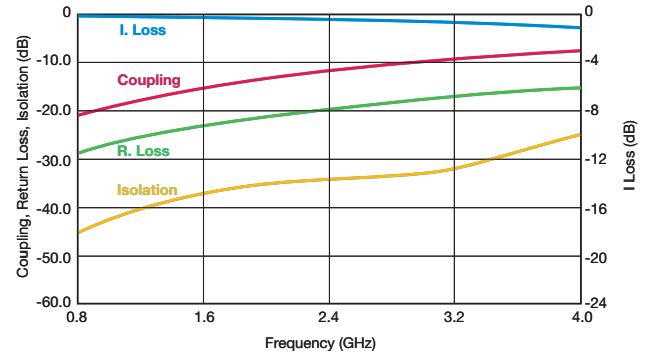

3

Farnell Stock Code 1343818 AVX P/N CP0603AxxxxBN

Application	P/N Examples	Frequency Band [MHz]	Coupling [dB]	I. Loss max. [dB]	Return Loss [dB]	Directivity [dB]	
AMPS	CP0603A0836BN	824 - 849	23.0	0.20	31	20	
	CP0603A0881BN	869 - 894	22.7				
GSM	CP0603A0902BN	890 - 915	22.5				
	CP0603A0947BN	935 - 960	22.0				
E-GSM	CP0603A0897BN	880 - 915	22.5				
	CP0603A0942BN	925 - 960	22.0				
PDC	CP0603A1441BN	1429 - 1453	18.5		0.25		27
PCN	CP0603A1747BN	1710 - 1785	17.0		0.25		25
	CP0603A1842BN	1805 - 1880	16.4				
PCS	CP0603A1880BN	1850 - 1910	16.2		0.25		24
	CP0603A1960BN	1930 - 1990	16.0				
PHP	CP0603A1907BN	1895 - 1920	16.1	0.25	25		
DECT	CP0603A1890BN	1880 - 1900	16.2	0.25	25		
Wireless LAN	CP0603A2442BN	2400 - 2484	14.2	0.35	23		

Farnell Stock Code 1343818 AVX P/N CP0603AxxxxBN

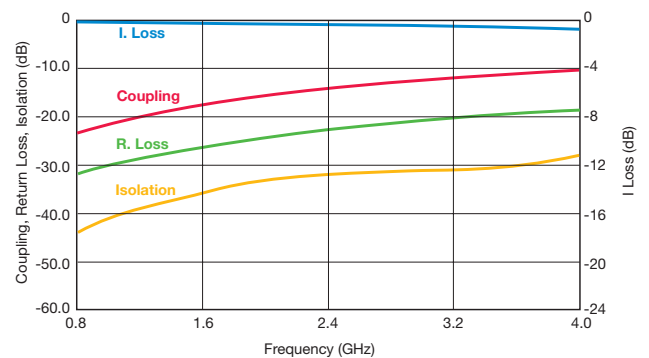

Farnell Stock Code 1343813 AVX P/N CP0603AxxxxCN

Application	P/N Examples	Frequency Band [MHz]	Coupling [dB]	I. Loss max. [dB]	Return Loss [dB]	Directivity [dB]	
AMPS	CP0603A0836CN	824 - 849	15.2	0.35	23	23	
	CP0603A0881CN	869 - 894	15.0				
GSM	CP0603A0902CN	890 - 915	14.7				
	CP0603A0947CN	935 - 960	14.3				
E-GSM	CP0603A0897CN	880 - 915	14.7				
	CP0603A0942CN	925 - 960	14.3				
PDC	CP0603A1441CN	1429 - 1453	11.0		0.70		19
PCN	CP0603A1747CN	1710 - 1785	9.5		0.80		18
	CP0603A1842CN	1805 - 1880	9.0				
PCS	CP0603A1880CN	1850 - 1910	8.8		0.90		17
	CP0603A1960CN	1930 - 1990	8.5				
PHP	CP0603A1907CN	1895 - 1920	8.8	0.90	17		
DECT	CP0603A1890CN	1880 - 1900	8.8	0.90	17		
Wireless LAN	CP0603A2442CN	2400 - 2484	7.0	1.40	15		

Farnell Stock Code 1343813 AVX P/N CP0603AxxxxCN

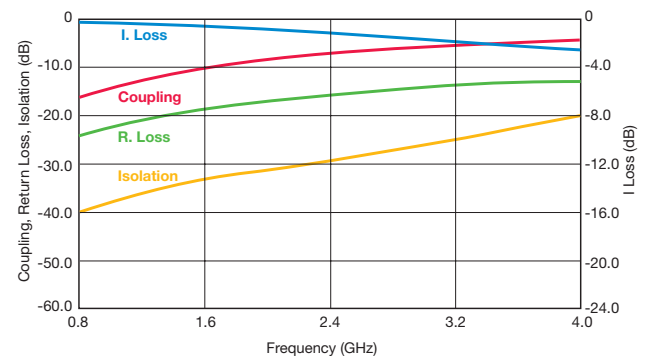

Important: Couplers can be used at any frequency within the indicated range.



# Thin-Film Directional Couplers



## CP0603 High Directivity LGA Type

Farnell Stock Code 1343817 AVX P/N CP0603AxxxxDN

Application	P/N Examples	Frequency Band [MHz]	Coupling [dB]	I. Loss max. [dB]	Return Loss [dB]	Directivity [dB]
AMPS	CP0603A0836DN	824 - 849	22.0	0.25	31	22
	CP0603A0881DN	869 - 894	21.8			
GSM	CP0603A0902DN	890 - 915	21.3	0.30	30	
	CP0603A0947DN	935 - 960	21.0			
E-GSM	CP0603A0897DN	880 - 915	21.3	0.30	30	
	CP0603A0942DN	925 - 960	21.0			
PDC	CP0603A1441DN	1429 - 1453	17.7	0.40	27	
PCN	CP0603A1747DN	1710 - 1785	16.0		25	
	CP0603A1842DN	1805 - 1880	15.4		24	
PCS	CP0603A1880DN	1850 - 1910	15.2			24
	CP0603A1960DN	1930 - 1990	15.0			
PHP	CP0603A1907DN	1895 - 1920	15.2	0.55	22	
DECT	CP0603A1890DN	1880 - 1900	15.2			
Wireless LAN	CP0603A2442DN	2400 - 2484	13.3			

Farnell Stock Code 1343817 AVX P/N CP0603AxxxxDN

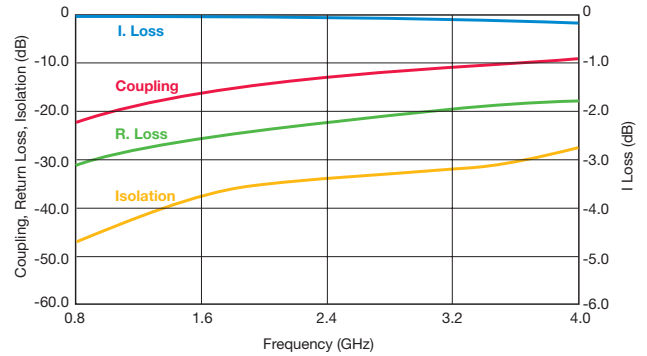

Farnell Stock Code 1343820 AVX P/N CP0603AxxxxEN

Application	P/N Examples	Frequency Band [MHz]	Coupling [dB]	I. Loss max. [dB]	Return Loss [dB]	Directivity [dB]
AMPS	CP0603A0836EN	824 - 849	25.8	0.20	32	21
	CP0603A0881EN	869 - 894	25.3			
GSM	CP0603A0902EN	890 - 915	25.0	0.25	28	
	CP0603A0947EN	935 - 960	24.7			
E-GSM	CP0603A0897EN	880 - 915	25.0	0.30	26	
	CP0603A0942EN	925 - 960	24.7			
PDC	CP0603A1441EN	1429 - 1453	21.0	0.40	24	
PCN	CP0603A1747EN	1710 - 1785	19.5		26	
	CP0603A1842EN	1805 - 1880	19.0			
PCS	CP0603A1880EN	1850 - 1910	18.8		26	
	CP0603A1960EN	1930 - 1990	18.5			
PHP	CP0603A1907EN	1895 - 1920	18.7	0.40	24	
DECT	CP0603A1890EN	1880 - 1900	18.8			
Wireless LAN	CP0603A2442EN	2400 - 2484	17.0			

Farnell Stock Code 1343820 AVX P/N CP0603AxxxxEN

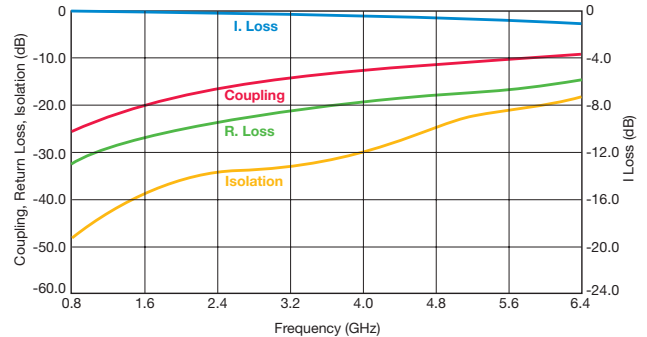

Farnell Stock Code 1343821 AVX P/N CP0603AxxxxFN

Application	P/N Examples	Frequency Band [MHz]	Coupling [dB]	I. Loss max. [dB]	Return Loss [dB]	Directivity [dB]
AMPS	CP0603A0836FN	824 - 849	31.2	0.20	28	12
	CP0603A0881FN	869 - 894	30.8			
GSM	CP0603A0902FN	890 - 915	30.5	0.25	27	
	CP0603A0947FN	935 - 960	30.2			
E-GSM	CP0603A0897FN	880 - 915	30.5	0.25	23	
	CP0603A0942FN	925 - 960	30.2			
PDC	CP0603A1441FN	1429 - 1453	27.0	0.25	21	
PCN	CP0603A1747FN	1710 - 1785	25.0		21	
	CP0603A1842FN	1805 - 1880	24.5			
PCS	CP0603A1880FN	1850 - 1910	24.3		20	
	CP0603A1960FN	1930 - 1990	24.0			
PHP	CP0603A1907FN	1895 - 1920	24.2	0.25	21	
DECT	CP0603A1890FN	1880 - 1900	24.2			
Wireless LAN	CP0603A2442FN	2400 - 2484	21.5			

Farnell Stock Code 1343821 AVX P/N CP0603AxxxxFN

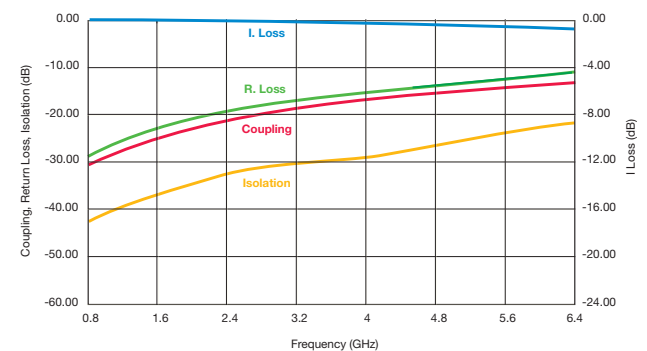

Important: Couplers can be used at any frequency within the indicated range.



# Thin-Film Directional Couplers



## CP0603 High Directivity LGA Type

Farnell Stock Code 1343823 AVX P/N CP0603AxxxxGN

Application	P/N Examples	Frequency Band [MHz]	Coupling [dB]	I. Loss max. [dB]	Return Loss [dB]	Directivity [dB]	
AMPS	CP0603A0836GN	824 - 849	34.2	0.20	39	13	
	CP0603A0881GN	869 - 894	33.8				
GSM	CP0603A0902GN	890 - 915	33.6				
	CP0603A0947GN	935 - 960	33.2				
E-GSM	CP0603A0897GN	880 - 915	33.6				
	CP0603A0942GN	925 - 960	33.2				
PDC	CP0603A1441GN	1429 - 1453	30.0		0.25		34
PCN	CP0603A1747GN	1710 - 1785	28.5				
	CP0603A1842GN	1805 - 1880	28.0				
PCS	CP0603A1880GN	1850 - 1910	27.7				
	CP0603A1960GN	1930 - 1990	27.5				
PHP	CP0603A1907GN	1895 - 1920	27.6				32
DECT	CP0603A1890GN	1880 - 1900	27.7				
Wireless LAN	CP0603A2442GN	2400 - 2484	25.5	31			

Farnell Stock Code 1343823 AVX P/N CP0603AxxxxGN

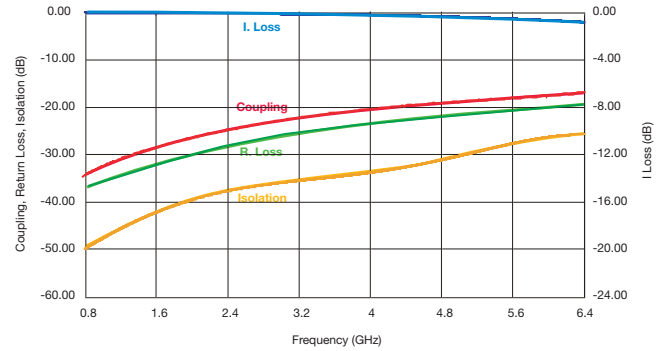

3

Farnell Stock Code 1343814 AVX P/N CP0603AxxxxHN

Application	P/N Examples	Frequency Band [MHz]	Coupling [dB]	I. Loss max. [dB]	Return Loss [dB]	Directivity [dB]	
AMPS	CP0603A0836HN	824 - 849	17.3	0.30	26	26	
	CP0603A0881HN	869 - 894	17.0				
GSM	CP0603A0902HN	890 - 915	16.7				
	CP0603A0947HN	935 - 960	16.3				
E-GSM	CP0603A0897HN	880 - 915	17.0				
	CP0603A0942HN	925 - 960	16.3				
PDC	CP0603A1441HN	1429 - 1453	13.0		0.55		22
PCN	CP0603A1747HN	1710 - 1785	11.4				
	CP0603A1842HN	1805 - 1880	11.0				
PCS	CP0603A1880HN	1850 - 1910	10.8				
	CP0603A1960HN	1930 - 1990	10.5				
PHP	CP0603A1907HN	1895 - 1920	10.7				19
DECT	CP0603A1890HN	1880 - 1900	10.8				
Wireless LAN	CP0603A2442HN	2400 - 2484	8.8	1.00		17	

Farnell Stock Code 1343814 AVX P/N CP0603AxxxxHN

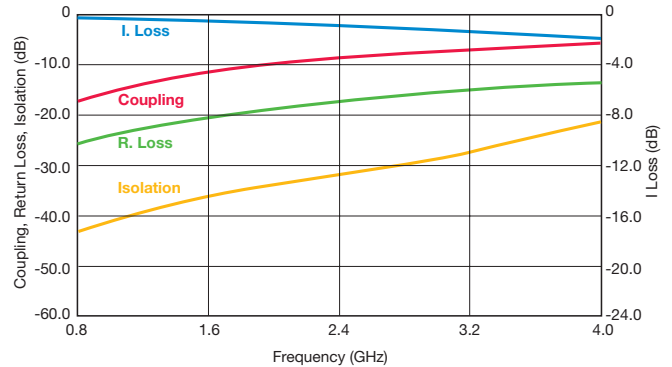

Farnell Stock Code 1343819 AVX P/N CP0603AxxxxMN

Application	P/N Examples	Frequency Band [MHz]	Coupling [dB]	I. Loss max. [dB]	Return Loss [dB]	Directivity [dB]	
AMPS	CP0603A0836MN	824 - 849	24.2	0.20	33	23	
	CP0603A0881MN	869 - 894	23.8				
GSM	CP0603A0902MN	890 - 915	23.4				
	CP0603A0947MN	935 - 960	23.2				
E-GSM	CP0603A0897MN	880 - 915	23.4				
	CP0603A0942MN	925 - 960	23.2				
PDC	CP0603A1441MN	1429 - 1453	20.0		0.25		28
PCN	CP0603A1747MN	1710 - 1785	18.4				
	CP0603A1842MN	1805 - 1880	18.0				
PCS	CP0603A1880MN	1850 - 1910	17.8				
	CP0603A1960MN	1930 - 1990	17.5				
PHP	CP0603A1907MN	1895 - 1920	17.7				26
DECT	CP0603A1890MN	1880 - 1900	17.8				
Wireless LAN	CP0603A2442MN	2400 - 2484	15.6	0.35		24	

Farnell Stock Code 1343819 AVX P/N CP0603AxxxxMN

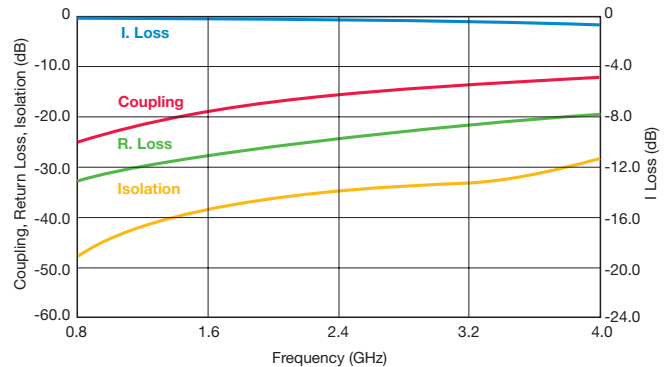

Important: Couplers can be used at any frequency within the indicated range.

# Thin-Film Directional Couplers



## CP0603 High Directivity LGA Type

APPLICATION	P/N	FREQUENCY BAND [ MHz ]	COUPLING [ dB ]	I. Loss max [ dB ]	Return Loss [dB]	Directivity [dB]
AMPS	CP0603A0836LNTR	824 ÷ 849	27.0	0.20	32	21
	CP0603A0881LNTR	869 ÷ 894	27.0	0.20	32	21
GSM	CP0603A0902LNTR	890 ÷ 915	26.5	0.20	32	21
	CP0603A0947LNTR	935 ÷ 960	26.0	0.20	31	21
E-GSM	CP0603A0897LNTR	880 ÷ 915	26.5	0.20	32	21
	CP0603A0942LNTR	925 ÷ 960	26.0	0.20	32	21
PDC	CP0603A1441LNTR	1429 ÷ 1453	22.0	0.20	28	21
PCN	CP0603A1747LNTR	1710 ÷ 1785	20.5	0.25	26	20
	CP0603A1842LNTR	1805 ÷ 1880	20.0	0.30	26	20
PCS	CP0603A1880LNTR	1850 ÷ 1910	20.0	0.30	26	20
	CP0603A1960LNTR	1930 ÷ 1990	19.5	0.30	26	19
PHP	CP0603A1907LNTR	1895 ÷ 1920	19.5	0.30	26	20
DECT	CP0603A1890LNTR	1880 ÷ 1900	20.0	0.30	26	20
WCDMA CDMA2000	CP0603A1950LNTR	1920 ÷ 1980	19.5	0.30	26	19
	CP0603A2140LNTR	2110 ÷ 2170	18.5	0.30	25	20
TDSCDMA	CP0603A1900LNTR	1880 ÷ 1920	19.5	0.30	26	20
	CP0603A2020LNTR	2015 ÷ 2025	19.0	0.30	25	19
Wireless LAN	CP0603A2442LNTR	2400 ÷ 2484	17.5	0.30	24	20

3

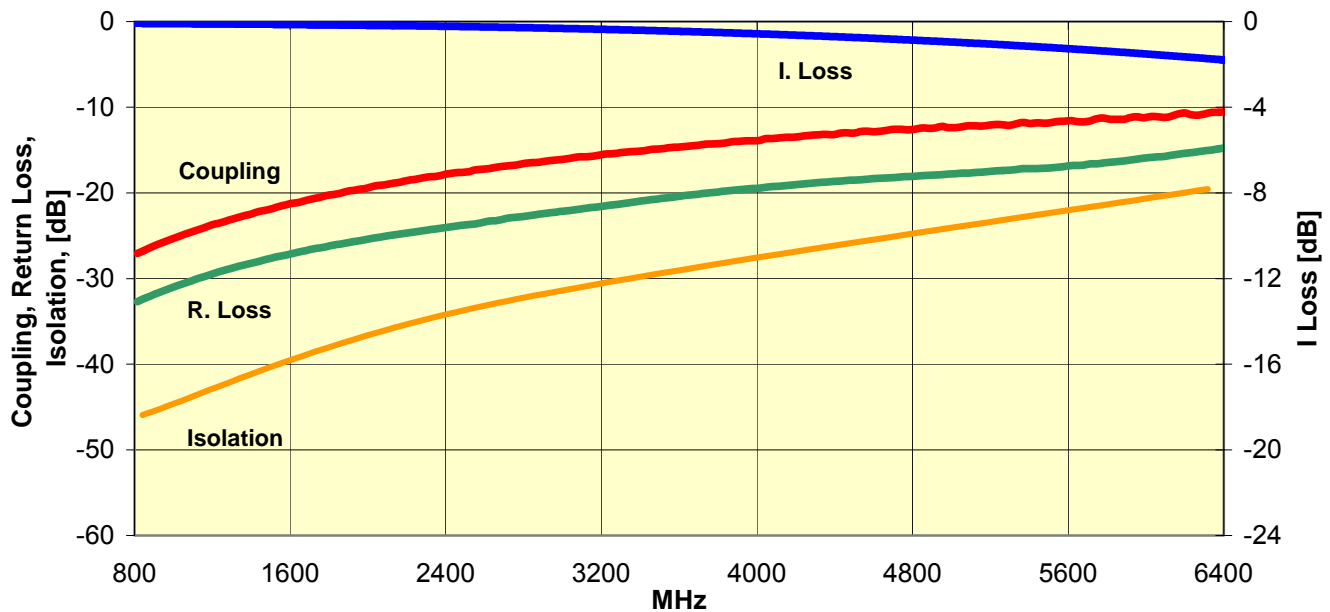

Important: Couplers can be used at any frequency within the indicated range.



# Thin-Film Directional Couplers



## CP0402 / CP0603 High Directivity Couplers Test Jigs

### GENERAL DESCRIPTION

These jigs are designed for testing the CP0402 and CP0603 High Directivity Couplers using a Vector Network Analyzer.

They consist of a dielectric substrate, having 50Ω microstrips as conducting lines and a bottom ground plane located at a distance of 0.254mm (0.010") from the microstrips.

The substrate used is Neltec's NH9338ST0254C1BC.

The connectors are SMA type (female), 'Johnson Components Inc.' Product P/N: 142-0701-841.

Both a measurement jig and a calibration jig are provided.

The calibration jig is designed for a full 2-port calibration, and consists of an open line, short line and through line. LOAD calibration can be done by a 50Ω SMA termination.

### MEASUREMENT PROCEDURE

When measuring a component, it can be either soldered or pressed using a non-metallic stick until all four ports touch the appropriate pads. Set the VNA to the relevant frequency band. Connect the VNA using a 10dB attenuator on the jig

terminal connected to port 2. Follow the VNA's instruction manual and use the [calibration jig](#) to perform a full 2-Port calibration in the required bandwidths.

3

#### Place the coupler on the [measurement jig](#) as follows:

Input (Coupler) → Connector 1 (Jig)      Termination (Coupler) → Connector 3 (Jig)  
Output (Coupler) → Connector 2 (Jig)      Coupling (Coupler) → Connector 4 (Jig)

#### To measure I. Loss connect:

Connector 1 (Jig) → Port 1 (VNA)      Connector 3 (Jig) → 50Ω  
Connector 2 (Jig) → Port 2 (VNA)      Connector 4 (Jig) → 50Ω

#### To measure R. Loss and Coupling connect:

Connector 1 (Jig) → Port 1 (VNA)      Connector 3 (Jig) → 50Ω  
Connector 2 (Jig) → 50Ω                  Connector 4 (Jig) → Port 2 (VNA)

#### To measure Isolation connect:

Connector 1 (Jig) → 50Ω                  Connector 3 (Jig) → 50Ω  
Connector 2 (Jig) → Port 1 (VNA)      Connector 4 (Jig) → Port 2 (VNA)

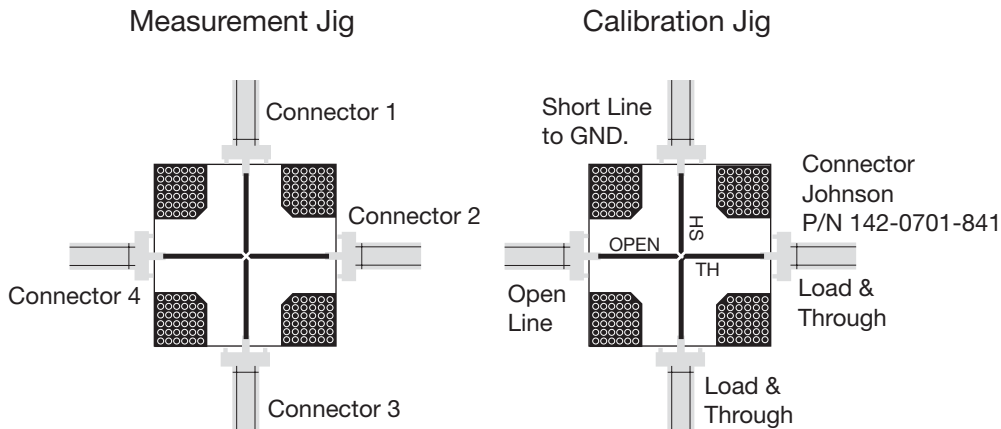

## X-ON Electronics

Largest Supplier of Electrical and Electronic Components

*Click to view similar products for [avx manufacturer](#):*

Other Similar products are found below :

[MD015A222JAB](#) [M39014/220755](#) [VE17M02750K--](#) [SV097C105MAA](#) [CX2016DB16000D0GPSC1](#) [AOL-1502-02](#) [LIFE\\_SAMP-1A139-159V001](#) [88011-154 RF](#) [CWR09HC106KBA](#) [00-8129-015-610-108](#) [PBRC7.37MR50X000](#) [M39014/22-1137-TUBE](#) [3640CC224KAT6A](#)  
[M39014/220778](#) [M39014/220458](#) [105061100000861+](#) [CDR12BP102AKUM](#) [CDR12BP330AJUR\M500](#) [18123A104FAT2A](#)  
[CDR12BP221AJUR\M500](#) [00 6224020001800](#) [LD12CC104KAB1A](#) [L08052R2DEWTR](#) [009286001203906](#) [M39014/22-1181](#)  
[F931A227KNC](#) [F931C227MNC](#) [FFLI6B3007KJE](#) [12102U101JAT2A](#) [KIT5000UZ](#) [KITTYPE1400 LF](#) [LD065A332FAB2A](#) [SA205C393JAA](#)  
[308016056000413](#) [SK052C105KAA](#) [SR211A151FAA](#) [F931A226MBA](#) [FFB24I0755K--](#) [CK06BX472K](#) [M39014/05-2731](#) [M39014/220476](#)  
[CWR29JC476KCHC](#) [TAJB225M035R](#) [TAJC107K006RNJ](#) [TAJD226K035RNJV](#) [TCH9107M035W0055U](#) [TLCU336M004XTA](#)  
[TPSA106K016R1000](#) [TPSD337K010R0150](#) [TPSE226K035R0200](#)