

## FEATURES

### Rail-to-rail input/output

Low power: 0.625 mA typical per amplifier at  $\pm 15$  V

Gain bandwidth product: 15.9 MHz at  $A_v = 100$  typical

Unity-gain crossover: 9.9 MHz typical

-3 dB closed-loop bandwidth: 13.9 MHz typical at  $\pm 15$  V

Low offset voltage: 100  $\mu$ V maximum (SOIC)

Unity-gain stable

High slew rate: 4.6 V/ $\mu$ s typical

Low noise: 3.9 nV/ $\sqrt{\text{Hz}}$  typical at 1 kHz

## APPLICATIONS

Battery-powered instrumentation

High-side and low-side sensing

Power supply control and protection

Telecommunications

DAC output amplifiers

ADC input buffers

## GENERAL DESCRIPTION

The ADA4084-2 (dual) and ADA4084-4 (quad) are single-supply, 10 MHz bandwidth amplifiers featuring rail-to-rail inputs and outputs. They are guaranteed to operate from 3 V to 30 V (or  $\pm 1.5$  V to  $\pm 15$  V).

These amplifiers are well suited for single-supply applications requiring both ac and precision dc performance. The combination of wide bandwidth, low noise, and precision makes the ADA4084-2 and ADA4084-4 useful in a wide variety of applications, including filters and instrumentation.

Other applications for these amplifiers include portable telecommunications equipment, power supply control and protection, and use as amplifiers or buffers for transducers with wide output ranges. Sensors requiring a rail-to-rail input amplifier include Hall effect, piezoelectric, and resistive transducers.

The ability to swing rail-to-rail at both the input and output enables designers to build multistage filters in single-supply systems and to maintain high signal-to-noise ratios.

The ADA4084-2 and ADA4084-4 are specified over the industrial temperature range of  $-40^\circ\text{C}$  to  $+125^\circ\text{C}$ . The dual ADA4084-2 is available in the 8-lead SOIC, MSOP, and LFCSP surface-mount packages, and the ADA4084-4 is offered in the 14-lead TSSOP and 16-lead LFCSP.

The ADA4084-2 and ADA4084-4 are members of a growing series of high voltage, low noise op amps offered by Analog Devices, Inc., (see Table 1).

### Rev. D

### Document Feedback

Information furnished by Analog Devices is believed to be accurate and reliable. However, no responsibility is assumed by Analog Devices for its use, nor for any infringements of patents or other rights of third parties that may result from its use. Specifications subject to change without notice. No license is granted by implication or otherwise under any patent or patent rights of Analog Devices. Trademarks and registered trademarks are the property of their respective owners.

## PIN CONFIGURATIONS

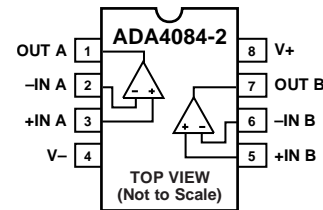

### NOTES

- FOR THE LFCSP PACKAGE THE EXPOSED PAD MUST BE CONNECTED TO V-.

08237-001

Figure 1. 8-Lead MSOP (RM), 8-Lead SOIC (R), 8-Lead LFCSP (CP)

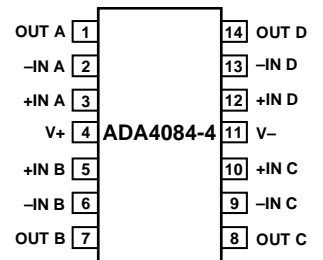
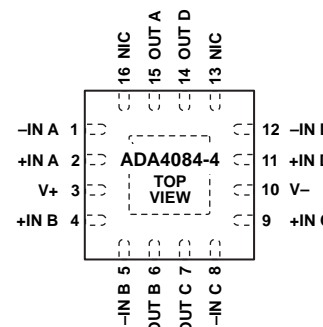

Figure 2. 14-Lead TSSOP (RU)



### NOTES

- NIC = NOT INTERNALLY CONNECTED.
- FOR THE LFCSP PACKAGE THE EXPOSED PAD MUST BE CONNECTED TO V-.

08237-103

Figure 3. 16-Lead LFCSP (CP)

For a more complete selection table of low input voltage noise amplifiers, see the [AN-940 Application Note, Low Noise Amplifier Selection Guide for Optimal Noise Performance](#), available at [www.analog.com](http://www.analog.com).

**Table 1. Low Noise Op Amps**

Voltage Noise	Single	Dual	Quad
1.1 nV/Hz	AD8597	AD8599	
1.8 nV/Hz	ADA4004-1	ADA4004-2	ADA4004-4
2.8 nV/Hz Rail-to-Rail Output	AD8675	AD8676	
2.8 nV/Hz	AD8671	AD8672	AD8674
3.2 nV/Hz	OP27/OP37		
3.9 nV/Hz Rail-to-Rail Input/Output		ADA4084-2	ADA4084-4

# IMPORTANT LINKS for the [ADA4084-2 4084-4](#)\*

Last content update 12/03/2013 04:11 pm

## SIMILAR PRODUCTS & PARAMETRIC SELECTION TABLES

### [ADA4077-2:](#)

available as a dual channel version in two grades offering lower offset and drift with higher linearity within the Input Voltage Range for dual supply applications.

### [ADA4500-2:](#)

offers similar speed and precision in a high linearity, zero-crossover, 5V Op Amp.

### [ADA4096-2](#)

a lower power, 30V, rail-to-rail input/output Op Amp.

[Find Similar Products By Operating Parameters](#)

[SAR ADC & Driver Quick-Match Guide](#)

## DOCUMENTATION

[AN-940: Low Noise Amplifier Selection Guide for Optimal Noise Performance](#)

[AN-849: Using Op Amps as Comparators](#)

[Op Amp Applications Handbook](#)

[MT-054: Precision Op Amps](#)

[MT-052: Op Amp Noise Figure: Don't Be Mislead](#)

[MT-048: Op Amp Noise Relationships: 1/f Noise, RMS Noise, and Equivalent Noise Bandwidth](#)

[MT-047: Op Amp Noise](#)

[MT-035: Op Amp Inputs, Outputs, Single-Supply, and Rail-to-Rail Issues](#)

## DESIGN TOOLS, MODELS, DRIVERS & SOFTWARE

[OpAmp Error Budget Calculator](#)

[ADIsimOpAmp™](#)

[Analog Bridge Wizard](#)

[ADA4084 SPICE Macro Model](#)

## EVALUATION KITS & SYMBOLS & FOOTPRINTS

[View the Evaluation Boards and Kits page for the ADA4084-2](#)

[View the Evaluation Boards and Kits page for the ADA4084-4](#)

[Symbols and Footprints for the ADA4084-2](#)

[Symbols and Footprints for the ADA4084-4](#)

## DESIGN COLLABORATION COMMUNITY



[Collaborate Online](#) with the ADI support team and other designers about select ADI products.

Follow us on Twitter: [www.twitter.com/ADI\\_News](http://www.twitter.com/ADI_News)

Like us on Facebook: [www.facebook.com/AnalogDevicesInc](http://www.facebook.com/AnalogDevicesInc)

## DESIGN SUPPORT

Submit your support request here:

[Linear and Data Converters](#)

[Embedded Processing and DSP](#)

Telephone our Customer Interaction Centers toll free:

Americas: 1-800-262-5643

Europe: 00800-266-822-82

China: 4006-100-006

India: 1800-419-0108

Russia: 8-800-555-45-90

[Quality and Reliability](#)

[Lead\(Pb\)-Free Data](#)

## SAMPLE & BUY

[ADA4084-2](#)

[ADA4084-4](#)

- [View Price & Packaging](#)
- [Request Evaluation Board](#)
- [Request Samples Check Inventory & Purchase](#)

[Find Local Distributors](#)

\* This page was dynamically generated by Analog Devices, Inc. and inserted into this data sheet.

Note: Dynamic changes to the content on this page (labeled 'Important Links') does not constitute a change to the revision number of the product data sheet.

This content may be frequently modified.



**TABLE OF CONTENTS**

Features .....	1	±15 V Characteristics .....	17
Applications.....	1	Applications Information .....	23
General Description .....	1	Functional Description.....	23
Pin Configurations .....	1	Start-Up Characteristics .....	24
Revision History .....	2	Input Protection .....	24
Specifications.....	3	Output Phase Reversal.....	24
Electrical Characteristics .....	3	Designing Low Noise Circuits in Single-Supply	
Absolute Maximum Ratings.....	6	Applications .....	25
Thermal Resistance .....	6	Comparator Operation.....	25
ESD Caution.....	6	Outline Dimensions .....	26
Typical Performance Characteristics .....	7	Ordering Guide .....	28
±1.5 V Characteristics.....	7		
±5 V Characteristics.....	12		

**REVISION HISTORY**

**11/13—Rev. C to Rev. D**

Added 14-Lead TSSOP and 16-Lead LFCSP	
Packages .....	Universal
Added ADA4804-4.....	Universal
Change to Features Section and Applications Section .....	1
Added Figure 2 and Figure 3; Renumbered Sequentially .....	1
Changes to Table 2.....	3
Changes to Table 3.....	4
Changes to Table 4.....	5
Changes to Table 5 and Table 6.....	6
Changes to Typical Performance Characteristics Section.....	7
Added Figure 101 .....	27
Added Figure 102; Changes to Ordering Guide.....	28

**4/13—Rev. B to Rev. C**

Changes to Figure 48 Caption.....	15
Updated Outline Dimensions .....	25

**6/12—Rev. A to Rev. B**

Added LFCSP Package .....	Universal
Changes to Figure 1.....	1
Changes to Output Voltage High Parameter, Table 4.....	5
Added Figure 5 and Figure 7, Renumbered Sequentially .....	7
Added Figure 30 and Figure 32 .....	12

Added Figure 55 and Figure 57 .....	17
Added Startup Characteristics Section.....	23
Moved Figure 78.....	23
Changes to Output Phase Reversal Section and Comparator	
Operation Section.....	24
Updated Outline Dimensions.....	25
Changes to Ordering Guide .....	26

**2/12—Rev. 0 to Rev. A**

Changes to Data Sheet Title .....	1
Changes to Voltage Range in General Description.....	1
Changes to Supply Current/Amplifier Parameter, Table 2 .....	3
Changes to Common-Mode Rejection Ratio Parameter, Table 3 ..	4
Changes to Common-Mode Rejection Ratio Parameter, Table 4 ..	5
Changes to Figure 2.....	6
Changes to Figure 24.....	10
Changes to Figure 32.....	12
Changes to Figure 47.....	14
Changes to Figure 55.....	16
Changes to Figure 62.....	17
Changes to Figure 73.....	20

**10/11—Revision 0: Initial Version**

## SPECIFICATIONS

## ELECTRICAL CHARACTERISTICS

$V_{SY} = 3\text{ V}$ ,  $V_{CM} = 1.5\text{ V}$ ,  $T_A = 25^\circ\text{C}$ , unless otherwise noted.

Table 2.

Parameter	Symbol	Test Conditions/Comments	Min	Typ	Max	Unit
INPUT CHARACTERISTICS						
Offset Voltage	$V_{OS}$	SOIC package		20	100	$\mu\text{V}$
		$-40^\circ\text{C} \leq T_A \leq +125^\circ\text{C}$			200	$\mu\text{V}$
		MSOP, TSSOP packages		50	130	$\mu\text{V}$
		$-40^\circ\text{C} \leq T_A \leq +125^\circ\text{C}$			250	$\mu\text{V}$
		ADA4084-2 LFCSP package		80	200	$\mu\text{V}$
Offset Voltage Drift	$\Delta V_{OS}/\Delta T$	$-40^\circ\text{C} \leq T_A \leq +125^\circ\text{C}$		0.5	1.75	$\mu\text{V}/^\circ\text{C}$
Offset Voltage Matching		$T_A = 25^\circ\text{C}$			150	$\mu\text{V}$
Input Bias Current	$I_B$	ADA4084-4 LFCSP package		140	250	nA
Input Offset Current		$-40^\circ\text{C} \leq T_A \leq +125^\circ\text{C}$			400	nA
Input Voltage Range	CMRR	$V_{CM} = 0\text{ V to } 3\text{ V}$ $-40^\circ\text{C} \leq T_A \leq +125^\circ\text{C}$				
			Common-Mode Rejection Ratio	64	88	
Large Signal Voltage Gain	$A_{VO}$	$R_L = 2\text{ k}\Omega$ , $0.5\text{ V} \leq V_O \leq 2.5\text{ V}$ $R_L = 2\text{ k}\Omega$ , $-40^\circ\text{C} \leq T_A \leq +125^\circ\text{C}$				
				60	104	
Input Impedance, Differential				100	1.1	$\text{k}\Omega    \text{pF}$
Input Impedance, Common Mode				80	2.9	$\text{M}\Omega    \text{pF}$
OUTPUT CHARACTERISTICS						
Output Voltage High	$V_{OH}$	$R_L = 10\text{ k}\Omega$ to $V_{CM}$ $-40^\circ\text{C} \leq T_A \leq +125^\circ\text{C}$	2.9	2.95		V
			2.8			V
		$R_L = 2\text{ k}\Omega$ to $V_{CM}$ $-40^\circ\text{C} \leq T_A \leq +125^\circ\text{C}$	2.85	2.9		V
			2.7			V
Output Voltage Low	$V_{OL}$	$R_L = 10\text{ k}\Omega$ to $V_{CM}$ $-40^\circ\text{C} \leq T_A \leq +125^\circ\text{C}$		10	20	mV
					40	mV
		$R_L = 2\text{ k}\Omega$ to $V_{CM}$ $-40^\circ\text{C} \leq T_A \leq +125^\circ\text{C}$		20	30	mV
					50	mV
Short-Circuit Current	$I_{SC}$			-17/+10	mA	
Closed-Loop Output Impedance	$Z_{OUT}$	$f = 1\text{ kHz}$ , $A = +1$		0.1		$\Omega$
POWER SUPPLY						
Power Supply Rejection Ratio	PSRR	$V_{SY} = \pm 1.25\text{ V to } \pm 1.75\text{ V}$ $-40^\circ\text{C} \leq T_A \leq +125^\circ\text{C}$	100	110		dB
Supply Current/Amplifier	$I_{SY}$	$I_O = 0\text{ mA}$ $-40^\circ\text{C} \leq T_A \leq +125^\circ\text{C}$		0.565	0.650	mA
					0.950	mA
DYNAMIC PERFORMANCE						
Slew Rate	SR	$R_L = 2\text{ k}\Omega$	2.0	2.6		$\text{V}/\mu\text{s}$
Gain Bandwidth Product	GBP	$V_{IN} = 5\text{ mV p-p}$ , $R_L = 10\text{ k}\Omega$ , $A_V = 100$		15.4		MHz
Unity-Gain Crossover	UGC	$V_{IN} = 5\text{ mV p-p}$ , $R_L = 10\text{ k}\Omega$ , $A_V = 1$		8.08		MHz
Phase Margin	$\Phi_M$			86		Degrees
-3 dB Closed-Loop Bandwidth	-3 dB	$A_V = 1$ , $V_{IN} = 5\text{ mV p-p}$		12.3		MHz
Settling Time	$t_S$	$A_V = 10$ , $V_{IN} = 2\text{V p-p}$ ; 0.1%		4		$\mu\text{s}$
Total Harmonic Distortion Plus Noise	THD + N	$V_{IN} = 300\text{ mV rms}$ , $R_L = 2\text{ k}\Omega$ , $f = 1\text{ kHz}$		0.009		%
NOISE PERFORMANCE						
Voltage Noise	$e_n$ p-p	0.1 Hz to 10 Hz		0.14		$\mu\text{V p-p}$
Voltage Noise Density	$e_n$	$f = 1\text{ kHz}$		3.9		$\text{nV}/\sqrt{\text{Hz}}$
Current Noise Density	$i_n$	$f = 1\text{ kHz}$		0.55		$\text{pA}/\sqrt{\text{Hz}}$

$V_{SY} = \pm 5.0\text{ V}$ ,  $V_{CM} = 0\text{ V}$ ,  $T_A = 25^\circ\text{C}$ , unless otherwise noted.

Table 3.

Parameter	Symbol	Conditions	Min	Typ	Max	Unit
<b>INPUT CHARACTERISTICS</b>						
Offset Voltage	$V_{OS}$	SOIC package		30	100	$\mu\text{V}$
		$-40^\circ\text{C} \leq T_A \leq +125^\circ\text{C}$			250	$\mu\text{V}$
		MSOP, TSSOP packages		60	130	$\mu\text{V}$
		$-40^\circ\text{C} \leq T_A \leq +125^\circ\text{C}$			250	$\mu\text{V}$
Offset Voltage Drift	$\Delta V_{OS}/\Delta T$	ADA4084-2 LFCSP package		90	200	$\mu\text{V}$
		$-40^\circ\text{C} \leq T_A \leq +125^\circ\text{C}$			300	$\mu\text{V}$
Offset Voltage Matching		$-40^\circ\text{C} \leq T_A \leq +125^\circ\text{C}$		0.5	1.75	$\mu\text{V}/^\circ\text{C}$
		$T_A = 25^\circ\text{C}$			150	$\mu\text{V}$
Input Bias Current	$I_B$	ADA4084-4 LFCSP package		140	200	$\mu\text{V}$
		$-40^\circ\text{C} \leq T_A \leq +125^\circ\text{C}$			250	nA
Input Offset Current	$I_{OS}$			5	25	nA
		$-40^\circ\text{C} \leq T_A \leq +125^\circ\text{C}$			50	nA
Input Voltage Range			-5		+5	V
Common-Mode Rejection Ratio	CMRR	$V_{CM} = \pm 4\text{ V}$ , $-40^\circ\text{C} \leq T_A \leq +125^\circ\text{C}$	106	124		dB
		$V_{CM} = \pm 5\text{ V}$	76			dB
		$V_{CM} = \pm 5\text{ V}$ , $-40^\circ\text{C} \leq T_A \leq +125^\circ\text{C}$	70			dB
Large Signal Voltage Gain	$A_{VO}$	$R_L = 2\text{ k}\Omega$ , $-4\text{ V} \leq V_O \leq 4\text{ V}$	108	112		dB
		$R_L = 2\text{ k}\Omega$ , $-40^\circ\text{C} \leq T_A \leq +125^\circ\text{C}$	103			dB
Input Impedance, Differential				100  1.1		$\text{k}\Omega  \text{pF}$
Input Impedance, Common Mode				200  2.5		$\text{M}\Omega  \text{pF}$
<b>OUTPUT CHARACTERISTICS</b>						
Output Voltage High	$V_{OH}$	$R_L = 10\text{ k}\Omega$ to $V_{CM}$	4.9	4.95		V
		$-40^\circ\text{C} \leq T_A \leq +125^\circ\text{C}$	4.8			V
		$R_L = 2\text{ k}\Omega$ to $V_{CM}$	4.8	4.85		V
		$-40^\circ\text{C} \leq T_A \leq +125^\circ\text{C}$	4.7			V
Output Voltage Low	$V_{OL}$	$R_L = 10\text{ k}\Omega$ to $V_{CM}$		-4.95	-4.9	V
		$-40^\circ\text{C} \leq T_A \leq +125^\circ\text{C}$			-4.8	V
		$R_L = 2\text{ k}\Omega$ to $V_{CM}$		-4.95	-4.8	V
		$-40^\circ\text{C} \leq T_A \leq +125^\circ\text{C}$			-4.7	V
Short-Circuit Current	$I_{SC}$			-24/+17		mA
Closed-Loop Output Impedance	$Z_{OUT}$	$f = 1\text{ kHz}$ , $A = +1$		0.1		$\Omega$
<b>POWER SUPPLY</b>						
Power Supply Rejection Ratio	PSRR	$V_{SY} = \pm 2\text{ V}$ to $\pm 18\text{ V}$	110	120		dB
		$-40^\circ\text{C} \leq T_A \leq +125^\circ\text{C}$	105			dB
Supply Current/Amplifier	$I_{SY}$	$I_O = 0\text{ mA}$		0.595	0.700	mA
		$-40^\circ\text{C} \leq T_A \leq +125^\circ\text{C}$			1.00	mA
<b>DYNAMIC PERFORMANCE</b>						
Slew Rate	SR	$R_L = 2\text{ k}\Omega$ to $V_{CM}$	2.4	3.7		$\text{V}/\mu\text{s}$
Gain Bandwidth Product	GBP	$V_{IN} = 5\text{ mV p-p}$ , $R_L = 10\text{ k}\Omega$ , $A_v = 100$		15.9		MHz
Unity-Gain Crossover	UGC	$V_{IN} = 5\text{ mV p-p}$ , $R_L = 10\text{ k}\Omega$ , $A_v = 1$		9.6		MHz
Phase Margin	$\Phi_M$			85		Degrees
-3 dB Closed-Loop Bandwidth	-3 dB	$A_v = 1$ , $V_{IN} = 5\text{ mV p-p}$		13.9		MHz
Settling Time	$t_S$	$A_v = 10$ , $V_{IN} = 8\text{ V p-p}$ ; 0.1%		4		$\mu\text{s}$
Total Harmonic Distortion Plus Noise	THD + N	$V_{IN} = 2\text{ V rms}$ , $R_L = 2\text{ k}\Omega$ , $f = 1\text{ kHz}$		0.003		%
<b>NOISE PERFORMANCE</b>						
Voltage Noise	$e_n$ p-p	0.1 Hz to 10 Hz		0.14		$\mu\text{V p-p}$
Voltage Noise Density	$e_n$	$f = 1\text{ kHz}$		3.9		$\text{nV}/\sqrt{\text{Hz}}$
Current Noise Density	$i_n$			0.55		$\text{pA}/\sqrt{\text{Hz}}$

$V_{SY} = \pm 15.0\text{ V}$ ,  $V_{CM} = 0\text{ V}$ ,  $T_A = 25^\circ\text{C}$ , unless otherwise noted.

Table 4.

Parameter	Symbol	Conditions	Min	Typ	Max	Unit
<b>INPUT CHARACTERISTICS</b>						
Offset Voltage	$V_{OS}$	SOIC package $-40^\circ\text{C} \leq T_A \leq +125^\circ\text{C}$		40	100	$\mu\text{V}$
		$-40^\circ\text{C} \leq T_A \leq +125^\circ\text{C}$			200	$\mu\text{V}$
		MSOP, TSSOP packages $-40^\circ\text{C} \leq T_A \leq +125^\circ\text{C}$		70	130	$\mu\text{V}$
		$-40^\circ\text{C} \leq T_A \leq +125^\circ\text{C}$			250	$\mu\text{V}$
		ADA4084-2 LFCSP package $-40^\circ\text{C} \leq T_A \leq +125^\circ\text{C}$		100	200	$\mu\text{V}$
		$-40^\circ\text{C} \leq T_A \leq +125^\circ\text{C}$			300	$\mu\text{V}$
Offset Voltage Drift	$\Delta V_{OS}/\Delta T$			0.5	1.75	$\mu\text{V}/^\circ\text{C}$
Offset Voltage Matching		$T_A = 25^\circ\text{C}$			150	$\mu\text{V}$
		ADA4084-4 LFCSP package			200	$\mu\text{V}$
Input Bias Current	$I_B$			140	250	nA
		$-40^\circ\text{C} \leq T_A \leq +125^\circ\text{C}$			400	nA
Input Offset Current	$I_{OS}$			5	25	nA
		$-40^\circ\text{C} \leq T_A \leq +125^\circ\text{C}$			50	nA
Input Voltage Range			-15		+15	V
Common-Mode Rejection Ratio	CMRR	$V_{CM} = \pm 14\text{ V}$ , $-40^\circ\text{C} \leq T_A \leq +125^\circ\text{C}$	106	124		dB
		$V_{CM} = \pm 15\text{ V}$	85			dB
		$V_{CM} = \pm 15\text{ V}$ , $-40^\circ\text{C} \leq T_A \leq +125^\circ\text{C}$	80			dB
Large Signal Voltage Gain	$A_{VO}$	$R_L = 2\text{ k}\Omega$ , $-13.5\text{ V} \leq V_O \leq +13.5\text{ V}$ $-40^\circ\text{C} \leq T_A \leq +125^\circ\text{C}$	110	117		dB
			105			dB
Input Impedance, Differential				100  1.1		k $\Omega$   pF
Input Impedance, Common Mode				200  2.5		M $\Omega$   pF
<b>OUTPUT CHARACTERISTICS</b>						
Output Voltage High	$V_{OH}$	$R_L = 10\text{ k}\Omega$ to $V_{CM}$ $-40^\circ\text{C} \leq T_A \leq +125^\circ\text{C}$	14.85	14.9		V
		$-40^\circ\text{C} \leq T_A \leq +125^\circ\text{C}$	14.8			V
		$R_L = 2\text{ k}\Omega$ to $V_{CM}$ $-40^\circ\text{C} \leq T_A \leq +125^\circ\text{C}$	14.5	14.6		V
		$-40^\circ\text{C} \leq T_A \leq +125^\circ\text{C}$	14.0			V
Output Voltage Low	$V_{OL}$	$R_L = 10\text{ k}\Omega$ to $V_{CM}$ $-40^\circ\text{C} \leq T_A \leq +125^\circ\text{C}$		-14.95	-14.9	V
		$-40^\circ\text{C} \leq T_A \leq +125^\circ\text{C}$			-14.8	V
		$R_L = 2\text{ k}\Omega$ to $V_{CM}$ $-40^\circ\text{C} \leq T_A \leq +125^\circ\text{C}$		-14.9	-14.80	V
		$-40^\circ\text{C} \leq T_A \leq +125^\circ\text{C}$			-14.7	V
Short-Circuit Current	$I_{SC}$			$\pm 30$		mA
Closed-Loop Output Impedance	$Z_{OUT}$	$f = 1\text{ kHz}$ , $A = +1$		0.1		$\Omega$
<b>POWER SUPPLY</b>						
Power Supply Rejection Ratio	PSRR	$V_{SY} = \pm 2\text{ V}$ to $\pm 18\text{ V}$ $-40^\circ\text{C} \leq T_A \leq +125^\circ\text{C}$	110	120		dB
			105			dB
Supply Current/Amplifier	$I_{SY}$	$I_O = 0\text{ mA}$ $-40^\circ\text{C} \leq T_A \leq +125^\circ\text{C}$		0.625	0.750	mA
					1.050	mA
<b>DYNAMIC PERFORMANCE</b>						
Slew Rate	SR	$R_L = 2\text{ k}\Omega$	2.4	4.6		V/ $\mu\text{s}$
Gain Bandwidth Product	GBP	$V_{IN} = 5\text{ mV p-p}$ , $R_L = 10\text{ k}\Omega$ , $A_V = 100$		15.9		MHz
Unity-Gain Crossover	UGC	$V_{IN} = 5\text{ mV p-p}$ , $R_L = 10\text{ k}\Omega$ , $A_V = 1$		9.9		MHz
Phase Margin	$\Phi_M$			86		Degrees
-3 dB Closed-Loop Bandwidth	-3 dB	$A_V = 1$ , $V_{IN} = 5\text{ mV p-p}$		13.9		MHz
Settling Time	$t_S$	$A_V = 10$ , $V_{IN} = 10\text{ V p-p}$ ; 0.1%		4		$\mu\text{s}$
Total Harmonic Distortion Plus Noise	THD + N	$V_{IN} = 5\text{ V rms}$ , $R_L = 2\text{ k}\Omega$ , $f = 1\text{ kHz}$		0.003		%
<b>NOISE PERFORMANCE</b>						
Voltage Noise	$e_n$ p-p	0.1 Hz to 10 Hz		0.1		$\mu\text{V p-p}$
Voltage Noise Density	$e_n$	$f = 1\text{ kHz}$		3.9		nV/ $\sqrt{\text{Hz}}$
Current Noise Density	$i_n$			0.55		pA/ $\sqrt{\text{Hz}}$

# ABSOLUTE MAXIMUM RATINGS

Table 5.

Parameter	Rating
Supply Voltage	±18 V
Input Voltage	$V- \leq V_{IN} \leq V+$
Differential Input Voltage <sup>1</sup>	±0.6 V
Output Short-Circuit Duration to GND	Indefinite
Storage Temperature Range	-65°C to +150°C
Operating Temperature Range	-40°C to +125°C
Junction Temperature Range	-65°C to +150°C
Lead Temperature (Soldering 60 sec)	300°C
<b>ESD</b>	
Human Body Model <sup>2</sup>	4.5 kV
Machine Model <sup>3</sup>	1.25 kV
Field-Induced Charged-Device Model (FICDM) <sup>4</sup>	200 V

<sup>1</sup> For input differential voltages greater than 0.6 V, limit the input current to less than 5 mA to prevent degradation or destruction of the input devices.

<sup>2</sup> Applicable standard: MIL-STD-883, Method 3015.7.

<sup>3</sup> Applicable standard: JESD22-A115-A (ESD machine model standard of JEDEC).

<sup>4</sup> Applicable standard: JESD22-C101-C (ESD FICDM standard of JEDEC).

Stresses above those listed under Absolute Maximum Ratings may cause permanent damage to the device. This is a stress rating only; functional operation of the device at these or any other conditions above those indicated in the operational section of this specification is not implied. Exposure to absolute maximum rating conditions for extended periods may affect device reliability.

## THERMAL RESISTANCE

$\theta_{JA}$  is specified for the device soldered on a 4-layer JEDEC standard printed circuit board (PCB) with zero airflow.

Table 6. Thermal Resistance

Package Type	$\theta_{JA}$	$\theta_{JC}$	Unit
8-Lead SOIC-N (R-8)	121	43	°C/W
8-Lead MSOP (RM-8)	142	45	°C/W
8-Lead LFCSP <sup>1,3</sup> (CP-8-12)	84	40	°C/W
14-Lead TSSOP (RU-14)	112	43	°C/W
16-Lead LFCSP (CP-16-26) <sup>2,3</sup>	55	30	°C/W

<sup>1</sup> Values are based on 4-layer (2S2P) JEDEC standard PCB, with four thermal vias. Exposed pad soldered to PCB.

<sup>2</sup> Values are based on 4-layer (2S2P) JEDEC standard PCB, with nine thermal vias. Exposed pad soldered to PCB.

<sup>3</sup>  $\theta_{JC}$  measured on top of package.

## ESD CAUTION



**ESD (electrostatic discharge) sensitive device.** Charged devices and circuit boards can discharge without detection. Although this product features patented or proprietary protection circuitry, damage may occur on devices subjected to high energy ESD. Therefore, proper ESD precautions should be taken to avoid performance degradation or loss of functionality.

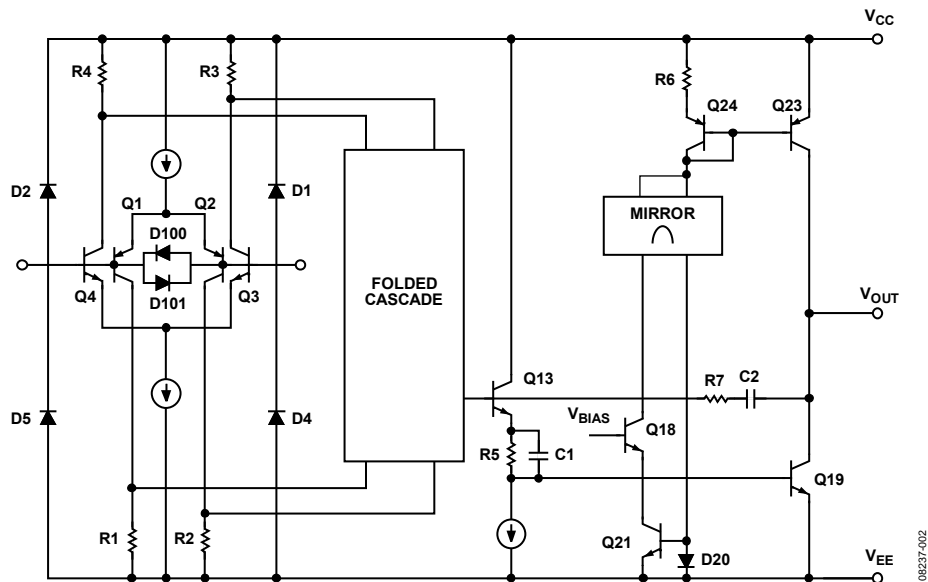

Figure 4. Simplified Schematic

# TYPICAL PERFORMANCE CHARACTERISTICS

T<sub>A</sub> = 25°C, unless otherwise noted.

## ±1.5 V CHARACTERISTICS

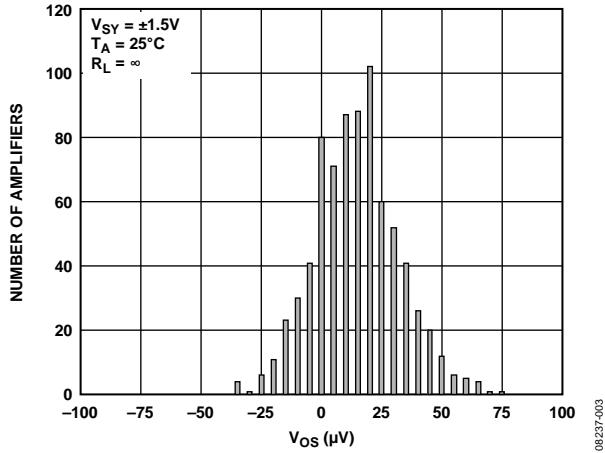

Figure 5. Input Offset Voltage Distribution, SOIC

08237-003

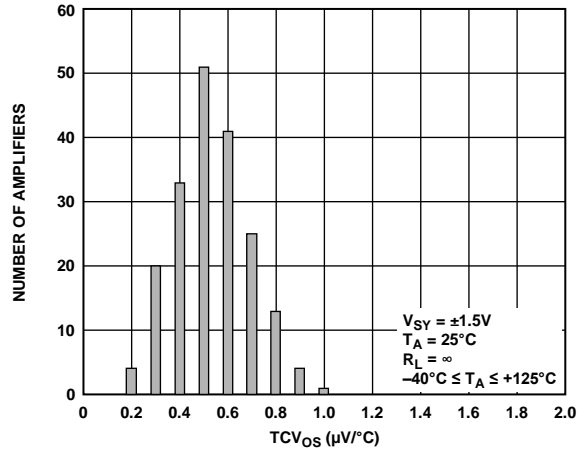

Figure 8. TCV<sub>OS</sub> Distribution, SOIC, MSOP, and TSSOP

08237-005

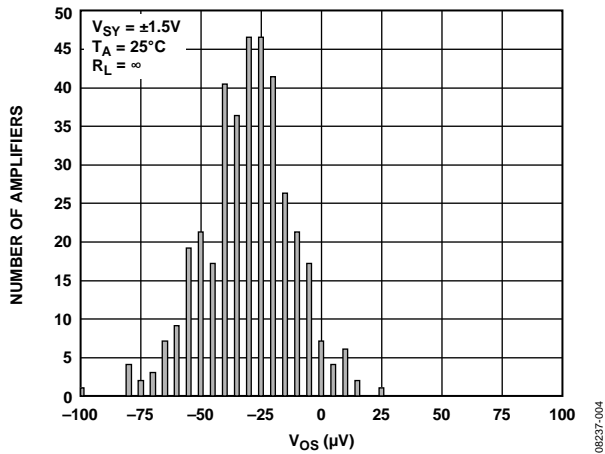

Figure 6. Input Offset Voltage Distribution, MSOP and TSSOP

08237-004

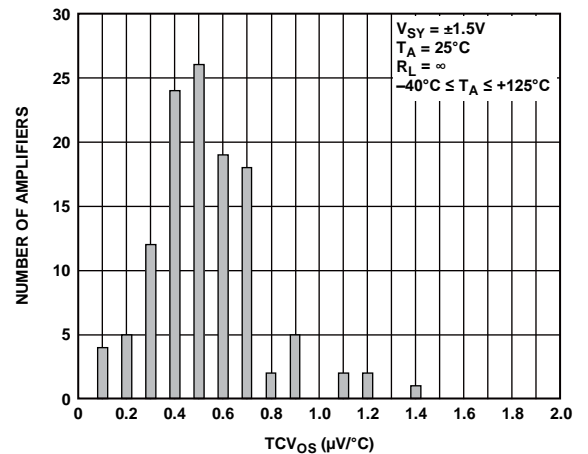

Figure 9. TCV<sub>OS</sub> Distribution, LFCSP

08237-082

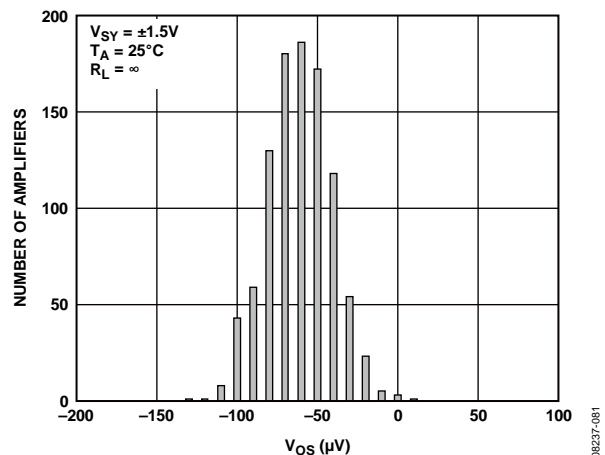

Figure 7. Input Offset Voltage Distribution, ADA4084-2 LFCSP

08237-081

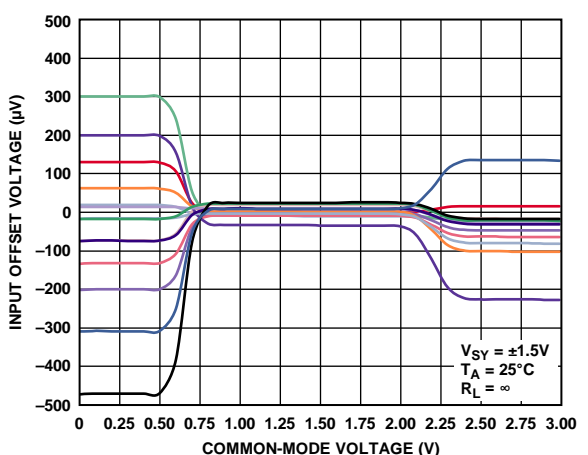

Figure 10. Input Offset Voltage vs. Common-Mode Voltage

08237-086



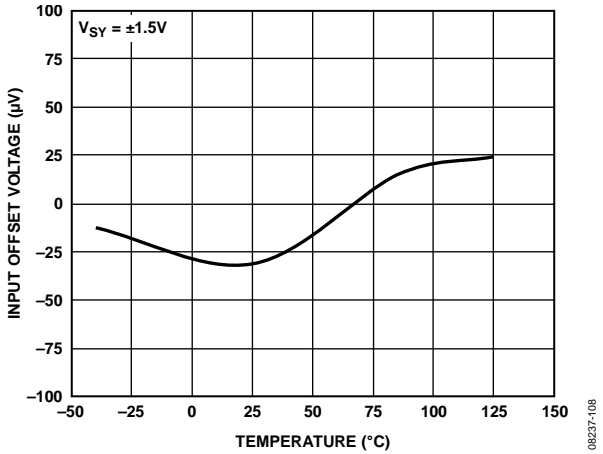

Figure 11. Input Offset Voltage vs. Temperature

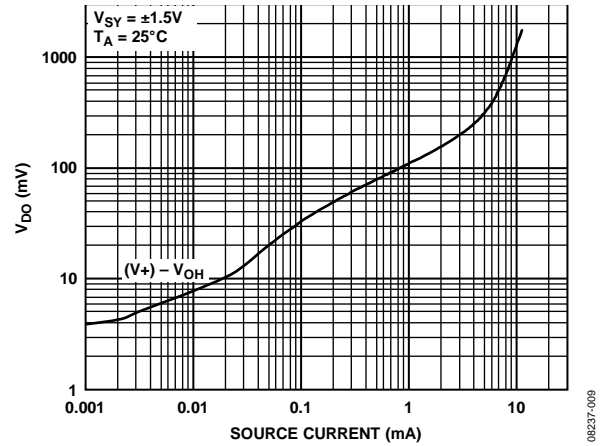

Figure 14. Dropout Voltage vs. Source Current

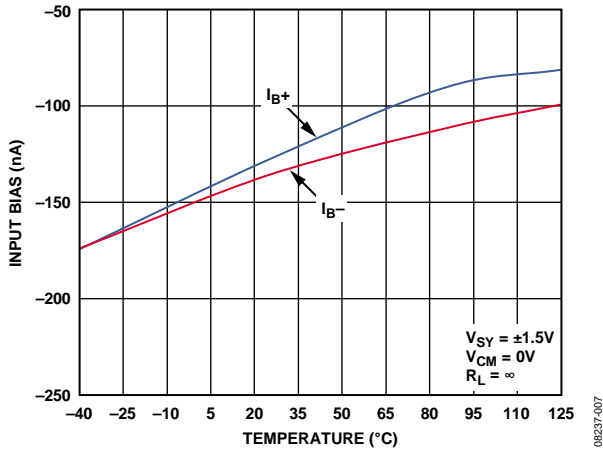

Figure 12. Input Bias Current vs. Temperature

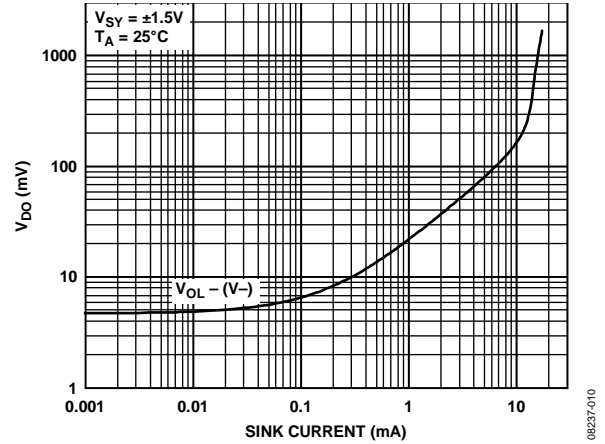

Figure 15. Dropout Voltage vs. Sink Current

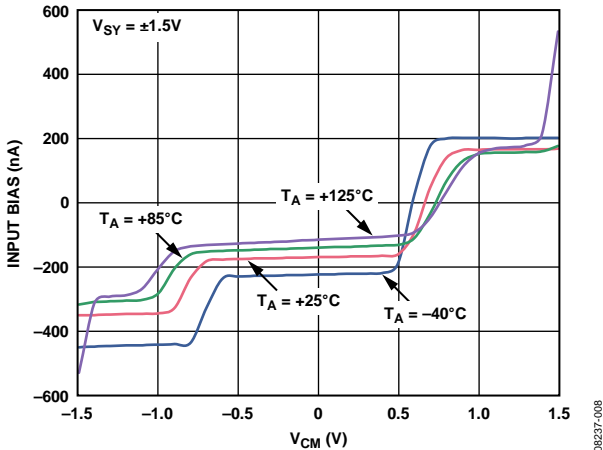

Figure 13. Input Bias Current vs.  $V_{CM}$  and Temperature

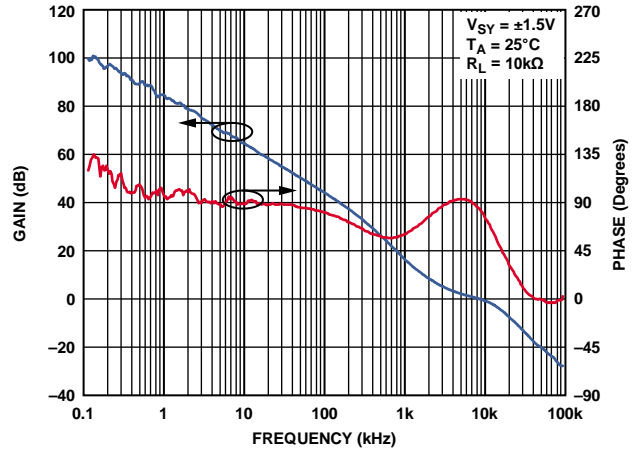

Figure 16. Open-Loop Gain and Phase vs. Frequency

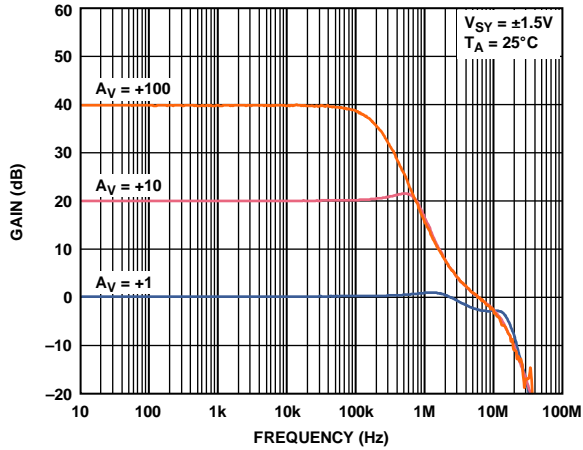

Figure 17. Closed-Loop Gain vs. Frequency

08237-012

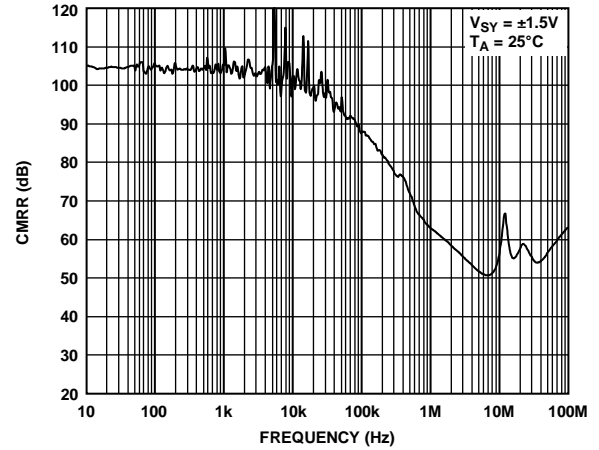

Figure 20. CMRR vs. Frequency

08237-015

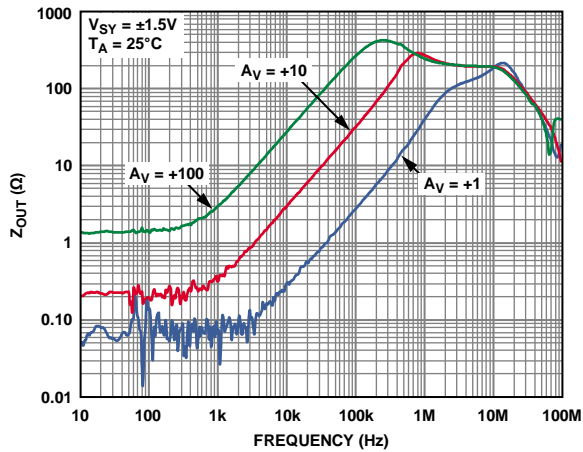

Figure 18. Output Impedance vs. Frequency

08237-013

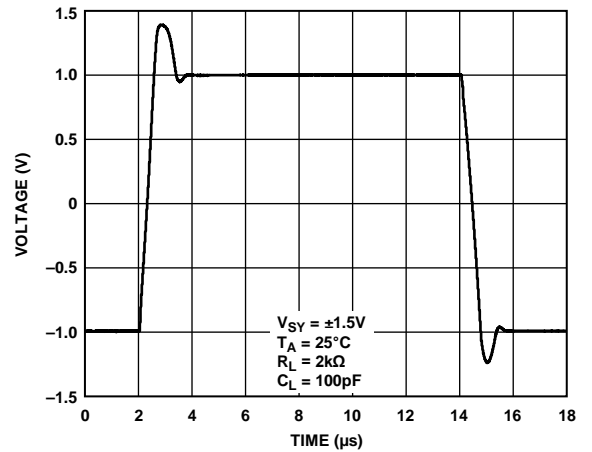

Figure 21. Large Signal Transient Response

08237-016

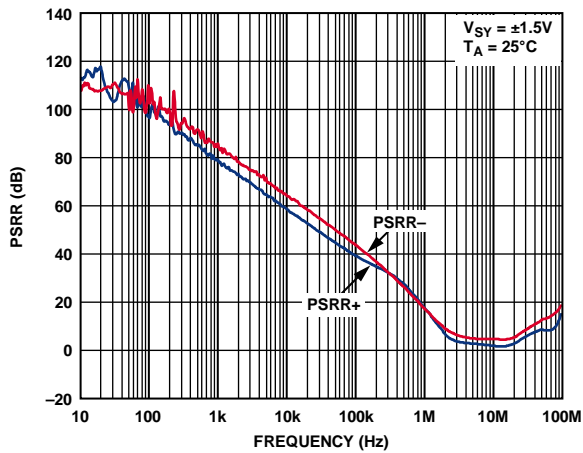

Figure 19. PSRR vs. Frequency

08237-014

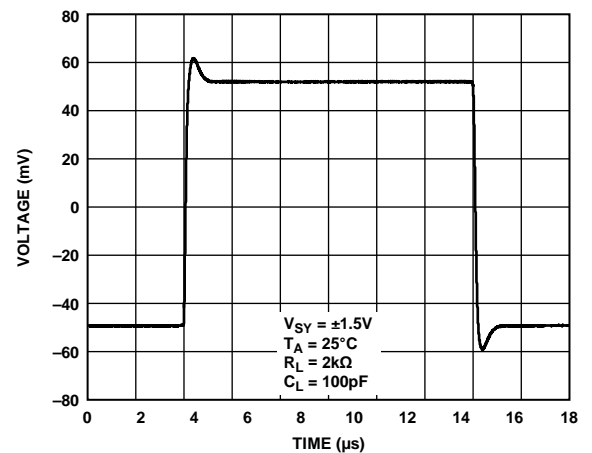

Figure 22. Small Signal Transient Response

08237-017

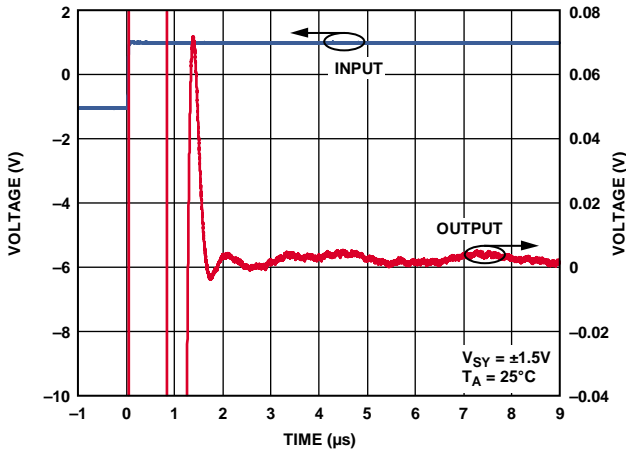

Figure 23. Settling Time

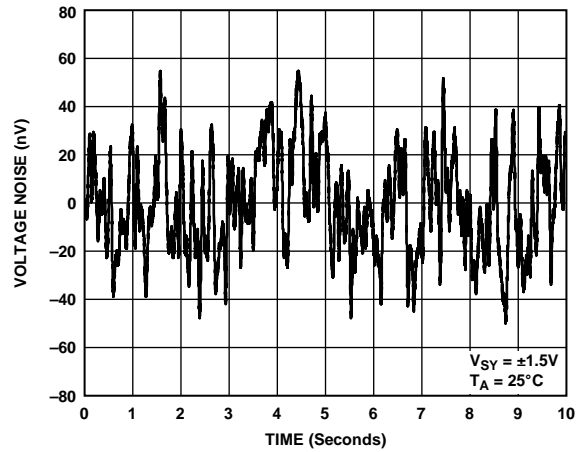

Figure 26. Voltage Noise, 0.1 Hz to 10 Hz

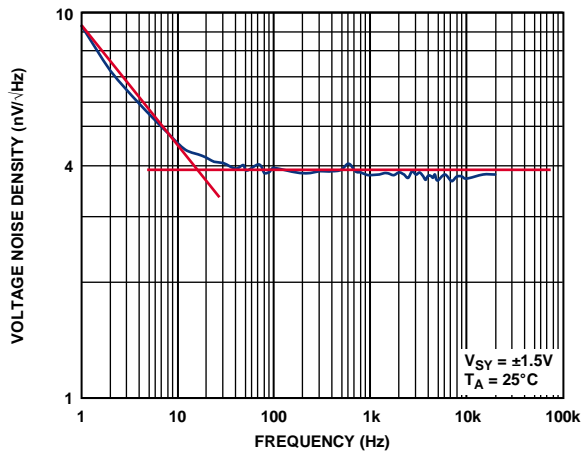

Figure 24. Voltage Noise Density

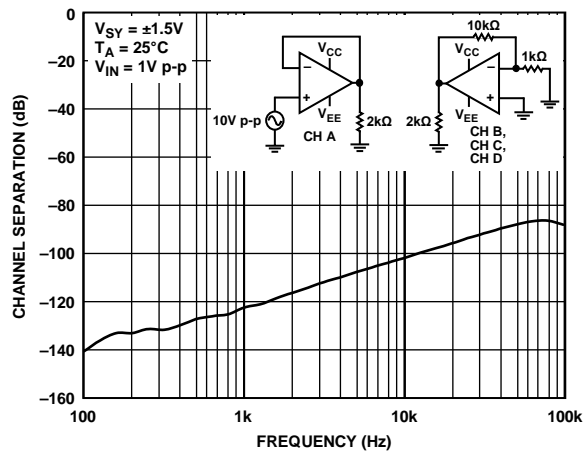

Figure 27. Channel Separation

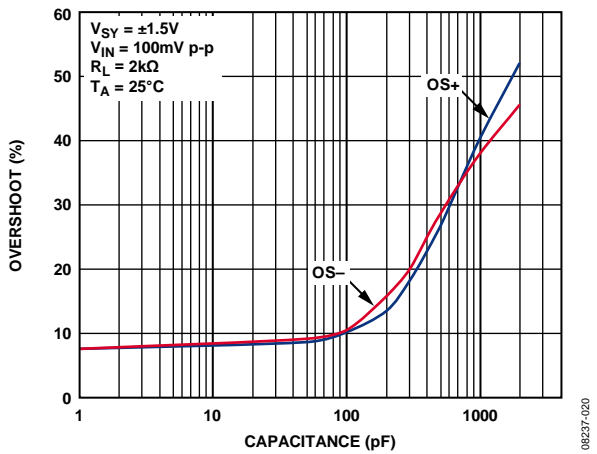

Figure 25. Overshoot vs. Load Capacitance

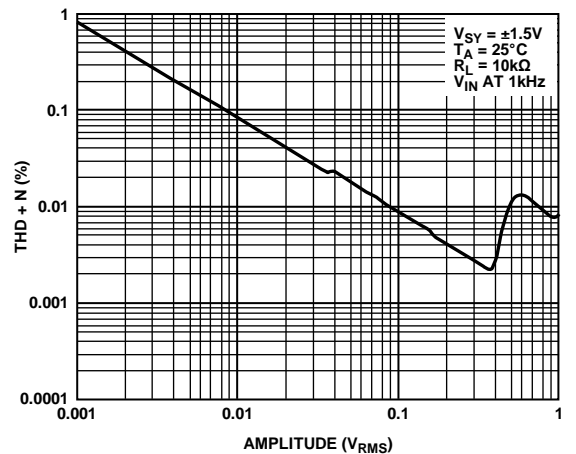

Figure 28. THD + N vs. Amplitude

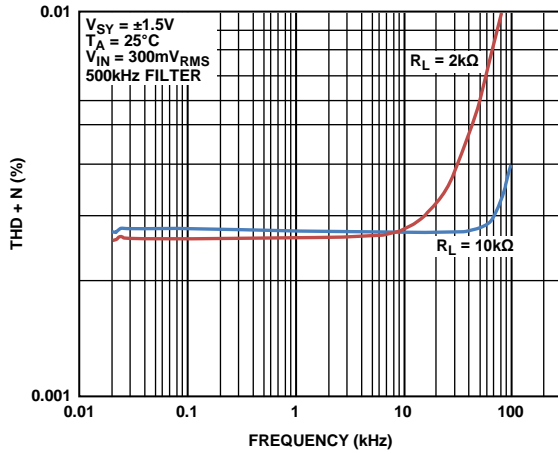

Figure 29. THD + N vs. Frequency

08237-126

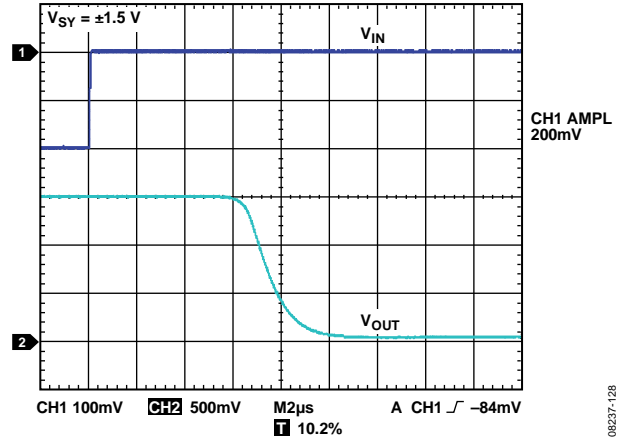

Figure 31. Positive Overload Recovery

08237-128

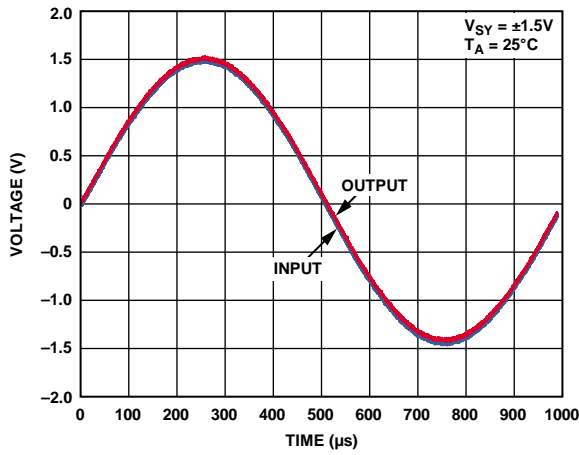

Figure 30. No Phase Reversal

08237-025

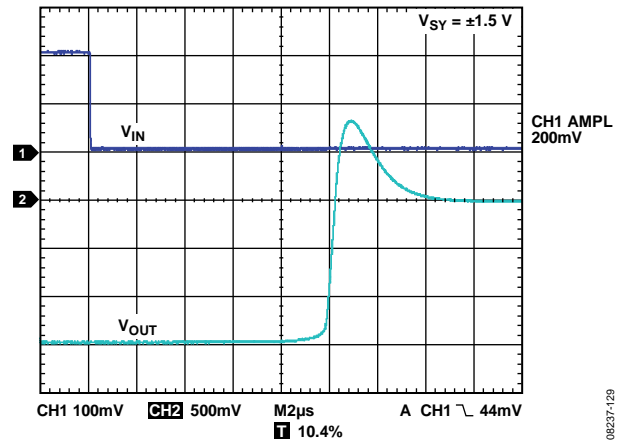

Figure 32. Negative Overload Recovery

08237-129

±5 V CHARACTERISTICS

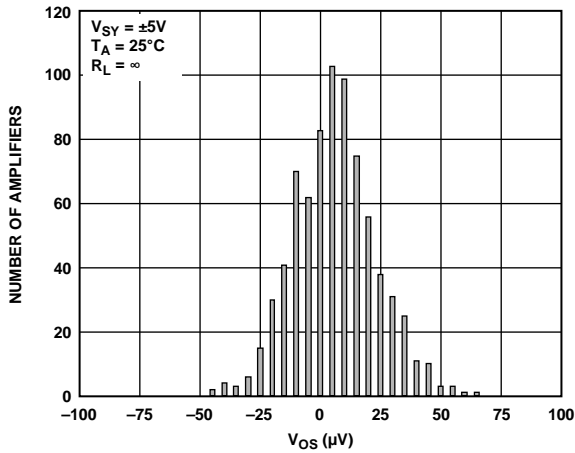

Figure 33. Input Offset Voltage Distribution, SOIC

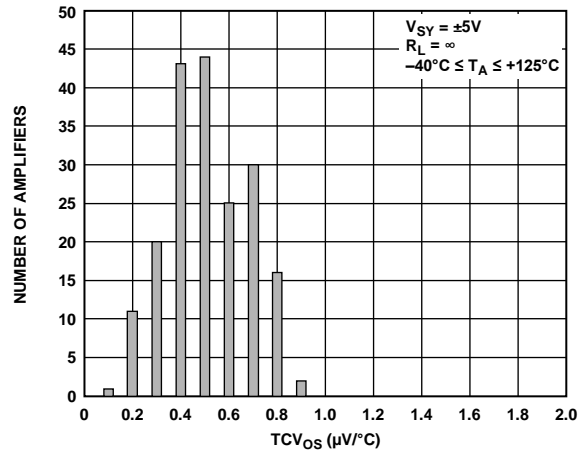

Figure 36.  $TCV_{OS}$  Distribution, SOIC and MSOP

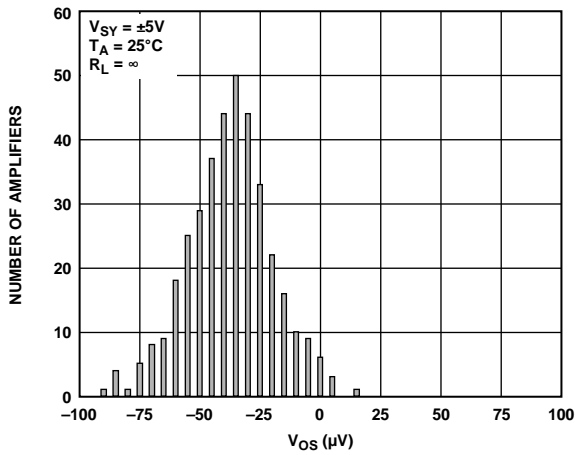

Figure 34. Input Offset Voltage Distribution, MSOP

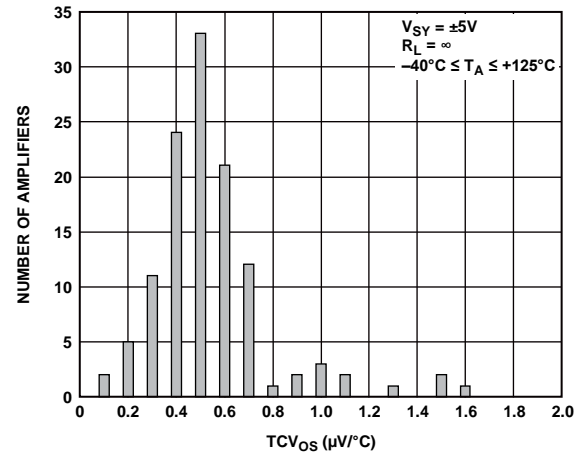

Figure 37.  $TCV_{OS}$  Distribution, ADA4084-2 LFCSP

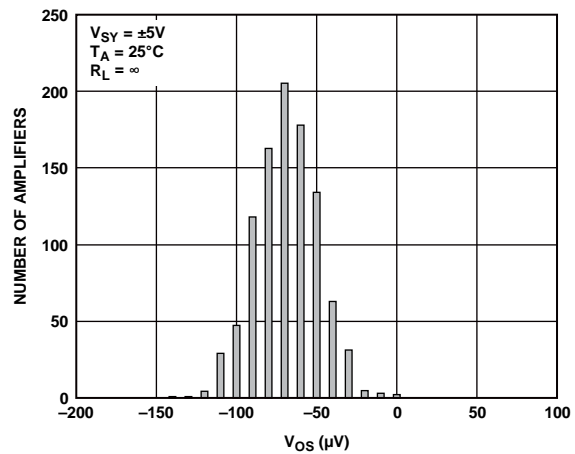

Figure 35. Input Offset Voltage Distribution, ADA4084-2 LFCSP

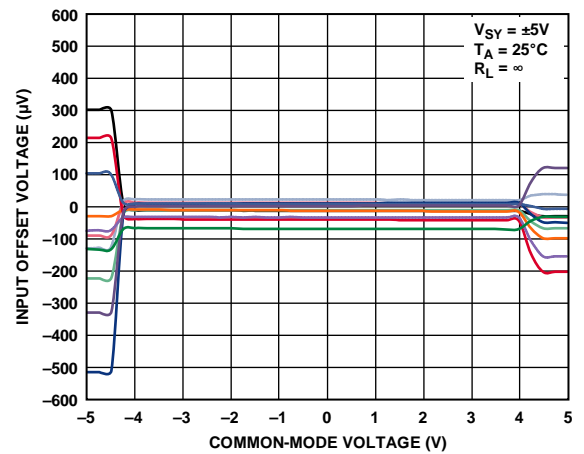

Figure 38. Input Offset Voltage vs. Common-Mode Voltage

08237-028

08237-028

08237-027

08237-084

08237-080

08237-029

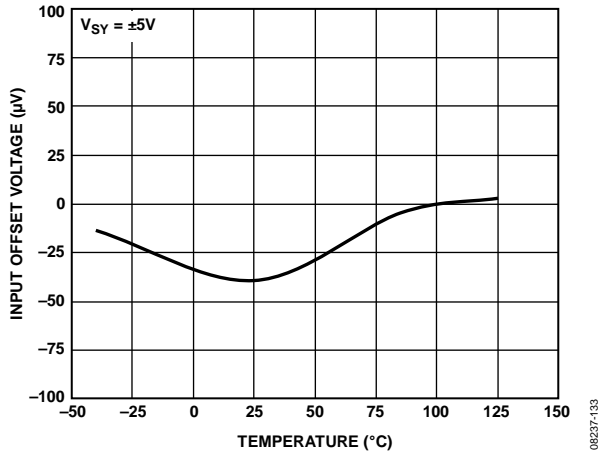

Figure 39. Input Offset Voltage vs. Temperature

08237-032

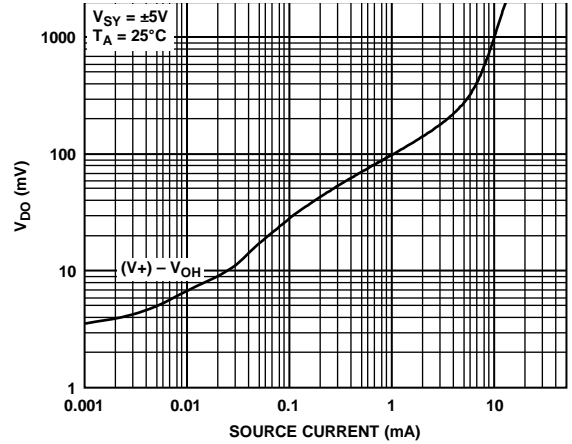

Figure 42. Dropout Voltage vs. Source Current

08237-032

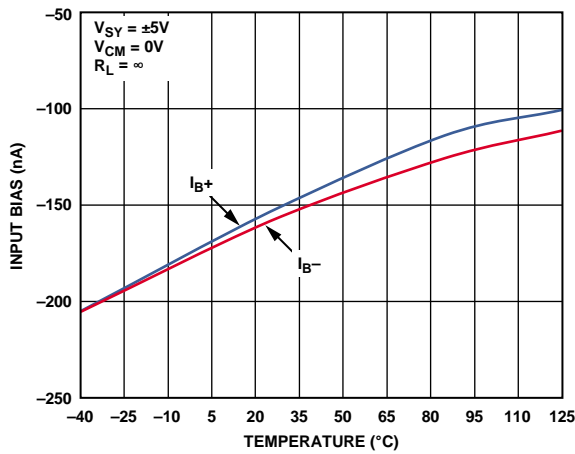

Figure 40. Input Bias Current vs. Temperature

08237-030

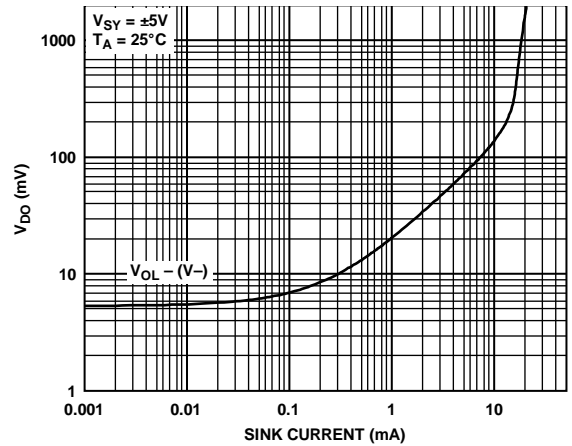

Figure 43. Dropout Voltage vs. Sink Current

08237-033

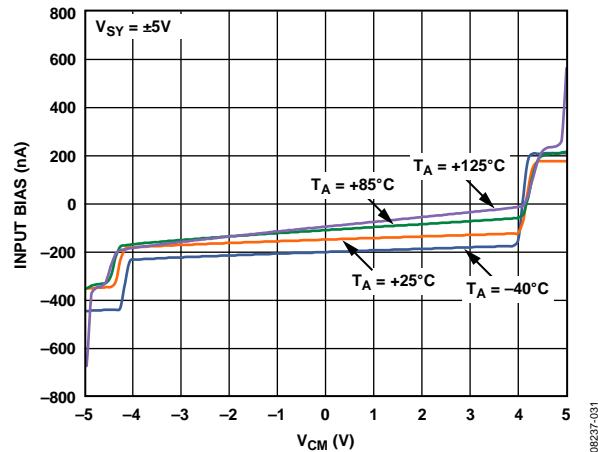

Figure 41. Input Bias Current vs.  $V_{CM}$  and Temperature

08237-031

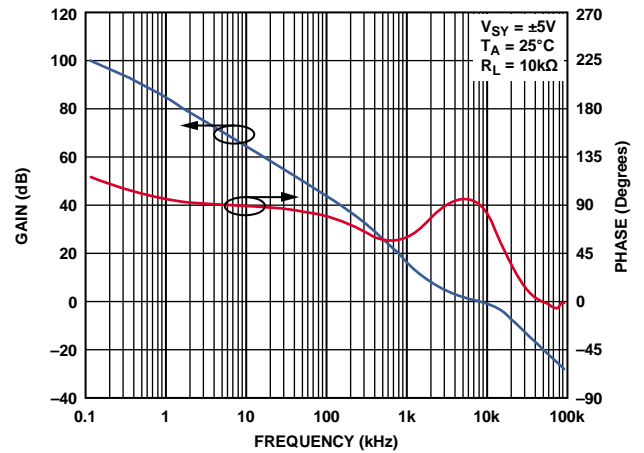

Figure 44. Open-Loop Gain and Phase vs. Frequency

08237-034

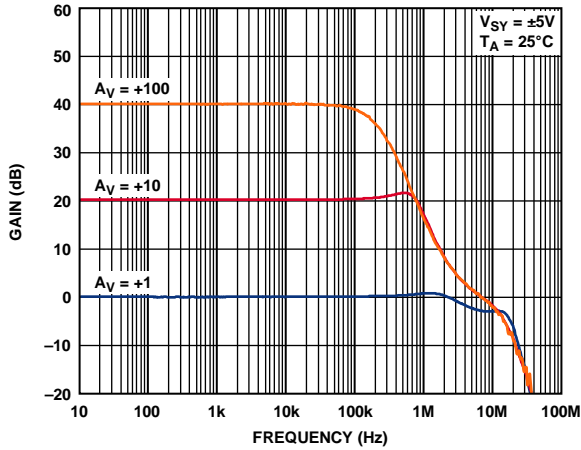

Figure 45. Closed-Loop Gain vs. Frequency

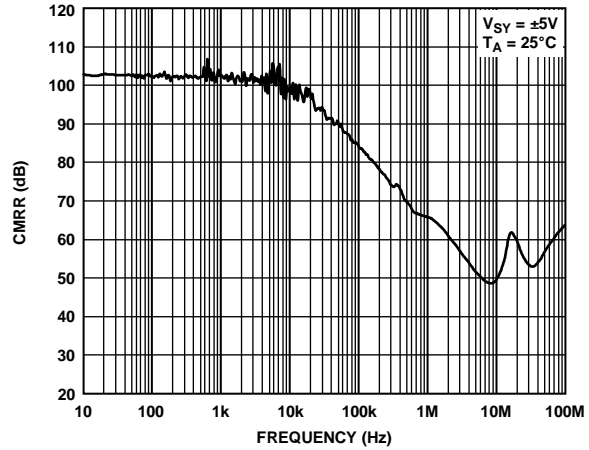

Figure 48. CMRR vs. Frequency

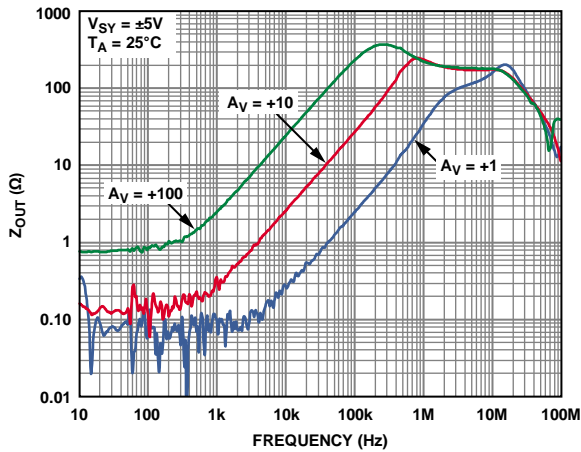

Figure 46. Output Impedance vs. Frequency

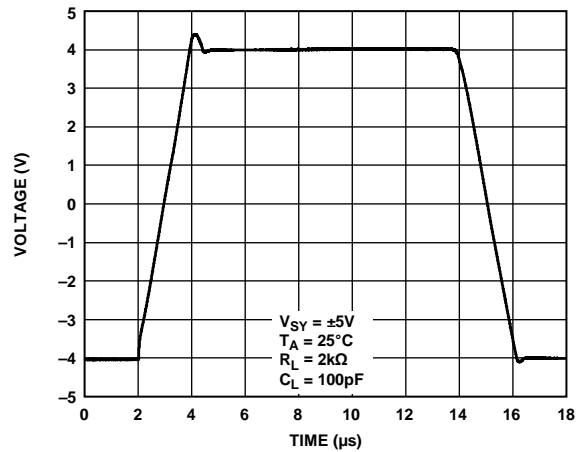

Figure 49. Large Signal Transient Response

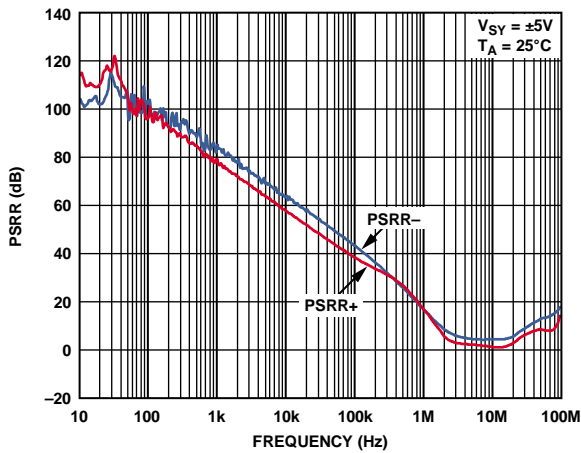

Figure 47. PSRR vs. Frequency

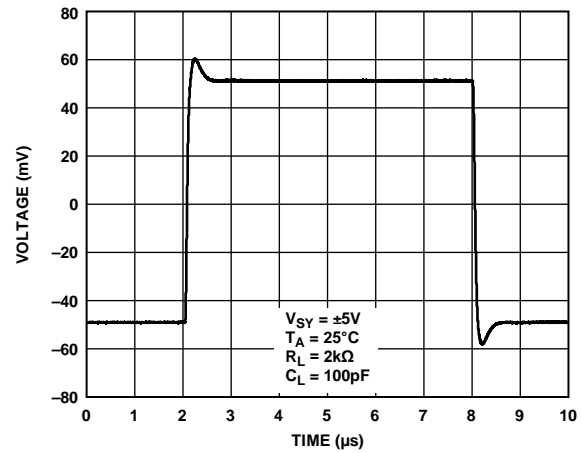

Figure 50. Small Signal Transient Response

08237-035

08237-038

08237-036

08237-039

08237-037

08237-040

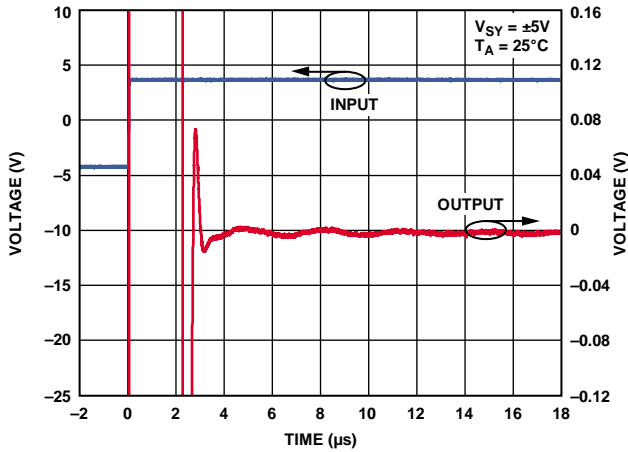

Figure 51. Settling Time

08237-041

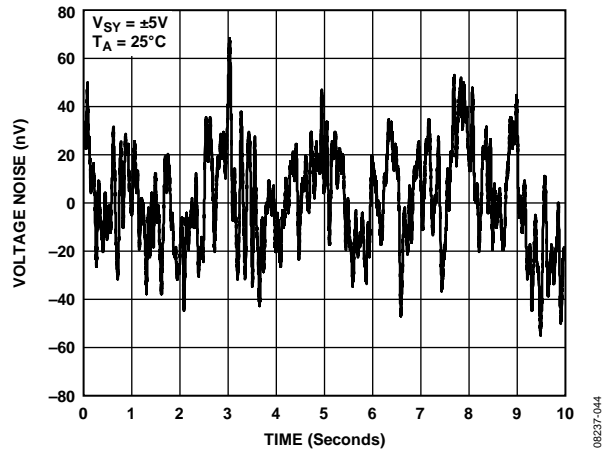

Figure 54. Voltage Noise, 0.1 Hz to 10 Hz

08237-044

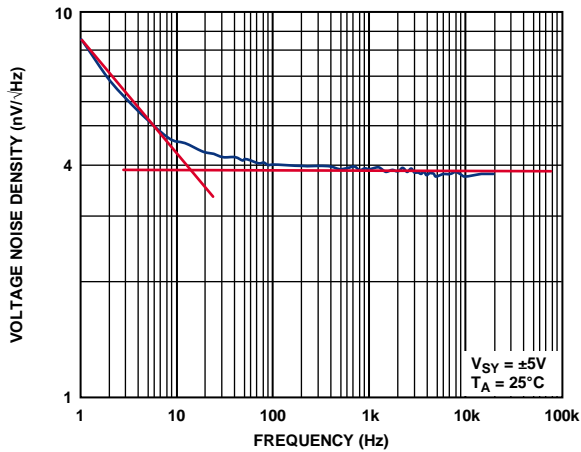

Figure 52. Voltage Noise Density

08237-042

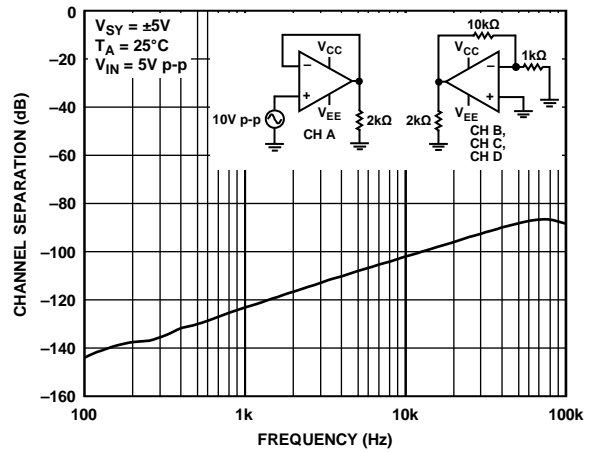

Figure 55. Channel Separation

08237-045

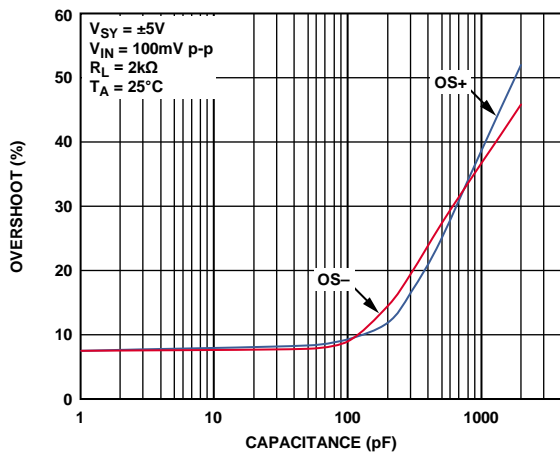

Figure 53. Overshoot vs. Load Capacitance

08237-043

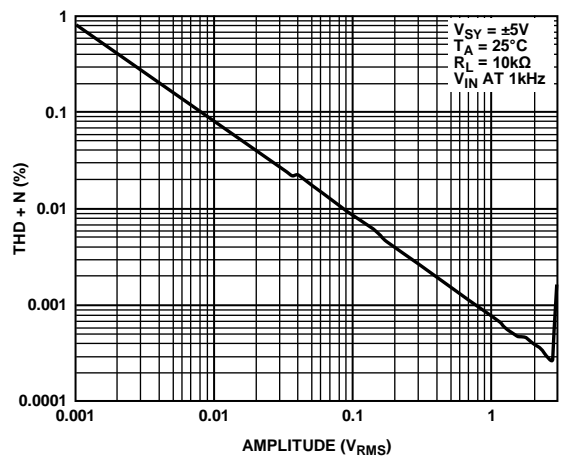

Figure 56. THD + N vs. Amplitude

08237-150



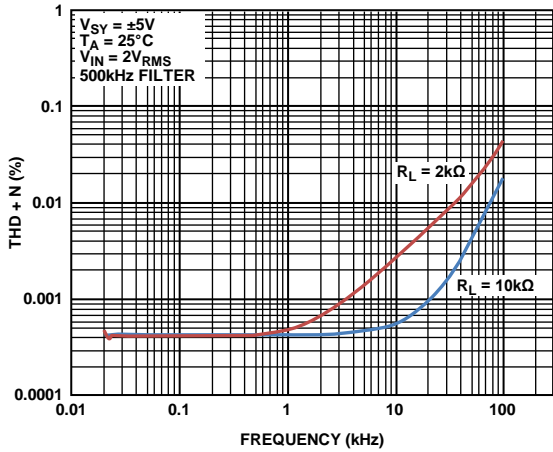

Figure 57. THD + N vs. Frequency

08237-151

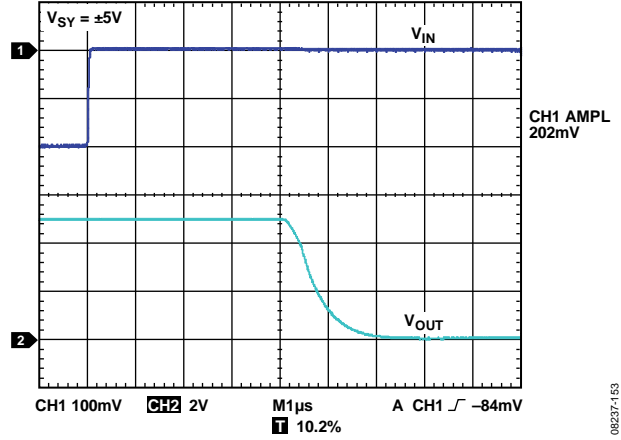

Figure 59. Positive Overload Recovery

08237-153

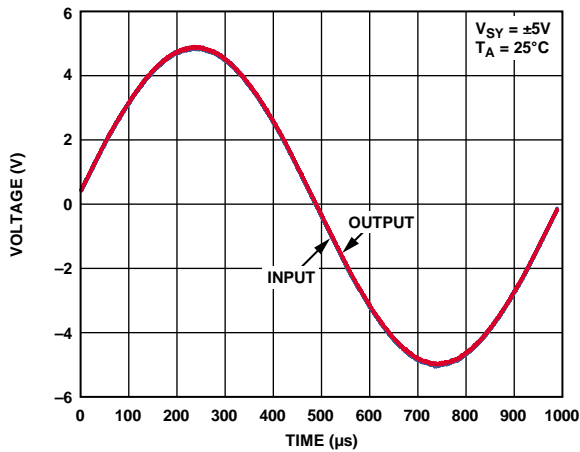

Figure 58. No Phase Reversal

08237-048

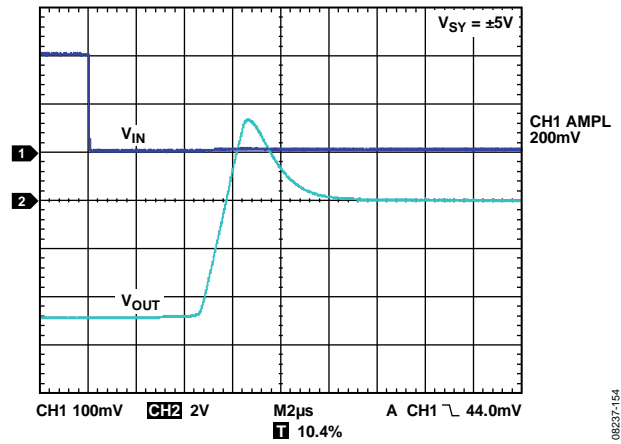

Figure 60. Negative Overload Recovery

08237-154

**±15 V CHARACTERISTICS**

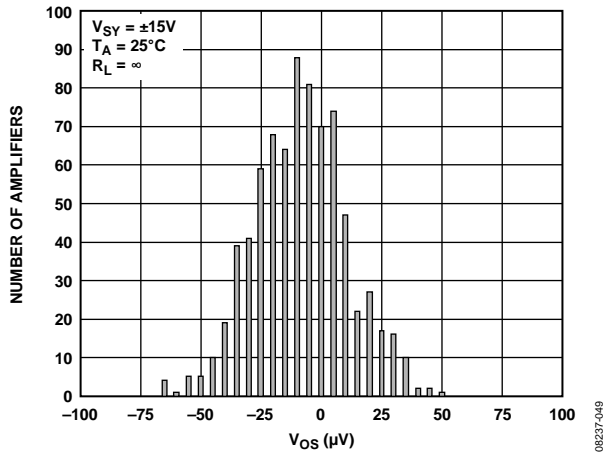

Figure 61. Input Offset Voltage Distribution, SOIC

08237-049

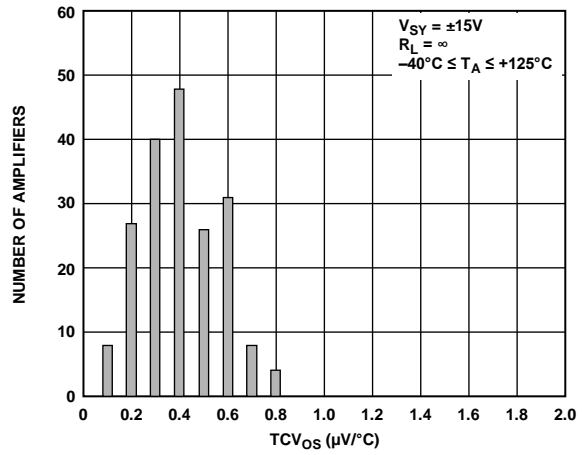

Figure 64.  $TCV_{OS}$  Distribution, SOIC and MSOP

08237-051

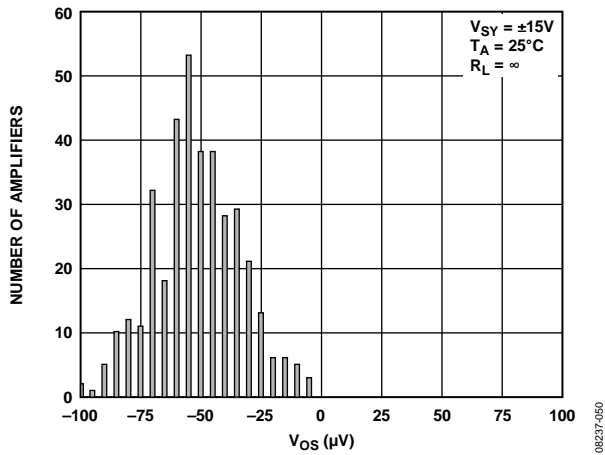

Figure 62. Input Offset Voltage Distribution, MSOP

08237-050

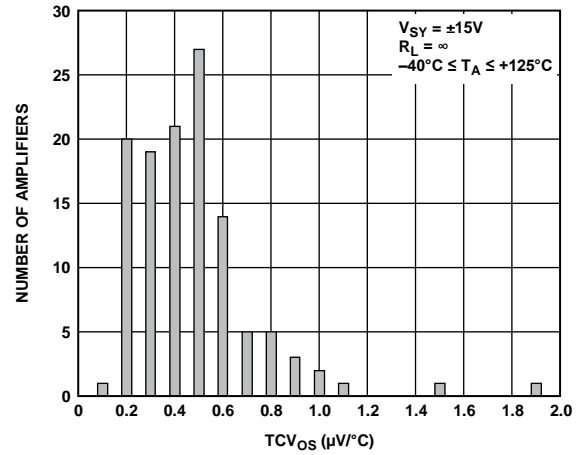

Figure 65.  $TCV_{OS}$  Distribution, ADA4084-2 LFCSP

08237-055

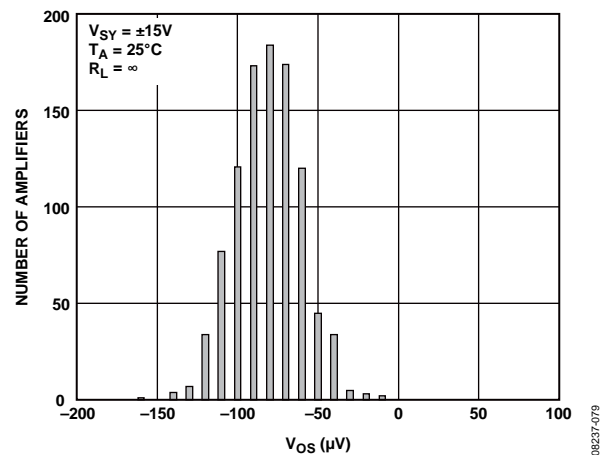

Figure 63. Input Offset Voltage Distribution, ADA4084-2 LFCSP

08237-079

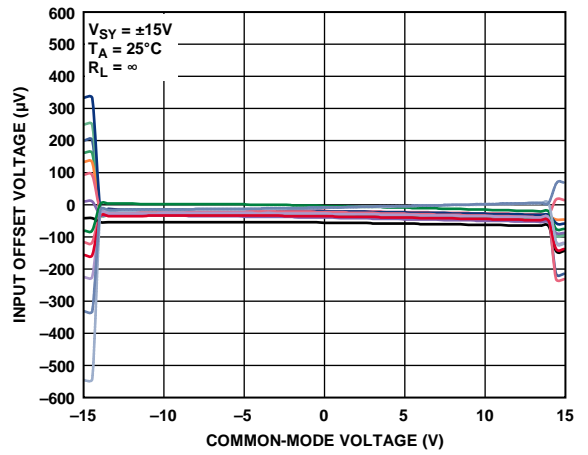

Figure 66. Input Offset Voltage vs. Common-Mode Voltage

08237-052

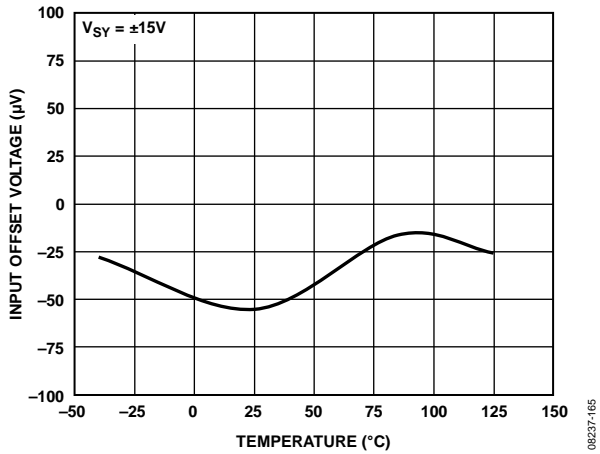

Figure 67. Input Offset Voltage vs. Temperature

08237-165

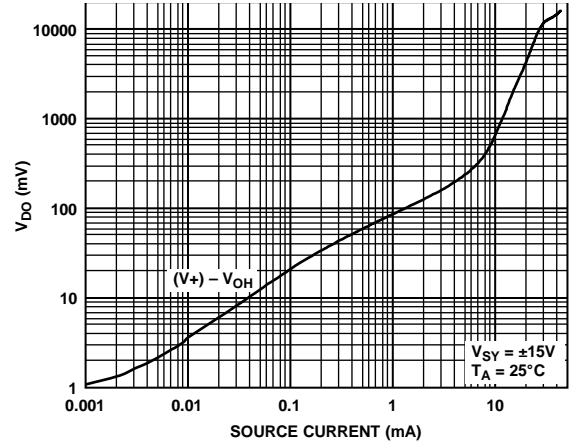

Figure 70. Dropout Voltage vs. Source Current

08237-055

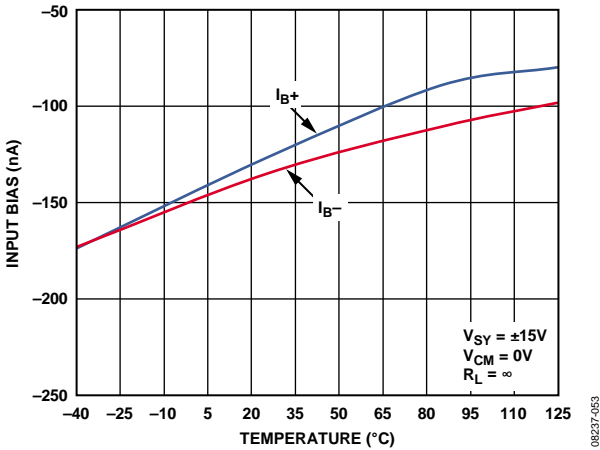

Figure 68. Input Bias Current vs. Temperature

08237-053

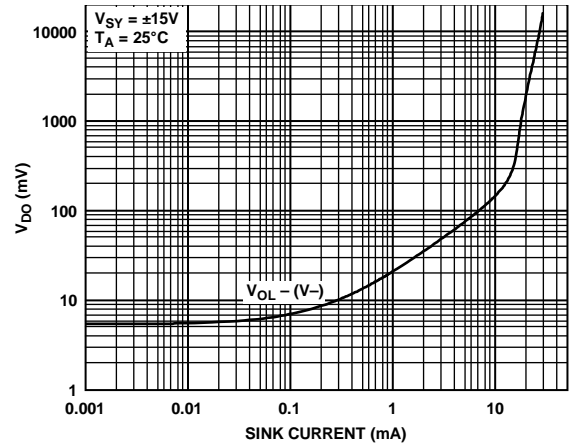

Figure 71. Dropout Voltage vs. Sink Current

08237-056

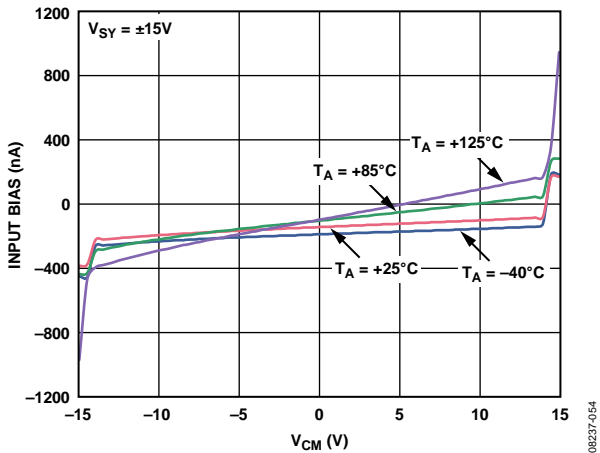

Figure 69. Input Bias Current vs.  $V_{CM}$  and Temperature

08237-054

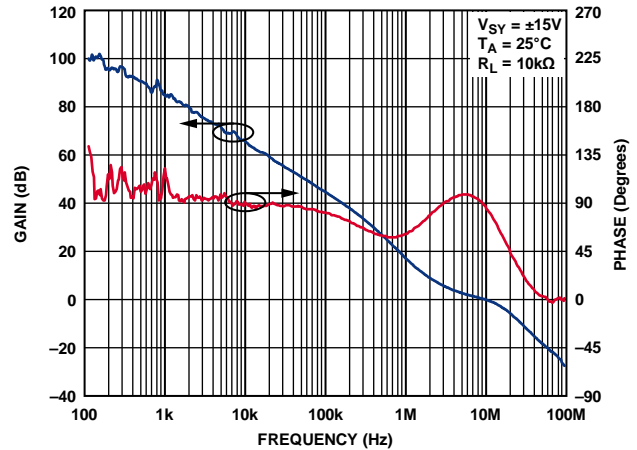

Figure 72. Open-Loop Gain and Phase vs. Frequency

08237-057

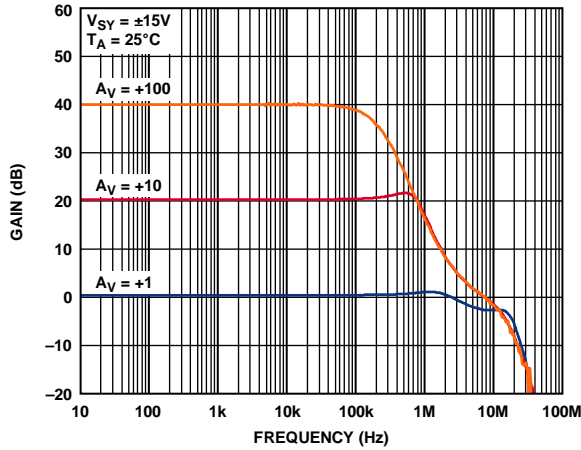

Figure 73. Closed-Loop Gain vs. Frequency

08237-058

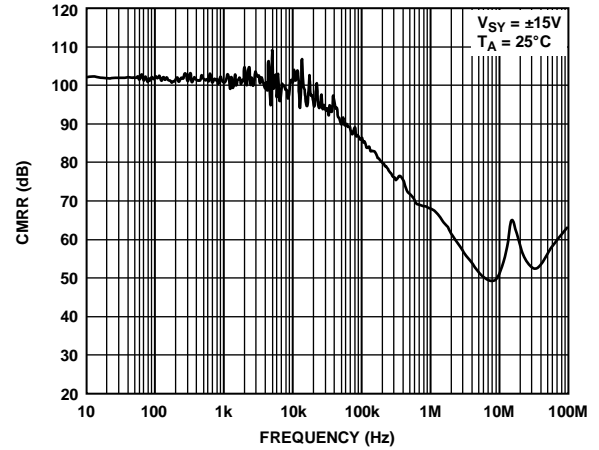

Figure 76. CMRR vs. Frequency

08237-061

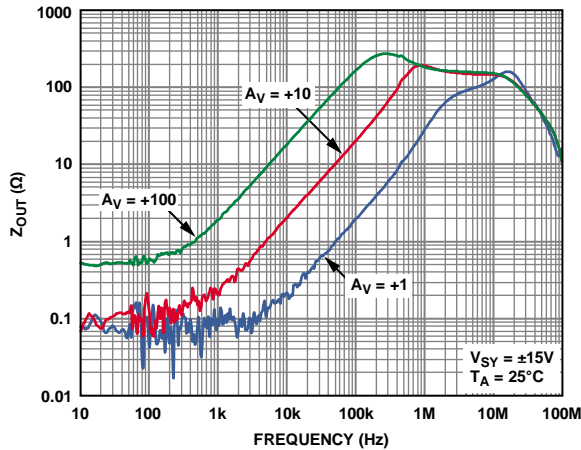

Figure 74. Output Impedance vs. Frequency

08237-059

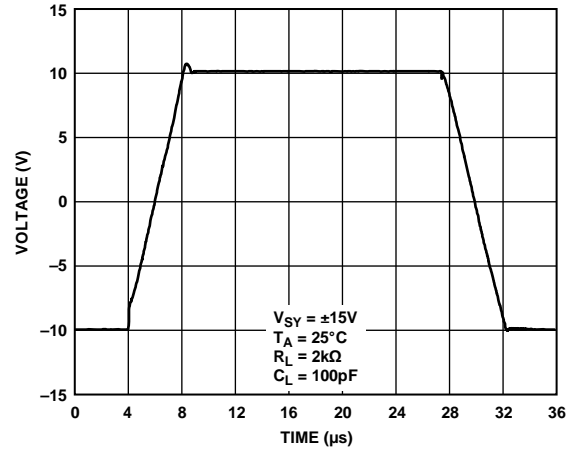

Figure 77. Large Signal Transient Response

08237-062

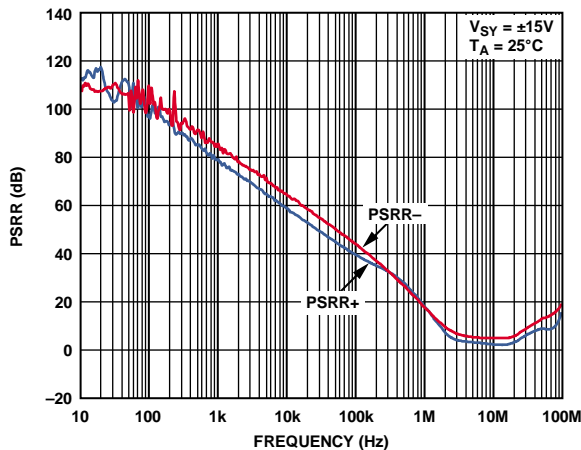

Figure 75. PSRR vs. Frequency

08237-060

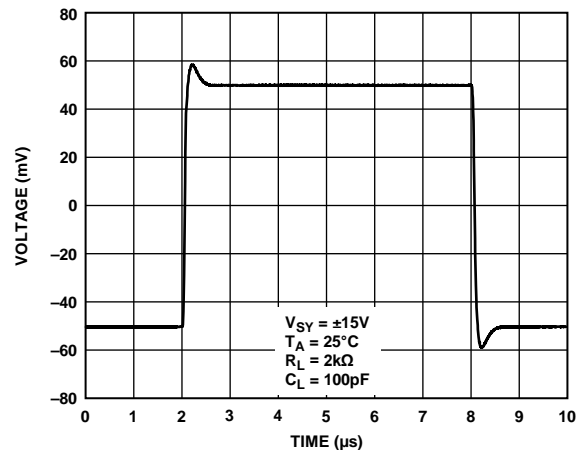

Figure 78. Small Signal Transient Response

08237-063

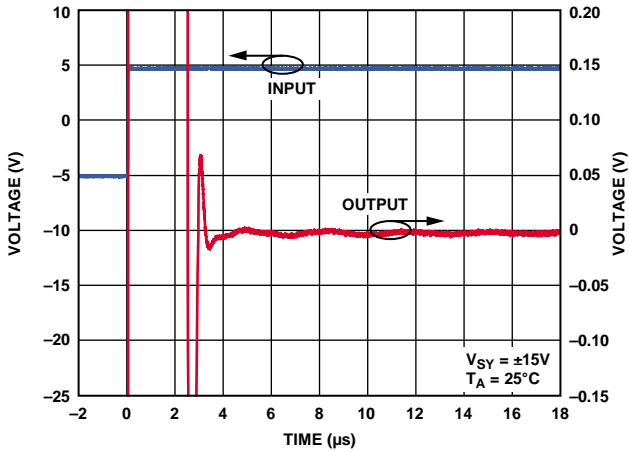

Figure 79. Settling Time

08237-064

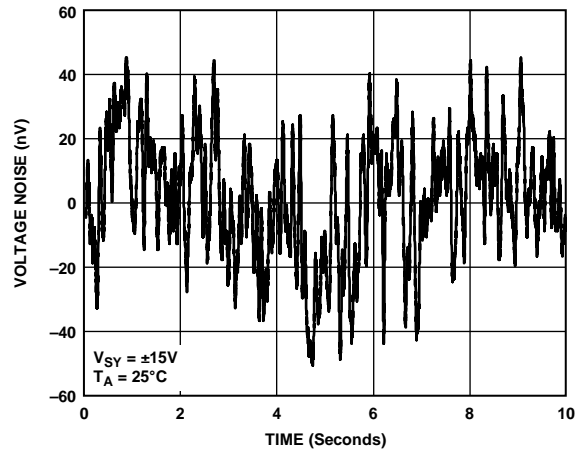

Figure 82. Voltage Noise 0.1 Hz to 10 Hz

08237-067

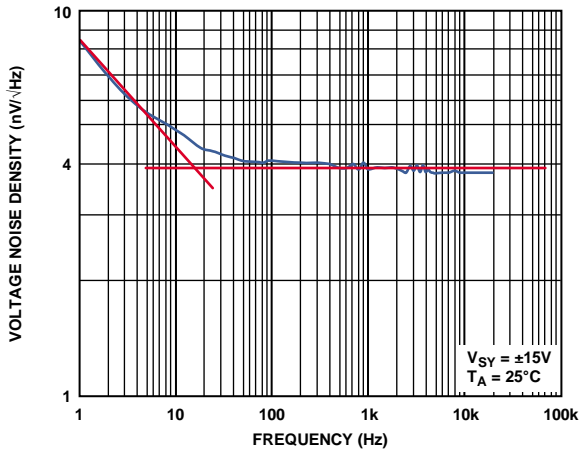

Figure 80. Voltage Noise Density

08237-065

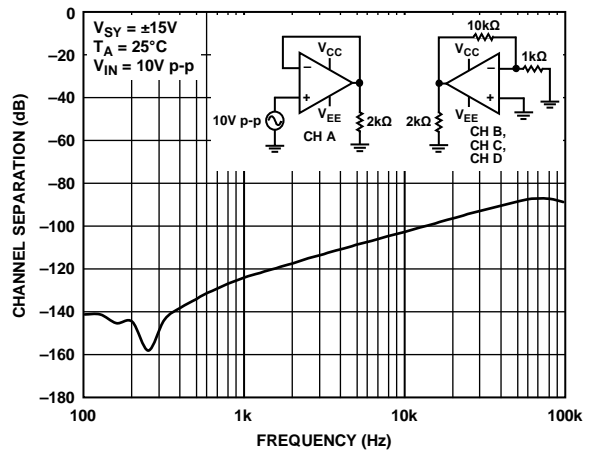

Figure 83. Channel Separation

08237-068

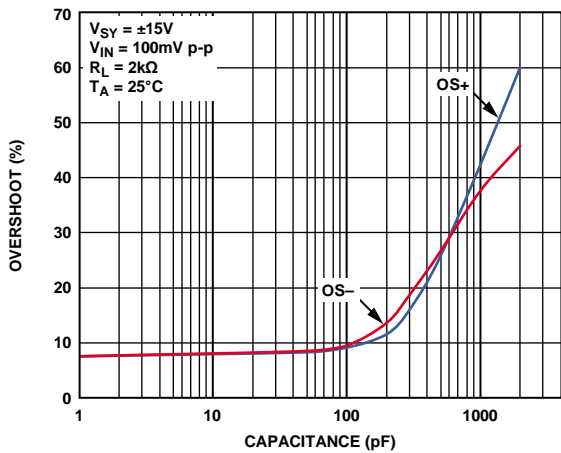

Figure 81. Overshoot vs. Load Capacitance

08237-066

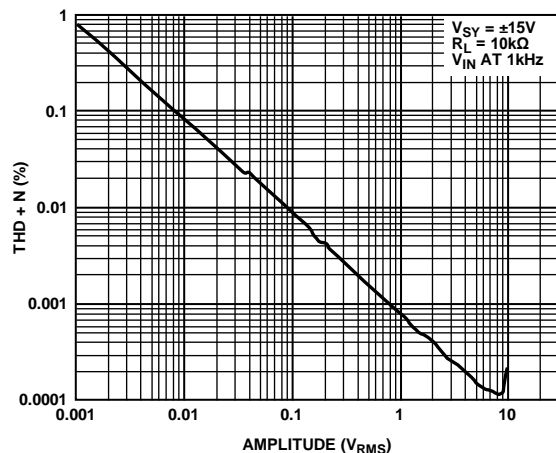

Figure 84. THD + N vs. Amplitude

08237-175

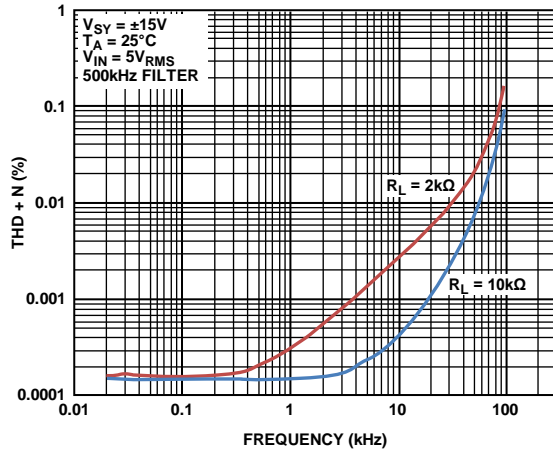

Figure 85. THD + N vs. Frequency

06237-176

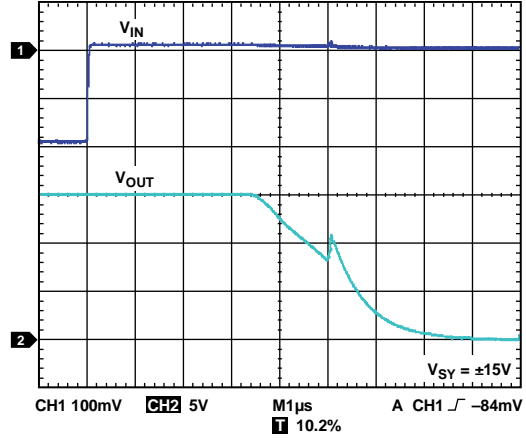

Figure 87. Positive Overload Recovery

06237-178

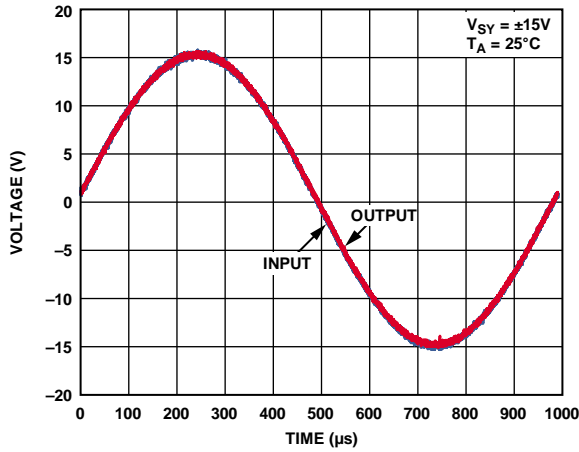

Figure 86. No Phase Reversal

06237-071

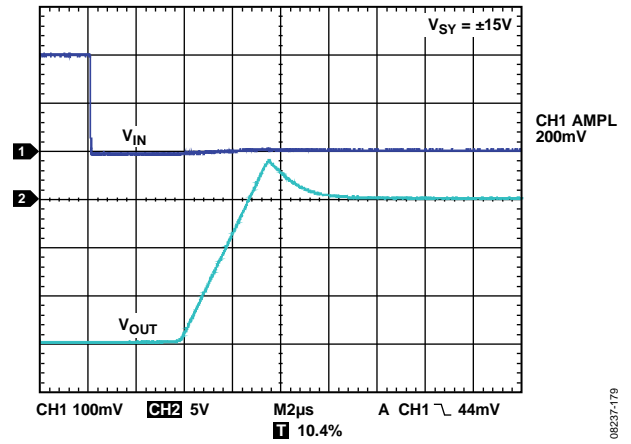

Figure 88. Negative Overload Recovery

06237-179

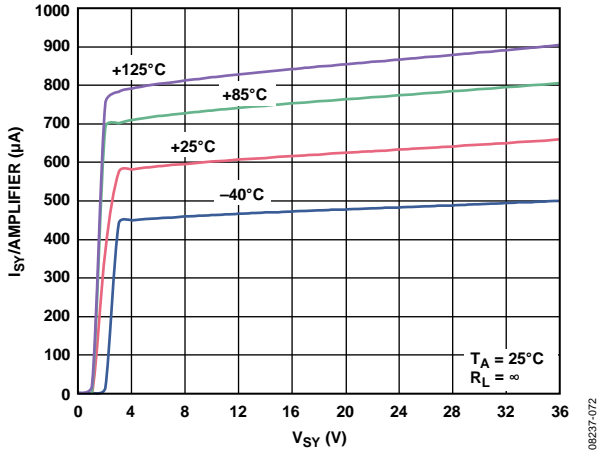

Figure 89. Supply Current vs. Supply Voltage

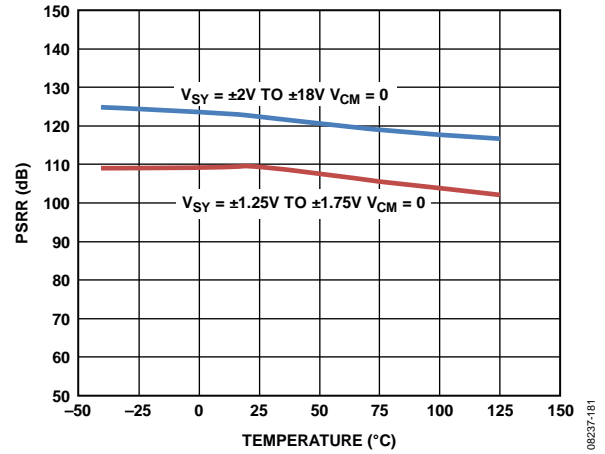

Figure 91. PSRR vs. Temperature

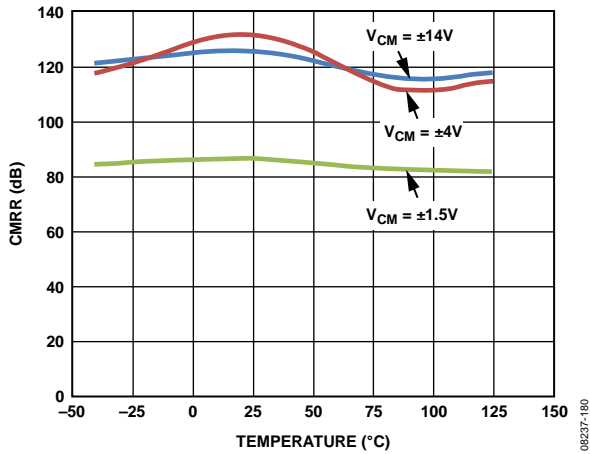

Figure 90. CMRR vs. Temperature

08237-072

08237-181

08237-180

## APPLICATIONS INFORMATION

### FUNCTIONAL DESCRIPTION

The ADA4084-2/ADA4084-4 devices are precision single-supply, rail-to-rail operational amplifiers. Intended for portable instrumentation, the ADA4084-2/ADA4084-4 devices combine the attributes of precision, wide bandwidth, and low noise, making them an ideal choice in single-supply applications that require both ac and precision dc performance. Other low supply voltage applications for which the ADA4084-2/ADA4084-4 devices are well suited are active filters, audio microphone preamplifiers, power supply control, and telecommunications. To combine all of these attributes with rail-to-rail input/output operation, novel circuit design techniques are used.

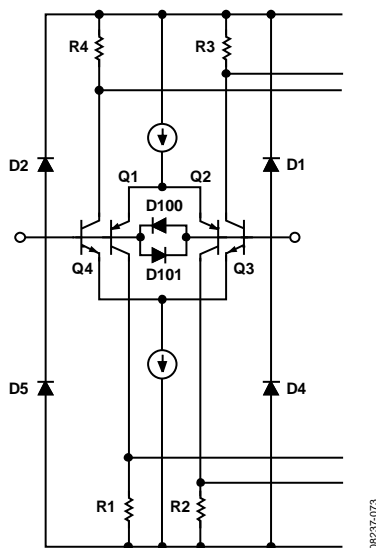

Figure 92. Equivalent Input Circuit

For example, Figure 92 illustrates a simplified equivalent circuit for the input stage of the ADA4084-2/ADA4084-4. It comprises a PNP differential pair, Q1 and Q2, and an NPN differential pair, Q3 and Q4, operating concurrently. Diode D100 and Diode D101 serve to clamp the applied differential input voltage to the ADA4084-2/ADA4084-4, thereby protecting the input transistors against Zener breakdown of the emitter-base junctions. Input stage voltage gains are kept low for input rail-to-rail operation. The two pairs of differential output voltages are connected to the second stage of the ADA4084-2/ADA4084-4, which is a modified compound folded cascade gain stage. It is also in the second gain stage that the two pairs of differential output voltages are combined into a single-ended output signal voltage used to drive the output stage.

A key issue in the input stage is the behavior of the input bias currents over the input common-mode voltage range. Input bias currents in the ADA4084-2/ADA4084-4 are the arithmetic sum of the base currents in Q1 and Q4 and in Q2 and Q3. As a result of this design approach, the input bias currents in the ADA4084-2/ADA4084-4 not only exhibit different amplitudes; they also exhibit different polarities. This effect is best illustrated by Figure 12, Figure 13, Figure 40, Figure 41, Figure 68, and Figure 69. It is,

therefore, important that the effective source impedances that are connected to the ADA4084-2/ADA4084-4 inputs be balanced for optimum dc and ac performance.

To achieve rail-to-rail output, the ADA4084-2/ADA4084-4 output stage design employs a unique topology for both sourcing and sinking current. This circuit topology is shown in Figure 93. The output stage is voltage-driven from the second gain stage. The signal path through the output stage is inverting; that is, for positive input signals, Q13 provides the base current drive to Q19 so that it conducts (sinks) current. For negative input signals, the signal path via Q18 → mirror → Q24 provides the base current drive for Q23 to conduct (source) current. Both transistors provide output current until they are forced into saturation.

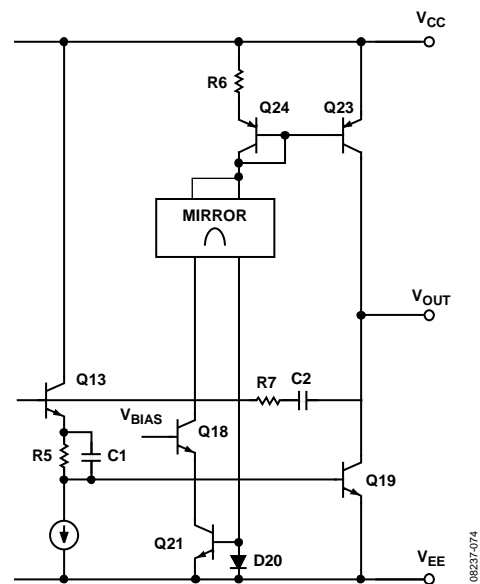

Figure 93. Equivalent Output Circuit

Thus, the saturation voltage of the output transistors sets the limit on the ADA4084-2/ADA4084-4 maximum output voltage swing. Output short-circuit current limiting is determined by the maximum signal current into the base of Q13 from the second gain stage. The output stage also exhibits voltage gain. This is accomplished by the use of common-emitter amplifiers, and, as a result, the voltage gain of the output stage (thus, the open-loop gain of the device) exhibits a dependence on the total load resistance at the output of the ADA4084-2/ADA4084-4.



## START-UP CHARACTERISTICS

The ADA4084-2/ADA4084-4 are specified to operate from 3 V to 30 V ( $\pm 1.5$  V to  $\pm 15$  V) under nominal power supplies. During power-up as the supply voltage increases from 0 V to the nominal power supply voltage, the supply current ( $I_{SY}$ ) increases as well, to the point at which it stabilizes and the amplifier is ready to operate. The stabilization varies with temperature, as shown in Figure 89. For example, at  $-40^{\circ}\text{C}$ , it requires a higher voltage and stabilizes at a lower supply current than at hot temperatures. At hot temperatures, it requires a lower voltage but stabilizes at a higher current. In all cases, the ADA4084-2/ADA4084-4 are specified to start up and operate at a minimum of 3 V under all temperature conditions.

## INPUT PROTECTION

As with any semiconductor device, if conditions exist where the applied input voltages to the device exceed either supply voltage, the input overvoltage I-to-V characteristic of the device must be considered. When an overvoltage occurs, the amplifier may be damaged, depending on the magnitude of the applied voltage and the magnitude of the fault current.

The D1, D2, D4, and D5 diodes conduct when the input common-mode voltage exceeds either supply pin by a diode drop. This diode drop voltage varies with temperature and is in the range of 0.3 V to 0.8 V. As shown in the simplified equivalent input circuit of Figure 92, the ADA4084-2/ADA4084-4 do not have any internal current limiting resistors; thus, fault currents can quickly rise to damaging levels.

This input current is not inherently damaging to the device, provided that it is limited to 5 mA or less. If a fault condition causes more than 5 mA to flow, add an external series resistor at the expense of additional thermal noise. Figure 94 shows a typical noninverting configuration for an overvoltage protected amplifier, where the series resistance,  $R_s$ , is chosen, such that

$$R_s = \frac{V_{IN(MAX)} - V_{SUPPLY}}{5 \text{ mA}}$$

For example, a 1 k $\Omega$  resistor protects the ADA4084-2/ADA4084-4 against input signals up to 5 V above and below the supplies. Note that the thermal noise of a 1 k $\Omega$  resistor at room temperature is 4 nV/ $\sqrt{\text{Hz}}$ , which exceeds the voltage noise of the ADA4084-2/ADA4084-4. For other configurations in which both inputs are used, protect each input against abuse with a series resistor. To ensure optimum dc and ac performance, balance the source impedance levels.

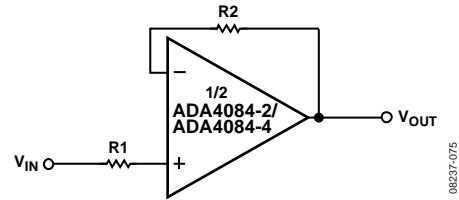

Figure 94. Resistance in Series with Input Limits Overvoltage Currents to Safe Values

To protect the Q1/Q2 and Q3/Q4 pairs from large differential voltages that may result in Zener breakdown of the emitter-base junction, D100 and D101 are connected between the two inputs. This precludes operation as a comparator. For a more complete description, see the MT-035 Tutorial, *Op Amp Inputs, Outputs, Single-Supply, and Rail-to-Rail Issues*; the MT-083 Tutorial, *Comparators*; the MT-084 Tutorial, *Using Op Amps As Comparators*; and the AN-849 Application Note, *Using Op Amps as Comparators*, at [www.analog.com](http://www.analog.com).

## OUTPUT PHASE REVERSAL

Some operational amplifiers designed for single-supply operation exhibit an output voltage phase reversal when their inputs are driven beyond their useful common-mode range. Typically, for single-supply bipolar op amps, the negative supply determines the lower limit of their common-mode range. With these devices, external clamping diodes, with the anode connected to ground and the cathode to the inputs, prevent input signal excursions from exceeding the negative supply of the device (that is, GND), preventing a condition that causes the output voltage to change phase. JFET input amplifiers can also exhibit phase reversal, and, if so, a series input resistor is usually required to prevent it.

The ADA4084-2/ADA4084-4 are free from reasonable input voltage range restrictions, provided that input voltages no greater than the supply voltages are applied (see Figure 30, Figure 58, and Figure 86).

Although device output does not change phase, large currents can flow through the input protection diodes. Therefore, apply the technique recommended in the Input Protection section to those applications where the likelihood of input voltages exceeding the supply voltages is high.

**DESIGNING LOW NOISE CIRCUITS IN SINGLE-SUPPLY APPLICATIONS**

In single-supply applications, devices like the [ADA4084-2/ADA4084-4](#) extend the dynamic range of the application through the use of rail-to-rail operation. Referring to the op amp noise model circuit configuration illustrated in Figure 95, the expression for the total equivalent input noise voltage of an amplifier for a source resistance level,  $R_s$ , is given by

$$e_{nT} = \sqrt{2 [(e_{nR})^2 + (i_{nOA} \times R_s)^2] + (e_{nOA})^2}, \text{ units in } \frac{V}{\sqrt{Hz}}$$

where:

- $R_s = 2R$ , the effective, or equivalent, circuit source resistance.
- $(e_{nR})^2$  is the source resistance thermal noise voltage power (4kTR).
- $k$  is the Boltzmann's constant,  $1.38 \times 10^{-23}$  J/K.
- $T$  is the ambient temperature in Kelvin of the circuit,  $273.15 + T_A$  ( $^{\circ}C$ ).
- $(i_{nOA})^2$  is the op amp equivalent input noise current spectral power (1 Hz bandwidth).
- $(e_{nOA})^2$  is the op amp equivalent input noise voltage spectral power (1 Hz bandwidth).

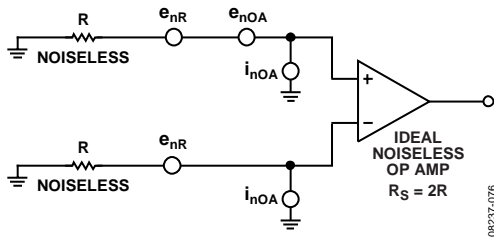

Figure 95. Op Amp Noise Circuit Model Used to Determine Total Circuit Equivalent Input Noise Voltage and Noise Figure

As a design aid, Figure 96 shows the equivalent thermal noise of the [ADA4084-2/ADA4084-4](#) vs. the total source resistance. Note that for source resistance less than 1 k $\Omega$ , the equivalent input noise voltage of the [ADA4084-2/ADA4084-4](#) is dominant.

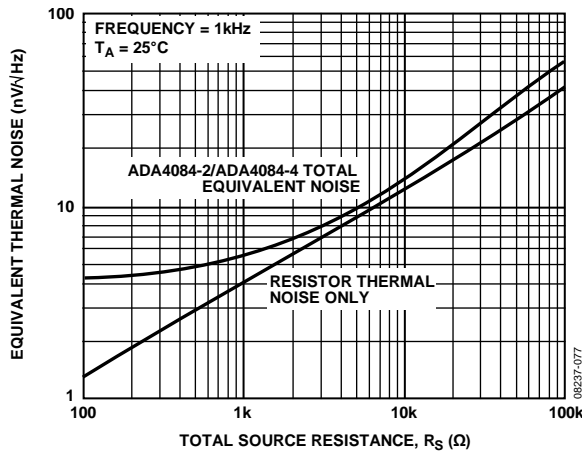

Figure 96. Equivalent Thermal Noise vs. Total Source Resistance

Because circuit SNR is the critical parameter in the final analysis, the noise behavior of a circuit is sometimes expressed in terms of its noise figure, NF. The noise figure is defined as the ratio of the signal-to-noise output of a circuit to its signal-to-noise input.

Noise figure is generally used for RF and microwave circuit analysis in a 50  $\Omega$  system. This is not very useful for op amp circuits where the input and output impedances can vary greatly. For a more complete description of noise figure, see the [MT-052 Tutorial, Op Amp Noise Figure: Don't be Mislead](#), available at [www.analog.com](http://www.analog.com).

Signal levels in the application invariably increase to maximize circuit SNR, which is not an option in low voltage, single-supply applications.

Therefore, to achieve optimum circuit SNR in single-supply applications, choose an operational amplifier with the lowest equivalent input noise voltage, along with source resistance levels that are consistent with maintaining low total circuit noise.

**COMPARATOR OPERATION**

Although op amps are quite different from comparators, occasionally an unused section of a dual or a quad op amp can be used as a comparator; however, this is not recommended for any rail-to-rail output op amps. For rail-to-rail output op amps, the output stage is generally a ratioed current mirror with bipolar or MOSFET transistors. With the device operating open loop, the second stage increases the current drive to the ratioed mirror to close the loop. However, the loop cannot close, which results in an increase in supply current. With the op amp configured as a comparator, the supply current can be significantly higher (see Figure 97). Configure an unused section as a voltage follower with the noninverting input connected to a voltage within the input voltage range. The [ADA4084-2/ADA4084-4](#) have unique second stage and output stage designs that greatly reduce the excess supply current when the op amp is operating open loop.

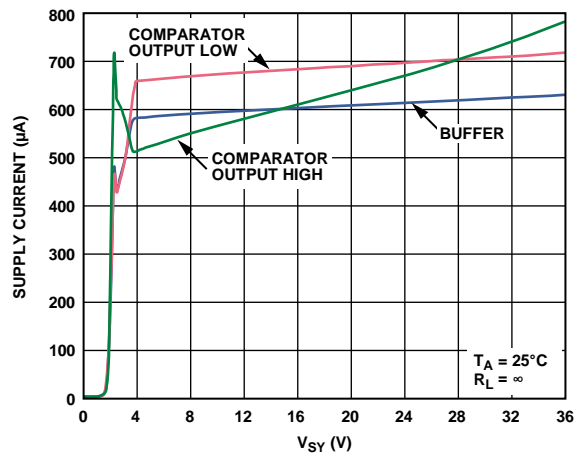
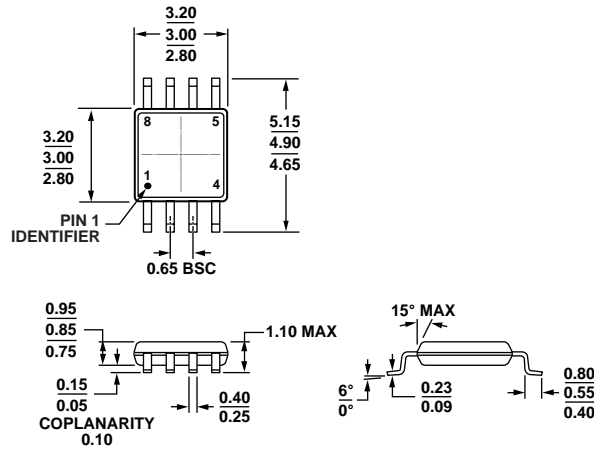

Figure 97. Supply Current vs. Supply Voltage

OUTLINE DIMENSIONS



COMPLIANT TO JEDEC STANDARDS MO-187-AA  
 Figure 98. 8-Lead Mini Small Outline Package [MSOP]  
 (RM-8)  
 Dimensions shown in millimeters

10-07-2009-B

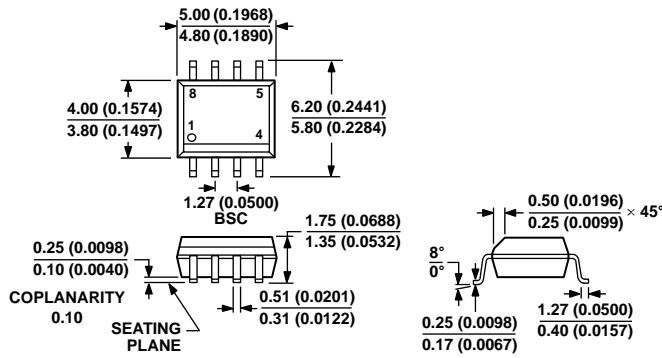

COMPLIANT TO JEDEC STANDARDS MS-012-AA  
 CONTROLLING DIMENSIONS ARE IN MILLIMETERS; INCH DIMENSIONS  
 (IN PARENTHESES) ARE ROUNDED-OFF MILLIMETER EQUIVALENTS FOR  
 REFERENCE ONLY AND ARE NOT APPROPRIATE FOR USE IN DESIGN.  
 Figure 99. 8-Lead Standard Small Outline Package [SOIC\_N]  
 Narrow Body  
 (R-8)  
 Dimensions shown in millimeters and (inches)

012407-A

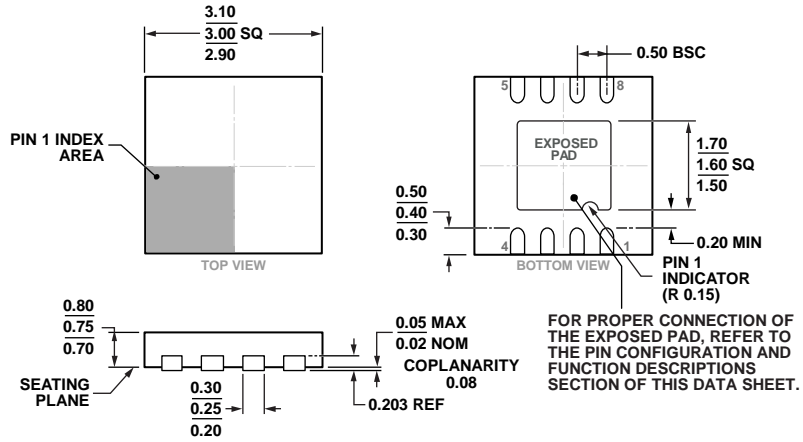

COMPLIANT TO JEDEC STANDARDS MO-229-WEED

Figure 100. 8-Lead Lead Frame Chip Scale Package [LFCSP\_WD]  
3 mm x 3 mm Body, Very Very Thin, Dual Lead  
(CP-8-12)

Dimensions shown in millimeters

02-05-2013-B

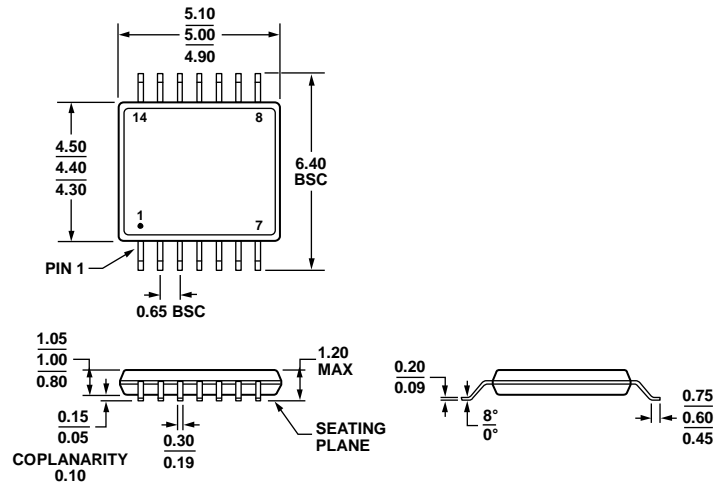

COMPLIANT TO JEDEC STANDARDS MO-153-AB-1

Figure 101. 14-Lead Thin Shrink Small Outline Package [TSSOP]  
(RU-14)

Dimensions shown in millimeters

061906-A

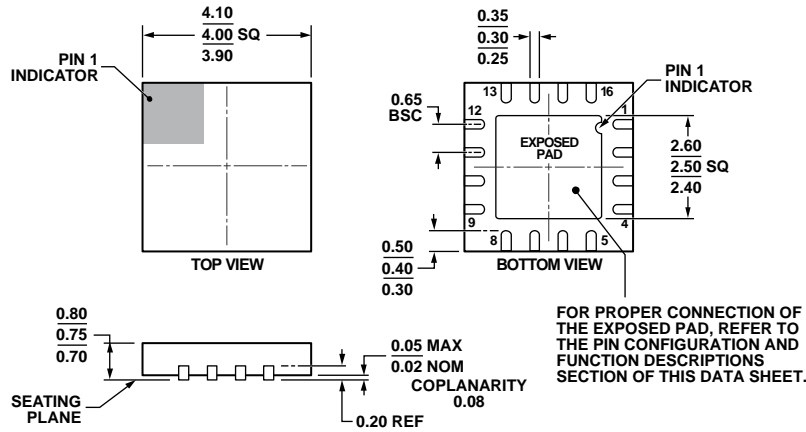

COMPLIANT TO JEDEC STANDARDS MO-220-WGGC.

Figure 102. 16-Lead Lead Frame Chip Scale Package [LFCSP\_WQ]  
 4 mm × 4 mm Body, Very Very Thin Quad  
 (CP-16-26)  
 Dimensions shown in millimeters

042709-A

**ORDERING GUIDE**

Model <sup>1</sup>	Temperature Range	Package Description	Package Option	Branding
ADA4084-2ARMZ	-40°C to +125°C	8-Lead Mini Small Outline Package [MSOP]	RM-8	A2Q
ADA4084-2ARMZ-R7	-40°C to +125°C	8-Lead Mini Small Outline Package [MSOP]	RM-8	A2Q
ADA4084-2ARMZ-RL	-40°C to +125°C	8-Lead Mini Small Outline Package [MSOP]	RM-8	A2Q
ADA4084-2ARZ	-40°C to +125°C	8-Lead Standard Small Outline Package [SOIC_N]	R-8	
ADA4084-2ARZ-R7	-40°C to +125°C	8-Lead Standard Small Outline Package [SOIC_N]	R-8	
ADA4084-2ARZ-RL	-40°C to +125°C	8-Lead Standard Small Outline Package [SOIC_N]	R-8	
ADA4084-2ACPZ-R7	-40°C to +125°C	8-Lead Lead Frame Chip Scale Package [LFCSP_WD]	CP-8-12	A2Q
ADA4084-2ACPZ-RL	-40°C to +125°C	8-Lead Lead Frame Chip Scale Package [LFCSP_WD]	CP-8-12	A2Q
ADA4084-4ACPZ-R7	-40°C to +125°C	16-Lead Lead Frame Chip Scale Package [LFCSP_WQ]	CP-16-26	
ADA4084-4ACPZ-RL	-40°C to +125°C	16-Lead Lead Frame Chip Scale Package [LFCSP_WQ]	CP-16-26	
ADA4084-4RUZ	-40°C to +125°C	14-Lead Thin Shrink Small Outline Package [TSSOP]	RU-14	
ADA4084-4RUZ-RL	-40°C to +125°C	14-Lead Thin Shrink Small Outline Package [TSSOP]	RU-14	

<sup>1</sup> Z = RoHS Compliant Part.

## X-ON Electronics

Largest Supplier of Electrical and Electronic Components

*Click to view similar products for [analog devices manufacturer](#):*

Other Similar products are found below :

[OP484ESZ-REEL](#) [AD8664ARUZ-REEL](#) [AD650JN](#) [OP400GP](#) [ADG707BRU](#) [ADSP-21469BBC-3](#) [AD843JN](#) [ADM694SQ](#) [AD8001AR](#)  
[HMC444LP4ETR](#) [LTC1564CG#PBF](#) [HMC505LP4ETR](#) [5962-8686101XA](#) [5962-89710013X](#) [5962-9169003MXA](#) [5962-9176404M3A](#) [5962-9316401MXA](#) [5962-9452101M2A](#) [EV1HMC1160LP5](#) [EV1HMC305SLP4](#) [EV1HMC306AMS10](#) [EV1HMC557ALC4](#) [EV1HMC6146BLC5A](#)  
[EV1HMC6832ALP5L](#) [EV1HMC7912LP5](#) [EV1HMC7992LP3D](#) [EV1HMC951BLP4](#) [EV-AD5443/46/53SDZ](#) [EV-ADF70301-433AZ](#) [EV-ADF70301-868BZ](#) [EV-ADUCM322IQSPZ](#) [EV-ADUCM322QSPZ](#) [EVAL01-HMC1048LC3B](#) [EVAL01-HMC1055LP2C](#) [EVAL01-HMC1063LP3](#) [EVAL01-HMC197B](#) [EVAL01-HMC760LC4B](#) [EVAL01-HMC829LP6GE](#) [EVAL01-HMC833LP6GE](#) [EVAL01-HMC835LP6G](#) [EVAL01-HMC985LP4KE](#) [EVAL01-HMC987LP5E](#) [EVAL01-HMC988LP3E](#) [EVAL01-HMC995LP5GE](#) [EVAL02-HMC1034LP6G](#) [EVAL-3CH4CHSOICEBZ](#) [EVAL-AD1871EBZ](#) [EVAL-AD5063EBZ](#) [EVAL-AD5064EBZ](#) [EVAL-AD5171DBZ](#)