



产品规格书 Specification

5050 RGB 贴片
5050 Single Chip RGB Color Top LED

产品型号/ Part No : WW-FCE50TC-Q1(P)(SQ)



批准	审核	制定
牛焕东	梁华彪	林镇心

华宏光电子（深圳）有限公司
 地址:深圳市宝安区大浪街道华荣路
 联建科技工业园第五栋
 电话: 0755-86019190
 传真: 0755-86019197

WAH WANG OPTOELECTRONIC (SHENZHEN)
 COMPANY LIMITED
 Address: Floor Block 5, Lianjian Science &
 Technology Industrial Park, Crossing of HuaRong
 Road, Dalang Sub-District, Bao`an, ShenZhen
 Tel: 0755-86019190
 Fax: 0755-86019197

S.D.N. / D.N. No. 送货单编号	
Customer Name 客户名称	
Sample Approval Signature 客户确认签署	
Date 日期	



■ 产品特性

■ Features:

PLCC封装的产品尺寸为: 5.0 (长) x 5.0 (宽) x 1.6 (高) mm

PLCC LED dimensions: 5.0(L) x 5.0(W) x 1.6(H) mm:

发散视角120°

Wide view angle 120°

环保防静电胶带包装

Available on tape and reel with Anti-electrostatic bag

产品性能稳定可靠

Compatible for all SMT Assembly and Lead-Free Soldering

RoHS Compliant



■ 应用

■ Applications:

背光液晶开关和显示

Backlight for LCD Switch and Display

装饰照明

Decorative Lighting

一般照明

General Lighting

汽车内部照明

Automotive Interior Lighting

常规使用

General Use

■ 产品尺寸图

■ Package Dimensions:

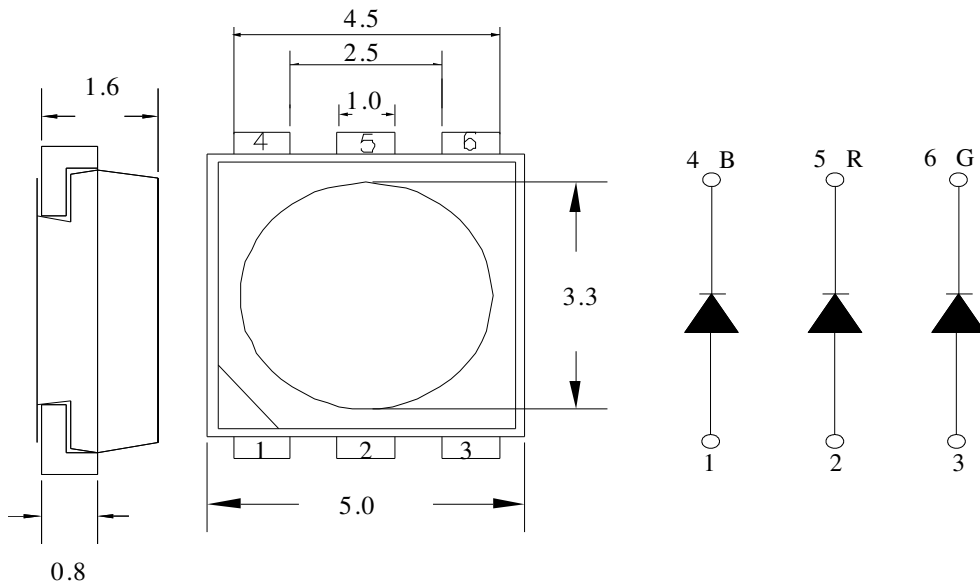

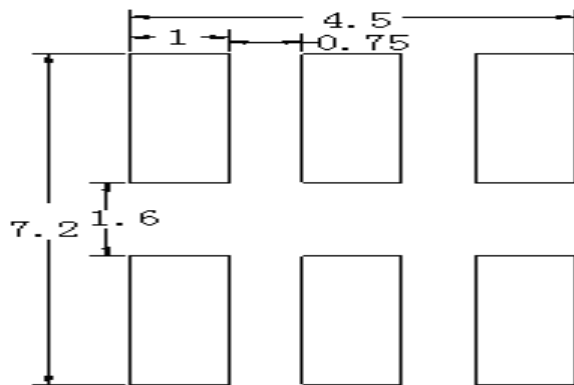

建议焊盘尺寸

Recommended Soldering Pads Dimensions

■ 注释

■ Recommended Soldering Pads Dimensions

1、上图所有尺寸的单位为毫米

All dimension units are in millimeters.

2、所有外形尺寸公差为 ±0.25 毫米，除非另有说明

All dimension tolerances are ± 0.25mm unless otherwise noted.

■ 最大绝对额定值

■ Absolute Maximum Ratings:

参数 Parameter	符号 Symbol	数值 Value	单位 Unit
功耗 Power dissipation	P_d	60	mW
连续正向电流 Continuous Forward Current	I_F	20	mA
峰值正向电流 (1/10 Duty Cycle, 0.1ms Pulse Width) Peak Forward Current	I_{FP}	50	mA
反向电压 Reverse Voltage	V_R	5	V
静电放电(HBM) Electrostatic Discharge (HBM)	ESD	1000	V
工作温度范围 Operating Temperature Range	T_{opr}	-25 to +85	°C
存储温度范围 Storage Temperature Range	T_{stg}	-40 to +100	°C
无铅焊接温度 Lead Soldering Temperature	T_{sol}	260(for 5 sec)	°C



光电参数规格:

Electrical Optical Characteristics:

WW-FCE50TC-Q1(P)(SQ)

参数 Parameter	符号 Symbol	最小值. Min.	平均值. Typ.	最大值 Max.	单位 Unit	测试条件 Test Conditions
发光强度 Luminous Intensity	LV(R)	400	---	600	mcd	$I_F = 20\text{mA}$
	Lv(G)	1000	---	1200		
	Lv(B)	300	---	400		
波长 Spectral	$\lambda_{d(R)}$	620	---	630	nm	$I_F = 20\text{mA}$
	$\lambda_{d(G)}$	515	---	525		
	$\lambda_{d(B)}$	465	---	475		
参考光通量 Ref.Luminous Flux	Φ_v	---	---	---	Lm	$I_F = 20\text{mA}$
视角 Viewing Angle	2 θ 1/2	---	120	---	Deg	$I_F = 20\text{mA}$
正向电压 Forward Voltage	VF(R)	1.8	---	2.6	V	$I_F = 20\text{mA}$
	VF(G)	2.8	---	3.6		
	VF(B)	2.8	---	3.6		
反向电流 Reverse Current	I_R	---	---	5	μA	$V_R = 5\text{V}$

注释 Notes:

1、发光强度、功耗和光通量的误差为 $\pm 10\%$ WW maintains a tolerance of $\pm 10\%$ on flux and power measurements.2、波长的误差为 $\pm 1\text{nm}$; $\lambda_d \pm 1\text{nm}$.3、电压的误差为 $\pm 0.1\text{V}$ A tolerance of $\pm 0.1\text{V}$ on forward voltage measurements



■ 光电特性

Typical Optical Characteristics Curves

Forward Current vs Forward Voltage 伏安特性曲线

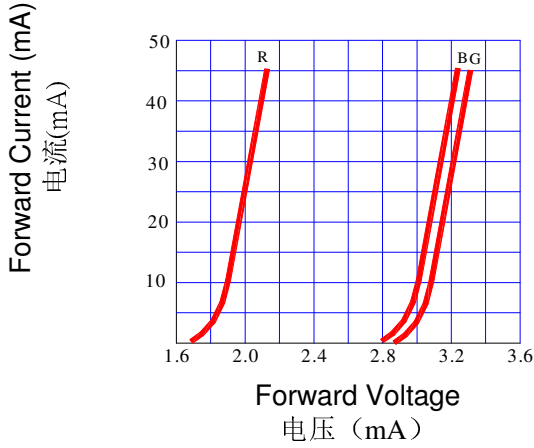

Forward Current vs Relative Luminous Intensity 电流和光通量的关系

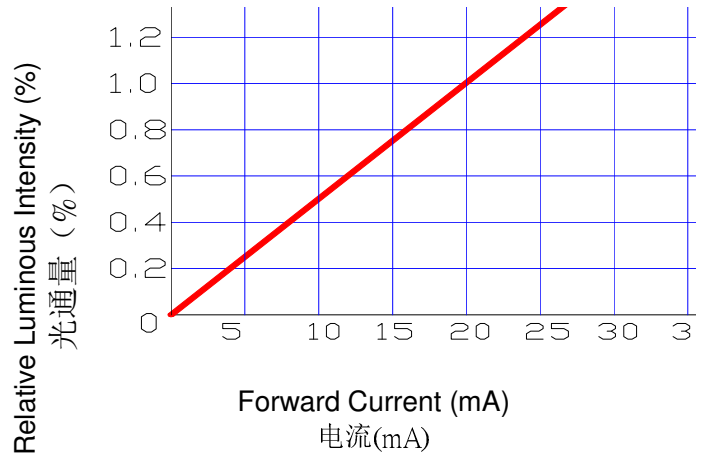

Spectral Distribution 波长曲线图

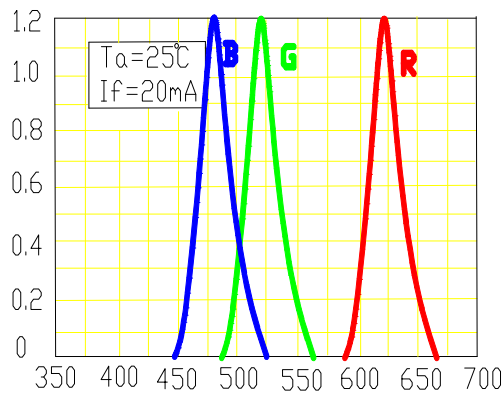

Luminous Intensity vs Ambient Temperature 发光强度与温度的关系曲线图

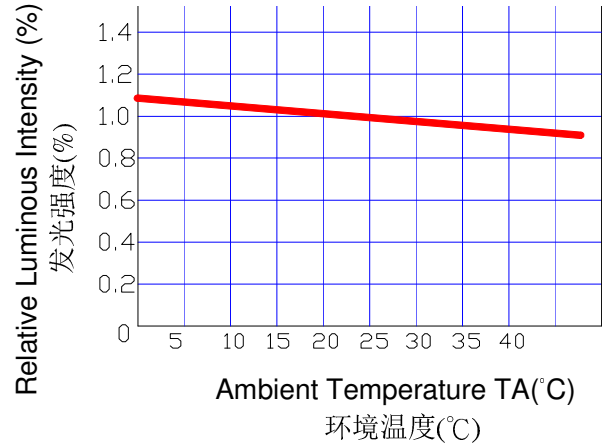

Radiation Diagram 发光角度图

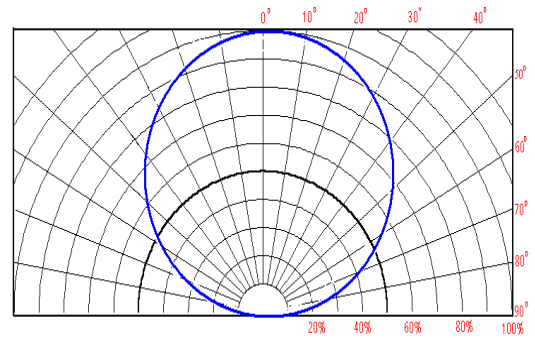

Forward Current Derating Curve 环境温度与电流的关系曲线图

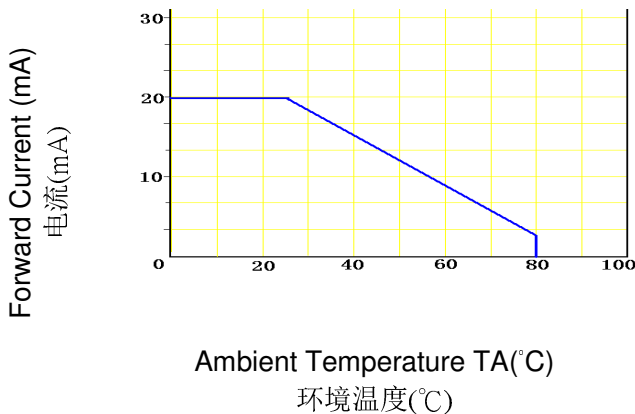

Radiation Diagram 发光角度图

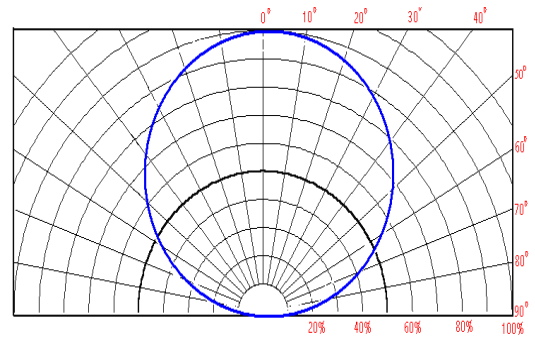



■ 产品可靠性检测项目:

序号 No.	实验项目 Test Item	标准测试方法 Standard Test Method	测试条件 Test Conditions	检测时间和周期 Duration	不良数/测试数 Failure Rate
1	正常工作寿命 Steady State Operating Life	JEITA ED-4701 100 103	I _f =20mA T _a =25°C	1000hrs	0/22
2	低温贮藏 Low Temperature Storage	JEITA ED-4701 200 202	T _a =-40°C	1000hrs	0/22
3	高温贮存 High Temperature Storage	JEITA ED-4701 200 201	T _a =100°C	1000hrs	0/22
4	高温高湿贮藏 Temperature Humidity Storage	JEITA ED-4701 100 103	T _a =60°C RH=90%	1000hrs	0/22
5	冷热冲击 Thermal Shock	JEITA ED-4701 300 307	0°C ~ +100°C 5min~ 15sec ~ 5min	10 cycles	0/22
6	高低温循环 Temperature Cycle	JEITA ED-4701 100 105	H: +100°C 30min. ∫ : +25°C 5min. L: -40°C 30min	100 cycles	0/22
7	烫锡 Solder Heat	JEITA ED-4701 300 301	T _{sld} =260°C, 10sec (Max.)	2 times	0/22

■ 失效产品判定标准:

项目 Item	符号 Symbol	测试条件 Test Condition	最小值 Min.	最大值 Max.
正向电压 Forward Voltage	V _F	I _F = 20mA	--	*U.S.L×1.1
反向电流 Reverse Current	I _R	V _R = 5V	--	*U.S.L×2.0
发光强度 Luminous Intensity	I _v	I _F = 20mA	**L.S.L×0.7	--

*U.S.L.:超出标准最大值

*U.S.L.: Upper Standard Level

** L.S.L.:低于标准最低值

** L.S.L.: Lower Standard Level



■ 载带尺寸

■ Dimensions of the tape:

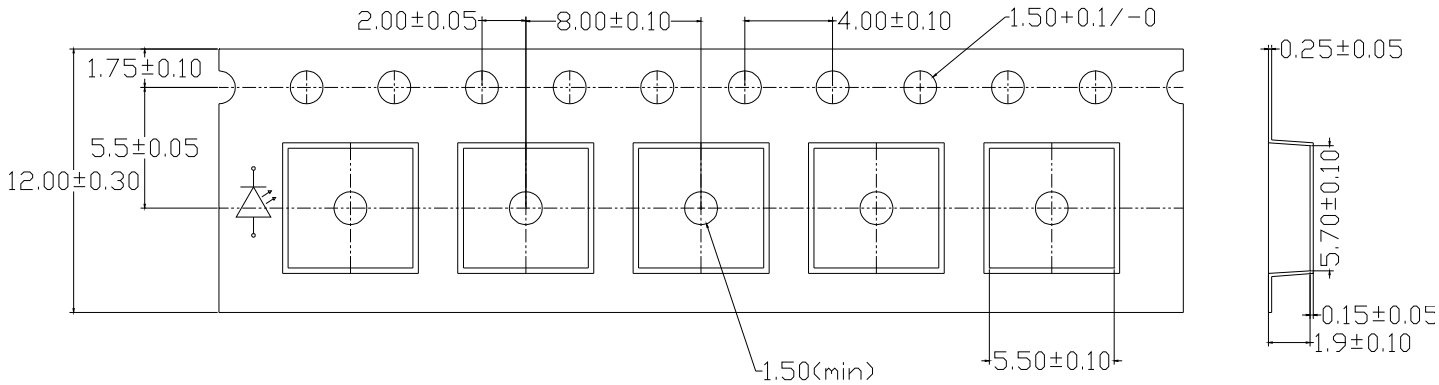

■ 包装盘的尺寸

■ Dimensions of the reel:

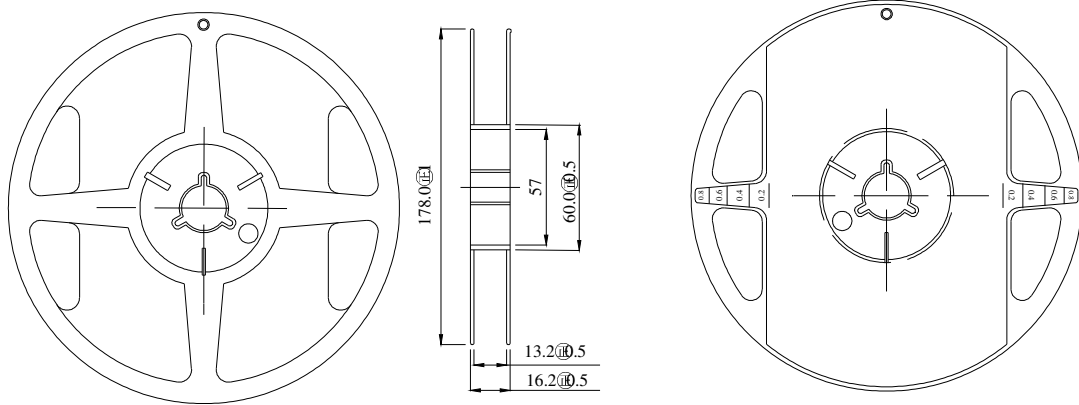

■ 包装

■ Packing:

防潮、防静电真空密封包装

■ Moisture, anti-static vacuum sealed packages

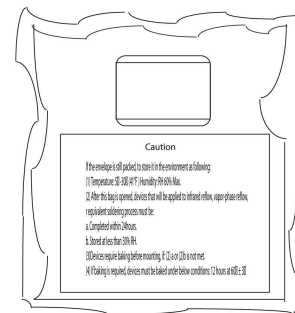
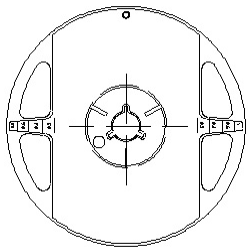

■ 注释

■ Note:

上图所有尺寸的单位为毫米，公差为 ± 2.0毫米，除非另有说明

All dimensions are in mm, tolerance is ± 2.0mm unless otherwise noted.



■ 注意事项:

PRECAUTION IN USE

1. 存储要求:

1.1 推荐储存环境

温度: 5°C ~ 30°C 的 (41°F ~ 86°F)

湿度: 相对湿度 60% 以下

1.2 储存时间 1 个月, 如超过 1 个月的 LED 需按 2.2 要求除潮烘烤后才能正常使用。

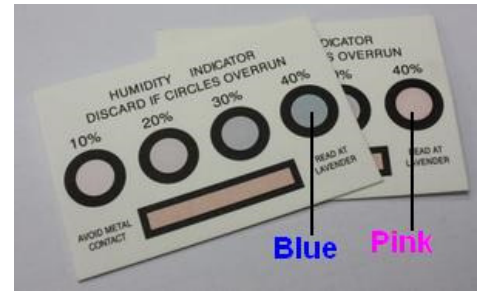

2. 使用条件:

2.1. 打开产品包装, 首先查看静电袋内的湿度卡湿度圆的颜色显示 (如上图所示), 40% 的湿度圆的颜色仍为蓝色时可正常使用, 若 40% 的湿度圆的颜色变为粉红色时, 请按照以下规定条件进行除潮, 完成除潮后可正常使用。

2.2. 除潮烘烤条件: 打开静电袋, 将产品包转盘从静电袋中取出。放进 75 ± 5°C 的烤箱烘烤 8H, 避免高温烘烤。

2.3. 产品拆封后, LED 在 ≤ 30°C, ≤ 60%RH 相对湿度的条件下, 请在 12H 内使用完, 若没有使用完的产品需以 75 ± 5°C/8H 除潮后密封, 建议放入干燥柜中存放。

2.4. 焊接:

A-1. 回流焊接程序:

回流焊接		
条件	含铅焊接	无铅焊接
	温度	温度
预热	120~150°C	180~200°C
预热时间	120sec. Max.	120sec. Max.
峰值温度	240°C Max.	260°C Max.
焊接时间	10sec. Max.	10sec. Max.

注: 回流焊后应避免迅速冷却

A-2. 正常工作条件下的参数显示

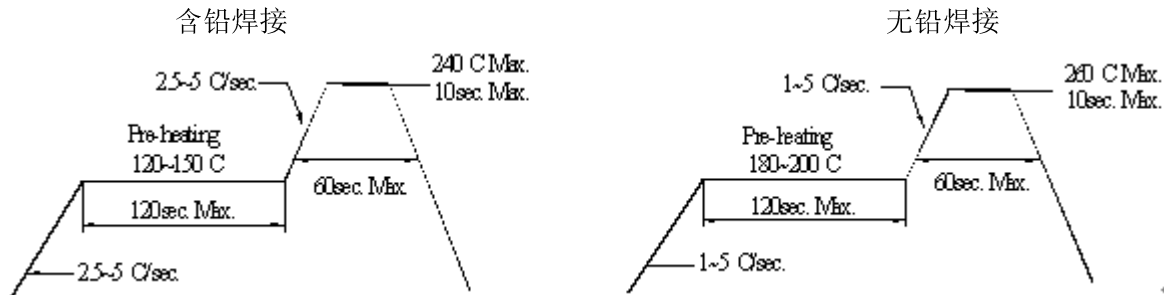

B-1. 手工焊接程序:

手工焊接	
温度	350°C Max.
焊接时间	3秒. Max.
注: 单颗材料焊接时间	

B-2 手动焊接注意事项:

- (1). 对于试样或者小批量作业的情况, 采用手动焊接为主。
- (2). 使用锡膏、导电、导热胶时, 请严格按照相应的使用要求作业, LED 发光二极管需与基材紧密连接, 焊接时, 可以轻轻按着产品, 防止产品和基材产生空隙, 如需要返修时, 请不要直接使用硬的工具撞击产品表面, 导致损伤产品, 可用镊子配合烙铁使用, 如下示意图所示。



(3).使用烙铁头的最佳温度为280℃，烙铁的功率 \leq 30瓦。每1PCS材料的焊接时间为 \leq 3S.

(4).注意，采用的焊接方式和条件不当极易对产品造成损坏.

2.5.清洗:

焊接后需做清洗

主要清洗剂:建议使用酒精

清洗条件:50℃* 30秒, 或30℃* 3分钟

超声波清洗:<15W/bath;容量: 最大1升

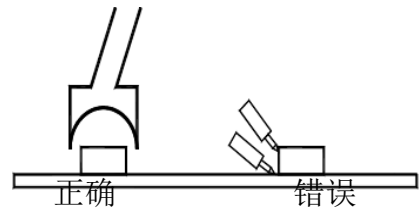

返修示意图

2.6.静电防护:

- (1).LED 是对静电很敏感的产品，因此所有的机械设备、工作台、烙铁必须接上地线，使用人员在接触产品时需佩戴防静电手环或防静电手套，防止静电对产品造成损伤.
- (2).作业时避免一些易产生静电的物品摩擦产生静电对产品造成损伤，所以作业场所尽量不使用易产生静电的物品，建议使用离子风扇离子发生器.
- (3).使用的电流不要过载，不可超过产品的额定电流和电压！反向电压不可过大，建议安装一个保护产品的驱动电路，防止因电流或电压过大造成对产品造成损伤.
- (4).用户需要不定时地检查静电防护措施的效果和落实状况.

3.其他注意事项:

- 3.1.电路设计时，建议使用定电流驱动设计，如以定电压设计，请考虑不同电压所造成的影响.
- 3.2.LED产品为单向导通性，使用安装前请确认产品极性，一般产品缺口边为产品负极，若装反，不能正常点亮，且在施加电压时容易造成LED芯片损伤或失效.
- 3.3.注意正确的电路设计，不当之设计与电流控制，易造成LED失效，如电流过大引起寿命问题甚至烧毁，电流过小引起亮度不足等.
- 3.4.不同BIN号之LED建议分开使用，若需安装在同一个组件时，请先确认是否可满足相关电气及光学特性要求，如电流是否均衡，光色、亮度的一致性.



Storage

Recommended storage environment

Temperature: 5°C ~ 30°C (41°F ~ 86°F)

Humidity: 60% RH Max.

Recommend the use of drying cabinet storage.

Recommended storage period is 1 month. Storage beyond such period requires baking treatment (as described below).

Use

Please check the Humidity indicator card after opening of sealed vapor/ESD (Picture 1.) If the 40% circle color is still blue, the product could normal use. Otherwise, 40% circle color is pink; please follow below Baking treatment before normal use.

Baking treatment : Open-static bag, the product and reel dial out from the Static bag, and then 75±5°C for 8 hours baking treatment.

All un-sealed products are recommended to be used within 12 hours (under a condition of ≤30°C, ≤60%RH). Seal all remaining products in time, recommend storage in dry cabinet storage. It must be baking treatment when using the remaining product.

Soldering

A. Reflow Process

Reflow Soldering		
	Lead Solder	Lead – free Solder
Pre-heat	120~150°C	180~200°C
Pre-heat time	120sec. Max.	120sec. Max.
Peak temperature	240°C Max.	260°C Max.
Soldering time	10sec. Max.	10sec. Max.
Condition	refer to Temperature-profile 1	refer to Temperature-profile 2

After reflow soldering rapid cooling should be avoided.

[Temperature-profile (Surface of circuit board)] Use the conditions shown to the under figure.

<1 : Lead Solder>

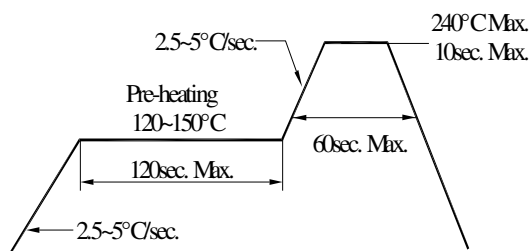

<2 : Lead-free Solder>

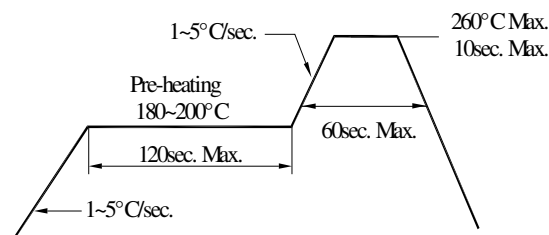

B. Manual Soldering Process

Hand Soldering	
Temperature	350°C Max.
Soldering time	3sec. Max. (one time only)

- For prototype builds or small series production runs it is possible to place and solder the LED by hand.
- Dispense thermal conductive glue or grease on the substrates and follow its curing specifications. Gently press LED housing to closely connect LED and substrate.
- It is recommended to hand solder the leads with a solder tip temperature of 280°C for less than 3 second, at a time with a soldering iron of less than 30W. Solder at intervals of two seconds or more.
- Take caution and be aware that damaged products are often a result of improper hand soldering technique.



Rework

1. Customer must finish rework within 5 sec under 260°C
2. The head of iron cannot touch the resin
3. Twin-head type is preferred.

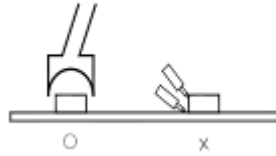

Cleaning :

The conditions of cleaning after soldering:

An alcohol-based solvent such as Isopropyl Alcohol(IPA) is recommended.

Temperature Time:<50°C *30sec,or <30°C *3min

Ultra sonic cleaning:<15W/bath; Bath volume:1liter max.

Curing:100 max,<3min

Cautions of Pick and Place:

It should be avoided to load stress on the resin during high temperature.

Avoid rubbing or scraping the resin by any object.

Electric-static may cause damage to the component. Please confirm that the equipment is grounding well. Using an ionizer fan is recommended.

Cautions of Design and Applications:

It should be done to connect with a current-limiting serial resistor. Avoid to drive reverse voltage over the specifications on LED when ON/OFF. Any application should refer to the specifications of absolute maximum ratings.

The dimensions of the recommended soldering pattern may not meet every users. Please confirm and study before designing the soldering pattern in order to obtain the best performance of soldering.

Do not contact with any component on the assembly board.

Static Electricity:

These products are so sensitive to static electricity charge so that all equipment and machinery must be properly grounded and it is recommended to use a wristband or anti-electrostatic glove when handling the SMD LED. Particularly if any over-current and over-voltage which exceed the Absolute Maximum Ratings of LED applied, the more energy may cause damage or possibly result in electrical destruction of the Products.

A protection design should be installed in the LED driving circuit, which does not exceed the max. rating for surge current during on/off switching.

A tip if soldering iron is requested to be grounded .An ionizer should be installed when risk of static generation is high.

If the countermeasures mentioned above are implemented, LED can work well.

Users are required to check those countermeasures when problems occur by static electricity charge

Other:

Damaged SMD LED will show unusual characteristics such as leak current remarkably low current. Increase, turn-on voltage becomes lower and the SMD LED get unlighted at low current.

In automatic mounting of the SMD LEDs on printed circuit boards, any bending and pulling forces or shock against the SMD LEDs shall be kept min. to prevent them from expanding or electrical failures and mechanical damages of the devices.

X-ON Electronics

Largest Supplier of Electrical and Electronic Components

Click to view similar products for [Standard LEDs - SMD category](#):

Click to view products by [Wah Wang manufacturer](#):

Other Similar products are found below :

[LTST-C19GD2WT](#) [LTST-N683GBEW](#) [597-3006-607F](#) [597-3403-607F](#) [LTW-K140SZR40](#) [LTW-M140ZVS](#) [598-8110-100F](#) [598-8170-100F](#)
[598-8610-202F](#) [7012X7](#) [AAAF5060QBFSEEZGS](#) [12-22SURSYGC/S530-A3/E2/TR8](#) [1383SURT/S530-A3/TR1\(R\)](#) [APT1608QGW](#)
[EASV1803BA0](#) [SML310BATT86](#) [SML-512VWT86A](#) [SML-LX0606SISUGC/A](#) [SML-LXL1307SRC-TR](#) [SML-LXR851SIUPGUBC](#)
[LT1ED53A](#) [17-21/G6C-FM1N2B/3T](#) [FAT801-S](#) [SSL-LXA227IC-TR31A](#) [AM27ZGC03](#) [APB3025SGNC](#) [APHK1608VGCA](#) [APT2012QGW](#)
[CLMVC-FKA-CA1E1L81BB7C3C3](#) [CLYBA-FKA-CFHHL9BBB7A363](#) [CMD11504UR](#) [LTW-020ZDCG](#) [LTW-21TS5](#) [LTW-K140SZR30](#)
[HSMY-C177](#) [UYGT801-S](#) [KVH1C100MF6R](#) [42-21SYGC/S530-E1/TR8](#) [YGFR411-H](#) [597-2311-402F](#) [597-2712-602F](#) [5973212407NF](#)
[597-3302-607F](#) [597-5202-407F](#) [598-8330-117F](#) [SAW8WA2A-L35M40-CA](#) [SML013WBDW1](#) [SML-LX0402IC-TR](#) [CLMVC-FKA-](#)
[CLBDGL7LBB79353](#) [VLMKG3400-GS08](#)