

**Schroff**

**EuropacPRO kit, light design, unshielded, for backplane mounting**

Catalog Number: 24564-433



- Aluminum construction
- Subrack with side panel type L ("light") with firmly fixed 19" brackets
- Rear horizontal rails for backplane mounting with insulation strip
- Internal and external dimensions in accordance with: IEC 60297-3-100, -101, IEEE 1101.1
- IP 20, in accordance with IEC 60529
- Modifications such as cutouts, different finishes or dimensions available
- Supplied as space-saving flat-pack
- Horizontal rail type "light"

Other Views

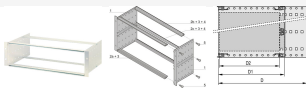

**Description**

**Load:**

Minimal

**Shock/vibration:**

Minimal

**Design:**

EuropacPRO, Light

**EMC Shielding:**

- Retrofitable
- Unshielded

**Type:**

Subrack Kit

**Note:**

Subrack is not prepared for shielding

**Delivery Comprises:**

Item	Quantity	Description
1	2	Side panel type L, Al, 2 mm, passivated, with built-in 19" support bracket
2a	2	Front horizontal rail (L-KD)
2c	1	Rear horizontal rail centre (H-ST)
2b	2	Rear horizontal rail (L-ST)
3	6	Threaded inserts, front and rear (pre-fitted)
4	4	Insulation strip (pre-fitted)
5	1	Fixing materials kit, user manual

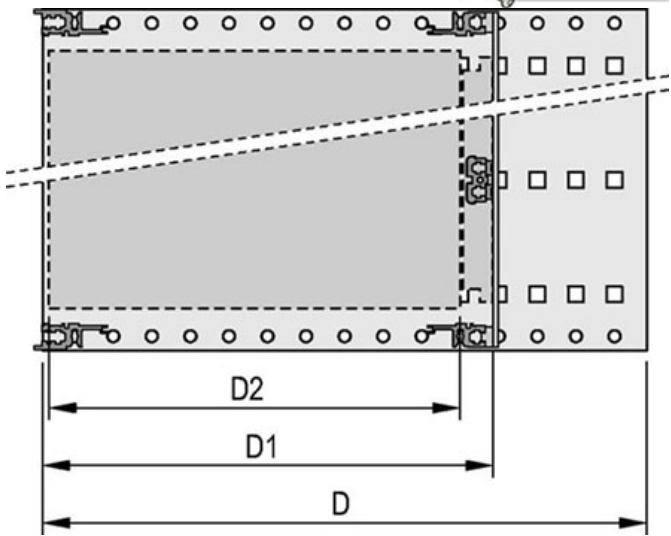
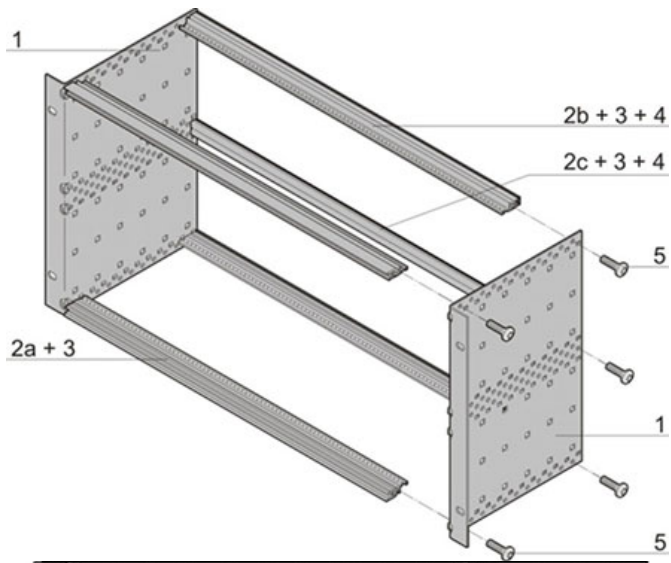

D = overall depth, D1 = insertion depth, D2 = board depth = D1 - 15 mm







Rear horizontal rail for backplane mounting with insulation strip

## Technical Data

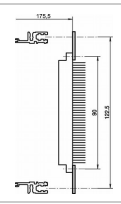
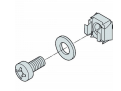
Catalog Number	<a href="#">24564-433</a>
Depth mm	295.0
Height U	6.0
Width HP	84.0
Depth D mm	295.0
Depth D1 mm	175/235/295

## Accessories

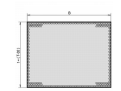
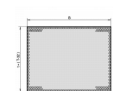
Item		
	Perforated rail for connector according to EN 60603-2 (DIN 41612), 84 HP, with thread M2.5, PU 4 pieces	20822-048
	19" fixing material kit (screw, washer, nut), (8 x screws, 8 x plastic washers, 8 x cage nuts)	21100-435
	ESD clip for guide rails, Spring steel, tin-plated, silver, PU 50 pieces	24560-255
	Guide rails, standard, 160 mm deep, PBT, UL 94 V-0, red, groove width 2 mm, PU 10 pieces	24560-351
	Guide rails, standard, 220 mm deep, PBT, UL 94 V-0, red, groove width 2 mm, PU 10 pieces	24560-353
	Cover plate standard, 160 mm deep, Al, 1.2 mm, perforated, to push into light horizontal rail, PU 2 pieces	24561-051
	Cover plate standard, 220 mm deep, Al, 1.2 mm, perforated, to push into light horizontal rail, PU 2 pieces	24561-052

## X-ON Electronics

Largest Supplier of Electrical and Electronic Components

*Click to view similar products for [Enclosures, Boxes, & Cases](#) category:*

*Click to view products by [Schroff](#) manufacturer:*

Other Similar products are found below :

[CR-425 PAINTED](#) [585-R-WH-PK](#) [M-10-PLATED](#) [60221-01](#) [60566-01-000](#) [HPL-9VB BATT DOOR](#) [M-16-LID-PLATED](#) [M18-PLTD](#) [M-21-LID-PLATED](#) [M-21-PLATED](#) [M-23-PLATED](#) [CU-281-MB](#) [6711GSKT](#) [71884-29-028](#) [LH45-100 Black](#) [7200B](#) [72868-510-000](#) [CNS-0000 Black](#) [72883-510-000](#) [CNS-0101 Black](#) [72906-510-000](#) [CNS-0407 Black](#) [73091-510-000](#) [CNM-0000-BLACK Kit](#) [73092-510-000](#) [CNM-0101 Black](#) [73108-510-000](#) [CNL-0303 Black](#) [73395-510-039](#) [CNS-0006 Bone](#) [74257-510-000](#) [CNL-0004](#) [MDC-1183-PLAIN-ALUM](#) [MDC-1183-PTD](#) [MDC-13104-PLAIN-ALUM](#) [MDC-211 - PAINTED IVORY/BEIGE](#) [MDC-321-PTD](#) [MDC-432-PLAIN-ALUM](#) [MDC-973-PTD](#) [76](#) [77153-01-028](#) [FLX6030](#) [83535-01-508](#) [PS-11296-G](#) [PS-11298-B](#) [116-508](#) [120-407](#) [120-412](#) [120-909](#) [120-455](#) [R272-100-000](#) [120-910](#) [R501-001-010](#) [R508-080-000](#) [R508-160-000](#) [R530-120-000](#) [R530-122-000](#) [R530-200-000](#) [R531-160-000](#) [R531-200-000](#) [R582-080-100](#)