

GP Batteries

DATA SHEET

Description	: Flat Lithium Battery
Chemical system	: Lithium Manganese Dioxide
Nominal voltage	: 3 Volts
Nominal capacity	: 300mAh@6.8k Ω to 2.5V
Dimensions	: ϕ 24.5 x 3.0mm
Shelf life	: 5 years at room temperature
Average weight	: 4 grams
Application	: Watch, calculator, camera and memory back up

Cross References:

IEC	JIS	Eveready	Varta	Duracell
CR2430	CR2430	ECR2430	CR2430	DL2430

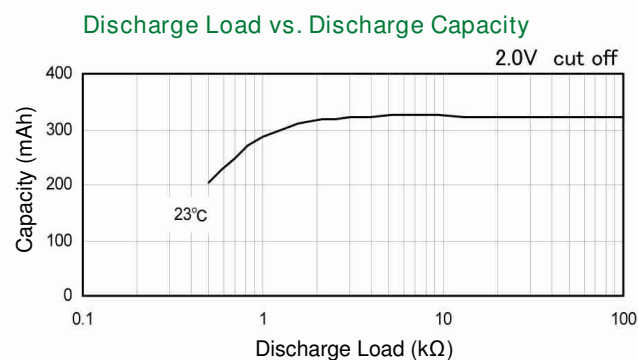
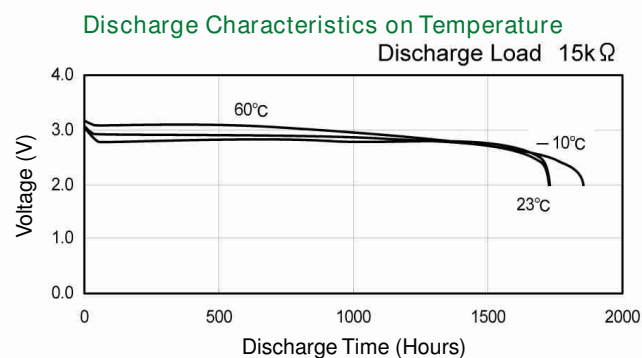
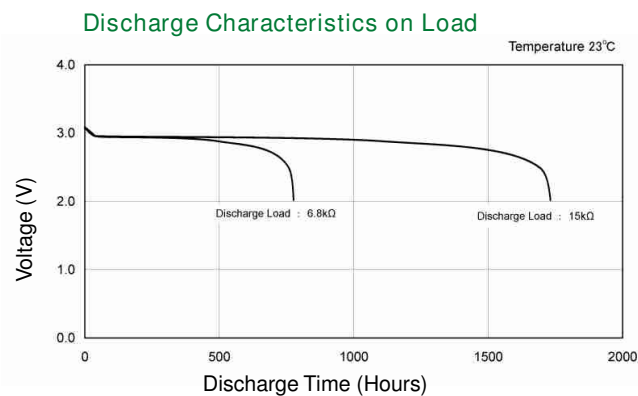

Model No.: **CR2430**

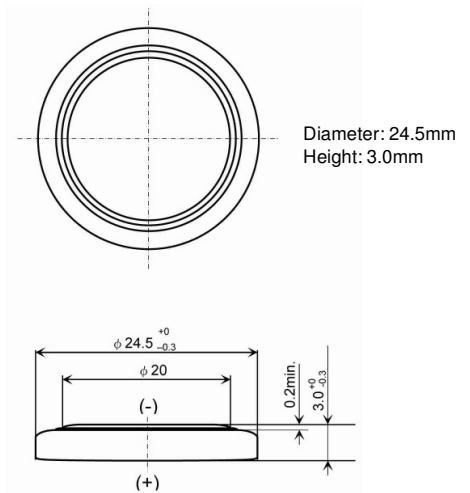

Dimension Drawing

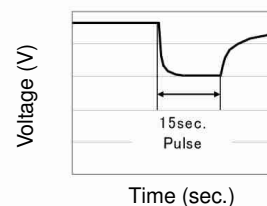
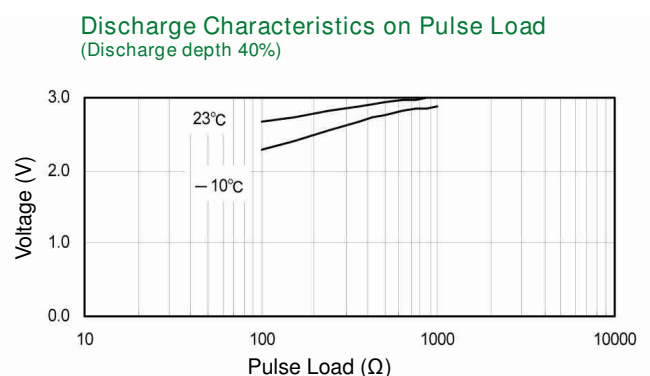

The information (subject to change without prior notice) contained in this document is for reference only and should not be used as a basis for product guarantee or warranty. For applications other than those described here, please consult your nearest GP Sales and Marketing Office or Distributors.

www.gpbatteries.com

Manufacturer reserves the right to alter or amend the design, model and specification without prior notice.
Copyright© GPI International Ltd. - All rights reserved

 Member
Gold Peak Group

09060106312

X-ON Electronics

Largest Supplier of Electrical and Electronic Components

Click to view similar products for [pro elec manufacturer](#):

Other Similar products are found below :

[PE01004](#) [LMP-G60BCW07-02B](#) [PSG91116](#) [PEL00582](#) [PEL00418](#) [PEL00217](#) [PEL00156](#) [PEL00170](#) [PEL00175](#) [PEL00251](#) [PE01003](#)
[PEL00581](#) [PEL00346](#) [PEL00350](#) [PEL00291](#) [PEL00153](#) [PEL00061](#) [PEL00199](#) [PEL00371](#) [PE01005](#) [PEL00414](#) [JR60431](#) [PEL00417](#)
[PEL00091](#) [PEL00075](#) [PEL00222](#) [PEL00144](#) [PEL00227](#) [PEL00151](#) [PEL00154](#) [PEL00281](#) [LMP-G60E27W07-02B](#) [PSG91112](#) [2213U 2.4A](#)
[PEL00093](#) [PEL00223](#) [PEL00165](#) [PEL00051](#) [HS-5626](#) [1518C WHT](#) [PEL00067](#) [PEL00221](#) [PEL00225](#) [PEL00157](#) [PEL00162](#) [PEL00163](#)
[PEL00231](#) [PE000031](#) [PC2213U](#) [PEL00347](#)