

PSAN Series

Small size, 1/2,000 resolution connector type digital pressure sensor

■ Features

- Ideal for a wide range of applications of gas, liquid, and oil.
(Inappropriate to corrosion environment for SUS316L)
- Enhanced environmental resistance with diaphragm
- 1/2,000 high resolution for indication
- Hold/Auto shift input function
(Only for models with Hold/Auto shift input type)
 - Hold : Holding instantaneous outputs and display value
 - Auto shift : Enable to output regardless of initial pressure change
- Hold function for instantaneous outputs and holding display value
- 2 independent outputs and NO/NC output selectable
- Forced-output mode embodied for easy operation test and monitoring
- One-touch connector type for easy maintenance
- Analog output (1/2,000 resolution, voltage : 1–5V, current : 4–20mA)
- Zero-point adjustment function, peak monitoring function, and chattering prevention function



Pneumatic type

Line-up



Fluid type

⚠ Please read "Caution for your safety" in operation manual before using.



■ Ordering information

PS AN - [] V 01 C P V - Rc1/8

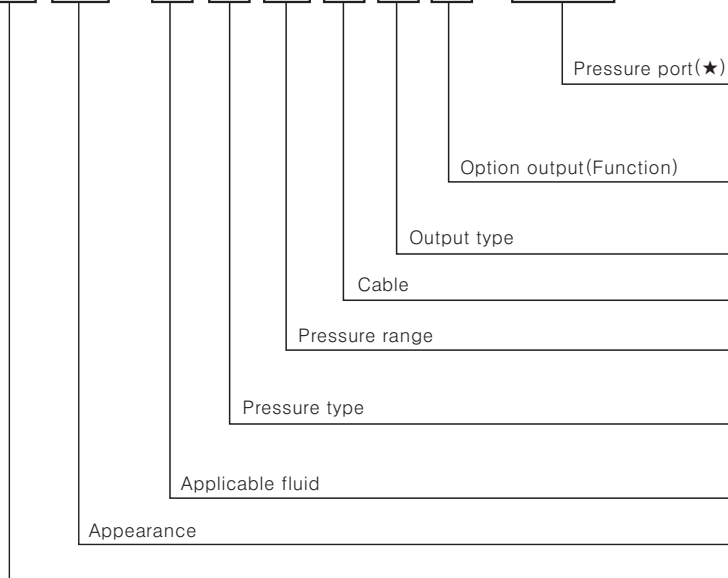

R1/8	Standard(Fluid type)
Rc1/8	Standard(Pneumatic type)
NPT1/8	Option
7/16–20UNF	Option(Fluid type)
V	Analog voltage(1–5V) output
A	Analog current(4–20mA) output
H	Hold/Auto shift input
Blank	NPN open collector output
P	PNP open collector output
C	Connector type
01	100kPa
1	1MPa
Blank	Positive pressure type
V	Vacuum pressure type
C	Compound pressure type
Blank	Pneumatic type(Gas)
L	Fluid type(Gas, Liquid, Oil)
AN	Regular square New type(30mm×30mm)
PS	Pressure Sensor

※ (★) In case of using M5 port, use PSO–Z01 (M5 Gender) together.

■ Pressure and Max. pressure display range

Type	kPa	kgf/cm ²	bar	psi	mmHg	inHg	mmH ₂ O
Vacuum pressure	0.0 to -101.3 (5.0 to -101.3)	0.000 to -1.034 (0.051 to -1.034)	0.000 to -1.013 (0.050 to -1.013)	0.00 to -14.70 (0.74 to -14.70)	0 to -760 (38.0 to -760.0)	0.0 to -29.9 (1.50 to -29.90)	0.0 to -103.4 (5.1 to -103.4)
Positive pressure	0.0 to 100.0 (-5.0 to 110.0)	0.000 to 1.020 (-0.051 to 1.122)	0.000 to 1.000 (-0.050 to 1.100)	0.00 to 14.50 (-0.72 to 15.96)	—	—	—
	0 to 1000 (-50 to 1100)	0.00 to 10.20 (-0.51 to 11.22)	0.00 to 10.00 (-0.50 to 11.00)	0.0 to 145.0 (-7.2 to 159.6)	—	—	—
Compound pressure	-101.3 to 100.0 (-101.3 to 110.0)	-1.034 to 1.020 (-1.034 to 1.122)	-1.013 to 1.000 (-1.013 to 1.100)	-14.70 to 14.50 (-14.70 to 15.96)	-760 to 750 (-760.0 to 824.0)	-29.9 to 29.5 (-29.88 to 32.58)	-103.4 to 102.0 (-103.4 to 112.2)

※ () is Max. pressure display range.

※ For using a unit mmH₂O, multiply display value by 100.

Pressure Sensor

Pressure conversion chart

from \ to	Pa	kPa	MPa	kgf/cm ²	mmHg	mmH ₂ O	psi	bar	inHg
1kPa	1000.000	1	0.001000	0.010197	7.500616	101.9689	0.145038	0.010000	0.2953
1kgf/cm ²	98066.54	98.066543	0.09806	1	735.5595	10000.20	14.22334	0.980665	28.95878
1mmHg	133.322368	0.133322	0.000133	0.001359	1	13.5954	0.019336	0.001333	0.039370
1mmH ₂ O	9.80665	0.00980	—	0.000099	0.0735578	1	0.00142	0.000098	0.002895
1psi	6894.757	6.89493	0.00689	0.070307	51.71630	703.07	1	0.068947	2.036074
1Pa	10000.0	100.0000	0.100000	1.019689	750.062	10196.89	14.50339	1	29.52998
1inHg	3386.417	3.386388	0.003386	0.034532	25.40022	345.31849	0.491158	0.033863	1

Ex) For calculating 760mmHg as kPa :

According to above chart, 1mmHg is 0.133322kPa, therefore 760mmHg will be 760×0.133322kPa=101.32472kPa.

Specifications

Pressure type		Gauge pressure							
		Vacuum pressure type	Positive pressure type		Compound pressure type				
Model (★1)	Analog voltage output	PSAN-(L)V01C(P)V-□	PSAN-(L)01C(P)V-□	PSAN-(L)1C(P)V-□	PSAN-(L)C01C(P)V-□				
	Analog current output	PSAN-(L)V01C(P)A-□	PSAN-(L)01C(P)A-□	PSAN-(L)1C(P)A-□	PSAN-(L)C01C(P)A-□				
	Hold/Auto shift input	PSAN-(L)V01C(P)H-□	PSAN-(L)01C(P)H-□	PSAN-(L)1C(P)H-□	PSAN-(L)C01C(P)H-□				
Rated pressure range		0.0 to -101.3kPa	0.0 to 100.0kPa	0 to 1,000kPa	-101.3kPa to 100.0kPa				
Display pressure range		5.0 to -101.3kPa	-5.0 to 110.0kPa	-50 to 1,100kPa	-101.3kPa to 110.0kPa				
Min. display unit (internal resolution)		0.1kPa (1/2,000)	0.1kPa (1/2,000)	1kPa (1/2,000)	0.1kPa (1/2,000)				
Max. pressure range		2 times of rated pressure		1.5 times of rated pressure	2 times of rated pressure				
Applicable fluid		<ul style="list-style-type: none"> • Pneumatic type ☞ Air, Non-corrosive gas • Fluid type ☞ Air, Non-corrosive gas and fluid that will not corrode SUS316L 							
Power supply		12V-24VDC ±10% (Ripple P-P:Max. 10%)							
Current consumption		Max. 50mA (Analog Current Output type Max 75mA)							
Control output		<ul style="list-style-type: none"> • NPN open collector output ☞ Max. sink current:Max. 100mA, Applied voltage:Max. 30VDC, Residual voltage:Max. 1V • PNP open collector output ☞ Max. source current:Max. 100mA, Residual voltage:Max. 2V 							
Hysteresis (★2)		Min. display range							
Repeat error		±0.2%F.S ± Min. display range							
Response time		Selectable 2.5ms, 5ms, 100ms, 500ms, 1000ms							
Short circuit protection		Built-in							
Analog output (★3)	Voltage output	<ul style="list-style-type: none"> • Output voltage:1-5VDC ±2% F.S • Zero point:Within 1VDC ±2% F.S • Resolution:1/2,000 (equal to display resolution) • Response Time:50ms 							
	Current output	<ul style="list-style-type: none"> • Output current:4-20mA ±2% F.S • Linear:Within ±1% F.S • Zero-point:Within 4mA ±2% F.S • Span:Within 16mA ±2% F.S • Resolution:1/2,000 (equal to display resolution) • Response Time:70ms 							
Display method		4 digit LED 7segment							
Min. Display interval (★4)	pressure unit \ resolution	1000	2000	1000	2000	1000	2000	1000	2000
	kPa	0.1	—	0.1	—	1	—	—	0.1
	kgf/cm ²	0.001	—	0.001	—	0.01	—	—	0.001
	bar	0.001	—	0.001	—	0.01	—	—	0.001
	psi	—	0.01	—	0.01	—	0.1	—	0.02
	mmHg	—	0.4	—	—	—	—	—	0.8
inHg	—	0.02	—	—	—	—	—	0.03	
mmH ₂ O	0.1	—	—	—	—	—	—	0.1	
Characteristic of control output and display temp.		Max. ±0.5% F.S. of display pressure at 25°C within 0°C to 50°C ※Max. ±1% F.S. of display pressure at 25°C under -10°C							
Analog output temp. characteristic		Max. ±2% F.S. of display pressure at 25°C within 0°C to 50°C							
Dielectric strength		1000VAC 50/60Hz for 1 minute							
Insulation resistance		Min. 50MΩ (at 500VDC megger)							
Ambient temperature		-10°C to +50°C (at non-dew status)							
Storage temperature		-20°C to +60°C (at non-freezing status)							
Ambient humidity		30 to 80%RH							
Storage humidity		30 to 80%RH							
Vibration		1.5mm amplitude at frequency of 10 to 55Hz in each of X, Y, Z direction for 2 hours							
Protection		IP40 (IEC specification)							
Material		<ul style="list-style-type: none"> • Pneumatic type ☞ Front case : PC, Rear case : PC, Pressure port : Nickel Plated Brass • Fluid type ☞ Front case : PC, Rear case : PA6, Pressure port : SUS316L 							
Cable		Connector cable (φ4, 5P, Length: 2m, AWG 24, Insulator diameter: φ1)							
Approval		CE							
Unit weight		<ul style="list-style-type: none"> • Pneumatic type ☞ Approx. 84g • Fluid type ☞ Approx. 57.5g 							

※F.S : Rated pressure.

※(★1) (P) is PNP output type, □ of model name is as pressure port.

※(★2) In hysteresis output mode, detection difference is variable. ※(★3) It is allowed to select one analog output type only.

※(★4) Resolution (1000/2000) of min. Display interval is automatically selected depend on pressure units.

(A) Photo electric sensor

(B) Fiber optic sensor

(C) Door/Area sensor

(D) Proximity sensor

(E) Pressure sensor

(F) Rotary encoder

(G) Connector/Socket

(H) Temp. controller

(I) SSR/Power controller

(J) Counter

(K) Timer

(L) Panel meter

(M) Tacho/Speed/Pulse meter

(N) Display unit

(O) Sensor controller

(P) Switching power supply

(Q) Stepping motor & Driver & Controller

(R) Graphic/Logic panel

(S) Field network device

(T) Production stoppage models & replacement

PSAN Series

● Analog output voltage and current—Pressure characteristic

(Normal Example)

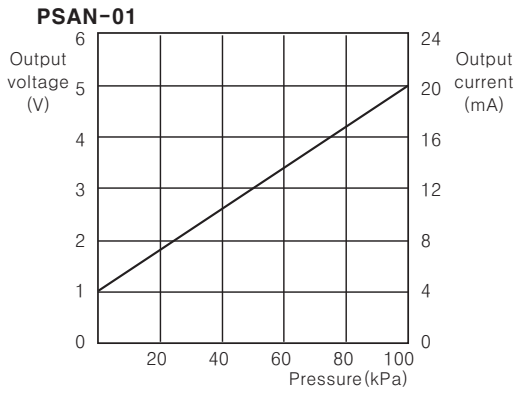

● Analog output voltage and current—Linear characteristic

(Normal Example)

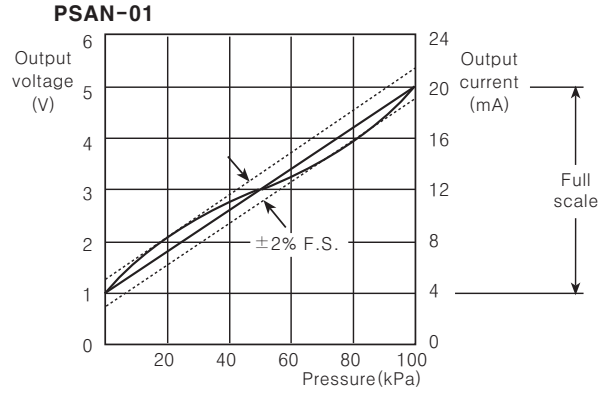

■ Dimensions

◎ Pneumatic type

(Unit:mm)

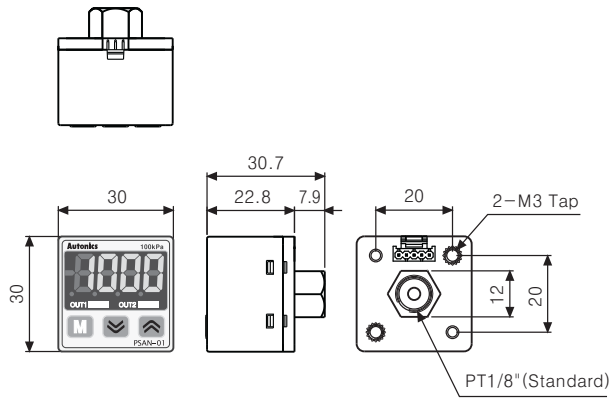

● Panel mounting bracket

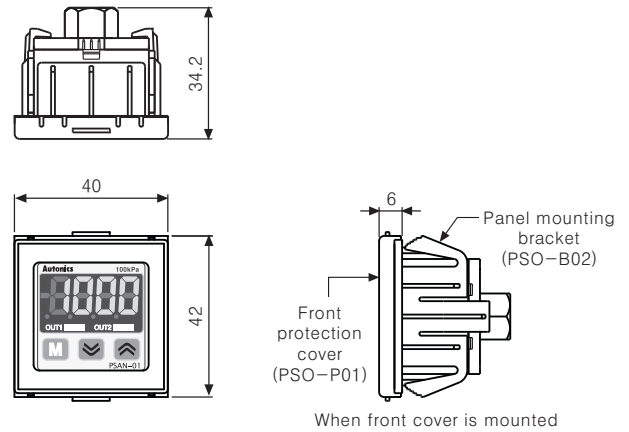

When front cover is mounted

● Fixing bracket A for mounting

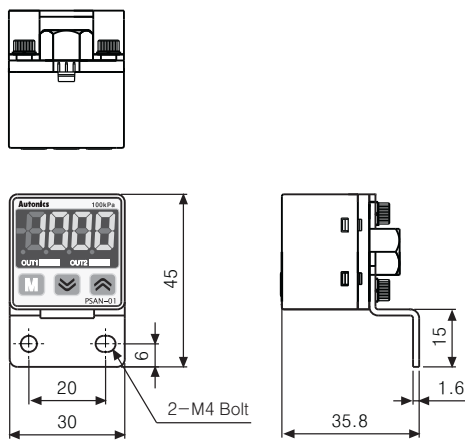

● Fixing bracket B for mounting

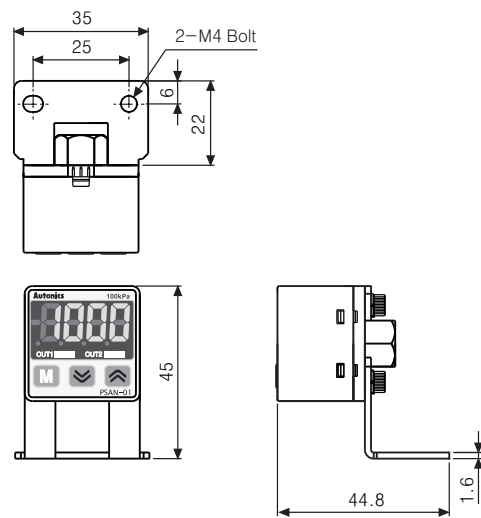

Pressure Sensor

Dimensions

Fluid type

(Unit:mm)

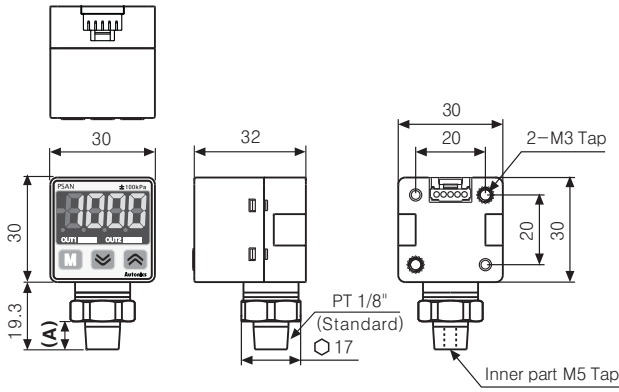

※ (A) PT1/8" model(Standard): 8, NPT1/8" model: 8,
7/16"-20 UNF model: 11
※ (*1) Only for PT1/8" model, NPT1/8" model

Panel mounting bracket

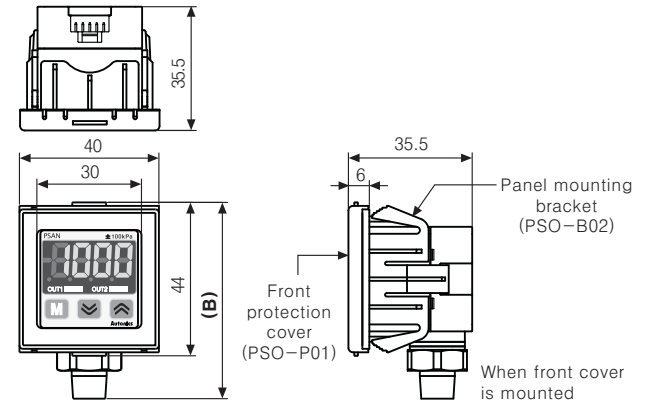

※ (B) PT1/8" model(Standard): 56.3, NPT1/8" model: 56.3,
7/16"-20 UNF model: 59.3

Fixing bracket A for mounting

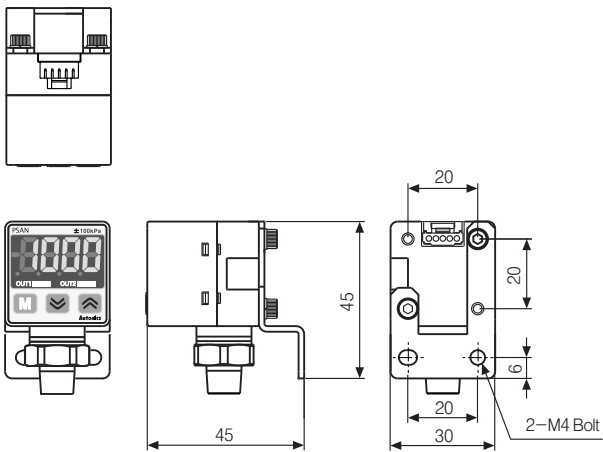

Fixing bracket B for mounting

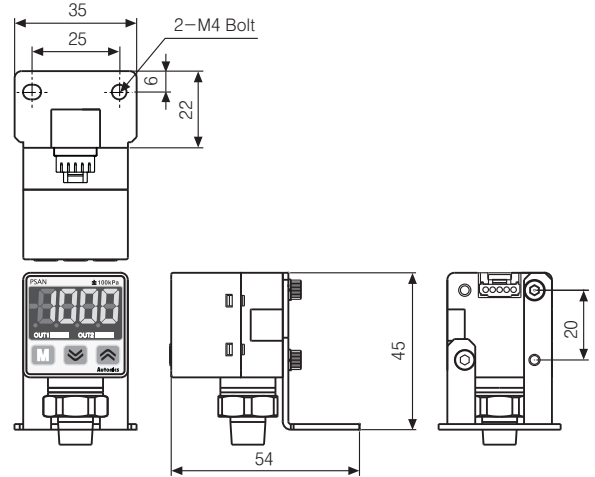

Accessory(Sold separately)

Panel cut-out

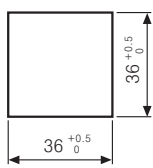

(Panel thickness :
0.8mm to 3.5mm)

Panel mounting bracket



< PSO-B02 >

Front protection cover

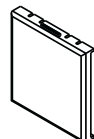

< PSO-P01 >

M5 Gender



< PSO-Z01 >

Accessory

Pressure unit label

±100kPa	-101.3kPa	2kPa	10kPa	100kPa	1MPa
±1.020kgf/cm ²	-1.034kgf/cm ²	2.040kgf/cm ²	10.20kgf/cm ²	1.020kgf/cm ²	10.20kgf/cm ²
±14.50psi	-14.70psi	29.00psi	145.0psi	14.50psi	145.0psi
±1.000bar	-1.013bar	2.000bar	10.00bar	1.000bar	10.00bar
±750mmHg	-760mmHg				
±29.5inHg	-29.9inHg			/100	/100
±10.20mmH ₂ O	-103.4mmH ₂ O	2.040mmH ₂ O	10.20mmH ₂ O	X100	X100

DISPLAY UNIT LABEL

Bracket A

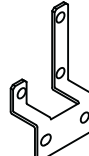

Bracket B

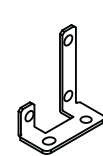

Connector cable(PSO-C01)

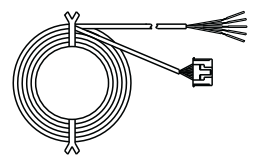

Bracket A

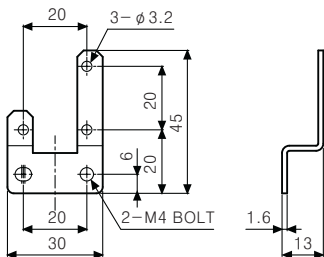

Bracket B

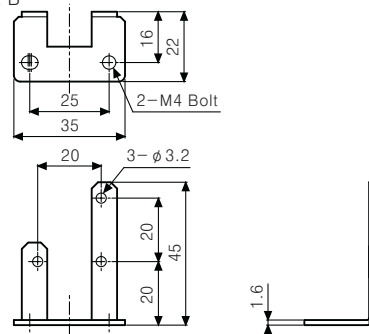

(A) Photo electric sensor

(B) Fiber optic sensor

(C) Door/Area sensor

(D) Proximity sensor

(E) Pressure sensor

(F) Rotary encoder

(G) Connector/Socket

(H) Temp. controller

(I) SSR/Power controller

(J) Counter

(K) Timer

(L) Panel meter

(M) Tacho/Speed/Pulse meter

(N) Display unit

(O) Sensor controller

(P) Switching power supply

(Q) Stepping motor & Driver & Controller

(R) Graphic/Logic panel

(S) Field network device

(T) Production stoppage models & replacement

PSAN Series

Control output diagram

Analog output (Voltage output PSAN-□□□□V-□, Current output PSAN-□□□□A-□ type)

●NPN open collector output type

●PNP open collector output type

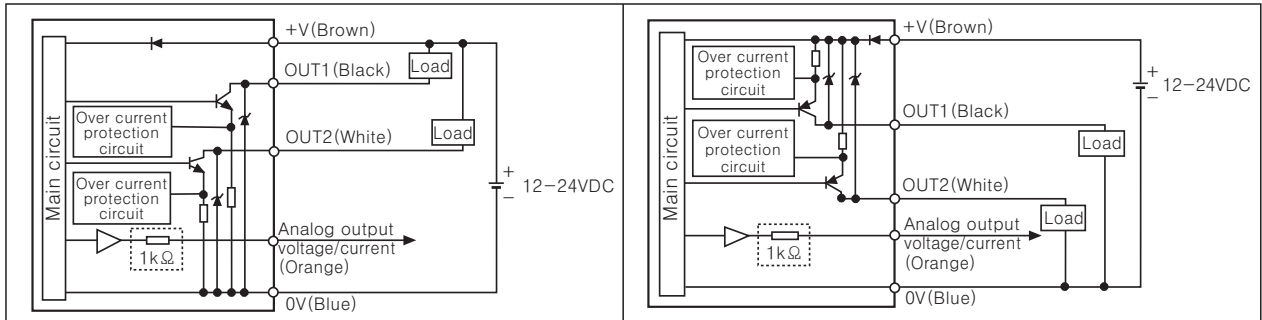

※In case of analog voltage output type models short-circuit protection is not embodied. (: For voltage output type only.)
Do not connect with power source or load directly.

※Be careful with input impedance of connecting devices when using analog voltage output type models.

※Be careful with voltage drop due to cable resistance when extending sensor cable.

Hold/Auto shift input (PSAN-□□□□H-□ type)

●NPN open collector output type

●PNP open collector output type

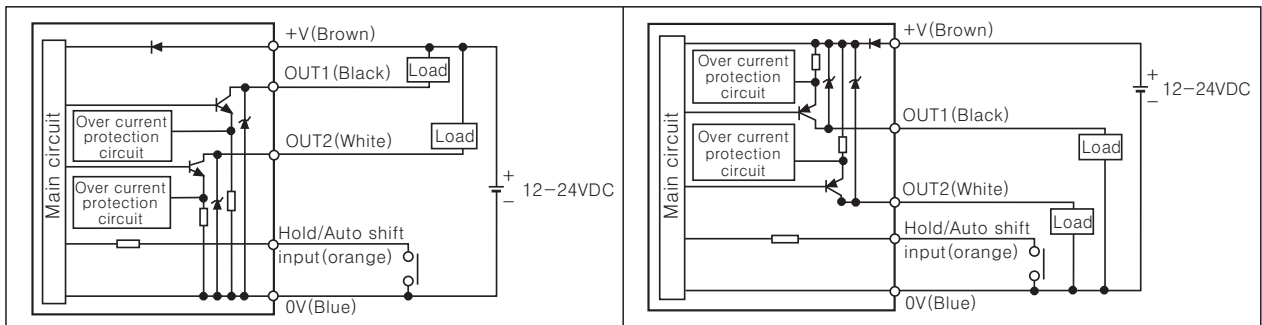

Front panel identification and function

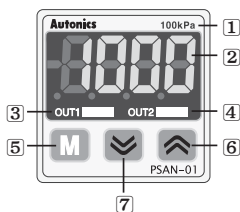

- 1 **Range of rated pressure** : The unit label is changeable.
Please use a desired measure unit label.
- 2 **4 digit LED display (Red)** : Indicates measuring pressure value, setting value, and error message.
- 3 **Output1 indicator (Red)** : Output 1 is ON, LED will be ON.
- 4 **Output2 indicator (Green)** : Output 2 is ON, LED will be ON.
- 5 **M key** : Used to enter into Preset/Parameter setting mode and to save Setting mode.
- 6 **↑ key** : Used to set parameter and preset, peak value check mode, function setting or output operation mode.
- 7 **↑+↓ keys** : Used for zero-point adjustment function by pressing ↑+↓ keys over 1 sec. simultaneously in RUN mode.

Setting

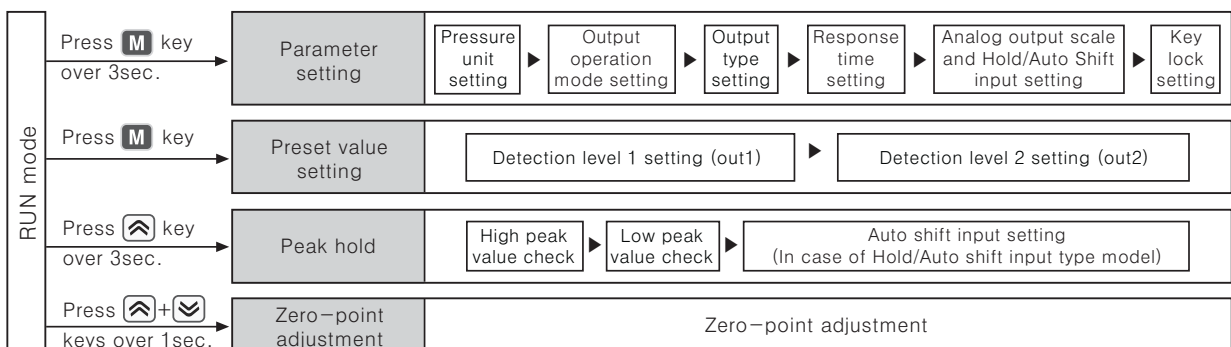

Zero-point adjustment

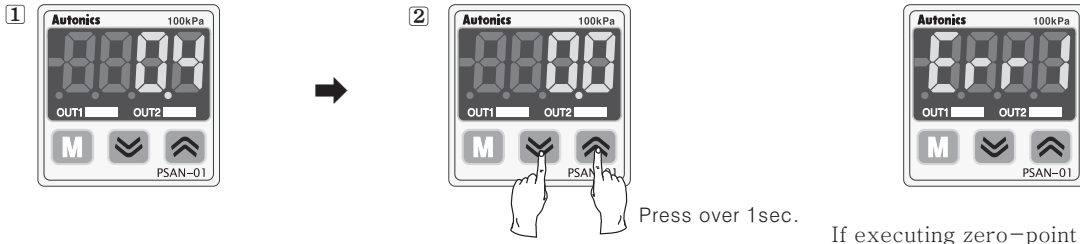

1. In state of atmospheric pressure during RUN mode, press **M** key and **PSAN** key at the same time for over 1sec.
 2. When the zero-point adjustment is completed, it will display **0.00** and return to RUN mode automatically.
- *Please execute zero-point adjustment regularly.

If executing zero-point adjustment when external pressure has been applied, **[Err1]** will flash. Please execute zero-point adjustment again in state of atmospheric pressure without external pressure.

Parameter setting

1. It is able to set pressure unit, display resolution, output operation mode, output type, response time, analog output scale, Hold/Auto shift and key lock setting in parameter setting mode.
2. If the key lock is set (lock1 or lock2), unlock the key lock before setting parameters. (Refer to Key Lock setting below.)

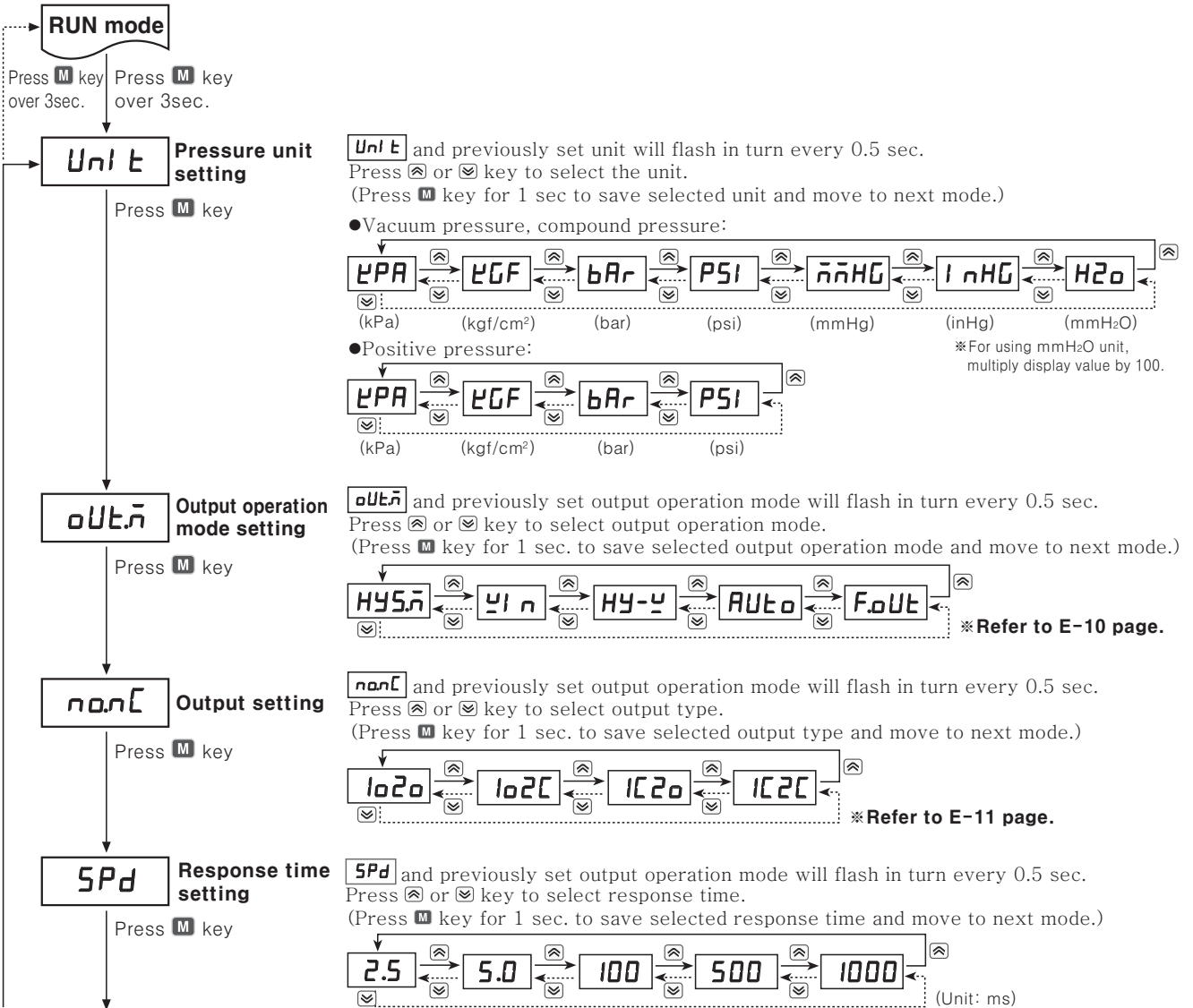

(A)	Photo electric sensor
(B)	Fiber optic sensor
(C)	Door/Area sensor
(D)	Proximity sensor
(E)	Pressure sensor
(F)	Rotary encoder
(G)	Connector/Socket
(H)	Temp. controller
(I)	SSR/Power controller
(J)	Counter
(K)	Timer
(L)	Panel meter
(M)	Tacho/Speed/Pulse meter
(N)	Display unit
(O)	Sensor controller
(P)	Switching power supply
(Q)	Stepping motor & Driver & Controller
(R)	Graphic/Logic panel
(S)	Field network device
(T)	Production stoppage models & replacement

PSAN Series

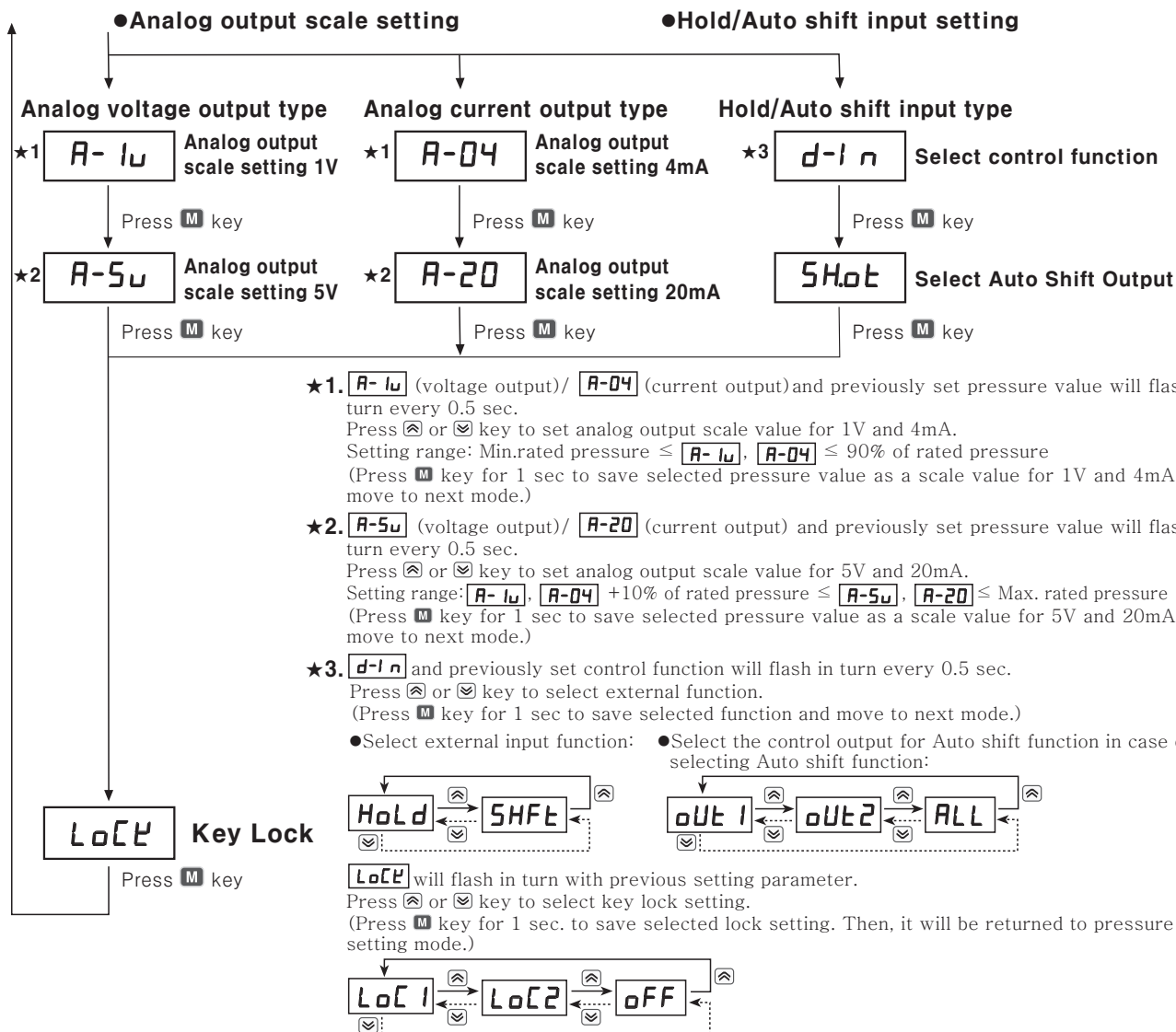

- ※ When pressing **M** key for 3 sec. in the middle of parameter setting, current setting value will be saved in EEPROM and it will be returned to RUN mode.
- ※ All settings are saved in EEPROM regardless of power failure. Make sure that EEPROM has a limited write life cycle (100,000 times).

■ Preset setting

○ Hysteresis mode(HY5.5)

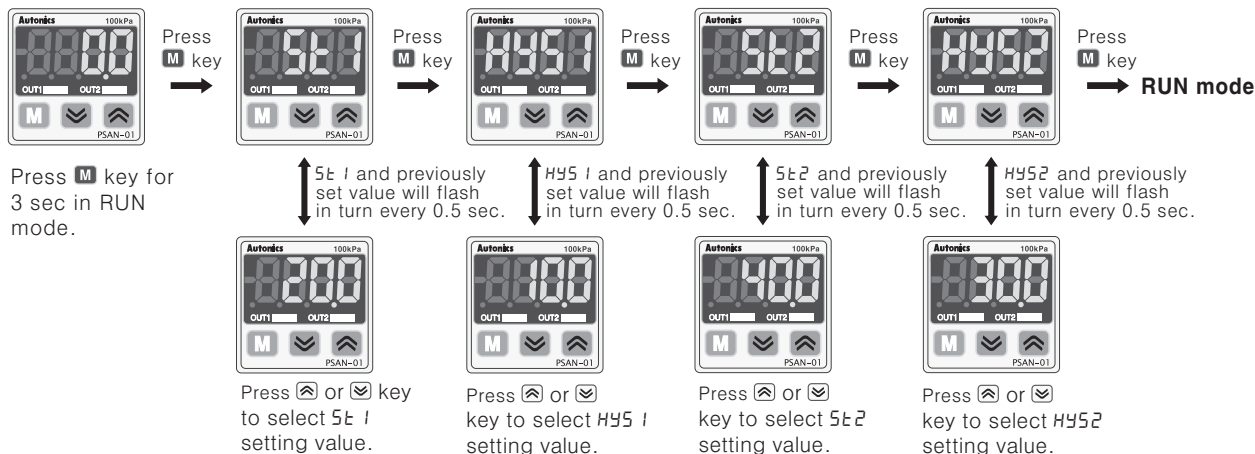

- ※ **5t1** setting range : Min. display pressure < **5t1** ≤ Max. display pressure
- ※ **HYS1** setting range : Min. display pressure < **HYS1** ≤ **5t1**
- ※ **5t2** setting range : Min. display pressure < **5t2** ≤ Max. display pressure
- ※ **HYS2** setting range : Min. display pressure < **HYS2** ≤ **5t2**

Pressure Sensor

Window comparison output mode(㉮㉮)

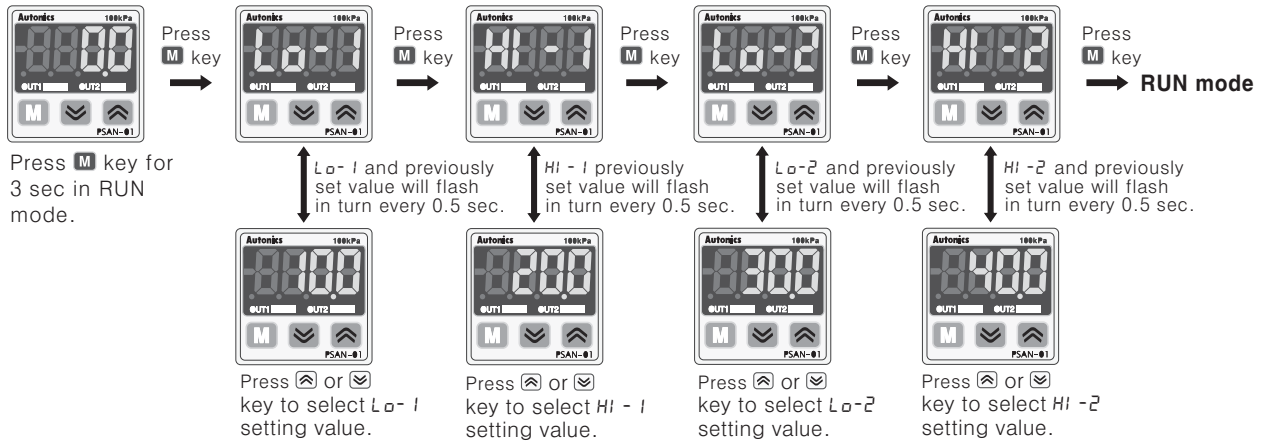

- ※ Low value setting range : Min. display pressure < L0-1, L0-2 ≤ Max. display pressure - (3 × Min. display range)
- ※ High value setting range : L0-1, L0-2 + (3 × Min. display range) ≤ HI-1, HI-2 ≤ Max. display pressure
- ※ The minimum display unit for hysteresis is fixed to 1.

Hysteresis-Window comparison output mode(㉮㉮)

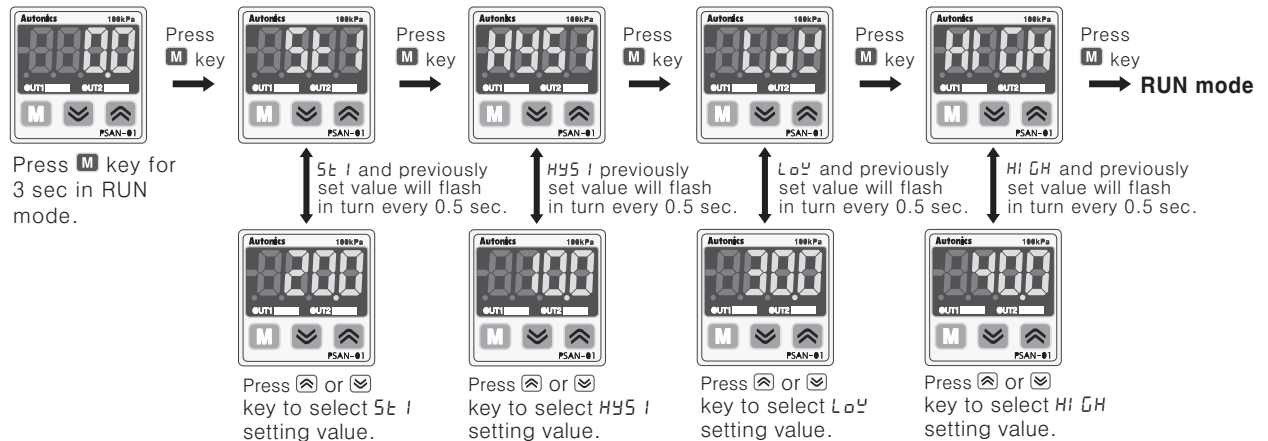

- ※ 5E1 setting range : Min. display pressure < 5E1 ≤ Max. display pressure
- ※ HYS1 setting range : Min. display pressure < HYS1 ≤ 5E1
- ※ Low value setting range : Min. display pressure < L0H ≤ Max. display pressure - (3 × Min. display range)
- ※ High value setting range : Low value + (3 × Min. display range) ≤ HI GH ≤ Max. display pressure
- ※ In case HYS1 and 5E1 have the same setting values, it will have the minimum display unit as a hysteresis.

Automatic sensitivity setting mode(㉮㉮)

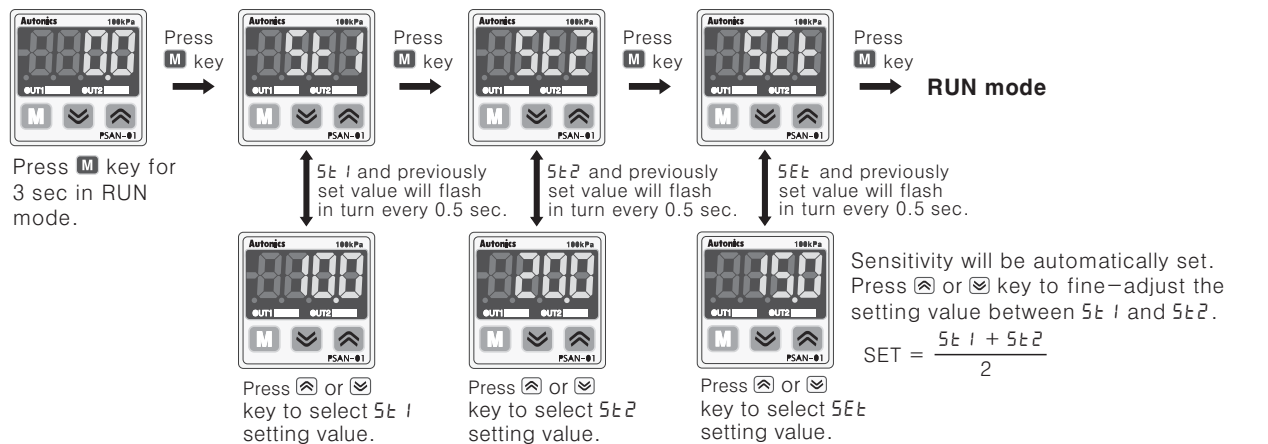

- ※ 5E1 setting range : Min. display pressure ≤ 5E1 ≤ Max. display pressure - 1% of rated pressure
- ※ 5E2 setting range : 5E1 + 1% of rated pressure ≤ 5E2 ≤ Max. display pressure
- ※ If certain detection level difference is not ensured, or setting conditions are not met, E-r-3 message will flash three times and returned to 5E2 setting mode. Check all setting conditions and set proper setting values.
- ※ Press **▲** key to change set values and last set value will be saved for level 1 and level 2.
- ※ In case of PSAN-□□□□H-□ models, it is possible to set 5E1 and 5E2 using option input (yellow) after applying pressure on pressure port.

- (A) Photo electric sensor
- (B) Fiber optic sensor
- (C) Door/Area sensor
- (D) Proximity sensor
- (E) Pressure sensor
- (F) Rotary encoder
- (G) Connector/Socket
- (H) Temp. controller
- (I) SSR/Power controller
- (J) Counter
- (K) Timer
- (L) Panel meter
- (M) Tacho/Speed/Pulse meter
- (N) Display unit
- (O) Sensor controller
- (P) Switching power supply
- (Q) Stepping motor & Driver & Controller
- (R) Graphic/Logic panel
- (S) Field network device
- (T) Production stoppage models & replacement

Output operation mode

1. Hysteresis mode(HY5.ñ)

It is able to set certain value for pressure detection level(5t1, 5t2) and hysteresis(HY51, HY52).

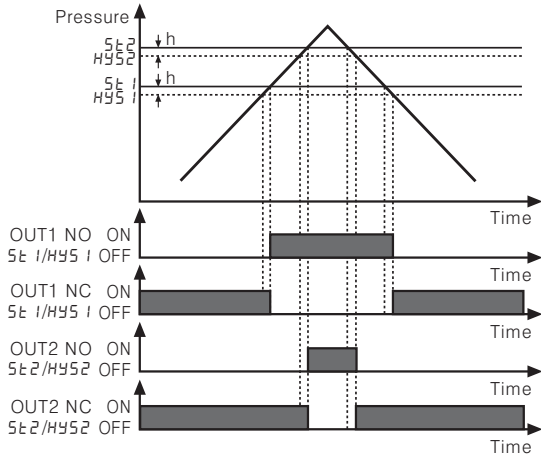

3. Hysteresis-window comparison output mode(HY-ψ)

- It is available to set hysteresis mode and window comparison output mode when both hysteresis mode(5t1, HY51) and window comparison output mode(Loψ, HIψH) are necessary.
- Detection hysteresis is fixed to min. display range.

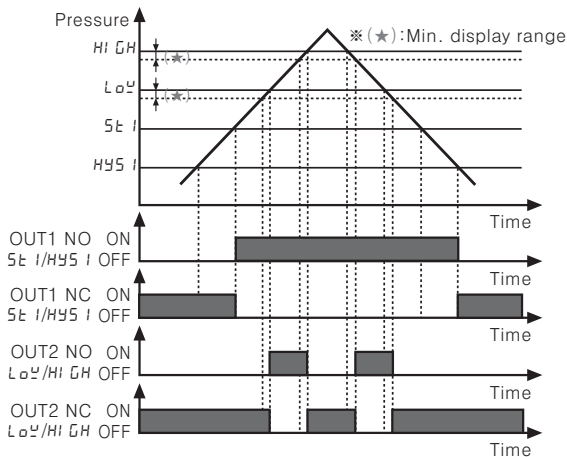

5. Forced output control mode(FoUt)

- Used to display pressure with forcibly holding comparing output OFF regardless of setting value.
- Output 1, 2 can be ON/OFF manually by pressing , key while the forced output control mode is applied.

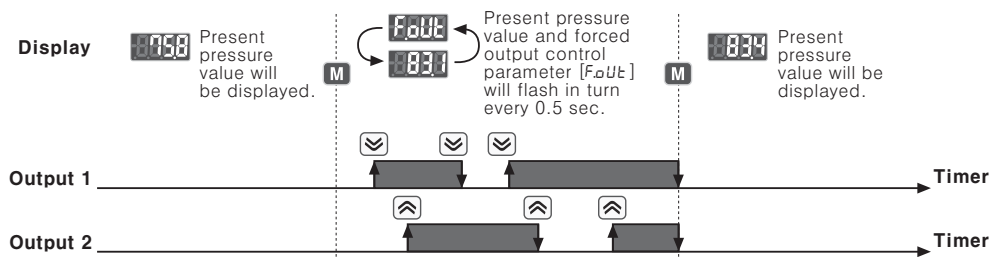

2. Window comparison output mode(ψ n)

- It is able to set the range for high(HI-1, HI-2), low(Lo-1, Lo-2) limit of pressure detection level when it is required to detect pressure at a certain range.
- Detection hysteresis is fixed to min. display range.

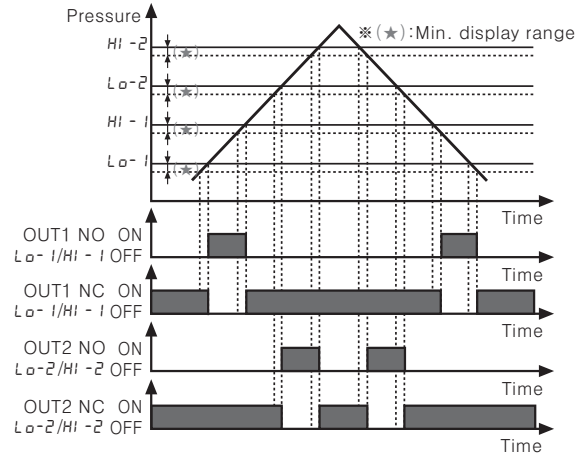

4. Automatic sensitivity setting mode(AUt)

- This function is to set pressure detection level to the proper position automatically. It is set by applied pressure from two positions(5t1, 5t2).
- Detection hysteresis is fixed to min. display range.
- The pressure detection level is shown in the following calculation.

$$SET = \frac{(5t1 + 5t2)}{2}$$

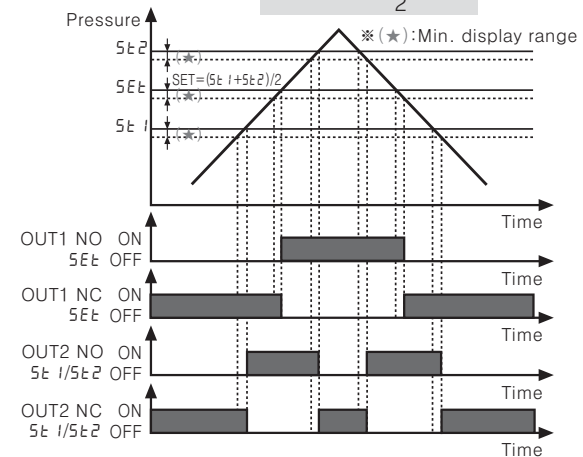

(A)	Photo electric sensor
(B)	Fiber optic sensor
(C)	Door/Area sensor
(D)	Proximity sensor
(E)	Pressure sensor
(F)	Rotary encoder
(G)	Connector/Socket
(H)	Temp. controller
(I)	SSR/Power controller
(J)	Counter
(K)	Timer
(L)	Panel meter
(M)	Tacho/Speed/Pulse meter
(N)	Display unit
(O)	Sensor controller
(P)	Switching power supply
(Q)	Stepping motor & Driver & Controller
(R)	Graphic/Logic panel
(S)	Field network device
(T)	Production stoppage models & replacement

■ Functions

◎ Pressure unit change function

PSAN-V01C(P) and PSAN-C01C(P) has 7 kinds of pressure unit, PSAN-01C(P) and PSAN-1C(P) has 4 kinds of pressure unit. Please select the proper unit for application.

- PSAN-V01C(P), PSAN-C01C(P) : kPa, kgf/cm², bar, psi, mmHg, inHg, mmH₂O
 - PSAN-01C(P), PSAN-1C(P) : kPa, kgf/cm², bar, psi
- ※ When using mmH₂O unit, multiply display value by 100.

◎ Output mode change function

There are 5 kinds of control output mode in order to realize the various pressure detection.

- Hysteresis mode (**HYS**) : When needed to change hysteresis for detecting pressure.
- Window comparison output mode (**WIN**) : When needed to detect pressure in certain area.
- Hysteresis - Window comparison output mode (**HY-W**) : When both hysteresis mode and window comparison output mode are required.
- Automatic sensitivity setting mode (**AUTO**) : When needed to set detection sensitivity automatically at proper position.
- Forced output control mode (**FOUR**) : When needed to display pressure with remaining comparison output OFF regardless of setting value.

◎ Control output change function

Type of control output for Out1 and Out2 is able to set Normal Open or Normal Close.

※ Note that Normal Open and Normal Close provide opposite output.

OUT1 output	OUT2 output	Parameter setting value
Normal Open	Normal Open	[1020]
Normal Open	Normal Close	[1021]
Normal Close	Normal Open	[1120]
Normal Close	Normal Close	[1121]

◎ Response time change function (Chattering prevention)

It can prevent chattering of control output by changing response time. It is able to set 5 kinds of response time (2.5ms, 5ms, 100ms, 500ms, 1000ms) and if the response time is getting longer, the detection will be more stable by increasing the number.

◎ Analog output scale setting function

- Analog voltage output scale setting : The scale function for analog output voltage (1-5VDC) is not fixed to the rated pressure range. It can be changed for User's application. Analog output voltage range will be fixed to 1-5VDC within the pressure range from pressure point of 1VDC output (**A-1V**) to pressure point of 5VDC output (**A-5V**).
- Analog current output scale setting : The scale for analog output Current (4-20mADC) is not fixed to the rated pressure range. It can be changed for User's application. Analog output voltage will be fixed to 4-20mA within the rated pressure range from pressure point of 4mA output (**A-04**) to pressure point of 20mA output (**A-20**).

◎ Hold/Auto shift input setting function

- Hold function: A function to hold present pressure value and control output at the time of hold signal input.

※ Present pressure value and Hold message will flash in turn every 0.5 sec. while Hold function is set. Make sure that Hold function is not able to execute while forced output mode is executed.

► Control output timing chart

EX) When Hold signal is applied in Hysteresis mode, refer to Control output diagram for hold signal input.

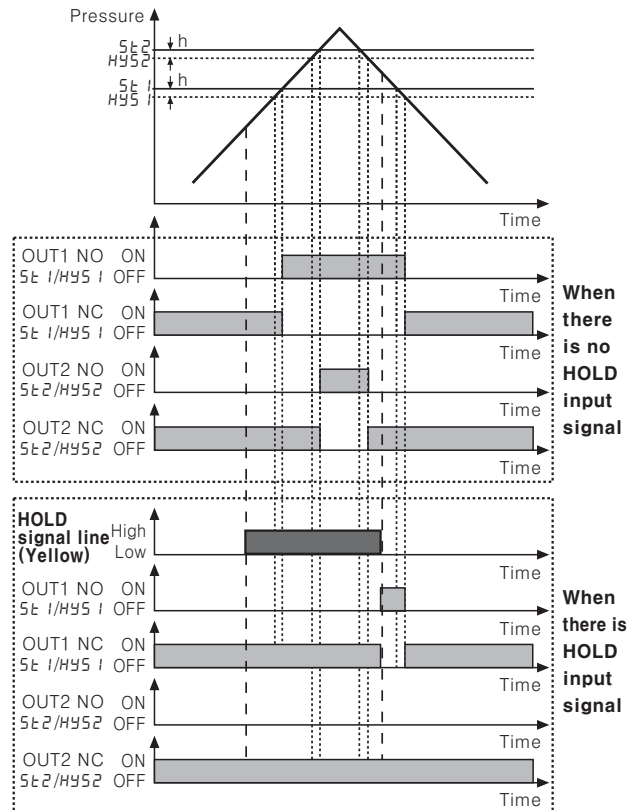

※ [Hold] and present pressure value will flash in turn every 0.5 sec. while Hold signal is applied.

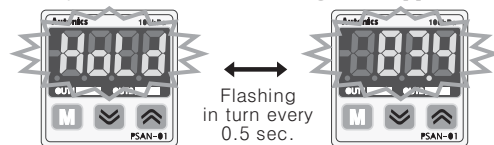

- Auto shift function: A function to use the measured pressure at the moment of auto shift input as a reference pressure in order to correct the set point values of control output when initial pressure changes.

※ Reference pressure is fixed to atmospheric pressure (0.0kPa) when Auto shift function is not used.

※ SHI n (Auto shift compensation value) will be reset to 0 when changing control output or preset values.

※ Auto shift function will not be executed if "HHHH" or "LLLL" error occurs or if forced output mode is set.

[SHI] : Reference pressure change through setting.

[OUT 1] : Changed reference will be applied to control output 1 only.

[OUT 2] : Changed reference will be applied to control output 2 only.

[ALL] : Changed reference will be applied to both control output 1 and control output 2.

Pressure Sensor

▶ When Auto shift function is used

When Auto shift input signal remains at low level more than 1ms, the measured pressure at this point will be saved as a reference value to make correct judgment regardless of pressure changes. Corrected preset pressure value will be applied after 7.5ms. Measured reference pressure value will be saved in [5H:n].

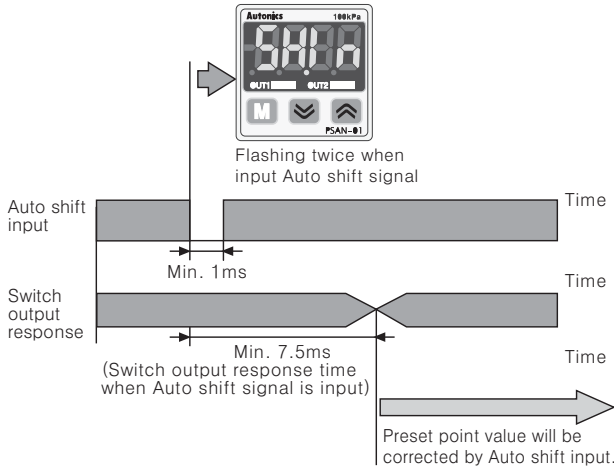

※ When Auto shift function is used, the possible set pressure range will be wider than rated set pressure range.

※ The possible set pressure range for Auto shift type models.

Pressure type	Set pressure range	Possible set pressure range for Auto shift type models
Vacuum pressure	-101.3kPa to 5.0kPa	-101.3kPa to 101.3kPa
Standard pressure	-5.0kPa to 110.0kPa	-110.0kPa to 110.0kPa
	-50.0kPa to 1100kPa	-1100kPa to 1100kPa
Compound pressure	-101.3kPa to 110.0kPa	-101.3kPa to 110.0kPa

※ If the set point value corrected by auto shift input exceeds set pressure range, an error message will flash three times and corrected value is not saved.

→ [-HH-] displayed when the set point value corrected by Auto shift input is above the upper limit of set pressure range.

→ [-LLL-] displayed when the set point value corrected by Auto shift input is below the lower limit of set pressure range.

※ The correction value will be saved in EEPROM.

▶ Example of Auto shift function

< When Auto shift is not used >

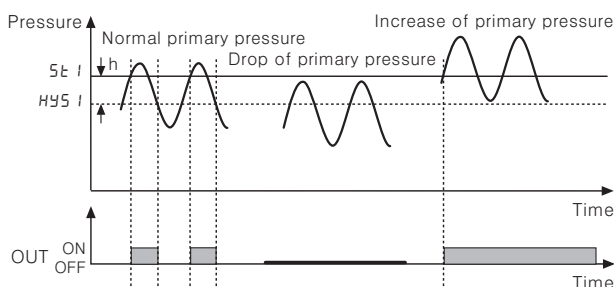

< When Auto shift is used >

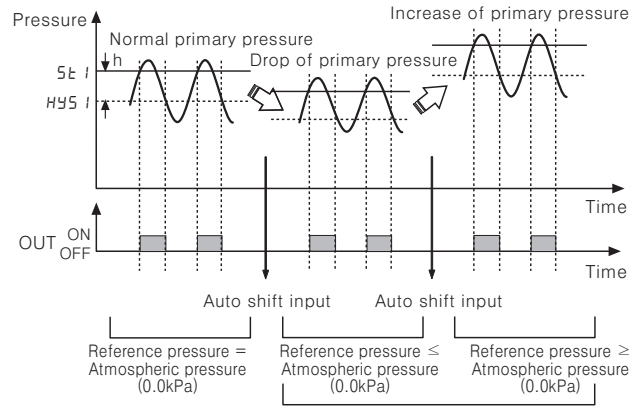

Correction set value: [5t i]' = [5t i] + [5H:n]
 Correction set value: [HYS i]' = [HYS i] + [5H:n]
 ※ [5H:n] is the reference pressure set by Auto shift input.

◎ Key lock function

The key lock function prevents key operations so that conditions set in each mode.

- **LoL1** : All keys are locked; therefore it is not available to change parameter settings, preset value, zero adjustment, High/Low peak check, and 5H:n data initialization. (Lock setting change is available)
- **LoL2** : Partially locked status; therefore it is not available to change parameter settings only (Lock setting change is available). Other settings are still available.
- **oFF** : All of the setting is available, all keys are unlocked.

◎ Zero-point adjustment function

The zero-point adjustment function forcibly sets the pressure value to "zero" when the pressure port is opened to atmospheric pressure. When the zero adjustment is applied, analog output [Voltage or Current] is changed by this function.

(Press + keys over 1 sec. in RUN mode.)

◎ High Peak / Low Peak Hold function

This function is to diagnosis malfunction of the system caused by parasitic pressure or to check through memorizing the max./min. pressure occurred from the system.

◎ Error display function

Error display	Description	Troubleshooting
Err1	When external pressure is input while adjusting zero point	Try again after removing external pressure
Err2	When overload is applied on control output	Remove overload
Err3	When setting condition is not met in Auto sensitivity setting mode	Check setting conditions and set proper setting values
LLLL	When applied pressure exceeds Low-limit of display pressure range	Apply pressure within display pressure range
HHHH	When applied pressure exceeds High-limit of display pressure range	
-HH- -LL- -HL-	Auto shift correction error	Set the corrected setting value within setting pressure range.

- (A) Photo electric sensor
- (B) Fiber optic sensor
- (C) Door/Area sensor
- (D) Proximity sensor
- (E) Pressure sensor
- (F) Rotary encoder
- (G) Connector/Socket
- (H) Temp. controller
- (I) SSR/Power controller
- (J) Counter
- (K) Timer
- (L) Panel meter
- (M) Tacho/Speed/Pulse meter
- (N) Display unit
- (O) Sensor controller
- (P) Switching power supply
- (Q) Stepping motor & Driver & Controller
- (R) Graphic/Logic panel
- (S) Field network device
- (T) Production stoppage models & replacement

PSAN Series

■ Installation

1. Pressure port is divided as basic and option specification. Therefore, be sure that to use commercially available one touch fitting. (Standard: R(PT) 1/8", Option: NPT1/8", 7/16" – 20 UNF)
2. Please connect it by using spanner (12mm, 17mm) at the metal part in order not to overload on the body when connecting one touch fitting.
3. Two different fixing brackets are provided for PSAN model. Select proper one with considering your application environments.
4. At first, please unscrew hexagon wrench bolt and assemble the bracket on this unit by fixing hexagon wrench bolt.

In this case, tightening torque of hexagon wrench should be max. 3kgf · cm. If not, it may cause mechanical problem.

⚠ Caution

The tightening torque of one touch fitting should be max. 100kgf · cm. If not, it may cause mechanical problem.

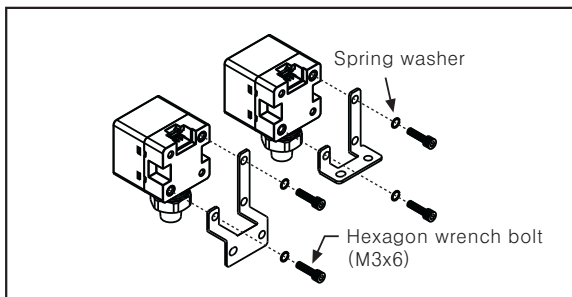
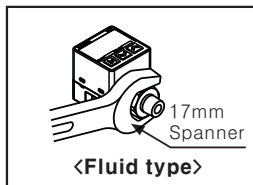
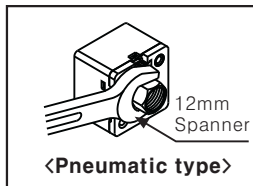

5. Bracket (PSO-B02) and front protection cover (PSO-P01) are sold separately. Please see the pictures for installation.

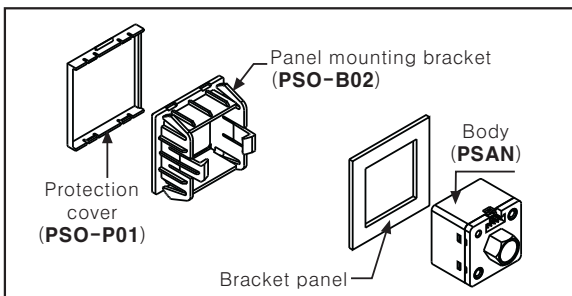

■ Proper usage

⚠ Caution

PSAN Series is for sensing of non corrosive gas. Do not use this product at corrosive gas or flammable gas, etc.

- Please using this unit within the range of specification, if applying pressure is larger than specification, it may not be working properly due to damage.
- After supplying power, it takes 3 sec. to work.
- When using switching regulator as power supply, it must be grounded (F.G.).

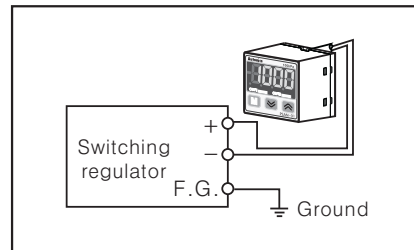

- It may cause malfunction by noise, when wiring with power line or high voltage line.
- Do not insert any sharp or pointed object into pressure port. It may cause mechanical problem due to sensor damage.
- Do not use this unit with flammable gas, because this is not an explosion proof structure.
- Be sure that this unit should not be contacted directly with water, oil, thinner, etc.

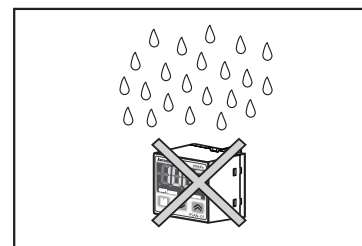

- Wiring must be done with power off.

X-ON Electronics

Largest Supplier of Electrical and Electronic Components

Click to view similar products for [Autonics](#) manufacturer:

Other Similar products are found below :

[MT4W-DV-4N](#) [CR30-15AO](#) [E40S6-2500-6-L-5](#) [LP-S070-T9D6-C5T](#) [PRFT30-10DO-V](#) [PRFWT12-2DO-IV](#) [PRFWT30-10DO-IV](#) [TC4W-24R](#) [TK4H-14CC](#) [TX4S-B4C](#) [TX4S-B4S](#) [CR30-15AC](#) [PRD12-8DN](#) [TMHA-42AE](#) [TMHE-82RE](#) [CX6M-1P2](#) [PRFAT12-2DO-V](#) [PRFAWT12-2DO-IV](#) [PT4-S3DP5](#) [PT8-S3DP5](#) [SRH2-4440](#) [SRH3-4430](#) [SRHL1-4220](#) [TF33-31H-R](#) [E50S8-360-3-T-24](#) [BTF30-DDTL-P](#) [PR08-1.5DP2](#) [PRL30-10DP](#) [AT8PSN-6 100/120VAC](#) [CT6S-2P4](#) [BJ15M-TDT-P](#) [E40H12-1000-6-L-5](#) [PRCM12-2DN](#) [PRDCM12-4DN](#) [PRDCM18-14DN](#) [PRDCM18-7DN](#) [PRDCM30-25DN](#) [PRDCML12-8DN](#) [PRDCML18-7DP](#) [PRDCML30-25DN](#) [SR1-4425](#) [SR3-2450](#) [TK4H-14SC](#) [TK4H-14SR](#) [TK4M-14RN](#) [TK4N-14RC](#) [TX4S-A4S](#) [PR08-1.5DP](#) [PR18-5AO](#) [SR3-1440R](#)