

## PX2 Series

### Heavy Duty Pressure Transducer



#### DESCRIPTION

Honeywell's PX2 Series Heavy Duty Pressure Transducer is a line of highly configurable pressure transducers that use piezoresistive sensing technology with ASIC (Application Specific Integrated Circuit) signal conditioning in a stainless steel housing that is compatible with a variety of harsh media.

The PX2 Series is fully calibrated and compensated for transducer offset, sensitivity, temperature effects and non-linearity using an on-board ASIC. This provides a Total Error Band of  $\pm 2\%$  over the operation temperature range of  $-40\text{ }^{\circ}\text{C}$  to  $125\text{ }^{\circ}\text{C}$  [ $-40\text{ }^{\circ}\text{F}$  to  $257\text{ }^{\circ}\text{F}$ ].

With thousands of possible configurations, the PX2 Series allows Honeywell to meet customer requirements and quickly provide samples. New standard configurations are regularly being added to the series.

#### VALUE PROPOSITIONS(★=competitive differentiator)

- ★ **Designed for configurability:** Numerous standard or custom connectors, ports, pressure types and ranges, and output options:
  - Allows customers the ability to configure devices to meet their specific application needs
  - Allows for quick availability of product samples
- ★ **Cost-effective:** The PX2 Series' configurability makes it a cost-effective solution; by configuring the transducer to meet the system's needs, the PX2 Series reduces the design and implementation costs of the end product
- ★ **Application expertise:** Honeywell's knowledgeable application engineers are available to answer customers' specific design questions during the development, launch, and production of their product
- **Global support:** Honeywell's global presence offers customers immediate product and application support; this allows Honeywell to support the customer throughout the development cycle from design to global manufacturing

The PX2 Series is compatible with a variety of harsh media including brake fluid, refrigerants, engine oil, tap water, hydraulic fluids, and compressed air. The wide operating temperature range, up to IP69K protection, and CE compliance allow compatibility for reliable performance in tough environments.

These transducers measure absolute or sealed gage pressure. The absolute versions have an internal vacuum reference and an output value proportional to absolute pressure. The sealed gage versions have an internal pressure reference of one atmosphere at sea level.

Honeywell's PX2 transducer is available in 7 bar to 46 bar [100 psi to 667 psi] pressure ranges with additional pressure ranges coming soon. All products are designed and manufactured according to ISO 9001 standards.

- **Industry-leading Total Error Band (TEB):** Honeywell specifies TEB—the most comprehensive, clear, and meaningful measurement—that provides the transducer's true accuracy over a compensated temperature range of  $-40\text{ }^{\circ}\text{C}$  to  $125\text{ }^{\circ}\text{C}$  [ $-40\text{ }^{\circ}\text{F}$  to  $257\text{ }^{\circ}\text{F}$ ]. The PX2 Series TEB of  $\pm 2\%$ :
  - Provides excellent transducers interchangeability due to minimal part-to-part variation in accuracy
  - Eliminates the customers' need for individual transducer testing and calibration
  - Supports system accuracy and warranty requirements
- **Durable:** Compatibility with a wide variety of harsh media (brake fluid, refrigerants, engine oil, tap water, hydraulic fluids, and compressed air), wide operating temperature range, up to IP69K sealing, and CE compliance allow for use in tough environments
- ★ **Designed to Six Sigma standards:** Provides the highest level of product quality, performance, and consistency; Six Sigma provides confidence that the transducer will perform to specification
- ★ **Energy efficient:** The PX2 Series AC and AD output transfer functions offer a 3.3 V ratiometric output with a  $< 7\text{ ms}$  turn on time enabling the PX2 Series to be used when energy efficiency is a key requirement

# PX2 Series

## FEATURES AND BENEFITS

- **Broad compensated temperature range** allows customers to design the same transducer into a broad set of applications
- **Good EMC protection** means that the transducer will not be damaged by environmental electromagnetic interference

## POTENTIAL APPLICATIONS

### Industrial:

- **HVAC/R**
  - Compressor inlet and outlet pressure
  - Rooftop chillers
  - Compressor rack rooms
  - Refrigerant recovery systems
  - Compressor oil pressure
- **Air Compressors**
  - Compressor inlet and outlet pressure
  - Filter pressure drop
  - Cooling water inlet and outlet pressure
  - Compressor oil pressure

### General

- System pressure
- Fluid power, flow and level
- Factory automation
- Pneumatics
- Injection molding knock-out valves
- Pumps
- Valves
- Packaging/laminating equipment
- Sprayers, industrial lasers
- Foam dispensing
- Solar energy
- Emissions monitoring

### Transportation (Heavy Equipment and Alternative Fuel Vehicles):

- System pressure
- Fluid power, flow and level
- Pneumatics
- Light hydraulics
- Brake and engine oil pressure
- Transmission
- Truck/trailer air braking

Table 1. Electrical Specifications

Characteristic	Ratiometric				Current Output	Regulated Output				
	Output Transfer Function Order Code (See Figure 5.)									
	AA	AB	AC	AD	CH	BC	BD	BE	BG	
Output transfer function <sup>1</sup> :										
null output value	10% of Vs	5% of Vs	10% of Vs	5 %of Vs	4 mA	1 V	0.25 V	0.5 V	1 V	
full scale output value	90% of Vs	95% of Vs	90% of Vs	95% of Vs	20 mA	6 V	10.25 V	4.5 V	5 V	
full scale span (FSS) <sup>15</sup>	80% of Vs	90% of Vs	80% of Vs	90% of Vs	16 mA	5 V	10 V	4 V	4 V	
operating supply voltage, min. (Vs) <sup>2</sup>	4.75 V	4.5 V	3.135 V	3.135 V	8 V	9 V	13 V	8 V	8 V	
operating supply voltage, typ. (Vs) <sup>2</sup>	5 V	5 V	3.3 V	3.3 V	–	–	–	–	–	
operating supply voltage, max. (Vs) <sup>2</sup>	5.25 V	5.5 V	3.465 V	3.465 V	30 V <sup>4</sup>	30 V	30 V <sup>3</sup>	30 V <sup>3</sup>	30 V <sup>3</sup>	
Supply current (typ.)	5 mA				–	5.5 mA				
Output load (pull up or down)										
minimum	2 kOhm				–	2 kOhm				
maximum	–				(Vs - 8) x 50 Ohm <sup>4</sup>	–				
Absolute voltage ratings <sup>5</sup> :										
minimum <sup>6</sup>	-16 V				-16 V	-16 V				
maximum <sup>6</sup>	16 V				30 V	30 V				
maximum applied to output pin	Vs				–	Vs				
EMC rating – CE compliance <sup>7</sup> :										
electrostatic discharge	±4 kV contact, ±8 kV air per IEC 61000-4-2									
radiated immunity	10 V/m (80 MHz to 1000 MHz) per IEC 61000-4-3									
fast transient burst	±1 kV per IEC61000-4-4									
immunity to conducted disturbances	3 V per IEC61000-4-6									
radiated emissions	40 dB 30 MHz to 230 MHz; 47 dB 230 MHz to 1000 MHz per CISPR 11									
EMC Rating – ISO 11452-2 <sup>7</sup>										
radiated immunity	100 V/m 200 MHz to 2 GHz					20 V/m 200 MHz to 2 GHz				

### Notes:

1. Transfer function options are shown in the Nomenclature and Order Guide. (See Figure 5.)
2. Transducer will not produce valid output when supply voltage is outside of operating range.
3. Applies at 25 °C. See Figure 1 for Regulated Output Supply Voltage.
4. Applies at 25 °C. See Figure 2 for Current Output Supply Voltage.
5. Absolute maximum ratings are the extreme limits the device can withstand without damage to the product. Voltages above these ratings may cause permanent damage. Exposure to absolute maximum conditions for extended periods may degrade device reliability.
6. Absolute voltage applies to potential across power and ground terminals.
7. All EMC ratings verified with the Packard Metripak 150 connector type.

# Heavy Duty Pressure Transducer

Figure 1. Regulated Output Supply Voltage

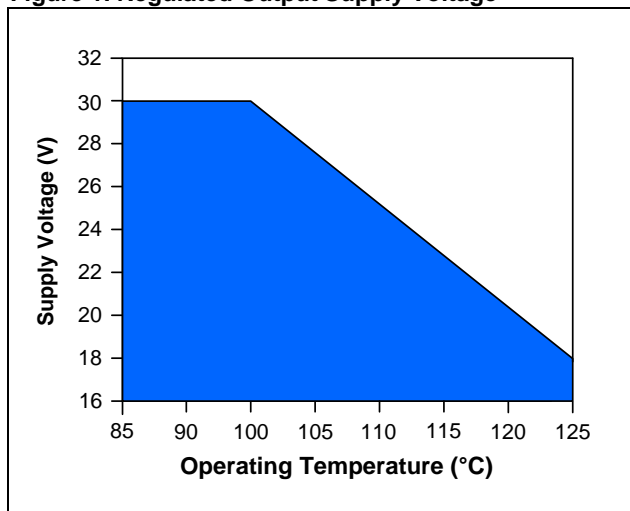

Figure 2. Current Output Supply Voltage

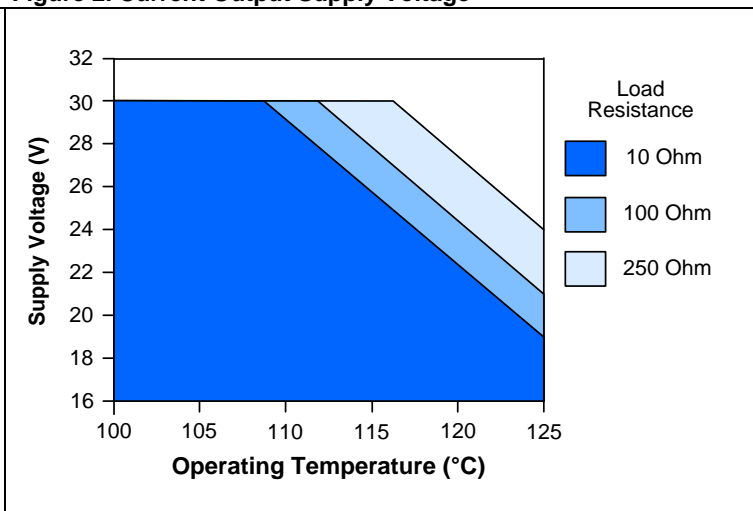

Table 2. Performance Specifications<sup>8</sup>

Parameter	Description
Operating temperature range <sup>9</sup>	-40 °C to 125 °C [-40 °F to 257 °F]
Storage temperature range <sup>10</sup>	-40 °C to 125 °C [-40 °F to 257 °F]
Compensated temperature range <sup>11</sup>	-40 °C to 125 °C [-40 °F to 257 °F]
Overpressure minimum rating <sup>12</sup>	(See Figure 3.)
Burst pressure minimum rating <sup>13</sup>	(See Figure 3.)
Long term stability	±0.5 %FSS <sup>15</sup> (1000 hr at 25 °C [77 °F])
Accuracy <sup>14</sup>	±0.25 %FSS <sup>15</sup> (See Figure 4.)
Offset error <sup>16</sup>	±1 %FSS <sup>15</sup>
Total Error Band <sup>17</sup>	±2 %FSS <sup>15</sup> (-40 °C to 125 °C [-40°F to 257 °F]) (See Figure 4.)
Response time <sup>18</sup>	<2 ms
Turn on time <sup>19</sup>	<7 ms
Life <sup>20</sup>	min. of 10 million cycles to operating pressure

**Notes:**

8. All specifications apply at 25 °C and under operating conditions unless otherwise noted.
9. Operating Temperature Range: The temperature range over which the product will produce an output proportional to pressure but may not remain within the specified performance limits.
10. Storage Temperature Range: The temperature range over which the product may safely be exposed without excitation or pressure applied. Under these conditions the product will remain in specification after excursion to any temperatures within this range. Exposure to temperatures outside this range may cause permanent damage to the product.
11. Compensated Temperature Range: The temperature range (or ranges) over which the product will produce an output proportional to pressure within the specified performance limits.
12. Overpressure: The absolute maximum rating for pressure which may be safely applied to the product for it to remain in specification once pressure is returned to the operating pressure range. Exposure to higher pressure may cause permanent damage to the product.
13. Burst Pressure: The maximum pressure that may be applied to the product without causing escape of the pressure media. The product should not be expected to function after exposure to any pressure beyond the rated burst pressure. This rating is also the case burst rating of the product.
14. Accuracy: The maximum deviation in output from a Best Fit Straight Line (BFSL) fitted to the output measured over the pressure range at 25 °C. Includes all errors due to pressure non-linearity, pressure hysteresis, and non-repeatability.
15. Full Scale Span (FSS): The algebraic difference between the output signal measured at the maximum (Pmax.) and minimum (Pmin.) limits of the pressure range.
16. Offset Error: the maximum deviation in the output signal obtained when the reference pressure is applied at 25 °C relative to the ideal transfer function.
17. Total Error Band: The maximum deviation from the ideal transfer function over the entire compensated temperature and pressure range. Includes all errors due to offset, full scale span, pressure non-linearity, pressure hysteresis, repeatability, thermal effect on offset, thermal effect on span, and thermal hysteresis.
18. Response Time: The response time of the transducer is the maximum amount of time that the transducer will take for the transducer to output a change from 10% to 90% of full scale in response to a 0% to 100% full scale step input pressure range.
19. Turn On Time: Duration from power applied until first valid output.
20. Life may vary depending on the application in which transducer is used. Contact Honeywell Sales and Service for Mean Time to Failure (MTTF) data based on customer-specific usage profile.

# PX2 Series

Figure 3. Pressure Rating Curve

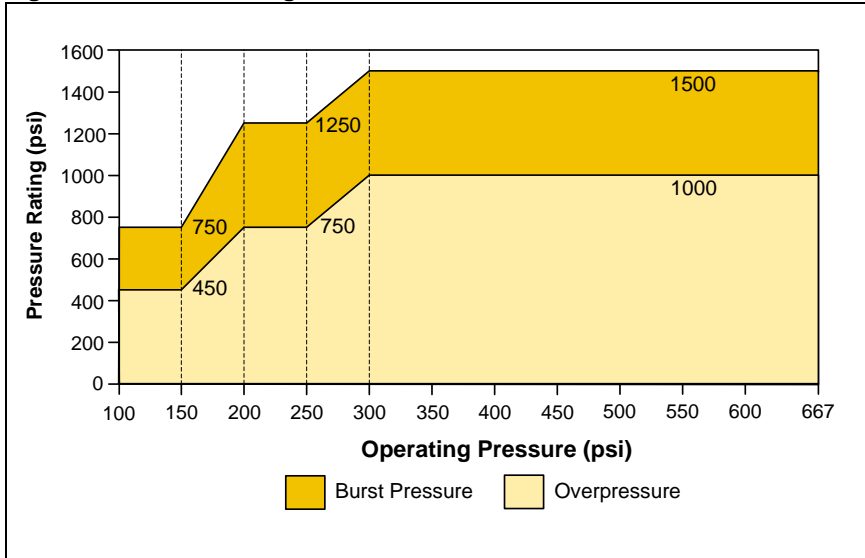

Figure 4. Total Error Band

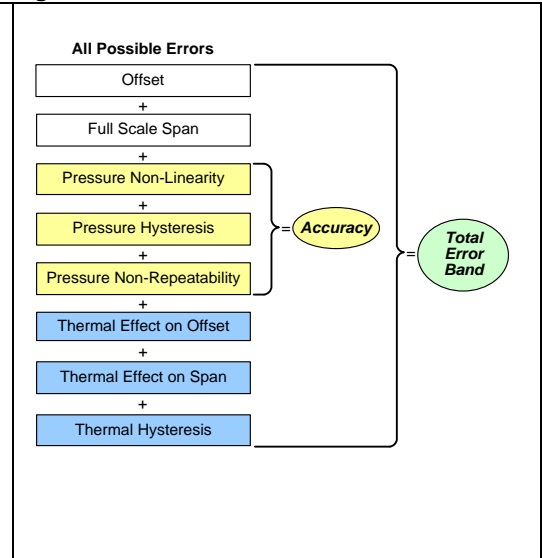

Table 3. Pressure Types

Pressure Reference	Description
Absolute	Output is proportional to the difference between applied pressure and a built-in fixed reference to vacuum (zero pressure), where the minimum operating pressure is set to absolute zero pressure (perfect vacuum)
Sealed Gage	Output is proportional to the difference between applied pressure and a built-in fixed reference to 1 atmsA, where the minimum operating pressure is set to 14.7 psiA (1 atmsA)

Table 4. Mechanical Characteristics

Characteristic	Parameter
Mechanical shock	100 G per MIL-STD-202F, Method 213B, Cond. F
Vibration	20 G sweep, 10 Hz to 2000 Hz
Enclosure rating	per electrical connector selection (See Figure 6.)
Wetted materials: port substrate adhesives electronics	304 stainless steel alumina ceramic epoxy glass, silicon
External materials: housing connector cable jacket	304 stainless steel PBT 30% GF TPE
Installation torque	per port type (See Figure 7.)

# Heavy Duty Pressure Transducer

Figure 5. Nomenclature and Order Guide<sup>1</sup>

For example, **PX2AN1XX010BAAAX** defines a PX2 Series heavy duty pressure transducer with a Packard Metripak 150 connector type, 1/4-18 NPT port type, 10 bar pressure range, absolute pressure reference, and 5.0 V ratiometric output (10 %VS to 90 %Vs).

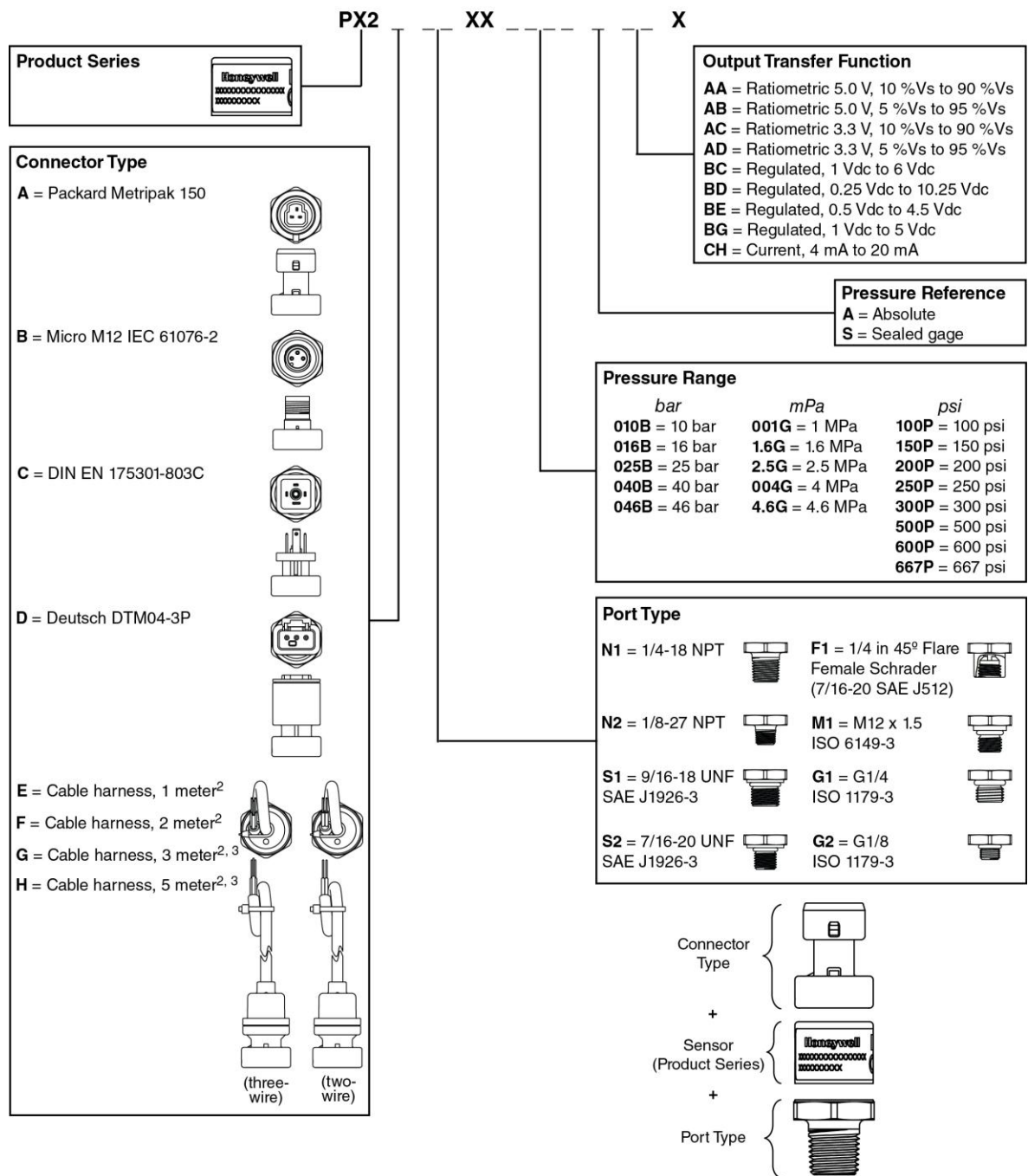









































**Notes:**

1. Not all catalog listing combinations are available; custom products are available. Please contact your Honeywell provider/representative for assistance.
2. Three-wire cable is required for ratiometric and regulated outputs; two wire cable is required for current output.
3. Three meter and five meter cables are only available with Output Transfer Function **CH** = Current, 4 mA to 20 mA.

# PX2 Series

Figure 6. All Available Standard Configurations

Connector Type	Port Type							
	1/4-18 NPT	1/8-27 NPT	9/16-18 UNF SAE J1926-3	7/16-20 UNF SAE J1926-3	1/4 in 45° Flare Female Schrader (7/16-20 SAE J512)	M12 X 1.5 ISO 6149-3	G1/4 ISO 1179-3	G1/8 ISO 1179-3
Packard Metripak 150								
Micro M12 IEC 61076-2								
DIN EN 175301-803C								
Deutsch DTM04-3P								
Cable Harness:  1 Meter 2 Meter 3 Meter 5 Meter								

# Heavy Duty Pressure Transducer

Figure 7. Connector Dimensions (For reference only: mm/[in.] )

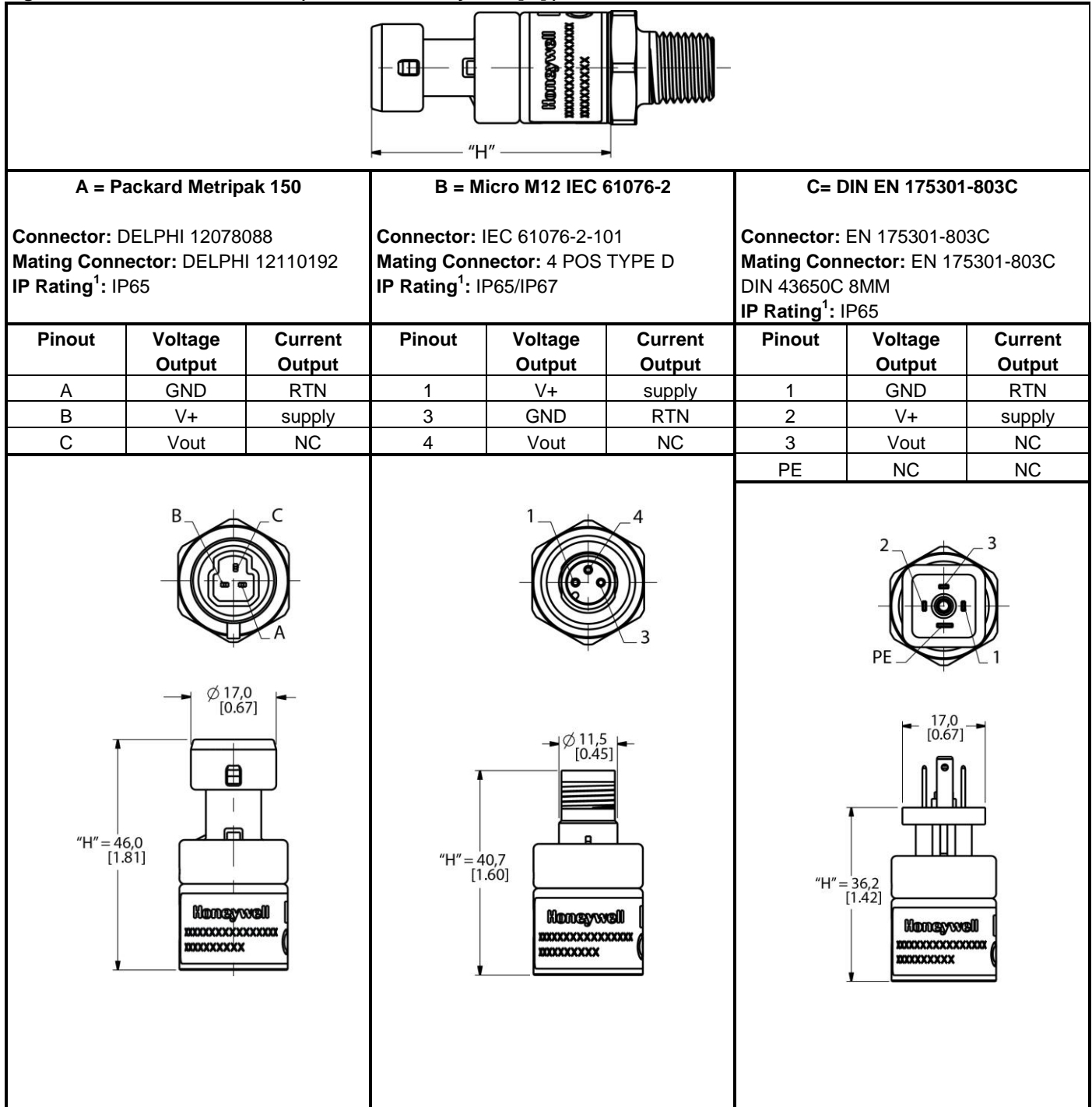

**Note:**

1. IP rating is determined by the electrical connection chosen.

# PX2 Series

Figure 7. Connector Dimensions (For reference only: mm/[in], continued.)

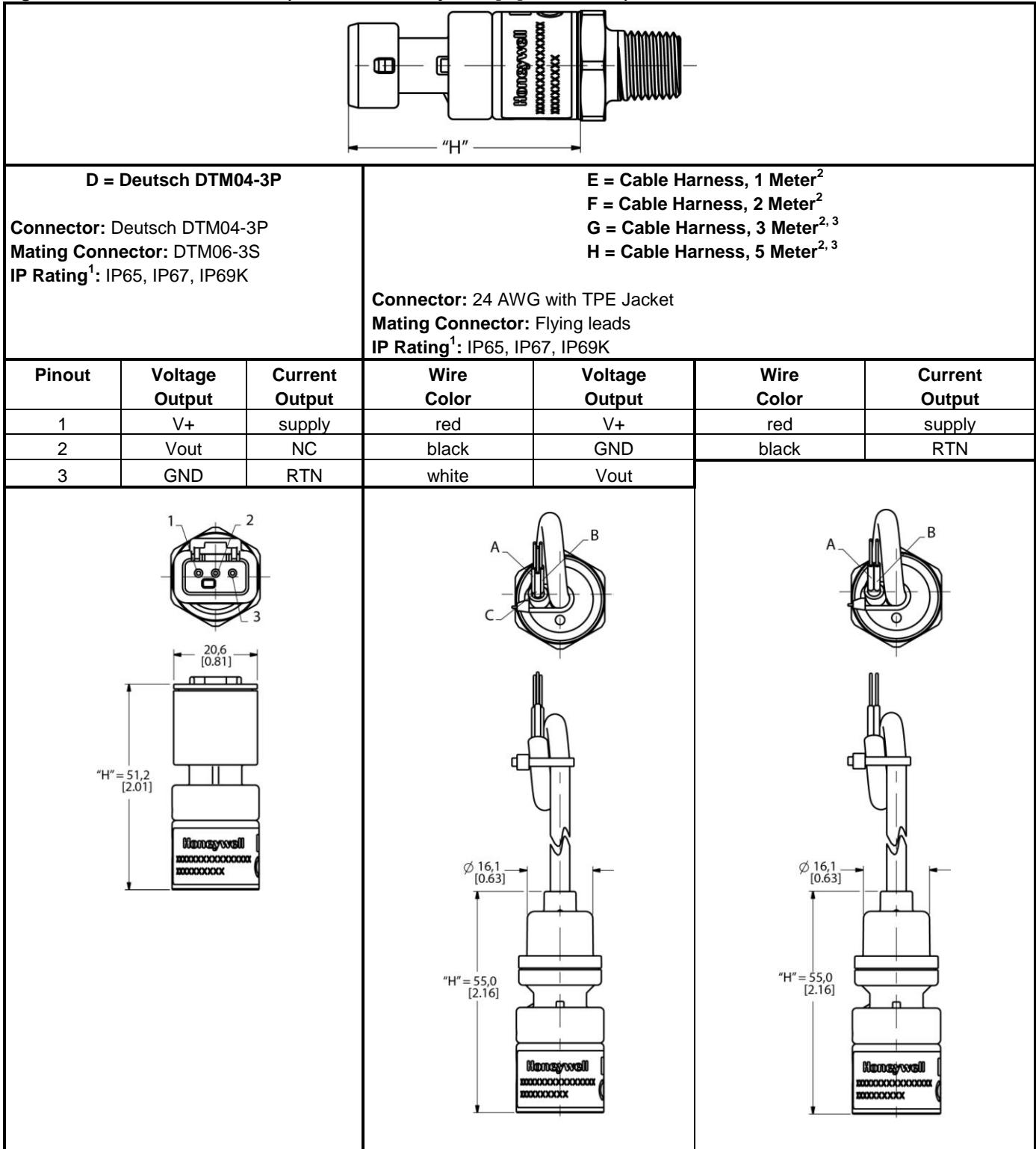



# Heavy Duty Pressure Transducer

## CAUTION

### PRODUCT DAMAGE

- Ensure torque specifications are determined for the specific application. Values provided are for reference only. NPT ports are not specified with torque values. Correct installation is based on the number of Turns From Finger Tight (TFFT). (Mating materials and thread sealants can result in significantly different torque values from one application to the next.)
- When using NPT ports in stainless steel manifolds, use a thread sealant with anti-seize properties to prevent thread galling. Ensure the sealant is rated for the application.
- Use appropriate tools (such as an open ended wrench or deep well socket) to install transducers.
- Always hand-start transducers into the hole to prevent cross threading and damage

**Failure to comply with these instructions may result in product damage.**

Figure 8. Port Dimensions (For reference only: mm/[in])

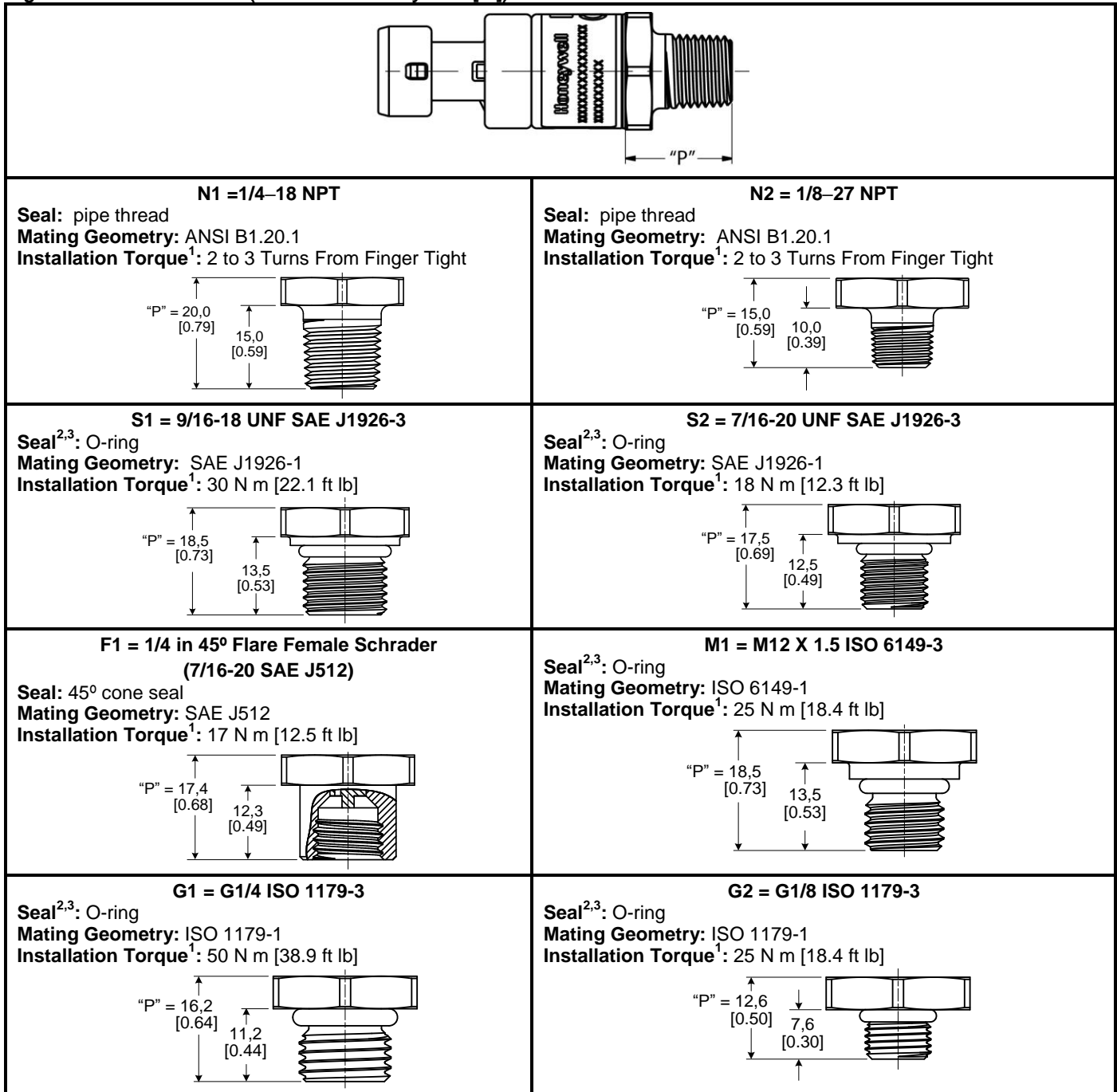

### Notes:

1. Straight thread maximum torque is validated to 150% of installation torque.
2. Seals for port order codes **S1**, **S2**, **M1**, **G1** and **G2** are included assembled to the sensor.
3. O-ring material is nitrile 90 durometer -30 °C to 125 °C [-22 °F to 257 °F].

## **WARNING**

### **MISUSE OF DOCUMENTATION**

- The information presented in this product sheet is for reference only. Do not use this document as a product installation guide.
- Complete installation, operation, and maintenance information is provided in the instructions supplied with each product.

**Failure to comply with these instructions could result in death or serious injury.**

### **WARRANTY/REMEDY**

Honeywell warrants goods of its manufacture as being free of defective materials and faulty workmanship. Honeywell's standard product warranty applies unless agreed to otherwise by Honeywell in writing; please refer to your order acknowledgement or consult your local sales office for specific warranty details. If warranted goods are returned to Honeywell during the period of coverage, Honeywell will repair or replace, at its option, without charge those items it finds defective. **The foregoing is buyer's sole remedy and is in lieu of all other warranties, expressed or implied, including those of merchantability and fitness for a particular purpose. In no event shall Honeywell be liable for consequential, special, or indirect damages.**

While we provide application assistance personally, through our literature and the Honeywell web site, it is up to the customer to determine the suitability of the product in the application.

Specifications may change without notice. The information we supply is believed to be accurate and reliable as of this printing. However, we assume no responsibility for its use.

## **WARNING**

### **PERSONAL INJURY**

DO NOT USE these products as safety or emergency stop devices or in any other application where failure of the product could result in personal injury.

**Failure to comply with these instructions could result in death or serious injury.**

### **SALES AND SERVICE**

Honeywell serves its customers through a worldwide network of sales offices, representatives and distributors. For application assistance, current specifications, pricing or name of the nearest Authorized Distributor, contact your local sales office or:

**E-mail:** [info.sc@honeywell.com](mailto:info.sc@honeywell.com)

**Internet:** [sensing.honeywell.com](http://sensing.honeywell.com)

### **Phone and Fax:**

Asia Pacific	+65 6355-2828 +65 6445-3033 Fax
Europe	+44 (0) 1698 481481 +44 (0) 1698 481676 Fax
Latin America	+1-305-805-8188 +1-305-883-8257 Fax
USA/Canada	+1-800-537-6945 +1-815-235-6847 +1-815-235-6545 Fax

## X-ON Electronics

Largest Supplier of Electrical and Electronic Components

*Click to view similar products for [Speakers & Transducers](#) category:*

*Click to view products by [Honeywell](#) manufacturer:*

Other Similar products are found below :

[AS02016MR-2-R](#) [PB-1220PE](#) [PB-2015PQ](#) [900-00001](#) [SMT-2240-TW-2-R](#) [SWFK-31736-000](#) [PT-2065FW](#) [PT-4175W](#) [AT-2830-TW-LW35-R](#) [ED-30761-000](#) [ED-31305-163](#) [CI-30120-A42](#) [TWFK-23991-000](#) [PB-0927PQ](#) [BF-7083-000](#) [AB6505B](#) [AS01708MR-SC-2-R](#) [AT-5030-TF-2-LW100-R](#) [AST-03008MR-R](#) [AS04008PS-4W-R](#) [AS01308MR-2-R](#) [AS01808AO-WP-R](#) [AS01508MR-6-R](#) [AS07108PO-R](#) [AS07708PS-2-WR-R](#) [AS07104PO-R](#) [SMS2020-08H4.5 LF](#) [BDT1717-08H6.5W56MLF](#) [SMS-2008MS-R](#) [AS04008PS-4W-WR-R](#) [AS06608PS-WR-R](#) [BLS50-1-08H18.2B-03 LF](#) [AS03008MR-R](#) [AS04008CO-2-R](#) [AS04008PR-WR-R](#) [ASE03008MR-LW150-R](#) [AS01808MR-LW152-R](#) [AS01808MR-R](#) [AS03608MR-4-R](#) [AS06608PS-R](#) [AS07708PS-2-R](#) [ASE06008MR-LW150-R](#) [ASE02008MR-LW150-R](#) [AST-1732MR-R](#) [SMS-1508MS-2-R](#) [AS05708MR-R](#) [AS05008MR-R](#) [APS3008S-R](#) [AS02008MR-R](#) [AS07104PO-WR-R](#)