

# IRLMS1902

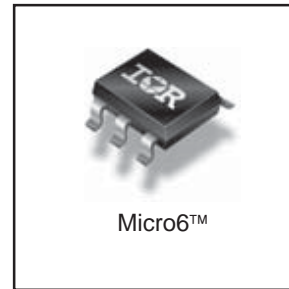
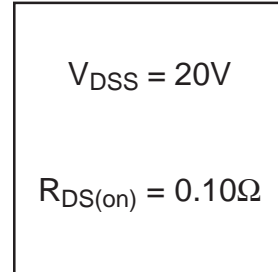
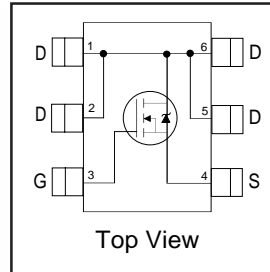
HEXFET® Power MOSFET

- Generation V Technology
- Micro6 Package Style
- Ultra Low  $R_{DS(on)}$
- N-Channel MOSFET

## Description

Fifth Generation HEXFET® power MOSFETs from International Rectifier utilize advanced processing techniques to achieve extremely low on-resistance per silicon area. This benefit, combined with the fast switching speed and ruggedized device design that HEXFET® power MOSFETs are well known for, provides the designer with an extremely efficient and reliable device for use in a wide variety of applications.

The Micro6™ package with its customized leadframe produces a HEXFET® power MOSFET with  $R_{DS(on)}$  60% less than a similar size SOT-23. This package is ideal for applications where printed circuit board space is at a premium. It's unique thermal design and  $R_{DS(on)}$  reduction enables a current-handling increase of nearly 300% compared to the SOT-23.



## Absolute Maximum Ratings

	Parameter	Max.	Units
$I_D @ T_A = 25^\circ C$	Continuous Drain Current, $V_{GS} @ 4.5V$	3.2	A
$I_D @ T_A = 70^\circ C$	Continuous Drain Current, $V_{GS} @ 4.5V$	2.6	
$I_{DM}$	Pulsed Drain Current ①	18	
$P_D @ T_A = 25^\circ C$	Power Dissipation	1.7	W
	Linear Derating Factor	13	mW/°C
$V_{GS}$	Gate-to-Source Voltage	$\pm 12$	V
dv/dt	Peak Diode Recovery dv/dt ②	5.0	V/ns
$T_J, T_{STG}$	Junction and Storage Temperature Range	-55 to + 150	°C

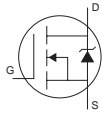
## Thermal Resistance Ratings

Parameter		Min.	Typ.	Max	Units
$R_{\theta JA}$	Maximum Junction-to-Ambient ④	—	—	75	°C/W

## Electrical Characteristics @ T<sub>J</sub> = 25°C (unless otherwise specified)

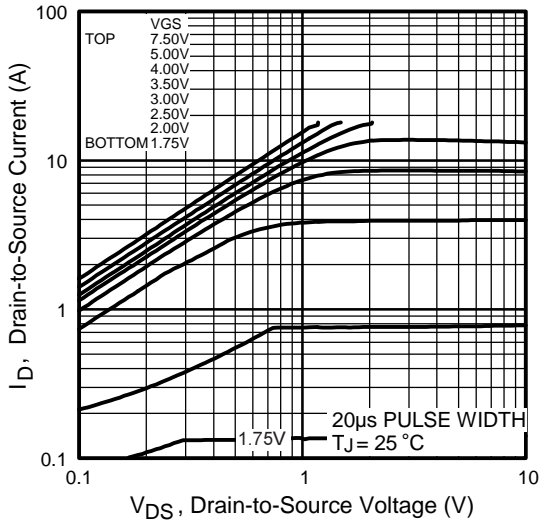
	Parameter	Min.	Typ.	Max.	Units	Conditions
V <sub>(BR)DSS</sub>	Drain-to-Source Breakdown Voltage	20	—	—	V	V <sub>GS</sub> = 0V, I <sub>D</sub> = 250μA
ΔV <sub>(BR)DSS</sub> /ΔT <sub>J</sub>	Breakdown Voltage Temp. Coefficient	—	0.032	—	V/°C	Reference to 25°C, I <sub>D</sub> = 1mA
R <sub>DS(on)</sub>	Static Drain-to-Source On-Resistance	—	—	0.10	Ω	V <sub>GS</sub> = 4.5V, I <sub>D</sub> = 2.2A ③
		—	—	0.17		V <sub>GS</sub> = 2.7V, I <sub>D</sub> = 1.1A ③
V <sub>GS(th)</sub>	Gate Threshold Voltage	0.70	—	—	V	V <sub>DS</sub> = V <sub>GS</sub> , I <sub>D</sub> = 250μA
g <sub>fs</sub>	Forward Transconductance	3.2	—	—	S	V <sub>DS</sub> = 10V, I <sub>D</sub> = 1.1A
I <sub>DSS</sub>	Drain-to-Source Leakage Current	—	—	1.0	μA	V <sub>DS</sub> = 16V, V <sub>GS</sub> = 0V
		—	—	25		V <sub>DS</sub> = 16V, V <sub>GS</sub> = 0V, T <sub>J</sub> = 125°C
I <sub>GSS</sub>	Gate-to-Source Forward Leakage	—	—	100	nA	V <sub>GS</sub> = 12V
	Gate-to-Source Reverse Leakage	—	—	-100		V <sub>GS</sub> = -12V
Q <sub>g</sub>	Total Gate Charge	—	4.7	7.0	nC	I <sub>D</sub> = 2.2A
Q <sub>gs</sub>	Gate-to-Source Charge	—	0.97	1.5		V <sub>DS</sub> = 16V
Q <sub>gd</sub>	Gate-to-Drain ("Miller") Charge	—	1.8	2.6		V <sub>GS</sub> = 4.5V, See Fig. 6 and 9 ③
t <sub>d(on)</sub>	Turn-On Delay Time	—	7.0	—	ns	V <sub>DD</sub> = 10V
t <sub>r</sub>	Rise Time	—	11	—		I <sub>D</sub> = 2.2A
t <sub>d(off)</sub>	Turn-Off Delay Time	—	12	—		R <sub>G</sub> = 6.0Ω
t <sub>f</sub>	Fall Time	—	4.0	—		R <sub>D</sub> = 4.4Ω, See Fig. 10 ③
C <sub>iss</sub>	Input Capacitance	—	300	—	pF	V <sub>GS</sub> = 0V
C <sub>oss</sub>	Output Capacitance	—	120	—		V <sub>DS</sub> = 15V
C <sub>rss</sub>	Reverse Transfer Capacitance	—	50	—		f = 1.0MHz, See Fig. 5

## Source-Drain Ratings and Characteristics

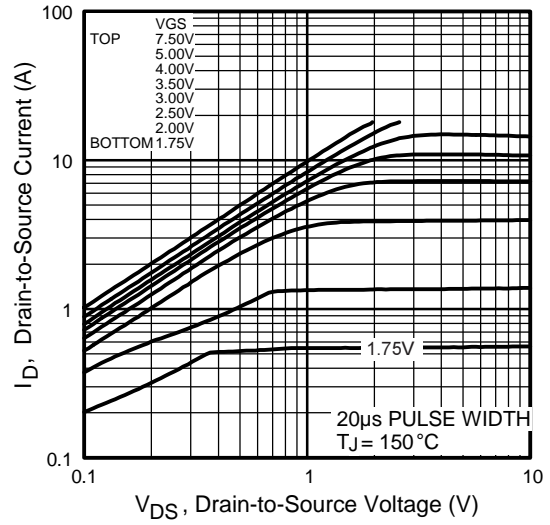
	Parameter	Min.	Typ.	Max.	Units	Conditions
I <sub>S</sub>	Continuous Source Current (Body Diode)	—	—	1.7	A	MOSFET symbol showing the integral reverse p-n junction diode. 
I <sub>SM</sub>	Pulsed Source Current (Body Diode) ①	—	—	18		
V <sub>SD</sub>	Diode Forward Voltage	—	—	1.2	V	T <sub>J</sub> = 25°C, I <sub>S</sub> = 2.2A, V <sub>GS</sub> = 0V ②
t <sub>rr</sub>	Reverse Recovery Time	—	40	60	ns	T <sub>J</sub> = 25°C, I <sub>F</sub> = 2.2A
Q <sub>rr</sub>	Reverse Recovery Charge	—	37	55	nC	di/dt = 100A/μs ②

### Notes:

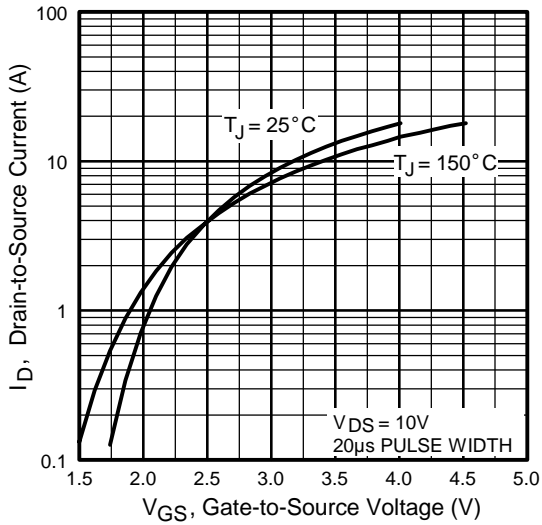
- ① Repetitive rating; pulse width limited by max. junction temperature. ( See fig. 11 )
- ② I<sub>SD</sub> ≤ 2.2A, di/dt ≤ 110A/μs, V<sub>DD</sub> ≤ V<sub>(BR)DSS</sub>, T<sub>J</sub> ≤ 150°C
- ③ Pulse width ≤ 300μs; duty cycle ≤ 2%.
- ④ Surface mounted on FR-4 board, t ≤ 5sec.



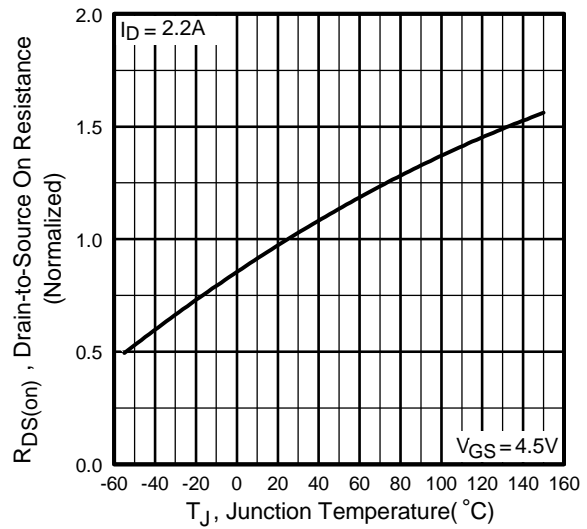
**Fig 1.** Typical Output Characteristics



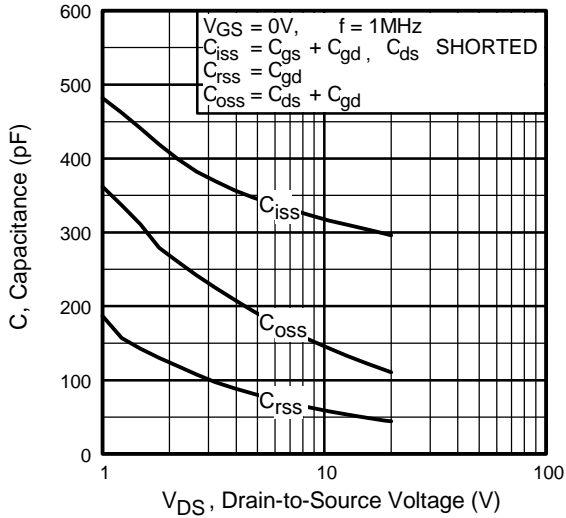
**Fig 2.** Typical Output Characteristics



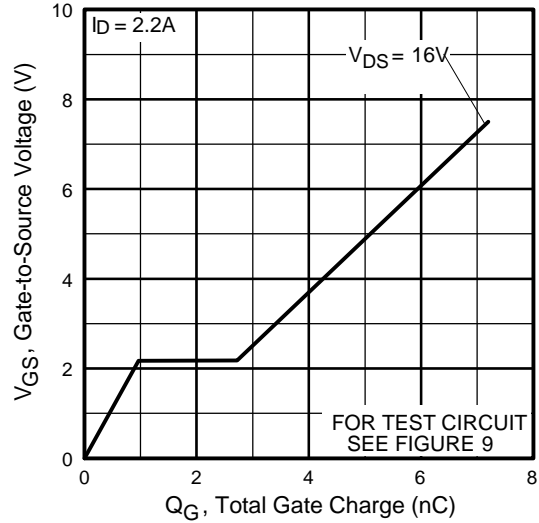
**Fig 3.** Typical Transfer Characteristics



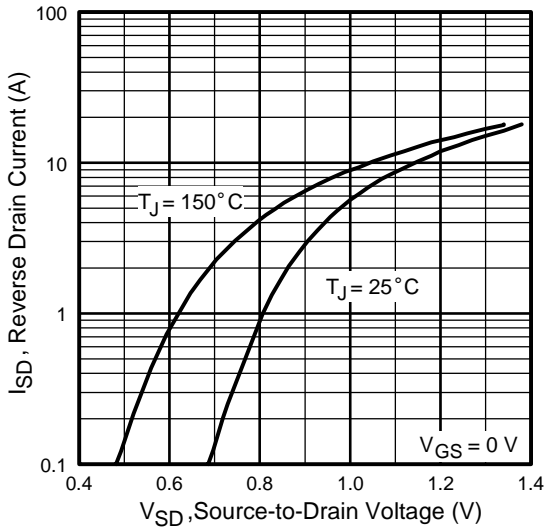
**Fig 4.** Normalized On-Resistance Vs. Temperature



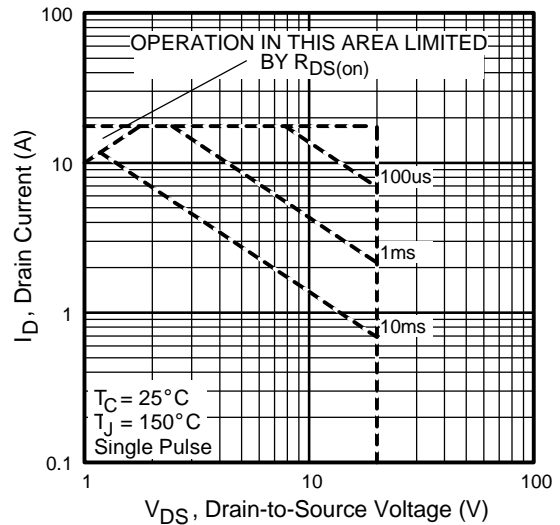
**Fig 5.** Typical Capacitance Vs. Drain-to-Source Voltage



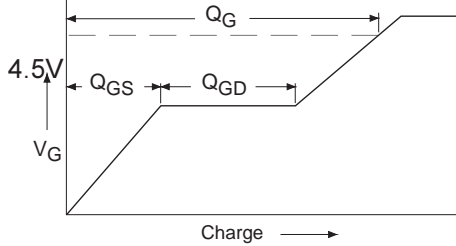
**Fig 6.** Typical Gate Charge Vs. Gate-to-Source Voltage



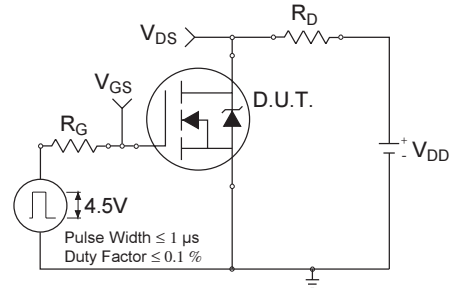
**Fig 7.** Typical Source-Drain Diode Forward Voltage



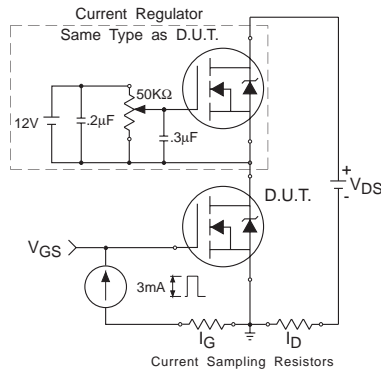
**Fig 8.** Maximum Safe Operating Area



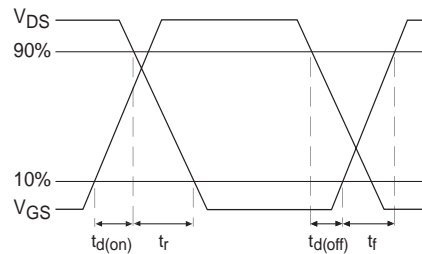
**Fig 9a.** Basic Gate Charge Waveform



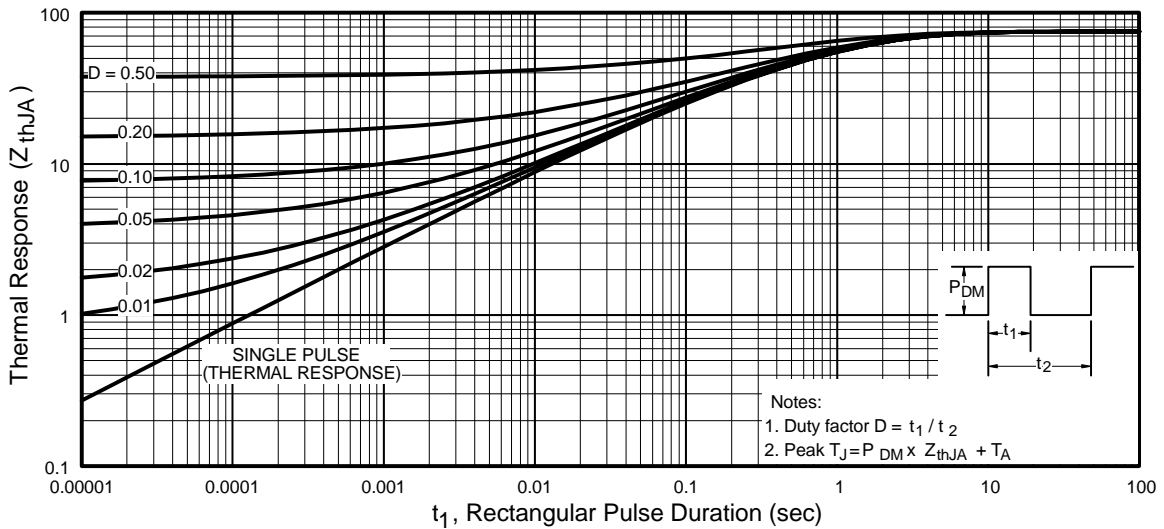
**Fig 10a.** Switching Time Test Circuit



**Fig 9b.** Gate Charge Test Circuit

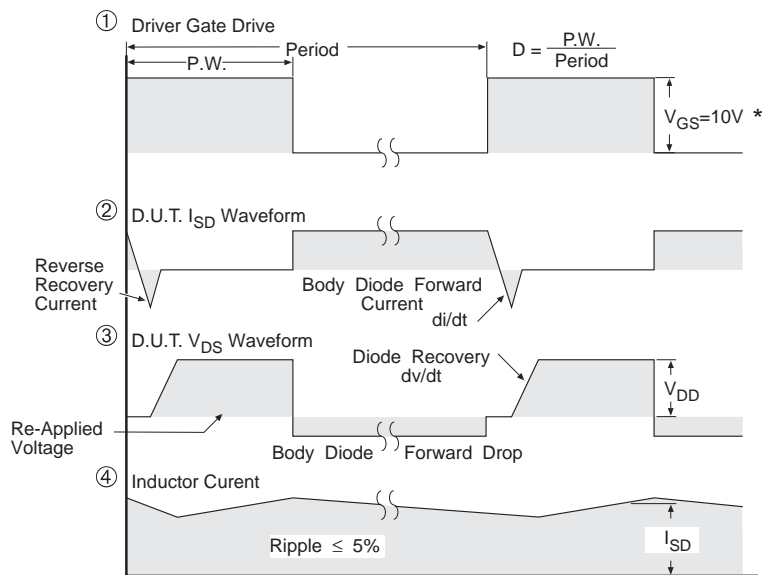
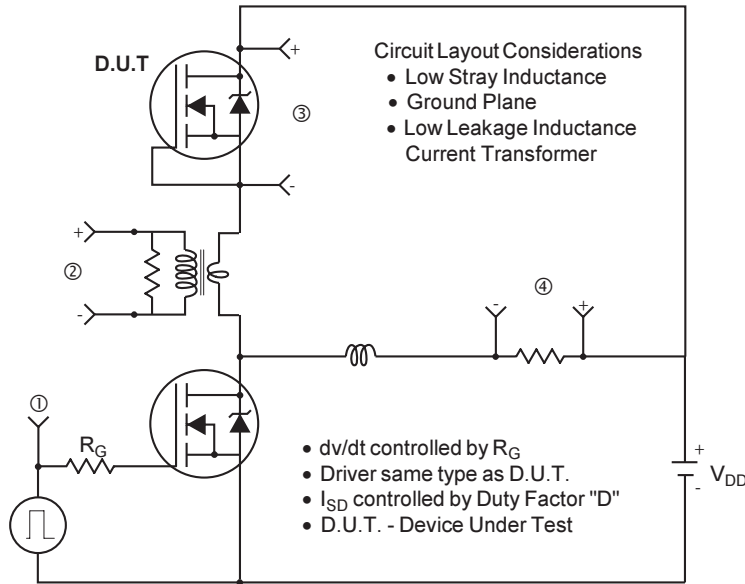


**Fig 10b.** Switching Time Waveforms



**Fig 11.** Maximum Effective Transient Thermal Impedance, Junction-to-Ambient

**Peak Diode Recovery dv/dt Test Circuit**

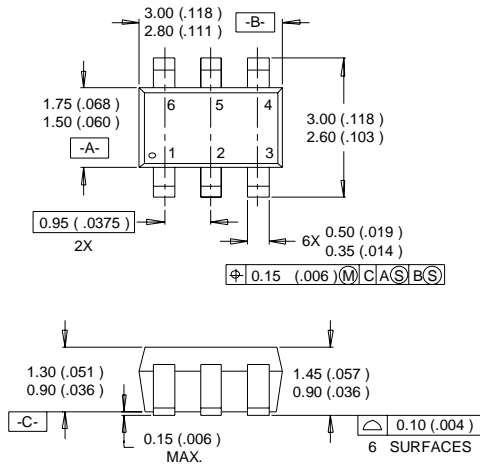


\*  $V_{GS} = 5V$  for Logic Level Devices

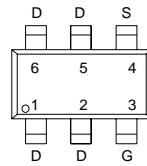
**Fig 12.** For N-channel HEXFET® power MOSFETs

International  
**IRF** Rectifier  
**Package Outline**  
**Micro6™**

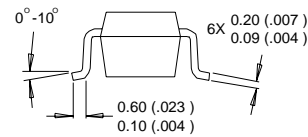
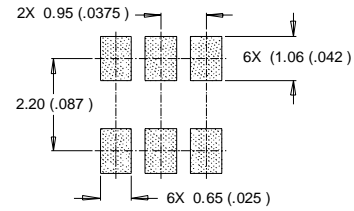
# IRLMS1902



**LEAD ASSIGNMENTS**



**RECOMMENDED FOOTPRINT**



- NOTES :**
1. DIMENSIONING & TOLERANCING PER ANSI Y14.5M-1982.
  2. CONTROLLING DIMENSION : MILLIMETER.
  3. DIMENSIONS ARE SHOWN IN MILLIMETERS (INCHES).

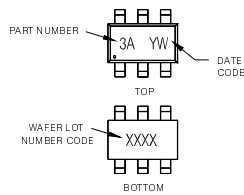
## Part Marking Information

**Micro6™**

Notes: This part marking information applies to devices produced before 02/26/2001

EXAMPLE: THIS IS AN IRLMS6702

WW - (1-26) IF PRECEDED BY LAST DIGIT OF CALENDAR YEAR



YEAR	Y	WORK WEEK	W
2001	1	01	A
2002	2	02	B
2003	3	03	C
2004	4	04	D
2005	5		
1996	6		
1997	7		
1998	8		
1999	9		
2000	0	24	X
		25	Y
		26	Z

PART NUMBER CODE REFERENCE:

- 2A - IRLMS1902
- 2B - IRLMS1503
- 2C - IRLMS6702
- 2D - IRLMS6703
- 2E - IRLMS6802
- 2F - IRLMS4502
- 2G - IRLMS2002
- 2H - IRLMS6803

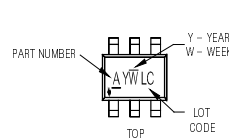
DATE CODE EXAMPLES:  
 YW - 9603 = 6C  
 YW - 9632 = FF

WW - (27-52) IF PRECEDED BY A LETTER

YEAR	Y	WORK WEEK	W
2001	A	27	A
2002	B	28	B
2003	C	29	C
2004	D	30	D
2005	E		
1996	F		
1997	G		
1998	H		
1999	J		
2000	K	50	X
		51	Y
		52	Z

Notes: This part marking information applies to devices produced after 02/26/2001

W - (1-26) IF PRECEDED BY LAST DIGIT OF CALENDAR YEAR



PART NUMBER CODE REFERENCE:

- A - IRLMS1902
- B - IRLMS1503
- C - IRLMS6702
- D - IRLMS6703
- E - IRLMS6802
- F - IRLMS4502
- G - IRLMS2002
- H - IRLMS6803

Note: A line above the work week (as shown here) indicates Lead-Free.

YEAR	Y	WORK WEEK	W
2001	1	01	A
2002	2	02	B
2003	3	03	C
2004	4	04	D
2005	5		
1996	6		
1997	7		
1998	8		
1999	9		
2000	0	24	X
		25	Y
		26	Z

W - (27-52) IF PRECEDED BY A LETTER

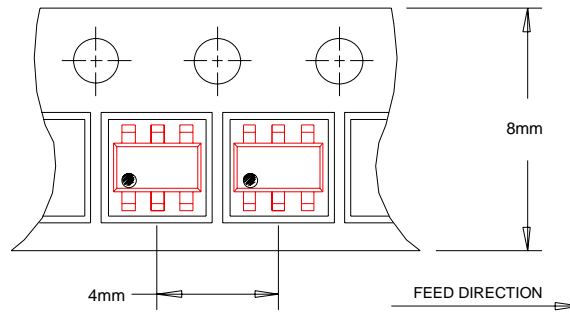
YEAR	Y	WORK WEEK	W
2001	A	27	A
2002	B	28	B
2003	C	29	C
2004	D	30	D
2005	E		
1996	F		
1997	G		
1998	H		
1999	J		
2000	K	50	X
		51	Y
		52	Z

# IRLMS1902

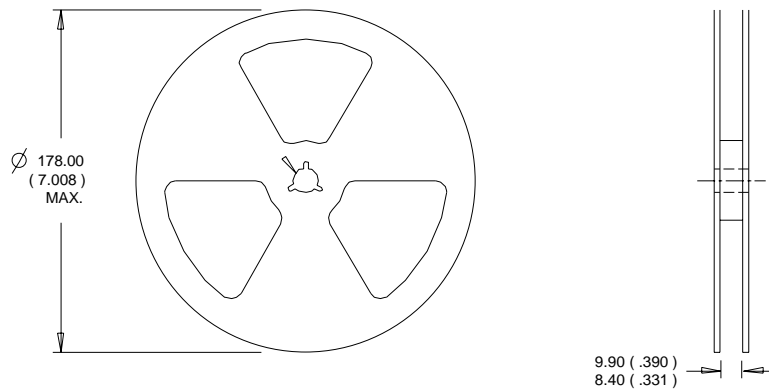
International  
**IR** Rectifier

## Tape & Reel Information

Micro6™



NOTES:  
1. OUTLINE CONFORMS TO EIA-481 & EIA-541.



NOTES:  
1. CONTROLLING DIMENSION : MILLIMETER.  
2. OUTLINE CONFORMS TO EIA-481 & EIA-541.

Data and specifications subject to change without notice.

International  
**IR** Rectifier

IR WORLD HEADQUARTERS: 233 Kansas St., El Segundo, California 90245, USA Tel: (310) 252-7105  
TAC Fax: (310) 252-7903

Visit us at [www.irf.com](http://www.irf.com) for sales contact information. 03/04

[www.irf.com](http://www.irf.com)



## X-ON Electronics

Largest Supplier of Electrical and Electronic Components

*Click to view similar products for [international rectifier manufacturer](#):*

Other Similar products are found below :

[AUIRFU4104](#) [IR2177SPBF](#) [IRAM136-1561A](#) [IRF7807VTRPBF](#) [IRF9642](#) [IRFB4321GPBF](#) [IRFR7446PBF](#) [IRG4PH40UD-EPBF](#)  
[IRGS30B60KTRRP](#) [IRGP4263PBF](#) [IRGP4063D-EPBF](#) [IRG4PC50KPBF](#) [IRFSL3207ZPBF](#) [IRF9362TRPBF](#) [IRS2548DSTRPBF](#)  
[IRLR8721PBF](#) [IRF3709ZPBF](#) [IRGP4063D1-EPBF](#) [IRDC3898](#) [IRDC3897](#) [IRDC3895](#) [IRF9389TRPBF](#) [IRF8707GTRPBF](#) [IRF1607PBF](#)  
[IRDC3823](#) [IRAUDAMP17](#) [IRFPE50PBF](#) [IRFD9110](#) [IRFD9120](#) [IRDC3811](#) [IRF1010NSPBF](#) [IRF1018ESPBF](#) [IRGB30B60KPBF](#)  
[IRS210614STRPBF](#) [IRDC3821](#) [IRG4PH40U](#) [IRGP4630DPBF](#) [IRLR024NTRLPBF](#) [IRDC3832W](#) [IRAUDAMP4A](#) [IRAUDAMP22](#)  
[IRFS3004-7PPBF](#) [IRFR1018ETRPBF](#) [IRFL024NTRPBF](#) [IRAUDAMP9](#) [IR2132SPbF](#) [IRFPF40PBF](#) [IRAUDAMP6](#) [IRG7PH44K10DPBF](#)  
[IRG8P60N120KD-EPBF](#)