

Cylindrical Connector Type

Cylindrical connector type proximity sensor

■ Features

- Shorten the time of maintenance
- Improved the noise resistance with dedicated IC (DC 3-wire)
- Reverse power polarity (DC 3-wire), surge (AC/DC), overcurrent protection (DC)
- Red LED status indication
- IP67 rated waterproof structure (IEC standard)
- Replacer for micro switches and limit switches

 Please read "Caution for your safety" in operation manual before using.



■ Specifications

● DC 2-wire type

Model	PRCMT12-2DO PRCMT12-2DC	PRCMT12-4DO PRCMT12-4DC	PRCMT18-5DO PRCMT18-5DC	PRCMT18-8DO PRCMT18-8DC	PRCMT30-10DO PRCMT30-10DC	PRCMT30-15DO PRCMT30-15DC
Sensing distance	2mm ±10%	4mm ±10%	5mm ±10%	8mm ±10%	10mm ±10%	15mm ±10%
Hysteresis	Max. 10% of sensing distance					
Standard sensing target	12×12×1mm (Iron)		18×18×1mm (Iron)	25×25×1mm (Iron)	30×30×1mm (Iron)	45×45×1mm (Iron)
Setting distance	0 ~ 1.4mm	0 ~ 2.8mm	0 ~ 3.5mm	0 ~ 5.6mm	0 ~ 7mm	0 ~ 10.5mm
Power supply (Operation voltage)	12-24VDC (10-30VDC)					
Leakage current	Max. 0.6mA					
Response frequency(*1)	1.5kHz	500Hz	350Hz	400Hz	200Hz	
Residual voltage	Max. 7V					
Affection by Temp.	±10% Max. for sensing distance at +20°C within temperature range of -25 ~ +70°C					
Control output	2 ~ 100mA					
Dielectric strength	Min. 50MΩ (at 500VDC mega)					
Insulation resistance	1500VAC 50/60Hz for 1 minute					
Vibration	1mm amplitude at frequency of 10 ~ 55Hz in each of X, Y, Z directions for 2 hours					
Shock	500m/s ² (50G) in X, Y, Z directions for 3 times					
Indicator	Operation indicator (Red LED)					
Ambient temperature	-25 ~ +70°C (at non-freezing status)					
Storage temperature	-30 ~ +80°C (at non-freezing status)					
Ambient humidity	35 ~ 95%RH					
Protection circuit	Surge protection circuit, Overload & Short circuit protection					
Protection	IP67 (IEC standard)					
Approval	CE					
Unit weight	Approx. 26g		Approx. 49g		Approx. 134g	

※ (*1) The response frequency is the average value. The standard sensing target is used and the width is set as 2 times of the standard sensing target, 1/2 of the sensing distance for the distance.

※ IEC standard item is available and add "-I" to the end of model. Ex) PRCM12-4DO-I

※ See J-51 for IEC standard connector cables and specifications.

(A)
Counter

(B)
Timer

(C)
Temp.
controller

(D)
Power
controller

(E)
Panel
meter

(F)
Tacho/
Speed/
Pulse
meter

(G)
Display
unit

(H)
Sensor
controller

(I)
Switching
power
supply

(J)
Proximity
sensor

(K)
Photo
electric
sensor

(L)
Pressure
sensor

(M)
Rotary
encoder

(N)
Stepping
motor &
Driver &
Controller

(O)
Graphic
panel

(P)
Field
network
device

(Q)
Production
stoppage
models &
replacement

PRCM Series

■ Specifications

● DC 3-wire type

Model	PRCM12-2DN PRCM12-2DP PRCM12-2DN2 PRCM12-2DP2	PRCM12-4DN PRCM12-4DP PRCM12-4DN2 PRCM12-4DP2	PRCM18-5DN PRCM18-5DP PRCM18-5DN2 PRCM18-5DP2 PRCML18-5DN PRCML18-5DP PRCML18-5DN2 PRCML18-5DP2	PRCM18-8DN PRCM18-8DP PRCM18-8DN2 PRCM18-8DP2 PRCML18-8DN PRCML18-8DP PRCML18-8DN2 PRCML18-8DP2	PRCM30-10DN PRCM30-10DP PRCM30-10DN2 PRCM30-10DP2 PRCML30-10DN PRCML30-10DP PRCML30-10DN2 PRCML30-10DP2	PRCM30-15DN PRCM30-15DP PRCM30-15DN2 PRCM30-15DP2 PRCML30-15DN PRCML30-15DP PRCML30-15DN2 PRCML30-15DP2
Sensing distance	2mm ±10%	4mm ±10%	5mm ±10%	8mm ±10%	10mm ±10%	15mm ±10%
Hysteresis	Max. 10% of sensing distance					
Standard sensing target	12×12×1mm (Iron)		18×18×1mm (Iron)	25×25×1mm (Iron)	30×30×1mm (Iron)	45×45×1mm (Iron)
Setting distance	0 ~ 1.4mm	0 ~ 2.8mm	0 ~ 3.5mm	0 ~ 5.6mm	0 ~ 7mm	0 ~ 10.5mm
Power supply (Operation voltage)	12~24VDC (10~30VDC)					
Current consumption	Max. 10mA					
Response frequency(*1)	1.5kHz	500Hz	350Hz	400Hz	200Hz	
Residual voltage	Max. 1.5V					
Affection by Temp.	±10% Max. for sensing distance at +20°C within temperature range of -25 ~ +70°C					
Control output	Max. 200mA					
Dielectric strength	Min. 50MΩ (at 500VDC mega)					
Insulation resistance	1500VAC 50/60Hz for 1 minute					
Vibration	1mm amplitude at frequency of 10 ~ 55Hz in each of X, Y, Z directions for 2 hours					
Shock	500m/s ² (50G) in X, Y, Z directions for 3 times					
Indicator	Operation indicator (Red LED)					
Ambient temperature	-25 ~ +70°C (at non-freezing status)					
Storage temperature	-30 ~ +80°C (at non-freezing status)					
Ambient humidity	35 ~ 95%RH					
Protection circuit	Surge, Reverse power polarity, Overcurrent protection circuit					
Protection	IP67 (IEC standard)					
Approval	CE					
Unit weight	Approx. 26g		PRCM18 : Approx. 49g PRCML18 : Approx. 73g		PRCM30 : Approx. 134g PRCML30 : Approx. 169g	

※ (*1) The response frequency is the average value. The standard sensing target is used and the width is set as 2 times of the standard sensing target, 1/2 of the sensing distance for the distance.

● AC 2-wire type

Model	PRCM12-2AO PRCM12-2AC	PRCM12-4AO PRCM12-4AC	PRCM18-5AO PRCM18-5AC PRCML18-5AO PRCML18-5AC	PRCM18-8AO PRCM18-8AC PRCML18-8AO PRCML18-8AC	PRCM30-10AO PRCM30-10AC PRCML30-10AO PRCML30-10AC	PRCM30-15AO PRCM30-15AC PRCML30-15AO PRCML30-15AC
Sensing distance	2mm ±10%	4mm ±10%	5mm ±10%	8mm ±10%	10mm ±10%	15mm ±10%
Hysteresis	Max. 10% of sensing distance					
Standard sensing target	12×12×1mm (Iron)		18×18×1mm (Iron)	25×25×1mm (Iron)	30×30×1mm (Iron)	45×45×1mm (Iron)
Setting distance	0 ~ 1.4mm	0 ~ 2.8mm	0 ~ 3.5mm	0 ~ 5.6mm	0 ~ 7mm	0 ~ 10.5mm
Power supply (Operation voltage)	100~240VAC (85~264VAC)					
Leakage current	Max. 2.5mA					
Response frequency(*1)	20Hz					
Residual voltage	Max. 10V					
Affection by Temp.	±10% Max. for sensing distance at +20°C within temperature range of -25 ~ +70°C					
Control output	5 ~ 150mA			5 ~ 200mA		
Dielectric strength	Min. 50MΩ (at 500VDC mega)					
Insulation resistance	2500VAC 50/60Hz for 1 minute					
Vibration	1mm amplitude at frequency of 10 ~ 55Hz in each of X, Y, Z directions for 2 hours					
Shock	500m/s ² (50G) in X, Y, Z directions for 3 times					
Indicator	Operation indicator (Red LED)					
Ambient temperature	-25 ~ +70°C (at non-freezing status)					
Storage temperature	-30 ~ +80°C (at non-freezing status)					
Ambient humidity	35 ~ 95%RH					
Protection circuit	Surge protection circuit					
Protection	IP67 (IEC standard)					
Approval	CE					
Unit weight	Approx. 30g		PRCM18 : Approx. 53g PRCML18 : Approx. 74g		PRCM30 : Approx. 134g PRCML30 : Approx. 169g	

※ (*1) The response frequency is the average value. The standard sensing target is used and the width is set as 2 times of the standard sensing target, 1/2 of the sensing distance for the distance.

Cylindrical Connector Type

Dimensions

(Unit:mm)

●PRCM(T)12-2D□

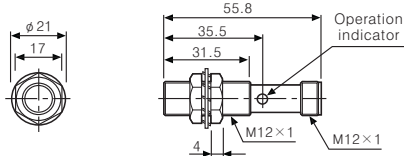

●PRCM(T)12-4D□

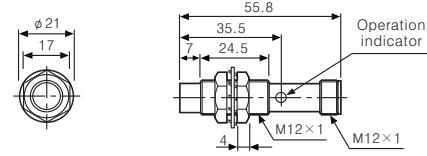

●PRCM(T)18-5D□

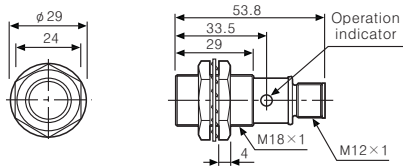

●PRCM(T)18-8D□

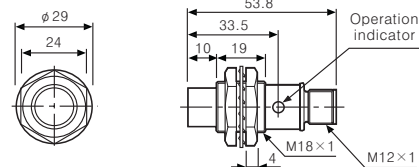

●PRCM(T)30-10D□

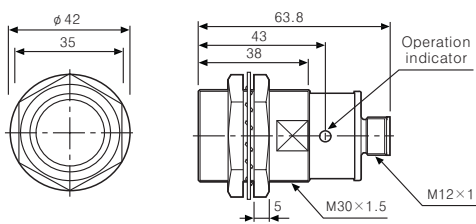

●PRCM(T)30-15D□

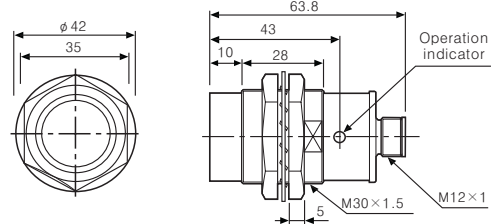

●PRCM12-2A□

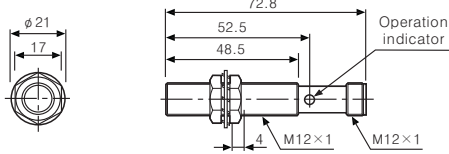

●PRCM12-4A□

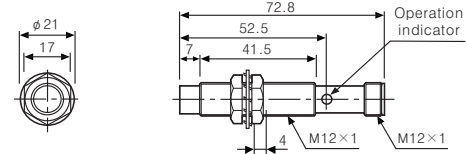

●PRCM18-5A□

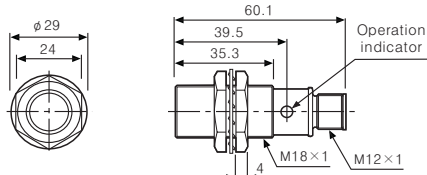

●PRCM18-8A□

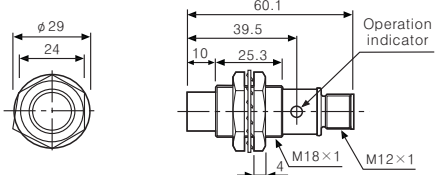

●PRCM30-10A□

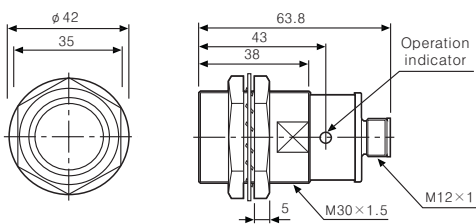

●PRCM30-15A□

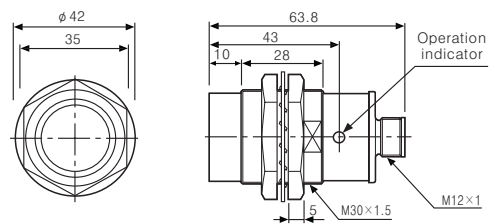

●PRCML18-5D□ / PRCML18-5A□

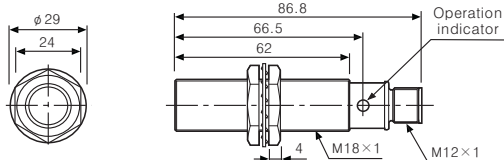

●PRCML18-8D□ / PRCML18-8A□

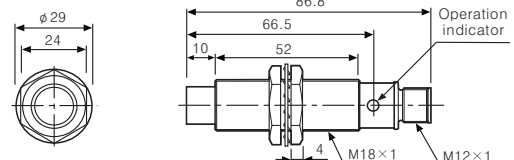

●PRCML30-10D□ / PRCML30-10A□

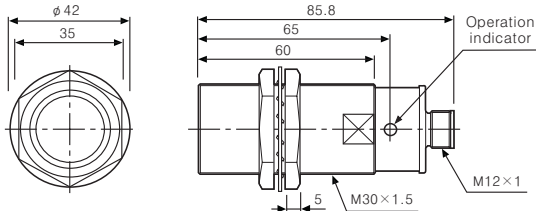

●PRCML30-15D□ / PRCML30-15A□

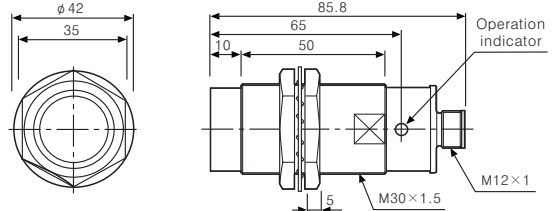

(A)
Counter

(B)
Timer

(C)
Temp.
controller

(D)
Power
controller

(E)
Panel
meter

(F)
Tacho/
Speed/
Pulse
meter

(G)
Display
unit

(H)
Sensor
controller

(I)
Switching
power
supply

(J)
Proximity
sensor

(K)
Photo
electric
sensor

(L)
Pressure
sensor

(M)
Rotary
encoder

(N)
Stepping
motor &
Driver &
Controller

(O)
Graphic
panel

(P)
Field
network
device

(Q)
Production
stoppage
models &
replacement

PRCM Series

Control output diagram

DC 2-wire type

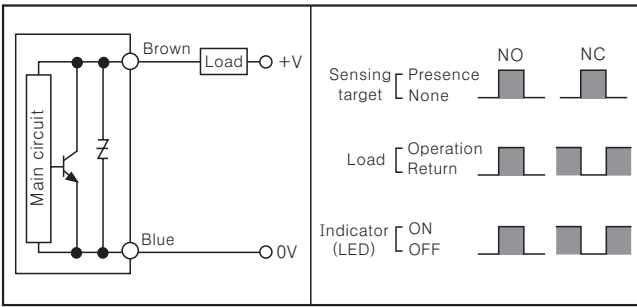

DC 3-wire type

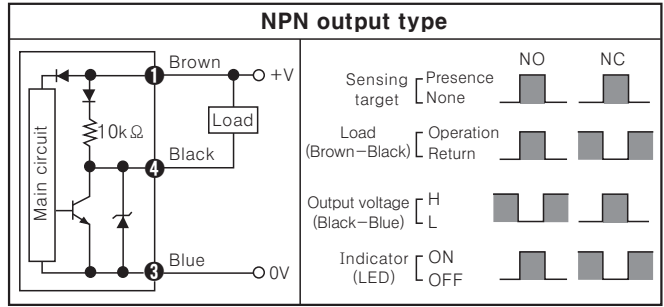

AC 2-wire type

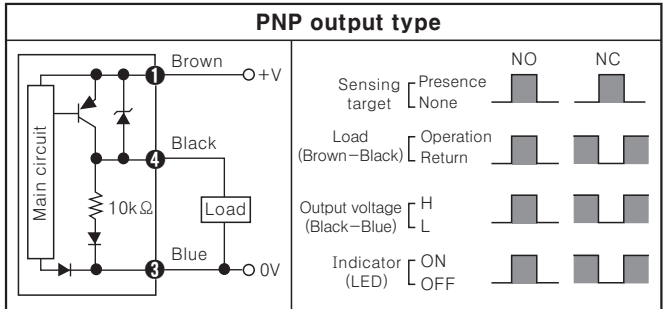
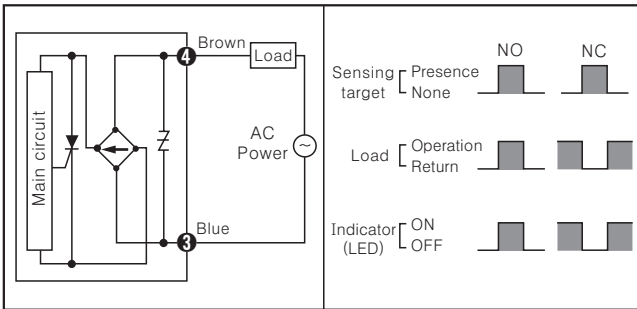

*The number in a circle is pin no. of connector.

Wiring diagram

DC 2-wire type (Standard type)

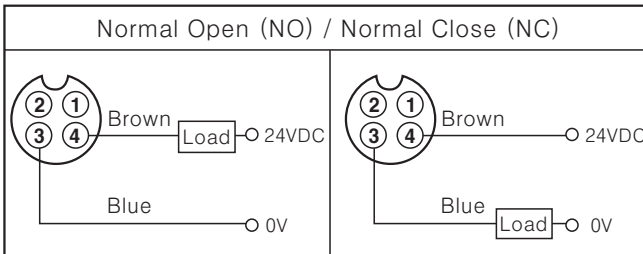

*Pin ①, ② are N.C (Not Connected) terminals.
*For DC 3-wire type connector cable, it is available to use with black wire (24VDC) and blue wire (0V).

DC 2-wire type (IEC standard type)

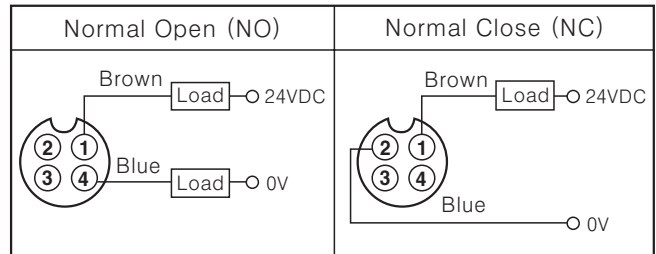

*The pin arrangement of connector applying IEC standard is being developed.
*Please attach "I" at the end of the name of standard type for purchasing the IEC standard product. Ex) PRCMT12-4DO-I
*The connector cable for IEC standard is being developed. Please attach "I" at the end of the name of standard type. Ex) CID2-2-I, CLD2-5-I

DC 3-wire

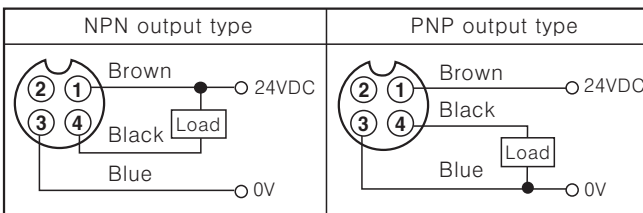

*Please fasten the cleat of connector not to shown the thread. (0.39~0.49N·m)

AC 2-wire

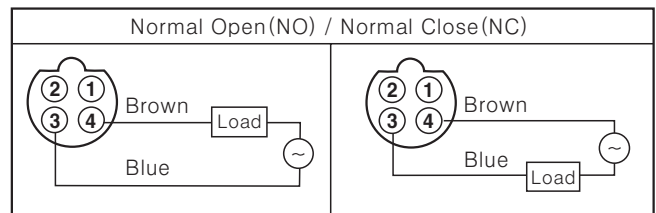

*In AC inductive type, ② and ③, ① and ④ are connected inside of the connector cable.

*Please fasten the vibration part with Teflon tape.
*See J-51 about IEC standard connector wires and specifications.

Cylindrical Connector Type

■ Proper usage

◎ Load connections

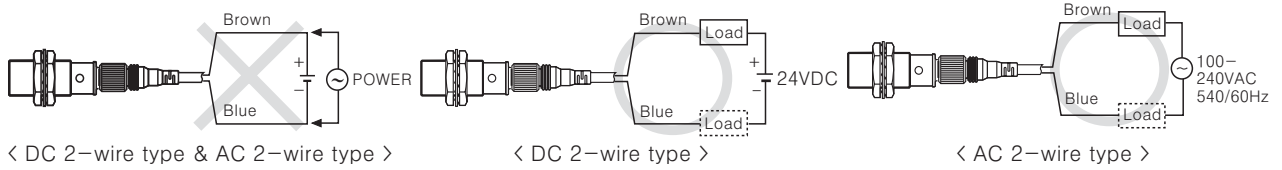

< DC 2-wire type & AC 2-wire type >

< DC 2-wire type >

< AC 2-wire type >

When using DC or AC 2-wire type proximity sensor, the load must be connected otherwise internal components may be damaged. And the load can be connected to either wire.

◎ In case of the load current is small

● AC 2-wire type

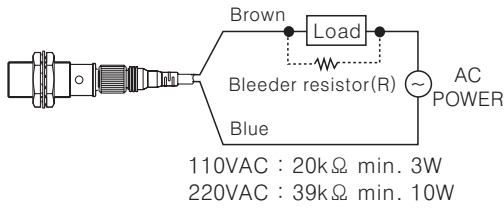

It may cause return failure of load by residual voltage. If the load current is under 5mA, please make sure the residual voltage is less than the return voltage of the load by connecting a bleeder resistor in parallel with the load as shown in the diagram.

$$R = \frac{V_s}{I} \text{ (}\Omega\text{)} \quad P = \frac{V_s^2}{R} \text{ (W)}$$

[I : Action current of load, R : Bleeder resistance, P : Permissible power]

● DC 2-wire type

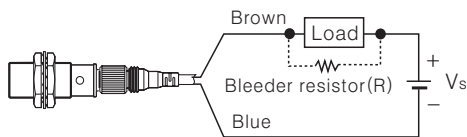

Please make the current on proximity sensor smaller than the return current of load by connecting a bleeder resistor in parallel. ※ W value of Bleeder resistor should be bigger for proper heat dissipation.

$$R = \frac{V_s}{I_o - I_{off}} \text{ (}\Omega\text{)} \quad P = \frac{V_s^2}{R} \text{ (W)}$$

[Vs : Power supply, Io : Min. action current of proximity sensor
Ioff : Return current of load, P : Number of Bleeder resistance watt]

◎ Mutual-interference & Influence by surrounding metals

When several proximity sensors are mounted closely, malfunction of sensor may be caused due to mutual interference. Therefore, be sure to provide a minimum distance between the two sensors, as below charts.

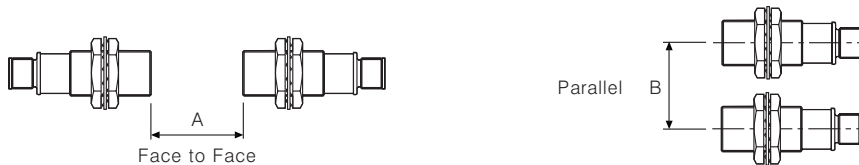

When sensors are mounted on metallic panel, you must prevent the sensors from being affected by any metallic object except target. Therefore, be sure to provide a minimum distance as below chart.

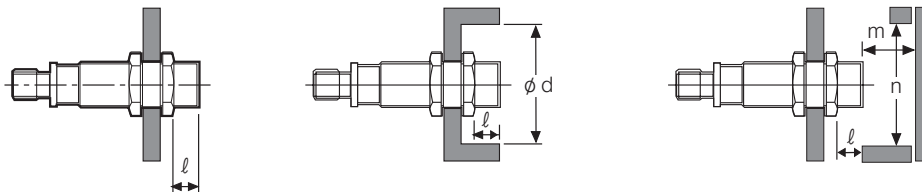

(Unit:mm)

Model	PRCMT12-2D□	PRCMT12-4D□	PRCMT18-5D	PRCMT18-8D□	PRCMT30-10D□	PRCMT30-15D
Item	PRCM12-2D□ PRCM12-2A□	PRCM12-4D□ PRCM12-4A□	PRCM(L)18-5D PRCM(L)18-5A	PRCM(L)18-8D□ PRCM(L)18-8A□	PRCM(L)30-10D□ PRCM(L)30-10A□	PRCM(L)30-15D PRCM(L)30-15A
A	12	24	30	48	60	90
B	24	36	36	54	60	90
l	0	11	0	14	0	15
φ d	12	36	18	54	30	90
m	6	12	15	24	30	54
n	18	36	27	54	45	90

- (A) Counter
- (B) Timer
- (C) Temp. controller
- (D) Power controller
- (E) Panel meter
- (F) Tacho/Speed/Pulse meter
- (G) Display unit
- (H) Sensor controller
- (I) Switching power supply
- (J) Proximity sensor
- (K) Photo electric sensor
- (L) Pressure sensor
- (M) Rotary encoder
- (N) Stepping motor & Driver & Controller
- (O) Graphic panel
- (P) Field network device
- (Q) Production stoppage models & replacement

X-ON Electronics

Largest Supplier of Electrical and Electronic Components

Click to view similar products for [Proximity Sensors](#) category:

Click to view products by [Autonics](#) manufacturer:

Other Similar products are found below :

[01.001.5653.1](#) [70.340.1028.0](#) [70.360.2428.0](#) [70.364.4828.0](#) [70.810.1053.0](#) [72.360.1628.0](#) [73.363.6428.0](#) [980659-1](#) [QT-12](#)
[E2ECQC2D1M1GJT03M](#) [E2EX10D1NN](#) [E2E-X14MD1-G](#) [E2E-X2D1-G](#) [E2EX2ME2N](#) [E2E-X3D1-N](#) [10M](#) [E2E-X4MD1-G](#)
[E2FMX1R5D12M](#) [E2K-F10MC1](#) [5M](#) [EC3016PPASL-1](#) [EI1204TBOSL-6](#) [EI5515NPAP](#) [BSA-08-25-08](#) [IC08ANC15PO-K](#) [25.161.3253.0](#)
[25.332.0653.1](#) [25.352.0653.0](#) [25.352.0753.0](#) [25.523.3253.0](#) [922FS1.5C-A4P-Z774](#) [SC606ABV0S30](#) [SM552A100](#) [SM952A126100LE](#)
[SM956A132600](#) [A1220EUA-T](#) [F3S-A162-U](#) [CL18](#) [QT-08L](#) [34.110.0010.0](#) [TL-C2MF1-M3-E4](#) [IA08BLF15NOM5](#) [IA08BSF15NOM5](#)
[IA12ASF04DOM1](#) [IS2](#) [IS31SE5000-UTLS2-TR](#) [34.110.0021.0](#) [34.110.0022.0](#) [CA150-120VACDC](#) [VM18VA3000Q](#) [XS508BSCBL2](#)
[XS512BLNAM12](#)