

## PrevaLED Cube AC

### Spot-, Down- and Wallmount Light Engines and Modules



#### Areas of application

- Suitable for diffuser and reflector luminaires
- Hospitality, hotels, restaurants
- Public and commercial buildings
- Offices
- Secondary rooms, garages, storerooms, cellars

#### Product benefits

- Enabling low cost and compact luminaire designs
- Low profile
- Future-proof dimensions for reliable designs
- Near Lambertian light distribution at 110° beam angle for high quality of light
- Safety through thermal shutdown

#### Product features

- Mains voltage driven LED engine
- Integrated control gear
- Diameter of light emitting surface: 61 mm
- System efficacy: up to 84 lm/W at 4,000 K
- Common mechanic and photometric interfaces
- Consistent white light: < 3 SDCM
- Lifetime (L70/B50): 50,000 h (temperature at  $t_c$  point < 80 °C) acc. to IEC/PAS 62717
- Temperature at  $t_p$  point (according to IEC/PAS 62717): 70 °C



## Product family datasheet

### Technical data

#### Electrical data

Product description	Nominal voltage	Nominal current	Nominal wattage	Rated wattage
LEP-CUB-AC -830-G1	230.00 V	0.13 A	13.5 W	13.00 W
LEP-CUB-AC -840-G1	230.00 V	0.13 A	13.0 W	13.00 W
PL-CUBE-AC -2000-830-G2	230.00 V		27.8 W	27.80 W
PL-CUBE-AC -2000-840-G2	230.00 V		25.3 W	25.30 W
PL-CUBE-AC -3000-830-G2	230.00 V		42.7 W	42.70 W
PL-CUBE-AC -3000-840-G2	230.00 V		38.4 W	38.40 W

Product description	Type of current	Voltage range	Power factor $\lambda$	Energy consumption
LEP-CUB-AC -830-G1	AC	220...240 V	0.78	15 kWh/1000h
LEP-CUB-AC -840-G1	AC	220...240 V	0.78	15 kWh/1000h
PL-CUBE-AC -2000-830-G2	AC	220...240 V	0.90	28
PL-CUBE-AC -2000-840-G2	AC	220...240 V	0.90	26
PL-CUBE-AC -3000-830-G2	AC	220...240 V	0.90	42
PL-CUBE-AC -3000-840-G2	AC	220...240 V	0.90	39

#### Light technical data

Product description	Nominal beam angle	Rated beam angle	Color temperature	Color rendering index Ra
LEP-CUB-AC -830-G1	110.00 °	110.00 °	3000 K	≥80
LEP-CUB-AC -840-G1	110.00 °	110.00 °	4000 K	≥80
PL-CUBE-AC -2000-830-G2	110.00 °	110.00 °	3000 K	≥80
PL-CUBE-AC -2000-840-G2	110.00 °	110.00 °	4000 K	≥80
PL-CUBE-AC -3000-830-G2	110.00 °	110.00 °	3000 K	≥80
PL-CUBE-AC -3000-840-G2	110.00 °	110.00 °	4000 K	≥80

Product description	Light color as per EN 12464-1	Light color LED	Total useful luminous flux	Luminous flux
LEP-CUB-AC -830-G1	Warm White	warm white	1100 lm	1100 lm
LEP-CUB-AC -840-G1	Cool White	cool white	1100 lm	1100 lm
PL-CUBE-AC -2000-830-G2	Warm White	warm white	2000 lm	2000 lm
PL-CUBE-AC -2000-840-G2	Cool White	cool white	2000 lm	2000 lm
PL-CUBE-AC -3000-830-G2	Warm White	warm white	3000 lm	3000 lm
PL-CUBE-AC -3000-840-G2	Cool White	cool white	3000 lm	3000 lm

## Product family datasheet

Product description	Lumen main.fact.at end of nom.life time	Rated peak intensity	Luminous efficacy	Starting time
LEP-CUB-AC -830-G1	0.70	400 cd	81 lm/W	0.5 s
LEP-CUB-AC -840-G1	0.70	400 cd	85 lm/W	0.5 s
PL-CUBE-AC -2000-830-G2	0.70	740 cd	72 lm/W	0.5 s
PL-CUBE-AC -2000-840-G2	0.70	740 cd	80 lm/W	0.5 s
PL-CUBE-AC -3000-830-G2	0.70	1100 cd	71 lm/W	0.5 s
PL-CUBE-AC -3000-840-G2	0.70	1100 cd	79 lm/W	0.5 s

Product description	Warm-up time (60 %)	Standard deviation of color matching
LEP-CUB-AC -830-G1	< 2.00 s	≤3 sdcn
LEP-CUB-AC -840-G1	< 2.00 s	≤3 sdcn
PL-CUBE-AC -2000-830-G2	< 2.00 s	≤3 sdcn
PL-CUBE-AC -2000-840-G2	< 2.00 s	≤3 sdcn
PL-CUBE-AC -3000-830-G2	< 2.00 s	≤3 sdcn
PL-CUBE-AC -3000-840-G2	< 2.00 s	≤3 sdcn

## Dimensions & weight

Product description	Rated height	Height	Rated width	Construction length
LEP-CUB-AC -830-G1	21.00 mm	18.5 mm	82.00 mm	83.0 mm
LEP-CUB-AC -840-G1	21.00 mm	18.5 mm	82.00 mm	83.0 mm
PL-CUBE-AC -2000-830-G2	21.00 mm	18.5 mm	82.00 mm	83.0 mm
PL-CUBE-AC -2000-840-G2	21.00 mm	18.5 mm	82.00 mm	83.0 mm
PL-CUBE-AC -3000-830-G2	21.00 mm	18.5 mm	82.00 mm	83.0 mm
PL-CUBE-AC -3000-840-G2	21.00 mm	18.5 mm	82.00 mm	83.0 mm

Product description	Product weight
LEP-CUB-AC -830-G1	59.10 g
LEP-CUB-AC -840-G1	59.10 g
PL-CUBE-AC -2000-830-G2	59.10 g
PL-CUBE-AC -2000-840-G2	59.10 g
PL-CUBE-AC -3000-830-G2	55.40 g
PL-CUBE-AC -3000-840-G2	55.40 g

## Produkt Strichzeichnungen (vermasst)

## Product family datasheet

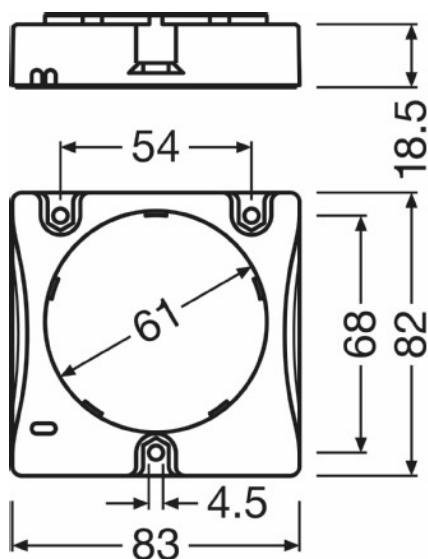

Product line drawing  
LEP-CUB-AC -830-G1 | LEP-CUB-AC -840-G1

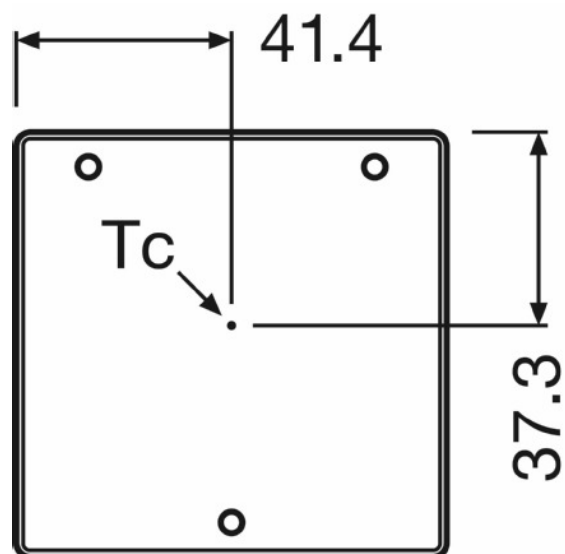

Product line drawing  
PL-CUBE-AC -2000-830-G2 | PL-CUBE-AC -2000-840-G2 |  
PL-CUBE-AC -3000-830-G2 | PL-CUBE-AC -3000-840-G2

## Temperatures

Product description	Maximum temperature at tc test point	Ambient temperature range
LEP-CUB-AC -830-G1	85 °C <sup>1)</sup>	-20...+50 °C
LEP-CUB-AC -840-G1	85 °C <sup>1)</sup>	-20...+50 °C
PL-CUBE-AC -2000-830-G2	85 °C <sup>1)</sup>	-20...+50 °C
PL-CUBE-AC -2000-840-G2	85 °C <sup>1)</sup>	-20...+50 °C
PL-CUBE-AC -3000-830-G2	85 °C <sup>1)</sup>	-20...+50 °C
PL-CUBE-AC -3000-840-G2	85 °C <sup>1)</sup>	-20...+50 °C

<sup>1)</sup> Maximum at the Tc-point

## Lifespan

Product description	Lifespan	Nominal lamp life time	Rated lamp life time	Number of switching cycles
LEP-CUB-AC -830-G1	50000 h <sup>1)</sup>	50000 h	50000 h	>=25000
LEP-CUB-AC -840-G1	50000 h <sup>1)</sup>	50000 h	50000 h	>=25000
PL-CUBE-AC -2000-830-G2	50000 h <sup>1)</sup>	50000 h	50000 h	>=25000
PL-CUBE-AC -2000-840-G2	50000 h <sup>1)</sup>	50000 h	50000 h	>=25000

## Product family datasheet

Product description	Lifespan	Nominal lamp life time	Rated lamp life time	Number of switching cycles
PL-CUBE-AC -3000-830-G2	50000 h <sup>1)</sup>	50000 h	50000 h	>=25000
PL-CUBE-AC -3000-840-G2	50000 h <sup>1)</sup>	50000 h	50000 h	>=25000

<sup>1)</sup> L70/B50 at Tc 70 °C

### Capabilities

Product description	Dimmable
LEP-CUB-AC -830-G1	No
LEP-CUB-AC -840-G1	No
PL-CUBE-AC -2000-830-G2	No
PL-CUBE-AC -2000-840-G2	No
PL-CUBE-AC -3000-830-G2	No
PL-CUBE-AC -3000-840-G2	No

### Certificates & standards

Product description	Energy efficiency class	Standards
LEP-CUB-AC -830-G1	A	CE/acc. to EN 62031/acc. to EN 55015/acc. to EN 61000-3-2/acc. to EN 61000-3-3/acc. to EN 61547/acc. to IEC 62471/acc. to VDE
LEP-CUB-AC -840-G1	A	CE/acc. to EN 62031/acc. to EN 55015/acc. to EN 61000-3-2/acc. to EN 61000-3-3/acc. to EN 61547/acc. to IEC 62471/acc. to VDE
PL-CUBE-AC -2000-830-G2	A	CE/acc. to EN 62031/acc. to EN 55015/acc. to EN 61000-3-2/acc. to EN 61000-3-3/acc. to EN 61547/acc. to IEC 62471/acc. to VDE
PL-CUBE-AC -2000-840-G2	A	CE/acc. to EN 62031/acc. to EN 55015/acc. to EN 61000-3-2/acc. to EN 61000-3-3/acc. to EN 61547/acc. to IEC 62471/acc. to VDE

## Product family datasheet

Product description	Energy efficiency class	Standards
PL-CUBE-AC -3000-830-G2	A	CE/acc. to EN 62031/acc. to EN 55015/acc. to EN 61000-3-2/acc. to EN 61000-3-3/acc. to EN 61547/acc. to IEC 62471/acc. to VDE
PL-CUBE-AC -3000-840-G2	A	CE/acc. to EN 62031/acc. to EN 55015/acc. to EN 61000-3-2/acc. to EN 61000-3-3/acc. to EN 61547/acc. to IEC 62471/acc. to VDE

### Country specific categorizations

Product description
LEP-CUB-AC -830-G1
LEP-CUB-AC -840-G1
PL-CUBE-AC -2000-830-G2
PL-CUBE-AC -2000-840-G2
PL-CUBE-AC -3000-830-G2
PL-CUBE-AC -3000-840-G2

### Light Distribution

## Product family datasheet

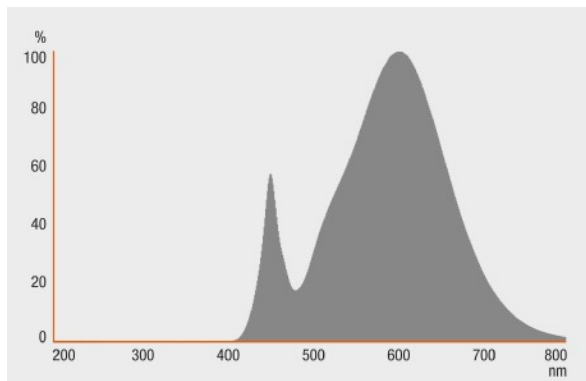

Spectral power distribution  
LEP-CUB-AC -830-G1 | PL-CUBE-AC -2000-830-G2 | PL-CUBE-AC -3000-830-G2

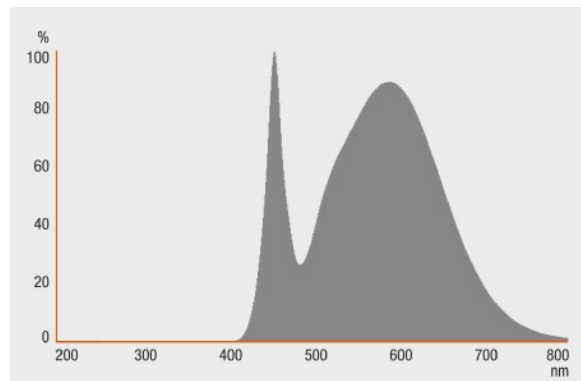

Spectral power distribution  
LEP-CUB-AC -840-G1 | PL-CUBE-AC -2000-840-G2 | PL-CUBE-AC -3000-840-G2

---

## Application advice

For more detailed application information and graphics please see product datasheet.





---

## Sales and Technical Support















Sales and Technical Support [www.osram.com](http://www.osram.com)

---

## Download Data

File	
	Product Family Datasheet LEP-CUB-AC-1100-8x0-G1 (GB)
	Brochures Technical application guide PrevaLED Cube AC light engine (GB)
	Certificates CB-certificate: PrevaLED Cube AC G1
	Declarations of conformity CE declaration of conformita: PrevaLED Cube AC G1
	CAD data PrevaLED Cube AC -X_T.x_t

## Product family datasheet

	CAD data 3-dim PrevaLED Cube AC - IGES
	CAD data 3-dim PrevaLED Cube AC - STEP.STEP
	Eulumdat PrevaLED Cube AC - LEP-AC-WM-830.LDT
	Eulumdat PrevaLED Cube AC - LEP-AC-WM-840
	Product Family Datasheet Family Datasheet: PrevaLED Cube AC G2
	Declarations of conformity EC-DoC PL-CUBE-AC-x000-8xx-230V-G2
	CAD data CAD PrevaLED Cube AC
	CAD data 3-dim CAD-Datei STEP: PrevaLED Cube AC G2
	CAD data 3-dim CAD-Data Parasolid: PrevaLED Cube AC G2
	CAD data 3-dim CAD-Datei IGES: PrevaLED Cube AC G2
	CAD data PDF CAD PrevaLED Cube AC 3D
	CAD data PDF CAD-Data 3D-PDF: PrevaLED Cube AC G2
	Eulumdat EULUMDAT: PrevaLED Cube AC G2
	CAD data CAD PrevaLED Cube AC Parasolid
	CAD data CAD PrevaLED Cube AC

## Logistical Data

Product code	Product description	Packaging unit (Pieces/Unit)	Dimensions (height x width x length)	Volume	Gross weight
4052899908611	LEP-CUB-AC -830-G1	Shipping carton box 20	- x - x -		
4052899908628	LEP-CUB-AC -840-G1	Shipping carton box 20	- x - x -		
4052899909496	PL-CUBE-AC -2000-830-G2	Shipping carton box 20	- x - x -		



## Product family datasheet

---

4052899909502	PL-CUBE-AC - 2000-840-G2	Shipping carton box 20	- x - x -
4052899909557	PL-CUBE-AC - 3000-830-G2	Shipping carton box 20	- x - x -
4052899909564	PL-CUBE-AC - 3000-840-G2	Shipping carton box 20	- x - x -

---

The mentioned product code describes the smallest quantity unit which can be ordered. One shipping unit can contain one or more single products. When placing an order, for the quantity please enter single or multiples of a shipping unit.

---

### Disclaimer

---

Subject to change without notice. Errors and omission excepted. Always make sure to use the most recent release.

## X-ON Electronics

Largest Supplier of Electrical and Electronic Components

*Click to view similar products for [osram](#) manufacturer:*

Other Similar products are found below :

[LS E65B-V1AB-1-1-50-R33-Z](#) [LO L296-Q2S1-24-Z](#) [IPD2131-27](#) [GW PSLPS1.EC-KSKU-5R8T-1](#) [418962A](#) [LCW JNSH.PC-CPCR-5H7I-1](#)  
[LE RTDUW S2W](#) [LT A67C-S2U1-35](#) [4052899958142](#) [4052899958173](#) [4052899971028](#) [BPW 34 FASR](#) [BPW 34 FSR](#) [BPW 34 SR](#) [LT](#)  
[A67C-T2V1-35](#) [GY CSHPM1.23-KQKS-36-0](#) [KW H5L531.TE-Z7R7-EBVFFCBB46-RS5R](#) [4058075097421](#) [79675](#) [79632](#) [OT 40/220-](#)  
[240/24 DIM P](#) [OT 60/220-240/24 DIM P](#) [OT 100/220-240/24 DIM P](#) [OT FIT 45/220-240/200 D L](#) [KW2 HIL532.TK-D2D9-4L07M0-SC6B](#)  
[LW TWTG.BB-BXCX-2B2C-1](#) [LA E6SF-BBCB-24-1-Z](#) [HDSP2112S](#) [LY E6SF-AABA-46-1-Z](#) [64760](#) [SFH 4715A-CBDA](#) [4058075097360](#)  
[4058075097544](#) [47659](#) [OT 6/200-240/24 CE](#) [OT FIT 35/220-240/350 D CS L](#) [OT FIT 8/220-240/180 CS S MINI](#) [64150ULT](#) [79366](#)  
[4052899917583](#) [4058075819658](#) [GW CSSRM2.PM-N3N5-XX51-1](#) [ELEMENT 90/220-240/24](#) [OT 40/220-240/24 P](#) [OT 60/220-240/24 P](#)  
[ELEMENT 6/220-240/150 S](#) [64210CBI](#) [LY E67F-ABBB-46-1-Z](#) [LS T670-J1K2-1-Z](#) [LO L29K-H2L1-24-Z](#)