

Dual IGBT NFH-Series Module 150 Amperes/1200 Volts

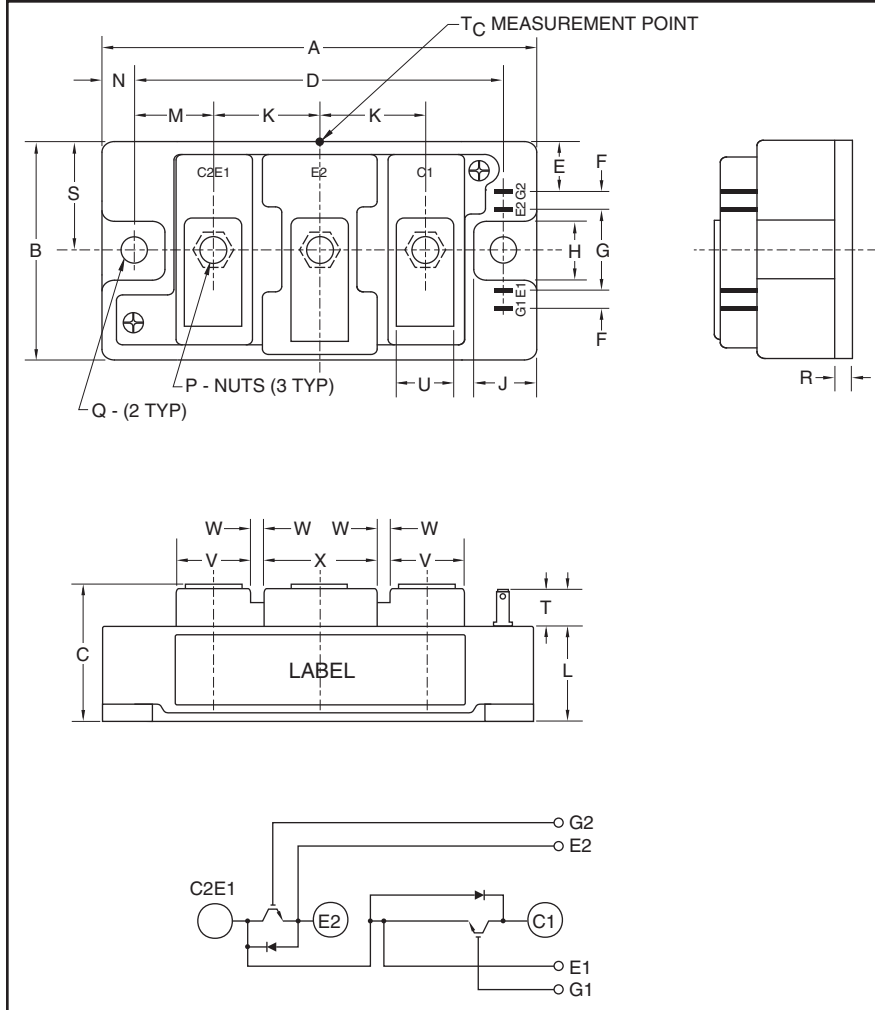

Outline Drawing and Circuit Diagram

Dimensions	Inches	Millimeters
A	3.70	94.0
B	1.89	48.0
C	1.18+0.04/-0.01	30.0+1.0/-0.5
D	3.15±0.01	80.0±0.25
E	0.43	11.0
F	0.16	4.0
G	0.71	18.0
H	0.51	13.0
J	0.53	13.5
K	0.91	23.0
L	0.83	21.2

Dimensions	Inches	Millimeters
M	0.67	17.0
N	0.28	7.0
P	M5 Metric	M5
Q	0.26 Dia.	Dia. 6.5
R	0.02	4.0
S	0.94	24.0
T	0.3	7.5
U	0.47	12.0
V	0.63	16.0
W	0.1	2.5
X	0.98	25.0

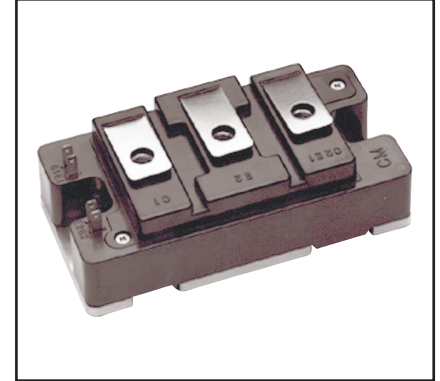

Description:

Powerex IGBT Modules are designed for use in high frequency applications; 30 kHz for hard switching applications and 60 to 70 kHz for soft switching applications. Each module consists of two IGBT Transistors in a half-bridge configuration with each transistor having a reverse-connected super-fast recovery free-wheel diode. All components and interconnects are isolated from the heat sinking baseplate, offering simplified system assembly and thermal management.

Features:

- Low ESW(off)
- Discrete Super-Fast Recovery Free-Wheel Diode
- Isolated Baseplate for Easy Heat Sinking

Applications:

- Power Supplies
- Induction Heating
- Welders

Ordering Information:

Example: Select the complete part module number you desire from the table below -i.e. CM150DU-24NFH is a 1200V (V_{CEs}), 150 Ampere Dual IGBT Power Module.

Type	Current Rating Amperes	V _{CEs} Volts (x 50)
CM	150	24



Powerex, Inc., 173 Pavilion Lane, Youngwood, Pennsylvania 15697 (724) 925-7272 www.pwr.com

CM150DU-24NFH
Dual IGBT NFH-Series Module
 150 Amperes/1200 Volts

Absolute Maximum Ratings, $T_j = 25^\circ\text{C}$ unless otherwise specified

Ratings	Symbol	CM150DU-24NF	Units
Collector-Emitter Voltage (G-E Short)	V_{CES}	1200	Volts
Gate-Emitter Voltage (C-E Short)	V_{GES}	± 20	Volts
Collector Current (Operation) ^{*2}	I_C	150	Amperes
Peak Collector Current (Pulse) ^{*2}	I_{CM}	300	Amperes
Emitter Current (Operation) ^{*2}	I_E^{*1}	150	Amperes
Peak Emitter Current (Pulse) ^{*2}	I_{EM}^{*1}	300	Amperes
Maximum Collector Dissipation ($T_C = 25^\circ\text{C}$)	P_C^{*3}	650	Watts
Maximum Collector Dissipation ($T_C = 25^\circ\text{C}$) ^{*7}	P_C^{*3}	960	Watts
Junction Temperature	T_j	-40 ~ +150	$^\circ\text{C}$
Storage Temperature	T_{stg}	-40 ~ +125	$^\circ\text{C}$
Isolation Voltage (Terminals to Baseplate, f = 60Hz, AC 1 Minute)	V_{ISO}	2500	Volts
Mounting Torque, M5 Main Terminal	—	30	in-lb
Mounting Torque, M6 Mounting	—	40	in-lb
Weight	—	310	Grams

Electrical Characteristics, $T_j = 25^\circ\text{C}$ unless otherwise specified

Characteristics	Symbol	Test Conditions	Min.	Typ.	Max.	Units
Collector-Cutoff Current	I_{CES}	$V_{CE} = V_{CES}, V_{GE} = 0V$	—	—	1.0	mA
Gate-Emitter Threshold Voltage	$V_{GE(th)}$	$I_C = 15mA, V_{CE} = 10V$	4.5	6.0	7.5	Volts
Gate Leakage Current	I_{GES}	$\pm V_{GE} = V_{GES}, V_{CE} = 0V$	—	—	0.5	μA
Collector-Emitter Saturation Voltage	$V_{CE(sat)}$	$I_C = 150A, V_{GE} = 15V, T_j = 25^\circ\text{C}$	—	5.0	6.5	Volts
		$I_C = 150A, V_{GE} = 15V, T_j = 125^\circ\text{C}$	—	5.0	—	Volts
Input Capacitance	C_{ies}		—	—	24	nf
Output Capacitance	C_{oes}	$V_{CE} = 10V, V_{GE} = 0V$	—	—	2.0	nf
Reverse Transfer Capacitance	C_{res}		—	—	0.45	nf
Total Gate Charge	Q_G	$V_{CC} = 600V, I_C = 150A, V_{GE} = 15V$	—	680	—	nC
Turn-on Delay Time	$t_{d(on)}$		—	—	150	ns
Turn-on Rise Time	t_r	$V_{CC} = 600V, I_C = 150A,$	—	—	80	ns
Turn-off Delay Time	$t_{d(off)}$	$V_{GE} = \pm 15V, R_G = 2.1\Omega,$	—	—	400	ns
Turn-off Fall Time	t_f	Inductive Load,	—	—	150	ns
Diode Reverse Recovery Time	t_{rr}^{*1}	$I_E = 150A$	—	—	150	ns
Diode Reverse Recovery Charge	Q_{rr}^{*1}		—	7.5	—	μC
Emitter-Collector Voltage	V_{EC}^{*1}	$I_E = 150A, V_{GE} = 0V$	—	—	3.5	Volts

*1 Represent ratings and characteristics of the anti-parallel, emitter-to-collector free wheeling diode (FWDI).

*2 Pulse width and repetition rate should be such that device junction temperature (T_j) does not exceed $T_{j(max)}$ rating.

*3 Junction temperature (T_j) should not increase beyond maximum junction temperature ($T_{j(max)}$) rating.

*7 Case temperature (T_C) measured point is just under the chips.

CM150DU-24NFH
Dual IGBT NFH-Series Module
 150 Amperes/1200 Volts

Thermal and Mechanical Characteristics, $T_j = 25\text{ }^\circ\text{C}$ unless otherwise specified

Characteristics	Symbol	Test Conditions	Min.	Typ.	Max.	Units
Thermal Resistance ^{*4} Junction to Case	$R_{th(j-c)Q}$	Per IGBT 1/2 Module	—	—	0.19	K/W
Thermal Resistance ^{*4} Junction to Case	$R_{th(j-c)D}$	Per FWDi 1/2 Module	—	—	0.35	K/W
Contact Thermal Resistance ^{*5} Case to Heatsink	$R_{th(c-f)}$	Per 1/2 Module, Thermal Grease Applied	—	0.07	—	K/W
Thermal Resistance ^{*7} Junction to Case	$R_{th(j-c)'Q}$	Per IGBT 1/2 Module	—	—	0.13 ^{*6}	K/W
Thermal Resistance ^{*7} Junction to Case	$R_{th(j-c)'D}$	Per FWDi 1/2 Module	—	—	0.21 ^{*6}	K/W
External Gate Resistance	R_G		2.1	—	21	Ω

*4 Case temperature (T_C) measured point is shown on page 1 of the outline drawing.
 *5 Typical value is measured by using thermally conductive grease of $\lambda = 0.9\text{ [W/(m}\cdot\text{K)]}$.
 *6 If you use this value, $R_{th(f-a)}$ should be measured just under the chips.
 *7 Case temperature (T_C) measured point is just under the chips.

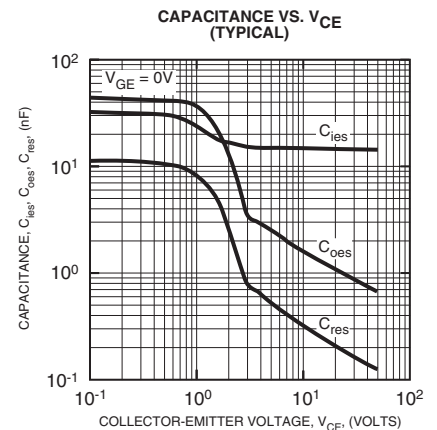
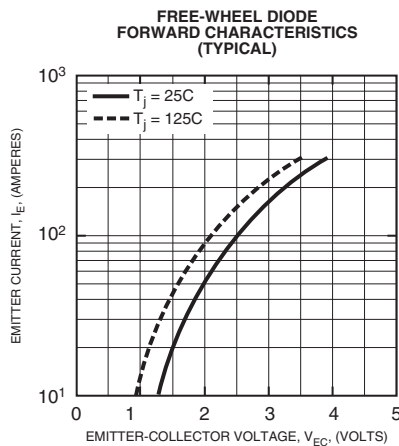
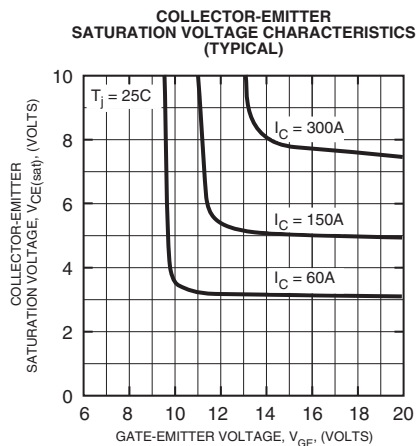
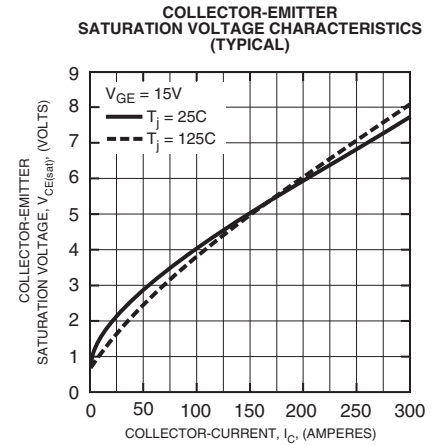
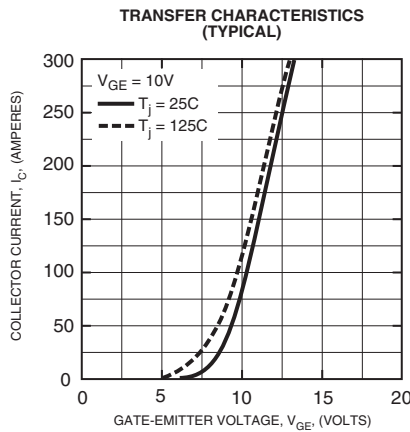
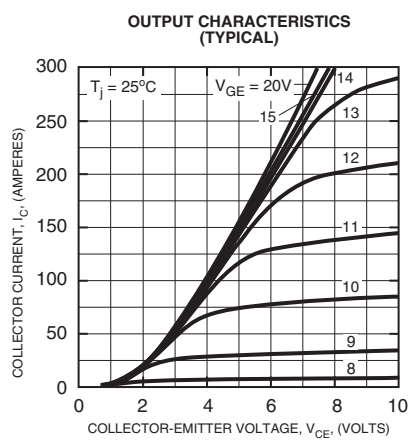



CM150DU-24NFH
Dual IGBT NFH-Series Module
 150 Amperes/1200 Volts

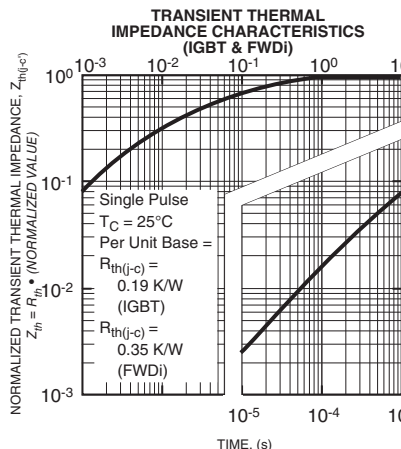
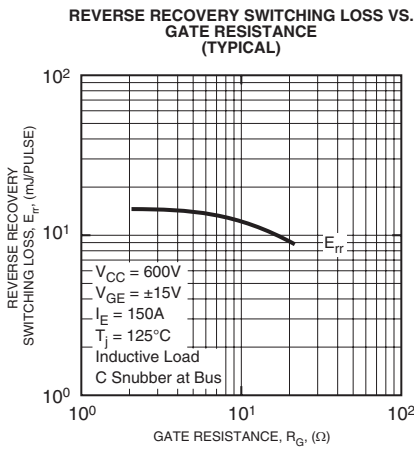
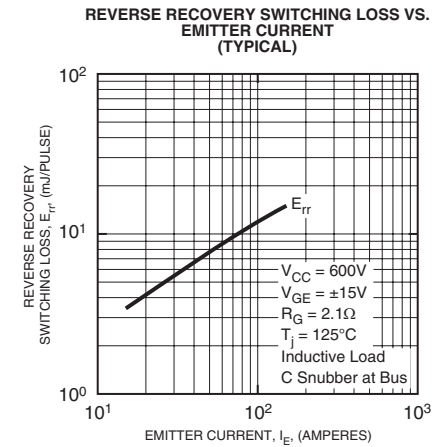
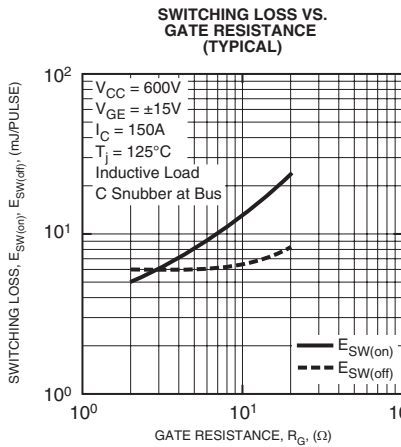
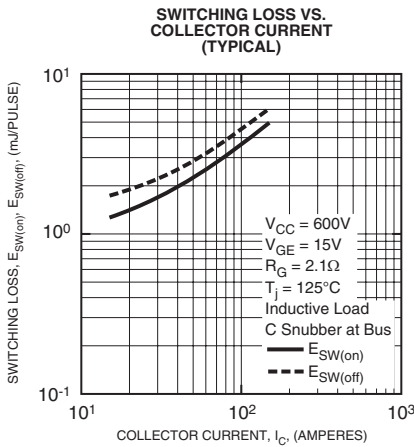
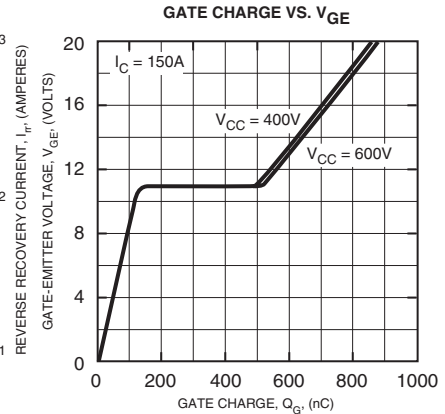
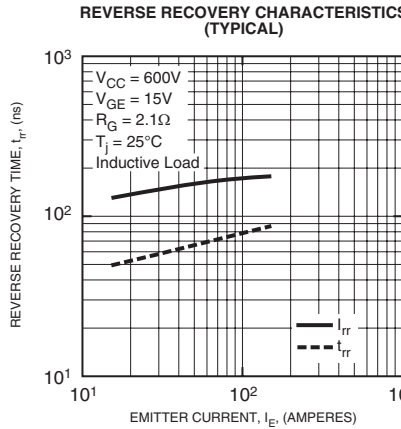
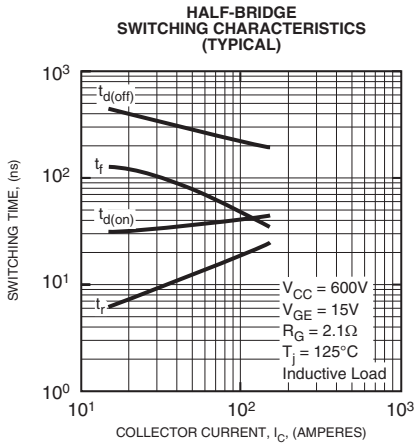

X-ON Electronics

Largest Supplier of Electrical and Electronic Components

Click to view similar products for [powerex manufacturer](#):

Other Similar products are found below :

[R7013003XXUA](#) [R9G01212XX](#) [VLA541-01R](#) [QRD0630T30](#) [CM400DY-24NF](#) [CM100TX-24S1](#) [CM600HA-24A](#) [NLD422PB](#)
[PSM03S93E5-A](#) [BP2B-V](#) [ND431625](#) [R5031213LSWS](#) [BG2B](#) [BG2C-5015](#) [ND431825](#) [T9G0121203DH](#) [CD611616C](#) [BG1A-PX](#)
[TCS4402802DH](#) [CD421690C](#) [PM600DVA060](#) [CD411899C](#) [CD631615B](#) [C601PB](#) [R5021213LSWS](#) [BG2A-NFH](#) [C180PB](#) [CD431690B](#)
[NLR425CM](#) [HARDWARE KIT 50](#) [CD410899C](#) [CM400HA-24A](#) [CD411699C](#) [LEAD KIT #NK](#) [HARDWARE KIT 49](#) [VLA500-01](#)
[HARDWARE KIT 87](#) [VLA106-24154](#) [VLA502-01](#) [VLA106-15242](#)