

# Cree® PLCC4 3 in 1 SMD LED

## CLV1A-FKB

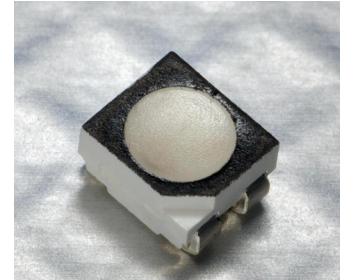

### PRODUCT DESCRIPTION

Cree PLCC full-color LEDs offer high-intensity light output and a wide viewing angle in an industry-standard package. Designed to work in a wide array of environmental conditions, Cree PLCC full-color LEDs are suited for indoor video screen, decorative lighting and amusement applications.

### FEATURES

- Size (mm): 3.2 x 2.8
- Dominant Wavelength:  
Red (619 - 624nm)  
Green (520 - 535nm)  
Blue (460 - 475nm)
- Luminous Intensity (mcd)  
Red (505 - 1010)  
Green (900 - 2240)  
Blue (224 - 450)
- Moisture Sensitivity Level: 5a
- Lead-Free
- RoHS Compliant

### APPLICATIONS

- Full-Color Video Screen
- Decorative lighting
- Amusement

### ABSOLUTE MAXIMUM RATINGS ( $T_A = 25^\circ\text{C}$ )

Items	Symbol	Absolute Maximum Rating			Unit
		R	G	B	
Forward Current <sup>Note 1</sup>	$I_F$	50	25	25	mA
Peak Forward Current <sup>Note 2</sup>	$I_{FP}$	200	100	100	mA
Reverse Voltage	$V_R$	5	5	5	V
Power Dissipation	$P_D$	130	100	100	mW
Operation Temperature	$T_{opr}$	-40 ~ +85			$^\circ\text{C}$
Storage Temperature	$T_{stg}$	-40 ~ +100			$^\circ\text{C}$
Junction Temperature	$T_J$	110	110	110	$^\circ\text{C}$
Junction/ambient 1 chip on	$R_{THJA}$	450	400	450	$^\circ\text{C}/\text{W}$
Junction/ambient 3 chips on	$R_{THJA}$	650	580	680	$^\circ\text{C}/\text{W}$
Junction/solder point 1 chip on	$R_{THJS}$	300	280	300	$^\circ\text{C}/\text{W}$
Junction/solder point 3 chips on	$R_{THJS}$	450	430	480	$^\circ\text{C}/\text{W}$

**Note:** 1.Single-color light.  
2.Pulse width  $\leq 0.1$  msec, duty  $\leq 1/10$ .

### TYPICAL ELECTRICAL & OPTICAL CHARACTERISTICS ( $T_A = 25^\circ\text{C}$ )

Characteristics	Condition	Symbol	Values			Unit
			R	G	B	
Dominant Wavelength	$I_F = 20$ mA	$\lambda_{DOM}$	619~624	520~535	460~475	nm
Spectral bandwidth at 50% $I_{REL}$ max	$I_F = 20$ mA	$\Delta \lambda$	24	38	28	nm
Forward Voltage	$I_F = 20$ mA	$V_{F(avg)}$	2.0	3.2	3.2	V
		$V_{F(max)}$	2.6	4.0	4.0	V
Luminous Intensity	$I_F = 20$ mA	$I_{V(min)}$	505	900	224	mcd
		$I_{V(avg)}$	710	1450	310	mcd
Reverse Current (max)	$V_R = 5$ V	$I_R$	10	10	10	$\mu\text{A}$

### INTENSITY BIN LIMIT ( $I_F = 20 \text{ mA}$ )

#### Red

Bin Code	Min.(mcd)	Max.(mcd)
km	505	635
K	560	710
np	635	805
M	710	900
qr	805	1010

#### Green

Bin Code	Min.(mcd)	Max.(mcd)
N	900	1120
st	1010	1260
P	1120	1400
vw	1260	1600
Q	1400	1800
xy	1600	2020
R	1800	2240

#### Blue

Bin Code	Min.(mcd)	Max.(mcd)
F	224	280
de	252	318
G	280	355
fg	318	403
H	355	450

Tolerance of measurement of luminous intensity is  $\pm 10\%$ .

### COLOR BIN LIMIT ( $I_F = 20 \text{ mA}$ )

#### Red

Bin Code	Min.(nm)	Max.(nm)
RB	619	624

#### Green

Bin Code	Min.(nm)	Max.(nm)
G7	520	525
G23	522.5	527.5
G8	525	530
G45	527.5	532.5
G9	530	535

#### Blue

Bin Code	Min.(nm)	Max.(nm)
B3	460	465
B23	462.5	467.5
B4	465	470
B45	467.5	472.5
B5	470	475

Tolerance of measurement of dominant wavelength is  $\pm 1 \text{ nm}$ .

**ORDER CODE TABLE\***

Kit Number	Color	Luminous Intensity (mcd)		Dominant Wavelength (nm)				Package
		Min.	Max.	Color Bin	Min. (nm)	Color Bin	Max. (nm)	
CLV1A-FKB-CkmqrNRFHBB79353	Red	505	1010	RB	619	RB	624	Reel
	Green	900	2240	G7	520	G9	535	Reel
	Blue	224	450	B3	460	B5	475	Reel
CLV1A-FKB-Ckm1P1F1BB7C3C3	Red	Any 1 Intensity bin from km(505) - qr(1010)		RB	619	RB	624	Reel
	Green	Any 1 Intensity bin from P(1120) - R(2240)		Any 1 hue bin from G7(520) - G9(535)				Reel
	Blue	Any 1 Intensity bin from F(224) - H(450)		Any 1 hue bin from B3(460) - B5(475)				Reel
CLV1A-FKB-CK1vw1de1BB7C3C3	Red	Any 1 Intensity bin from K(560) - qr(1010)		RB	619	RB	624	Reel
	Green	Any 1 Intensity bin from vw(1260) - R(2240)		Any 1 hue bin from G7(520) - G9(535)				Reel
	Blue	Any 1 Intensity bin from de(252) - H(450)		Any 1 hue bin from B3(460) - B5(475)				Reel

Notes:

1. The above kit numbers represent the order codes which include multiple intensity-bin and color-bin codes. Only one intensity-bin code and one color-bin code will be shipped on each reel. Single intensity-bin code and single color-bin code will be orderable in certain quantities. For example, any 1 intensity bin from P - R means only 1 intensity bin (P or vw or Q or xy or R) will be shipped by Cree. For example, any 1 color bin from G7 - G9 means only 1 color bin (G7 or G23 or G8 or G45 or G9) will be shipped by Cree.
2. Please refer to the "Cree LED Lamp Reliability Test Standards" document for reliability test conditions.
3. Please refer to the "Cree LED Lamp Soldering & Handling" document for information about how to use this LED product safely.

## GRAPHS

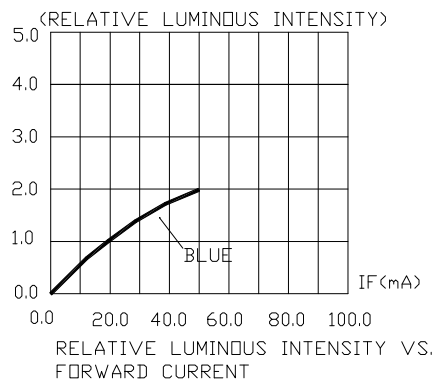
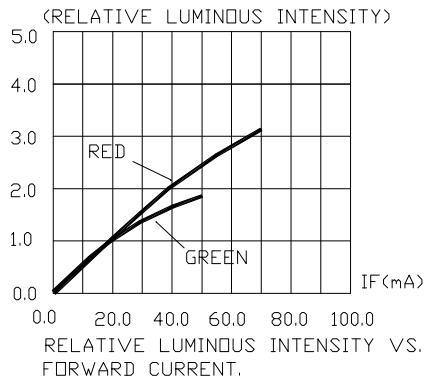
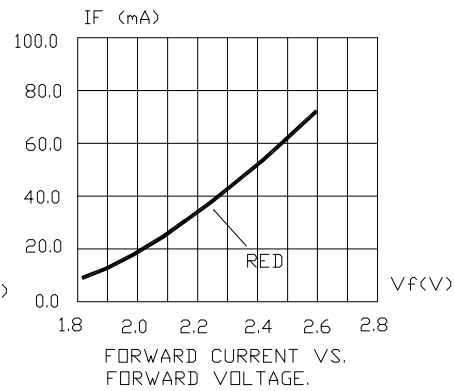
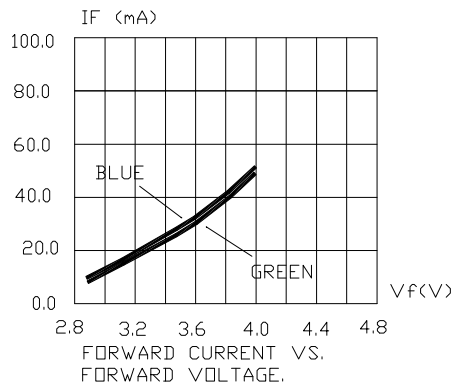
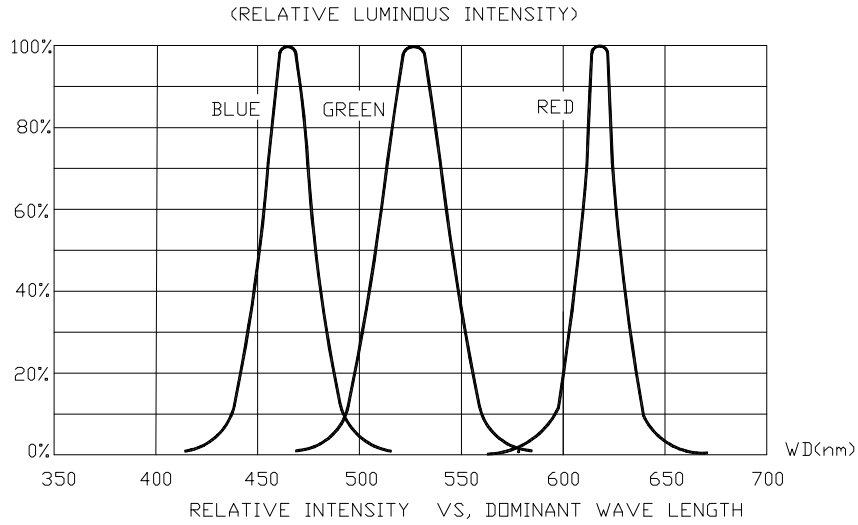

The above data are collected from statistical figures that do not necessarily correspond to the actual parameters of each single LED. Hence, these data will be changed without further notice.

## GRAPHS

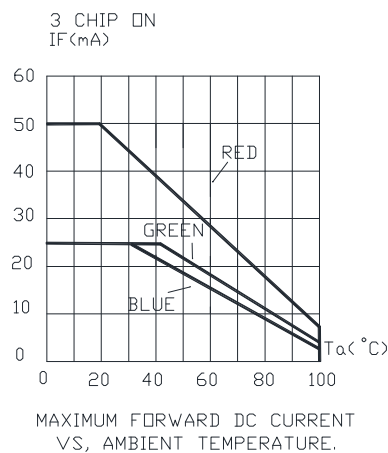
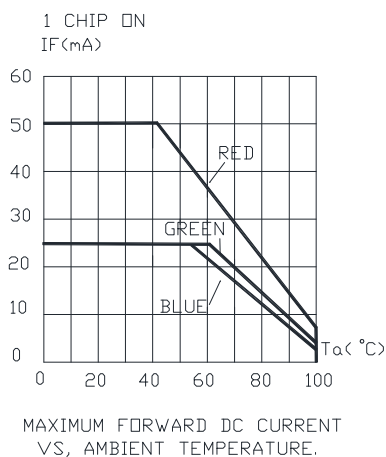
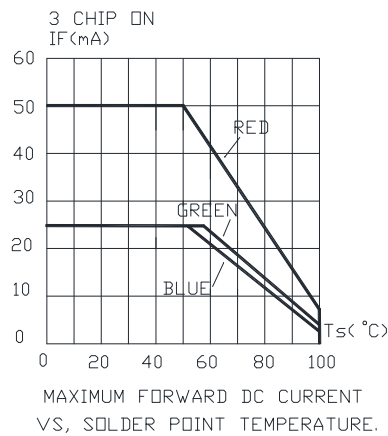
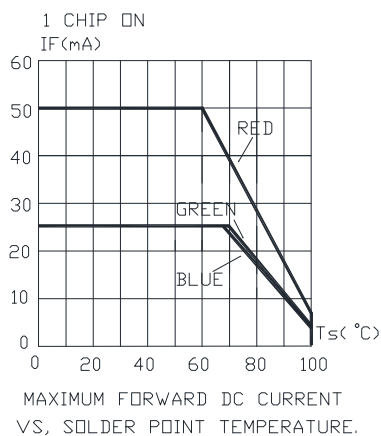
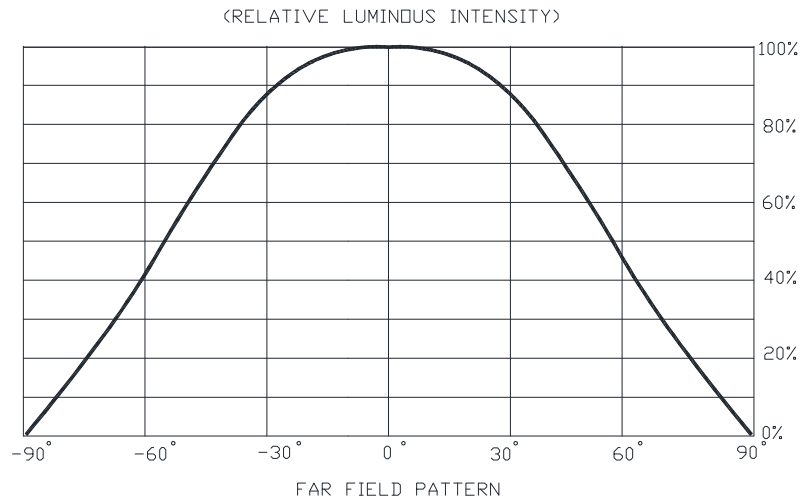

The above data are collected from statistical figures that do not necessarily correspond to the actual parameters of each single LED. Hence, these data will be changed without further notice.

## MECHANICAL DIMENSIONS

All dimensions are in mm.

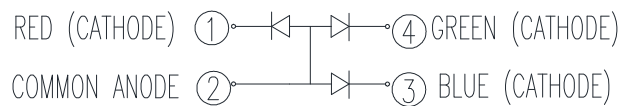
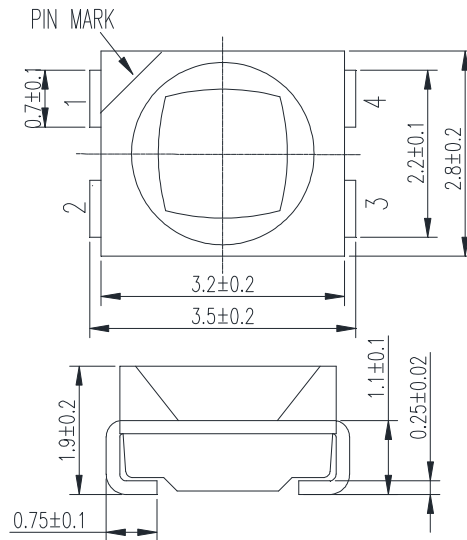

## NOTES

### RoHS Compliance

The levels of environmentally sensitive, persistent biologically toxic (PBT), persistent organic pollutants (POP), or otherwise restricted materials in this product are below the maximum concentration values (also referred to as the threshold limits) permitted for such substances, or are used in an exempted application, in accordance with EU Directive 2002/95/EC on the restriction of the use of certain hazardous substances in electrical and electronic equipment (RoHS), as amended through April 21, 2006.

### Vision Advisory Claim

Users should be cautioned not to stare at the light of this LED product. The bright light can damage the eye.

## KIT NUMBER SYSTEM

Cree LED lamps are tested and sorted into performance bins. A bin is specified by ranges of color, forward voltage, and brightness. Sorted LEDs are packaged for shipping in various convenient options. Please refer to the "Cree LED Lamp Packaging Standard" document for more information about shipping and packaging options.

Cree LEDs are sold by order codes in combinations of bins called kits. Order codes are configured in the following manner:

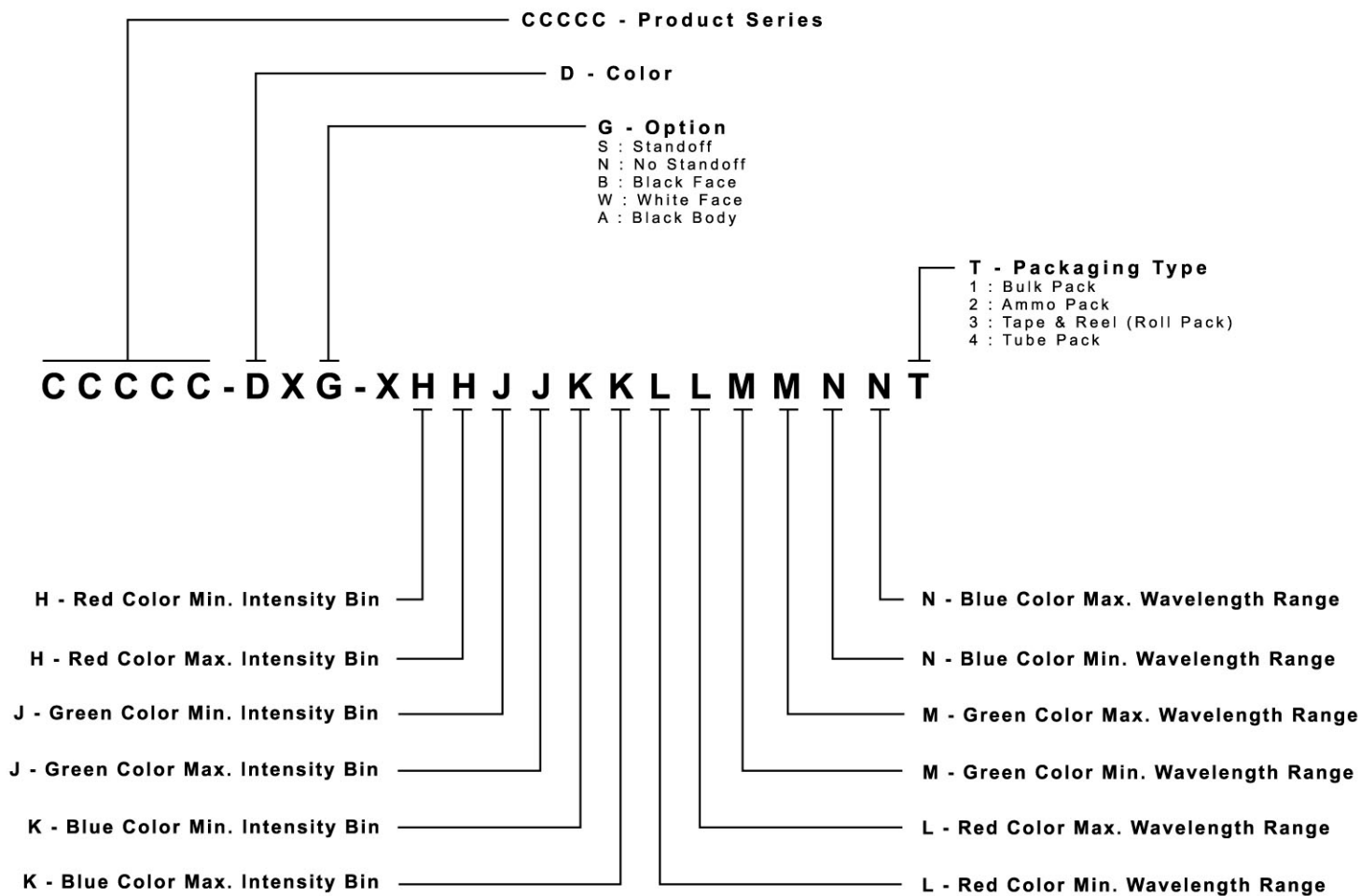



## PACKAGING

- The CLV1A-FKB is rated as a MSL 5a product.
- The boxes are not water resistant and they must be kept away from water and moisture.
- The LEDs are packed in cardboard boxes after packaging in normal or anti-electrostatic bags.
- Cardboard boxes will be used to protect the LEDs from mechanical shocks during transportation.
- The reel pack is applied in SMD LED.
- Max 2000 pcs per reel.

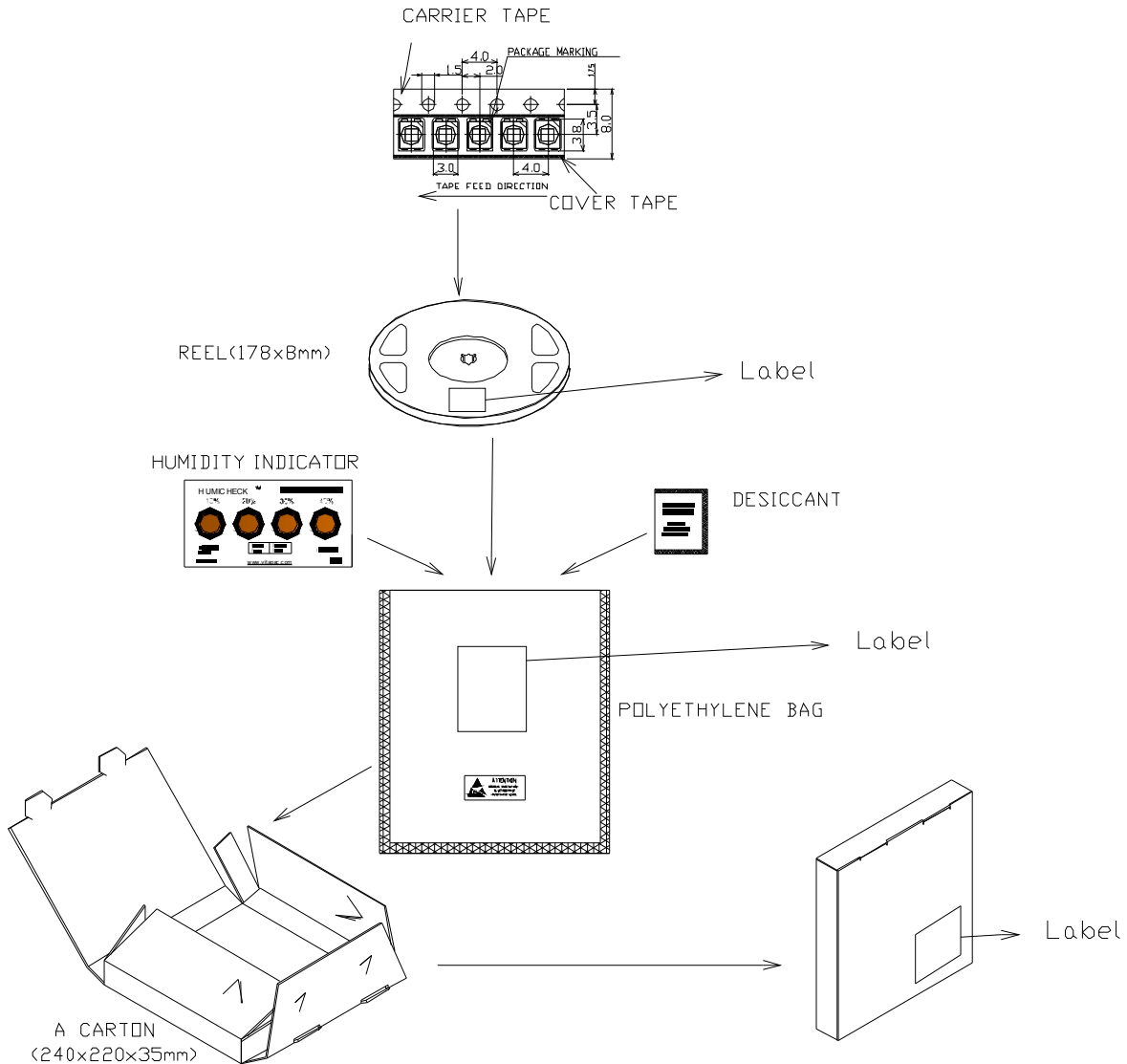

## X-ON Electronics

Largest Supplier of Electrical and Electronic Components

*Click to view similar products for [Standard LEDs - SMD category](#):*

*Click to view products by [Cree manufacturer](#):*

Other Similar products are found below :

[LTST-C19GD2WT](#) [LTST-N683GBEW](#) [597-3006-607F](#) [597-3403-607F](#) [LTW-K140SZR40](#) [LTW-M140ZVS](#) [598-8110-100F](#) [598-8170-100F](#)  
[598-8610-202F](#) [7012X7](#) [AAAF5060QBFSEEZGS](#) [12-22SURSYGC/S530-A3/E2/TR8](#) [1383SURT/S530-A3/TR1\(R\)](#) [APT1608QGW](#)  
[EASV1803BA0](#) [SML310BATT86](#) [SML-512VWT86A](#) [SML-LX0606SISUGC/A](#) [SML-LXL1307SRC-TR](#) [SML-LXR851SIUPGUBC](#)  
[LT1ED53A](#) [17-21/G6C-FM1N2B/3T](#) [FAT801-S](#) [SSL-LXA227IC-TR31A](#) [AM27ZGC03](#) [APB3025SGNC](#) [APHK1608VGCA](#) [APT2012QGW](#)  
[CLMVC-FKA-CA1E1L81BB7C3C3](#) [CLYBA-FKA-CFHHL9BBB7A363](#) [CMD11504UR](#) [LTW-020ZDCG](#) [LTW-21TS5](#) [LTW-K140SZR30](#)  
[HSMY-C177](#) [UYGT801-S](#) [KVH1C100MF6R](#) [42-21SYGC/S530-E1/TR8](#) [YGFR411-H](#) [597-2311-402F](#) [597-2712-602F](#) [5973212407NF](#)  
[597-3302-607F](#) [597-5202-407F](#) [598-8330-117F](#) [SAW8WA2A-L35M40-CA](#) [SML013WBDW1](#) [SML-LX0402IC-TR](#) [CLMVC-FKA-](#)  
[CLBDGL7LBB79353](#) [VLMKG3400-GS08](#)