

Connectors according to DIN 41612 / IEC 60603-2

Type R

Female connector

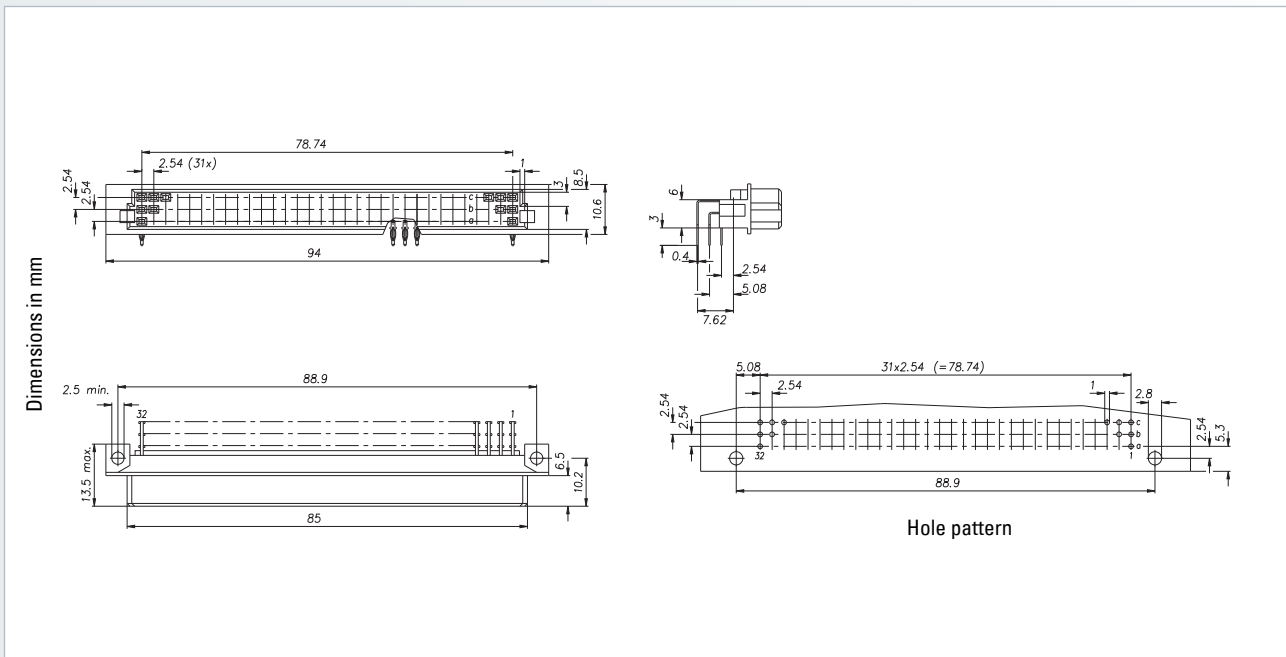

No. of contacts	Contact arrangement	Press-fit technology – Performance level II
		Termination length
		Part number
64		116-60054
96		116-60074

Accessories

- Press-fit tool (see page 210)
- Support tool (see page 211)

On request

- Performance levels I + III or customer-specific
- Special contact length

Options

- Without flange
- Contact arrangement (see page 162)

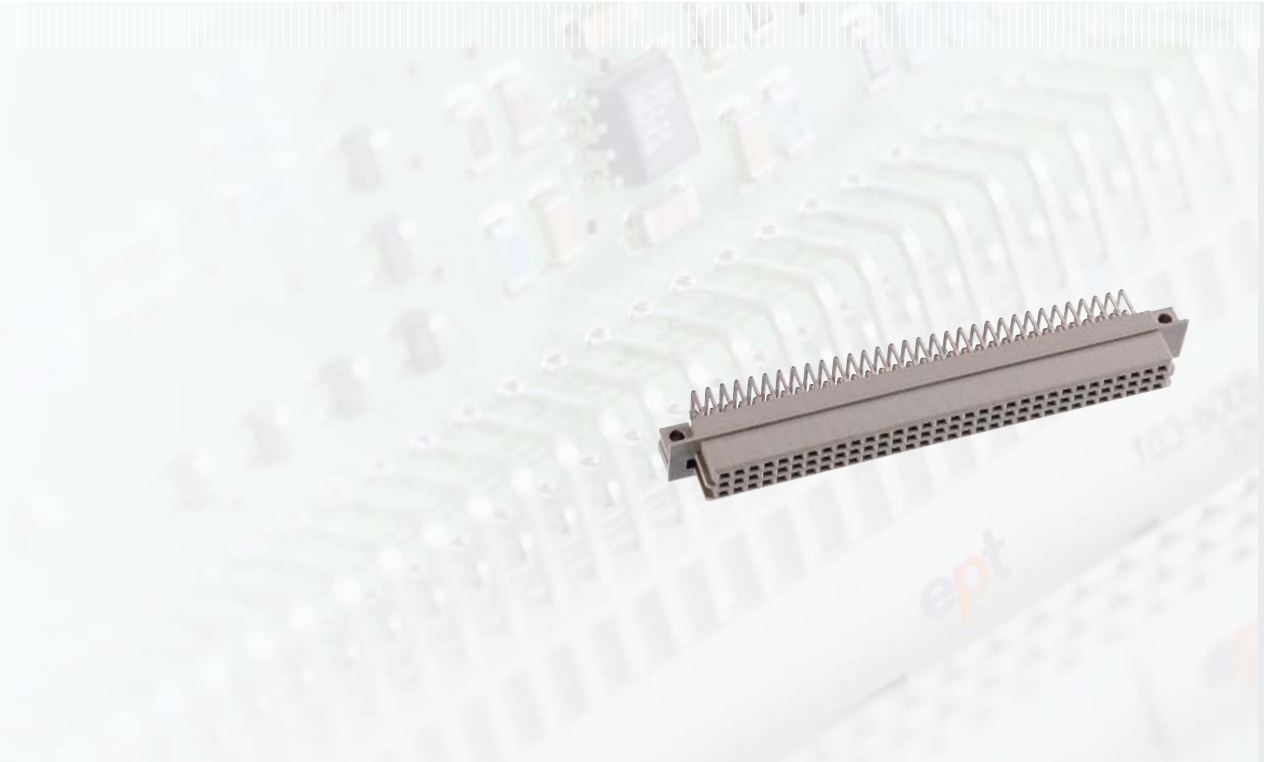

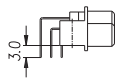
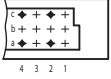
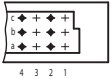
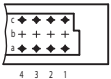
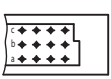
No. of contacts	Contact arrangement	Solder technology – Performance level II	
		Termination length	
			
		Part number	
32		116-40034	
48		116-40044	
64		116-40054	
96		116-40074	

On request

- Performance levels I + III or customer-specific
- Special contact length
- Also in THTR

Options

- Board lock (see page 159)
- Contact arrangement (see page 162)

X-ON Electronics

Largest Supplier of Electrical and Electronic Components

Click to view similar products for [FFC & FPC Connectors](#) category:

Click to view products by [EPT manufacturer](#):

Other Similar products are found below :

[HFW11R-1STE1H1LF](#) [FH29B-100S-0.2SHW\(99\)](#) [FA5S008HP1](#) [FH29B-120S-0.2SHW\(99\)](#) [FH29B-80S-0.2SHW\(99\)](#) [FHS-16](#) [FPH-2022G](#)
[52610-1075](#) [52610-1275](#) [52610-1934](#) [XF3M\(1\)-1415-1B-R100](#) [501864-3091-TR225](#) [0525594033](#) [086210010340800](#) [086222026001800](#)
[52271-2869-CUT-TAPE](#) [62674-201121DLF](#) [62684-36210E9ALF](#) [52610-1675](#) [52746-1671-TR250](#) [10051922-2810EHLF](#) [6-520415-9](#)
[BD021-09A-A1-0350-0200-0550-LD](#) [SFV6R-1STE9HLF](#) [XF3M-2915-1B-R100](#) [1658549-1](#) [62674-221121ALF](#) [46214008010800](#)
[046298003000883](#) [151660622](#) [842-816-2630-035](#) [AYF530665TA](#) [AYF351525](#) [046296011930846+](#) [AYF352325A](#) [046254020000800+](#)
[FH19C-13S-0.5SH\(99\)](#) [FH39J-51S-0.3SHW\(99\)](#) [AYF355125A](#) [AYF530365TA](#) [FH29B-44S-0.2SHW\(99\)](#) [SFW5R-2STAE9LF](#) [AYF351125A](#)
[AYF350725A](#) [62684-502100AHLF](#) [FH39-61S-0.3SHW\(99\)](#) [AYF414035A](#) [10064555-172520HLF](#) [AYF212335A](#) [504754-2500](#)