

Part Number: L-7113SF6C

Features

- Mechanically and spectrally matched to the phototransistor.
- RoHS compliant.

Description

SF6 Made with Gallium Aluminum Arsenide Infrared Emitting diodes.

Package Dimensions

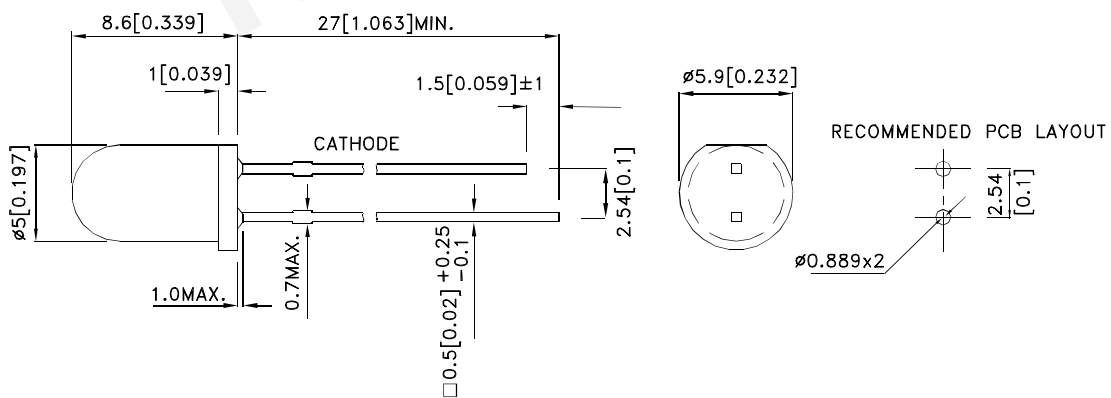

Notes:

1. All dimensions are in millimeters (inches).
2. Tolerance is ± 0.25 (0.01") unless otherwise noted.
3. Lead spacing is measured where the leads emerge from the package.
4. The specifications, characteristics and technical data described in the datasheet are subject to change without prior notice.



Selection Guide

Part No.	Emitting Color (Material)	Lens Type	Po (mW/sr) [2] @ 20mA		Po (mW/sr) [2] @ 50mA		Viewing Angle [1]
			Min.	Typ.	Min.	Typ.	2 θ 1/2
L-7113SF6C	Infrared (GaAlAs)	Water Clear	18	40	55	100	20°

Notes:

1. θ 1 / 2 is the angle from optical centerline where the luminous intensity is 1 / 2 of the optical peak value.
2. Radiant Intensity / luminous flux: +/-15%.
3. Radiant intensity value is traceable to the CIE127-2007 compliant national standards.

Electrical / Optical Characteristics at TA=25°C

Parameter	P/N	Symbol	Typ.	Max.	Units	Test Conditions
Forward Voltage [1]	SF6	V _F	1.35	1.6	V	I _F =20mA
Reverse Current	SF6	I _R		10	uA	V _R = 5V
Capacitance	SF6	C	30		pF	V _F =0V;f=1MHz
Peak Spectral Wavelength	SF6	λ _P	860		nm	I _F =20mA
Spectral Bandwidth	SF6	$\Delta\lambda$ 1/2	50		nm	I _F =20mA

Notes:

1. Forward Voltage: + / -0.1V.
2. Wavelength value is traceable to the CIE127-2007 compliant national standards.
3. Excess driving current and/or operating temperature higher than recommended conditions may result in severe light degradation or premature failure.

Absolute Maximum Ratings at TA=25°C

Parameter	Symbol	Values	Units
Power dissipation	P _D	80	mW
DC Forward Current	I _F	50	mA
Peak Forward Current [1]	i _{FS}	1	A
Reverse Voltage	V _R	5	V
Operating Temperature	T _A	-40 To +85	°C
Storage Temperature	T _{STG}	-40 To +85	°C
Lead Solder Temperature [2]		260°C For 3 Seconds	
Lead Solder Temperature [3]		260°C For 5 Seconds	

Notes:

1. 1 / 100 Duty Cycle, 10 μ s Pulse Width.
2. 2mm below package base.
3. 5mm below package base.

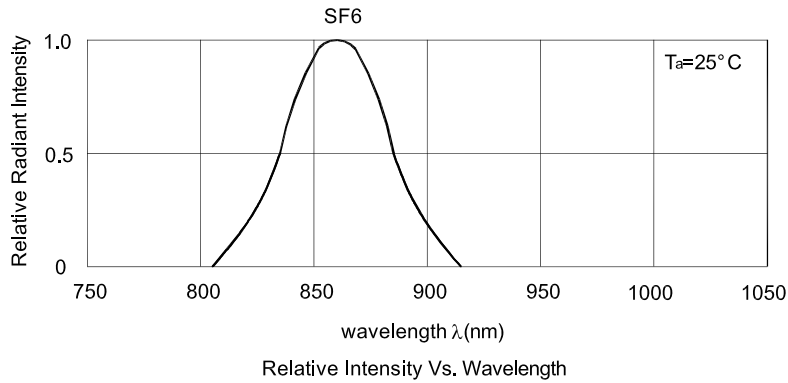

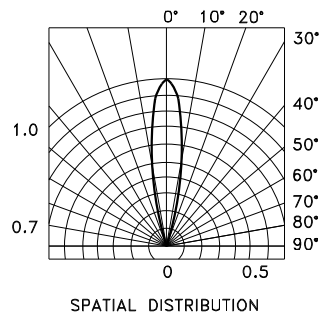
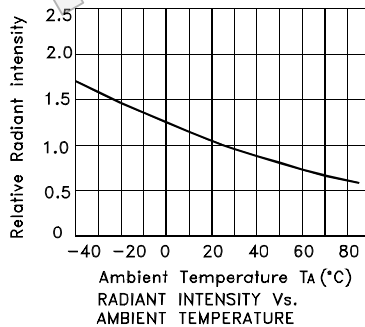
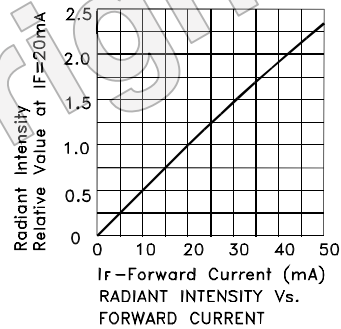
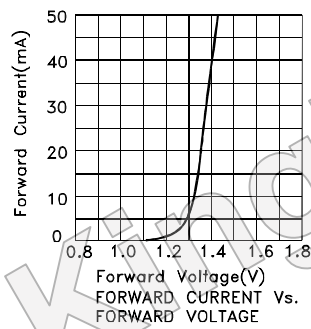

L-7113SF6C

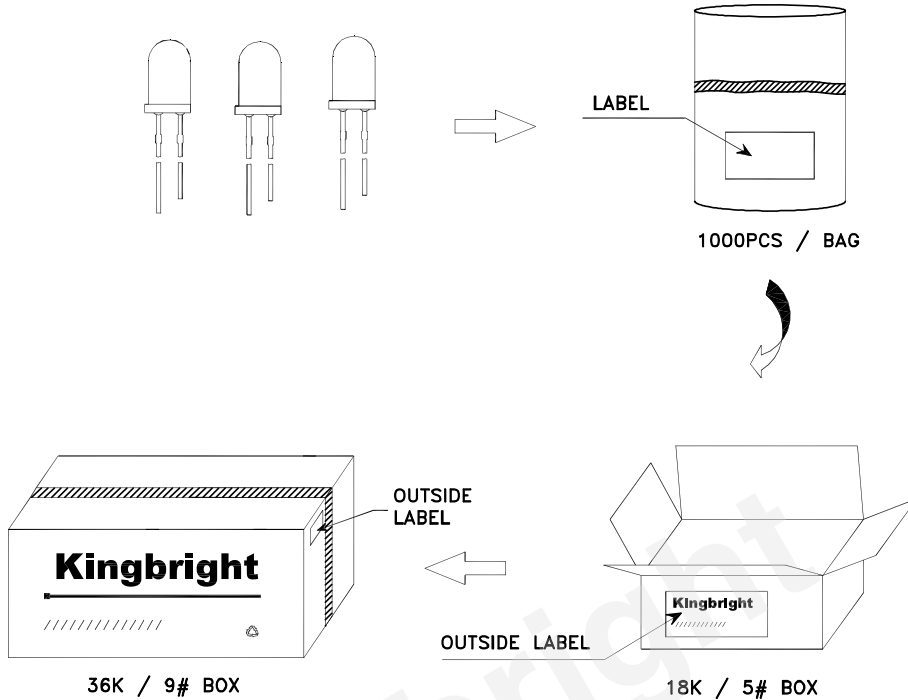

PACKING & LABEL SPECIFICATIONS

L-7113SF6C



Kingbright		
P/NO: L-7113xxx		
QTY: 1000 pcs	Q.C.	Q C XX XX XXXX PASSED
S/N: XXXX		
CODE: XXX		
LOT NO:		
 <small>XXXXXXXXXXXXXXXXXXXXXXXXXXXX</small>		
RoHS Compliant		

Terms and conditions for the usage of this document

1. The information included in this document reflects representative usage scenarios and is intended for technical reference only.
2. The part number, type, and specifications mentioned in this document are subject to future change and improvement without notice. Before production usage customer should refer to the latest datasheet for the updated specifications.
3. When using the products referenced in this document, please make sure the product is being operated within the environmental and electrical limits specified in the datasheet. If customer usage exceeds the specified limits, Kingbright will not be responsible for any subsequent issues.
4. The information in this document applies to typical usage in consumer electronics applications. If customer's application has special reliability requirements or have life-threatening liabilities, such as automotive or medical usage, please consult with Kingbright representative for further assistance.
5. The contents and information of this document may not be reproduced or re-transmitted without permission by Kingbright.
6. All design applications should refer to Kingbright application notes available at http://www.kingbright.com/application_notes

PRECAUTIONS

1. Storage conditions:

- a. Avoid continued exposure to the condensing moisture environment and keep the product away from rapid transitions in ambient temperature.
- b. LEDs should be stored with temperature $\leq 30^{\circ}\text{C}$ and relative humidity $< 60\%$.
- c. Product in the original sealed package is recommended to be assembled within 72 hours of opening. Product in opened package for more than a week should be baked for 30 (+10/-0) hours at $85 \sim 100^{\circ}\text{C}$.

2. The lead pitch of the LED must match the pitch of the mounting holes on the PCB during component placement. Lead-forming may be required to insure the lead pitch matches the hole pitch. Refer to the figure below for proper lead forming procedures. (Fig. 1)

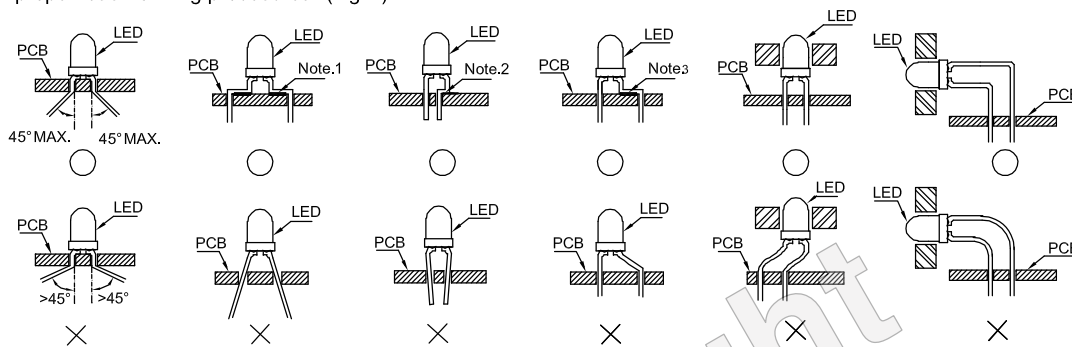

Fig.1

"O" Correct mounting method "X" Incorrect mounting method

Note 1-3: Do not route PCB trace in the contact area between the leadframe and the PCB to prevent short-circuits.

3. When soldering wires to the LED, each wire joint should be separately insulated with heat-shrink tube to prevent short-circuit contact. Do not bundle both wires in one heat shrink tube to avoid pinching the LED leads. Pinching stress on the LED leads may damage the internal structures and cause failure. (Fig. 2)

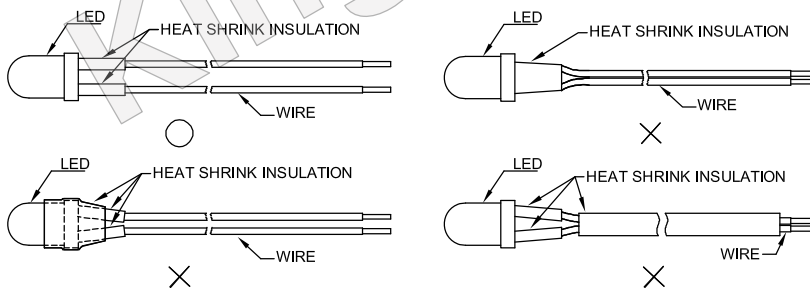

Fig. 2

4. Use stand-offs (Fig.3) or spacers (Fig.4) to securely position the LED above the PCB.

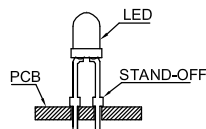

Fig. 3

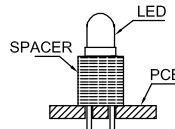

Fig. 4

5. Maintain a minimum of 3mm clearance between the base of the LED lens and the first lead bend. (Fig. 5 and 6)

6. During lead forming, use tools or jigs to hold the leads securely so that the bending force will not be transmitted to the LED lens and its internal structures. Do not perform lead forming once the component has been mounted onto the PCB. (Fig. 7)

7. Do not bend the leads more than twice. (Fig. 8)

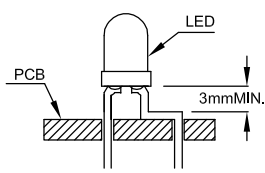

Fig. 5

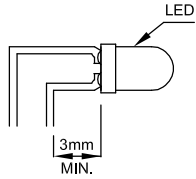

Fig. 6

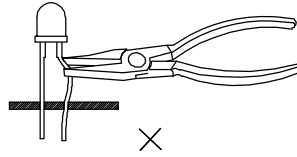

Fig. 7

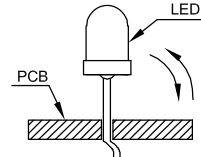
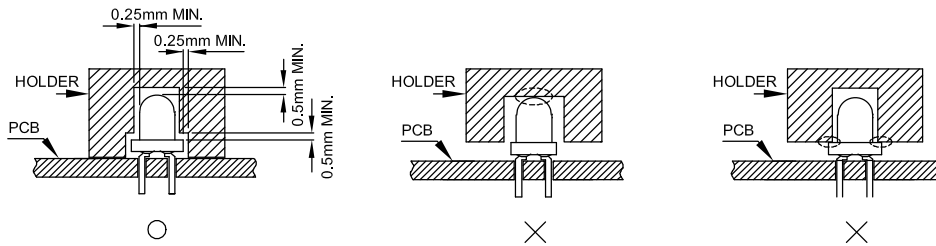

Fig. 8

8. During soldering, component covers and holders should leave clearance to avoid placing damaging stress on the LED during soldering.



9. The tip of the soldering iron should never touch the lens epoxy.

10. Through-hole LEDs are incompatible with reflow soldering.

11. If the LED will undergo multiple soldering passes or face other processes where the part may be subjected to intense heat, please check with Kingbright for compatibility.

12. Recommended Wave Soldering Profiles:

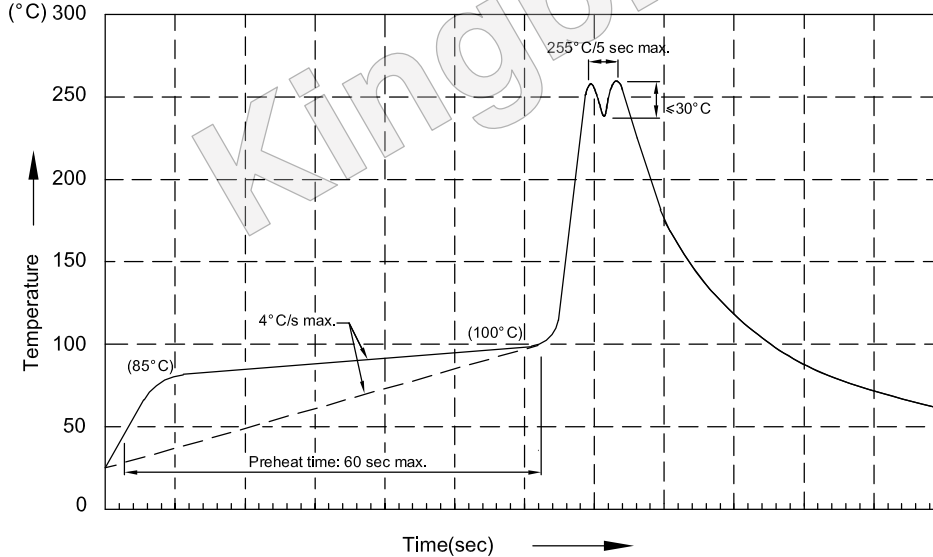

Notes:

1. Recommend pre-heat temperature of 105°C or less (as measured with a thermocouple attached to the LED pins) prior to immersion in the solder wave with a maximum solder bath temperature of 260°C
2. Peak wave soldering temperature between 245°C ~ 255°C for 3 sec (5 sec max).
3. Do not apply stress to the epoxy resin while the temperature is above 85°C.
4. Fixtures should not incur stress on the component when mounting and during soldering process.
5. SAC 305 solder alloy is recommended.
6. No more than one wave soldering pass.

X-ON Electronics

Largest Supplier of Electrical and Electronic Components

Click to view similar products for [Infrared Emitters - High Power category](#):

Click to view products by [Kingbright manufacturer](#):

Other Similar products are found below :

[IR19-315C/TR8](#) [SFH 4030](#) [SFH 4060](#) [HSM8-V380](#) [HSM9-V380](#) [SFH 5750](#) [PK2S-2KJE-A](#) [PK2S-2LJE-A](#) [PK2S-3KJE-A](#) [PK2S-3KKE-A](#)
[PK2S-3LJE-A](#) [PK2S-4KJE-A](#) [AREQ-90C0-00000](#) [AREQ-80C0-00000](#) [SFH 4775S A01](#) [SST-10-IRD-B90H-S810](#) [SFH 4727A](#) [SFH 4726AS](#)
[SFH 4717AS](#) [AREQ-8020-00000](#) [HR5P-N3FB-00000](#) [HR5P-N2FB-00000](#) [HR5P-N3CB-00000](#) [HR5P-N2CB-00000](#) [HR5P-N3CA-00000](#)
[HR5P-N2CA-00000](#) [HR5P-N2FA-00000](#) [HR5P-N3FA-00000](#) [VSMY2853SLX01](#) [VSMY2853RGX01](#) [VSMY2853GX01](#) [IN-P281ASGHIR](#)
[IN-P281ASGIR](#) [QEE123](#) [HSDL-4400#011](#) [C3535SIR2C-2B](#) [KM-4457F3C](#) [L-53F3BT](#) [VTE1291W-2H](#) [LL-304IRC4B-2AD](#) [LL-](#)
[503HIRT2E-1CC](#) [LL-503IRC2E-2AC](#) [LL-503IRC2V-2AD](#) [LL-503IRT2E-2AC](#) [LL-503IRT2E-2AE](#) [LL-503SIRC2E-1BD](#) [LL-503SIRC2H-](#)
[1BE](#) [LL-S170IRC-2A](#) [SFH 4259](#) [SFH 4542-Z](#)