

Part Number: L-9294ZGC

Green



**ATTENTION**  
OBSERVE PRECAUTIONS  
FOR HANDLING  
ELECTROSTATIC  
DISCHARGE  
SENSITIVE  
DEVICES

### Features

- High luminous emission.
- Low power consumption.
- General purpose leads.
- Reliable and rugged.
- Long life - solid state reliability.
- RoHS compliant.

### Description

The Green source color devices are made with InGaN on Sapphire Light Emitting Diode.

Static electricity and surge damage the LEDs.

It is recommended to use a wrist band or anti-electrostatic glove when handling the LEDs.

All devices, equipment and machinery must be electrically grounded.

### Package Dimensions

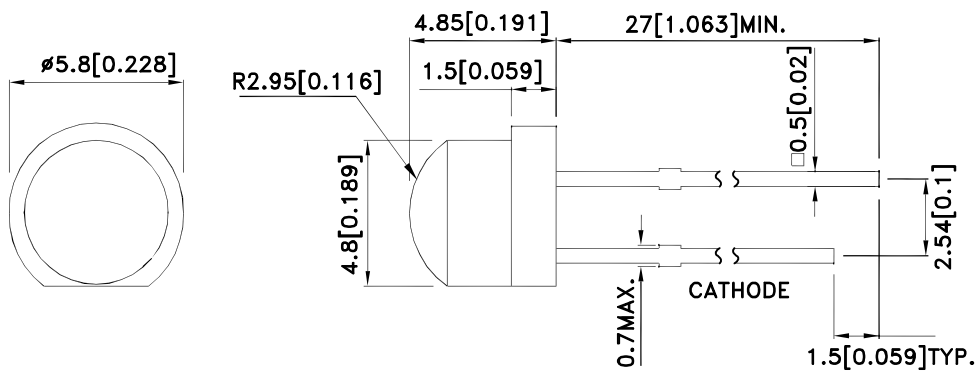

#### Notes:

1. All dimensions are in millimeters (inches).
2. Tolerance is  $\pm 0.25$  (0.01") unless otherwise noted.
3. Lead spacing is measured where the leads emerge from the package.
4. The specifications, characteristics and technical data described in the datasheet are subject to change without prior notice.



## Selection Guide

Part No.	Dice	Lens Type	Iv (mcd) [2] @ 20mA		Viewing Angle [1]
			Min.	Typ.	2θ1/2
L-9294ZGC	Green (InGaN)	Water Clear	1500	2300	60°

Notes:

1. θ1/2 is the angle from optical centerline where the luminous intensity is 1/2 of the optical peak value.
2. Luminous intensity/ luminous Flux: +/-15%.
3. Luminous intensity value is traceable to the CIE127-2007 compliant national standards.

## Electrical / Optical Characteristics at TA=25°C

Symbol	Parameter	Device	Typ.	Max.	Units	Test Conditions
λ <sub>peak</sub>	Peak Wavelength	Green	515		nm	I <sub>F</sub> =20mA
λ <sub>D</sub> [1]	Dominant Wavelength	Green	525		nm	I <sub>F</sub> =20mA
Δλ <sub>1/2</sub>	Spectral Line Half-width	Green	30		nm	I <sub>F</sub> =20mA
C	Capacitance	Green	45		pF	V <sub>F</sub> =0V;f=1MHz
V <sub>F</sub> [2]	Forward Voltage	Green	3.3	4.1	V	I <sub>F</sub> =20mA
I <sub>R</sub>	Reverse Current	Green		50	uA	V <sub>R</sub> = 5V

Notes:

1. Wavelength: +/-1nm.
2. Forward Voltage: +/-0.1V.
3. Wavelength value is traceable to the CIE127-2007 compliant national standards.

## Absolute Maximum Ratings at TA=25°C

Parameter	Green	Units
Power dissipation	102.5	mW
DC Forward Current	25	mA
Peak Forward Current [1]	150	mA
Reverse Voltage	5	V
Operating/Storage Temperature	-40°C To +85°C	
Lead Solder Temperature [2]	260°C For 3 Seconds	
Lead Solder Temperature [3]	260°C For 5 Seconds	

Notes:

1. 1/10 Duty Cycle, 0.1ms Pulse Width.
2. 2mm below package base.
3. 5mm below package base.



**Green**

**L-9294ZGC**

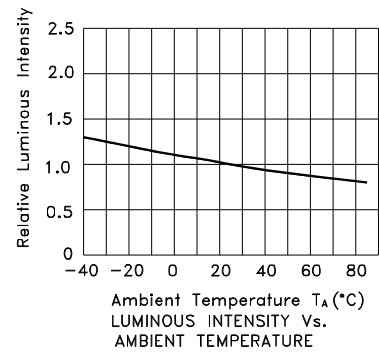

**PACKING & LABEL SPECIFICATIONS**

**L-9294ZGC**

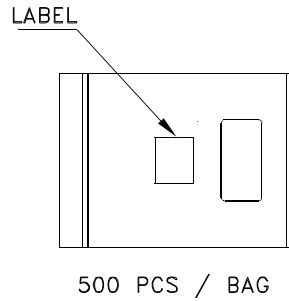
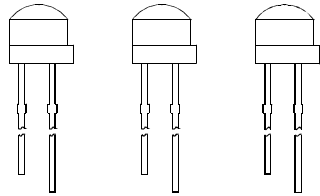

OUTSIDE LABEL

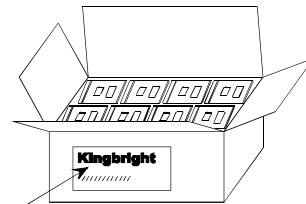

OUTSIDE LABEL

20K/BOX

10K/BOX

<h1>Kingbright</h1>	
P/NO: L-9294xxx	
QTY: 500 pcs	Q.C. <span style="border: 1px solid black; border-radius: 50%; padding: 2px;">Q C XX XX XXXX PASSED</span>
S/N: XXXX	
CODE: XXX	
LOT NO:	
 XXXXXXXXXXXX	
RoHS Compliant	

## PRECAUTIONS

1. The lead pitch of the LED must match the pitch of the mounting holes on the PCB during component placement. Lead-forming may be required to insure the lead pitch matches the hole pitch. Refer to the figure below for proper lead forming procedures. (Fig. 1)



Fig.1

”○” Correct mounting method ”×” Incorrect mounting method

2. When soldering wire to the LED, use individual heat-shrink tubing to insulate the exposed leads to prevent accidental contact short-circuit. (Fig.2)

3. Use stand-offs (Fig.3) or spacers (Fig.4) to securely position the LED above the PCB.



Fig. 2

Fig. 3

Fig. 4

4. Maintain a minimum of 2mm clearance between the base of the LED lens and the first lead bend. (Fig. 5 and 6)
5. During lead forming, use tools or jigs to hold the leads securely so that the bending force will not be transmitted to the LED lens and its internal structures. Do not perform lead forming once the component has been mounted onto the PCB. (Fig. 7)

6. Do not bend the leads more than twice. (Fig. 8)

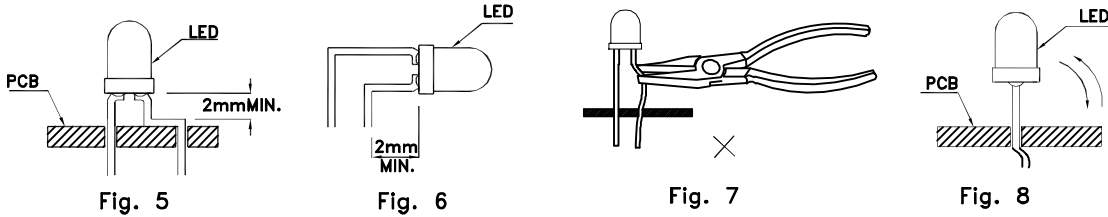

7. During soldering, component covers and holders should leave clearance to avoid placing damaging stress on the LED during soldering.

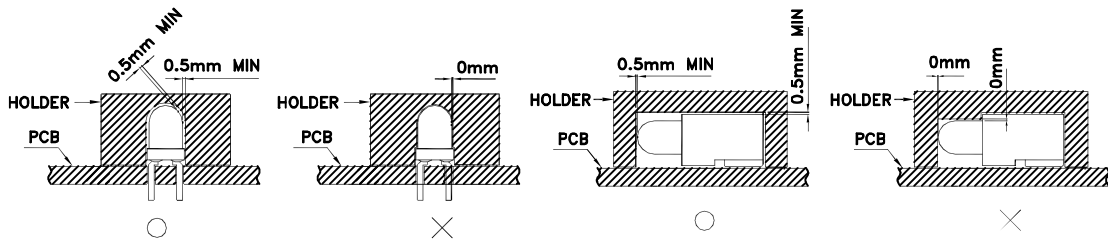

8. The tip of the soldering iron should never touch the lens epoxy.

9. Through-hole LEDs are incompatible with reflow soldering.

10. If the LED will undergo multiple soldering passes or face other processes where the part may be subjected to intense heat, please check with Kingbright for compatibility.

11. Recommended Wave Soldering Profile for Kingbright Thru-Hole Products

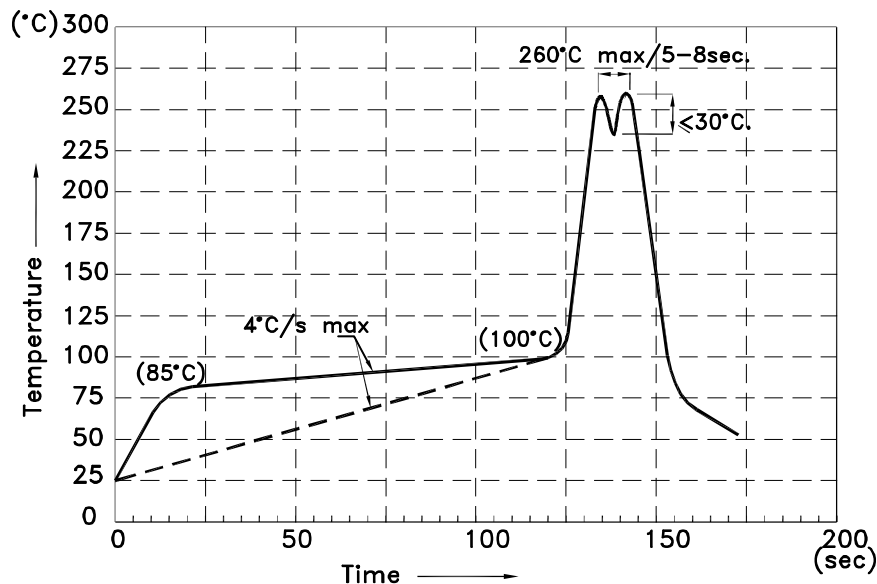

**Notes:**

1. Recommend the solder wave peak temperature kept between 245~260°C, The maximum soldering temperature should not exceed 260°C.
2. Do not apply stress to the epoxy body while the temperature is above 85°C.
3. During the wave soldering process, the preheat temperature must not exceed 100°C.
4. Fixtures should not place stress on the component when mounted.
5. No more than one soldering pass.

## X-ON Electronics

Largest Supplier of Electrical and Electronic Components

*Click to view similar products for [kingbright](#) manufacturer:*

Other Similar products are found below :

[DLC-6EGW](#) [BR-8.24](#) [L-934EW/1GD](#) [AA4040PGS](#) [PSA05-11GWA](#) [BC04-11SYKWA](#) [KB-2600ID](#) [L53YC13](#) [DLC2-6GD](#) [DLC2-6SGD](#)  
[SA40-19GWA](#) [CC56-21SRWA](#) [WP4060VH/2ID](#) [DC10GWA](#) [DC-05YWA](#) [KA-3535SELZ4S](#) [KB-2755SYKW](#) [SA56-11GWA](#) [DE2CGKD](#)  
[AA4040SF4S-P22](#) [BR9.52](#) [L-1384AL/1ID](#) [SA15-11PBWA-A](#) [KB-2855SGW](#) [BA56-11SYKWA](#) [ACSA03-41EWA-F01](#) [L-59GYC](#)  
[WP7113SF4BT-P22](#) [SA03-11PBWA/A](#) [SC40-19EWA](#) [DA03-11GWA](#) [L-934EB/2ID](#) [WP132WUM/EGW](#) [WP1503CB/GD](#) [WP1384AD/GD](#)  
[AA3528AVUACGSK](#) [L-964ID](#) [KPBD-3224SURKCGKC](#) [WP1533BQ/GD](#) [SA08-11SURKWA](#) [AM2520SYCK09](#) [L-138A8QMP/1ID](#) [SA23-](#)  
[12EWA](#) [WP934MD/2ID](#) [KPHBM-2012ETSGTC](#) [KPTR-3216SGC](#) [WP4060VH/2GD](#) [PDC54-12SRWA](#) [WP53MGD](#) [DLC-6MBD](#)