

Darlington

2SB1560

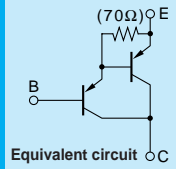

Silicon PNP Epitaxial Planar Transistor (Complement to type 2SD2390)

Application : Audio, Series Regulator and General Purpose

Absolute maximum ratings (Ta=25°C)

| Symbol | 2SB1560 | Unit |
|------------------|---------------------------|------|
| V _{CB0} | -160 | V |
| V _{CEO} | -150 | V |
| V _{EBO} | -5 | V |
| I _c | -10 | A |
| I _B | -1 | A |
| P _c | 100(T _c =25°C) | W |
| T _J | 150 | °C |
| T _{stg} | -55 to +150 | °C |

Electrical Characteristics (Ta=25°C)

| Symbol | Conditions | 2SB1560 | Unit |
|----------------------|---|----------|------|
| I _{CB0} | V _{CB} =-160V | -100max | μA |
| I _{EBO} | V _{EB} =-5V | -100max | μA |
| V _{(BR)CEO} | I _c =-30mA | -150min | V |
| h _{FE} | V _{CE} =-4V, I _c =-7A | 5000min* | |
| V _{CE(sat)} | I _c =-7A, I _B =-7mA | -2.5max | V |
| V _{BE(sat)} | I _c =-7A, I _E =-7mA | -3.0max | V |
| f _r | V _{CE} =-12V, I _E =2A | 50typ | MHz |
| COB | V _{CB} =-10V, f=1MHz | 230typ | pF |

*h_{FE} Rank ○(5000to12000), P(6500to20000), Y(15000to30000)

Typical Switching Characteristics (Common Emitter)

| V _{CC} (V) | R _L (Ω) | I _c (A) | V _{BB1} (V) | V _{BB2} (V) | I _{B1} (mA) | I _{B2} (mA) | t _{on} (μs) | t _{stg} (μs) | t _f (μs) |
|---------------------|--------------------|--------------------|----------------------|----------------------|----------------------|----------------------|----------------------|-----------------------|---------------------|
| -70 | 10 | -7 | -10 | 5 | -7 | 7 | 0.8typ | 3.0typ | 1.2typ |

External Dimensions MT-100(TO3P)

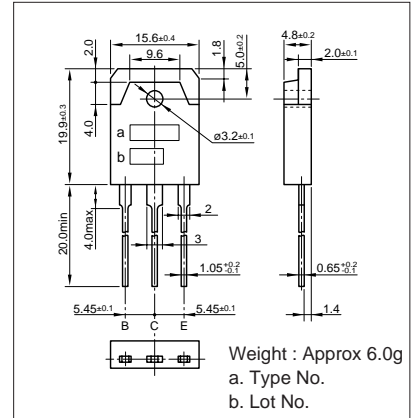

I_c-V_{CE} Characteristics (Typical)

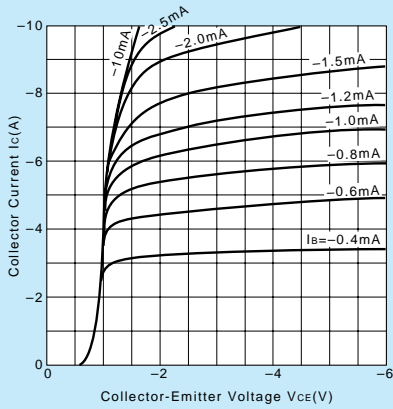

V_{CE(sat)}-I_B Characteristics (Typical)

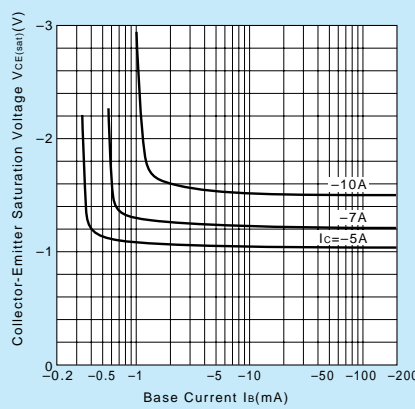

I_c-V_{BE} Temperature Characteristics (Typical)

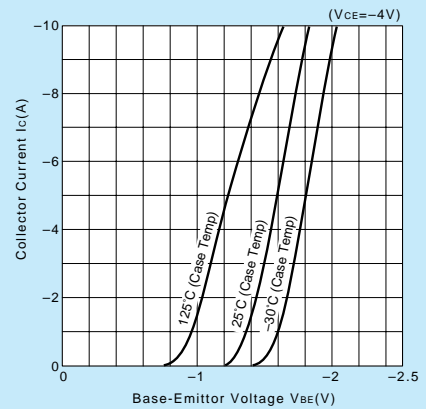

h_{FE}-I_c Characteristics (Typical)

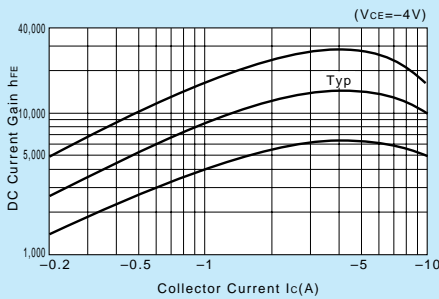

h_{FE}-I_c Temperature Characteristics (Typical)

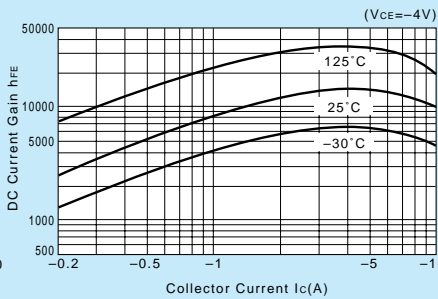

θ_{j-a}-t Characteristics

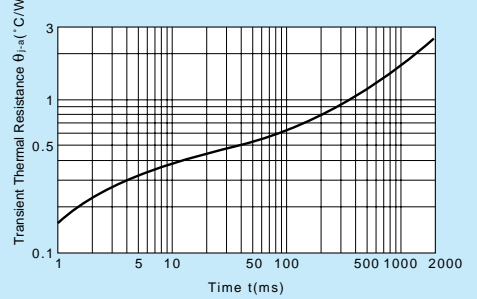

f_T-I_E Characteristics (Typical)

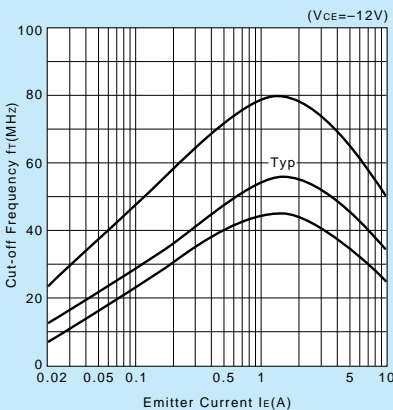

Safe Operating Area (Single Pulse)

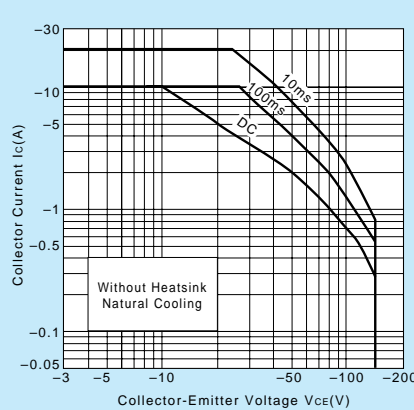

P_c-T_a Derating

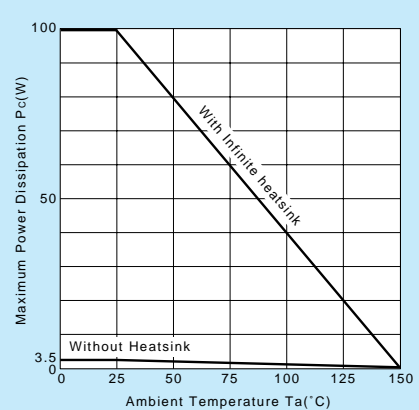

X-ON Electronics

Largest Supplier of Electrical and Electronic Components

Click to view similar products for [allegro manufacturer](#):

Other Similar products are found below :

[A1101ELHLT-T](#) [APEK4954ELP-01-T-DK](#) [APEK4491EES-01-T-DK](#) [APEK4490EES-01-T-DK](#) [ASEK758KCB-150U-T-DK](#) [ASEK759LCB-050B-T-DK](#) [APEK3901SEJ-01-T-DK](#) [APEK3931KJP-01-T-DK](#) [APEK4403GEU-01-T-DK](#) [ACS714ELCTR-30A-T](#) [APS12235LUAABU](#) [A3981KLPTR-T](#) [A5985GETTR-T](#) [ACS724LLCTR-50AB-T](#) [APEK4952ELY-01-T-DK](#) [APEK4931MET-01-T-DK](#) [APEK4447SLJ-01-T-DK](#) [ASEK710KLA-6BB-T-DK](#) [ASEK758LCB-050B-T-DK](#) [ASEK770KCB-150U-T-DK](#) [APEK4985SLP-01-T-DK](#) [ASEK711KLC-25AB-T-DK](#) [ASEK713ELC-20A-T-DK](#) [ASEK716KLA-12CB-T-DK](#) [A1212LLHLT-T](#) [A3213ELHLT-T](#) [A3916GESTR-T-1](#) [ACS758KCB-150B-PFF-T](#) [APEK4953ELJ-01-T-DK](#) [APEK4942GES-01-T-DK](#) [APEK3906SES-01-T-DK](#) [ASEK712ELC-30A-T-DK](#) [ASEK758ECB-200B-T-DK](#) [ASEK758LCB-100B-T-DK](#) [ASEK716KLA-25CB-T-DK](#) [ASEK759KCB-150B-T-DK](#) [ASEK770ECB-200U-T-DK](#) [A3930KJPTR-T](#) [APEK4979GLP-01-T-DK](#) [ASEK716KLA-6BB-T-DK](#) [ASEK758LCB-050U-T-DK](#) [A3959SLBTR-T](#) [ACS715ELCTR-30A-T](#) [APEK8651KLP-01-MH-DK](#) [APEK8650KLY-01-MH-DK](#) [APEK4915MLP](#) [ASEK710KLA-25CB-T-DK](#) [ASEK770ECB-200B-T-DK](#) [ASEK770KCB-150B-T-DK](#) [APEK4402KLP-01-T-DK](#)