

TeSys™ IEC-Style Contactors and Starters

Catalog

04

File 8502



CONTENTS

Description	Page
TeSys IEC Contactors and Starters Selection Guide	3
TeSys K-line Mini-contactors, Overload Relays, and Accessories	37
TeSys D-line Contactors, Enclosed Starters Overload Relays, and Accessories	77
TeSys F-line Contactors, Overload Relays, and Accessories	179
Catalog Number Index	247



TeSys™ IEC-Style Contactors and Starters Selection Guide

Catalog

04

File 8502



CONTENTS

Description	Page
Technical Information	
Product Standards	4
Product Approvals	6
Protective Treatment According to Climatic Environment	10
Degrees of Protection	12
Kilowatt Motor Ratings	14
Horsepower Motor Ratings	15
Contactor Selection Guide	
Definitions of Utilization Categories	16
Contactor Selection Guide for Utilization Category AC-3	18
Contactor Selection Guide for Utilization Category AC-1	22
Contactor Selection Guide for Utilization Category AC-2 and AC-4	24
Contactor Selection Guide for Utilization Category DC-1 to DC-5	28
Voltage Code Table	32
Definitions and Comments	36

TeSys™ IEC-Style Contactors and Starters Selection Guide

Technical Information: Product Standards

Conformity to Standards

The Telemecanique D-Line, F-line, and K-line contactors, overload relays and accessories satisfy most national, European, and international standards for promoting worldwide product acceptance. These product standards precisely define the performance of the designated products (such as IEC 60947 for low voltage equipment).

When used correctly, as designated by the manufacturer and in accordance with the regulations and rules of the art, these products will allow assembled equipment, machine systems or installations to conform to their appropriate standards (for example: IEC 60204, relating to electrical equipment used on industrial machines).

Telemecanique is able to provide proof of conformity of its production, in accordance with the standards selected by ourselves, due to our quality assurance system. On request, and depending on the situation, Telemecanique can provide the following:

- A declaration of conformity.
- A certificate of conformity (ASEFA/LOVAG).
- An approval certificate or agreement, in the countries where this procedure is required or for particular specifications, such as those existing in the merchant marine.

Code	Standards Body - Name	Abbreviation	Country
ANSI	American National Standards Institute	ANSI	USA
BS	British Standards Institution	BSI	Great Britain
CEI	Comitato Electrotecnico Italiano	CEI	Italy
DIN/VDE	Verband Deutscher Electrotechniker	VDE	Germany
EN	Comité Européen de Normalisation Electrotechnique	CENELEC	Europe
GOST	Gosudarstvenne Komitet Standartov	GOST	Russia
IEC	International Electrotechnical Commission	IEC	Worldwide
JIS	Japanese Industrial Standard	JISC	Japan
NBN	Institut Belge de Normalisation	IBN	Belgium
NEN	Nederlands Normalisatie Instituut	NNI	Netherlands
NFC	Union Technique de l'Electricité	UTE	France
SAA	Standards Association of Australia	SAA	Australia
UNE	Instituto Nacional de Racionalizacion y Normalizacion	IRANOR	Spain

European EN Standards

This is a group of technical specifications established in conjunction with, and approval of, the relative bodies within the various CENELEC member countries (EEC and EFTA). Arrived at by the principal of consensus, the European standards are the result of a majority vote. Such adopted standards are then integrated into the national collection of standards, and contradictory national standards are withdrawn. The European standards are now incorporated within the French standards and carry the prefix NF EN. Under the "Technical Union of Electricity" (UTE), the French version of the corresponding European standard carries a double notation: European reference (NF EN ...) and classification (C ...).

In addition, the standard NF EN 60947-4-1 relating to motor contactors and starters, effectively constitutes the French version of the European standard EN 60947-4-1 and carries the UTE classification C 63-110. This standard is identical to the British standard BS EN 60947-4-1 and the German standard DIN VDE 0660 Teil 102. Whenever reasonably practical, European standards reflect international standards (IEC).

For automation system components and distribution equipment, Telemecanique supplements the requirements of the French NF standards with those necessary for all other major industrial countries.

European Directives

The opening of the European market assumes a harmonization of the regulations pertaining to each member country of the European Community. The purpose of the European Directive is the elimination of obstacles hindering the free circulation of goods within the European Community, and its application applies to each member country.

Member countries are obliged to transcribe each Directive into their national legislation and to simultaneously withdraw any contradictory regulation. The Directives, in particular those of a technical content concerning us here, only establish the objectives to be obtained and are referred to as "essential requirements."

TeSys™ IEC-Style Contactors and Starters Selection Guide

Technical Information: Product Standards

The manufacturer is obliged to ensure that all measures are taken to provide conformity to the regulations of the particular Directive applicable to his product. As a general rule, the manufacturer certifies conformity to the essential requirements of the Directive(s) for the product by affixing a CE marking. The CE marking will be affixed to Telemecanique products progressively throughout the transition period, as defined by the French and European regulations.

Significance of the CE marking:

- The CE marking is affixed to a product to signify that the manufacturer certifies that the product conforms to the relevant European Directive(s) and is obligatory for a product, subject to one or more of the European Directives, before it can be freely distributed within the European Community.
- The CE marking is intended solely for national market control authorities.
- The CE marking must not be confused with a conformity marking.

For electrical equipment, only conformity to standards signifies that the product is suitable for its designated function, and only the guarantee of an established manufacturer can provide a high level of quality assurance. For Telemecanique labelled products, one or several Directives are liable to be applied, in particular:

- The Low Voltage Directive 73/23/EEC amended by the Directive 93/68/EEC: the CE marking relating to this Directive could not be affixed before 1 January 1995 but was obligatory as of January 1, 1997.
- The Electromagnetic Compatibility Directive 89/336/EEC, amended by the Directives 92/31/EEC and 93/68/EEC: the CE marking on products covered by this Directive is obligatory from 1 January 1996.

ASEFA-LOVAG Certification

The function of ASEFA (Association des Stations d'Essais Française d'Appareils électriques — Association of French Testing Stations for Low Voltage Industrial Electrical Equipment) is to carry out tests for conformity to standards and to issue certificates and test reports. ASEFA laboratories are authorized by the National Testing Network (RNE).

ASEFA is now effectively a member of the European accord group LOVAG (Low Voltage Agreement Group). This means that any certificates issued by LOVAG/ASEFA are recognized by all the authorities forming the membership of the group and carry the same validity as those issued by any of the member authorities.

Quality Labels

When components can be used in domestic and similar applications, it is sometimes necessary to obtain a "quality label," which is a form of certification of conformity.

Code	Quality Label	Country
CEBEC	Comité Electrotechnique Belge	Belgium
KEMA-KEUR	Keuring van Electrotechnische Materialen	Netherlands
NF-USE	Union Technique de l'Electricité	France
ÖVE	Österreichischer Verband für Electrotechnik	Austria
SEMKO	Svenska Elektriska Materiel Kontrollnatanalen	Sweden

Approvals



In some countries, the approval of certain electrical equipment is required by law. In this case, an approval certificate is issued by the official test authority. Each approved component must bear the relevant quality label when this is mandatory.

Code	Approval Authority	Country
ASE	Association Suisse des Electriciens	Switzerland
CSA	Canadian Standards Association	Canada
DEMKO	Danmarks Elektriske Materielkontrol	Denmark
FI	Sähkötarkastuskeskus Elinspektions Centralen (SETI)	Finland
NEMKO	Norges Elektriske Materielkontroll	Norway
UL	Underwriters Laboratories Inc.	USA

TeSys™ IEC-Style Contactors and Starters Selection Guide

Technical Information: Product Approvals

Note on approvals issued by the Underwriters Laboratories Inc. (UL) that there are two levels of approval:

Level of Approval	Symbol	Description
"Recognized"		The component is fully approved for inclusion in equipment built in a workshop, where the operating limits are known by the equipment manufacturer, and where its use within such limits is acceptable by Underwriters Laboratories Inc. The component is not approved as a "product for general use" because its manufacturing characteristics are incomplete or its application possibilities are limited. A "Recognized" component does not necessarily carry the approval symbol.
"Listed"		The component conforms to all the requirements of the classification applicable to it and may therefore be used both as a "product for general use" and as a component in assembled equipment. A "Listed" component must carry the approval symbol.

Marine Classification Authorities



















Prior approval by certain marine classification authorities is generally required for electrical equipment which is intended for use on board merchant vessels.

Code	Classification authority	Country
BV	Bureau Veritas	France
DNV	Det Norske Veritas	Norway
GL	Germanischer Lloyd	Russia
LROS	Lloyd's Register of Shipping	Great Britain
NKK	Nippon Kaiji Kyokai	Japan
RINA	Registro Italiano Navale	Italy
RRS	Register of Shipping	Russia

Product Approvals

The table below shows the approvals obtained or pending with the various approvals authorities as of 5/15/1995. For more detailed information, please consult your Local Square D Field Sales Office.

















Existing and Pending Approval of Automation System Components (except control and signalling units)

Standard Version X: Approved O: Approval pending Special Version +: Approved Ø: Approval pending	Approvals						Marine Classification Authorities								Quality Labels			
																		
	Switzerland	Canada	Denmark	Finland	Norway	U.S.A.  	France	Norway	Germany	Great Britain	Japan	Italy	CIS	Netherlands	France	Austria	Sweden	
AB1BB, AB1BC	X	X		X	X	X		X					X	X				
AB1BD	X												X					
AB1DV	X	X				X							X					
AB1FU	X	X	X		X	X		X					X					
AB1FV	X	X			X	X							X					
AB1NE, AB1SE	X	X		X	X	X							X					
AB1SV		X				X							X					
AB1TP	X	X		X	X	X		X	X	X		X	X	X			X	
AB1TR	X												X				X	
AB1VV	X	X	X	X	X	X		X	X	X		X	X	X		X	X	
AB3RV		X																
ABA6, ABE6R						X												
ABR1, ABR2		X				X	X	X	X									
ABS1							X	X	X									
ABS2		X				X	X	X	X									
AK2BA01	X																	
AK2BA162U		X				X												
AK2SB	X																	
AK3JB4 (CMD)	X	X				X	X	X	X	X	O					X		
AK3JB8 (CMD)	X	X				X			X	X	O					X		

TeSys™ IEC-Style Contactors and Starters Selection Guide

Technical Information: Product Approvals

















Existing and Pending Approval of Automation System Components (except control and signalling units)

Standard Version X: Approved O: Approval pending Special Version +: Approved Ø: Approval pending	Approvals							Marine Classification Authorities							Quality Labels			
																		
	ASE	CSA	DEMKO	FI	NEMKO	UL		BV	DNV	GL	LROS	NKK	RINA	RRS	KEMA	NF	ÖVE	SEMKO
Switzerland	Canada	Denmark	Finland	Norway	U.S.A.		France	Norway	Germany	Great Britain	Japan	Italy	CIS	Netherlands	France	Austria	Sweden	
AK5		X			X		X		X		X							
ATP		O					X											
ATS23		X					X											
ATV16, ATV66		X					X											
CA2D	X	X	X	X	X		X	X	X				X					X
CA2KN	X	X	X				X	O	O	O	O		O	O				X
CA3D	X	X	X		X		X	X	X				X					X
CA3KN	X	X					X	O	O	O	O		O	O				X
CA4D	X	X		X			X	X					X					X
CA4KN	X	X	X				X	O	O	O	O		O	O				X
CCX 17		O					X		O									
DF6															X			
DK1								X					X					
FTX 417		O					X											
FTX 117		O					O											
GB2CB	X	X			X	X											X	
GB2CD					X	X												
GC1■			X		X									X	X	X	X	
GC3					X										X			
GD2					X													
GV2M■		X	X		X		X	X	X	X	X			X			O	X
GV2P		X					X											
GV3		X					X				X						X	
GV7R		X					X	O	O	O	O		O					
GY1■					X											X	X	
GY3					X										X			
LA1D	X	X	X		X		X	X	X	O	O		X	X				X
LA1KN		X	X				X	O	O	O	O		O	O				X
LA1LB		X			X		X	O	X	O	O		X					X
LA1LC		X	X	X	X		X	X	X	X	X	X	X	X				
LA2D, LA3D		X	X		X		X	X	X	O	X		X	X				X
LA2K, LA4K		X					X	O	O	O	O		O	O				
LA4D	X	X					X	X		O	O		X	X				
LA8D	X	X		X	X		X	X		O	O		X	X				
LB•LB	X	X	X	X	X		X	O	X	O	O		X	O			X	X
LB•LC		X	X		X		X	X	X	X	X	X	X	X				
LB•LD	X	X		X			X	X	X	X		X	X	X				
LC1D	X	X	X	X	X		X	X	X	O	O		X	X				X
LC2D	X	X					X	X	X	O	O		X	X				
LC1F	X	X					X	X	X	O	O		X	X				
LC1K		X	X			X	X	O	O	O	O		O	O				X
LC2F		X					X	X	X	O	O		X	X				
LC2K, LC7K, LC8K		X				X	X	O	O	O	O		O	O				
LD1LB	X	X	X	X	X		X	O	X	O	O		X					X
LD1LC	X	X	X				X	X	X	X	X	X	X	X				

TeSys™ IEC-Style Contactors and Starters Selection Guide

Technical Information: Product Approvals

















Existing and Pending Approval of Automation System Components (except control and signalling units)

Standard Version X: Approved O: Approval pending Special Version +: Approved Ø: Approval pending	Approvals							Marine Classification Authorities							Quality Labels			
																		
	ASE	CSA	DEMKO	FI	NEMKO	UL	BV	DNV	GL	LROS	NKK	RINA	RRS	KEMA	NF	ÖVE	SEMKO	
	Switzerland	Canada	Denmark	Finland	Norway	U.S.A.	France	Norway	Germany	Great Britain	Japan	Italy	CIS	Netherlands	France	Austria	Sweden	
LD1LD	X	X				X	X	X		X	X	X	X					
LD4LC	X	X	X	X	X	X	X	X	X	X	X	X	X			X		
LD4LD	X	X		X	X	X	X	X	X	X	X	X	X					
LD5LB		X				X	O	X	O	O		X	O					
LD5LC	X	X				X			X	X	X	X	X			X		
LD5LD	X	X				X			X		X	X	X					
LE1D	X	X					X											
LN1D		X		X		X							X					
LP1D	X	X	X	X	X	X	X	X	O	X			X					
LP1K		X				X	X	O	O	O	O		O	O				
LP2D	X	X				X	X	X	O	O			X					
LP2K		X				X	X	O	O	O	O		O	O				
LP4D	X	X		X		X	X		O	O								
LP4K		X	X			X	X	O	O	O	O		O	O				
LP5D	X	X				X	X		O	O								
LP5K		X				X	X	O	O	O	O		O	O				
LR1F	X	X				X	X	X	X	X		X	X					
LR2D	X	X	X	X	X	X	X	X	O	O		X	X					
LR2F	X	X				X	X	X	O	O		X	X					
LR2K		X				X	O	O	O	O		O	O					
LR9F		X				X												
LS1D							X											
LT2S	X	X					X											
LT7F	X	X				X												
LT8	X	X						X										
RE1LA, RE1LC		X			X		X											
RE4, RE5		X				X			X									
RH+		X				X	X		X				X					
RM1XA		X																
RM3		X				X			X									
RS1, RS2																		
RTV74, RTV84		O				O												
RXN, RUW		O				O			O									
TSX 07		X				X		O										
TSX 1710/20		X				X	X	X	X			X	X					
K1, K2		X				X		X	X		X		X					
XA2B, BV, BW		X				X												
XACA (small hoist)		X	X		X	X				X	X	X						
XACA (all applications)		+	X		X	+				X	X	X						
XACB		X			X													
XACM		X																
XALB, XALJ, XALN		+		X	X	+		X					X					
XAPA		+		X				X		X			X					
XAPM		+		X		+		X	X	X			X					
XASE, XASP					X													

TeSys™ IEC-Style Contactors and Starters Selection Guide

Technical Information: Product Approvals

Existing and Pending Approval of Automation System Components (except control and signalling units)

Standard Version X: Approved O: Approval pending Special Version +: Approved Ø: Approval pending	Approvals							Marine Classification Authorities							Quality Labels			
																		
	ASE	CSA	DEMKO	FI	NEMKO	UL U.S.A.		BV	DNV	GL	LROS	NKK	RINA	RRS	KEMA	NF	ÖVE	SEMKO
Switzerland	Canada	Denmark	Finland	Norway	U.S.A.		France	Norway	Germany	Great Britain	Japan	Italy	CIS	Netherlands	France	Austria	Sweden	
XBLA		X					X											
XBTA, XBTK, KL, KN		X					X	X	X									
XBTB, XBTC		+					+											
XBTH, XBTP, XBTE, XBTHM		X					X											
XBTM, ML		X					X	O	X									
XBTV		+					+											
XB2B (pushbuttons)		X		X	X	X	X	X	X	X	X		X					X
XB2BV, BW (direct) (via transformer)		X	X	X	X	X	X	X	X	X	X		X					X
XB2BV, BW (reducer)		X	X	X	X	X	X	X	X	X	X		X					
XB2EV		X					X											
XB2M (pushbuttons)		X	X	X	X		X	X		X				X				
XB2MW (direct) (via transformer)		+	X	X	X		+			X				X				
XDA, XDL		X					X											
XD2A, XD2C, XD2E		+	X							X								
XD2PA, XD2GA		X					X				X							
XPEA				X														
XPEM		+		X														
XVAC, XVAL		X					X											
XVLA		X					X											
XY2CB, XY2CH		X																
XY2CE		+					+											
ZA2VA		X					X											
ZB2MW (direct) (via transformer)		+	X	X	X		+			X				X				

TeSys™ IEC-Style Contactors and Starters Selection Guide

Technical Information: Protective Treatment / Climatic Environment

Depending on the climatic and environmental conditions in which the equipment is placed, Telemecanique can offer specially adapted products to meet your requirements.

In order to make the correct choice of protective finish, two points should be remembered:

- The prevailing climate of the country is never the only criterion.
- Only the atmosphere in the immediate vicinity of the equipment should be considered.

“TC” Treatment for All Climates

“TC” is the standard treatment for Telemecanique equipment and is suitable for the vast majority of applications. It is the equivalent of treatments described as “Klimafest,” “Climateproof,” “Total Tropicalization,” or “Super Tropicalization,” and meets the following requirements:

- Publication UTE C 63-100 (method I), successive cycles of humid heat at + 40 °C (104 °F) and 95% relative humidity.
- DIN 50016 — Variations of ambient conditions within a climatic chamber:
 - + 23 °C (73 °F) and 83% relative humidity,
 - + 40 °C (104 °F) and 92% relative humidity.

It also meets the requirements of the marine classification authority BV-LROS-GL-DNV-RINA.

Characteristics

- Steel components are usually treated with zinc chromate and, when they have a mechanical function, they may also be painted.
- Insulating materials are selected for their high electrical, dielectric and mechanical characteristics.
- Metal enclosures have a stoved paint finish, applied over a primary phosphate protective coat, or are galvanized (for example, some prefabricated busbar trunking components).

Limits for Use of “TC” (All Climates) Treatment

- “TC” treatment is suitable for the following temperatures and humidity:

Temperature	20 °C (68 °F)	40 °C (104 °F)	50 °C (122 °F)
Relative Humidity	95%	80%	50%

- It may also be used where the above limits are only exceeded accidentally or for very short periods, or where temperature variations are not sufficient or fast enough to cause heavy condensation or dripping water on the equipment. “TC” treatment is therefore suitable for all latitudes, including tropical and equatorial regions, where the equipment is mounted in normal, ventilated industrial locations. Being sheltered from external climatic conditions, temperature variations are small, the risk of condensation is minimized, and the risk of dripping water is virtually non-existent.

Extension of Use of “TC” (All Climates) Treatment

In cases where the humidity around the equipment exceeds the conditions described above, where the equipment (in tropical regions) is mounted outdoors, or where it is placed in a very humid location (laundries, sugar refineries, steam rooms, and so forth), “TC” treatment can still be used if the following precautions are taken:

- The enclosure in which the equipment is mounted must be protected with a “TH” finish (see page 11) and must be well ventilated to avoid condensation and dripping water (for example, enclosure base plate mounted on spacers).
- Components mounted inside the enclosure must have a “TC” finish.
- If the equipment is to be switched off for long periods, a heater must be provided (0.2 to 0.5 kW per square decimeter / 15.5 square inch of enclosure), switched on automatically when the equipment is turned off. This heater keeps the inside of the enclosure at a temperature slightly higher than the outside surrounding temperature, thereby avoiding any risk of condensation and dripping water (the heat produced by the equipment itself in normal running is sufficient to provide this temperature difference).

TeSys™ IEC-Style Contactors and Starters Selection Guide

Technical Information: Protective Treatment / Climatic Environment

- For pilot devices, the use of “TC” treatment can be extended to outdoor use provided the enclosure is made of light alloys, zinc alloys, or plastic material. In this case, it is essential to ensure that the degree of protection against penetration of liquids and solid objects is suitable for the applications involved.

“TH” Treatment for Hot and Humid Environments

This treatment is for hot and humid atmospheres where installations are subject to condensation, dripping water, and the risk of fungi.

Plastic insulating components are also resistant to attacks from insects such as termites and cockroaches. These properties have led to this treatment being described as “Tropical Finish,” but this does not mean that all equipment installed in tropical and equatorial regions must have undergone “TH” treatment. On the other hand, certain operating conditions in temperate climates may well require the use of “TH”-treated equipment (see the Limits for Use of “TC” Treatment section on page 10).

The following are special characteristics of “TH” treatment:

- All insulating components are made of materials which are either resistant to fungi or treated with a fungicide, having increased resistance to creepage (Standards IEC 112, NF C 26-220, DIN 5348).
- Metal enclosures receive a top-coat of baked, fungicidal paint, applied over a rust inhibiting undercoat. Components with “TH” treatment may be subject to a surcharge (a large number of Telemecanique products are “TH” treated as standard and are, therefore, not subject to a price surcharge). Please consult our local representatives or agents.

Protective Treatment Selection Guide

Location	Environmental Conditions	Duty Cycle	Internal Heating of Enclosure when Not in Use	Type of Climate	Protective Treatment of	
					Components	Enclosure
Indoors	No dripping water or condensation	Unimportant	Unnecessary	Unimportant	“TC”	“TC”
	Presence of dripping water or condensation	Frequent switching off for periods of more than 1 day	No	Temperate	“TC”	“TH”
			Yes	Equatorial	“TH”	“TH”
		Continuous	Unimportant	Unimportant	“TC”	“TH”
Outdoors (sheltered)	No dripping water or dew	Unimportant	Unnecessary	Temperate	“TC”	“TC”
				Equatorial	“TH”	“TH”
Exposed outdoors, or near the sea	Frequent and regular presence of dripping water or dew	Frequent switching off for periods of more than 1 day	No	Temperate	“TC”	“TH”
			Yes	Equatorial	“TH”	“TH”
		Continuous	Unimportant	Unimportant	“TC”	“TH”

These treatments cover, in particular, the applications defined by methods I and II of guide UTE C 63-100.

Special Precautions for Electronic Equipment

Electronic products always meet the requirements of “TC” treatment. A number of them are “TH”-treated as standard.

Some electronic products (for example, programmable controllers, flush-mountable controllers CCX, and flush-mountable operator terminals XBT) necessitate the use of an enclosure providing a degree of protection to at least IP 54 (as defined by the standards IEC 60664 and NF C 20 040) for use in industrial applications or in environmental conditions requiring a “TH” treatment.

These electronic products, including flush-mountable products, must have a degree of protection to at least IP 20 (either provided by the enclosure itself or following installation) for restricted access locations where the degree of pollution does not exceed 2 (a test booth not containing machinery or other dust producing activities, for example).

TeSys™ IEC-Style Contactors and Starters Selection Guide

Technical Information: Degrees of Protection

IEC Publication 60529 *Classification of Degrees of Protection Provided by Enclosures* provides a system for specifying the enclosures of electrical equipment on the basis of the degree of protection provided by the enclosure. IEC 60529 does not specify degrees of protection against mechanical damage of equipment, risk of explosions, or conditions such as moisture (produced, for example, by condensation), corrosive vapors, fungi, or vermin. NEMA Standards Publication 250, and UL 50 Standard does test for environmental conditions such as corrosion, rust, icing, oil, and coolants. For this reason, and because tests and evaluations for other characteristics are not identical, the IEC Enclosure Classification Designations cannot be exactly equated with NEMA Enclosure Type Numbers.





The IEC designation consists of the letters IP followed by, usually, two numerals (for example IP 55). The first characteristic numeral indicates the degree of protection provided by the enclosure with respect to persons and solid foreign objects entering the enclosure. The second characteristic numeral indicates the degree of protection provided by the enclosure with respect to the harmful ingress of water. See the tables below and on page 13 for what the two numbers mean.

In addition, a single-digit letter may follow the two numerals (for example, IP 20C). This letter indicates that the actual protection of personnel against direct contact with live parts is better than that indicated by the first numeral. So this example (IP 20C) indicates that the device is finger-safe (the '2') and tool-safe (the 'C') for tools 2.5 mm (or larger) in diameter. See the table on page 13 for what letters are permissible and what each indicates.

Finally, a third numeral may sometimes appear and corresponds to the degree of protection against mechanical impact. In accordance with standard NF C 20-010, the third numeral may either follow the two IP numerals (for example, IP 55-9) or be shown separately from the IP code. This numeral also corresponds to an external factor classification as defined in standard NF C 15-100. See the table on page 13 for what numbers are permissible and what each indicates.

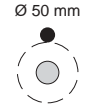
NOTE: Any characteristic numeral which is unspecified is replaced by an X (for example, IP XXB).

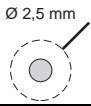
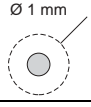









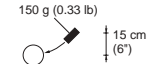

IEC 60529 Classification Designations — First Characteristic Numeral

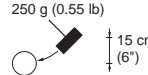
First Characteristic Numeral		Protection of the Equipment	Protection of Personnel
Corresponds to protection of the equipment against penetration of solid objects and protection of personnel against direct contact with live parts.			
0		Not protected	Not protected
1		Protected against the penetration of solid objects having a diameter greater than or equal to 50 mm (2").	Protected against direct contact with the back of the hand (accidental contacts).
2		Protected against the penetration of solid objects having a diameter greater than or equal to 12.5 mm (0.5").	Protected against direct finger contact.
3		Protected against the penetration of solid objects having a diameter greater than or equal to 2.5 mm (0.1").	Protected against direct contact with a 2.5-mm (0.1") diameter tool.
4		Protected against the penetration of solid objects having a diameter greater than 1 mm (0.04").	Protected against direct contact with a 1mm (0.04") diameter wire.
5		Dust-protected (no harmful deposits).	Protected against direct contact with a 1mm (0.04") diameter wire.
6		Dust-tight.	Protected against direct contact with a 1mm (0.04") diameter wire.

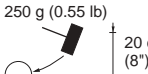
TeSys™ IEC-Style Contactors and Starters Selection Guide

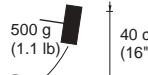
Technical Information: Degrees of Protection

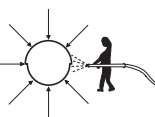
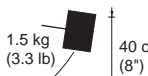
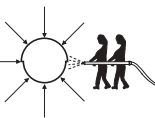
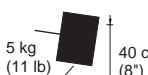
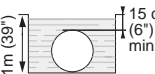
IEC 60529 Classification Designations — Second and Third Characteristic Numerals

Second Characteristic Numeral		Additional Letter	Third Characteristic Numeral		
Corresponds to protection of equipment against penetration of water with harmful effects.		Corresponds to protection of personnel against direct contact with live parts.	Corresponds to the degree of protection against mechanical impact. This numeral also corresponds to an external factor classification as defined in standard NF C 15-100.		
0	Non-protected	A	With the back of the hand.	0	Non-protected
1	  Protected against vertical dripping water (condensation).	B	With the finger.	1	 150 g (0.33 lb) 15 cm (6") Impact energy: at least equal to 0.25 N·m (external classification factor AG1).
2	 15° Protected against dripping water at an angle of up to 15°.	C	With a 2.5-mm (0.1") diameter tool.	2	 250 g (0.55 lb) 15 cm (6") Impact energy: at least equal to 0.375 N·m.
3	  60° Protected against rain at an angle of up to 60°.	D	With a 1mm (0.04") diameter wire.	3	 250 g (0.55 lb) 20 cm (8") Impact energy: at least equal to 0.5 N·m.
4	  Protected against splashing water in all directions.			5	 500 g (1.1 lb) 40 cm (16") Impact energy: at least equal to 0.5 N·m.
5	  Protected against water jets in all directions.			7	 1.5 kg (3.3 lb) 40 cm (8") Impact energy: at least equal to 6 N·m (external classification factor AG3).
6	 Protected against powerful jets of water and waves.			9	 5 kg (11 lb) 40 cm (8") Impact energy: at least equal to 20 N·m (external classification factor AG4).
7	 1m (39") 15 cm (6") min Protected against the effects of temporary immersion.				
8	 1m (39") Protected against the effects of prolonged immersion under specified conditions.				

The table below provides an equivalent conversion *from* NEMA Enclosure Type Numbers *to* IEC Enclosure Classification Designations. The NEMA Types meet or exceed the test requirements for the associated IEC Classifications; **for this reason this table cannot be used to convert from IEC Classifications to NEMA Types.**

Conversion of NEMA Type Numbers to IEC Classification Designations

(cannot be used to convert IEC Classification Designations to NEMA Type Numbers)

NEMA Enclosure Type Number	IEC Enclosure Classification Designation	NEMA Enclosure Type Number	IEC Enclosure Classification Designation
1	IP10	4 and 4X	IP56
2	IP11	5	IP52
3	IP54	6 and 6P	IP67
3R	IP14	12 and 12K	IP52
3S	IP54	13	IP54

The comparison is based on tests specified in IEC Publication 60529, and is from NEMA Publication 250.

TeSys™ IEC-Style Contactors and Starters Selection Guide

Technical Information: Kilowatt Motor Ratings

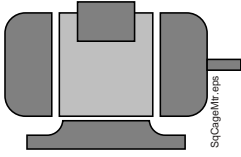

The tables below provide the average full-load currents of squirrel cage motors in accordance with IEC conventions. These are given only as a guide — they may vary depending on the type of motor and manufacturer. Refer to the actual motor nameplate for full-load current values.

Single-Phase Motors		
Power	220 Vac	240 Vac
Kilowatts	A	A
0.37	3.9	3.6
0.55	5.2	4.8
0.75	6.6	6.1
1.1	9.6	8.8
1.5	12.7	11.7
1.8	15.7	14.4
2.2	18.6	17.1
3	24.3	22.2
4	29.6	27.1
4.4	34.7	31.8
5.2	39.8	36.5
5.5	42.2	38.7
6	44.5	40.8
7	49.5	45.4
7.5	54.4	50

3-Phase Motors, 50/60 Hz						
Power	230 Vac	400 Vac	415 Vac	440 Vac	500 Vac	690 Vac
Kilowatts	A	A	A	A	A	A
0.37	2	0.98	–	0.99	1	–
0.55	2.8	1.5	–	1.36	1.21	–
0.75	3.6	1.9	2	1.68	1.5	–
1.1	5.2	2.5	2.5	2.37	2	–
1.5	6.8	3.4	3.5	3.06	2.6	–
2.2	9.6	4.8	5	4.42	3.8	–
3	–	6.3	6.5	5.77	5	3.5
3.7	15.2	–	–	–	–	–
4	–	8.1	8.4	7.9	6.5	4.9
5.5	22	11	11	10.4	9	6.7
7.5	28	14.8	14	13.7	12	9
9	–	18.1	17	16.9	13.9	10.5
11	42	21	21	20.1	18.4	12.1
15	54	28.5	28	26.5	23	16.5
18.5	68	35	35	32.8	28.5	20.2
22	80	42	40	39	33	24.2
30	104	57	55	51.5	45	33
37	130	69	66	64	55	40
45	154	81	80	76	65	46.8
55	192	100	100	90	80	58
75	248	131	135	125	105	75.7
90	312	162	165	146	129	94
110	360	195	200	178	156	113
132	–	233	240	215	187	135
–	480	222	260	236	207	–
160	–	285	280	256	220	165
–	600	–	–	–	–	–
200	–	352	340	321	281	203
220	720	388	385	353	310	224
250	840	437	425	401	360	253
280	–	–	–	–	–	–
315	–	555	535	505	445	321
–	1080	–	–	–	–	–
355	–	605	580	549	500	350
–	1200	–	–	–	–	–
400	–	675	650	611	540	390
450	1440	–	–	–	–	–
500	–	855	820	780	680	494
560	–	950	920	870	760	549
630	–	1045	1020	965	850	605
710	–	1200	1140	1075	960	694
800	–	–	1320	1250	1100	790
900	–	–	1470	1390	1220	880

TeSys™ IEC-Style Contactors and Starters Selection Guide

Technical Information: Horsepower Motor Ratings

The table below provides the average full-load currents of squirrel cage motors based on NEC (National Electrical Code) Tables 430-148, 149, and 150. These values are given only as a guide — they may vary depending on the type of motor and manufacturer. Refer to the actual motor nameplate for full-load current values.

HP	110 to 120 Vac			220 to 240 Vac ♦			380 to 415 Vac		440 to 480 Vac			550 to 600 Vac		
	Single Phase	Two Phase	Three Phase	Single Phase	Two Phase	Three Phase	Single Phase	Three Phase	Single Phase	Two Phase	Three Phase	Single Phase	Two Phase	Three Phase
1/10	3.0	-	-	1.5	-	-	1.0	-	-	-	-	-	-	-
1/8	3.8	-	-	1.9	-	-	1.2	-	-	-	-	-	-	-
1/6	4.4	-	-	2.2	-	-	1.4	-	-	-	-	-	-	-
1/4	5.8	-	-	2.9	-	-	1.8	-	-	-	-	-	-	-
1/3	7.2	-	-	3.6	-	-	2.3	-	-	-	-	-	-	-
1/2	9.8	4.0	4.4	4.9	2.0	2.2	3.2	1.3	2.5	1.0	1.1	2.0	0.8	0.9
3/4	13.8	4.8	6.4	6.9	2.4	3.2	4.5	1.8	3.5	1.2	1.6	2.8	1.0	1.3
1	16.0	6.4	8.4	8.0	3.2	4.2	5.1	2.3	4.0	1.6	2.1	3.2	1.3	1.7
1 1/2	20.0	9.0	12.0	10.0	4.5	6.0	6.4	3.3	5.0	2.3	3.0	4.0	1.8	2.4
2	24.0	11.8	13.6	12.0	5.9	6.8	7.7	4.3	6.0	3.0	3.4	4.8	2.4	2.7
3	34.0	16.6	19.2	17.0	8.3	9.6	10.9	6.1	8.5	4.2	4.8	6.8	3.3	3.9
5	56.0	26.4	30.4	28.0	13.2	15.2	17.9	9.7	14.0	6.6	7.6	11.2	5.3	6.1
7 1/2	80.0	38.0	44.0	40.0	19.0	22.0	27.0	14.0	21.0	9.0	11.0	16.0	8.0	9.0
10	100.0	48.0	56.0	50.0	24.0	28.0	33.0	18.0	26.0	12.0	14.0	20.0	10.0	11.0
15	135.0	72.0	84.0	68.0	36.0	42.0	44.0	27.0	34.0	18.0	21.0	27.0	14.0	17.0
20	-	94.0	108.0	88.0	47.0	54.0	56.0	34.0	44.0	23.0	27.0	35.0	19.0	22.0
25	-	118.0	136.0	110.0	59.0	68.0	70.0	44.0	55.0	29.0	34.0	44.0	24.0	27.0
30	-	138.0	160.0	136.0	69.0	80.0	87.0	51.0	68.0	35.0	40.0	54.0	28.0	32.0
40	-	180.0	208.0	176.0	90.0	104.0	112.0	66.0	88.0	45.0	52.0	70.0	36.0	41.0
50	-	226.0	260.0	216.0	113.0	130.0	139.0	83.0	108.0	56.0	65.0	86.0	45.0	52.0
60	-	-	-	-	133.0	154.0	-	103.0	-	67.0	77.0	-	52.0	62.0
75	-	-	-	-	166.0	192.0	-	128.0	-	83.0	96.0	-	66.0	77.0
100	-	-	-	-	218.0	248.0	-	165.0	-	109.0	124.0	-	87.0	99.0
125	-	-	-	-	-	312.0	-	208.0	-	135.0	156.0	-	108.0	125.0
150	-	-	-	-	-	360.0	-	240.0	-	156.0	180.0	-	125.0	144.0
200	-	-	-	-	-	480.0	-	320.0	-	208.0	240.0	-	167.0	192.0
250	-	-	-	-	-	602.0	-	403.0	-	-	302.0	-	-	242.0
300	-	-	-	-	-	-	-	482.0	-	-	361.0	-	-	289.0
350	-	-	-	-	-	-	-	560.0	-	-	414.0	-	-	336.0
400	-	-	-	-	-	-	-	636.0	-	-	477.0	-	-	382.0
500	-	-	-	-	-	-	-	786.0	-	-	590.0	-	-	472.0

♦ To obtain full-load currents for 200 and 208 Vac motors, increase corresponding 220 to 240 Vac ratings by 15 and 10 percent, respectively.
 To obtain full-load currents for 265 and 277 Vac motors, decrease corresponding 220 to 240 Vac ratings by 13 and 17 percent, respectively.

TeSys™ IEC-Style Contactors and Starters Selection Guide

Definitions of Utilization Categories

IEC contactors should be selected according to the utilization category which is a combination of application and duty cycle rates defined by the following:

- The type of application (inductive motor loads or resistive loads)
- The conditions under which making or breaking current takes place (motor starting or running, reversing, plugging or jogging, locked rotor or stalled motor)
- Number of making and breaking operations (or cycles) required for the life of the contactor

Utilization Categories for Contactors Conforming to IEC 60947-4

Type of Application	Utilization Category	Definition
AC Applications	Category AC-1	This category applies to AC loads with a power factor greater than or equal to 0.95 ($\cos \varphi \geq 0.95$). Application examples: heating, distribution.
	Category AC-2	This category applies to starting, plugging, and inching of slip ring motors. On closing, the contactor makes the starting current, which is about 2.5 times the rated current of the motor. On opening, it must break the starting current at a voltage less than or equal to the mains supply voltage.
	Category AC-3	This category applies to squirrel cage motors with breaking during normal running of the motor. On closing, the contactor makes the starting current, which is about 5 to 7 times the rated current of the motor. On opening, it breaks the rated current drawn by the motor; at this point, the voltage at the contactor terminals is about 20% of the mains supply voltage. Breaking is light. Applications examples: all standard squirrel cage motors — lifts, escalators, conveyor belts, bucket elevators, compressors, pumps, mixers, air conditioning units, and so forth.
	Categories AC-4 and AC-2	These categories cover applications with plugging and inching of squirrel cage and slip ring motors. The contactor closes at a current peak which may be as high as 5 or 7 times the rated motor current. On opening, it breaks this same current at a voltage which is higher as the motor speed lessens. This voltage can be the same as the mains voltage. Breaking is severe. Application examples: printing machines, wire drawing machines, cranes, hoists, metallurgy industry.
DC applications	Category DC-1	This category applies to all types of DC load with a time constant (L/R) of less than or equal to 1 ms.
	Category DC-3	This category applies to starting, counter-current braking, and inching of shunt motors. The time constant is less than or equal to 2 ms. On closing, the contactor makes the starting current, which is about 2.5 times the rated motor current. On opening, the contactor must be able to break 2.5 times the starting current at a voltage which is less than or equal to the mains voltage. The slower the motor speed, and therefore the lower its back e.m.f., the higher this voltage. Breaking is difficult.
	Category DC-5	This category applies to starting, counter-current braking and inching of series wound motors. The time constant is less than or equal to 7.5 ms. On closing, the contactor makes a starting current peak which may be as high as 2.5 times the rated motor current. On opening, the contactor breaks this same current at a voltage which is higher as the motor speed lessens. This voltage can be the same as the mains voltage. Breaking is severe.

Utilization Categories for Auxiliary Contacts and Control Relays Conforming to IEC 60947-5

Type of Application	Utilization Category	Definition
AC Applications	Category AC-14	This category applies to the switching of electromagnetic loads whose power drawn with the electromagnet closed is less than 72 VA. Application example: switching the operating coil of contactors and relays.
	Category AC-15	This category applies to the switching of electromagnetic loads whose power drawn with the electromagnet closed is greater than 72 VA. Application example: switching the operating coil of contactors.
DC Applications	Category DC-13	This category applies to the switching of electromagnetic loads for which the time taken to reach 95% of the steady state current ($T=0.95$) is equal to 6 times the power P drawn by the load (with $P \leq 50$ W). Application example: switching the operating coil of contactors without economy resistor.

TeSys™ IEC-Style Contactors and Starters Selection Guide

Definitions of Utilization Categories

The following tables show the results of tests performed according to standard utilization categories conforming to IEC 60947 based on rated operational current (Ie) and rated operational voltage (Ve).

Contactors

		Making and Breaking Conditions (normal operation)						Making and Breaking Conditions (occasional operation)						
AC Supply														
Typical Applications	Utilization Category	Making			Breaking			Making			Breaking			
		I	V	cos φ	I	V	cos φ	I	V	cos φ	I	V	cos φ	
Resistors, non-inductive or slightly inductive loads	AC-1	1 Ie	1.05 Ve	0.8	1 Ie	1.05 Ve	0.8	1.5 Ie	1.05 Ve	0.8	1.5 Ie	1.05 Ve	0.8	
Motors	Slip ring motors: starting, breaking	AC-2	2 Ie	1.05 Ve	0.65	2 Ie	1.05 Ve	0.65	4 Ie	1.05 Ve	0.65	4 Ie	1.05 Ve	0.65
	Squirrel cage motors: starting, breaking while motor running	AC-3												
		Ie ≤ 100A	2 Ie	1.05 Ve	0.45	2 Ie	1.05 Ve	0.45	10 Ie	1.05 Ve	0.45	8 Ie	1.05 Ve	0.45
		Ie > 100A	2 Ie	1.05 Ve	0.35	2 Ie	1.05 Ve	0.35	10 Ie	1.05 Ve	0.35	8 Ie	1.05 Ve	0.35
Slip ring motors: starting, plugging, inching	AC-4													
	Ie ≤ 100A	6 Ie	1.05 Ve	0.45	6 Ie	1.05 Ve	0.45	12 Ie	1.05 Ve	0.35	10 Ie	1.05 Ve	0.35	
	Ie > 100A	6 Ie	1.05 Ve	0.35	6 Ie	1.05 Ve	0.35	12 Ie	1.05 Ve	0.35	10 Ie	1.05 Ve	0.35	

DC Supply

Typical Applications	Utilization Category	Making			Breaking			Making			Breaking		
		I	V	L/R (ms)	I	V	L/R (ms)	I	V	L/R (ms)	I	V	L/R (ms)
Resistors, non inductive or slightly inductive loads	DC-1	1 Ie	1 Ve	1	1 Ie	1 Ve	1	1.5 Ie	1.05 Ve	1	1.5 Ie	1.05 Ve	1
Shunt wound motors: starting, counter-current braking, inching	DC-3	2.5 Ie	1.05 Ve	2	2.5 Ie	1.05 Ve	2	4 Ie	1.05 Ve	2.5	4 Ie	1.05 Ve	2.5
Series wound motors: starting, counter-current braking, inching	DC-5	2.5 Ie	1.05 Ve	7.5	2.5 Ie	1.05 Ve	7.5	4 Ie	1.05 Ve	15	4 Ie	1.05 Ve	15

Auxiliary Contacts and Control Relays

		Making and Breaking Conditions (normal operation)						Making and Breaking Conditions (occasional operation)						
AC Supply														
Typical Application	Utilization Category	Making			Breaking			Making			Breaking			
		I	V	cos φ	I	V	cos φ	I	V	cos φ	I	V	cos φ	
Electromagnets	< 72 VA	AC-14	6 Ie	1 Ve	0.3	1 Ie	1 Ve	0.3	6 Ie	1.1 Ve	0.7	6 Ie	1.1 Ve	0.7
	≥ 72 VA	AC-15	10 Ie	1 Ve	0.3	1 Ie	1 Ve	0.3	10 Ie	1.1 Ve	0.3	10 Ie	1.1 Ve	0.3

DC Supply

Typical Application	Utilization Category	Making			Breaking			Making			Breaking		
		I	V	L/R (ms)	I	V	L/R (ms)	I	V	L/R (ms)	I	V	L/R (ms)
Electromagnets	DC-13	1 Ie	1 Ve	6 P ■	1 Ie	1 Ve	6 P ■	1.1 Ie	1.1 Ve	6 P ■	1 Ie	1.1 Ve	6 P ■

■ The value 6 P (in watts) is based on practical observations and is considered to represent the majority of magnetic loads up to the maximum limit of P = 50 W, that is 6 P = 300 ms = L/R. Above this, the loads are made up of smaller loads in parallel. The value 300 ms is therefore a maximum limit whatever the value of current drawn.

TeSys™ IEC-Style Contactors and Starters Selection Guide

Contactor Selection for Utilization Category AC-3

How to Use the Electrical Life Curves

The contactor electrical life curves on the following pages may be used to estimate the number of make and break operations a contactor can achieve for a specific application. Compare the application to the utilization category definitions listed on page 16 and select the appropriate chart. Each chart shows the Number of Operations in Millions on the Y axis and the Current Broken in Amps on the X axis.

- AC-1 The current broken should be the same as the make and maintain current.
- AC-3 The current broken should be the same as the full load current rating (FLA) of the motor.
- AC-4 The current broken should be the same as the locked rotor current (LRA) or 6 times full-load current of the motor.

Once the appropriate chart is selected, find the breaking current of the application on the X axis of the chart and draw a vertical line. Draw a vertical line at this point. Find the intersection of this vertical line and the life curve of a particular contactor. At the intersection point read the number of electrical operations off the Y axis. If longer electrical life is required, continue checking the intersection points until an acceptable contactor is found.

Operational Current and Power Conforming to IEC ($\theta \leq 55^{\circ}\text{C}$ [131 °F]) for Category AC-3

Contactor Size			LC1 LP1	LC1 LC1	LC1 LP1	LC1 LP1	LC1 LP1	LC1 LP1	LC1 LP1	LC1 LP1	LC1 LP1	LC1 LP1
			K06	K09	K12	D09	D12	D18	D25	D32	D38	D40
Max. operational current (AC-3)	≤ 440 Vac	A	6	9	12	9	12	18	25	32	38	40
	220/240 Vac	kW	1.5	2.2	3	2.2	3	4	5.5	7.5	9	11
Rated operational power P (standard motor power ratings)	380/400 Vac	kW	2.2	4	5.5	4	5.5	7.5	11	15	18.5	18.5
	415 Vac	kW	2.2	4	5.5	4	5.5	9	11	15	18.5	22
	440 Vac	kW	3	4	5.5	4	5.5	9	11	15	18.5	22
	500 Vac	kW	3	4	4	5.5	7.5	10	15	18.5	18.5	22
	660/690 Vac	kW	3	4	4	5.5	7.5	10	15	18.5	18.5	30
	1000 Vac	kW	–	–	–	–	–	–	–	–	–	22

Maximum Operating Rate in Operating Cycles/Hour ♦

On-load Factor	Operational Power			LC1 LP1	LC1 LP1	LC1 LP1	LC1 LP1	LC1 LP1	LC1 LP1	LC1 LP1	LC1 LP1
				D09	D12	D18	D25	D32	D38	D40	
$\leq 85\%$	P	–	–	–	1200	1200	1200	1200	1000	1000	1000
	0.5 P	–	–	–	3000	3000	2500	2500	2500	2500	2500
$\leq 25\%$	P	–	–	–	1800	1800	1800	1800	1200	1200	1200

Operational Current and Power Conforming to UL, CSA ($\theta \leq 55^{\circ}\text{C}$ [131 °F])

Contactor Size			LC1 LP1	LC1 LP1	LC1 LP1	LC1 LP1	LC1 LP1	LC1 LP1	LC1 LP1	LC1 LP1	LC1 LP1	
			K06	K09	K12	D09	D12	D18	D25	D32	D38●	D40
Max. operational current (AC-3)	≤ 440 Vac	A	6	9	12	9	12	18	25	32	–	40
	200/208 Vac	HP	1.5	2	3	2	3	5	7.5	10	–	10
Rated operational power P (standard motor power ratings) 60 Hz	230/240 Vac	HP	1.5	3	3	2	3	5	7.5	10	–	10
	460/480 Vac	HP	3	5	7.5	5	7.5	10	15	20	–	30
	575/600 Vac	HP	3	5	10	7.5	10	15	20	30	–	30

♦ Depending on the operational power and the on-load factor ($\theta \leq 55^{\circ}\text{C}$ [131 °F]).

● Not UL Listed or CSA Certified.

TeSys™ IEC-Style Contactors and Starters Selection Guide

Contactor Selection for Utilization Category AC-3

In many applications there is a mixture of AC3 and AC4 duty. For these applications the electrical life of a particular contactor can be estimated by using the following formula:

$$E = \frac{AC3}{1 - \left(\frac{P}{100}\right) + \left(\frac{P}{100} \times \frac{AC3}{AC4}\right)}$$

Where: E = Estimated electrical life for mixed duty application
 AC3 = Number of electrical operations taken from the 100% AC3 Duty Life Curve
 AC4 = Number of electrical operations taken for the 100% AC4 Duty Life Curve
 P = Proportion of AC-4 operations to total operations for the application, expressed as a percentage.

Example: A LC1D12 contactor for a motor load of 7.5 HP at 460 Vac, 11 A, 15% AC4 duty.

AC-3 breaking current is 11 Amps From chart: AC3 = 2,250,000 operations

AC-4 breaking current is 66 Amps (approximate inrush) From chart: AC4 = 90,000 operations

E = 2,250,000 / [1 - (15/100) + (15/100) x (2,250,000 / 90,000)] = 489,130 operations for approximate electrical life

Operational Current and Power Conforming to IEC ($\theta \leq 55^\circ\text{C}$ [131 °F]) for Category AC-3

Contactor Size			LC1	LC1	LC1	LC1	LC1	LC1	LC1	LC1	LC1	LC1	LC1	LC1	LC1	LC1	
			LP1	LP1	LP1	LC1	LC1	LC1	LC1	LC1	LC1	LC1	LC1	LC1	LC1	LC1	LC1
			D50	D65	D80	D95	D115	D150	F185	F225	F265	F330	F400	F500	F630	F780	F800
Max. operational current (AC-3)	≤ 440 Vac	A	50	65	80	95	115	150	185	225	265	330	400	500	630	780	800
Rated operational power P (standard motor power ratings)	220/240 Vac	kW	15	18.5	22	25	30	40	55	63	75	100	110	147	200	220	250
	380/400 Vac	kW	22	30	37	45	55	75	90	110	132	160	200	250	335	400	450
	415 Vac	kW	25	37	45	45	59	80	100	110	140	180	220	280	375	425	450
	440 Vac	kW	30	37	45	45	59	80	100	110	140	200	250	295	400	425	450
	500 Vac	kW	30	37	55	55	75	90	110	129	160	200	257	355	400	450	450
	660/690 Vac	kW	33	37	45	45	80	100	110	129	160	220	280	335	450	475	475
1000 Vac	kW	30	37	45	45	75	90	100	100	147	160	185	335	450	450	450	

Maximum Operating Rate in Operating Cycles/Hour ♦

On-load Factor	Operational Power	LC1	LC1	LC1	LC1	LC1	LC1	LC1	LC1	LC1	LC1	LC1	LC1	LC1	LC1	LC1
		LP1	LP1	LP1	LC1	LC1	LC1	LC1	LC1	LC1	LC1	LC1	LC1	LC1	LC1	LC1
		D50	D65	D80	D95	D115	D150	F185	F225	F265	F330	F400	F500	F630	F780	F800
$\leq 85\%$	P	1000	1000	750	750	750	750	750	750	750	750	500	500	500	500	500
	0.5 P	2500	2500	2000	2000	2000	1200	2000	2000	2000	2000	1200	1200	1200	1200	600
$\leq 25\%$	P	1200	1200	1200	1200	1200	1200	1200	1200	1200	1200	1200	1200	1200	1200	600

Operational Current and Power Conforming to UL, CSA ($\theta \leq 55^\circ\text{C}$ [131 °F])

Contactor Size			LC1	LC1	LC1	LC1	LC1	LC1	LC1	LC1	LC1	LC1	LC1	LC1	LC1	LC1	
			LP1	LP1	LP1	LC1	LC1	LC1	LC1	LC1	LC1	LC1	LC1	LC1	LC1	LC1	LC1
			D50	D65	D80	D95 ♦	D115	D150	F185	F225 ♦	F265	F330	F400	F500	F630	F780	F800
Max. operational current (AC-3)	≤ 440 Vac	A	50	65	80	–	115	150	185	–	265	330	400	500	630	780	800
Rated operational power P (standard motor power ratings) 60 Hz	200/208 Vac	HP	15	20	30	–	30	40	50	–	60	75	100	150	–	–	350
	230/240 Vac	HP	15	20	30	–	40	50	60	–	75	100	125	200	300	450	400
	460/480 Vac	HP	40	50	60	–	75	100	125	–	150	200	250	400	600	900	900
	575/600 Vac	HP	40	50	60	–	100	125	150	–	200	250	300	500	800	900	900

♦ Depending on the operational power and the on-load factor ($\theta \leq 55^\circ\text{C}$ [131 °F]).

• Not UL Listed or CSA Certified.

TeSys™ IEC-Style Contactors and Starters Selection Guide

Contactor Selection for Utilization Category AC-3

Use in Category AC-3 (Ve < 440 Vac)

Control of 3-phase asynchronous squirrel cage motors with breaking while running.

The current broken (Ic) in category AC-3 is equal to the rated operational current (Ie) of the motor.

Use motor full-load current on horizontal axis for selection purposes.

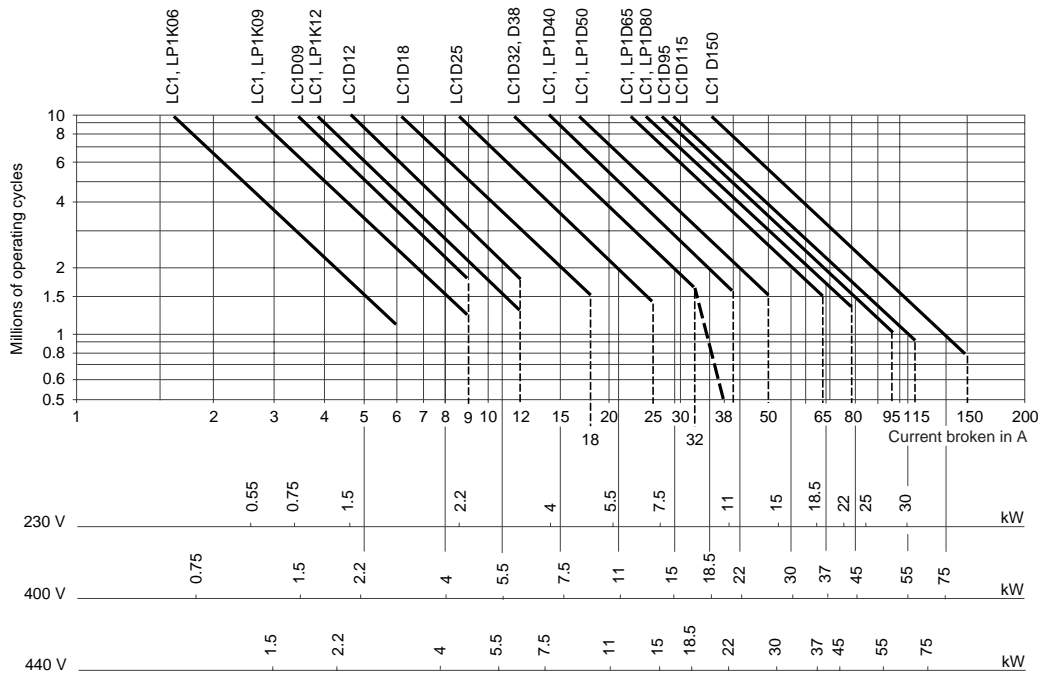

NOTE: The dotted lines relate to LC1D38 contactors only.

Operational power in kW-50 Hz.

Example: Asynchronous motor with P = 5.5 kW – Ve = 400 V – Ie = 11 A – Ic = Ie = 11 A; or
Asynchronous motor with P = 5.5 kW – Ve = 415 V – Ie = 11 A – Ic = Ie = 11 A.
3 million operating cycles required.

The above selection curves show the contactor rating needed: LC1D18 or LP1D18.

Use in Category AC-3 (Ve = 660/690 Vac)

Control of 3-phase asynchronous squirrel cage motors with breaking while running.

The current broken (Ic) in category AC-3 is equal to the rated operational current (Ie) of the motor.

Use motor full-load current on horizontal axis for selection purposes.

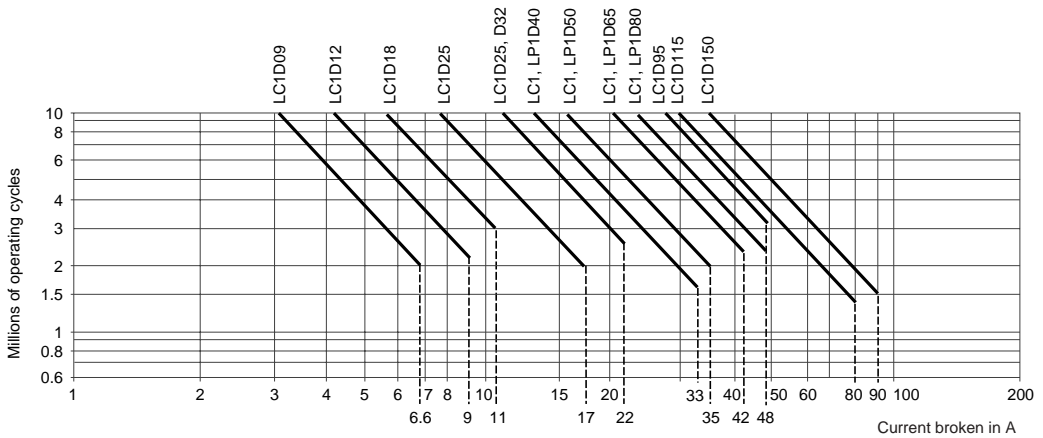

NOTE: For Ve = 1000 Vac, use the 660/690 Vac curves without exceeding the corresponding operational current at the operational power indicated for 1000 Vac.

TeSys™ IEC-Style Contactors and Starters Selection Guide

Contactor Selection for Utilization Category AC-3

Use in Category AC-3 ($V_e \leq 440$ Vac)

Control of 3-phase asynchronous squirrel cage motors with breaking while running.

The current broken (I_c) in category AC-3 is equal to the rated operational current (I_e) of the motor.

Use motor full-load current on horizontal axis for selection purposes.

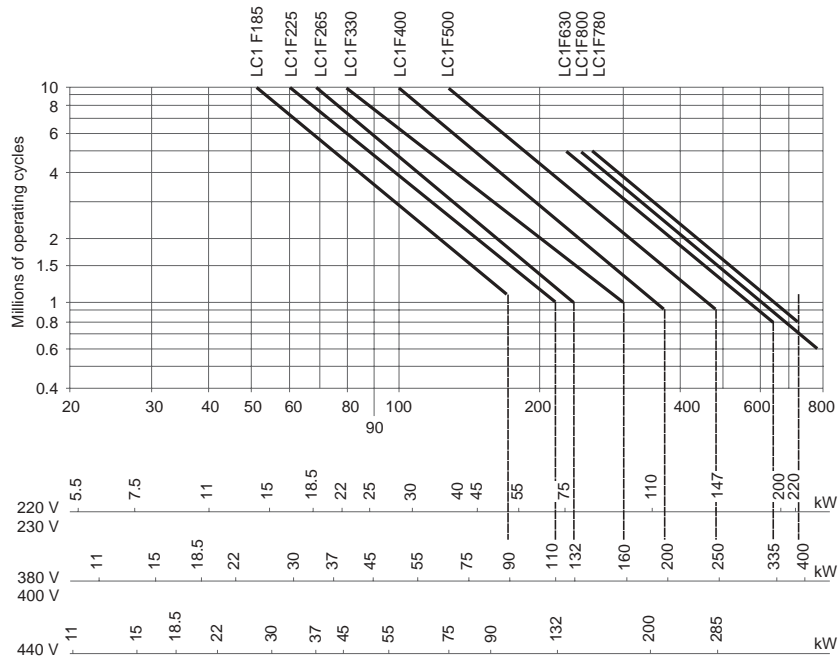

Operational power in kW-50 Hz.

Example: Asynchronous motor with $P = 132$ kW – $V_e = 380$ V – $I_e = 245$ A – $I_c = I_e = 245$ A; or Asynchronous motor with $P = 132$ kW – $V_e = 415$ V – $I_e = 240$ A – $I_c = I_e = 240$ A. 1.5 million operating cycles required.

The above selection curves show the contactor rating needed: LC1F330.

Use in Category AC-3 ($V_e = 660/690$ Vac)

Control of 3-phase asynchronous squirrel cage motors with breaking while running.

The current broken (I_c) in category AC-3 is equal to the rated operational current (I_e) of the motor.

Use motor full-load current on horizontal axis for selection purposes.

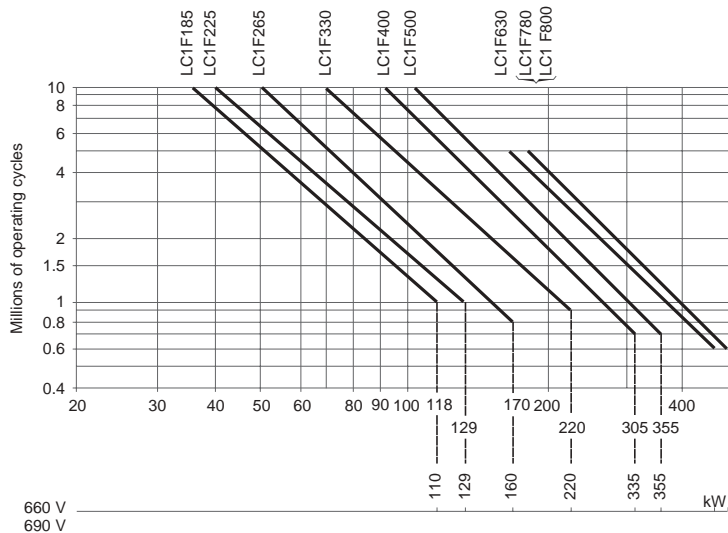

Example: Asynchronous motor with $P = 132$ kW – $V_e = 660$ V – $I_e = 140$ A – $I_c = I_e = 140$ A. 1.5 million operating cycles required.

The above selection curves show the contactor rating needed: LC1F330.

TeSys™ IEC-Style Contactors and Starters Selection Guide

Contactor Selection for Utilization Category AC-1

Maximum Operational Current (Open-mounted Device)

Contactor Size			LC1	LC1	LC1	LC1	LC1	LC1	LC1	LC1	LC1
			LC1	LP1	LP1	LP1	LP1	LP1	LP1	LP1	LP1
			K09	K12	D09	D12	D18	D25	D32	D38	D40
Maximum operating rate operating cycles/hour			600	600	600	600	600	600	600	600	600
Cabling to IEC 60947-1	cable c.s.a	mm ² (AWG)	4 (#12)	4 (#12)	4 (#12)	4 (#12)	6 (#10)	6 (#10)	10 (#8)	10 (#8)	16 (#6)
	bar c.s.a.	mm	–	–	–	–	–	–	–	–	–
Operational current in A, in AC-1 according to the ambient temperature to IEC 60947-1	≤ 40 °C (104 °F)	A	20	20	25	25	32	40	50	50	60
	≤ 55 °C (131 °F)	A	20	20	25	25	32	40	50	50	60
	≤ 70 °C (158 °F)	A (to Vc)	♦	♦	17	17	22	28	35	35	42
Maximum operational power ≤ 55°C	220/230 Vac	kW	8	8	9	9	11	14	18	18	21
	240 Vac	kW	8	8	9	9	12	15	19	19	23
	380/400 Vac	kW	14	14	15	15	20	25	31	31	37
	415 Vac	kW	14	14	17	17	21	27	34	34	41
	440 Vac	kW	15	15	18	18	23	29	36	36	43
	500 Vac	kW	17	17	20	20	23	33	41	41	49
	660/690 Vac	kW	22	22	27	27	34	43	54	54	65
	1000 Vac	kW	–	–	–	–	–	–	–	–	70

♦ Please consult our local representatives or agents.

Increase in operation current by paralleling of poles: Apply the following multiplying factors to the current or power values given above.

The factors take into account the often unbalanced current distribution between poles:

2 poles in parallel: K = 1.6

3 poles in parallel: K = 2.25

4 poles in parallel: K = 2.8

Use in Category AC-1 ($V_e \leq 440$ Vac)

Control of resistive circuits (power factor ≥ 0.95).

The current broken (I_c) in category AC-1 is equal to the current (I_e) normally drawn by the load.

Use motor full-load current on horizontal axis for selection purposes.

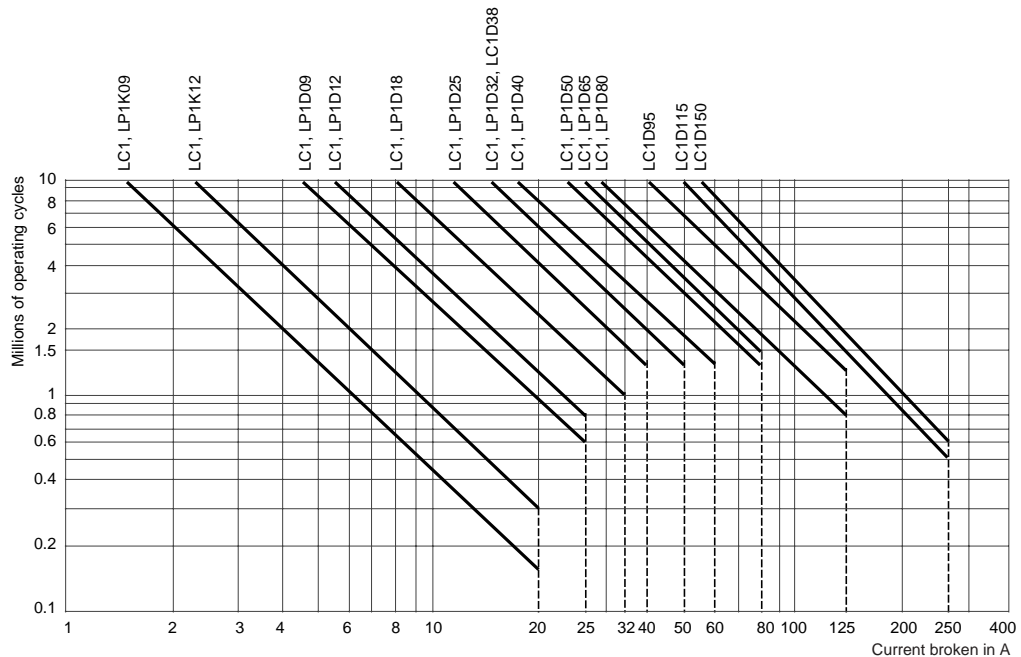

Example: $V_e = 220$ V – $I_e = 50$ A ($\theta \leq 40$ °C) – $I_c = I_e = 50$ A.

2 million operating cycles required.

The above selection curves show the contactor rating needed: LC1D50 or LP1D50.

TeSys™ IEC-Style Contactors and Starters Selection Guide

Contactor Selection for Utilization Category AC-1

Maximum Operational Current (Open-mounted Device)

Contactor Size			LC1 LP1	LC1 LP1	LC1 LP1	LC1	LC1	LC1	LC1	LC1	LC1	LC1	LC1	LC1	LC1		
			D50	D65	D80	D95	D115	D150	F185	F225	F265	F330	F400	F500	F630	F780	F800
Maximum operating rate operating cycles/hour			600	600	600	600	600	600	600	600	600	600	600	600	600	600	
Cabling to IEC 60947-1	cable c.s.a	mm ² (AWG)	25 (#4)	25 (#4)	50 (#0)	50 (#0)	120 (250 MCM)	120 (250 MCM)	150 (300 MCM)	185 (350 MCM)	185 (350 MCM)	240 (500 MCM)	-	-	-	-	
	Number of Bars		-	-	-	-	-	-	-	-	-	2	2	2	2	2	
	bar c.s.a.	mm	-	-	-	-	-	-	-	-	-	30 x 5	40 x 5	60 x 5	100 x 5	60 x 5	
		inches	-	-	-	-	-	-	-	-	-	1.18 x 0.2	1.57 x 0.2	2.36 x 0.2	4.0 x 0.2	2.36 x 0.2	
Operational current in A, in AC-1 according to the ambient temperature to IEC 60947-1	≤ 40 °C (104 °F)	A	80	80	125	125	250	250	275	315	350	400	500	700	1000	1600	1000
	≤ 55 °C (131 °F)	A	80	80	125	125	200	200	275	280	300	360	430	580	850	1350	850
	≤ 70 °C (158 °F)	A (to Vc)	56	56	80	80	160	160	180	200	250	290	340	500	700	1100	700
Maximum operational power ≤ 55°C (131°F)	220/230 Vac	kW	29	29	45	45	80	80	90	100	120	145	170	240	350	550	350
	240 Vac	kW	31	31	49	49	83	83	95	110	125	160	180	255	370	570	370
	380/400 Vac	kW	50	50	78	78	135	135	165	175	210	250	300	430	600	950	600
	415 Vac	kW	54	54	85	85	140	140	170	185	220	260	310	445	630	1000	630
	440 Vac	kW	58	58	90	90	150	150	180	200	230	290	330	470	670	1050	670
	500 Vac	kW	65	65	102	102	170	170	200	220	270	320	380	660	750	1200	750
	660/690 Vac	kW	86	86	135	135	235	235	280	300	370	400	530	740	1000	1650	1000
	1000 Vac	kW	85	100	120	120	345	345	410	450	540	640	760	950	1500	2400	1500

Increase in operation current by paralleling of poles: Apply the following multiplying factors to the current or power values given above.

The factors take into account the often unbalanced current distribution between poles:

2 poles in parallel: K = 1.6

3 poles in parallel:

K = 2.254 poles in parallel: K = 2.8

Use in Category AC-1 ($V_e \leq 440$ Vac)

Control of resistive circuits (power factor ≥ 0.95).

The current broken (I_c) in category AC-1 is equal to the current (I_e) normally drawn by the load.

Use motor full-load current on horizontal axis for selection purposes.

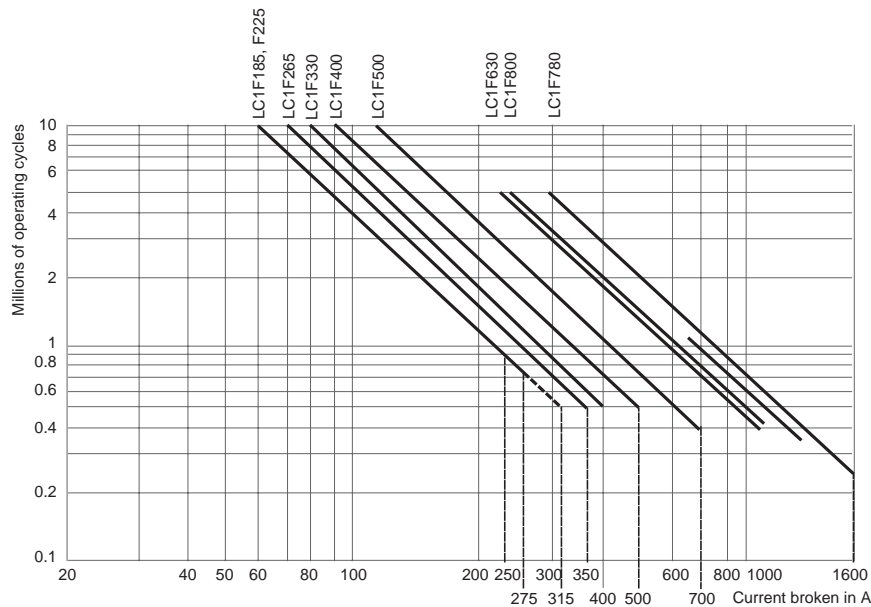

NOTE: The dotted lines relate to LC1F225 contactors only.

Example: $V_e = 220$ V – $I_e = 500$ A ($\theta \leq 40$ °C) – $I_c = I_e = 500$ A.

2 million operating cycles required.

The above selection curves show the contactor rating needed: LC1 F780.

TeSys™ IEC-Style Contactors and Starters Selection Guide

Contactors Selection for Utilization Categories AC-2 and AC-4

Utilization category AC-2 is for breaking the starting current of slip-ring motors, while utilization category AC-4 is for breaking the starting current of squirrel-cage motors.

Maximum Breaking Current for Categories AC-2 and AC-4

Contactor Size		LC1	LC1	LC1	LC1	LC1	LC1	LC1	LC1	LC1	LC1
		LP1	LP1	LP1	LP1	LP1	LP1	LP1	LP1	LP1	LP1
		K06	K09	K12	D09	D12	D18	D25	D32	D38	D40
In category AC-4 (Ie maximum) – Ve ≤ 440 Vac Ie maximum broken = 6 x I motor	A	36	54	54	54	72	108	150	192	192	240
– 440 Vac ≤ Ve ≤ 690 Vac Ie maximum broken = 6 x I motor	A	26	40	40	40	50	70	90	105	105	150

Depending on the maximum operating rate ♦ and the on-load factor, $\theta \leq 55^\circ\text{C}$ [131 °F] ■

From 150 & 15% to 300 & 10%	A	20	30	30	30	40	45	75	80	80	110
From 150 & 20% to 600 & 10%	A	18	27	27	27	36	40	67	70	70	96
From 150 & 30% to 1200 & 10%	A	16	24	24	24	30	35	56	60	60	80
From 150 & 55% to 2400 & 10%	A	13	19	19	19	24	30	45	50	50	62
From 150 & 85% to 3600 & 10%	A	10	16	16	16	21	25	40	45	45	53

♦ Do not exceed the maximum number of mechanical operating cycles.

■ For temperatures higher than 55 °C (131 °F), use a maximum operating rate value equal to 80% of the actual value when selecting from the above tables.

Plugging

The current varies from the maximum plug-braking current to the rated motor current. The making current must be compatible with the rated making and breaking capacities of the contactor. As breaking normally takes place at a current value at or near the locked rotor current, the contactor can be selected using the criteria for categories AC-2 and AC-4.

Permissible AC-4 Power Rating for 200,000 Operating Cycles

Operational Voltage		LC•	LC•	LC•	LC•	LC•	LC•	LC•	LC•	LC•	LC•
		LP•	LP•	LP•	LP•	LP•	LP•	LP•	LP•	LP•	LP•
		K06	K09	K12	D09	D12	D18	D25	D32	D38	D40
220/230 Vac	kW	0.75	1.1	1.1	1.5	1.5	2.2	3	4	4	4
380/400 Vac	kW	1.5	2.2	2.2	2.2	3.7	4	5.5	7.5	7.5	9
415 Vac	kW	1.5	2.2	2.2	2.2	3	3.7	5.5	7.5	7.5	9
440 Vac	kW	1.5	2.2	2.2	2.2	3	3.7	5.5	7.5	7.5	11
500 Vac	kW	2.2	3	3	3	4	5.5	7.5	9	9	11
660/690 Vac	kW	3	4	4	4	5.5	7.5	10	11	11	15

Note: Tables continue on next page.

TeSys™ IEC-Style Contactors and Starters Selection Guide

Contactor Selection for Utilization Categories AC-2 and AC-4

Maximum Breaking Current for Categories AC-2 and AC-4

Contactor Size		LC1 LP1	LC1 LP1	LC1 LP1	LC1	LC1	LC1	LC1	LC1	LC1	LC1	LC1	LC1	LC1	LC1	
		D50	D65	D80	D95	D115	D150	F185	F225	F265	F330	F400	F500	F630	F780	F800
In category AC-4 (Ie maximum) – Ve ≤ 440 Vac Ie maximum broken = 6 x I motor	A	300	390	480	570	630	830	1020	1230	1470	1800	2220	2760	3360	4260	3690
– 440 Vac ≤ Ve ≤ 690 Vac Ie maximum broken = 6 x I motor	A	170	210	250	250	540	640	708	810	1020	1410	1830	2130	2760	2910	2910

Depending on the maximum operating rate ♦ and the on-load factor, $\theta \leq 55^\circ\text{C}$ [131 °F] ■

From 150 & 15% to 300 & 10%	A	140	160	200	200	280	310	380	420	560	670	780	1100	1400	1600	1600
From 150 & 20% to 600 & 10%	A	120	148	170	170	250	280	350	400	500	600	700	950	1250	1400	1400
From 150 & 30% to 1200 & 10%	A	100	132	145	145	215	240	300	330	400	500	600	750	950	1100	1100
From 150 & 55% to 2400 & 10%	A	80	110	120	120	170	150	240	270	320	390	450	600	720	820	820
From 150 & 85% to 3600 & 10%	A	70	90	100	100	125	145	170	190	230	290	350	500	660	710	710

- ♦ Do not exceed the maximum number of mechanical operating cycles.
- For temperatures higher than 55 °C (131 °F), use a maximum operating rate value equal to 80% of the actual value when selecting from the above tables.

Plugging

The current varies from the maximum plug-braking current to the rated motor current. The making current must be compatible with the rated making and breaking capacities of the contactor. As breaking normally takes place at a current value at or near the locked rotor current, the contactor can be selected using the criteria for categories AC-2 and AC-4.

Permissible AC-4 Power Rating for 200,000 Operating Cycles

Operational Voltage		LC• LP•	LC• LP•	LC• LP•	LC•	LC1	LC1	LC1	LC1	LC1	LC1	LC1	LC1	LC1	LC1	
		D50	D65	D80	D95	D115	D150	F185	F225	F265	F330	F400	F500	F630	F780	F800
220/230 Vac	kW	5.5	7.5	7.5	9	9	11	22	25	30	37	40	45	55	63	63
380/400 Vac	kW	11	11	15	15	18.5	22	40	45	55	63	75	80	100	110	110
415 Vac	kW	11	11	15	15	18.5	22	45	51	59	75	80	90	100	110	110
440 Vac	kW	11	15	15	15	18.5	22	45	51	63	75	80	100	110	132	132
500 Vac	kW	15	18.5	22	22	37	30	51	59	75	80	90	110	132	150	150
660/690 Vac	kW	18.5	22	25	25	30	45	63	75	90	110	129	140	160	185	185

TeSys™ IEC-Style Contactors and Starters Selection Guide

Contactors Selection for Utilization Categories AC-2 and AC-4

Use in Categories AC-2 or AC-4 ($V_e \leq 440$ Vac)

Control of 3-phase asynchronous squirrel cage (AC-4) or slip-ring (AC-2) motors with breaking while motor stalled.

The current broken (I_c) in category AC-4 is equal to 6 times I_e , where I_e is the operational current of the motor.

Use motor-locked rotor current (6 times full-load current) on horizontal axis for selection purposes.

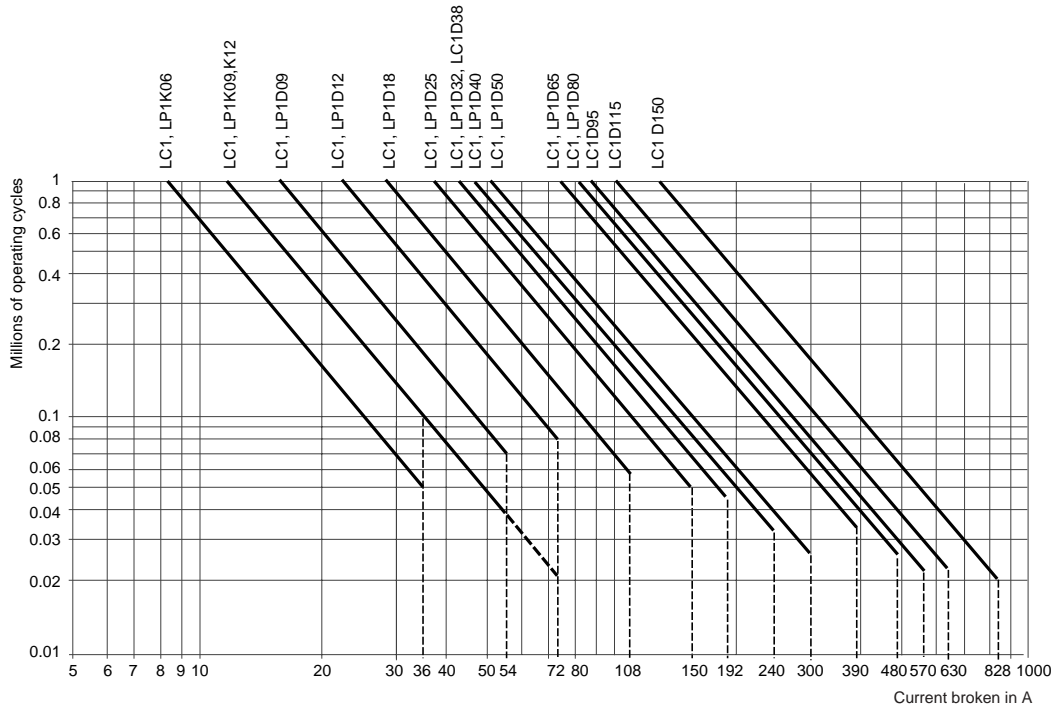

NOTE: The dotted lines relate to LC1K12 and LP1K12 contactors only.

Example: Asynchronous motor with $P = 5.5$ kW – $V_e = 400$ V – $I_e = 11$ A $I_c = 6 \times I_e = 66$ A; or
 Asynchronous motor with $P = 5.5$ kW – $V_e = 415$ V – $I_e = 11$ A $I_c = 6 \times I_e = 66$ A.
 200,000 operating cycles required.
 The above selection curves show the contactor rating needed: LC1D25 or LP1D25.

Use in Category AC-4 (440 Vac < $V_e \leq 690$ V)

Control of 3-phase asynchronous squirrel cage motors with breaking while motor stalled.

The current broken (I_c) in category AC-4 is equal to 6 times I_e , where I_e is the operational current of the motor.

Use motor-locked rotor current (6 times full-load current) on horizontal axis for selection purposes.

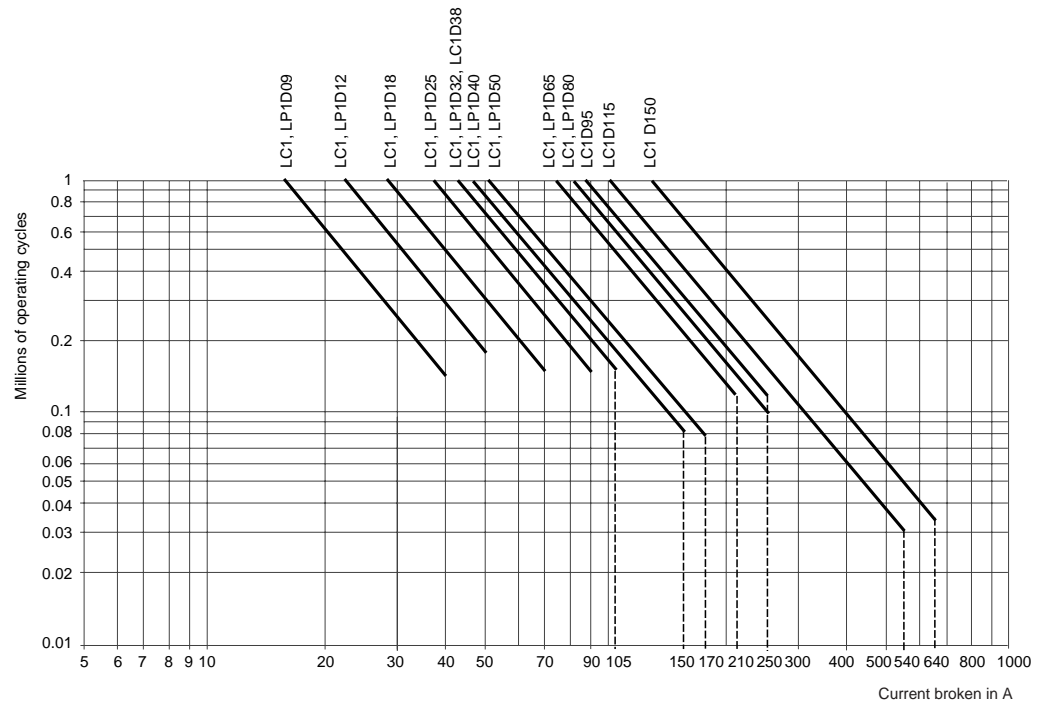

TeSys™ IEC-Style Contactors and Starters Selection Guide

Contactors Selection for Utilization Categories AC-2 and AC-4

Use in Categories AC-2 or AC-4 ($V_e \leq 440$ Vac)

Control of 3-phase asynchronous squirrel cage (AC-4) or slip-ring (AC-2) motors with breaking while motor stalled.

The current broken (I_c) in category AC-4 is equal to 6 times I_e , where I_e is the operational current of the motor.

Use motor-locked rotor current (6 times full-load current) on horizontal axis for selection purposes.

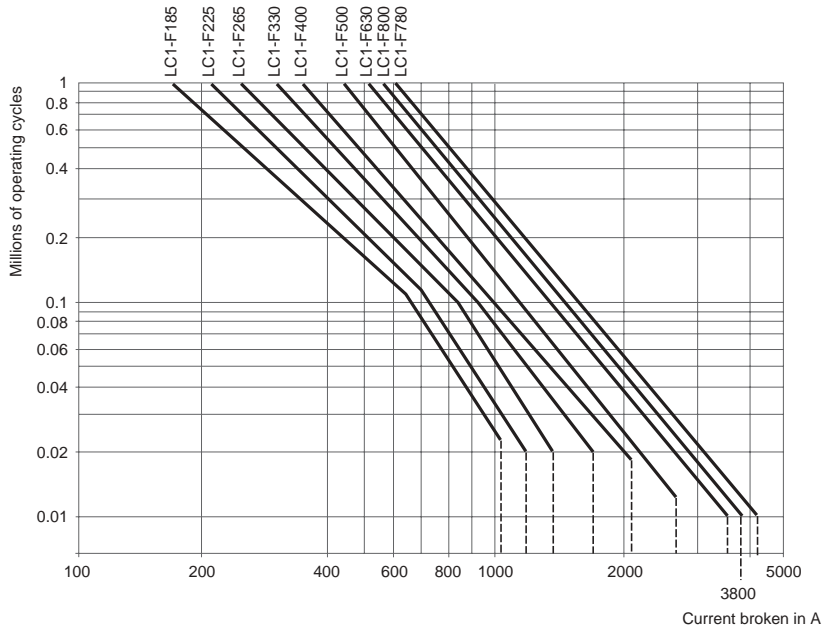

Example: Asynchronous motor with $P = 90$ kW – $V_e = 380$ V – $I_e = 170$ A $I_c = 6 \times I_e = 1020$ A; or
 Asynchronous motor with $P = 90$ kW – $V_e = 415$ V – $I_e = 165$ A $I_c = 6 \times I_e = 990$ A.
 60,000 operating cycles required.

The above selection curves show the contactor rating needed: LC1F265.

Use in Category AC-4 (440 Vac < $V_e \leq 690$ V)

Control of 3-phase asynchronous squirrel cage motors with breaking while motor stalled.

The current broken (I_c) in category AC-4 is equal to 6 times I_e , where I_e is the operational current of the motor.

Use motor-locked rotor current (6 times full-load current) on horizontal axis for selection purposes.

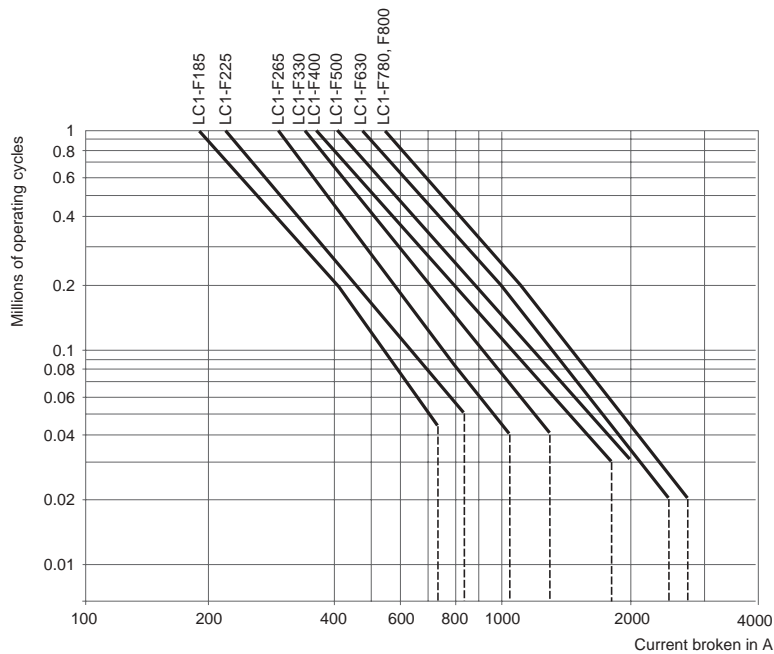

TeSys™ IEC-Style Contactors and Starters Selection Guide

Contactor Selection for Utilization Categories DC-1 to DC-5

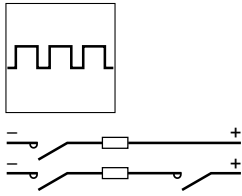

Rated Operational Current (Ie) in Amperes for Category DC-1

Resistive loads: time constant $\frac{L}{R} \leq 1$ ms, ambient $\theta \leq 55$ °C [131 °F]

Rated Operational Voltage Ve	Number of Poles Connected in Series	Contactor Rating ♦									
		LC1 LP1	LC1 LP1	LC1 LP1	LC1 LP1	LC1 LP1	LC1	LC1 LP1	LC1 LP1	LC1 LP1	LC1 LP1
		D09	D12	D18	D25	D32	D38	D40	D50	D65	D80
24 Vdc	1	15	15	15	30	30	30	40	50	50	70
	2	18	18	18	32	32	32	55	70	70	100
	3	20	20	20	32	32	32	55	70	70	100
	4	-	20	-	32	-	-	55	-	70	100
48/75 Vdc	1	12	12	12	25	25	25	25	25	25	25
	2	17	17	17	30	30	30	55	70	70	100
	3	20	20	20	32	32	32	55	70	70	100
	4	-	20	-	32	-	-	55	-	70	100
125 Vdc	1	6	6	8	8	8	8	8	8	8	8
	2	12	12	12	25	25	25	40	50	60	80
	3	15	15	15	27	27	27	45	60	65	85
	4	-	17	-	30	-	-	55	-	70	100
225 Vdc	1	4	4	5	5	5	5	5	5	5	5
	2	8	8	8	15	15	15	35	40	40	45
	3	10	10	10	22	22	22	40	50	50	55
	4	-	12	-	25	-	-	50	-	60	70
300 Vdc	3	-	-	-	-	-	-	-	-	-	-
	4	-	12	-	25	-	40	40	-	60	70
460 Vdc	4	-	-	-	-	-	-	-	-	-	-
900 Vdc	2	-	-	-	-	-	-	-	-	-	-
1200 Vdc	3	-	-	-	-	-	-	-	-	-	-
1500 Vdc	4	-	-	-	-	-	-	-	-	-	-

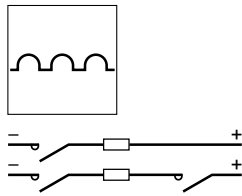

Rated Operational Current (Ie) in Amperes for Categories DC-2 to DC-5

Inductive loads: time constant $\frac{L}{R} \leq 15$ ms, ambient $\theta \leq 55$ °C [131 °F]

Rated Operational Voltage Ve	Number of Poles Connected in Series	Contactor Rating ♦									
		LC1 LP1	LC1 LP1	LC1 LP1	LC1 LP1	LC1 LP1	LC1	LC1 LP1	LC1 LP1	LC1 LP1	LC1 LP1
		D09	D12	D18	D25	D32	D38	D40	D50	D65	D80
24 Vdc	1	12	12	12	20	20	20	25	35	35	40
	2	15	15	15	25	25	25	30	45	45	60
	3	18	18	18	30	30	30	45	55	55	80
	4	-	18	-	30	-	-	50	-	60	90
48/75 Vdc	1	10	10	10	15	15	15	15	15	15	15
	2	12	12	12	20	20	20	25	40	40	50
	3	15	15	15	30	30	30	40	50	50	70
	4	-	15	-	30	-	-	50	-	60	90
125 Vdc	1	2	2	2	2.5	2.5	2.5	2.5	2.5	2.5	2.5
	2	8	8	8	15	15	15	20	25	25	40
	3	12	12	12	20	20	20	30	35	35	60
	4	-	15	-	25	-	-	40	-	50	72
225 Vdc	1	0.75	0.75	0.75	1	1	1	1	1	1	1
	2	1.5	1.5	1.5	3	3	3	4	5	5	7
	3	6	6	6	10	10	10	20	25	25	35
	4	-	8	-	15	-	-	25	-	30	40
300 Vdc	3	-	-	-	-	-	-	-	-	-	-
	4	-	6	-	10	-	-	20	-	25	35
460 Vdc	1	-	-	-	-	-	-	-	-	-	-
900 Vdc	2	-	-	-	-	-	-	-	-	-	-
1200 Vdc	3	-	-	-	-	-	-	-	-	-	-
1500 Vdc	4	-	-	-	-	-	-	-	-	-	-

♦ For rated operational currents of contactors LC1 and LP1K, please consult your Local Square D Field Sales Office.

Continued on next page.

TeSys™ IEC-Style Contactors and Starters Selection Guide

Contactor Selection for Utilization Categories DC-1 to DC-5

Rated Operational Current (Ie) in Amperes for Category DC-1

Resistive loads: time constant $\frac{L}{R} \leq 1$ ms, ambient $\theta \leq 55$ °C [131 °F]

Rated Operational Voltage Ve	Number of Poles Connected in Series	Contactor Rating											
		LC1	LC1	LC1	LC1	LC1	LC1	LC1	LC1	LC1	LC1	LC1	LC1
		D95	D115	D150	F185	F225	F265	F330	F400	F500	F630	F780	F800
24 Vdc	1	70	200	200	240	260	300	360	430	580	850	1300	850
	2	100	200	200	240	260	300	360	430	580	850	1300	850
	3	100	200	200	240	260	300	360	430	580	850	1300	850
	4	–	200	–	240	260	300	360	430	580	850	1300	850
48/75 Vdc	1	25	200	200	240	260	300	360	430	580	850	1300	850
	2	100	200	200	240	260	300	360	430	580	850	1300	850
	3	100	200	200	240	260	300	360	430	580	850	1300	850
	4	–	200	–	240	260	300	360	430	580	850	1300	850
125 Vdc	1	8	180	180	210	230	270	320	380	520	760	1180	760
	2	80	180	180	210	230	270	320	380	520	760	1180	760
	3	85	200	200	240	260	300	360	430	580	850	1300	850
	4	–	200	–	240	260	300	360	430	580	850	1300	850
225 Vdc	1	5	160	160	–	–	–	–	–	–	–	–	–
	2	45	160	160	190	200	250	280	350	450	700	1000	700
	3	55	200	200	240	260	300	360	430	580	850	1300	850
	4	–	200	–	240	260	300	360	430	580	850	1300	850
300 Vdc	3	–	140	140	190	200	250	280	350	450	700	1000	700
	4	–	180	–	240	260	300	360	430	580	850	1000	850
460 Vdc	4	–	140	–	190	200	250	280	350	450	700	1000	700
900 Vdc	2	–	–	–	–	–	–	–	–	–	–	–	–
1200 Vdc	3	–	–	–	–	–	–	–	–	–	–	–	–
1500 Vdc	4	–	–	–	–	–	–	–	–	–	–	–	–

Rated Operational Current (Ie) in Amperes for Categories DC-2 to DC-5

Inductive loads: time constant $\frac{L}{R} \leq 15$ ms, ambient $\theta \leq 55$ °C [131 °F]

Rated Operational Voltage Ve	Number of Poles Connected in Series	Contactor Rating ♦											
		LC1	LC1	LC1	LC1	LC1	LC1	LC1	LC1	LC1	LC1	LC1	LC1
		D95	D115	D150	F185	F225	F265	F330	F400	F500	F630	F780	F800
24 Vdc	1	40	200	200	240	260	300	360	430	580	850	1300	850
	2	60	200	200	240	260	300	360	430	580	850	1300	850
	3	80	200	200	240	260	300	360	430	580	850	1300	850
	4	–	200	–	240	260	300	360	430	580	850	1300	850
48/75 Vdc	1	15	200	200	240	260	300	360	430	580	850	1300	850
	2	50	200	200	240	260	300	360	430	580	850	1300	850
	3	70	200	200	240	260	300	360	430	580	850	1300	850
	4	–	200	–	240	260	300	360	430	580	850	1300	850
125 Vdc	1	2.5	100	100	–	–	–	–	–	–	–	–	–
	2	40	140	140	160	180	250	300	350	500	700	1000	700
	3	60	200	220	240	240	280	310	350	550	850	1000	850
	4	–	200	–	240	240	280	310	350	550	850	1000	850
225 Vdc	1	1	100	100	–	–	–	–	–	–	–	–	–
	2	7	120	120	140	160	220	280	310	480	680	900	680
	3	35	140	140	160	180	250	300	350	500	700	1000	700
	4	–	180	–	240	260	300	360	430	580	850	1300	850
300 Vdc	3	–	100	100	140	160	220	280	310	480	680	900	680
	4	–	180	–	240	260	300	360	430	580	850	1300	850
460 Vdc	1	–	–	–	–	–	–	–	–	–	–	–	–
	4	–	100	100	140	160	220	280	310	480	680	800	680
900 Vdc	2	–	–	–	–	–	–	–	–	–	–	–	–
1200 Vdc	3	–	–	–	–	–	–	–	–	–	–	–	–
1500 Vdc	4	–	–	–	–	–	–	–	–	–	–	–	–

♦ For rated operational currents of contactors LC1 and LP1K, please consult your Local Square D Field Sales Office.

TeSys™ IEC-Style Contactors and Starters Selection Guide

Contactor Selection for Utilization Categories DC-1 to DC-5

Use in Category DC-1 to DC-5

The criteria for contactor selection are:

- The rated operational current I_e .
- The rated operational voltage V_e (see page 31).
- The utilization category and the time constant L/R (see page 31)
- The required electrical durability.

Maximum Operating Rate (Operating Cycles)

The following operating rate must not be exceeded: 120 operating cycles/hour at rated operational current I_e .

Electrical Durability

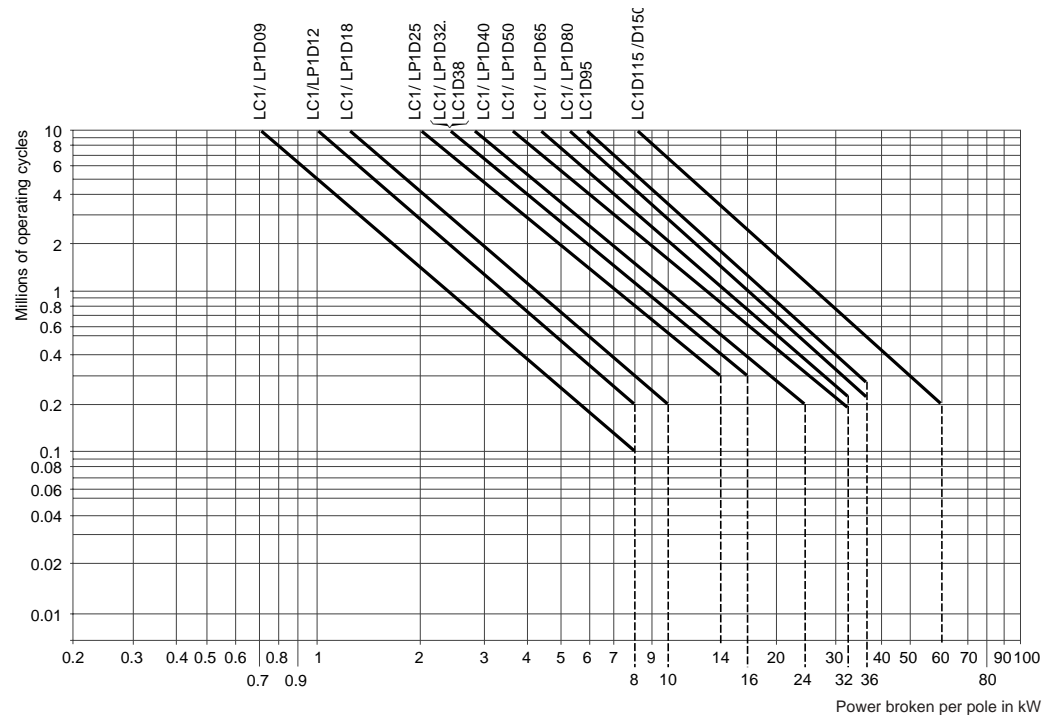

Example: Series-wound motor with $P = 1.5$ kW, $V_e = 200$ V, and $I_e = 7.5$ A.
 Application: counter-current braking and inching (utilization category DC-5).
 Select a contactor type LC1D25 or LP1D25 with 3 poles in series.
 The power broken is: $P_c \text{ total} = 2.5 \times 200 \times 7.5 = 3.75$ kW.
 The power broken per pole is: 1.25 kW.
 The electrical durability read from the curve above is ≥ 106 operating cycles.

Use of Poles in Parallel

Electrical durability can be increased by using poles connected in parallel. With N poles connected in parallel, the electrical durability becomes: electrical durability read from the curves $\times N \times 0.7$.

NOTE: Connecting the poles in parallel does not allow the maximum operational currents indicated on pages 28 and 29 to be exceeded.

NOTE: Ensure that the connections are made in such a way as to equalize the currents in each pole.

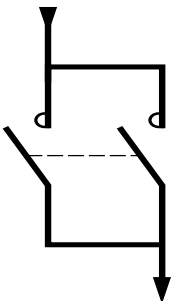

TeSys™ IEC-Style Contactors and Starters Selection Guide

Contactor Selection for Utilization Categories DC-1 to DC-5

Telemecanique offers a line of contactors for applications involving DC control circuits. It does not matter whether the power circuit is AC or DC. There are two considerations when using these contactors in applications involving a DC power circuit:

1. Voltage per pole must not be exceeded.

On D-line contactors, you can use the AC inductive/resistive rating as long as the voltage does not exceed 75 volts per pole. On F-line contactors, the voltage must not exceed 125 volts per pole. However, by wiring the contacts in **series**, you can multiply the number of poles in series by the maximum voltage allowed per pole.

Example 1: D-Line contactors (9 - 38 amps)

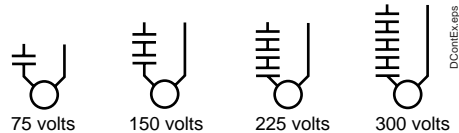

On AC power circuits, follow regular procedures.

Example 2: F-Line & D115, D150 contactors

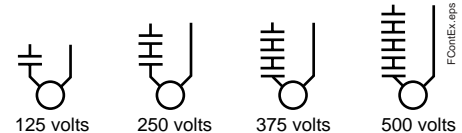

2. $L/R \leq 15$ ms without derating.

A time constant is defined as the length of time it takes the current to rise from 0 to 63.2% of its maximum value, or to decay to 36.8% of its maximum value. Time constants are measured in seconds. The inductance (L) is measured in henries and the resistance (R) is measured in ohms.

In a pure resistive circuit, current reaches its maximum value when the circuit is energized. Because inductance opposes a change in current flow and tends to hold back current, the time constant will increase as the circuit inductance is increased. As the time constant exceeds 15 ms, the electrical life of the contactor is affected and a derating factor (normally one contactor size) is needed to compensate for this loss. In most applications this time constant will be under 15 ms. It is a good idea, however, to check with the motor manufacturer.

TeSys™ IEC-Style Contactors and Starters Selection Guide

Voltage Code Tables

Voltage Code Tables _ See notes pertaining to each product line at the end of this table.

Voltage	Frequency	K-line				D-line			F-line					
		LC1K LC2K Notes K1, K2	LC7K LC8K Note K4	LP1K LP2K Notes K2, K3	LP4K LP5K	LC1D09 - D38 LC2D09 - D38 Notes D1, D3	LC1D40 - D95 LC2D40 - D95 Note D1	LC1D115 - D150 Note D1, D2, D4	LC1F115 - F225 Note F1, F2	LC1F265 - F400 Note F1, F2	LC1F500 - F630 Note F1, F2	LC1F780 Note F1, F2	LC1F800 Note F1, F2, F3,	
5	Low Consump DC	-	-	-	-	AL	-	-	-	-	-	-	-	
12	50/60	J7	-	-	-	J7	-	-	-	-	-	-	-	
	50	-	-	-	-	-	J5	-	-	-	-	-	-	
	DC	-	-	JD	-	JD	JD	-	-	-	-	-	-	
	Low Consump DC	-	-	-	JW3	JL	-	-	-	-	-	-	-	
	Wide Range DC	-	-	-	-	-	JW	-	-	-	-	-	-	
20	50/60	Z7	-	-	-	-	Z7	-	-	-	-	-	-	
	50	-	-	-	-	-	Z5	-	-	-	-	-	-	
	60	-	-	-	-	-	Z6	-	-	-	-	-	-	
	DC	-	-	ZD	-	-	-	-	-	-	-	-	-	
	Low Consump DC	-	-	-	ZW3	ZL	-	-	-	-	-	-	-	
24	50/60	B7 Note K2	B7	-	-	B7	B7	B7	-	-	-	-	-	
	50	-	-	-	-	-	B5	B5	B5	-	-	-	-	
	60	-	-	-	-	-	B6	B6	B6	-	-	-	-	
	40-400	-	-	-	-	-	-	-	-	B7 Note F4	-	-	-	
	DC	-	-	BD Note K2	-	BD	BD	BD	BD	BD	BD Note F4	-	-	-
	Low Consump DC	-	-	-	BW3	BL	-	-	-	-	-	-	-	
	Wide Range DC	-	-	-	-	-	BW	-	-	-	-	-	-	
36	50/60	C7	-	-	-	CC7	-	-	-	-	-	-	-	
	DC	-	-	CD	-	CD	CD	CD	-	-	-	-	-	
	Wide Range DC	-	-	-	-	-	CW	-	-	-	-	-	-	
42	50/60	D7	D7	-	-	D7	D7	D7	-	-	-	-	-	
	50	-	-	-	-	-	D5	D5	D5	-	-	-	-	
	60	-	-	-	-	-	-	-	-	-	-	-	-	
48	50/60	E7	E7	-	-	E7	E7	E7	-	-	-	-	-	
	50	-	-	-	-	-	E5	E5	E5	-	-	-	-	
	60	-	-	-	-	-	E6	E6	E6	-	-	-	-	
	40-400	-	-	-	-	-	-	-	-	E7	E7	-	-	
	DC	-	-	ED	-	ED	ED	ED	ED	ED	ED	-	-	
	Low Consump DC	-	-	-	EW3	EL	-	-	-	-	-	-	-	
	Wide Range DC	-	-	-	-	-	EW	-	-	-	-	-	-	
60	50/60	-	-	-	-	EE7	-	-	-	-	-	-	-	
	DC	-	-	ND	-	ND	ND	ND	-	-	-	-	-	
72	DC	-	-	SD	-	SD	SD	SD	-	-	-	-	-	
	Low Consump DC	-	-	-	SW3	SL	-	-	-	-	-	-	-	
	Wide Range DC	-	-	-	-	-	SW	-	-	-	-	-	-	
96	Low Consump DC	-	-	-	-	DL	-	-	-	-	-	-	-	

TeSys™ IEC-Style Contactors and Starters Selection Guide

Voltage Code Tables

Voltage Code Tables (Continued) _ See notes pertaining to each product line at the end of this table.

Voltage	Frequency	K-line				D-line			F-line				
		LC1K LC2K Notes K1, K2	LC7K LC8K Note K4	LP1K LP2K Note K2, K3	LP4K LP5K	LC1D09 - D38 LC2D09 - D38 Notes D1, D3	LC1D40 - D95 LC2D40 - D95 Note D1	LC1D115 - D150 Note D1, D2, D4	LC1F115 - F225 Note F1, F2	LC1F265 - F400 Note F1, F2	LC1F500 - F630 Note F1, F2	LC1F780 Note F1, F2	LC1F800 Note F1, F2, F3,
100	50/60	-	-	-	-	K7	K7	-	-	-	-	-	-
	DC	-	-	KD	-	-	-	-	-	-	-	-	-
110	50/60	F7	F7	-	-	F7	F7	F7	-	-	-	-	-
	50	-	-	-	-	-	F5	F5	F5	-	-	-	-
	60	-	-	-	-	-	F6	F6	F6	-	-	-	-
	40-400	-	-	-	-	-	-	-	F7	F7	F7	F7	-
	DC	-	-	FD	-	FD	FD	FD	FD	FD	FD	FD	FW
	Low Consump DC	-	-	-	FW3	FL	-	-	-	-	-	-	-
	Wide Range DC	-	-	-	-	-	FW	-	-	-	-	-	-
110/127	40-400	-	-	-	-	-	-	-	-	-	-	-	FE7
115	50/60	FE7	FE7	-	-	FE7	FE7	FE7	-	-	-	-	-
	50	-	-	-	-	-	FE5	FE5	FE5	-	-	-	-
	40-400	-	-	-	-	-	-	-	FE7	FE7	FE7	FE7	-
120	50/60	G7	G7	-	-	G7	G7	G7	-	-	-	-	-
	50	-	-	-	-	-	-	-	-	-	-	-	-
	60	-	-	-	-	-	G6	G6	G6	-	-	-	-
	40-400	-	-	-	-	-	-	-	G7	G7 Note F5	F7	F7	-
	DC	-	-	-	-	-	-	-	-	-	-	-	FW
	Low Consump DC	-	-	-	GW3	-	-	-	-	-	-	-	-
125	DC	-	-	GD	-	GD	GD	GD	GD	GD	GD	GD	-
127	50/60	FC7	-	-	-	FC7	-	FC7	-	-	-	-	-
	60	-	-	-	-	-	G5	FC5	G5	-	-	-	-
	40-400	-	-	-	-	-	-	-	G7	G7	G7	G7	-
155	DC	-	-	PD	-	-	-	-	-	-	-	-	
174	DC	-	-	QD	-	-	-	-	-	-	-	-	
200	50/60	-	-	-	-	L7	L7	-	-	-	-	-	-
	DC	-	-	LD	-	-	-	-	-	-	-	-	-
200/208	50/60	L7	-	-	-	-	-	-	-	-	-	-	-
	60	-	-	-	-	-	-	-	L6	-	-	-	-
208	40-400	-	-	-	-	-	-	-	-	L7	L7	L7	-
	50/60	-	-	-	-	LE7	LE7	LE7	-	-	-	-	-
	60	-	-	-	-	-	L6	L6	-	-	-	-	-
220	40-400	-	-	-	-	-	-	-	L7	-	-	-	-
	50/60	-	M7	-	-	M7	M7	M7	-	-	-	-	-
	50	-	-	-	-	-	-	M5	M5	-	-	-	-
	60	-	-	-	-	-	M6	M6	M6	-	-	-	-
	40-400	-	-	-	-	-	-	-	M7	M7	M7	M7	-
	DC	-	-	MD	-	MD	MD	MD	-	MD	MD	MD	-
220/230	Low Consump DC	-	-	-	-	ML	-	-	-	-	-	-	-
	Wide Range DC	-	-	-	-	-	MW	-	-	-	-	-	-
220/240	50/60	M7	-	-	-	-	-	-	-	-	-	-	-
	50	-	-	-	-	-	M5	-	-	-	-	-	-
	60	-	-	-	-	-	-	-	-	-	-	-	-
	40-400	-	-	-	-	-	-	-	-	-	-	-	-
220/240	DC	-	-	-	-	-	-	-	MD	-	-	-	-
	40-400	-	-	-	-	-	-	-	-	-	-	-	P7
DC	-	-	-	-	-	-	-	-	-	-	-	MW	

TeSys™ IEC-Style Contactors and Starters Selection Guide

Voltage Code Tables

Voltage Code Tables (Continued) _ See notes pertaining to each product line at the end of this table.

Voltage	Frequency	K-line				D-line			F-line				
		LC1K LC2K Notes K1, K2	LC7K LC8K Note K4	LP1K LP2K Note K2, K3	LP4K LP5K	LC1D09 - D38 LC2D09 - D38 Notes D1, D3	LC1D40 - D95 LC2D40 - D95 Note D1	LC1D115 - D150 Note D1, D2, D4	LC1F115 - F225 Note F1, F2	LC1F265 - F400 Note F1, F2	LC1F500 - F630 Note F1, F2	LC1F780 Note F1, F2	LC1F800 Note F1, F2, F3,
230	50/60	P7	-	-	-	P7	P7	P7	-	-	-	-	-
	50	-	-	-	-	U7	P5	P5	P5	-	-	-	-
	60	-	-	-	-	-	-	-	-	-	-	-	-
	40-400	-	-	-	-	-	-	-	P7	P7	P7	P7	-
	DC	-	-	MPD	-	-	-	-	-	-	-	-	-
230/240	50/60	U7 Note K4	U7	-	-	-	-	-	-	-	-	-	-
240	50/60	-	-	-	-	U7	U7	U7	-	-	-	-	-
	50	-	-	-	-	-	U5	U5	U5	-	-	-	-
	60	-	-	-	-	-	U6	U6	U6	-	-	-	-
	40-400	-	-	-	-	-	-	-	U7	U7	U7	U7	-
	DC	-	-	MUD	-	-	-	-	-	-	-	-	-
250	DC	-	-	UD	-	UD	UD	UD	UD	UD	UD	UD	-
	Low Consump DC	-	-	-	-	UL	-	-	-	-	-	-	-
256	50/60	W7	-	-	-	-	-	-	-	-	-	-	-
	50	-	-	-	-	-	W5	-	-	-	-	-	-
277	50/60	UE7	-	-	-	W7	-	UE7	-	-	-	-	-
	50	-	-	-	-	-	W6	W6	W5	-	-	-	-
	40-400	-	-	-	-	-	-	-	-	W7	W7	W7	-
380	50/60	-	-	-	-	Q7	Q7	Q7	-	-	-	-	-
	50	-	-	-	-	-	-	Q5	Q5	-	-	-	-
	60	-	-	-	-	-	Q6	Q6	Q6	-	-	-	-
	40-400	-	-	-	-	-	-	-	Q7	Q7	Q7	Q7	-
380/400	50/60	Q7 Note K4	-	-	-	-	-	-	-	-	-	-	-
	50	-	-	-	-	-	Q5	-	-	-	-	-	-
	60	-	-	-	-	-	-	-	-	-	-	-	-
	40-400	-	-	-	-	-	-	-	-	-	-	-	-
	DC	-	-	-	-	-	-	-	-	-	-	-	QW
380/440	40-400	-	-	-	-	-	-	-	-	-	-	-	V7
400	50/60	V7	-	-	-	V7	V7	V7	-	-	-	-	-
	50	-	-	-	-	-	V5	V5	V5	-	-	-	-
	40-400	-	-	-	-	-	-	-	V7	V7	V7	V7	-
400/415	50/60	N7	-	-	-	-	-	-	-	-	-	-	
415	50/60	-	-	-	-	N7	N7	N7	-	-	-	-	-
	50	-	-	-	-	-	N5	N5	N5	-	-	-	-
	40-400	-	-	-	-	-	-	-	N7	N7	N7	N7	-
415-440	50	-	-	-	-	-	-	-	-	-	-	-	-
	40-400	-	-	-	-	-	-	-	-	-	-	-	-
440	50/60	R7	-	-	-	R7	R7	R7	-	-	-	-	-
	50	-	-	-	-	-	R5	R5	-	-	-	-	-
	60	-	-	-	-	-	R6	R6	R6	-	-	-	-
	40-400	-	-	-	-	-	-	-	R7	R7	R7	R7	-
	DC	-	-	-	-	RD	RD	RD	-	RD	RD	RD	-
440/460	DC	-	-	-	-	-	-	-	RD	-	-	-	-
460/480	60	-	-	-	-	-	-	-	Q5	-	-	-	-
480	50/60	T7	-	-	-	T7	-	T7	-	-	-	-	-
	50	-	-	-	-	-	-	-	-	-	-	-	-
	60	-	-	-	-	-	T6	T6	-	-	-	N7	-
	40-400	-	-	-	-	-	-	-	-	S7 Note F4	-	-	-

TeSys™ IEC-Style Contactors and Starters Selection Guide

Voltage Code Tables

Voltage Code Tables (Continued) _ See notes pertaining to each product line at the end of this table.

Voltage	Frequency	K-line				D-line			F-line				
		LC1K LC2K Notes K1, K2	LC7K LC8K Note K4	LP1K LP2K Note K2, K3	LP4K LP5K	LC1D09 - D38 LC2D09 - D38 Notes D1, D3	LC1D40 - D95 LC2D40 - D95 Note D1	LC1D115 - D150 Note D1, D2, D4	LC1F115 - F225 Note F1, F2	LC1F265 - F400 Note F1, F2	LC1F500 - F630 Note F1, F2	LC1F780 Note F1, F2	LC1F800 Note F1, F2, F3,
500	50/60	S7	-	-	-	S7	-	S7	-	-	-	-	-
	50	-	-	-	-	-	S5	S5	S5	-	-	-	-
	40-400	-	-	-	-	-	-	-	S7	S7	S7	S7	-
575	50/60	SC7	-	-	-	SC7	-	-	-	-	-	-	-
	60	-	-	-	-	-	S6	-	-	-	-	-	-
600	50/60	X7	-	-	-	X7	-	-	-	-	-	-	-
	60	-	-	-	-	-	X6	-	-	-	-	-	-
	40-400	-	-	-	-	-	-	-	-	-	X7	-	-
660	50	-	-	-	-	Y5	Y5	-	-	-	-	-	-
	60	-	-	-	-	-	-	-	Y6	-	-	-	-
660/690	50/60	Y7	-	-	-	-	-	-	-	-	-	-	-

Notes:

K-Line:

K1 Up to and including 240 V, coil with integral suppression device (bi-directional diode): add 2 to the requested voltage code. Ex. J72

K2 For voltage codes B7 or BD, when connecting an electronic sensor or timer in series with the coil of the control relay, select a 20 V coil (Voltage code Z7 for AC or ZD for DC). This coil compensates for incurred voltage drop.

K3 Coil with integral suppression device available (bidirectional diode): add 3 to the requested voltage code. Ex JD3.

K4 For voltage codes M7, U7, Q7, N7, Y7 and all LC7K and LC8K devices, operating range is 0.85 - 1.10 of nominal. For all other LC1K and LC2K the operating range is 0.80 - 1.15 of nominal.

D line:

D1 For operating ranges refer to technical data section of the D-line contactors. Ranges vary as a function of the current rating of the contactor and type of supply (AC/DC)

D2 LC1-D150 Contactors utilize dual frequency 50/60 Hz. coils only. Single frequency coils are not available.

D3 LC1D09 -LC1D38 contactors with DC coil have integral suppression device (bi-directional diode) as standard.

D4 D115 and D150 coils have integral suppression device fitted as standard.

F-Line:

F1 For operating ranges refer to technical data section of the F-line contactors. Ranges vary as a function of the supply (AC/DC).

F2 For non-stock voltage codes, order contactor and coil separately. See page 202 - 209 for coils.

F3 Built in surge suppressor included on LC1F800 coils.

F4 For use with LC1F265 and LC1F330 only.

F5 For LC1-F400 contactor with 120VAC coil, use F7 code.

TeSys™ IEC-Style Contactors and Starters Selection Guide

Definitions and Comments

Altitude	<p>The low oxygen atmosphere at high altitudes reduces the dielectric strength of the air and hence the rated operational voltage of the contactor. It also reduces the cooling effect of the air and hence the rated operational current of the contactor (unless the temperature drops at the same time).</p> <p>No derating is necessary up to 3000 m (9,840 ft.). Derating factors to be applied above this altitude for main pole operational voltage and current (AC supply) are as follows.</p> <table border="1" style="margin-left: auto; margin-right: auto;"> <thead> <tr> <th>Altitude</th> <th>3500 m (11,480 ft.)</th> <th>4000 m (13,120 ft.)</th> <th>4500 m (14,760 ft.)</th> <th>5000 m (16,400 ft.)</th> </tr> </thead> <tbody> <tr> <td>Rated operational voltage</td> <td>0.90</td> <td>0.80</td> <td>0.70</td> <td>0.60</td> </tr> <tr> <td>Rated operational current</td> <td>0.92</td> <td>0.90</td> <td>0.88</td> <td>0.86</td> </tr> </tbody> </table>					Altitude	3500 m (11,480 ft.)	4000 m (13,120 ft.)	4500 m (14,760 ft.)	5000 m (16,400 ft.)	Rated operational voltage	0.90	0.80	0.70	0.60	Rated operational current	0.92	0.90	0.88	0.86
Altitude	3500 m (11,480 ft.)	4000 m (13,120 ft.)	4500 m (14,760 ft.)	5000 m (16,400 ft.)																
Rated operational voltage	0.90	0.80	0.70	0.60																
Rated operational current	0.92	0.90	0.88	0.86																
Ambient air temperature	<p>The temperature of the air surrounding the device, measured near to the device. The operating characteristics are given:</p> <ul style="list-style-type: none"> • with no restriction for temperatures between –5 and +55 °C (+23 and +131 °F) • with restrictions, if necessary, for temperatures between –50 and +70 °C (–58 and +149 °F) 																			
Rated operational current (Ie)	<p>This is defined taking into account the rated operational voltage, operating rate and duty, utilization category and ambient temperature around the device.</p>																			
Rated conventional thermal current (Ith) ♦	<p>The current which a closed contactor can sustain for a minimum of 8 hours without its temperature rise exceeding the limits given in the standards.</p>																			
Permissible short time rating	<p>The current which a closed contactor can sustain for a short time after a period of no load, without dangerous overheating.</p>																			
Rated operational voltage (Ve)	<p>This is the voltage value which, in conjunction with the rated operational current, determines the use of the contactor or starter, and on which the corresponding tests and the utilization category are based. For three-phase circuits it is expressed as the voltage between phases. Apart from exceptional cases such as rotor short-circuiting, the rated operational voltage Ve is less than or equal to the rated insulation voltage Vi.</p>																			
Rated control circuit voltage (Vc)	<p>The rated value of the control circuit voltage, on which the operating characteristics are based. For AC applications, the values are given for a near sinusoidal wave form (less than 5% total harmonic distortion).</p>																			
Rated insulation voltage (Vi)	<p>This is the voltage value used to define the insulation characteristics of a device and referred to in dielectric tests determining leakage paths and creepage distances. As the specifications are not identical for all standards, the rated value given for each of them is not necessarily the same.</p>																			
Rated impulse withstand voltage (Vimp)	<p>The peak value of a voltage surge which the device is able to withstand without breaking down.</p>																			
Rated operational power (expressed in kW)	<p>The rated power of the standard motor which can be switched by the contactor, at the stated operational voltage.</p>																			
Rated breaking capacity ▲	<p>This is the current value which the contactor can break in accordance with the breaking conditions specified in the IEC standard.</p>																			
Rated making capacity ▲	<p>This is the current value which the contactor can make in accordance with the making conditions specified in the IEC standard.</p>																			
On-load factor (m)	<p>This is the ratio between the time the current flows (t) and the duration of the cycle (T)</p> $m = \frac{t}{T}$  <p>Cycle duration: duration of current flow + time at zero current</p>																			
Pole impedance	<p>The impedance of one pole is the sum of the impedance of all the circuit components between the input terminal and the output terminal. The impedance comprises a resistive component (R) and an inductive component (X=Lω). The total impedance therefore depends on the frequency and is normally given for 50 Hz. This average value is given for the pole at its rated operational current.</p>																			
Electrical durability	<p>This is the average number of on-load operating cycles which the main pole contacts can perform without maintenance. The electrical durability depends on the utilization category, the rated operational current and the rated operational voltage.</p>																			
Mechanical durability	<p>This is the average number of on-load operating cycles (i.e. with zero current flow through the main poles) which the contactor can perform without mechanical failure</p>																			

♦ Conventional thermal current, in free air, conforming to IEC standards.

▲ For AC applications, the breaking and making capacities are expressed by the rms value of the symmetrical component of the short-circuit current. Taking into account the maximum asymmetry which may exist in the circuit, the contacts therefore have to withstand a peak asymmetrical current which may be twice the rms symmetrical component.

NOTE: These definitions are extracted from standard IEC 60947-1.

TeSys™ K-Line

Mini-Contactors, Overload Relays, and Accessories

Catalog

04

File 8502



CONTENTS

Description	Page
General Information	38
Mini-contactors	
Characteristics	39
Selection	43
K-line Voltage Code Table	52
Auxiliary Contacts and Timers	54
Accessories	56
Dimensions and Mounting	57
Schematics	59
Overload Relays	
Characteristics	61
Selection	63
Dimensions, Mounting, and Schematics	64
Low-consumption Mini-contactors	
Characteristics	65
Selection	68
Auxiliary Contacts, Timers, and Accessories	72
Dimensions and Mounting	73
Schematics	75

TeSys™ K-line Mini-Contactors and Starters

General Information





K-line Mini-contactors, and Overload Relays are ideal for general-duty applications where small size and reliability are key concerns. They feature:

- Three contactor ratings for the USA market:
 - K06 rated for 3 HP motors at 480 Vac or 600 Vac.
 - K09 rated for 5 HP motors at 480 Vac or 600 Vac.
 - K12 rated for 7.5 HP motors at 480 Vac or 10 HP at 600 Vac.
- Space savings — the special magnet and armature structure allow for a DC coil-operated device with the same physical size and panel footprint of the AC coil version.
- IP20-rated touch-safe terminals with both North American and International terminal markings
- Mountable on 35mm DIN rail or panel mount with screws
- Available in 3-pole contactor versions with built-in auxiliary contact for holding circuit or 4-pole contactor versions.
- Easily-installed accessories.
 - 2-pole or 4-pole instantaneous auxiliary contact blocks with screw clamp, slip-on, or spring terminals.
 - Transient voltage surge suppressors.
 - Electronic 1 to 30 second on-delay timers.
- Four wiring methods to reduce installation time:
 - Captive screw terminals for use with either Phillips or slotted head screwdrivers.
 - Slip-on terminals for quick installation of single 1/4" or double 1/8" tabs.
 - Terminal pins for soldering the contactor directly to a printed circuit board.
 - Spring terminals for extreme-vibration applications.
- Control circuit flexibility
All versions of the K-line mini-contactors are available with an AC, DC, or low-consumption DC operating coil. The low-consumption DC coil operating device can be energized by a low level DC signal from a computer or PLC and includes built-in transient suppression and LED "On" indicator.
- Bimetallic overload relays
The K-line Class 10 bimetallic overload relays are ambient-compensated and include single-phase sensitivity for phase unbalance and phase loss protection. Standard features include isolated N.C. trip contact and N.O. alarm contact, manual or automatic reset function, tamper resistant window for full load current settings, and Test trip button. Five pins connect to the contactor load side terminals — three for the power circuit and two for the control circuit — which eliminate customer wiring for the 3-wire control holding circuit.

TeSys™ K-line Mini-Contactors and Starters

Characteristics of Type LC•K and LP•K Contactors

Environment

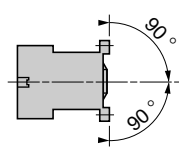
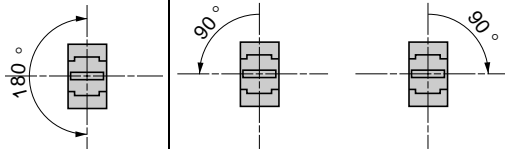
Rated insulation voltage (Vi)	Conforming to IEC 60947	V	690			
	Conforming to VDE 0110 gr C	V	750			
	Conforming to BS 5424, NF C 20-040	V	690			
	Conforming to CSA 22-2 No. 14, UL 508	V	600			
Rated impulse withstand voltage (Vimp)		kV	8			
Conforming to standards	 Meets the essential requirements of the LV & EMC directives	IEC 60947, NF C 63-110, VDE 0660, BS 5424, UL508, CSA 22-2 No. 14				
Approvals	LC•K06, LC•K09, LC•K12 LP•K06, LP•K09, LP•K12	 E164862 NLDX (Screw Clamp)	 E164862 NLDX2 (Slip-on & Solder Pin)	 LR 43364 * 321104		
Protective treatment	Conforming to IEC 60068 (DIN 50016)	"TC" (Fungus-proof, tropicalization protection)				
Degree of protection	Conforming to VDE 0106	Protection against direct finger contact				
Ambient air temperature around the device	Storage	- 50° to + 80°C (-58° to +176°F)				
	Operation	- 25° to + 50°C (-13° to +122°F)				
Maximum operating altitude	Without derating	2000 m (6562 ft.)				
Operating position	Vertical axis	 <p>Without derating</p>				
	Horizontal axis	 <p>Without derating</p> <p>Derate current carrying capability by 15% when not mounted vertically</p>				
Flame resistance	Conforming to UL 94	Self-extinguishing material V1				
	Conforming to NF F 16-101 and 16-102	Conforming to requirement 2				
Shock resistance (1/2 sine wave, 11 ms)	Contact open	10 gn				
	Contact closed	15 gn				
Vibration resistance 5 to 300 Hz	Contact open	2 gn				
	Contact closed	4 gn				
Safe circuit separation	Conforming to VDE 0106 and IEC 60536	SELV ♦, up to 400 V				
Cabling			Min	Max	Max to IEC 60947	
	Screw-clamp terminals	Solid or stranded cable	AWG	1 x 18	2 x 14 or 1 x 12	—
		Solid cable	mm ²	1 x 1.5	2 x 4	1 x 4 + 1 x 2.5
		Stranded cable without cable end	mm ²	1 x 0.75	2 x 4	2 x 2.5
		Stranded cable with cable end	mm ²	1 x 0.34	1 x 1.5 + 1 x 2.5	1 x 1.5 + 1 x 2.5
Slip-on connectors	Clip	2 x 2.8mm or 1 x 6.35mm (2 x 0.110 in. or 1 x 0.250 in.)				
Solder pins for printed circuit board	With locating device between power and control circuits	4 mm x 35 microns				
Tightening torque	Phillips no. 2 or 3/16" slotted head screwdriver	0.8 N•m (7lb.-in.)				
Terminal referencing	Conforming to standards EN 50005 and EN 50012	Up to 5 contacts				

♦ Safety extra low voltage.

TeSys™ K-line Mini-Contactors and Starters

Characteristics of Type LC•K and LP•K Contactors

Pole Characteristics

Conventional thermal current (Ith)	For ambient temperature ≤ 50 °C (122 °F)		20 A						
Rated operational frequency			50/60 Hz						
Frequency limits of the operational current			Up to 400 Hz						
Rated operational voltage (Ve)			690 Vac						
Rated making capacity	I rms conforming to NF C 63-110 and IEC 60947 LC•K06, LP•K06, LC•K09, LP•K09		110 A						
	LC•K12, LP•K12		144 A						
	LC•K16		160 A						
Rated breaking capacity	Conforming to NF C 63-110 and IEC 60947		220/230 V	380/400 V	415 V	440 V	500 V	660/690 V	
	LC•K06, LP•K06, LC•K09, LP•K09 I rms		110 A	110 A	110 A	110 A	80 A	70 A	
	LC•K12, LP•K12		–	–	–	110 A	80 A	70 A	
	LC•K16		–	–	–	110 A	80 A	70 A	
Permissible short-time rating	In free air for a time "t" from cold state (θ ≤ 50 °C [122 °F])		1 s	5 s	10 s	30 s	1 min	3 min	≥ 15 min
	LC•K06, LP•K06, LC•K09, LP•K09		90 A	85 A	80 A	60 A	45 A	40 A	20 A
	LC•K12, LP•K12 LC•K16		115 A	105 A	100 A	75 A	55 A	50 A	25 A
Short-circuit protection	By circuit breaker		Select in accordance with NEC and local codes						
	By fuses		Max 400% of motor FLA						
Average impedance/pole	At Ith and 50 Hz		3 mΩ						
	At Ith and 60 Hz		3.6 mΩ						
Utilization in category AC-1: resistive circuit, heating, lighting (Ve ≤ 440 V)	Maximum rated operational current for a temperature ≤ 50 °C (122 °F)		20 A						
	Maximum rated operational current for a temperature ≤ 70 °C (158 °F)		16 A for Ve only						
	Rated operational current limits in relation to on-load factor and operating frequency		On-load factor		90%	60%	30%		
			300 op. cycles/hour		13 A	15 A	18 A		
			120 op. cycles/hour		15 A	18 A	19 A		
			30 op. cycles/hour		19 A	20 A	20 A		
Increase in operational current by paralleling of poles		Apply the following coefficients to the current values given above. These take into account the often unbalanced current distribution between poles							
		2 poles in parallel: K = 1.60							
		3 poles in parallel: K = 2.25							
		4 poles in parallel: K = 2.80							

Utilization in category AC-3 Squirrel cage motors	Operational power according to the voltage	Voltage 50 or 60 Hz	115 V	220 V	220/240 V	380/415 V	440/480 V	500/600 V	660/690 V
			1-phase		3-phase				
	LC•K06, LP•K06	Motor ratings	0.37 kW	0.75 kW	1.5 kW	2.2 kW	3 kW	3 kW	3 kW
	LC•K09, LP•K09	Motor ratings	0.55 kW	1.1 kW	2.2 kW	4 kW	4 kW	4 kW	4 kW
	LC•K12, LP•K12	Motor ratings	–	–	3 kW	5.5 kW	5.5/4 (480) kW	4 kW	4 kW
	LC•K16	Motor ratings	–	–	4 kW	7.5 kW	5.5/4 (480) kW	4 kW	4 kW
	Maximum operating rate (in operating cycles/hour in relation to percentage of rated power)		Op. cycles/hour		600	900	1200		
		Power		100%	75%	50%			

Utilization in category AC-3 Squirrel cage motors	Operational power according to the voltage	Voltage 50 or 60 Hz	115	220	200/208	220/240	460/480	575/600
			1-phase		3-phase			
	LC•K06, LP•K06	Motor ratings	0.5 HP	1 HP	1.5 HP	1.5 HP	3 HP	3 HP
	LC•K09, LP•K09	Motor ratings	0.5 HP	1.5 HP	2 HP	3 HP	5 HP	5 HP
	LC•K12, LP•K12	Motor ratings	0.5 HP	1.5 HP	3 HP	3 HP	7.5 HP	10 HP
	LC•K16, LP•K16	Not UL Listed or CSA Certified.						

TeSys™ K-line Mini-Contactors and Starters Characteristics of Type LC•K and LP•K Contactors

Control Circuit Characteristics

Type		LC1	LC2	LC7	LC8	LP1	LP2
Rated control circuit voltage (Vc)		12 to 690 Vac ♦		24 to 230 Vac		12 to 250 Vdc ♦	
Control voltage limits (≤ 50 °C [122 °F]) single voltage coil	For operation ▲	0.8 to 1.15 Vc		0.85 to 1.1 Vc		0.8 to 1.15 Vc	
	For drop-out	≥ 0.20 Vc		≥ 0.10 Vc		≥ 0.10 Vc	
Average consumption at 20 °C (68 °F) and at Vc	Inrush	30 VA		3 VA		3 W	
	Sealed	4.5 VA		3 VA		3 W	
Heat dissipation		1.3		3		3	
Operating time at 20 °C (68 °F) and at Vc	Between coil energization and:						
	- opening of the N.C. contacts	5 to 15 ms		25 to 35 ms		25 to 35 ms	
	- closing of the N.O. contacts	10 to 20 ms		30 to 40 ms		30 to 40 ms	
	Between coil de-energization and:						
- opening of the N.O. contacts	10 to 20 ms		30 ms		10 ms		
- closing of the N.C. contacts	15 to 25 ms		40 ms		15 ms		
Maximum immunity to micro-breaks		2 ms		2 ms		2 ms	
Maximum operating rate	In operating cycles per hour	3600		3600		3600	
Mechanical durability at Vc In millions of operating cycles	50/60 Hz coil	10	5	10	5	–	–
	DC coil	–	–	–	–	10	5

♦ For mains supplies with a high level of interference (voltage surge > 800 V), use a suppressor module LA4KE1FC (50 to 129 V) or LAFKE1UG (130 to 250 V); see page 56.

▲ LC1K16: 0.85 to 1.15 Vc.

TeSys™ K-line Mini-Contactors and Starters

Characteristics of Type LC•K and LP•K Contactors

Auxiliary Contact Characteristics and Instantaneous Contact Blocks

Number of contacts	On LC•K or LP•K	1
	On LA1K	2 or 4
Rated operational voltage (Ve)	Up to	690 Vac
Rated insulation voltage (Vi)	Conforming to BS 5424	690 Vac
	Conforming to IEC 60947	690 Vac
	Conforming to VDE 0110 group C	750 Vac
	Conforming to CSA C 22.2 No.14, UL 508	600 Vac
Conventional thermal current (Ith)	For ambient temperature ≤ 50 °C (122 °F)	10 A
Frequency of operational current		Up to 400 Hz
Minimum switching capacity	V min (DIN 19 240)	17 Vac
	I min	5 mA
Short-circuit protection	Conforming to IEC 60947 and VDE 0660, gl fuse	10 A
Rated making capacity	Conforming to IEC 60947	I rms
		110 A
Overload current	Permissible for	1 s
		500 ms
		100 ms
Insulation resistance		> 10 mΩ
Non-overlap distance	Linked contacts conforming to INRS and BIA spec.	0.5 mm

Operational power of contacts conforming to IEC 60947	AC supply, category AC-15						DC supply, category DC-13							
	V	24	48	110/127	220/230	440	600/690	V	24	48	110	220	440	600
1 million operating cycles	VA	48	96	240	440	880	1200	W	120	80	60	52	51	50
2 million operating cycles	VA	17	34	86	158	317	500	W	55	38	30	28	26	25
10 million operating cycles	VA	7	14	36	66	132	200	W	15	11	9	8	7	6
Occasional making capacity	VA	1000	2050	5000	10000	13000	9000	W	720	600	400	300	230	200

Power in broken VA

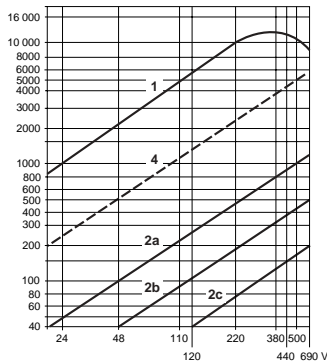

- 1 Breaking limit of contacts valid for maximum of 50 operating cycles at 10 s intervals (breaking current = making current x power factor 0.7).
- 2 Electrical durability of contacts for:
 - 1 million operating cycles (2a)
 - 3 million operating cycles (2b)
 - 10 million operating cycles (2c).
- 3 Breaking limit of contacts valid for maximum of 20 operating cycles at 10 s intervals with current passing for 0.5 s per operating cycle.
- 4 Thermal limit.

Power in broken W

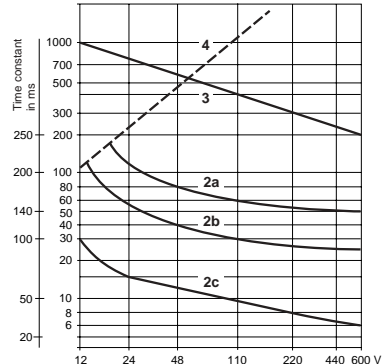

TeSys™ K-line Mini-Contactors and Starters

Selection of Contactors for Motor Control

General-Purpose Contactors for AC Control Circuits

The table below shows general-purpose contactors. The contactors mount on 35 mm DIN rails or with 4 mm (# 6) screws. The wire termination screws are in the open, “ready-to-tighten” position.

For information on add-on auxiliary contact blocks and accessories, see page 54 to 58.

Horsepower Ratings for North American Applications							Kilowatt Ratings for International Applications				Type of Connection	Auxiliary Contacts		Catalog Number ▼ ▲	Weight lb. (kg)
Maximum Horsepower Rating Category AC-3, 50/60 Hz						Max. Inductive Current	Standard power ratings of 3-phase motors, 50/60 Hz in category AC-3			Rated operational current, up to 440 V		N.O.	N.C.		
1-Phase		3-Phase					220 V 230 V	380 V 415 V	440/500 V 660/690 V						
115/ 120 V	230/ 240 V	200/ 208 V	220/ 240 V	460/ 480 V	575/ 600 V	A	kW	kW	kW	A					
0.5	1	1.5	1.5	3	3	6	1.5	2.2	3	6	Screw clamp	1	–	LC1K0610••	0.40 (0.180)
											–	1	LC1K0601••	0.40 (0.180)	
											Slip-on 1 x 0.25 in., or 2 x 0.11 in.	1	–	LC1K06107••	0.40 (0.180)
											–	1	LC1K06017••	0.40 (0.180)	
											Solder pins for printed circuit board	1	–	LC1K06105••	0.46 (0.210)
–	1	LC1K06015••	0.46 (0.210)												
0.5	1.5	2	3	5	5	9	2.2	4	4	9	Spring terminals	1	–	LC1K06103••	0.40 (0.180)
											–	1	LC1K06013••	0.40 (0.180)	
											Screw clamp	1	–	LC1K0910••	0.40 (0.180)
											–	1	LC1K0901••	0.40 (0.180)	
											Slip-on 1 x 0.25 in., or 2 x 0.11 in.	1	–	LC1K09107••	0.40 (0.180)
–	1	LC1K09017••	0.40 (0.180)												
0.5	1.5	3	3	7.5	10	12	3	5.5	4 (> 440) 5.5 (440)	12	Solder pins for printed circuit board	1	–	LC1K09105••	0.46 (0.210)
											–	1	LC1K09015••	0.46 (0.210)	
											Spring terminals	1	–	LC1K09103••	0.40 (0.180)
											–	1	LC1K09013••	0.40 (0.180)	
											Screw clamp	1	–	LC1K1210••	0.40 (0.180)
–	1	LC1K1201••	0.40 (0.180)												
Not for North American applications — not UL Listed or CSA Certified	1.5	3	3	7.5	10	12	3	5.5	4 (> 440) 5.5 (440)	12	Slip-on 1 x 0.25 in., or 2 x 0.11 in.	1	–	LC1K12107••	0.40 (0.180)
											–	1	LC1K12017••	0.40 (0.180)	
											Solder pins for printed circuit board	1	–	LC1K12105••	0.46 (0.210)
											–	1	LC1K12015••	0.46 (0.210)	
											Spring terminals	1	–	LC1K12103••	0.40 (0.180)
–	1	LC1K12013••	0.40 (0.180)												
Not for North American applications — not UL Listed or CSA Certified	1.5	3	3	7.5	10	12	3	5.5	4 (> 440) 5.5 (440)	16	Screw clamp	1	–	LC1K1610••	0.40 (0.180)
											–	1	LC1K1601••	0.40 (0.180)	
											Slip-on 1 x 0.25 in., or 2 x 0.11 in.	1	–	LC1K16107••	0.40 (0.180)
											–	1	LC1K16017••	0.40 (0.180)	
											Solder pins for printed circuit board	1	–	LC1K16105••	0.46 (0.210)
–	1	LC1K16015••	0.46 (0.210)												
Not for North American applications — not UL Listed or CSA Certified	1.5	3	3	7.5	10	12	3	5.5	4 (> 440) 5.5 (440)	16	Spring terminals	1	–	LC1K16103••	0.40 (0.180)
											–	1	LC1K16013••	0.40 (0.180)	

▼ Use voltage codes on page 52 “Voltage Code Table” to complete catalog number.

▲ For mains supplies with a high level of interference (voltage surge > 800 V), use a suppressor module LA4KE1FC (50 to 129 V) or LA4KE1UG (130 to 250 V), see page 56.

LC1K0610••



LC1K06107••



LC1K09103••



TeSys™ K-line Mini-Contactors and Starters

Selection of Contactors for Motor Control



Sensitive-Environment Contactors for AC Control Circuits

The tables below show the kilowatt ratings (for international applications) and horsepower ratings (for North American applications) of contactors for use in sensitive environments. They are recommended for use in areas sensitive to noise, high interference mains supplies, and so forth. The contactors mount on 35 mm DIN rails or with 4 mm (# 6) screws. The wire termination screws are in the open, “ready-to-tighten” position, and include a coil with a built-in rectifier and suppressor.

For information on add-on auxiliary contact blocks and accessories, see page 54 to 58.

LC7K06105••

Horsepower Ratings for North American Applications						Max. Inductive Current	Kilowatt Ratings for International Applications				Type of connection	Auxiliary Contacts		Catalog Number ▼	Weight lb. (kg)	
Maximum Horsepower Rating Category AC-3, 50/60 Hz							Standard power ratings of 3-phase motors, 50/60 Hz in category AC-3					Rated operational current, 440V up to:				
1-Phase		3-Phase					220 V 230 V	380 V 415 V	440/500 V 660/690 V				N.O.			N.C.
115/ 120 V	230/ 240 V	200/ 208 V	220/ 240 V	460/ 480 V	575/ 600 V	A	kW	kW	kW	A						
HP	HP	HP	HP	HP	HP											
0.5	1	1.5	1.5	3	3	6	1.5	2.2	3	6	Screw clamp	1	–	LC7K0610••	0.50 (0.225)	
											–	1	LC7K0601••	0.50 (0.225)		
											Slip-on 1 x 0.25 in., or 2 x 0.11 in.	1	–	LC7K06107••	0.50 (0.225)	
											–	1	LC7K06017••	0.50 (0.225)		
											Solder pins for printed circuit board	1	–	LC7K06105••	0.50 (0.225)	
											–	1	LC7K06015••	0.50 (0.225)		
0.5	1.5	2	3	5	5	9	2.2	4	4	9	Screw clamp	1	–	LC7K0910••	0.50 (0.225)	
											–	1	LC7K0901••	0.50 (0.225)		
											Slip-on 1 x 0.25 in., or 2 x 0.11 in.	1	–	LC7K09107••	0.50 (0.225)	
											–	1	LC7K09017••	0.56 (0.255)		
											Solder pins for printed circuit board	1	–	LC7K09105••	0.56 (0.255)	
											–	1	LC7K09015••	0.50 (0.225)		
0.5	1.5	3	3	7.5	10	12	3	5.5	4 (> 440) 5.5 (440)	12	Screw clamp	1	–	LC7K1210••	0.50 (0.225)	
											–	1	LC7K1201••	0.50 (0.225)		
											Slip-on 1 x 0.25 in., or 2 x 0.11 in.	1	–	LC7K12107••	0.50 (0.225)	
											–	1	LC7K12017••	0.50 (0.225)		
											Solder pins for printed circuit board	1	–	LC7K12105••	0.56 (0.255)	
											–	1	LC7K12015••	0.56 (0.255)		

▼ Use voltage codes on page 52 “Voltage Code Table” to complete catalog number.

TeSys™ K-line Mini-Contactors and Starters

Selection of Contactors for Motor Control

Three-Pole Contactors for DC Control Circuits

The table below shows the kilowatt ratings (for international applications) and horsepower ratings (for North American applications) for three-pole contactors for DC control circuits. The contactors mount on 35 mm DIN rails or with 4 mm (# 6) screws. The wire termination screws are in the open, “ready-to-tighten” position.

For information on add-on auxiliary contact blocks and accessories, see page 54 to 58.

Horsepower Ratings for North American Applications							Kilowatt Ratings for International Applications				Type of Connection	Auxiliary Contacts		Catalog Number	Weight lb. (kg)	
Maximum Horsepower Rating Category AC-3, 50/60 Hz							Max. Inductive Current	Standard power ratings of 3-phase motors, 50/60 Hz in category AC-3				Rated operational current, 440V up to:	N.O.			N.C.
1-Phase		3-Phase			220 V 230 V	380 V 415 V		440/500 V 660/690 V								
115/ 120 V	230/ 240 V	200/ 208 V	220/ 240 V	460/ 480 V	575/ 600 V	A	kW	kW	kW	A						
1.5	2.2	3	6	0.5	1	1.5	1.5	3	3	6	Screw clamp	1	–	LP1K0610••	0.50 (0.225)	
											–	1	LP1K0601••	0.50 (0.225)		
											Slip-on 1 x 0.25 in., or 2 x 0.11 in.	1	–	LP1K06107••	0.50 (0.225)	
											–	1	LP1K06017••	0.50 (0.225)		
2.2	4	4	9	0.5	1.5	2	3	5	5	9	Solder pins for printed circuit board	1	–	LP1K06105••	0.56 (0.255)	
											–	1	LP1K06015••	0.56 (0.255)		
											Spring terminals	1	–	LP1K06103••	0.50 (0.225)	
											–	1	LP1K06013••	0.50 (0.225)		
3	5.5	4 (> 440 V) 5.5 (440 V)	12	0.5	1.5	3	3	7.5	10	12	Screw clamp	1	–	LP1K0910••	0.50 (0.225)	
											–	1	LP1K0901••	0.50 (0.225)		
											Slip-on 1 x 0.25 in., or 2 x 0.11 in.	1	–	LP1K09107••	0.50 (0.225)	
											–	1	LP1K09017••	0.50 (0.225)		
3	5.5	4 (> 440 V) 5.5 (440 V)	12	0.5	1.5	3	3	7.5	10	12	Solder pins for printed circuit board	1	–	LP1K09105••	0.50 (0.225)	
											–	1	LP1K09015••	0.56 (0.255)		
											Spring terminals	1	–	LP1K09103••	0.50 (0.225)	
											–	1	LP1K09013••	0.50 (0.225)		
3	5.5	4 (> 440 V) 5.5 (440 V)	12	0.5	1.5	3	3	7.5	10	12	Screw clamp	1	–	LP1K1210••	0.50 (0.225)	
											–	1	LP1K1201••	0.50 (0.225)		
											Slip-on 1 x 0.25 in., or 2 x 0.11 in.	1	–	LP1K12107••	0.50 (0.225)	
											–	1	LP1K12017••	0.50 (0.225)		
3	5.5	4 (> 440 V) 5.5 (440 V)	12	0.5	1.5	3	3	7.5	10	12	Solder pins for printed circuit board	1	–	LP1K12105••	0.56 (0.255)	
											–	1	LP1K12015••	0.56 (0.255)		
											Spring terminals	1	–	LP1K12103••	0.50 (0.225)	
											–	1	LP1K12013••	0.50 (0.225)		

▼ Use voltage codes on page 52 “Voltage Code Table” to complete catalog number.

LP1K0610••



LP1K06107••



TeSys™ K-line Mini-Contactors and Starters

Selection of Contactors for Resistive Loads

Three- and Four-Pole Contactors for AC Control Circuits

The tables below show general-purpose and sensitive-environment three- and four-pole contactors for AC control circuits. (The sensitive-environment contactors are recommended for use in areas sensitive to noise, high interference mains supplies, and so forth.) The contactors mount on 35 mm DIN rails or with 4 mm (# 6) screws. The wire termination screws are in the open, "ready-to-tighten" position. In addition, the sensitive-environment contactors include a coil with a built-in rectifier and suppressor.

For information on add-on auxiliary contact blocks and accessories, see page 54 to 58.

General-Purpose Contactors ♦



LC1K09004**

Non-inductive loads Category AC-1 Maximum current at ≤ 50 °C (122 °F)	Type of Connection	Power Poles		Auxiliary Contacts		Catalog Number ▼	Weight lb. (kg)
		N.O.	N.C.	N.O.	N.C.		
A	Screw clamp	3	–	1	–	LC1K0910**	0.56 (0.255)
		3	–	–	1	LC1K0901**	0.56 (0.255)
		4	–	–	–	LC1K09004**	0.40 (0.180)
		2	2	–	–	LC1K09008**	0.40 (0.180)
	Slip-on 1 x 0.25 in. or 2 x 0.11 in.	3	–	1	–	LC1K09107**	0.56 (0.255)
		3	–	–	1	LC1K09017**	0.56 (0.255)
		4	–	–	–	LC1K090047**	0.40 (0.180)
		2	2	–	–	LC1K090087**	0.40 (0.180)
	Solder pins for printed circuit board	3	–	1	–	LC1K09105**	0.56 (0.255)
		3	–	–	1	LC1K09015**	0.56 (0.255)
		4	–	–	–	LC1K090045**	0.46 (0.210)
		2	2	–	–	LC1K090085**	0.46 (0.210)
	Spring terminals	3	–	1	–	LC1K09103**	0.56 (0.255)
		3	–	–	1	LC1K09013**	0.56 (0.255)
		4	–	–	–	LC1K090043**	0.46 (0.210)
		2	2	–	–	LC1K090083**	0.46 (0.210)

Sensitive-environment Contactors



LC7K090047**

20	Screw clamp	3	–	1	–	LC7K0910**	0.56 (0.255)
		3	–	–	1	LC7K0901**	0.56 (0.255)
		4	–	–	–	LC7K09004**	0.56 (0.255)
		2	2	–	–	LC7K09008**	0.56 (0.255)
	Slip-on 1 x 0.25 in. or 2 x 0.11 in.	3	–	1	–	LC7K09107**	0.56 (0.255)
		3	–	–	1	LC7K09017**	0.56 (0.255)
		4	–	–	–	LC7K090047**	0.56 (0.255)
		2	2	–	–	LC7K090087**	0.56 (0.255)
	Solder pins for printed circuit board	3	–	1	–	LC7K09105**	0.56 (0.255)
		3	–	–	1	LC7K09015**	0.56 (0.255)
		4	–	–	–	LC7K090045**	0.56 (0.255)
		2	2	–	–	LC7K090085**	0.56 (0.255)

♦ For mains supplies with a high level of interference (voltage surge > 800 V), use a suppressor module LA4KE1FC (50 to 129 V) or LAFKE1UG (130 to 250 V), see page 56.

▼ Use voltage codes on page 52 "Voltage Code Table" to complete catalog number.

TeSys™ K-line Mini-Contactors and Starters

Selection of Contactors for Resistive Loads

Three- and Four-Pole Contactors for DC Control Circuits

The table below shows three- and four-pole contactors for DC control circuits. The contactors mount on 35 mm DIN rails or with 4 mm (# 6) screws. The wire termination screws are in the open, “ready-to-tighten” position.

For information on add-on auxiliary contact blocks and accessories, see page 54 to 58.



LP1K09004••

Non-inductive loads Category AC-1 Maximum current at ≤ 50 °C (122 °F)	Type of Connection	Power Poles		Auxiliary Contacts		Catalog Number ▼	Weight lb. (kg)
		N.O.	N.C.	N.O.	N.C.		
A	Screw clamp	3	–	1	–	LP1K0910••	0.56 (0.225)
		3	–	–	1	LP1K0901••	0.56 (0.225)
		4	–	–	–	LP1K09004••	0.56 (0.225)
		2	2	–	–	LP1K09008••	0.56 (0.225)
		3	–	1	–	LP1K09107••	0.56 (0.225)
		3	–	–	1	LP1K09017••	0.56 (0.225)
	Slip-on 1 x 0.25 in. or 2 x 0.11 in.	4	–	–	–	LP1K090047••	0.56 (0.225)
		2	2	–	–	LP1K090087••	0.56 (0.225)
		3	–	1	–	LP1K09105••	0.56 (0.225)
		3	–	–	1	LP1K09015••	0.56 (0.225)
	Solder pins for printed circuit board	4	–	–	–	LP1K090045••	0.56 (0.225)
		2	2	–	–	LP1K090085••	0.56 (0.225)
		3	–	1	–	LC1K09103••	0.56 (0.225)
	Spring terminals	3	–	–	1	LC1K09013••	0.56 (0.225)
		4	–	–	–	LC1K090043••	0.46 (0.210)
		2	2	–	–	LC1K090083••v	0.46 (0.210)

▼ Use voltage codes on page 52 “Voltage Code Table” to complete catalog number.

TeSys™ K-line Mini-Contactors and Starters

Selection of Reversing Contactors for Motor Control

Three-Pole Reversing Contactors for AC Control Circuits

The table below shows three-pole reversing contactors with integrated mechanical interlock. The contactors mount on 35 mm DIN rails or with 4 mm (# 6) screws. The wire termination screws are in the open, “ready-to-tighten” position. Customer wiring is required to connect coil terminations to electrical interlock; see page 60 (top row, center wiring diagram).

For information on add-on auxiliary contact blocks and accessories, see page 54 to 58.

Horsepower Ratings for North American Applications							Kilowatt Ratings for International Applications				Type of Connection	Auxiliary Contacts		Catalog Number ▼ ■	Weight lb. (kg)
Maximum Horsepower Rating Category AC-3, 50/60 Hz						Max. Inductive Current	Standard power ratings of 3-phase motors, 50/60 Hz in category AC-3			Rated Operational Current, up to 440 V		N.O.	N.C.		
1-Phase		3-Phase					220 V 230 V	380 V 415 V	440/500 V 660/690 V						
115/ 120 V	230/ 240 V	200/ 208 V	220/ 240 V	460/ 480 V	575/ 600 V	A	kW	kW	kW	A					
0.5	1	1.5	1.5	3	3	6	1.5	2.2	3	6	Screw clamp ▲	1	—	LC2K0610●●	0.86 (0.390)
											—	1	LC2K0601●●	0.86 (0.390)	
											Slip-on 1 x 0.25 in., or 2 x 0.11 in.	1	—	LC2K06107●●	0.81 (0.370)
											—	1	LC2K06017●●	0.81 (0.370)	
											Solder pins for printed circuit board	1	—	LC2K06105●●	0.95 (0.430)
—	1	LC2K06015●●	0.95 (0.430)												
Spring terminals	1	—	LC2K06103●●	0.86 (0.390)											
—	1	LC2K06013●●	0.86 (0.390)												
0.5	1.5	2	3	5	5	9	2.2	4	4	9	Screw clamp ▲	1	—	LC2K0910●●	0.86 (0.390)
											—	1	LC2K0901●●	0.86 (0.390)	
											Slip-on 1 x 0.25 in., or 2 x 0.11 in.	1	—	LC2K09107●●	0.86 (0.390)
											—	1	LC2K09017●●	0.86 (0.390)	
											Solder pins for printed circuit board	1	—	LC2K09105●●	0.95 (0.430)
—	1	LC2K09015●●	0.95 (0.430)												
Spring terminals	1	—	LC2K09103●●	0.86 (0.390)											
—	1	LC2K09013●●	0.86 (0.390)												
0.5	1.5	3	3	7.5	10	12	3	5.5	4 (> 440) 5.5 (440)	12	Screw clamp ▲	1	—	LC2K1210●●	0.86 (0.390)
											—	1	LC2K1201●●	0.86 (0.390)	
											Slip-on 1 x 0.25 in., or 2 x 0.11 in.	1	—	LC2K12107●●	0.86 (0.390)
											—	1	LC2K12017●●	0.86 (0.390)	
											Solder pins for printed circuit board	1	—	LC2K12105●●	0.95 (0.430)
—	1	LC2K12015●●	0.95 (0.430)												
Spring terminals	1	—	LC2K12103●●	0.86 (0.390)											
—	1	LC2K12013●●	0.86 (0.390)												
Not for North American applications — not UL Listed or CSA Certified							3	7.5	4 (440) 5.5 (440)	16	Screw clamp ▲	1	—	LC2K1610●●	0.86 (0.390)
											—	1	LC2K1601●●	0.86 (0.390)	
											Slip-on 1 x 0.25 in., or 2 x 0.11 in.	1	—	LC2K16107●●	0.86 (0.390)
											—	1	LC2K16017●●	0.86 (0.390)	
											Solder pins for printed circuit board	1	—	LC2K16105●●	0.95 (0.430)
—	1	LC2K16015●●	0.95 (0.430)												
Spring terminals	1	—	LC2K16103●●	0.86 (0.390)											
—	1	LC2K16013●●	0.86 (0.390)												

- ▼ Use voltage codes on page 52 “Voltage Code Table” to complete catalog number.
- For mains supplies with a high level of interference (voltage surge > 800 V), use a suppressor module **LA4KE1FC** (50 to 129 V) or **LA4KE1UG** (130 to 250 V), see page 56.
- ▲ Pre-wired power circuit connections are standard on screw clamp versions.

LC2K0610●●

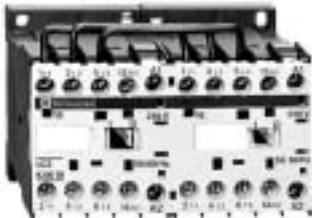

LC2K06107●●

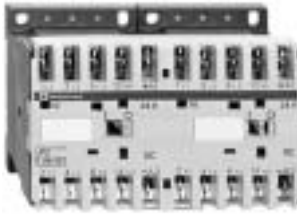

LC2K09103●●



TeSys™ K-line Mini-Contactors and Starters

Selection of Reversing Contactors for Motor Control

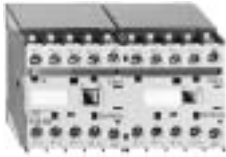

LC8K06105••

Sensitive-Environment Reversing Contactors for AC Control Circuits

The tables below show the kilowatt ratings (for international applications) and horsepower ratings (for North American applications) for reversing contactors with mechanical interlock for use in sensitive environments. They are recommended for use in areas sensitive to noise, high interference mains supplies, and so forth. A coil with incorporated rectifier and suppressor is standard.

The contactors mount on 35 mm DIN rails or with 4 mm (# 6) screws. The wire termination screws are in the open, “ready-to-tighten” position. Customer wiring is required to connect coil terminations to electrical interlock; see page 60 (top row, center wiring diagram).

For information on add-on auxiliary contact blocks and accessories, see page 54 to 58.

Horsepower Ratings for North American Applications						Kilowatt Ratings for International Applications				Type of Connection	Auxiliary Contacts		Catalog Number ▼	Weight lb. (kg)	
Maximum Horsepower Rating Category AC-3, 50/60 Hz						Max. Inductive Current	Standard power ratings of 3-phase motors, 50/60 Hz in category AC-3				Rated Operational Current, up to 440 V				
1-Phase		3-Phase					220 V 230 V	380 V 415 V	440/500 V 660/690 V			N.O.			N.C.
115/ 120 V	230/ 240 V	200/ 208 V	220/ 240 V	460/ 480 V	575/ 600 V	A	kW	kW	kW	A					
0.5	1	1.5	1.5	3	3	6	1.5	2.2	3	6	Screw clamp ▲	1	–	LC8K0610••	1.05 (0.480)
											–	1	LC8K0601••	1.05 (0.480)	
											Slip-on 1 x 0.25 in., or 2 x 0.11 in.	1	–	LC8K06107••	1.00 (0.460)
											–	1	LC8K06017••	1.00 (0.460)	
											Solder pins for printed circuit board	1	–	LC8K06105••	1.14 (0.520)
											–	1	LC8K06015••	1.14 (0.520)	
0.5	1.5	2	3	5	5	9	2.2	4	4	9	Screw clamp ▲	1	–	LC8K0910••	1.05 (0.480)
											–	1	LC8K0901••	1.05 (0.480)	
											Slip-on 1 x 0.25 in., or 2 x 0.11 in.	1	–	LC8K09107••	1.00 (0.460)
											–	1	LC8K09017••	1.00 (0.460)	
											Solder pins for printed circuit board	1	–	LC8K09105••	1.14 (0.520)
											–	1	LC8K09015••	1.14 (0.520)	
0.5	1.5	3	3	7.5	10	12	3	5.5	4 (> 440) 5.5 (440)	12	Screw clamp ▲	1	–	LC8K1210••	1.05 (0.480)
											–	1	LC8K1201••	1.05 (0.480)	
											Slip-on 1 x 0.25 in., or 2 x 0.11 in.	1	–	LC8K12107••	1.00 (0.460)
											–	1	LC8K12017••	1.00 (0.460)	
											Solder pins for printed circuit board	1	–	LC8K12105••	1.14 (0.520)
											–	1	LC8K12015••	1.14 (0.520)	

▼ Use voltage codes on page 52 “Voltage Code Table” to complete catalog number.

▲ Pre-wired power circuit connections are standard on screw clamp versions.

TeSys™ K-line Mini-Contactors and Starters

Selection of Reversing Contactors for Motor Control

Three-Pole Reversing Contactors for DC Control Circuits

The table below show the kilowatt ratings (for international applications) and horsepower ratings (for North American applications) for three-pole reversing contactors with integrated mechanical interlock for DC control circuits. The contactors mount on 35 mm DIN rails or with 4 mm (# 6) screws. The wire termination screws are in the open, "ready-to-tighten" position. Customer wiring is required to connect coil terminations to electrical interlock; see page 60 (top row, center wiring diagram).

For information on add-on auxiliary contact blocks and accessories, see page 54 to 58.

Horsepower Ratings for North American Applications						Kilowatt Ratings for International Applications				Rated Operation al Current in AC-3 up to 400 V	Type of Connection	Auxiliary Contacts		Catalog Number ▼	Weight lb. (kg)
Maximum Horsepower ratings						Maximum Inductive Current in AC-3 Category	Standard power ratings of 3-phase motors 50/ 60 Hz in category AC-3					N.O.	N.C.		
1- phase 50/60 HZ		3- phase 50/60 HZ					A	220 V 230 V	380 V 415 V	440/500 V 660/690 V	A				
115/ 120 V	230/ 240 V	200/ 208 V	220/ 240 V	460/ 480 V	575/ 600 V	kW		kW	kW	A					
HP	HP	HP	HP	HP	HP										
0.5	1	1.5	1.5	3	3	6	1.5	2.2	3	6	Screw clamp ▲	1	–	LP2K0610●●	1.05 (0.480)
											–	1	LP2K0601●●	1.05 (0.480)	
											1	–	LP2K06107●●	1.00 (0.460)	
											–	1	LP2K06017●●	1.00 (0.460)	
											1	–	LP2K06015●●	1.14 (0.520)	
–	1	LP2K06103●●	1.05 (0.480)												
–	–	1	LP2K06013●●	1.05 (0.480)											
0.5	1.5	2	3	5	5	9	2.2	4	4	9	Screw clamp ▲	–	1	LP2K0910●●	1.05 (0.480)
											1	–	LP2K0901●●	1.05 (0.480)	
											–	1	LP2K09107●●	1.00 (0.460)	
											–	1	LP2K09017●●	1.00 (0.460)	
											1	–	LP2K09015●●	1.14 (0.520)	
–	1	LP2K09103●●	1.14 (0.520)												
–	–	1	LP2K09013●●	1.14 (0.520)											
0.5	1.5	3	3	7.5	10	12	3	5.5	4 (> 440) 5.5 (440)	12	Screw clamp ▲	–	1	LP2K1210●●	1.05 (0.480)
											1	–	LP2K1201●●	1.05 (0.480)	
											–	1	LP2K12107●●	1.00 (0.460)	
											1	–	LP2K12017●●	1.00 (0.460)	
											–	1	LP2K12105●●	1.14 (0.520)	
–	1	LP2K12103●●	1.14 (0.520)												
–	–	1	LP2K12013●●	1.14 (0.520)											

▼ Use voltage codes on page 52 "Voltage Code Table" to complete catalog number.

▲ Pre-wired power circuit connections are standard on screw clamp versions.

LP2K0610●●

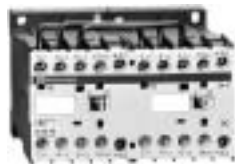

LP2K06107●●

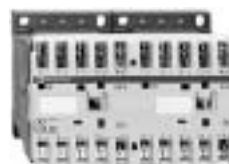

TeSys™ K-line Mini-Contactors and Starters

Selection of Contactors for Resistive Loads

Three- and Four-Pole Contactors for AC Control Circuits

The tables below show general purpose and sensitive-environment three-pole reversing and four-pole change over contactors for AC control circuits. The sensitive-environment contactors are recommended for use in areas sensitive to noise, high interference mains supplies, and so forth. The contactors incorporate an integrated mechanical interlock.

Both types of contactors mount on 35 mm DIN rails or with 4 mm (# 6) screws. The wire termination screws are in the open, "ready-to-tighten" position. In addition, the sensitive-environment contactors include a coil with a built-in rectifier and suppressor. Customer wiring is required to connect coil terminations to the electrical interlock; see page 60 (top row, center wiring diagram).

For information on add-on auxiliary contact blocks and accessories, see page 54 to 58.

General-Purpose Contactors ♦



LC2K09004♦♦

Non-inductive loads Category AC-1 Maximum current at ≤ 50 °C (122 °F)	Type of Connection	Power Poles		Auxiliary Contacts		Catalog Number	Weight lb. (kg)
		N.O.	N.C.	N.O.	N.C.		
A	Screw clamp ▲	3	–	1	–	LC2K0910♦♦	0.86 (0.390)
		3	–	–	1	LC2K0901♦♦	0.86 (0.390)
		4	–	–	–	LC2K09004♦♦	0.84 (0.380)
	Slip-on 1 x 0.25 in. or 2 x 0.11 in.	3	–	–	1	LC2K09107♦♦	0.81 (0.370)
		3	–	1	–	LC2K09017♦♦	0.81 (0.370)
		4	–	–	–	LC2K090047♦♦	0.81 (0.370)
	Solder pins for circuit board	3	–	1	1	LC2K09105♦♦	0.95 (0.430)
		3	–	–	–	LC2K09015♦♦	0.95 (0.430)
		4	–	–	–	LC2K090045♦♦	0.95 (0.430)
	Spring terminals	3	–	1	1	LC2K09103♦♦	0.86 (0.390)
		3	–	–	–	LC2K09013♦♦	0.86 (0.390)
		4	–	–	–	LC2K090043♦♦	0.86 (0.390)

Sensitive-Environment Contactors



LC8K09105♦♦

20	Screw clamp ▲	3	–	1	–	LC8K0910♦♦ ♦	1.05 (0.480)
		3	–	–	1	LC8K0901♦♦ ♦	1.05 (0.480)
		4	–	–	–	LC8K09004♦♦	1.03 (0.470)
	Slip-on 1 x 0.25 in. or 2 x 0.11 in.	3	–	–	1	LC8K09107♦♦	1.01 (0.460)
		3	–	1	–	LC8K09017♦♦	1.01 (0.460)
		4	–	–	–	LC8K090047♦♦	1.01 (0.460)
	Solder pins for circuit board	3	–	1	1	LC8K09105♦♦	1.14 (0.520)
		3	–	–	–	LC8K09015♦♦	1.14 (0.520)
		4	–	–	–	LC8K090045♦♦	1.14 (0.520)

♦ For mains supplies with a high level of interference (voltage surge > 800 V), use a suppressor module LA4KE1FC (50 to 129 V) or LAFKE1UG (130 to 250 V), see page 56.

▼ Use voltage codes on page 52 "Voltage Code Table" to complete catalog number.

▲ Pre-wired power circuit connections are standard on screw clamp versions.

TeSys™ K-line Mini-Contactors and Starters

Voltage Code Table

Three- and Four-Pole Contactors for DC Control Circuits

The table below shows general-purpose three-pole reversing and four-pole change over contactors for DC control circuits. The contactors incorporate an integrated mechanical interlock.

The contactors mount on 35 mm DIN rails or with 4 mm (# 6) screws. The wire termination screws are in the open, "ready-to-tighten" position. Customer wiring is required to connect coil terminations to the electrical interlock; see page 60 (top row, center wiring diagram).

For information on add-on auxiliary contact blocks and accessories, see page 54 to 58.



LC2K09004**

Non-inductive loads Category AC-1 Maximum current at ≤ 50 °C (122 °F)	Type of Connection	Power Poles		Auxiliary Contacts		Catalog Number ▼	Weight lb. (kg)
		N.O.	N.C.	N.O.	N.C.		
A	Screw clamp ▲	3	-	1	-	LP2K0910**	1.05 (0.480)
		3	-	-	1	LP2K0901**	1.05 (0.480)
		4	-	-	-	LP2K09004**	1.05 (0.480)
		3	-	-	1	LP2K09107**	1.01 (0.460)
		3	-	1	-	LP2K09017**	1.01 (0.460)
		4	-	-	-	LP2K090047**	1.01 (0.460)
	Slip-on 1 x 0.25 in. or 2 x 0.11 in.	3	-	1	1	LP2K09105**	1.14 (0.520)
		3	-	-	-	LP2K09015**	1.14 (0.520)
		4	-	-	-	LP2K090045**	1.14 (0.520)
		3	-	-	-	LP2K09015**	1.14 (0.520)
		3	-	-	-	LP2K09015**	1.14 (0.520)
		4	-	-	-	LP2K090045**	1.14 (0.520)

- ▼ Use voltage codes below to complete the catalog number.
- ▲ Pre-wired power circuit connections are standard on screw clamp versions.

K-line Voltage Code

Voltage	Frequency	K-line (see notes at end of table)			
		LC1K LC2K Notes K1, K2	LC7K LC8K Note K4	LP1K LP2K Notes K2, K3	LP4K LP5K
5	Low Consump DC	-	-	-	-
	50/60	J7	-	-	-
12	50	-	-	-	-
	DC	-	-	JD	-
	Low Consump DC	-	-	-	JW3
	Wide Range DC	-	-	-	-
20	50/60	Z7	-	-	-
	50	-	-	-	-
	60	-	-	-	-
	DC	-	-	ZD	-
	Low Consump DC	-	-	-	ZW3
24	50/60	B7 Note K2	B7	-	-
	50	-	-	-	-
	60	-	-	-	-
	40-400	-	-	-	-
	DC	-	-	BD Note K2	-
	Low Consump DC	-	-	-	BW3
	Wide Range DC	-	-	-	-
36	50/60	C7	-	-	-
	DC	-	-	CD	-
	Wide Range DC	-	-	-	-

K-line Voltage Code (Continued)

Voltage	Frequency	K-line (see notes at end of table)			
		LC1K LC2K Notes K1, K2	LC7K LC8K Note K4	LP1K LP2K Notes K2, K3	LP4K LP5K
42	50/60	D7	D7	-	-
	50	-	-	-	-
	60	-	-	-	-
48	50/60	E7	E7	-	-
	50	-	-	-	-
	60	-	-	-	-
	40-400	-	-	-	-
	DC	-	-	ED	-
	Low Consump DC	-	-	-	EW3
60	50/60	-	-	-	-
	DC	-	-	ND	-
	DC	-	-	SD	-
72	Low Consump DC	-	-	-	SW3
	Wide Range DC	-	-	-	-
96	Low Consump DC	-	-	-	-
100	50/60	-	-	-	-
	DC	-	-	KD	-
110	50/60	F7	F7	-	-
	50	-	-	-	-
	60	-	-	-	-
	40-400	-	-	-	-
	DC	-	-	FD	-
	Low Consump DC	-	-	-	FW3
Wide Range DC	-	-	-	-	

TeSys™ K-line Mini-Contactors and Starters Voltage Code Table

K-line Voltage Code (Continued)

Voltage	Frequency	K-line (see notes at end of table)			
		LC1K LC2K Notes K1, K2	LC7K LC8K Note K4	LP1K LP2K Notes K2, K3	LP4K LP5K
110/127	40-400	-	-	-	-
	50/60	FE7	FE7	-	-
115	50	-	-	-	-
	40-400	-	-	-	-
120	50/60	G7	G7	-	-
	50	-	-	-	-
	60	-	-	-	-
	40-400	-	-	-	-
	DC	-	-	-	-
	Low Consump DC	-	-	-	GW3
125	DC	-	-	GD	-
	50/60	FC7	-	-	-
127	60	-	-	-	-
	40-400	-	-	-	-
155	DC	-	-	PD	-
174	DC	-	-	QD	-
200	50/60	-	-	-	-
	DC	-	-	LD	-
200/208	50/60	L7	-	-	-
	60	-	-	-	-
	40-400	-	-	-	-
208	50/60	-	-	-	-
	60	-	-	-	-
	40-400	-	-	-	-
220	50/60	-	M7	-	-
	50	-	-	-	-
	60	-	-	-	-
	40-400	-	-	-	-
	DC	-	-	MD	-
	Low Consump DC	-	-	-	-
	Wide Range DC	-	-	-	-
220/230	50/60	M7	-	-	-
	50	-	-	-	-
	60	-	-	-	-
	40-400	-	-	-	-
	DC	-	-	-	-
220/240	40-400	-	-	-	-
	DC	-	-	-	-
230	50/60	P7	-	-	-
	50	-	-	-	-
	60	-	-	-	-
	40-400	-	-	-	-
	DC	-	-	MPD	-
230/240	50/60	U7 Note K4	U7	-	-
	50/60	-	-	-	-
240	50	-	-	-	-
	60	-	-	-	-
	40-400	-	-	-	-
	DC	-	-	MUD	-
	DC	-	-	UD	-
250	Low Consump DC	-	-	-	-
256	50/60	W7	-	-	-
	50	-	-	-	-
277	50/60	UE7	-	-	-
	50	-	-	-	-
	40-400	-	-	-	-
380	50/60	-	-	-	-
	50	-	-	-	-
	60	-	-	-	-
	40-400	-	-	-	-

K-line Voltage Code (Continued)

Voltage	Frequency	K-line (see notes at end of table)			
		LC1K LC2K Notes K1, K2	LC7K LC8K Note K4	LP1K LP2K Notes K2, K3	LP4K LP5K
380/400	50/60	Q7 Note K4	-	-	-
	50	-	-	-	-
	60	-	-	-	-
	40-400	-	-	-	-
	DC	-	-	-	-
380/440	40-400	-	-	-	-
400	50/60	V7	-	-	-
	50	-	-	-	-
	40-400	-	-	-	-
400/415	50/60	N7	-	-	-
	50/60	-	-	-	-
415	50	-	-	-	-
	40-400	-	-	-	-
415-440	50	-	-	-	-
	40-400	-	-	-	-
440	50/60	R7	-	-	-
	50	-	-	-	-
	60	-	-	-	-
	40-400	-	-	-	-
	DC	-	-	-	-
440/460	DC	-	-	-	-
460/480	60	-	-	-	-
480	50/60	T7	-	-	-
	50	-	-	-	-
	60	-	-	-	-
	40-400	-	-	-	-
500	50/60	S7	-	-	-
	50	-	-	-	-
	40-400	-	-	-	-
575	50/60	SC7	-	-	-
	60	-	-	-	-
600	50/60	X7	-	-	-
	60	-	-	-	-
	40-400	-	-	-	-
660	50	-	-	-	-
	60	-	-	-	-
660/690	50/60	Y7	-	-	-

Notes:

- K1 Up to and including 240 V, coil with integral suppression device (bi-directional diode): add 2 to the requested voltage code. Ex. J72
- K2 For voltage codes B7 or BD, when connecting an electronic sensor or timer in series with the coil of the control relay, select a 20 V coil (Voltage code Z7 for AC or ZD for DC). This coil compensates for incurred voltage drop.
- K3 Coil with integral suppression device available (bidirectional diode): add 3 to the requested voltage code. Ex JD3.
- K4 For voltage codes M7, U7, Q7, N7, Y7 and all LC7K and LC8K devices, operating range is 0.85 - 1.10 of nominal. For all other LC1K and LC2K the operating range is 0.80 - 1.15 of nominal.

TeSys™ K-line Mini-Contactors and Starters

Selection of Auxiliary Contacts and Timers

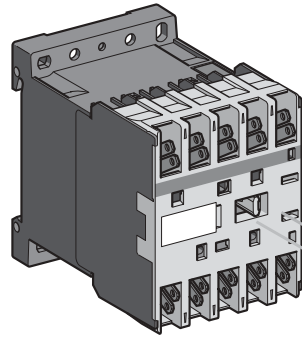

LC1/LC7/LP1K

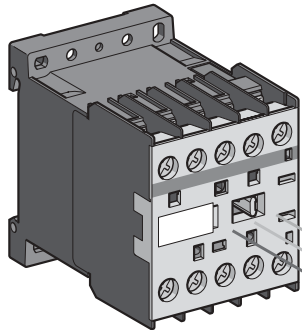

LC1/LC7/LP1K

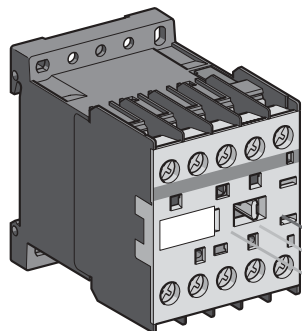

LC1/LC7/LP1K

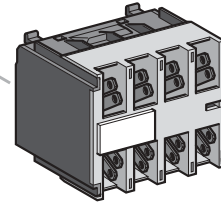

LA1KN●●●

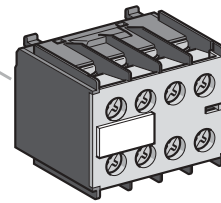

LA1KN●●M

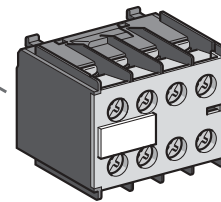

LA1KN●●

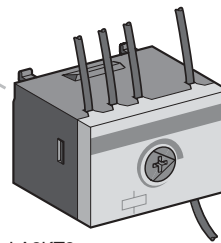

LA2KT2●

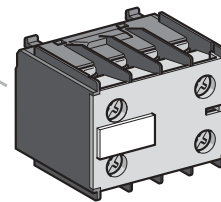

LA1 KN●●P

TeSys™ K-line Mini-Contactors and Starters

Selection of Auxiliary Contacts and Timers

Instantaneous Auxiliary Contact Blocks for Type LC•K and LP•K Contactors

Recommended for standard applications. Clip-on front mounting, 1 block per contactor

Type of Connection	Type of Contactor	Auxiliary Contacts		Catalog Number	Weight lb. (kg)
		N.O.	N.C.		
Screw Clamp	LC1, LC2 LC7, LC8 LP1, LP2 3- or 4-pole	2	–	LA1KN20	0.10 (0.045)
		–	2	LA1KN02	0.10 (0.045)
		1	1	LA1KN11	0.10 (0.045)
		4	–	LA1KN40	0.10 (0.045)
		3	1	LA1KN31	0.10 (0.045)
		2	2	LA1KN22	0.10 (0.045)
		1	3	LA1KN13	0.10 (0.045)
		–	4	LA1KN04	0.10 (0.045)
Slip-on 1 x 0.25 in. or 2 x 0.11 in.	LC1, LC2 LC7, LC8 LP1, LP2 3- or 4-pole	2	–	LA1KN207	0.10 (0.045)
		–	2	LA1KN027	0.10 (0.045)
		1	1	LA1KN117	0.10 (0.045)
		4	–	LA1KN407	0.10 (0.045)
		3	1	LA1KN317	0.10 (0.045)
		2	2	LA1KN227	0.10 (0.045)
		1	3	LA1KN137	0.10 (0.045)
		–	4	LA1KN047	0.10 (0.045)
Spring Terminals	LC1, LC2 LP1, LP2 3- or 4-pole	2	–	LA1KN203	0.10 (0.045)
		–	2	LA1KN023	0.10 (0.045)
		1	1	LA1KN113	0.10 (0.045)
		4	–	LA1KN403	0.10 (0.045)
		3	1	LA1KN313	0.10 (0.045)
		2	2	LA1KN223	0.10 (0.045)
		1	3	LA1KN133	0.10 (0.045)
		–	4	LA1KN043	0.10 (0.045)

With terminal referencing conforming to standard EN 50012. Clip-on front mounting, 1 block per contactor

Screw clamp with terminal referencing conforming to standard EN 50012 ▲	LC1, LC2 LC7, LC8 LP1, LP2 3-pole + N.O.	–	2	LA1KN02M	0.10 (0.045)
		1	1	LA1KN11M	0.10 (0.045)
		3	1	LA1KN31M	0.10 (0.045)
		2	2	LA1KN22M	0.10 (0.045)
	1	3	LA1KN13M	0.10 (0.045)	
	LC1, LC2 LC7, LC8 LP1, LP2 4-pole	1	1	LA1KN11P	0.10 (0.045)
		2	2	LA1KN22P	0.10 (0.045)

▲ See pages 59 and 60 for actual terminal markings.

Electronic Time-Delay Auxiliary Contact Blocks for Type LC•K and LP•K Contactors

- Relay output, with common point changeover contact, AC or DC 240 Vac, 2 A maximum.
- Control voltage: 0.85 to 1.1 Vc.
- Maximum switching capacity: 250 VA or 150 W.
- Operating temperature: -10 to + 60 °C (14 to 140 °F).
- Reset time: 1.5 s during the time delay period, 0.5 s after the time delay period.

Clip-on front mounting, 1 block per contactor

Voltage	Type	Timing Range s	Auxiliary Contacts	Catalog Number	Weight lb. (kg)
			SPDT		
V					
AC or DC 24 to 48	On-delay	1 to 30	1	LA2KT2E	0.09 (0.040)
AC 110 to 240	On-delay	1 to 30	1	LA2KT2U	0.09 (0.040)

TeSys™ K-line Mini-Contactors and Starters

Selection of Accessories

Coil Suppressor Modules With an LED Indicator for Type LC•K and LP•K Contactors

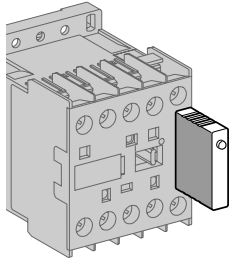

LA4K••

Mounting and connection	Type	For voltages:	Sold in lots of	Catalog Number	Weight lb. (kg)
Clip-on mounting on the front of LC1 and LP1 contactors. No tools required.	Varistor ■	AC and DC 12 to 24 V	5	LA4KE1B	0.02 (0.010)
		AC and DC 32 to 48 V	5	LA4KE1E	0.02 (0.010)
		AC and DC 50 to 129 V	5	LA4KE1FC	0.02 (0.010)
		AC and DC 201 to 250 V	5	LA4KE1UG	0.02 (0.010)
	Diode + Zener diode ◆	DC 12 to 24 V	5	LA4KC1B	0.02 (0.010)
		DC 32 to 48 V	5	LA4KC1E	0.02 (0.010)
	RC ▲	AC 220 to 250 V	5	LA4KA1U	0.02 (0.010)

- Protection by limitation of the transient voltage up to 2 Vc maximum. Maximum reduction of transient voltage peaks. Slight time delay on drop-out (1.1 to 1.5 times the normal time).
- ◆ No overvoltage or oscillation frequency. Polarized component. Slight time delay on drop-out (1.1 to 1.5 times the normal time).
- ▲ Protection by limitation of the transient voltage up to 3 Vc maximum and limitation of the oscillation frequency. Slight time delay on drop-out (1.2 to 2 times the normal time).

Mounting and Marking Accessories

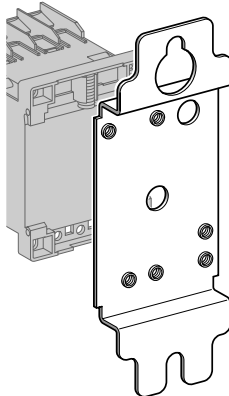

DX1AP25

Description	Application		Sold in lots of	Unit Catalog Number	Weight lb. (kg)
Mounting plates ■	For mounting on 1 ' rail	Clip-on	1	LA9D973	0.05 (0.025)
	For mounting on 2 ' rails	110/120 mm mounting centers	10	DX1AP25	0.14 (0.065)
Marker holder	Clip-on	Onto front of contactor	100	LA9D90	0.002 (0.001)
Clip-in markers	4 maximum per contactor	Strips of 10 identical numbers 0 to 9	25	AB1R• ▲	0.004 (0.002)
		Strips of 10 identical capital letters A to Z	25	AB1G• ▲	0.004 (0.002)
35mm " DIN rail (7.5mm deep x 2m long)			10	AM1DP200	2.88 (1.310)
35mm " DIN rail (15mm deep x 2m long)			10	AM1ED200	1.44 (0.650)

- Order 1 mounting plate for a contactor and 2 mounting plates for a reversing contactor.
- ▲ Complete the catalog number by replacing the • with the required number or character.

Cabling Accessories

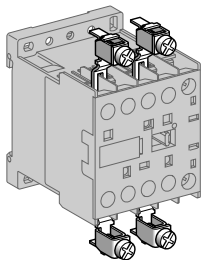

LA9E01

Description	Application		Sold in lots of	Unit Catalog Number	Weight kg (lb.)
Paralleling links	For 2-poles	With screw clamp terminals	4	LA9E01	0.02 (0.010)
	For 4-poles	With screw clamp terminals	2	LA9E02	0.03 (0.015)
Power connections: 6 required per contactor	For 3-pole reversing contactors for motor control	For contactors with screw clamp terminals	100	LA9K0969	0.02 (0.010)
Power connections: 4 required per contactor	For 4-pole changeover contactor pairs	For contactors with screw clamp terminals	100	LA9K0970	0.02 (0.010)

TeSys™ K-line Mini-Contactors and Starters

Dimensions and Mounting of Type LC•K and LP•K Contactors

Contactors LC1K, LC7K, LP1K On panel

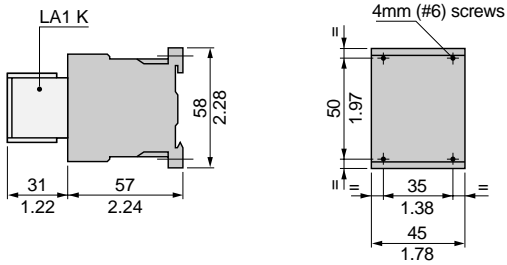

On mounting rail **AM1DP200** or **AM1DE200** 1.4 in. (35 mm) DIN rail

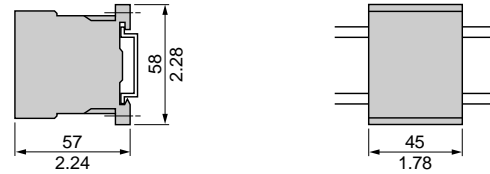

On one asymmetrical rail **DZ5MB** with clip-on mounting plate **LA9D973**

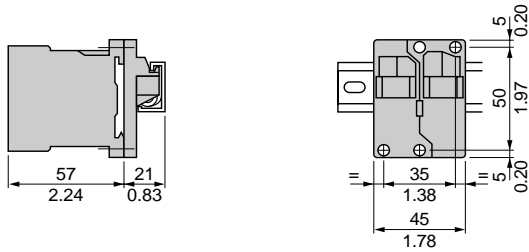

DX1AP25

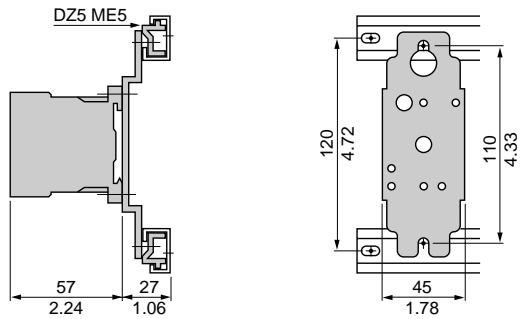

On printed circuit board

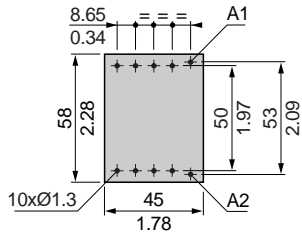

Electronic time-delay auxiliary contact blocks

LA2KT

On contactor

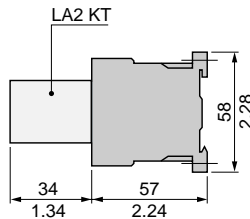
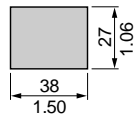
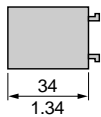

Suppressor modules

LA4K•

On contactor

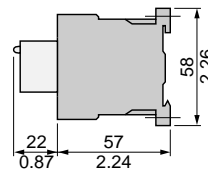
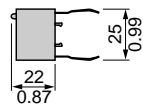

Dimensions Inches
mm

TeSys™ K-line Mini-Contactors and Starters

Dimensions and Mounting of Type LC•K and LP•K Reversing Contactors

Reversing contactors LC2K, LC8K, LP2K
On panel

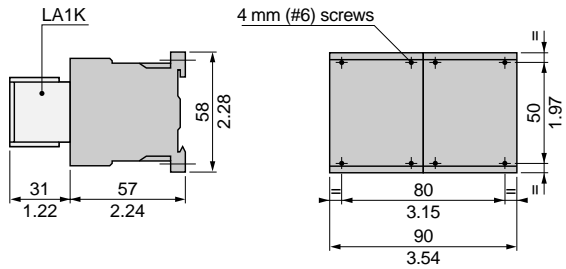

On mounting rail **AM1DP200** or **AM1DE200** 1.4 (35 mm) DIN rail

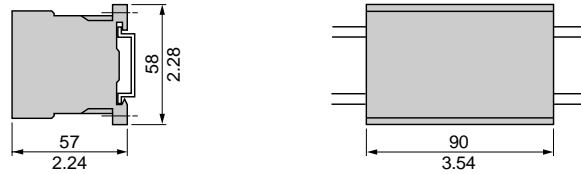

On one asymmetrical rail **DZ5MB** with 2 clip-on mounting plates **LA9D973** or on 2 mounting plates **DX1AP25**.

2 x **LA9D973**

2 x **DX1AP25**

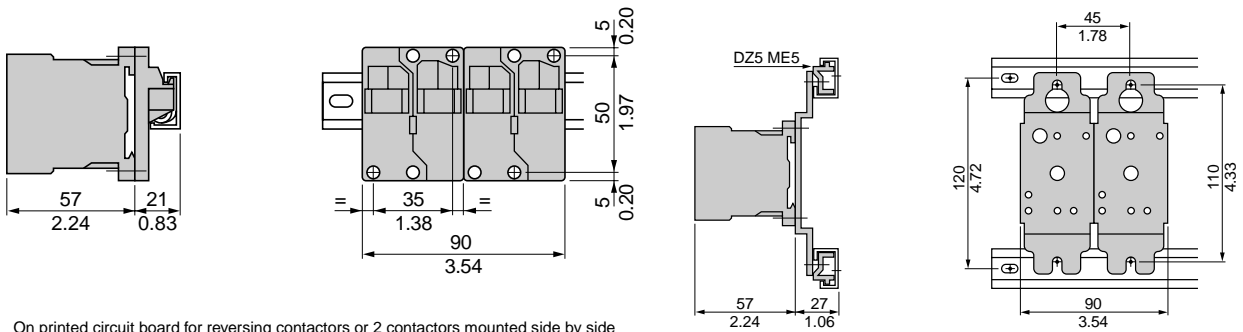

On printed circuit board for reversing contactors or 2 contactors mounted side by side

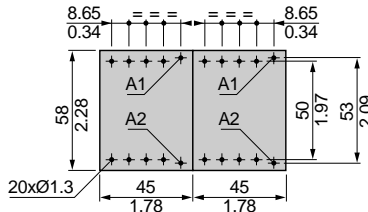

Electronic time delay auxiliary contact blocks

LA2KT

On reversing contactors

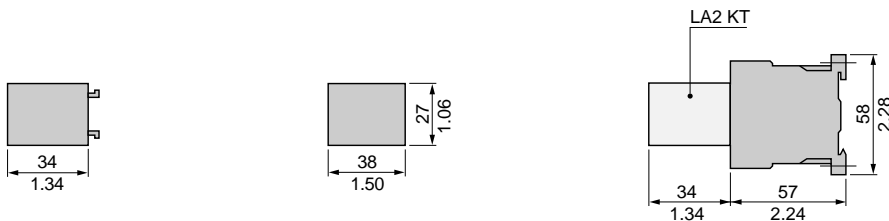

Suppressor modules

LA4K•

On reversing contactors

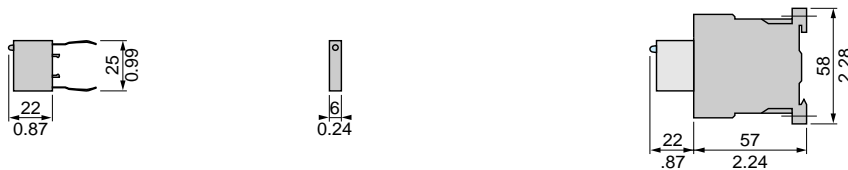

Dimensions $\frac{\text{inches}}{\text{mm}}$

Type LC•K and LP•K Contactors and Accessories

3-pole contactors LC1K, LC7K, LP1K

3-pole + N.O.

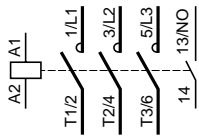

3-pole + N.C.

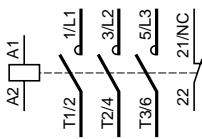

Integrated-coil suppression device LC7K

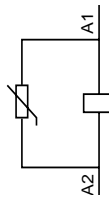

4-pole contactors LC1K, LC7K, LP1K

4-pole

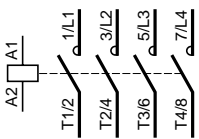

2-pole N.O. + 2-pole N.C.

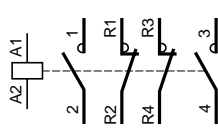

Integrated-coil suppression device LC7K

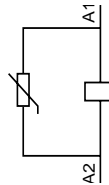

Instantaneous auxiliary contacts LA1K For contactors LC•K and LP•K

2 N.O.

LA1KN20
LA1KN207

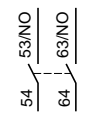

2 N.C.

LA1KN02
LA1KN027

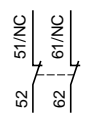

1 N.O. + 1 N.C.

LA1KN11
LA1KN117

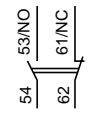

4 N.O.

LA1KN40
LA1KN407

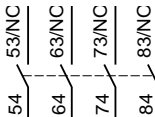

3 N.O. + 1 N.C.

LA1KN31
LA1KN317

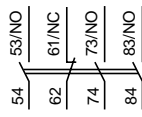

2 N.O. + 2 N.C.

LA1KN22
LA1KN227

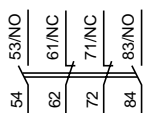

1 N.O. + 3 N.C.

LA1KN13
LA1KN137

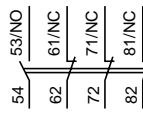

4 N.C.

LA1KN04
LA1KN047

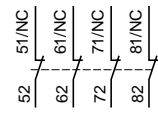

Terminal referencing conforming to standard EN 50012 For 3-pole contactors

2 N.C.

LA1KN02M

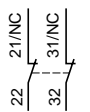

1 N.O. + 1 N.C.

LA1KN11M

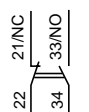

3 N.O. + 1 N.C.

LA1KN31M

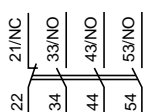

2 N.O. + 2 N.C.

LA1KN22M

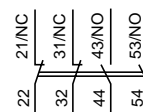

1 N.O. + 3 N.C.

LA1KN13M

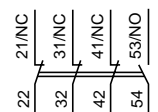

For 4-pole contactors

1 N.O. + 1 N.C.

LA1KN11P

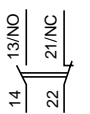

2 N.O. + 2 N.C.

LA1KN22P

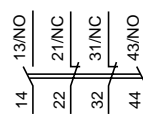

Electronic time delay auxiliary contact blocks

LA2KT

For contactors LC•K and LP•K

1 C/O

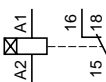

Suppressor modules LA4KC

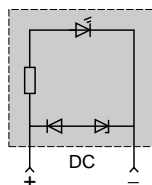

LA4KE

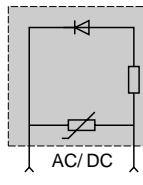

TeSys™ K-line Mini-Contactors and Starters Schematics

Type LC•K and LP•K Reversing Contactors and Accessories

3-pole reversing contactors LC2K, LC8K, LP2K

With screw clamp terminals

3 P + N.O.

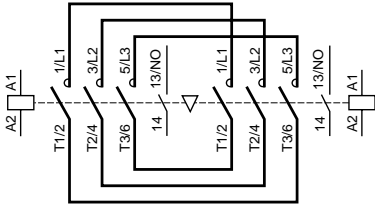

With Slip-on connectors or solder pins (printed circuit board)

3 P + N.O.

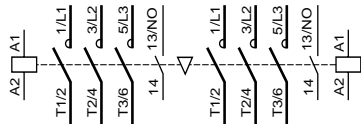

Dashed lines indicate suggested customer wiring to electrically interlock coils

3 P + N.C.

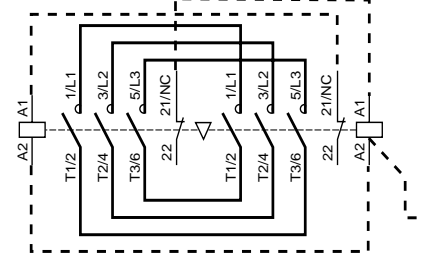

With Slip-on connectors or solder pins (printed circuit board)

3 P + N.C.

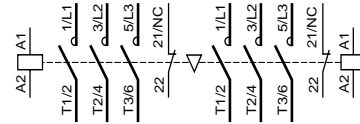

Integrated-coil suppression device
LC8K

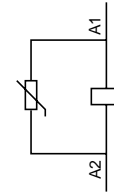

4-pole reversing contactors LC2K, LC8K, LP2K

With screw clamp terminals

4 P

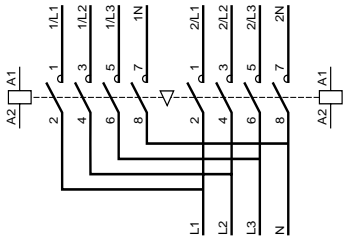

With Slip-on connectors or solder pins (printed circuit board)

4 P

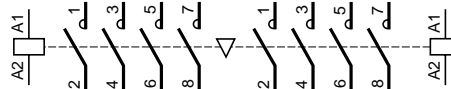

Integrated-coil suppression device
LC8K

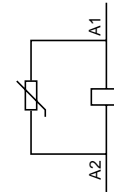

Instantaneous auxiliary contact blocks LA1K

For contactors LC•K and LP2K

2 N.O.

LA1KN20
LA1KN207



2 N.C.

LA1KN02
LA1KN027

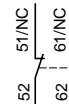

1 N.O. + 1 N.C.

LA1KN11
LA1KN117



Terminal referencing conforming to standard EN 50012

1 N.O. + 1 N.C.
LA1KN11P

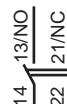

For contactors LC•K, LP2K

4 N.O.

LA1KN40
LA1KN407



3 N.O. + 1 N.C.

LA1KN31
LA1KN317

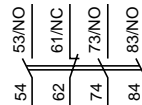

2 N.O. + 2 N.C.

LA1KN22
LA1KN227

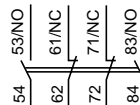

1 N.O. + 3 N.C.

LA1KN13
LA1KN137

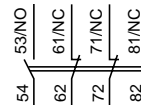

4 N.C.

LA1KN04
LA1KN047

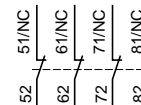

For auxiliary contacts with terminal referencing conforming to standard EN 50012 see page 55.

Electronic time delay contact blocks LA2KT

For contactors LC•K and LP•K

1 C/O

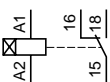

Suppressor modules LA4KC

LA4KC

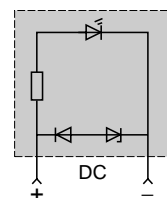

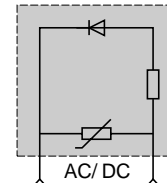

LA4KE



TeSys™ K-line Mini-Contactors and Starters

Characteristics of Type LR•K Overload Relays

Environment

Conforming to standards	 Meets the essential requirements of the LV & EMC directives	IEC 60947, NF C 63-650, VDE 0660, BS 4941, UL 508, CSA 22.2 No. 14				
Product certifications		 E164353 NKCR	 LR43364 3211 03			
Protective treatment	Conforming to IEC 60068 (DIN 50016)	"TC" (Fungus-proof, tropicalization protection)				
Degree of protection	Conforming to VDE 0106	Protection against direct finger contact				
Ambient air temperature around the device	Storage	-40° to +70° C (-40 to +158° F)				
	For normal operation (IEC 60947)	-20 to +55° C (-4 to +131° F) without derating				
	Operating limit	-30 to +60° C (-22 to +140° F) with derating ■				
Maximum operating altitude	Without derating	2000 m (6562 ft.)				
Operating positions	Vertical axis	Horizontal axis				
	 Without derating	 With derating ■				
Flame resistance	Conforming to UL 94	Self-extinguishing material V1				
	Conforming to NF F 16-101 and 16-102	Conforming to requirement 2				
Shock resistance, hot state (1/2 sine wave, 11 ms)	Conforming to IEC 60068, N.C. contact	10 gn				
	Conforming to IEC 60068, N.O. contact	10 gn				
Vibration resistance, hot state 5 to 300 Hz	Conforming to IEC 60068, N.C. contact	2 gn				
	Conforming to IEC 60068, N.O. contact	2 gn				
Safe separation of circuits	Conforming to VDE 0106 and IEC 60536	SELV, up to 400 V ▲				
Cabling		Minimum	Maximum	Maximum to IEC 60947		
Screw clamp terminals	Solid or stranded cable	AWG	1 x 18	2 x 14 or 1 x 12	-	
	Solid cable	mm ²	1 x 1.5	2 x 4	1 x 4 + 1 x 2.5	
	Stranded cable without cable end	mm ²	1 x 0.75	2 x 4	2 x 2.5	
	Stranded cable with cable end	mm ²	1 x 0.34	1 x 1.5 + 1 x 2.5	1 x 1.5 + 1 x 2.5	
Tightening torque	Phillips no. 2 or 3/16" slotted head	0.8 N•m (7 lb.-in.)				
Mounting	Directly under the contactor or reversing contactor					
Connections	Made automatically when mounted under the contactor, as follows: - contactor terminal A2 connected to overload relay terminal 96 on all products, - contactor terminal 14 connected to overload relay terminal 95 on products with 3 P + N.O. When using 3 P + N.C., or 4 P contactors, or the N.O. auxiliary contact marked 13-14, at a voltage other than the coil voltage, break off the link marked 14. (See page 64 for additional information.)					

■ Please consult your Local Field Sales Office.

▲ Safe extra low voltage.

Auxiliary Contact Characteristics

Number of contacts	1 N.C. + 1 N.O.								
Conventional thermal current	A	6							
Short-circuit protection ●	Conforming to IEC 60947, VDE 0660. gf fuse or supplementary protector GB2CB●●	A	6 max.						
Maximum power of the controlled contactor coils (sealed) (Occasional operating cycles of contact 95-96)	AC	V	24	48	110	220/230	400	415/440	600/690
		VA	100	200	400	600	600	600	600
	DC	V	24	48	110	220	250	-	-
		W	100	100	50	45	35	-	-
Maximum operational voltage	AC, category AC-15	V	690						
	DC, category DC-13	V	250						

● Select short circuit protection to meet the National Electrical Code or other local codes and standards.

TeSys™ K-line Mini-Contactors and Starters

Characteristics of Type LR•K Overload Relays

Electrical Characteristics of the Power Circuit

Rated operational voltage (Ve)	Up to	V	690
	Conforming to BS 4941	V	690
Rated insulation voltage (Vi)	Conforming to IEC 60947	V	690
	Conforming to VDE 0110 group C	V	750
	Conforming to UL 508, CSA 22.2 No. 14	V	600
Rated impulse withstand voltage (Vimp)		kV	6
Frequency limits of the operational current		Hz	Up to 400
Power dissipated per pole		W	2
Short-circuit protection and coordination	By circuit breaker		Select in accordance with NEC and local codes
	By fuses		Maximum 400% of motor FLA

Operating Characteristics

Sensitivity to phase failure	Conforming to IEC 60947	Yes
Reset	Manual or automatic	Selected by means of a lockable and sealable switch on the front of the relay
Signalling	On front of relay	Trip indicator
Reset-Stop function		Pressing the Reset-Stop button: – Actuates the N.C. contact – Has no effect on the N.O. contact
Test function	By pushbutton	Pressing the Test button enables: – Checking of the control circuit wiring – Simulation of overload tripping (actuation of both N.C. and N.O. contacts, and of the trip indicator)

Tripping curves

Average operating time related to multiples of the current setting Class 10 A

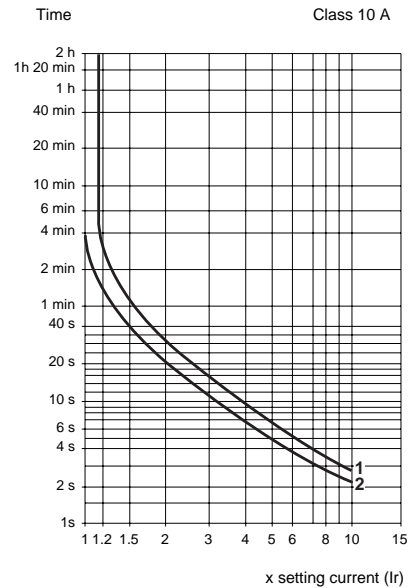
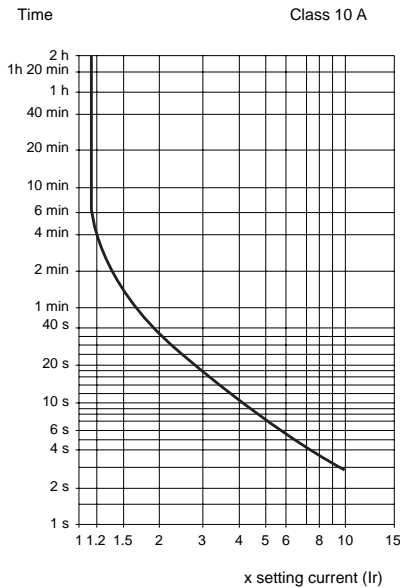

TeSys™ K-line Mini-Contactors and Starters Selection of Type LR•K Overload Relays

These overload relays are designed for the protection of motors. They are ambient-compensated and phase-failure sensitive. They may be reset either manually or automatically.

For direct mounting, the relays are placed under the contactors with screw clamp terminals only (pre-wired terminals; see page 64). For separate mounting, use terminal block LA7K0064 (see below).

The front face of the overload relay provides:

- Selection of reset mode: Manual (marked H) or Automatic (marked A).
- A red pushbutton for the Trip Test function.
- A blue pushbutton for Stop and manual reset.
- A yellow trip flag to indicate that the overload relay tripped.



LR2K0301

Three-Pole Overload Relays with Screw Clamp Terminals

Short-circuit protection for North American applications		By circuit breaker			Select in accordance with NEC and local codes	
		By fuses			Maximum 400% of motor FLA	
Relay Setting Range	European type fuses			Catalog Number	Weight lb. (kg)	
	Maximum rating Type					
	aM	gI	BS88			
A	A	A	A			
Class 10 (the standard specifies a tripping time of between 2 and 10 seconds at 7.2 In)						
0.11 to 0.16	0.25	0.5	–	LR2K0301	0.32 (0.145)	
0.16 to 0.23	0.25	0.5	–	LR2K0302	0.32 (0.145)	
0.23 to 0.36	0.5	1	–	LR2K0303	0.32 (0.145)	
0.36 to 0.54	1	1.6	–	LR2K0304	0.32 (0.145)	
0.54 to 0.8	1	2	–	LR2K0305	0.32 (0.145)	
0.8 to 1.2	2	4	6	LR2K0306	0.32 (0.145)	
1.2 to 1.8	2	6	6	LR2K0307	0.32 (0.145)	
1.8 to 2.6	4	8	10	LR2K0308	0.32 (0.145)	
2.6 to 3.7	4	10	16	LR2K0310	0.32 (0.145)	
3.7 to 5.5	6	16	16	LR2K0312	0.32 (0.145)	
5.5 to 8	8	20	20	LR2K0314	0.32 (0.145)	
8 to 11.5	10	25	20	LR2K0316	0.32 (0.145)	
10 to 14	16	32	25	LR2K0321 ♦	0.32 (0.145)	
12 to 16	20	40	32	LR2K0322 ♦	0.32 (0.145)	

♦ Not UL Listed or CSA Certified.

Overload Relays without Single-phase Sensitivity ♦

Class 10: To order, replace the prefix **LR2** by **LR7** in the catalog numbers selected from above (only applicable to overload relays LR2K0305 to LR2K0322). Example: **LR7K0308**.

♦ Not UL Listed or CSA Certified.

Accessory

Description	Type of Connection	Catalog Number	Weight lb. (kg)
Terminal block for separate clip-on mounting of the overload relay on 35 mm DIN rail	Screw clamp	LA7K0064	0.22 (0.100)



LA7K0064

TeSys™ K-line Mini-Contactors and Starters

Dimensions, Mounting, and Schematics for Type LR•K Overload Relays

Protection Components

LR2K
Direct mounting beneath the contactor

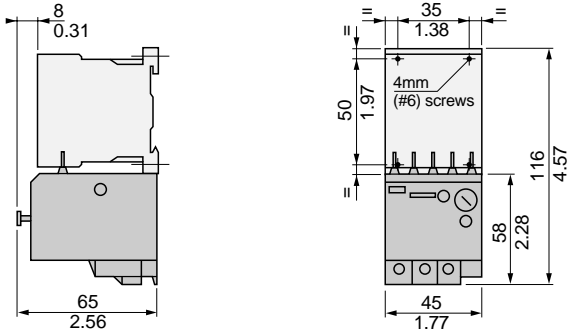

Separate mounting with terminal block **LA7K0064** on 1.4 in. (35 mm) DIN rail
(**AM1DP200** or **AM1DE200**)

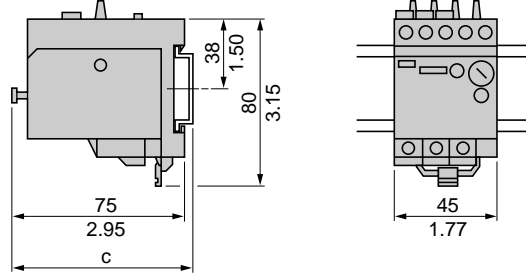

AM1-	c
DP200	3.09 in. / 78.5mm
DE200	3.38 in. / 86mm

LR2K

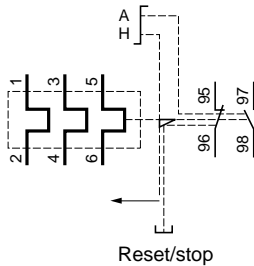

LR2K + LC•K
Built-in wiring schematic

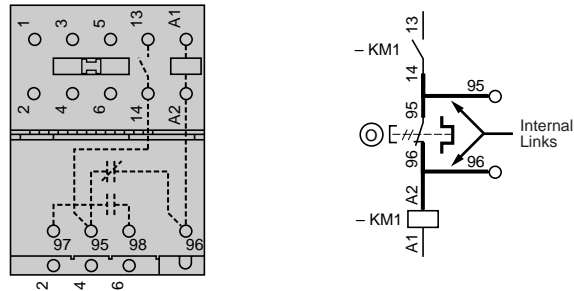

LR2K Overload Relays feature built-in wiring to save time and materials when all five links of the overload relay are connected to a K-line contactor with an integrated N.O. (normally-open) auxiliary contact. Terminal 96 of the N.C. (normally-closed) overload relay contact (95-96) will be internally linked in series with terminal A2 of the contactor operating coil. Terminal 95 of the N.C. overload relay contact (95-96) will be internally linked in series with terminal 14 of N.O. coil holding contact (13-14) of the contactor. These internal links help to eliminate additional wiring when using a conventional 3-wire control circuit similar to the diagram shown.

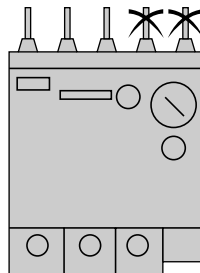
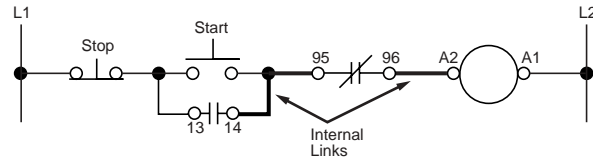





If integrated wiring between contactor and overload relay is not desired, break off the two links on the overload relay as indicated.

TeSys™ K-line Mini-Contactors and Starters

Characteristics of Type LP•K Low-consumption Contactors

Environment

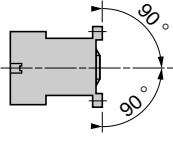
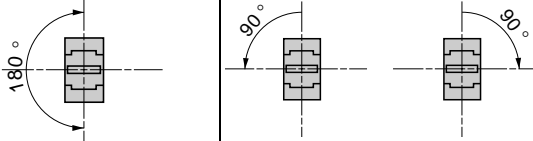
Rated insulation voltage (Vi)	Conforming to IEC 60947	V	690		
	Conforming to VDE 0110 gr C	V	750		
	Conforming to BS 5424, NF C 20-040	V	690		
	Conforming to CSA 22.2 No. 14, UL 508	V	600		
Rated impulse withstand voltage (Vimp)		kV	8		
Conforming to standards	 Meets the essential requirements of the LV & EMC directives		IEC 60947, NF C 63-110, VDE 0660, BS 5424, UL 508, CSA 22.2 No. 14		
Approvals	LP•K06, LP•K09, LP•K12	 E164862 NLDX (screw clamp)  LR43364 3211 04  E164862 NLDX2 (Slip-on & solder pin)			
Protective treatment	Conforming to IEC 60068 (DIN 50016)		"TC" (Fungus-proof, Tropicalization protection)		
Degree of protection	Conforming to VDE 0106		Protection against direct finger contact		
Ambient air temperature around the device	Storage		- 50 to + 80 °C (-58 to +176 °F)		
	Operation		- 25 to + 50 °C (-13 to +122 °F)		
Maximum operating altitude	Without derating		2000 m (6562 ft)		
Operating positions	Vertical axis	Horizontal axis			
					
	Without derating	Without derating	Derate current carrying capability by 15% when not mounted vertically		
Flame resistance	Conforming to UL 94		Self-extinguishing materials V1		
	Conforming to NF F 16-101 and 16-102		Conforming to requirement 2		
Shock resistance (1/2 sine wave, 11 ms)	Contactors open		10 g		
	Contactors closed		15 g		
Vibration resistance 5 to 300 Hz	Contactors open		2 g		
	Contactors closed		4 g		
Safe separation of circuits	Conforming to VDE 0106 and IEC 60536		SELV, up to 400 V ▲		
Cabling		Min	Max	Max to IEC 60947	
	Screw clamp terminals	Solid or stranded cable	AWG 1 x 18	2 x 14 or 1 x 12	-
		Solid cable	mm ² 1 x 1.5	2 x 4	1 x 4 + 1 x 2.5
		Stranded cable without cable end	mm ² 1 x 0.75	2 x 4	2 x 2.5
		Stranded cable with cable end	mm ² 1 x 0.34	1 x 1.5 + 1 x 2.5	1 x 1.5 + 1 x 2.5
Slip-on connectors	Clip	2 x 2.8mm or 1 x 6.35mm (2 x 0.110 in. or 1 x 0.250 in.)			
Solder pins for printed circuit board	With locating device between power and control circuits	4 mm x 35 microns			
Tightening torque	Phillips no. 2 or 3/16" slotted head screwdriver		0.8 to 1.3 N•m (7 to 11.5 lb.-in)		
Terminal referencing	Conforming to standards EN 50005 and EN 50012		Up to 3 contacts		

▲ Safe extra low voltage.

TeSys™ K-line Mini-Contactors and Starters

Characteristics of Type LP•K Low-consumption Contactors

Pole Characteristics

Conventional rated thermal current (I_{th})	For ambient temperature ≤ 50 °C (122°F)		A	20						
Rated operational frequency			Hz	50/60						
Frequency limits of the operational current			Hz	Up to 400						
Rated operational voltage (V_e)			V	690						
Rated making capacity	I _{rms} conforming to NF C 63-110 and IEC 60947		A							
	LP•K06, LP•K09 LP•K12			110 144						
Rated breaking capacity	Conforming to NF C 63-110 and IEC 60947		V	220/ 230	380/ 400	415	440	500	660/ 690	
	LP•K06, LP•K09 LP•K12	I _{rms}	A	110 –	110 –	110 –	110 120	80 80	70 70	
Permissible short time rating	Open mounted, for a time "t" from cold state (θ ≤ 50 °C [122 °F])			1 s	5 s	10 s	30 s	1 min	3 min	≥15 min
	LP•K06, LP•K09 LP•K12		A	90 115	85 105	80 100	60 75	45 55	40 50	20 25
Short-circuit protection	By circuit breaker		Select in accordance with NEC and local codes							
	By fuses		Max 400% of motor FLA							
Average impedance per pole	At I _{th} and 50 Hz		mΩ	3						
Utilization in category AC-1 resistive circuits, heating, lighting (V _e ≤ 440 V)	Maximum rated operational current for a temperature ≤ 50 °C (122 °F)		A	20						
	Rated operational current limits in relation to on-load factor and operating frequency		A	On-load factor		90%	60%	30%		
				300 op. cycles/hour		13	15	18		
				120 op. cycles/hour		15	18	19		
			30 op. cycles/hour		19	20	20			
Increase in operational current by paralleling poles		Apply the following coefficients to the current values given above. These take into account the often unbalanced current distribution between poles								
		2 poles in parallel: K = 1.60								
		3 poles in parallel: K = 2.25								
		4 poles in parallel: K = 2.80								
Utilization in category AC-3 Squirrel cage motors	Operational power according to the voltage	Voltage 50 or 60Hz	V	115	220	220/ 240	380/ 415	440/ 480	500/ 600	660/ 690
	LP•K06	Motor ratings	kW	0.37	0.75	1.5	2.2	3	3	3
	LP•K09	Motor ratings	kW	0.55	1.1	2.2	4	4	4	4
	LP•K12	Motor ratings	kW	–	–	3	5.5	5.5 4 (480)	4	4
	Percent utilization of operational power in relation to the maximum operating rate				Op. cycles/h		600	900	1200	
				Power		100%	75%	50%		
Utilization in category AC-3 Squirrel cage motors	Operational power according to the voltage	Voltage 50 or 60Hz	V	115	220	200/ 208	220/ 240	460/ 480	575/ 600	
	LC•K06, LP•K06	Motor ratings	HP	0.5	1	1.5	1.5	3	3	
	LC•K09, LP•K09	Motor ratings	HP	0.5	1.5	2	3	5	5	
	LC•K12, LP•K12	Motor ratings	HP	1	2	3	3	7.5	10	
	LC•K16, LP•K16	Not for North American Applications. Not UL Listed or CSA Certified.								

TeSys™ K-line Mini-Contactors and Starters

Characteristics of Type LP•K Low-consumption Contactors

Control Circuit Characteristics

Type		LP4	LP5
Rated control circuit voltage (Vc)	V	DC 12 to 72	
Control voltage limits (≤ 50 °C [122 °F]) single-voltage coil	For operation	0.7 to 1.30 Vc	
	For drop-out	≥ 0.10 Vc	
Average consumption at 20 °C (68 °F) and at Vc	Inrush	W	1.8
	Sealed	W	1.8
Heat dissipation	W	1.8	
Operating time at 20 °C (68 °F) and at Vc	Between coil energization and: - opening of the N.C. contacts - closing of the N.O. contacts	ms ms	25 to 35 30 to 40
	Between coil de-energization and: - opening of the N.O. contacts - closing of the N.C. contacts	ms ms	10 to 20 15 to 25
Maximum immunity to micro breaks	ms	2	
Maximum operating rate	In operating cycles per hour	3600	
Mechanical durability at Vc In millions of operating cycles	Wide range DC coil	30	5

Auxiliary Contact Characteristics of Contactors and Instantaneous Contact Blocks

Number of contacts	On LP4, LP5K		1
	On LA1K		2 max.
Rated operational voltage (Ve)	Up to	V	690
Rated insulation voltage (Vi)	Conforming to BS 5424	V	690
	Conforming to IEC 60947	V	690
	Conforming to VDE 0110 group C	V	750
	Conforming to CSA 22.2 No. 14, UL 508	V	600
Conventional rated thermal current (Ith)	For ambient temperature ≤ 50 °C (122 °F)	A	10
Frequency of operational current		Hz	Up to 400
Minimum switching capacity	V min (DIN 19 240)	V	17 (reliability <10 ⁻⁸ at 24V)
	I min	mA	5
Short-circuit protection	Conforming to IEC 60947 and VDE 0660, gl fuse	A	10
Rated making capacity	Conforming to IEC 60947	I rms	A 110
		1 s	A 80
Overload current	Permissible for	500 ms	A 90
		100 ms	A 110
Insulation resistance		MΩ	> 10
Non-overlap distance	Linked contacts conforming to INRS and BIA specs.	mm	0.5 (0.02")

Operational power of contacts
conforming to IEC 60947

AC supply, category AC-15

Electrical durability (valid up to 3600 operating cycles per hour) on an inductive load such as the coil of an electromagnet: making current (power factor 0.7) = 10 times the breaking current (power factor 0.4).

DC supply, category DC-13

Electrical durability (valid up to 1200 operating cycles per hour) on an inductive load such as the coil of an electromagnet, without economy resistor, the time constant increasing with the load.

	V	24	48	110/127	220/230	380/400	400	600/690	V	24	48	110	220	440	600
1 million operating cycles	VA	48	96	240	440	800	880	1200	W	120	80	60	52	51	50
3 million operating cycles	VA	17	34	86	158	288	317	500	W	55	38	30	28	26	25
10 million operating cycles	VA	7	14	36	66	120	132	200	W	15	11	9	8	7	6
Occasional making capacity	VA	1000	2050	5000	10000	14000	13000	9000	W	720	600	400	300	230	200

Power in broken VA

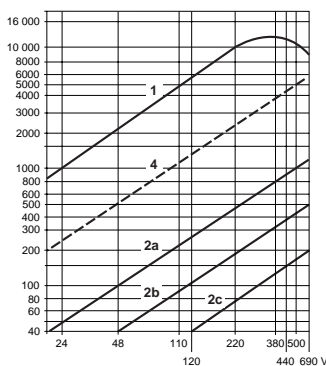

- Breaking limit of contacts valid for maximum of 50 operating cycles at 10 s intervals (breaking current = making current x power factor 0.7).
- Electrical durability of contacts for:
 - 1 million operating cycles (2a)
 - 3 million operating cycles (2b)
 - 10 million operating cycles (2c).
- Breaking limit of contacts valid for maximum of 20 operating cycles at 10 s intervals with current passing for 0.5 s per operating cycle.
- Thermal limit.

Power in broken W

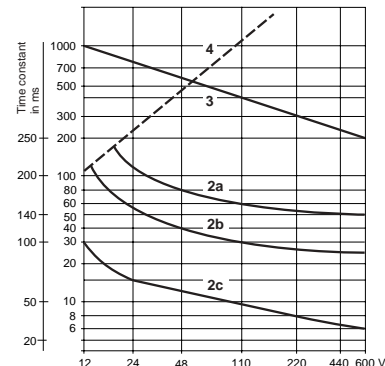

TeSys™ K-line Mini-Contactors and Starters

Selection of Low-consumption Contactors for Motor Control

The table below shows three-pole contactors with low-consumption coils for DC control circuits. They are compatible with programmable controller outputs, and incorporate an LED indicator. For wide-range coils (0.7 to 1.3 Vc), a suppressor (zener diode) is fitted as standard (consumption is 1.8 W).

The contactors mount on 35 mm DIN rails or with 4 mm (# 6) screws. The wire termination screws are in the open, "ready-to-tighten" position.

For information on add-on auxiliary contact blocks and accessories, see page 72.

Three-Pole Contactors with Low-consumption Coils for DC Control Circuits

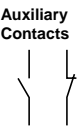
Horsepower Ratings for North American Applications						Kilowatt Ratings for International Applications				Type of Connection	Auxiliary Contacts		Catalog Number ◆ ▼	Weight lb. (kg)	
Maximum Horsepower Rating Category AC-3, 50/60 Hz						Max. Inductive Current	Standard power ratings of 3-phase motors, 50/60 Hz in category AC-3				Rated Operational Current, up to 440 V				
1-Phase		3-Phase					220 V 230 V	380 V 415 V	440/500 V 660/690 V						N.O.
115/ 120 V	230/ 240 V	200/ 208 V	220/ 240 V	460/ 480 V	575/ 600 V	A	kW	kW	kW	A					
HP	HP	HP	HP	HP	HP										
0.5	1	1.5	1.5	3	3	6	1.5	2.2	3	6	Screw clamp	1	–	LP4K0610◆◆◆	0.52 (0.235)
												–	1	LP4K0601◆◆◆	0.52 (0.235)
											Slip-on 1 x 0.25 in., or 2 x 0.11 in.	1	–	LP4K06107◆◆◆	0.52 (0.235)
												–	1	LP4K06017◆◆◆	0.52 (0.235)
											Solder pins for printed circuit board	1	–	LP4K06105◆◆◆	0.265 (0.58)
	–	1	LP4K06015◆◆◆	0.58 (0.265)											
											Spring terminals	1	–	LP4K06103◆◆◆	0.52 (0.235)
												–	1	LP4K06013◆◆◆	0.52 (0.235)
0.5	1.5	2	3	5	5	9	2.2	4	4	9	Screw clamp	1	–	LP4K0910◆◆◆	0.52 (0.235)
												–	1	LP4K0901◆◆◆	0.52 (0.235)
											Slip-on 1 x 0.25 in., or 2 x 0.11 in.	1	–	LP4K09107◆◆◆	0.52 (0.235)
												–	1	LP4K09017◆◆◆	0.52 (0.235)
											Solder pins for printed circuit board	1	–	LP4K09105◆◆◆	0.58 (0.265)
	–	1	LP4K09015◆◆◆	0.58 (0.265)											
											Spring terminals	1	–	LP4K09103◆◆◆	0.52 (0.235)
												–	1	LP4K09013◆◆◆	0.52 (0.235)
1	2	3	3	7.5	10	12	3	5.5	4 (> 440) 5.5 (440)	12	Screw clamp	1	–	LP4K1210◆◆◆	0.52 (0.235)
												–	1	LP4K1201◆◆◆	0.52 (0.235)
											Slip-on 1 x 0.25 in., or 2 x 0.11 in.	1	–	LP4K12107◆◆◆	0.52 (0.235)
												–	1	LP4K12017◆◆◆	0.52 (0.235)
											Solder pins for printed circuit board	1	–	LP4K12105◆◆◆	0.58 (0.265)
	–	1	LP4K12015◆◆◆	0.58 (0.265)											
											Spring terminals	1	–	LP4K12103◆◆◆	0.52 (0.235)
												–	1	LP4K12013◆◆◆	0.52 (0.235)

◆ Standard control circuit voltages (variable delivery times, please consult your Local Square D Field Sales Office).

▼ Use voltage codes on page 52 "Voltage Code Table" to complete catalog number.



LP4K06105◆◆◆

TeSys™ K-line Mini-Contactors and Starters

Selection of Low-consumption Reversing Contactors for Motor Control

The table below shows three-pole reversing contactors with low-consumption coils for DC control circuits. They are compatible with programmable controller outputs, and incorporate an LED indicator and mechanical interlock. For wide-range coils (0.7 to 1.3 Vc), a suppressor (zener diode) is fitted as standard (consumption is 1.8 W).

The contactors mount on 35 mm DIN rails or with 4 mm (# 6) screws. The wire termination screws are in the open, "ready-to-tighten" position. Customer wiring is required to connect coil terminations to the electrical interlock; see page 75 for more information.

For information on add-on auxiliary contact blocks and accessories, see page 72.

Three-Pole Reversing Contactors with Low-Consumption Coils for DC Control Circuits

Horsepower Ratings for North American Applications							Kilowatt Ratings for International Applications				Type of Connection	Auxiliary Contacts		Catalog Number ◆ ▼	Weight lb. (kg)
Maximum Horsepower Rating Category AC-3, 50/60 Hz						Max. Inductive Current	Standard power ratings of 3-phase motors, 50/60 Hz in category AC-3			Rated Operational Current, up to 440 V		N.O.	N.C.		
1-Phase		3-Phase					220 V 230 V	380 V 415 V	440/500 V 660/690 V						
115/ 120 V	230/ 240 V	200/ 208 V	220/ 240 V	460/ 480 V	575/ 600 V	A	kW	kW	kW	A					
0.5	1	1.5	1.5	3	3	6	1.5	2.2	3	6	Screw clamp ▲	1	–	LP5K0610◆◆◆	1.08 (0.490)
											–	1	LP5K0601◆◆◆	1.08 (0.490)	
											Slip-on 1 x 0.25 in., or 2 x 0.11 in.	1	–	LP5K06107◆◆◆	1.03 (0.470)
											–	1	LP5K06017◆◆◆	1.03 (0.470)	
											Solder pins for printed circuit board	1	–	LP5K06105◆◆◆	1.17 (0.530)
–	1	LP5K06015◆◆◆	1.17 (0.530)												
Spring terminals	1	–	LP5K06103◆◆◆	1.08 (0.490)											
–	1	LP5K06013◆◆◆	1.08 (0.490)												
0.5	1.5	2	3	5	5	9	2.2	4	4	9	Screw clamp ▲	1	–	LP5K0910◆◆◆	1.08 (0.490)
											–	1	LP5K0901◆◆◆	1.08 (0.490)	
											Slip-on 1 x 0.25 in., or 2 x 0.11 in.	1	–	LP5K09107◆◆◆	1.03 (0.470)
											–	1	LP5K09017◆◆◆	1.03 (0.470)	
											Solder pins for printed circuit board	1	–	LP5K09105◆◆◆	1.17 (0.530)
–	1	LP5K09015◆◆◆	1.17 (0.530)												
Spring terminals	1	–	LP5K09103◆◆◆	1.08 (0.490)											
–	1	LP5K09013◆◆◆	1.08 (0.490)												
1	2	3	3	7.5	10	12	3	5.5	4 (> 440) 5.5 (440)	12	Screw clamp ▲	1	–	LP5K1210◆◆◆	1.08 (0.490)
											–	1	LP5K1201◆◆◆	1.08 (0.490)	
											Slip-on 1 x 0.25 in., or 2 x 0.11 in.	1	–	LP5K12107◆◆◆	1.03 (0.470)
											–	1	LP5K12017◆◆◆	1.03 (0.470)	
											Solder pins for printed circuit board	1	–	LP5K12105◆◆◆	1.17 (0.530)
–	1	LP5K12015◆◆◆	1.17 (0.530)												
Spring terminals	1	–	LP5K12103◆◆◆	1.08 (0.490)											
–	1	LP5K12013◆◆◆	1.08 (0.490)												

◆ Standard control circuit voltages (variable delivery times, please consult your Local Square D Field Sales Office.).

▲ Pre-wired power circuit connections are standard on screw clamp versions.

▼ Use voltage codes on page 52 "Voltage Code Table" to complete catalog number.



LP5K06105◆◆◆

TeSys™ K-line Mini-Contactors and Starters

Selection of Low-consumption Contactors for Resistive Loads



LP4K090047**

Three- and Four-Pole Contactors with Low-consumption Coils for DC Control Circuits

The table below shows three- and four-pole contactors with low-consumption coils for DC control circuits. They are compatible with programmable controller outputs, and incorporate an LED indicator. For wide-range coils (0.7 to 1.3 Vc), a suppressor (zener diode) is fitted as standard (consumption is 1.8 W).

The contactors mount on 35 mm DIN rails or with 4 mm (# 6) screws. The wire termination screws are in the open, "ready-to-tighten" position. For information on add-on auxiliary contact blocks and accessories, see page 72.

Non-inductive loads Category AC-1 Maximum current at ≤ 50 °C (122 °F)	Type of Connection	Power Poles		Auxiliary Contacts		Catalog Number ◆ ▼	Weight lb. (kg)
		N.O.	N.C.	N.O.	N.C.		
A	Screw clamp	3	–	1	–	LP4K0910***	0.52 (0.235)
		4	–	–	1	LP4K0901***	0.52 (0.235)
		2	2	–	–	LP4K09008***	0.52 (0.235)
	Slip-on 1 x 0.25 in. or 2 x 0.11 in.	3	–	1	–	LP4K09107***	0.52 (0.235)
		4	–	–	–	LP4K09017***	0.52 (0.235)
		2	2	–	–	LP4K090087***	0.52 (0.235)
	Solder pins for printed circuit board	3	–	1	–	LP4K09105***	0.58 (0.265)
		4	–	–	–	LP4K09015***	0.58 (0.265)
		2	2	–	–	LP4K090085***	0.58 (0.265)
	Spring terminals	3	–	1	–	LP4K09103***	0.52 (0.235)
		4	–	–	–	LP4K09013***	0.52 (0.235)
		2	–	–	–	LP4K090083***	0.52 (0.235)

◆ Standard control circuit voltages (variable delivery times, please consult your Local Square D Field Sales Office.).

▼ Use voltage codes on page 52 "Voltage Code Table" to complete catalog number.

TeSys™ K-line Mini-Contactors and Starters

Selection of Low-consumption Contactors for Resistive Loads







LP5K0910...

Three- and Four-Pole Contactors with Low-Consumption Coils for DC Control Circuits

The table below shows three-pole reversing and four-pole change over contactors with low-consumption coils for DC control circuits. They are compatible with programmable controller outputs, and incorporate an LED indicator and mechanical interlock. For wide-range coils (0.7 to 1.3 Vc), a suppressor (zener diode) is fitted as standard (consumption is 1.8 W).

The contactors mount on 35 mm DIN rails or with 4 mm (# 6) screws. The wire termination screws are in the open, "ready-to-tighten" position. Customer wiring is required to connect coil terminations to the electrical interlock; see page 75 for more information.

For information on add-on auxiliary contact blocks and accessories, see page 72.

Non-inductive loads Category AC-1 Maximum current at ≤ 50 °C (122 °F)	Type of Connection	Power Poles		Auxiliary Contacts		Catalog Number ◆▼	Weight lb. (kg)
							
A		N.O.	N.C.	N.O.	N.C.		
20	Screw clamp	3	–	1	–	LP5K0910... ■	1.08 (0.490)
		3	–	–	1	LP5K0901... ■	1.08 (0.490)
		4	–	–	–	LP5K09004... ■	1.08 (0.490)
	Slip-on 1 x 0.25 in. or 2 x 0.11 in.	3	–	1	–	LP5K09107... ■	1.03 (0.470)
		3	–	–	1	LP5K09017... ■	1.03 (0.470)
		4	–	–	–	LP5K090047... ■	1.17 (0.530)
	Solder pins for printed circuit board	3	–	1	–	LP5K09105... ■	1.17 (0.530)
		3	–	–	1	LP5K09015... ■	1.17 (0.530)
		4	–	–	–	LP5K090045... ■	1.17 (0.530)
	Spring terminals	3	–	1	–	LP5K09103... ■	1.08 (0.490)
		3	–	–	1	LP5K09013... ■	1.08 (0.490)
		4	–	–	–	LP5K090043... ■	1.08 (0.490)

◆ Standard control circuit voltages (variable delivery times, please consult your Local Square D Field Sales Office.).

■ WARNING: These reversing contactors are pre-wired for reverse motor operation

▼ Use voltage codes on page 52 "Voltage Code Table" to complete catalog number.

TeSys™ K-line Mini-Contactors and Starters

Selection of Auxiliary Contacts and Accessories for Low-consumption Contactors

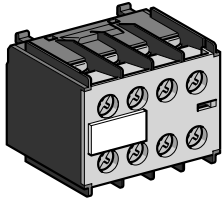

LA1KN••

Instantaneous Auxiliary Contact Blocks (clip-on front mounting, 1 block per contactor)

Type of Connection	Type of Contactor	Auxiliary Contacts		Catalog Number	Weight lb. (kg)
		N.O.	N.C.		
Screw clamp	3- or 4-pole	2	–	LA1KN20	0.10 (0.045)
		–	2	LA1KN02	0.10 (0.045)
		1	1	LA1KN11	0.10 (0.045)
Slip-on 1 x 0.25 in. or 2 x 0.11 in.	3- or 4-pole	2	–	LA1KN207	0.10 (0.045)
		–	2	LA1KN027	0.10 (0.045)
		1	1	LA1KN117	0.10 (0.045)
Spring terminals	3- or 4-pole	2	–	LA1KN203	0.10 (0.045)
		–	2	LA1KN023	0.10 (0.045)
		1	1	LA1KN113	0.10 (0.045)
With terminal referencing conforming to EN 50012					
Screw clamp •	3-pole, 6 and 9 A	–	2	LA1KN02M	0.10 (0.045)
		1	1	LA1KN11M	0.10 (0.045)
	4-pole, 9 A	1	1	LA1KN11P	0.10 (0.045)

• See pages 75 and 76 for actual markings.

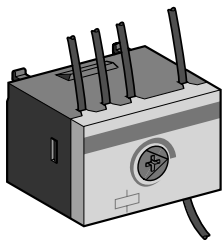

LA2KT2•

Electronic Time-Delay Auxiliary Contact Blocks

- Relay output, with common point changeover contact, AC or DC 240 V, 2 A maximum.
- Control voltage: 0.85 to 1.1 Vc.
- Maximum switching capacity: 250 VA or 150 W.
- Operating temperature: -10 to +60 °C (14 to 140 °F).
- Reset time: 1.5 s during the time-delay period, 0.5 s after the time delay period.

Clip-on front mounting, 1 block per contactor

Voltage	Type	Timing Range	Auxiliary Contacts	Catalog Number	Weight lb. (kg)
			SPDT		
V		s	SPDT		
AC or DC 24 to 48 (1)	On-delay	1 to 30	1	LA2KT2E	0.09 (0.040)

Mounting and Marking Accessories

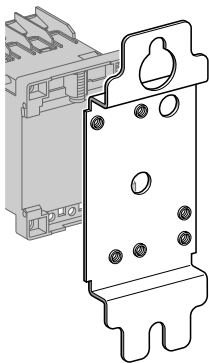

DX1AP25

Description	Application		Sold in lots of	Unit Catalog No.	Weight lb. (kg)
Mounting plates (order 1 for a contactor; order 2 for a reversing contactor)	For mounting on 1 rail	Clip-on	1	LA9D973	0.05 (0.025)
	For mounting on 2 rails	110/120 mm mounting centers	10	DX1AP25	0.14 (0.065)
Marker holder	Clip-on	On to front of contactor	100	LA9D90	0.002 (0.001)
Clip-in markers	4 maximum per contactor	Strips of 10 identical numbers 0 to 9 ▲	25	AB1R• ▲	0.004 (0.002)
		Strips of 10 identical capital letters A to Z ▲	25	AB1G• ▲	0.004 (0.002)
35mm " DIN rail (7.5 mm deep x 2 m long)			10	AM1DP200	2.88 (1.310)
35mm " DIN rail (15 mm deep x 2 m long)			10	AM1ED200	1.44 (0.650)

▲ Complete the catalog number by replacing the • with the required number or character.

Cabling Accessories

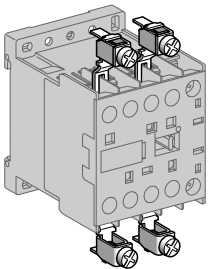

LA9E01

Description	Application		Sold in lots of	Unit Catalog No.	Weight lb. (kg)
Paralleling links	For 2-poles	With screw clamp terminals	4	LA9E01	0.02 (0.010)
	For 4-poles	With screw clamp terminals	2	LA9E02	0.03 (0.015)
Set of 6 power connections	For 3-pole reversing contactors for motor control	For contactors with screw clamp terminals	100	LA9K0969	0.02 (0.010)
Set of 4 power connections	For 4-pole changeover contactor pairs	For contactors with screw clamp terminals	100	LA9K0970	0.02 (0.010)

(1) Low consumption K-line contactors are DC only.

TeSys™ K-line Mini-Contactors and Starters Dimensions and Mounting of Low-consumption Contactors

Contactors LP4K

On panel

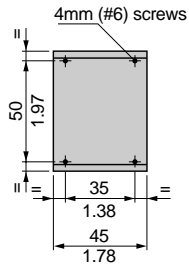
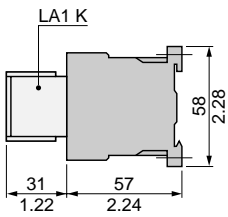

On mounting rail **AM1DP200** or **AM1DE200** 1.4 in. (35 mm) DIN rail

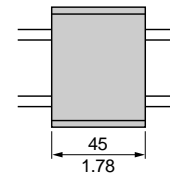
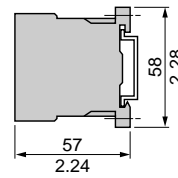

On one asymmetrical rail **DZ5MB** with clip-on mounting plate

LA9D973

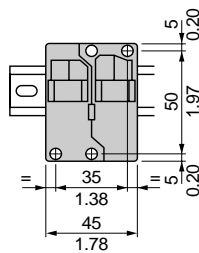
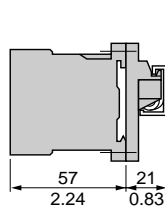

DX1AP25

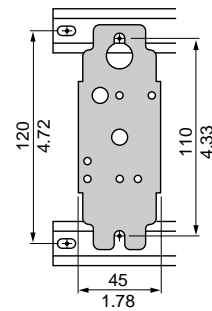
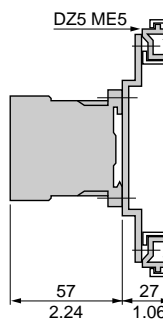

On printed circuit board

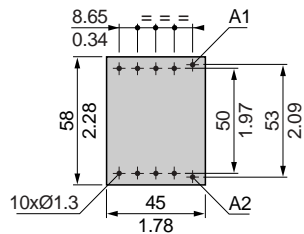

Electronic time-delay auxiliary contact blocks

LA2KT

On contactor

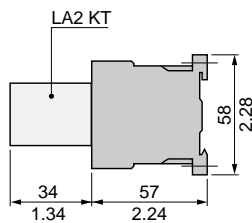
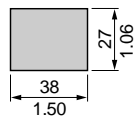
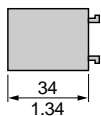

Dimensions $\frac{\text{inches}}{\text{mm}}$

TeSys™ K-line Mini-Contactors and Starters

Dimensions and Mounting of Low-consumption Reversing Contactors

Reversing contactors LP5K

On panel

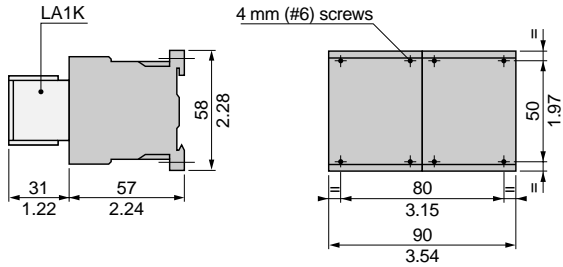

On mounting rail **AM1DP200** or **AM1DE200** 1.4 in. (35 mm) DIN rail

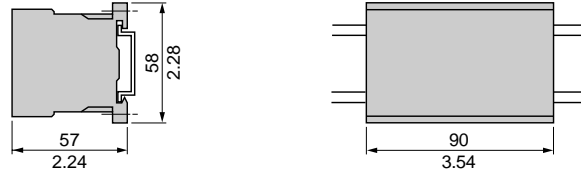

On one asymmetrical rail **DZ5MB** with 2 clip-on mounting plates **LA9D973** or on 2 mounting plates **DX1AP25**.

2 x LA9D973

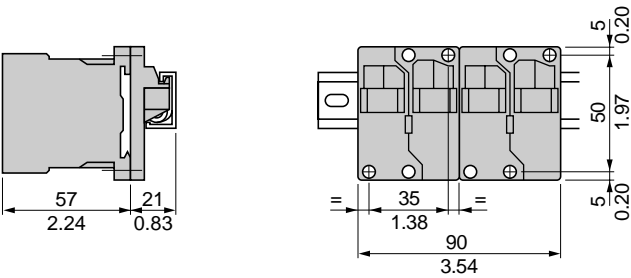

2 x DX1AP25

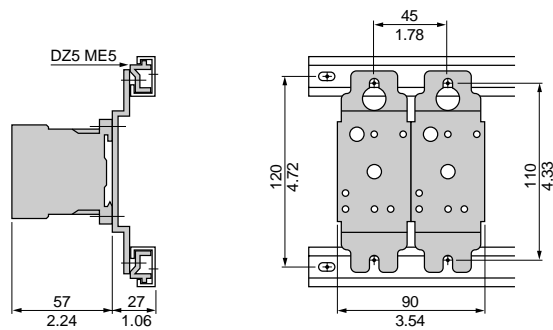

On printed circuit board for reversing contactors or 2 contactors mounted side by side

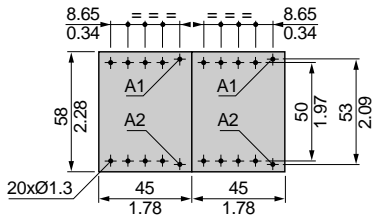

Electronic time-delay auxiliary contact blocks

LA2KT

On reversing contactors

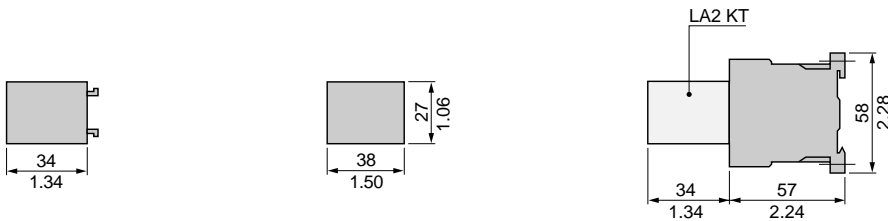

Dimensions inches
mm

Type LP•K Three-Pole Low-Consumption Contactors, Reversing Contactors, and Accessories

3-pole contactors LP4K

3-pole + N.O.

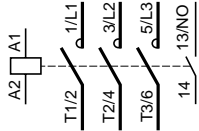

3-pole + N.C.

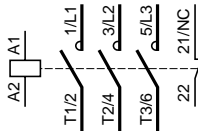

Integrated-coil suppression device
LP4K

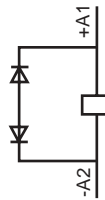

3-pole reversing contactors LP5K

With screw clamp terminals

3-pole + N.O.

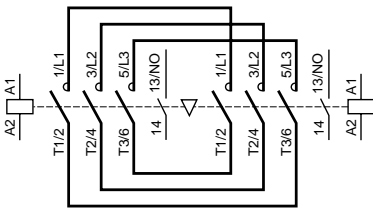

Dashed lines indicate suggested customer wiring to electrically interlock coils

3-pole + N.C.

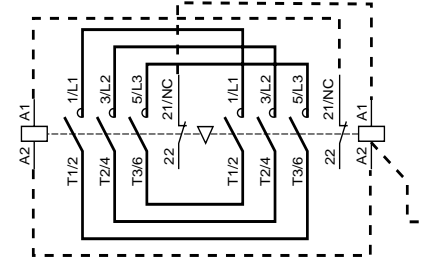

Integrated-coil suppression device
LC5K

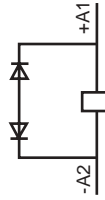

With Slip-on connectors or solder pins for printed circuit boards

3-pole + N.O.

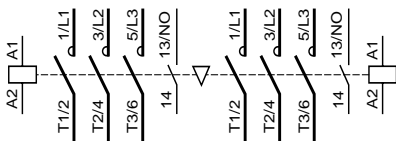

3-pole + N.O.

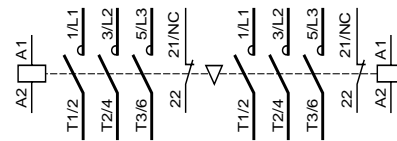

Instantaneous auxiliary contact blocks LA1K

For 3-pole contactors

2 N.O.
LA1KN20
LA1KN207



2 N.C.
LA1KN02
LA1KN027



1 N.O. + 1 N.C.
LA1KN11
LA1KN117



Terminal referencing conforming to standard EN 50012

2 N.C.
LA1KN02



1 N.O. + 1 N.C.
LA1KN11M



Electronic Time-delay Auxiliary Contact Blocks LA2KT

For 3-pole contactors LP•K

1 C/O

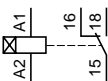

TeSys™ K-line Mini-Contactors and Starters

Type LP•K Schematics

Type LP•K Four-Pole Low-Consumption Contactors, Reversing Contactors, and Accessories

4-pole contactors LP4K

4-pole + N.O.

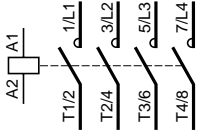

2-pole N.O. + 2-pole N.C.

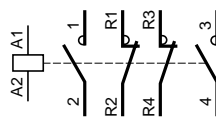

Integrated-coil suppression device
LP4K

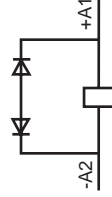

4-pole reversing contactors LP5K

With screw clamp terminals

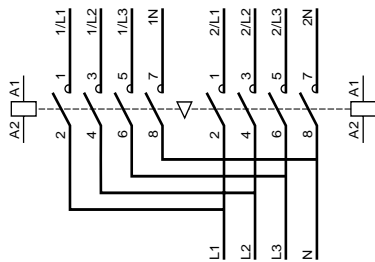

With slip-on terminals or solder pins for printed circuits boards

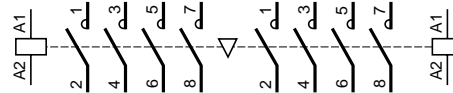

Integrated-coil suppression device
LP5K

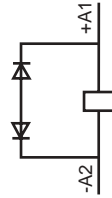

Instantaneous auxiliary contact blocks LA1K

2 N.O.
LA1KN20
LA1KN207

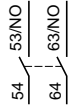

2 N.C.
LA1KN02
LA1KN027

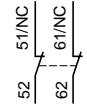

1 N.O. + 1 N.C.
LA1KN11
LA1KN117

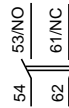

Terminal referencing conforming to standard EN 50012
1 N.O. + 1 N.C.
LA1KN11P



Electronic Time-delay Auxiliary Contact Blocks

LA2KT

For 3-pole contactors LP•K

1 C/O

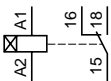

TeSys™ D-Line

Contactors, Enclosed Starters, Overload Relays, and Accessories

Catalog

04

File 8502



CONTENTS

Description	Page
General Information	79
Contactors	
Characteristics	80
Selection	88
Auxiliary Contacts, Timers, and Accessories Characteristics	100
Auxiliary Contacts, Timers, and Accessories Selection	106
D-line Voltage Code Table	115
Replacement Coils	117
Dimensions and Mounting	122
Schematics	126
Overload Relays	
Characteristics	130
Selection	134
Dimensions, Mounting, and Schematics	138
Plate-mounted Starters	144
Wye-delta Starters	146
Enclosed Contactors and Starters	
Horsepower Rated Devices for North American Applications	151
Kilowatt Rated Devices for International Applications	159
Cross Reference List	175

TeSys™ D-Line Contactors and Starters

General Information

The D-line contactors and overload relays are the largest selling line of contactors and starters in the world. They offer high reliability with long mechanical and electrical life and the most complete line of accessories in the industry.

Contactors Ratings

- D-line contactors and overload relays are available in 11 contactor ratings for the USA market for inductive motor applications up to 150 full-load amps and resistive loads up to 200 A. They offer motor control and overload protection for motors rated up to 100 hp at 480 Vac or 125 hp at 600 Vac.
- 3-pole and 4-pole contactor versions available.
- All contactors include built-in auxiliary contacts.
- All screw connections have IP20 rated touch-safe terminals with both North American and International terminal markings.
- D-line contactors can be panel mounted with screws or DIN rail mounted.

Easily Installed Accessories

- Auxiliary contact blocks with serrated wiping action
- Front mount dust tight auxiliary contact blocks
- Pneumatic time delay blocks
- Transient voltage surge suppressors
- Interface modules and electronic timers
- Mechanical latching blocks

Control Circuit Flexibility

The D-line contactors are available with ac or dc operating coils. Several devices utilize a low-consumption dc coil with built-in transient suppression for operation with a low-level dc signal from a computer or PLC without need for an interposing relay.

Overload Relays



Class 10 or Class 20 bimetallic overload relays are available up to 140 A. They are bimetallic ambient compensated and are available with or without single-phase sensitivity for phase unbalance and phase loss protection. New solid state overload relays are available for 90 to 150 A applications. Both bimetallic and solid-state overload relays include the following features:

- Isolated N.C. trip contact and N.O. alarm contacts.
- Manual or Automatic reset function (bi-metallic versions only).
- Tamper-resistant window for FLA settings.
- Test trip button.

TeSys™ D-Line Contactors and Starters

Characteristics of Type LC•D and LP•D Contactors

Environment

Type			LC1D09	LC1D12	LC1D18	LC1D25	
			LC1DT20	LC1DT25	LC1DT32	LC1DT40	
Rated insulation voltage (Vi)	UL/CSA	V	690	690	690	690	
	To IEC 60947-4-1, overvoltage category III, degree of pollution: 3	V	1000	1000	1000	1000	
	Conforming to UL, CSA	V	600	600	600	600	
Rated impulse withstand voltage (Vimp)	Conforming to IEC 60947	kV	6	6	6	6	
Conforming to standards	 Meets the essential requirements of the LV & EMC directives		IEC 60947-1, 60947-4-1, NFC 63-110, VDE 0660, BS 5424, JEM 1038., EN 60947-1, EN 60947-4-1.				
Approvals	 E164862 CCN NLDX	 LR43364 Class 3211 04	ASE, UL, CSA, DEMKO, NEMKO, SEMKO, FI, Conforming to SNCF, Sichere Trennung recommendations				
Degree of protection ♦	Conforming to VDE 0106	Power connections	Protection against direct finger contact IP 2X				
		Coil connections	Protection against direct finger contact IP 2X				
Protective treatment	Conforming to IEC 60068		"TH"				
Ambient air temperature around the device	Storage		- 60 to + 80 °C (-76 to +176 °F)				
	Operation at 80 to 110% nominal control voltage		- 5 to + 60 °C (+23 to +140 °F)				
	Permissible at nominal control voltage		- 40 to + 70 °C (-40 to +158 °F)				
Maximum operating altitude	Without derating		3000m (8900 ft.)				
Operating positions	Without derating		± 30° possible, in relation to normal vertical mounting plane				
Flame resistance	Conforming to UL 94		V 1	V1	V1	V1	
	Conforming to IEC 60695-2-1		960°	960°	960°	960°	
Shock resistance ▲ 1/2 sine wave = 11ms	Contacteur open		10 g	10 g	10 g	8 g	
	Contacteur closed		15 g	15 g	15 g	15 g	
Vibration resistance ▲ 5 to 300 Hz	Contacteur open		2 g	2 g	2 g	2 g	
	Contacteur closed		4 g	4 g	4 g	4 g	
Pole characteristics							
Number of poles			3	3 or 4	3	3 or 4	
Rated operational current (Ie)	In ac-3, θ ≤ 55°C (131°F)	A	9	12	18	25	
	In ac-1, θ ≤ 40°C (104°F)	A	25	25	32	40	
Rated operational voltage (Ve)	Up to	V	690	690	690	690	
Frequency limits	Of the operational current	Hz	25 to 400	25 to 400	25 to 400	25 to 400	
Rated thermal current (Ith)	θ ≤ 40°C (104°F)	A	25	25	32	40	
Rated making capacity (1 rms)	Conforming to IEC 60947-4	A	250	250	300	450	
Rated breaking capacity (1 rms)	Conforming to IEC 60947	220-380-415-440 V	A	250	250	300	450
		500 V	A	175	175	250	400
		690 V		85	85	120	180
Permissible short time rating from cold state, no current flowing for previous 15 minutes, at θ ≤ 40 °C (104 °F)	For 1 s	A	210	210	240	380	
	For 10 s	A	105	105	145	240	
	For 1 min	A	61	61	84	120	
	For 10 min	A	30	30	40	50	
Short-circuit protection	By circuit breaker		Select circuit breaker in accordance with NEC and local codes				
	By fuses		Maximum 400% of motor full load Amps				
Average impedance per pole	A Ith and 50 Hz	mΩ	2.5	2.5	2.5	2	
Power dissipation per pole for the above operational currents	AC-3	W	0.20	0.36	0.8	1.25	
	AC-1	W	1.56	1.56	2.5	3.2	



♦ Protection provided for the cable c.s.a. indicated on page 86 and for cable connections.

▲ In the least favorable direction, without change of contact state (coil supplied at Ve).

TeSys™ D-Line Contactors and Starters

Characteristics of Type LC•D and LP•D Contactors

Environment

Type			LC1D32	LC1D38	LC1D40	LC1D50	LC1D65	LC1D80	LC1D95	LC1D115	LC1D150
					LP1D40	LP1D50	LP1D65	LP1D80			
Rated insulation voltage (Vi)	UL/CSA	V	690	690	690	690	690	690	690	690	690
	To IEC 60947-4-1, overvoltage category III, degree of pollution: 3	V	1000	1000	1000	1000	1000	1000	1000	1000	1000
	Conforming to UL, CSA	V	600	600	600	600	600	600	600	600	600
Rated impulse withstand voltage (Vimp)	Conforming to IEC 60947	kV	6	6	8	8	8	8	8	8	8
Conforming to standards	 Meets the essential requirements of the LV & EMC directives		IEC 60947-1, 60947-4-1, NFC 63-110, VDE 0660, BS 5424, JEM 1038., EN 60947-1, EN 60947-4-1.								
Approvals	 E164862 CCN NLDX	 LR43364 Class 3211 04	ASE, UL, CSA, DEMKO, NEMKO, SEMKO, FI, Conforming to SNCF, Sichere Trennung recommendations				UL 508, CSA C22.2 No.14				
Degree of protection ♦	Conforming to VDE 0106	Power connections	Protection against direct finger contact IP 2X								
		Coil connections	Protection against direct finger contact IP 2X except LP1D40 to LP1D80								
Protective treatment	Conforming to IEC 60068		"TH"								
Ambient air temperature around the device	Storage		- 60 to + 80 °C (-76 to +176 °F)								
	Operation at 80 to 110% nominal control voltage		- 5 to + 55 °C (+23 to +131 °F)								
	Permissible at nominal control voltage		- 40 to + 70 °C (-40 to +158 °F)								
Maximum operating altitude	Without derating		3000m (8900 ft.)								
Operating positions	Without derating		± 30° possible, in relation to normal vertical mounting plane								
Flame resistance	Conforming to UL 94	V 1	V 1	V 1	V 1	V 1	V 1	V 1	V 1	V 1	V 1
	Conforming to IEC 60695-2-1	960°	960°	960°	960°	960°	960°	960°	960°	960°	960°
Shock resistance ▲ 1/2 sine wave = 11ms	Contacteur open	8 g	8 g	8 g	8 g	8 g	8 g	8 g	8 g	6 g	6 g
	Contacteur closed	15 g	10 g	10 g	10 g	10 g	10 g	10 g	10 g	15 g	15 g
Vibration resistance ▲ 5 to 300 Hz	Contacteur open	2 g	2 g	2 g	2 g	2 g	2 g	2 g	2 g	2 g	2 g
	Contacteur closed	4 g	4 g	3 g	3 g	3 g	3 g	3 g	3 g	4 g	4 g
Pole characteristics											
Number of poles			3	3	3 or 4	3	3 or 4	3 or 4	3	3 or 4	3
Rated operational current (Ie)	In ac-3, θ ≤ 55°C (131°F)	A	32	38	40	50	65	80	95	115	150
	In ac-1, θ ≤ 40°C (104°F)	A	50	50	60	80	80	125	125	200	200
Rated operational voltage (Ve)	Up to	V	690	690	1000	1000	1000	1000	1000	1000	1000
Frequency limits	Of the operational current	Hz	25 to 400	25 to 400	25 to 400	25 to 400	25 to 400	25 to 400	25 to 400	25 to 400	25 to 400
Rated thermal current (Ith)	θ ≤ 40°C (104°F)	A	50	50	60	80	80	125	125	200	200
Rated making capacity (1 rms)	Conforming to IEC 60947-4	A	550	–	800	900	1000	1100	–	–	–
Rated breaking capacity (1 rms)	Conforming to IEC 60947	220-380-415-440 V	550	–	800	900	1000	1100	–	–	–
		500 V	450	–	800	900	1000	1100	–	–	–
		690 V	180	–	400	400	630	640	–	–	–
Permissible short time rating from cold state, no current flowing for previous 15 minutes, at θ ≤ 40 °C (104 °F)	For 1 s	A	430	430	720	810	900	990	1100	1100	1400
	For 10 s	A	260	310	320	400	520	640	800	950	1200
	For 1 min	A	138	150	165	208	260	320	400	550	580
	For 10 min	A	60	60	72	84	110	135	135	250	250
Short-circuit protection	By circuit breaker		Select circuit breaker in accordance with NEC and local codes								
	By fuses		Maximum 400% of motor full load Amps								
Average impedance per pole	A Ith and 50 Hz	mΩ	2	2	1.5	1.5	1	0.8	0.8	0.6	0.6
Power dissipation per pole for the above operational currents	AC-3	W	2	2	2.4	3.7	4.2	5.1	7.2	7.9	13.5
	AC-1	W	5	5	5.4	9.6	6.4	12.5	12.5	24	24

♦ Protection provided for the cable c.s.a. indicated on page 86 and for cable connections.

▲ In the least favorable direction, without change of contact state (coil supplied at Ve).

TeSys™ D-Line Contactors and Starters

Characteristics of Type LC•D and LP•D Contactors

Control Circuit Characteristics

Type				LC1D09	LC1D12	LC1D18	LC1D25	LC1D32	LC1D38				
				LC1DT20	LC1DT25	LC1DT32	LC1DT40						
Rated control circuit voltage (Vc)		50 or 60 Hz		V				21 to 660					
Control voltage limits ($\theta \leq 55^\circ\text{C}$ [131°F])		50 or 60 Hz coils		Operational		0.8 to 1.1 Vac							
				Drop-out		0.3 to 0.6 Vac							
		50/60 Hz coils		Operational		0.85 to 1.1 Vac at 60 Hz							
				Drop-out		0.3 to 0.6 Vac							
Average consumption at 20°C (68°F) and at Vc		50 Hz ac		Inrush		50 Hz coil	VA	–	–	–	–	–	
						Cos φ		0.75	0.75	0.75	0.75	0.75	0.75
						50/60 Hz coil		VA	70	70	70	70	70
				Sealed		50 Hz coil		VA	–	–	–	–	–
						Cos φ		0.3	0.3	0.3	0.3	0.3	0.3
						50/60 Hz coil		VA	7	7	7	7	7
		60 Hz ac		Inrush		60 Hz coil		VA	–	–	–	–	–
						Cos φ		0.75	0.75	0.75	0.75	0.75	0.75
						50/60 Hz coil		VA	70	70	70	100	70
				Sealed		60 Hz coil		VA	–	–	–	–	–
						Cos φ		0.3	0.3	0.3	0.3	0.3	0.3
						50/60 Hz coil		VA	7.5	7.5	7.5	7.5	7.5
Heat dissipation		50/60 Hz		W		2 to 3	2 to 3	2 to 3	2.5 to 3.5	2 to 3	2 to 3		
Operating time		Closing "C" ■		ms		12 to 22	12 to 22	12 to 22	15 to 24	12 to 22	12 to 22		
		Opening "O" ▲		ms		4 to 19	4 to 19	4 to 19	5 to 19	4 to 19	4 to 19		
Mechanical durability in millions of operating cycles		50 or 60 Hz coil				–	–	–	–	–	–		
		50/60 Hz coil at 50 Hz				15	15	15	15	15	15		
Maximum operating rate at ambient temperature $\leq 55^\circ\text{C}$ (131°F)		In operating cycles per hour				3600	3600	3600	3600	3600	3600		

■ The closing time "C" is measured from the moment the coil supply is switched on to initial contact of the main poles.

▲ The opening time "O" is measured from the moment the coil supply is switched off to the moment the mains poles separate.

TeSys™ D-Line Contactors and Starters

Characteristics of Type LC•D and LP•D Contactors

Control Circuit Characteristics

Type			LC1D40	LC1D50	LC1D65	LC1D80	LC1D95	LC1D115	LC1D150		
Rated control circuit voltage (Vc)	50 or 60 Hz	V	24 to 660						24 to 500		
Control voltage limits ($\theta \leq 55\text{ °C}$ [131 °F])	50 or 60 Hz coils	Operational	0.85 to 1.1 Vac						-		
		Drop-out	0.3 to 0.6 Vac						0.3 to 0.5 Vc		
	50/60 Hz coils	Operational	0.85 to 1.1 Vac at 60 Hz				0.8 to 1.15 Vac at 50/60 Hz				
		Drop-out	0.3 to 0.6 Vac						0.3 to 0.5 Vc		
Average consumption at 20 °C (68 °F) and at Vc	50 Hz ac	Inrush	50 Hz coil	VA	200	200	200	200	200	300	-
			Cos ϕ		0.75	0.75	0.75	0.75	0.75	0.8	0.9
			50/60 Hz coil	VA	245	245	245	245	245	280-350	280-350
		Sealed	50 Hz coil	VA	20	20	20	20	20	22	-
			Cos ϕ		0.3	0.3	0.3	0.3	0.3	0.3	0.9
			50/60 Hz coil	VA	26	26	26	26	26	2 to 18	2 to 18
	60 Hz ac	Inrush	60 Hz coil	VA	220	220	220	220	220	300	-
			Cos ϕ		0.75	0.75	0.75	0.75	0.75	0.8	0.9
			50/60 Hz coil	VA	245	245	245	245	245	280-350	280-350
		Sealed	60 Hz coil	VA	22	22	22	22	22	22	-
			Cos ϕ		0.3	0.3	0.3	0.3	0.3	0.3	0.9
			50/60 Hz coil	VA	26	26	26	26	26	6	6
Heat dissipation	50/60 Hz	W	6 to 10	6 to 10	6 to 10	6 to 10	6 to 10	2 to 18	2 to 18		
Operating time	Closing "C" ■	ms	20 to 26	20 to 26	20 to 26	20 to 35	20 to 35	20 to 50	20 to 35		
	Opening "O" ▲	ms	8 to 12	8 to 12	8 to 12	6 to 20	6 to 20	6 to 20	40 to 75		
Mechanical durability in millions of operating cycles	50 or 60 Hz coil		16	16	16	10	10	8	-		
	50/60 Hz coil at 50 Hz		6	6	6	4	4	8	8		
Maximum operating rate at ambient temperature $\leq 55\text{ °C}$ (131 °F)	In operating cycles per hour		3600	3600	3600	3600	3600	2400	1200		

■ The closing time "C" is measured from the moment the coil supply is switched on to initial contact of the main poles.

▲ The opening time "O" is measured from the moment the coil supply is switched off to the moment the mains poles separate.

TeSys™ D-Line Contactors and Starters

Characteristics of Type LC•D and LP•D Contactors

DC Control Circuit Characteristics

Type of contactor			LC1 D09 to D38 DT20 to DT40	LP1 D12 and D25	LC1 or LP1 D40 to D65	LC1 or LP1D80	LC1D115 & LC1D150	
Rated control circuit voltage (Uc)	dc	V	12 to 440		12 to 440		24 to 440	
Rated insulation voltage	Conforming to IEC 60947-1	V	690					
	Conforming to UL, CSA	V	600					
Control voltage limits	Operational	Standard coil	0.7 to 1.25 Uc at 60 °C (140 °F)	0.8 to 1.1 Uc @ 55 °C (131 °F)	0.85 to 1.1 Uc at 55 °C (131 °F)		0.75 to 1.2 Uc at 55 °C (131 °F)	
		Wide range coil	–	0.7 to 1.25 Uc @ 55 °C (131 °F)	0.75 to 1.2 Uc at 55 °C (131 °F)		–	
	Drop-out		0.1 to 0.25 Uc at 60 °C (140 °F)		0.1 to 0.3 Uc at 55 °C (131 °F)		0.15 to 0.4 Uc at 55 °C (131 °F)	
Average consumption at 20 °C (68 °F) and at Uc	dc	Inrush	W	5.4	9/11	22	22	270 to 365
		Sealed	W	5.4	9/11	22	22	2.4 to 5.1
Average operating time at Uc (1)	Closing	"C"	ms	55	52 - 64	85 to 110	95 to 130	20 to 35
	Opening	"O"	ms	20	8 - 14	20 to 35	20 to 35	40 to 75
Note: The arcing time depends on the circuit switched by the poles. For normal three-phase applications, the arcing time is usually less than 10 ms. The load is isolated from the supply after a time equal to the sum of the opening time and the arcing time.								
Time constant (L/R)		ms	28	42	65	75	25	
Mechanical life at Uc	In millions of operating cycles		30	30	20	20	8	
Maximum operating rate at ambient temperature ≤ 60 °C (140 °F)	In operating cycles per hour		3600	3600	3600	3600	1200	

Low Consumption Control Circuit Characteristics

Rated insulation voltage	Conforming to IEC 60947-1	V	690				
	Conforming to UL, CSA	V	600				
Maximum voltage	Of the control circuit on dc		250				
Average consumption dc at 20 °C and at Uc	Wide range coil (0.7 to 1.25 Uc)	Inrush	W	2.4			
		Sealed	W	2.4			
Operating time (1) at Uc and at 20 °C (68 °F)	Closing	"C"	ms	70			
	Opening	"O"	ms	25			
Voltage limits $\theta \leq 60$ °C (140 °F) of the control circuit	Operational		0.7 to 1.25 Uc				
	Drop-out		0.1 to 0.3 Uc				
Time constant (L/R)		ms	40				
Mechanical life	In millions of operating cycles		30				
Maximum operating rate	At ambient temperature ≤ 60 °C (140 °F)	ops/h	3600				
Rated insulation voltage	Conforming to UL, CSA	V	600				
	Conforming to IEC 60947-1	V	690				

- (1) Operating times depend on the type of contactor electromagnet and its control mode.
The closing time "C" is measured from the moment the coil supply is switched on to initial contact of the main poles. The opening time "O" is measured from the moment the coil supply is switched off to the moment the main poles separate.

TeSys™ D-Line Contactors and Starters

Characteristics of Type LC•D and LP•D Contactors

Contactor Integral Auxiliary Contact Characteristics

Linked contacts conforming to draft standard IEC 60947-4-5	Each contactor has two N.O. and N.C. contacts mechanically linked on the same movable contact holder.		
Mirror contact	The N.C. contact on each contactor represents the state of the power contacts and can be connected to a PREVENTA safety module		
Rated operational voltage (Ue)	Up to	V	690
Rated insulation voltage (Ui)	Conforming to IEC 60947-1	V	690
	Conforming to UL, CSA	V	600
Conventional thermal current (Ith)	For ambient temperature ≤ 60 °C (140 °F)	A	10
Operating current frequency		Hz	25 to 400
Minimum switching capacity	U min.	V	17
	I min.	mA	5
Short-circuit protection ●	Conforming to IEC 60947-5-1		gG fuse: 10 A
Rated making capacity	Conforming to IEC 60947-5-1, I rms	A	ac: 140; dc: 250
Short-time rating	Permissible for	1 s	A 100
		500 ms	A 120
		100 ms	A 140
Insulation resistance		MΩ	> 10
Non-overlap time	Guaranteed between N.C. and N.O. contacts	ms	1.5 on energizing and on de-energizing

- Select short circuit protection to meet the National Electrical Code or other local codes and standards.

ac supply categories AC-14 and AC-15

Contact operating power
conforming to IEC 60947-5-1

Electrical life (valid for up to 3600 operating cycles/hour) on an inductive load such as the coil of an electromagnet making power (cos φ 0.7) = 10 times the power broken (cos φ 0.4).

dc supply category DC-13

Electrical life (valid for up to 1200 operating cycles/hour) on an inductive load such as the coil of an electromagnet, without economy resistor, the time constant increasing with the load.

	V	24	48	115	230	400	440	600	V	24	48	125	250	440
1 million operating cycles	VA	60	120	280	560	960	1050	1440	W	96	76	76	76	44
3 million operating cycles	VA	16	32	80	160	280	300	420	W	48	38	38	32	–
10 million operating cycles	VA	4	8	20	40	70	80	100	W	14	12	12	–	–

AC-15

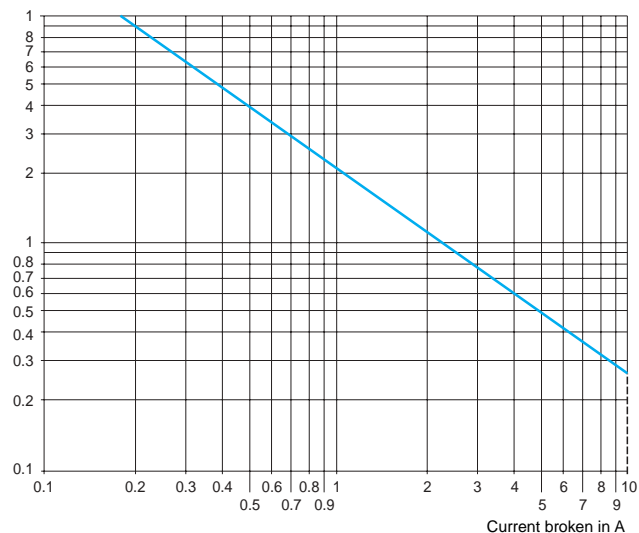

DC-13

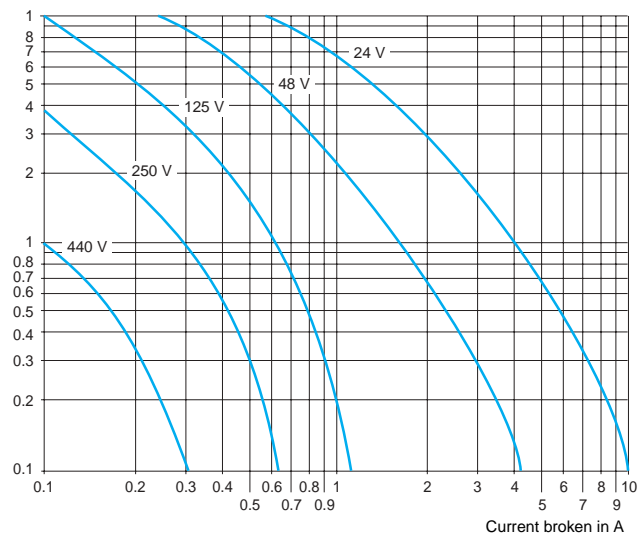

TeSys™ D-Line Contactors and Starters

Characteristics of Type LC•D and LP•D Contactors

Power Circuit Connections

Type			LC1 D09, D12 DT20, DT25	LC1D18 LC1DT32	LC1D25 LC1DT40	LC1D32	LC1D38	LC1D40 LP1D40	LC1D50 LP1D50	
Cabling (for screw clamp terminals)	Stranded cable without cable end	1 conductor	AWG	18-10	18-8	18-8	14-6	–	10-3	10-3
		2 conductors	AWG	18-10	18-8	18-8	14-6	–	10-4	10-4
	Stranded cable with cable end	1 conductor	mm ²	1/4	1.5/6	1.5/10	2.5/10	2.5/10	2.5/25	2.5/25
		2 conductors	mm ²	1/4	1.5/6	1.5/6	2.5/10	2.5/10	2.5/16	2.5/16
	Solid cable without cable end	1 conductor	AWG	18-10	18-3	18-3	18-3/0	–	10-4	10-4
		2 conductors	AWG	18-10	18-10	18-10	14-2	–	12-2	12-2
	Phillips head type	1 conductor	mm ²	1/4	1/6	1/6	1/10	1/10	2.5/25	2.5/25
		2 conductors	mm ²	1/2.5	1/4	1/4	1.5/6	1.5/6	2.5/10	2.5/10
	Screwdriver Ø	1 conductor	AWG	18-8	18-8	18-8	14-8	–	10-3	10-3
		2 conductors	AWG	18-8	18-8	18-8	10-8	–	10-6	10-6
	Hexagon spanner	1 conductor	mm ²	1/4	1.5/6	1.5/6	1.5/10	1.5/10	2.5/25	2.5/25
		2 conductors	mm ²	1/4	1.5/6	1.5/6	2.5/10	2.5/10	2.5/16	2.5/16
	Tightening torque	1 conductor	mm ²	1/4	1.5/6	1.5/6	2.5/10	2.5/10	2.5/16	2.5/16
		2 conductors	mm ²	1/4	1.5/6	1.5/6	2.5/10	2.5/10	2.5/16	2.5/16
Bus bar connection (for bus bar or ring-tongue terminals)	Connection by bus bar or ring-tongue terminals									
	Bar c.s.a.		–	–	–	–	–	–	–	–
	Lug external Ø	mm	8	8	10	10	10	13	16	
	Screw Ø	mm	M3.5	M3.5	M4	M4	M4	M5	M6	
	Phillips head type		N° 2	N° 2	N° 2	N° 2	N° 2	N° 2	N° 3	
	Screwdriver Ø		Ø 6	Ø 6	Ø 6	3/16 in. Ø 6 mm	3/16 in. Ø 6 mm	Ø 8 mm	Ø 8 mm	
	Hexagon spanner		–	–	–	–	–	–	–	
Tightening torque		15 lb.-in. 1.7 N•m	15 lb.-in. 1.7 N•m	15 lb.-in. 1.7 N•m	20 lb.-in. 7.5 N•m	20 lb.-in. 7.5 N•m	53 lb.-in. 6 N•m	71 lb.-in. 6 N•m		
Flexible cabling (for spring terminals)	Spring terminals									
	Flexible cable without cable end	1 conductor	AWG	14	12	12	12	12	–	–
		2 conductors	AWG	14	12	12	12	12	–	–
	Solid cable without cable end	1 conductor	mm ²	2.5	4	4	4	4	–	–
		2 conductors	mm ²	2.5	4	4	4	4	–	–

Control Circuit Connections

Type			LC1 D09, D12 DT20, DT25	LC1D18 LC1DT32	LC1D25 LC1DT40	LC1D32	LC1D38	LC1D40 LP1D40	LC1D50 LP1D50	
Connection by cable										
Screw clamp terminals										
Cabling	Stranded cable without cable end	1 conductor	AWG (mm ²)	18 - 10 (1/4)	18 - 10 (1/4)	18 - 10 (1/4)	1/4	18 - 10 (1/4)	18 - 10 (1/4)	18 - 10 (1/4)
		2 conductors	AWG (mm ²)	18 - 10 (1/4)	18 - 10 (1/4)	18 - 10 (1/4)	1/4	18 - 10 (1/4)	18 - 10 (1/4)	18 - 10 (1/4)
	Stranded cable with cable end	1 conductor	AWG (mm ²)	18 - 10 (1/4)	18 - 10 (1/4)	18 - 10 (1/4)	1/4	18 - 10 (1/4)	18 - 10 (1/4)	18 - 10 (1/4)
		2 conductors	AWG (mm ²)	18 - 12 (1/2.5)	18 - 12 (1/2.5)	18 - 12 (1/2.5)	18 - 12 (1/2.5)	18 - 12 (1/2.5)	18 - 12 (1/2.5)	18 - 12 (1/2.5)
	Solid cable without cable end	1 conductor	AWG (mm ²)	18 - 10 (1/4)	18 - 10 (1/4)	18 - 10 (1/4)	1/4	18 - 10 (1/4)	18 - 10 (1/4)	18 - 10 (1/4)
		2 conductors	AWG (mm ²)	18 - 10 (1/4)	18 - 10 (1/4)	18 - 10 (1/4)	1/4	18 - 10 (1/4)	18 - 10 (1/4)	18 - 10 (1/4)
Phillips head type				N° 2	N° 2	N° 2	N° 2	N° 2	N° 2	
Screwdriver Ø			mm	Ø 6	Ø 6	Ø 6	Ø 6	Ø 6	Ø 6	
Tightening torque				15 lb.-in. 1.7 N•m	15 lb.-in. 1.7 N•m	17 lb.-in. 1.7 N•m	15 lb.-in. 1.7 N•m	15 lb.-in. 1.7 N•m	15 lb.-in. 1.7 N•m	
Connection by bus bar or ring-tongue terminals										
Lug external Ø			mm	8	8	8	8	8	8	
Screw Ø			mm	M3.5	M3.5	M3.5	M3.5	M3.5	M3.5	
Phillips head type				N° 2	N° 2	N° 2	N° 2	N° 2	N° 2	
Screwdriver Ø				3/16 in. Ø 6	3/16 in. Ø 6	3/16 in. Ø 6	3/16 in. Ø 6	3/16 in. Ø 6	3/16 in. Ø 6	
Tightening torque				15 lb.-in. 1.7 N•m	15 lb.-in. 1.7 N•m	15 lb.-in. 1.7 N•m	15 lb.-in. 1.7 N•m	15 lb.-in. 1.7 N•m	15 lb.-in. 1.7 N•m	

TeSys™ D-Line Contactors and Starters

Characteristics of Type LC•D and LP•D Contactors

Power Circuit Connections

Type				LC1D65 LP1D65	LC1D80 LP1D80	LC1D95	LC1D115	LC1D150	
Cabling (for screw clamp terminals)	Stranded cable without cable end	1 conductor	AWG	10-3	10-2	–	8-250 mcm	8-250 mcm	
		2 conductors	AWG	10-4	10-4	–	8-1+8-250 mcm ▲	8-1+8-250 mcm ▲	
	Stranded cable with cable end	1 conductor	mm ²	2.5/25	4/50	4/50	10/120	10/120	
		2 conductors	mm ²	2.5/16	4/25	4/25	10/120+ 10/50 ▲	10/120+ 10/50 ▲	
	Stranded cable with cable end	1 conductor	AWG	10-4	10-4	–	–	–	
		2 conductors	AWG	12-2	12-2	–	–	–	
	Stranded cable with cable end	1 conductor	mm ²	2.5/25	4/50	4/50	10/120	10/120	
		2 conductors	mm ²	2.5/10	4/16	4/16	10/120+ 10/50 ▲	10/120+ 10/50 ▲	
	Solid cable without cable end	1 conductor	AWG	10-3	10-3	–	8-250 mcm	8-250 mcm	
		2 conductors	AWG	10-6	10-2	–	8-0+ 8-250mcm ▲	8-0+8-250 mcm ▲	
	Solid cable without cable end	1 conductor	mm ²	2.5/25	4/50	4/50	10/120	10/120	
		2 conductors	mm ²	2.5/16	4/25	4/25	10/120+ 10/50 ▲	10/120+ 10/50 ▲	
	Phillips head type				–	–	–	–	–
	Screwdriver Ø				Ø 6 to Ø 8	Ø 6 to Ø 8	Ø 6 to Ø 8	–	–
	Hexagon spanner				4 mm	4 mm	4 mm	4 mm	4 mm
Tightening torque				45 lb.-in. 5 N•m	100 lb.-in. 11.3 N•m	100 lb.-in. 11.3 N•m	100 lb.-in. 11.3 N•m	100 lb.-in. 11.3 N•m	
Connection by bus bar or ring-tongue terminals									
Bar c.s.a.				–	3 x 16	3 x 16	5 x 25	5 x 25	
Lug external Ø				mm	16	17	25	25	
Screw Ø				mm	M6	M6	M8	M8	
Phillips head type				N° 3	–	–	–	–	
Screwdriver Ø				Ø 8 mm	Ø 8 mm	Ø 8 mm	–	–	
Hexagon spanner				–	10 mm	10 mm	13 mm	13 mm	
Tightening torque				71 lb.-in. 6 N•m	71 lb.-in. 8 N•m	71 lb.-in. 8 N•m	124 lb.-in. 14 N•m	124 lb.-in. 14 N•m	
Spring terminals									
Flexible cabling (for spring terminals)	Flexible cable without cable end	1 conductor	AWG	–	–	–	–	–	
		2 conductors	AWG	–	–	–	–	–	
		1 conductor	mm ²	–	–	–	–	–	
		2 conductors	mm ²	–	–	–	–	–	

▲ One of each size range.

Control Circuit Connections

Type				LC1D65 LP1D65	LC1D80 LP1D80	LC1D95	LC1D115	LC1D150
Connection by cable								
Screw clamp terminals								
Cabling	Stranded cable without cable end	1 conductor	AWG (mm ²)	18 - 10 (1/4)	18 - 10 (1/4)	18 - 10 (1/4)	18 - 12 (1/2.5)	18 - 12 (1/2.5)
		2 conductors	AWG (mm ²)	18 - 10 (1/4)	18 - 10 (1/4)	18 - 10 (1/4)	18 - 12 (1/2.5)	18 - 12 (1/2.5)
	Stranded cable with cable end	1 conductor	AWG (mm ²)	18 - 10 (1/4)	18 - 10 (1/4)	18 - 10 (1/4)	18 - 12 (1/2.5)	18 - 12 (1/2.5)
		2 conductors	AWG (mm ²)	18 - 12 (1/2.5)	18 - 12 (1/2.5)	18 - 12 (1/2.5)	18 - 12 (1/2.5)	18 - 12 (1/2.5)
	Solid cable without cable end	1 conductor	AWG (mm ²)	18 - 10 (1/4)	18 - 10 (1/4)	18 - 10 (1/4)	18 - 12 (1/2.5)	18 - 12 (1/2.5)
		2 conductors	AWG (mm ²)	18 - 10 (1/4)	18 - 10 (1/4)	18 - 10 (1/4)	18 - 12 (1/2.5)	18 - 12 (1/2.5)
Phillips head type				N° 2	N° 2	N° 2	N° 2	N° 2
Screwdriver Ø				mm	Ø 6	Ø 6	Ø 6	Ø 6
Tightening torque				15 lb.-in. 1.7 N•m	15 lb.-in. 1.7 N•m	15 lb.-in. 1.7 N•m	15 lb.-in. 1.7 N•m	15 lb.-in. 1.7 N•m
Connection by bus bar or ring-tongue terminals								
Lug external Ø				mm	8	8	8	8
Screw Ø				mm	M3.5	M3.5	M3.5	M3.5
Phillips head type					N° 2	N° 2	N° 2	N° 2
Screwdriver Ø					3/16 in. Ø 6	3/16 in. Ø 6	3/16 in. Ø 6	3/16 in. Ø 6
Tightening torque					15 lb.-in. 1.7 N•m	15 lb.-in. 1.7 N•m	15 lb.-in. 1.7 N•m	15 lb.-in. 1.7 N•m

TeSys™ D-Line Contactors and Starters

Selection of Contactors for Motor Control

The tables below show the kilowatt ratings (for international applications) and horsepower ratings (for North American applications) of contactors for motor control.

AC and DC Control Circuit — 3-pole Contactors with Touch-safe Terminals for Power Cabling (AC-3 category)

Maximum horsepower ratings						Maximum Inductive Current in AC-3 Category 600 V	Standard power ratings of 3-phase motors 50/60 Hz in category AC-3								Rated Operating Current in AC-3 up to 440 V	Instantaneous Auxiliary Contacts		Catalog Number ▼◆	Weight lb (kg)
1-phase 50/60 Hz		3-phase 50/60 Hz					220 V 230 V	380 V 400 V	415 V	440 V	500 V	660 V 690 V	1000 V	N.O.		N.C.			
115/ 120 V	230/ 240 V	200/ 208 V	220/ 240 V	460/ 480 V	575 V 600 V														
HP	HP	HP	HP	HP	HP	A	kW	kW	kW	kW	kW	kW	A						
0.5	1	2	2	5	7.5	9	2.2	4	4	4	5.5	5.5	–	9	1	1	LC1D09••	0.71 (0.320)	
1	2	3	3	7.5	10	12	3	5.5	5.5	5.5	7.5	7.5	–	12	1	1	LC1D12••	0.72 (0.325)	
1	3	5	5	10	15	18	4	7.5	9	9	10	10	–	18	1	1	LC1D18••	0.73 (0.330)	
2	3	7.5	7.5	15	20	25	5.5	11	11	11	15	15	–	25	1	1	LC1D25••	0.82 (0.370)	
2	5	10	10	20	30	32	7.5	15	15	15	18.5	18.5	–	32	1	1	LC1D32••	0.83 (0.375)	
Not for North American applications ■						38	9	18.5	18.5	18.5	18.5	18.5	–	38	1	1	LC1D38••	0.84 (0.380)	
3	5	10	10	30	30	40	11	18.5	22	22	22	30	22	40	1	1	LC1D40••	3.11 (1.400)	
3	7.5	15	15	40	40	50	15	22	25	30	30	33	30	50	1	1	LC1D50••	3.11 (1.400)	
5	10	20	20	50	50	65	18.5	30	37	37	37	37	37	65	1	1	LC1D65••	3.11 (1.400)	
7.5	15	25	30	60	60	80	22	37	45	45	55	45	45	80	1	1	LC1D80••	3.53 (1.590)	
Not for North American applications ■						95	25	45	45	45	55	45	45	95	1	1	LC1D95••	3.58 (1.610)	
–	–	30	40	75	100	115	30	55	59	59	75	80	75	115	1	1	LC1D115••	5.38 (2.420)	
–	–	40	50	100	125	150	40	75	80	80	90	100	90	150	1	1	LC1D150••	5.42 (2.440)	

- ◆ For LC1D09 to LC1D38: clip-on mounting on 35 mm DIN rail **AM1DP** or screw mounting.
For LC1D40 to LC1D95: clip-on mounting on 35 mm DIN rail **AM1DE** or 75 mm DIN rail **AM1DL** or screw mounting.
For LC1D115 and LC1D150: clip-on mounting on 2 x 35 mm DIN rails **AM1DP** or screw mounting.
- ▼ Use voltage codes on page 115 "Voltage Code Table" to complete catalog number.
- Devices are UL Listed at the same HP ratings as 32 and 80 amp devices, respectively.

LC1D09••



LC1D65••



LC1D150••



TeSys™ D-Line Contactors and Starters Selection of Contactors for Motor Control

The tables below show the kilowatt ratings (for international applications) and horsepower ratings (for North American applications) of contactors for motor control.



LC1D123••

AC and DC Control Circuit — 3-pole Contactors for Spring Terminal Connections (AC-3 category)

Maximum horsepower ratings						Maximum Inductive Current in AC-3 Category 600 V	Standard power ratings of 3-phase motors 50/60 Hz in category AC-3							Rated Operating Current in AC-3 up to 440 V	Instantaneous Auxiliary Contacts		Catalog Number ▼◆	Weight lb (kg)	
1-phase 50/60 Hz		3-phase 50/60 Hz					220 V 230 V	380 V 400 V	415 V	440 V	500 V	660 V 690 V	1000 V		A	N.O.			N.C.
115/ 120 V	230/ 240 V	200/ 208 V	220/ 240 V	460/ 480 V	575 V 600 V														
HP	HP	HP	HP	HP	HP	A	kW	kW	kW	kW	kW	kW	kW	A	N.O.	N.C.			
0.5	1	2	2	5	7.5	9	2.2	4	4	4	5.5	5.5	—	9	1	1	LC1D093••	0.71 (0.320)	
1	2	3	3	7.5	10	12	3	5.5	5.5	5.5	7.5	7.5	—	12	1	1	LC1D123••	0.72 (0.325)	
1	3	5	5	10	15	18	4	7.5	9	9	10	10	—	18	1	1	LC1D183••	0.73 (0.330)	
2	3	7.5	7.5	15	20	25	5.5	11	11	11	15	15	—	25	1	1	LC1D253••	0.82 (0.370)	
2	5	10	10	20	30	32	7.5	15	15	15	18.5	18.5	—	32	1	1	LC1D323••	0.83 (0.375)	
Not for North American applications ■						38	9	18.5	18.5	18.5	18.5	18.5	18.5	—	38	1	1	LC1D383••	0.84 (0.380)

- ◆ For LC1D09 to LC1D38: clip-on mounting on 35 mm DIN rail AM1DP or screw mounting.
- ▼ Use voltage codes on page 115 "Voltage Code Table" to complete catalog number.
- Device is UL Listed at the same HP ratings as 32 amp device.

TeSys™ D-Line Contactors and Starters

Selection of Contactors for Motor Control



The tables below show the kilowatt ratings (for international applications) and horsepower ratings (for North American applications) of contactors for motor control.

LC1D1506••

AC and DC Control Circuit — 3-pole Contactors for Ring-tongue Terminals or Bus Bar Power Connections (AC-3 category)

Maximum horsepower ratings						Maximum Inductive Current in AC-3 Category 600 V	Standard power ratings of 3-phase motors 50/60 Hz in category AC-3							Rated Operating Current in AC-3 up to 440 V	Instantaneous Auxiliary Contacts		Catalog Number ◆▼	Weight lb (kg)	
1-phase 50/60 Hz		3-phase 50/60 Hz					220 V 230 V	380 V 400 V	415 V	440 V	500 V	660 V 690 V	1000 V		A	N.O.			N.C.
115/120 V	230/240 V	200/208 V	220/240 V	460/480 V	575 V 600 V														
HP	HP	HP	HP	HP	HP	A	kW	kW	kW	kW	kW	kW	kW	A					
0.5	1	2	2	5	7.5	9	2.2	4	4	4	5.5	5.5	—	9	1	1	LC1D096••	0.71 (0.320)	
1	2	3	3	7.5	10	12	3	5.5	5.5	5.5	7.5	7.5	—	12	1	1	LC1D126••	0.72 (0.325)	
1	3	5	5	10	15	18	4	7.5	9	9	10	10	—	18	1	1	LC1D186••	0.73 (0.330)	
2	3	7.5	7.5	15	20	25	5.5	11	11	11	15	15	—	25	1	1	LC1D256••	0.82 (0.370)	
2	5	10	10	20	30	32	7.5	15	15	15	18.5	18.5	—	32	1	1	LC1D326••	0.83 (0.375)	
Not for North American applications ■						38	9	18.5	18.5	18.5	18.5	18.5	—	38	1	1	LC1D386••	0.84 (0.380)	
3	5	10	10	30	30	40	11	18.5	22	22	22	30	22	40	1	1	LC1D406••	2.93 (1.320)	
3	7.5	15	15	40	40	50	15	22	25	30	30	33	30	50	1	1	LC1D506••	2.93 (1.320)	
5	10	20	20	50	50	65	18.5	30	37	37	37	37	37	65	1	1	LC1D656••	2.93 (1.320)	
7.5	15	25	30	60	60	80	22	37	45	45	55	45	45	80	1	1	LC1D806••	3.55 (1.600)	
Not for North American applications ■						95	25	45	45	45	55	45	45	95	1	1	LC1D956••	3.55 (1.600)	
—	—	30	40	75	100	115	30	55	59	59	75	80	75	115	1	1	LC1D1156••	4.69 (2.110)	
—	—	40	50	100	125	150	40	75	80	80	90	100	90	150	1	1	LC1D1506••	4.69 (2.130)	

- ◆ For LC1D09 to LC1D38: clip-on mounting on 35 mm DIN rail AM1DP or screw mounting.
- For LC1D40 to LC1D95: clip-on mounting on 35 mm DIN rail AM1DE or 75 mm DIN rail AM1DL or screw mounting.
- For LC1D115 and LC1D150: clip-on mounting on 2 x 35 mm DIN rails AM1DP or screw mounting.
- ▼ Use voltage codes on page 115 "Voltage Code Table" to complete catalog number.
- Devices are UL Listed at the same HP ratings as 32 and 80 amp devices, respectively.

AC and DC Control Circuit — 3-pole Contactors for Connection with Slip-on Connectors

For contactors LC1D09 and LC1D12 only, replace the last digit in the catalog numbers shown in the table above ("6") with a 9. For example, LC1D096•• becomes LC1D099••. These contactors include slip-on connectors: UL Recognized **E164862 NLDX2**, 2 x 6.35 mm (0.25 in.) on the power poles and 1 x 6.35 mm (0.25 in.) on the coil terminals.

TeSys™ D-Line Contactors and Starters

Selection of Contactors for Resistive Loads (AC-1) and Inductive Loads (AC-3)



LC1DT20**

AC and DC Control Circuit — 3- or 4-Pole Screw Terminal Connections (AC-1 Category)

Maximum Current Utilization Categories		Number of Poles		Instantaneous Auxiliary Contacts		Catalog Number ◆ ▼	Weight lb (kg)
AC-1	AC-3	N.O.	N.C.	N.O.	N.C.		
20	9	3	0	1	1	LC1D09**	0.71 (0.320)
		4	0	1	1	LC1DT20**	0.80 (0.365)
		2	2	1	1	LC1D098**	0.80 (0.365)
25	12	3	0	1	1	LC1D12**	0.75 (0.340)
		4	0	1	1	LC1DT25**	0.80 (0.365)
		2	2	1	1	LC1D128**	0.80 (0.365)
32	18	3	0	1	1	LC1D18**	0.79 (0.355)
		4	0	1	1	LC1DT32**	0.93 (0.425)
		2	2	1	1	LC1D188**	0.93 (0.425)
40	25	3	0	1	1	LC1D25**	0.82 (0.370)
		4	0	1	1	LC1DT40**	0.93 (0.425)
		2	2	1	1	LC1D258**	0.93 (0.425)
50	32	3	0	1	1	LC1D32**	0.83 (0.375)
		3	0	1	1	or ▲ LC1D38** ■	0.84 (0.380)
60	40	3	0	1	1	LC1D40**	3.11 (1.400)
		4	0	1	1	LC1D40004**	0.93 (0.425)
		2	2	1	1	LC1D40008**	0.93 (0.425)
		4	0	1	1	LP1D40004**	0.93 (0.425)
		2	2	1	1	LP1D40008**	0.93 (0.425)
80	65	3	0	1	1	LC1D50**	3.22 (1.450)
		3	0	1	1	or ▲ LC1D65**	3.11 (1.400)
		4	0	0	0	LC1D65004**	3.20 (1.440)
		4	0	0	0	LP1D65004**	4.89 (2.220)
		2	2	0	0	LC1D65008**	3.22 (1.450)
125	80	2	2	0	0	LP1D65008**	4.89 (2.220)
		3	0	1	1	LC1D80**	3.53 (1.590)
		3	0	1	1	or ▲ LC1D95** ■	3.55 (1.600)
		4	0	0	0	LC1D80004**	3.91 (1.760)
		4	0	0	0	LP1D80004**	4.87 (2.210)
200	115	2	2	0	0	LC1D80008**	4.09 (1.940)
		2	2	0	0	LP1D80008**	5.84 (2.650)
		3	0	1	1	LC1D115**	5.38 (2.420)
200	150	3	0	1	1	or ▲ LC1D150**	5.42 (2.440)
		4	0	0	0	LC1D115004**	6.35 (2.860)

AC and DC Control Circuit — 3- or 4-Pole Spring Terminal Connections (AC-1 Category)

20	9	3	0	1	1	◆	LC1D093**	0.710 (0.320)
		4	0	1	1	◆	LC1DT203**	0.837 (0.380)
		2	2	1	1	◆	LC1D0983**	0.837 (0.380)
25	12	3	0	1	1	◆	LC1D123**	0.710 (0.320)
		4	0	1	1	◆	LC1DT253**	0.840 (0.380)
		2	2	1	1	◆	LC1D1283**	0.840 (0.380)
32	18	3	0	1	1	◆	LC1D183**	0.730 (0.330)
		4	0	1	1	◆	LC1DT323**	0.940 (0.425)
		2	2	1	1	◆	LC1D1883**	0.940 (0.425)
40	25	3	0	1	1	◆	LC1D253**	0.820 (0.370)
		4	0	1	1	◆	LC1DT403**	0.940 (0.425)
		2	2	1	1	◆	LC1D2583**	0.940 (0.425)

- ◆ For LC1D09 to LC1D38: clip-on mounting on 35 mm DIN rail AM1DP or screw mounting.
- For LC1D40 to LC1D95: clip-on mounting on 35 mm DIN rail AM1DE or 75 mm DIN rail AM1DL or screw mounting.
- For LC1D115 and LC1D150: clip-on mounting on 2 x 35 mm DIN rails AM1DP or screw mounting.
- ◆ For LC1D09 to LC1D25: clip-on mounting on 35 mm DIN rail AM1DP or screw mounting.
- ▲ Select between the two shown based upon the number of operating cycles; see the AC-1 graph on page 22 for further information.
- ▼ Use voltage codes on page 115 "Voltage Code Table" to complete catalog number.
- Devices are UL Listed at the same ratings as 32 and 80 amp devices, respectively.

TeSys™ D-Line Contactors and Starters

Resistive Loads (AC-1) and Inductive Loads (AC-3)



LC1D150●●

AC and DC Control Circuit — 3- or 4-pole Contactors For Ring Terminals or Bus Bar Power Connections (AC-1 category)

Maximum Current Utilization Categories		Number of Poles		Instantaneous Auxiliary Contacts		Catalog Number ♦ ▼	Weight lb (kg)	
AC-1	AC-3	N.O.	N.C.	N.O.	N.C.			
20	9	3	0	1	1	LC1D096●●	0.71 (0.320)	
		4	0	1	1	LC1DT206●●	0.80 (0.365)	
		2	2	1	1	LC1D0986●●	0.80 (0.365)	
25	12	3	0	1	1	LC1D126●●	0.75 (0.340)	
		4	0	1	1	LC1DT256●●	0.80 (0.365)	
		2	2	1	1	LC1D1286●●	0.80 (0.365)	
32	18	3	0	1	1	LC1D186●●	0.79 (0.355)	
		4	0	1	1	LC1DT326●●	0.93 (0.425)	
		2	2	1	1	LC1D1886●●	0.93 (0.425)	
40	25	3	0	1	1	LC1D256●●	0.82 (0.370)	
		4	0	1	1	LC1DT406●●	0.93 (0.425)	
		2	2	1	1	LC1D2586●●	0.93 (0.425)	
50	32	3	0	1	1	LC1D326●●	0.83 (0.375)	
		3	0	1	1	or ▲ LC1D386●● ■	0.84 (0.380)	
60	40	3	0	1	1	LC1D406●●	3.11 (1.400)	
		4	0	1	1	LC1D400046●●	0.93 (0.425)	
		2	2	1	1	LC1D400086●●	0.93 (0.425)	
		4	0	1	1	LP1D40004●●	0.93 (0.425)	
		2	2	1	1	LP1D40008●●	0.93 (0.425)	
80	80	3	0	1	1	LC1D656●●	3.11 (1.400)	
		4	0	0	0	LC1D800046●●	3.20 (1.440)	
		4	0	0	0	LP1D800046●●	4.89 (2.220)	
		2	2	0	0	LC1D800086●●	3.22 (1.450)	
		2	2	0	0	LP1D800086●●	4.89 (2.220)	
125	80	3	0	1	1	LC1D806●●	3.53 (1.590)	
		4	0	0	0	LC1D800046●●	3.91 (1.760)	
		4	0	0	0	LP1D800046●●	4.87 (2.210)	
		2	2	0	0	LC1D800086●●	4.09 (1.940)	
		2	2	0	0	LP1D800086●●	5.84 (2.650)	
200	115	3	0	1	1	LC1D95●● ■	3.55 (1.600)	
		115	3	0	1	1	LC1D1156●●	5.38 (2.420)
		150	3	0	1	1	or ▲ LC1D1506●●	5.42 (2.440)
	115	4	0	0	0	LC1D1150046●●	6.35 (2.860)	

- ♦ For LC1D09 to LC1D38: clip-on mounting on 35 mm DIN rail AM1DP or screw mounting.
- For LC1D40 to LC1D95: clip-on mounting on 35 mm DIN rail AM1DE or 75 mm DIN rail AM1DL or screw mounting.
- For LC1D115 and LC1D150: clip-on mounting on 2 x 35 mm DIN rails AM1DP or screw mounting.
- ▲ Select between the two shown based upon the number of operating cycles and control voltage; see the AC-1 graph on page 22 for further information.
- ▼ Use voltage codes on page 115 "Voltage Code Table" to complete catalog number.
- Devices are UL Listed at the same ratings as 32 and 80 amp devices, respectively.

AC and DC Control Circuit — Contactors for Connection with Slip-on Connectors (3-pole only) AC-1 category

For contactors **LC1D09** and **LC1D12** only, replace the last digit in the catalog numbers shown in the table above ("6") with a 9. For example, **LC1D096●●** becomes **LC1D099●●**. These contactors include slip-on connectors: UL Recognized **E164862 NLDX2**, 2 x 6.35 mm (0.25 in.) on the power poles and 1 x 6.35 mm (0.25 in.) on the coil terminals.

TeSys™ D-Line Contactors and Starters

Selection of Reversing Contactors for Motor Control



The tables below show the kilowatt ratings (for international applications) and horsepower ratings (for North American applications) of contactors for motor control.

The contactors are pre-assembled, horizontally-mounted, and have pre-wired power connections. Order accessories separately. For information on auxiliary contact blocks and modules, see pages 106 to 107.

AC and DC Control Circuit — 3-pole Reversing Contactors with Touch-safe Terminals for Power Cabling (AC-3 category)

Maximum horsepower ratings						Maximum Inductive Current in AC-3 Category 600 V	Standard power ratings of 3-phase motors 50/60 Hz in category AC-3							Rated Operating Current in AC-3 up to 440 V	Instantaneous Auxiliary Contacts		Catalog Number ◆▼	Weight lb (kg)
1-phase 50/60 Hz		3-phase 50/60 Hz					220 V 230 V	380 V 400 V	415 V	440 V	500 V	660 V 690 V	1000 V		N.O.	N.C.		
HP	HP	HP	HP	HP	HP	A	kW	kW	kW	kW	kW	kW	A					
0.5	1	2	2	5	7.5	9	2.2	4	4	4	5.5	5.5	–	9	1	1	LC2D09●●▲●	1.55 (0.700)
1	2	3	3	7.5	10	12	3	5.5	5.5	5.5	7.5	7.5	–	12	1	1	LC2D12●●▲●	1.55 (0.700)
1	3	5	5	10	15	18	4	7.5	9	9	10	10	–	18	1	1	LC2D18●●▲●	1.670 (0.75)
2	3	7.5	7.5	15	20	25	5.5	11	11	11	15	15	–	25	1	1	LC2D25●●▲●	2.44 (1.100)
2	5	10	10	20	30	32	7.5	15	15	15	18.5	18.5	–	32	1	1	LC2D32●●▲●	2.67 (1.200)
Not for North American applications						38	9	18.5	18.5	18.5	18.5	18.5	–	38	1	1	LC2D38●●▲●▶	2.67 (1.200)
3	5	10	10	30	30	40	11	18.5	22	22	22	30	–	40	1	1	LC2D40●●▲	5.33 (2.400)
3	7.5	15	15	40	40	50	15	22	25	30	30	33	–	50	1	1	LC2D50●●▲	5.33 (2.400)
5	10	20	20	50	50	65	18.5	30	37	37	37	37	–	65	1	1	LC2D65●●▲	5.33 (2.400)
7.5	15	25	30	60	60	80	22	37	45	45	55	45	–	80	1	1	LC2D80●●▲	7.11 (3.200)
Not for North American applications						95	25	45	45	45	55	45	–	95	1	1	LC2D95●●▲▶	7.11 (3.200)
–	–	30	40	75	100	115	30	55	59	59	75	80	75	115	1	1	LC2D115■	14.44 (6.500)
–	–	40	50	100	125	150	40	75	80	80	90	100	90	150	1	1	LC2D150■	14.44 (6.500)

- ◆ For LC2D09 to LC2D38: clip-on mounting on 35 mm DIN rail AM1DP or screw mounting.
- ▼ For LC2D40 to LC2D95: clip-on mounting on 35 mm DIN rail AM1DE or 75 mm DIN rail AM1DL or screw mounting.
- ▶ For LC2D115 and LC2D150: clip-on mounting on 2 x 35 mm DIN rails AM1DP or screw mounting.
- ▲ Includes mechanical interlock without electrical contacts. Installer to complete wiring for electrically interlocking contactor operating coils by utilizing a N.C. auxiliary contact integrated in the contactor or optional LADN or LAD8N type auxiliary contact block.
- Included with electrical contacts integrated in mechanical interlock (type LA9D●●02).
- ▼ Use voltage codes on page 115 "Voltage Code Table" to complete catalog number.
- For reversing contactors with electrical interlocking pre-wired at the factory, add suffix V to the catalog number reflected above. Example: LC2D09●● becomes LC2D09●●V.
- ▶ Devices are UL Listed at the same HP ratings as 32 and 80 amp devices, respectively.

TeSys™ D-Line Contactors and Starters

Selection of Reversing Contactors for Motor Control



The tables below show the kilowatt ratings (for international applications) and horsepower ratings (for North American applications) of contactors for motor control.

The contactors are pre-assembled, horizontally-mounted, and have pre-wired power connections. Order accessories separately. For information on auxiliary contact blocks and modules, see pages 106 to 107.

AC and DC Control Circuit — 3-pole Reversing Contactors for Spring Terminal Connections (AC-3 category)

Maximum horsepower ratings						Maximum Inductive Current in AC-3 Category 600 V	Standard power ratings of 3-phase motors 50/60 Hz in category AC-3								Rated Operating Current in AC-3 up to 440 V	Instantaneous Auxiliary Contacts		Catalog Number ♦ ▼ *	Weight lb (kg)
1-phase 50/60 Hz		3-phase 50/60 Hz					220 V 230 V	380 V 400 V	415 V	440 V	500 V	660 V 690 V	1000 V	N.O.		N.C.			
115/120 V	230/240 V	200/208 V	220/240 V	460/480 V	575 V 600 V	A	kW	kW	kW	kW	kW	kW	kW	A					
0.5	1	2	2	5	7.5	9	2.2	4	4	4	5.5	5.5	–	9	1	1	LC2D093** ▲	1.55 (0.700)	
1	2	3	3	7.5	10	12	3	5.5	5.5	5.5	7.5	7.5	–	12	1	1	LC2D123** ▲	1.55 (0.700)	
1	3	5	5	10	15	18	4	7.5	9	9	10	10	–	18	1	1	LC2D183** ▲	1.670 (0.75)	
2	3	7.5	7.5	15	20	25	5.5	11	11	11	15	15	–	25	1	1	LC2D253** ▲	2.44 (1.100)	
2	5	10	10	20	30	32	7.5	15	15	15	18.5	18.5	–	32	1	1	LC2D323** ▲	2.67 (1.200)	
Not for North American applications						38	9	18.5	18.5	18.5	18.5	18.5	–	38	1	1	LC2D383** ▲ ●	2.67 (1.200)	

- ♦ For LC2D09 to LC2D38: clip-on mounting on 35 mm DIN rail AM1DP or screw mounting.
- ▲ Includes mechanical interlock without electrical contacts. Installer to complete wiring for electrically interlocking contactor operating coils by utilizing a N.C. auxiliary contact integrated in the contactor or optional LADN or LAD8N type auxiliary contact block.
- ▼ Use voltage codes on page 115 "Voltage Code Table" to complete catalog number.
- * For reversing contactors with electrical interlocking pre-wired at the factory, add suffix V to the catalog number reflected above. Example: LC2D09** becomes LC2D09**V.
- LC2D38 is UL Listed at the same HP rating as the 32 amp device.

TeSys™ D-Line Contactors and Starters Selection of Reversing Contactors for Motor Control



LC2D186••

The tables below show the kilowatt ratings (for international applications) and horsepower ratings (for North American applications) of contactors for motor control.

The contactors have pre-wired power connections. Order accessories separately. For information on auxiliary contact blocks and modules, see pages 106 to 107.

AC and DC Control Circuit — 3-pole Reversing Contactors for Ring-tongue Terminals or Bus Bar Power Connections (AC-3 category)

Maximum horsepower ratings							Maximum Inductive Current in AC-3 Category 600 V	Standard power ratings of 3-phase motors 50/60 Hz in category AC-3								Rated Operating Current in AC-3 up to 440 V	Instantaneous Auxiliary Contacts		Catalog Number ◆▼	Weight
1-phase 50/60 Hz		3-phase 50/60 Hz						Standard power ratings of 3-phase motors 50/60 Hz in category AC-3									Instantaneous Auxiliary Contacts			
115/120 V	230/240 V	200/208 V	220/240 V	460/480 V	575 V 600 V	A	220 V 230 V	380 V 400 V	415 V	440 V	500 V	660 V 690 V	1000 V	A	N.O.	N.C.		lb (kg)		
0.5	1	2	2	5	7.5	9	2.2	4	4	4	5.5	5.5	—	9	1	1	LC2D096••▲	1.55 (0.700)		
1	2	3	3	7.5	10	12	3	5.5	5.5	5.5	7.5	7.5	—	12	1	1	LC2D126••▲	1.55 (0.700)		
1	3	5	5	10	15	18	4	7.5	9	9	10	10	—	18	1	1	LC2D186••▲	1.67 (0.750)		
2	3	7.5	7.5	15	20	25	5.5	11	11	11	15	15	—	25	1	1	LC2D256••▲	2.44 (1.100)		
2	5	10	10	20	30	32	7.5	15	15	15	18.5	18.5	—	32	1	1	LC2D326••▲	2.67 (1.200)		
Not for North American applications						38	9	18.5	18.5	18.5	18.5	18.5	—	38	1	1	LC2D386••▲●	2.67 (1.200)		
—	—	30	40	75	100	115	30	55	59	59	75	80	75	115	1	1	LC2D1156••■▲	13.22 (5.950)		
—	—	15	15	40	40	150	40	70	80	80	90	100	90	150	1	1	LC2D1506••■▲	13.22 (5.950)		

- ◆ For **LC2D09** to **LC2D38**: clip-on mounting on 35 mm DIN rail **AM1DP** or screw mounting.
For **LC2D115** and **LC2D150**: clip-on mounting on 2 x 35 mm DIN rails **AM1DP** or screw mounting.
- ▲ Includes mechanical interlock without electrical contacts. Installer to complete wiring for electronically interlocking contactor operating coils by utilizing a N.C. auxiliary contact integrated in the contactor or optional **LADN** or **LAD8N** type auxiliary contact block.
- Included with electrical contacts integrated in mechanical interlock (type **LA9D••02**).
- ▼ Use voltage codes on page 115 "Voltage Code Table" to complete catalog number.
- LC2D386 devices are UL Listed at the same HP rating as the 32 amp device.

AC and DC Control Circuit — 3-pole Reversing Contactors for Connection with Slip-on Connectors (AC-3 category)

For contactors **LC2D09** and **LC2D12** only, replace the last digit in the catalog numbers shown in the table above ("6") with a 9. For example, **LC2D096••** becomes **LC2D099••**. These contactors include slip-on connectors: UL Recognized **E164862 NLDX2**, 2 x 6.35 mm (0.25 in.) on the power poles and 1 x 6.35 mm (0.25 in.) on the coil terminals.

Power connections are to be made by the customer.

TeSys™ D-Line Contactors and Starters

Selection of Changeover Contactors for Resistive Loads (AC-1) and Inductive Loads (AC-3)



LC2DT20**

The contactors have pre-wired power connections. Order accessories separately. For information on auxiliary contact blocks and modules, see pages 106 to 107.

AC and DC Control Circuit — 4-pole Changeover Contactors with Touch-safe Terminals for Power Cabling (AC-1 category)

Maximum Current Utilization Categories		Instantaneous Auxiliary Contacts 		Catalog Number ◆ ▼	Weight
AC-1	AC-3	N.O.	N.C.		lb (kg)
20	9	1	1	LC2DT20** ▲	1.60 (0.730)
25	12	1	1	LC2DT25** ▲	1.55 (0.700)
32	18	1	1	LC2DT32** ▲	1.86 (0.450)
40	25	1	1	LC2DT40** ▲	2.43 (1.100)
60	40	1	1	LC2D40004** ▲	5.30 (2.400)
		1	1	LP2D40004** ▲	5.30 (2.400)
80	65	–	–	LC2D65004** ▲	7.07 (3.200)
		–	–	LP2D80004** ▲	7.07 (3.200)
125	80	–	–	LC2D80004** ▲	7.07 (3.200)
		–	–	LP2D80004** ▲	7.07 (3.200)
200	115	–	–	LC2D115004** ■	16.0 (27.250)

◆ For LC2D12 and LC2D25: clip-on mounting on 35 mm DIN rail AM1DP or screw mounting.

For LC2D40 to LC2D95: clip-on mounting on 35 mm DIN rail AM1DE or 75 mm DIN rail AM1DL or screw mounting.

For LC2D115: clip-on mounting on 2 x 35 mm DIN rails AM1DP or screw mounting.

▲ Includes mechanical interlock (type LA9**D978) without electrical contacts. Installer to complete wiring for electronically interlocking contactor operating coils by utilizing a N.C. auxiliary contact integrated in the contactor or optional LA1DN or LA8DN type auxiliary contact block.

■ Includes mechanical interlock (Type LA9D11502) with pre-wired electrical contacts for interlocking contactor operating coils.

▼ Use voltage codes on page 115 "Voltage Code Table" to complete catalog number.

Selection of Changeover Contactors for Resistive Loads (AC-1) and Inductive Loads (AC-3)

AC and DC Control Circuit— 4-pole
Changeover Contactors with Ring-tongue Terminal or Bus Bar Power Connection
(AC-1 category)

Maximum Current Utilization Categories		Instantaneous Auxiliary Contacts 		Catalog Number ◆ ▼	Weight lb (kg)
AC-1	AC-3	N.O.	N.C.		
20	9	1	1	LC2DT206** ▲	1.60 (0.730)
25	12	1	1	LC2DT256** ▲	1.55 (0.700)
32	18	1	1	LC2DT326** ▲	1.86 (0.450)
40	25	1	1	LC2DT406** ▲	2.43 (1.100)
60	40	1	1	LC2D400046** ▲	5.30 (2.400)
		1	1	LP2D400046** ▲	5.30 (2.400)
80	65	–	–	LC2D650046** ▲	7.07 (3.200)
		–	–	LP2D800046** ▲	7.07 (3.200)
125	80	–	–	LC2D800046** ▲	7.07 (3.200)
		–	–	LP2D800046** ▲	7.07 (3.200)
200	115	–	–	LC2D1150046** ■	16.0 (27.250)

- ◆ For LC2D12 and LC2D25: clip-on mounting on 35 mm DIN rail AM1DP or screw mounting.
For LC2D40 to LC2D95: clip-on mounting on 35 mm DIN rail AM1DE or 75 mm DIN rail AM1DL or screw mounting.
For LC2D115: clip-on mounting on 2 x 35 mm DIN rails AM1DP or screw mounting.
- ▲ Includes mechanical interlock (Type LA9**D978) without electrical contacts. Installer to complete wiring for electronically interlocking contactor operating coils by utilizing a N.C. auxiliary contact integrated in the contactor or optional LA1DN or LA8DN type auxiliary contact block.
- Includes mechanical interlock (Type LA9D11502) with pre-wired electrical contacts for interlocking contactor operating coils.
- ▼ Use voltage codes on page 115 "Voltage Code Table" to complete catalog number.

TeSys™ D-Line Contactors and Starters

Component Parts for Reversing and Two Speed Contactors

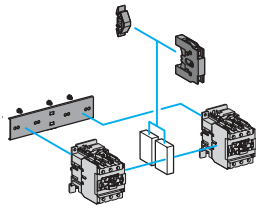

LA9D4002

For 3-pole Motor Reversing Contactors

Contactors with Screw Clamp Terminals or Connectors Horizontally Mounted, Assembled by Customer

Using 2 Identical Contactors (1)	Set of Power Connections		Mechanical Interlock Kit	
	Catalog Number	Weight lb (kg)	Catalog Number	Weight lb (kg)

Including mechanical interlock and an electrical interlocking kit for the contactors

Power Connections for LC1D09 to D38

Use with screw terminal versions LC1D09 - LC1D38

Line Side (Parallel) Connector	LAD9V5	0.037 (0.17)	LAD9R1V (2)	–
Load Side (Reversing) Connector	LAD9V6	0.037 (0.17)	LAD9R1V (2)	–
Low Voltage Control Circuit Interlock	LAD9V1 (3)	0.037 (0.17)	LAD9R1V (2)	–

Use with spring terminal versions LC1D093 - LC1D383

When using Quick-Fit LAD34 and LAD33 Power Connectors

Line Side (Parallel) Connector	LAD9V10	0.037 (0.17)	LAD9V2	–
Load Side (Reversing) Connector	LAD9V11	0.037 (0.17)	LAD9V2	–

When using standard cable/wire

Line Side (Parallel) Connector	LAD9V12	0.037 (0.17)	LAD9V2	–
Load Side (Reversing) Connector	LAD9V13	0.037 (0.17)	LAD9V2	–

Including mechanical interlock with integral electrical interlocking

LC1D40 to D65	LA9D6569	0.290 (0.64)	LA9D4002	0.37 (0.170)
LC1D80 and D95 (ac)	LA9D8069	0.290 (0.64)	LA9D4002	0.37 (0.170)
LC1D80 and D95 (dc)	LA9D8069	0.490 (1.08)	LA9D8002	0.37 (0.170)
LC1D115 and D150	LA9D11569	1.450 (3.20)	LA9D11502	0.63 (0.290)

Including mechanical interlock without electrical interlocking

Power Connections for LC1D09 to D38

Line Side (Parallel) Connector	LAD9V5	0.045 (0.10)	LAD9R1 (2)	–
Load Side (Reversing) Connector	LAD9V6	0.045 (0.10)	LAD9R1 (2)	–
LC1D40 to D65	LA9D6569	0.290 (0.64)	LA9D50978	0.37 (0.170)
LC1D80 and D95 (ac)	LA9D8069	0.490 (1.08)	LA9D50978	0.37 (0.170)
LC1D80 and D95 (dc)	LA9D8069	0.490 (1.08)	LA9D80978	0.37 (0.170)

For Low Speed – High Speed Starter

Description	For Contactors with Connections	Catalog Number	Weight lb (kg)
Connection kit enabling reversing of slow and high speed directions, using a reversing contactor and a 2 N.O. + 2 N.C. main pole contactor	Screw clamps or connectors	LA9D9PVG V	0.03 (0.016)
	Spring terminals	LAD3PVP G	0.15 (0.068)

(1) To order the 2 contactors: see pages 88, 89 and 90.

(2) Mechanical interlock kit includes line and load side power connectors, mechanical interlock, control circuit interlock (LAD9R1V only), and clip. Interlock only -- LAD9V2 (includes retaining clip). Retaining clip only -- W116430980111 (std. package of 10).

(3) There is no spring terminal equivalent for this part.

(4) Line side (parallel) connector: LAD9V5; load side (reversing) connector: LAD9V6.

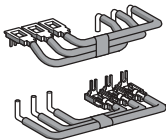

LA9D6569

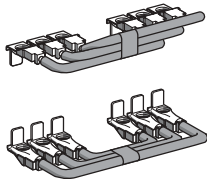

LA9D8069

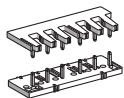
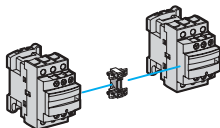

LAD9R1

Characteristics: pages 80 to 87 Dimensions, Schematics: pages 128, 129

TeSys™ D-Line Contactors and Starters

Component Parts for Assembling Changeover Contactor Parts for Distribution

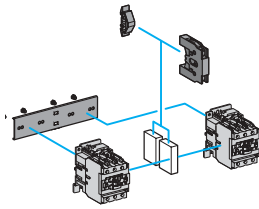

LA9D4002

For 4-pole Changeover Contactor Pairs (3-phase distribution + neutral)

Contactors with Screw Clamp Terminals or Connectors
Horizontally Mounted, Assembled by Customer

Using 2 Identical Contactors (1)	Set of Power Connections		Mechanical Interlock	
	Catalog Number	Weight lb (kg)	Catalog Number of Kit	Weight lb (kg)

Including mechanical interlock and an electrical interlocking kit for the contactors

LC1DT20 to DT40	LADT9R1V (2)	0.088 (0.040)	–	–
-----------------	--------------	---------------	---	---

Including mechanical interlock with integral electrical interlocking

LC1D65004	LA9D6570	0.33 (0.150)	LA9D4002	0.37 (0.170)
LC1D80004	LA9D8070	0.62 (0.280)	LA9D4002	0.37 (0.170)
LP1D80004	LA9D8070	0.62 (0.280)	LA9D8002	0.37 (0.170)
LC1D115004	LA9D11570	2.43 (1.100)	LA9D11502	0.62 (0.280)

Including mechanical interlock without electrical interlocking

LC1DT20 to DT40 With screw clamp terminals or connectors	LADT9R1 (2)	0.08 (0.035)	–	–
LC1DT203 to DT403 With spring terminal connections	(4)	–	–	–
LC1 or LP1D65004	LA9D6570 (3)	0.33 (0.150)	LA9D50978	0.34 (0.155)
LC1D80004	LA9D8070 (3)	0.62 (0.280)	LA9D50978	0.34 (0.155)
LP1D80004	LA9D8070 (3)	0.62 (0.280)	LA9D80978	0.40 (0.180)

For 3-pole changeover contactor pairs

Including mechanical interlock with integral electrical interlocking

LC1D115 and D150	LA9D11571	2.12 (0.960)	LA9D11502	0.62 (0.280)
------------------	-----------	--------------	-----------	--------------

(1) To order the two contactors: see page 91.

(2) Including mechanical interlock.

(3) Order two contact blocks LADN•1 to obtain electrical interlocking between the contactors, see page 106.

(4) To build a reversing contactor with spring terminal connections, the following components must be ordered in addition to the two contactors:
- 1 mechanical interlock LAD9V2,
- 1 downstream power connection kit LAD9V9

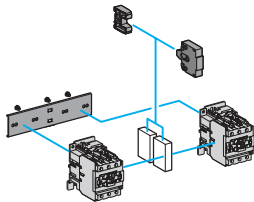

LA9D50978

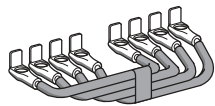

LA9D8070

TeSys™ D-Line Contactors and Starters

Characteristics of Auxiliary Contacts, Timers, and Accessories

Auxiliary Contact Blocks without Dust and Damp Protected Contacts for Contactors

Environment

Contact block type			LADN or C	LADT and S	LADR	LAD8
Conforming to standards	CE Meets the essential requirements of the LV & EMC directives		IEC 60947-5-1, NF C 63-140, VDE 0660, BS 4794, EN 60947-5-1			
Product certifications			UL, CSA			
Protective treatment	Conforming to IEC 60068		"TH"			
Degree of protection	Conforming to VDE 0106		Protection against direct finger contact IP 2X			
Ambient air temperature around the device	Storage	°C	- 60 to + 80 (- 140 to + 176 °F)			
	Operation	°C	- 5 to + 60 (- 41 to + 140 °F)			
	Permissible for operation at U _c	°C	- 40 to + 70 (- 104 to + 158 °F)			
Maximum operating altitude	Without derating	m	3000			
Cabling	Phillips N° 2 and Ø 6 mm Flexible or solid cable with or without cable end	mm ²	Min.: 1 x 1; max.: 2 x 2.5 (#10 AWG)			
Connection by spring terminals	Flexible or solid cable without cable end	mm ²	Max.: 2 x 2.5 (#10 AWG)			

Instantaneous and Time Delay Contact Characteristics

Number of contacts			1, 2 or 4	2	2	2
Rated operational voltage (U _e)	Up to	V	690			
Rated insulation voltage (U _i)	Conforming to IEC 60947-5-1	V	690			
	Conforming to UL, CSA	V	600			
Conventional thermal current (I _{th})	For ambient temperature ≤ 60 °C (140 °F)	A	10			
Frequency of operational current		Hz	25 to 400			
Minimum switching capacity	U min.	V	17			
	I min.	mA	5			
Short-circuit protection ●	Conforming to IEC 60947-5-1 and VDE 0660. gG fuse	A	10			
Rated making capacity	Conforming to IEC 60947-5-1, I rms	A	ac: 140; dc: 250			
Short-time rating	Permissible for:	1 s	A	100		
		500 ms	A	120		
		100 ms	A	140		
Insulation resistance		MΩ	> 10			
Non-overlap time	Guaranteed between N.C. and N.O. contacts	ms	1.5 (on energizing and on de-energizing)			
Overlap time	Guaranteed between N.C. and N.O. on LADC22	ms	1.5	–	–	–
Time delay (LADT, R and S contact blocks) Accuracy only valid for setting range indicated on the front face	Ambient air temperature for operation	°C	–	- 40 to + 70 (- 104 to + 158 °F)	- 40 to + 70 (- 104 to + 158 °F)	–
	Repeat accuracy		–	± 2%	± 2%	–
	Drift up to 0.5 million operating cycles		–	+ 15%	+ 15%	–
	Drift depending on ambient air temperature		–	0.25% per °C	0.25% per °C	–
Mechanical durability	In millions of operating cycles		30	5	5	30
Operational power of contacts			See page 101.			

- Select short circuit protection to meet the National Electrical Code or other local codes and standards.

Catalog Number: pages 107, 108

Dimensions: pages 122, 123

Schematics: pages 126, 127

TeSys™ D-Line Contactors and Starters

Characteristics of Auxiliary Contacts, Timers, and Accessories

Auxiliary Contact Blocks with Dust and Damp Protected Contacts for Contactors

Operational Power of Contacts (conforming to IEC 60947-5-1)

AC supply, categories AC-14 and AC-15

Electrical durability (valid up to 3600 operating cycles/hour) on an inductive load such as the coil of an electromagnet: making power ($\cos \varphi 0.7$) = 10 times the power broken ($\cos \varphi 0.4$)

	V	24	48	115	230	400	440	600
1 million operating cycles	VA	60	120	280	560	960	1050	1440
3 million operating cycles	VA	16	32	80	160	280	300	420
10 million operating cycles	VA	4	8	20	40	70	80	100

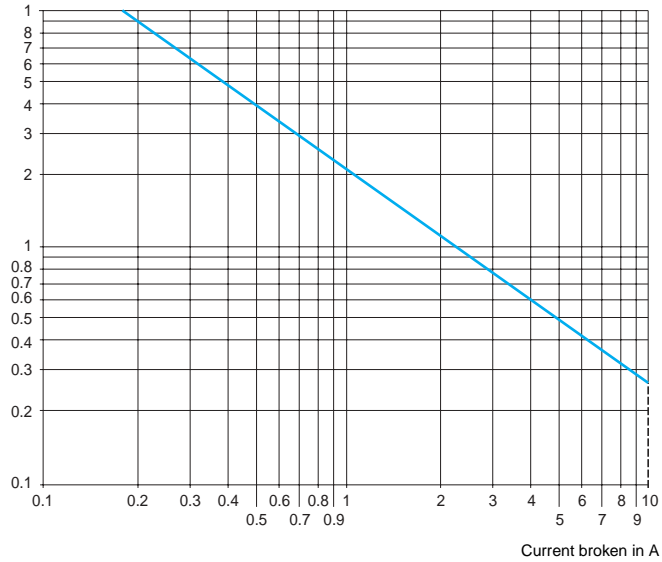

DC supply, category DC-13

Electrical durability (valid up to 1200 operating cycles/hour) on an inductive load such as the coil of an electromagnet, without economy resistor, the time constant increasing with the power.

	V	24	48	125	250	440
1 million operating cycles	W	120	90	75	68	61
3 million operating cycles	W	70	50	38	33	28
10 million operating cycles	W	25	18	14	12	10

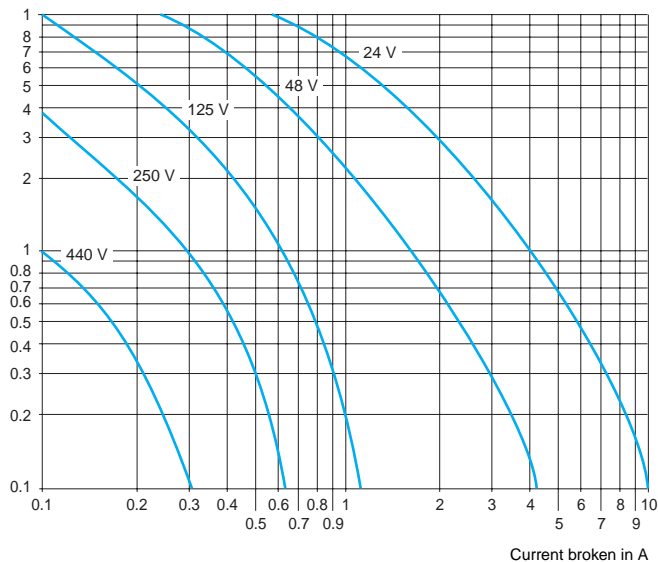

Catalog Number: pages 107, 108

Dimensions: pages 122, 123



Schematics: pages 126, 127

TeSys™ D-Line Contactors and Starters

Characteristics of Auxiliary Contacts, Timers, and Accessories

Auxiliary Contact Blocks with Dust and Damp Protected Contacts for Contactors

Environment

Contact block type			LA1DX	LA1DZ		LA1DY
				protected	non protected	
Conforming to standards	 Meets the essential requirements of the LV & EMC directives		IEC 60947-5-1, VDE 0660			
Product certifications	 		UL, CSA			
Protective treatment	Conforming to IEC 60068		"TH"			
Degree of protection	Conforming to VDE 0106		Protection against direct finger contact IP 2X			
Ambient air temperature	Storage and operation	°C	- 25 to + 70 (- 77 to + 158 °F)			
Cabling	Phillips N° 2 and Ø 6 mm Flexible or solid cable with or without cable end	mm ²	Min.: 1 x 1 Max.: 2 x 2.5			
Number of contacts			2	2	2	2

Contact Characteristics

Rated operational voltage (Ue)	Up to	V	50	50	690	24	
Rated insulation voltage (Ui)	Conforming to IEC 60947-5-1	V	250	250	690	250	
	Conforming to UL, CSA	V	–	–	600	–	
Conventional thermal current (Ith)	For ambient temperature ≤ 40 °C (104 °F)	A	–	–	10	–	
Maximum operational current (Ie)		mA	50	50	10	50	
Frequency of operational current		Hz	–	–	25 to 400	–	
Minimum switching capacity	U min.	V	3	3	17	3	
	I min.	mA	0.3	0.3	5	0.3	
Short-circuit protection ●	Conforming to IEC 60947-5-1, gG fuse	A	–	–	10	–	
Rated making capacity	Conforming to IEC 60947-5-1, I rms	A	–	–	ac: 140; dc: 250	–	
Short-time rating	Permissible for:	1 s	A	–	–	100	–
		500 ms	A	–	–	120	–
		100 ms	A	–	–	140	–
Insulation resistance		MΩ	> 10	> 10	> 10	> 10	
Mechanical durability	In millions of operating cycles		5	5	30	5	
Materials and technology used for dust and damp protected contacts			Gold - Single break with crossed bars	Gold - Single break with crossed bars	–	Gold - Single break with crossed bars	

- Select short circuit protection to meet the National Electrical Code or other local codes and standards.

Catalog Number: pages 107, 108

Dimensions: pages 122, 123



Schematics: pages 126, 127

TeSys™ D-Line Contactors and Starters

Characteristics of Auxiliary Contacts, Timers, and Accessories

Interface Modules for Contactors

Environment

Conforming to standards	 Meets the essential requirements of the LV & EMC directives		IEC 60255-5
Product certifications	 		UL, CSA
Protective treatment	Conforming to IEC 60068		"TH"
Degree of protection	Conforming to VDE 0106		Protection against direct finger contact IP 2X
Ambient air temperature around the device	Storage	°C	- 40 to + 80 (- 104 to + 176 °F)
	Operation	°C	- 25 to + 55 (- 77 to + 131 °F)
	Permissible for operation at Uc	°C	- 25 to + 70 (- 77 to + 158 °F)

Other Characteristics

Module type			LA4DFBQ	LA4DFB	LA4DFE	LA4DLB	LA4DLE	LA4DWB	
			With relay	With relay	With relay	With relay + override	Solid state		
Rated insulation voltage	Conforming to IEC 60947-1		V	5	250				
Rated operational voltage	Conforming to IEC 60947-1		V	415	250				
Indication of input state	By integral LED which illuminates when the contactor coil is energized								
Input signals	Control voltage (E1-E2)		V	dc 24	dc 24	dc 48	dc 24	dc 48	dc 24
	Permissible variation		V	17 to 30	17 to 30	33 to 60	17 to 30	33 to 60	5 to 30
	Current consumption at 20 °C (68 °F)		mA	25	25	15	25	15	8.5 for 5 V 15 for 24 V
	State "0" guaranteed for	U	V	< 2.4	< 2.4	< 4.8	< 2.4	< 4.8	< 2.4
		I	mA	< 2	< 2	< 1.3	< 2	< 1.3	< 2
State "1" guaranteed for	U	V	17	17	33	17	33	5	
Built-in protection	Against reverse polarity			By diode					
	Of the input			By diode					
Electrical durability at 220/240 V	In millions of operating cycles			3	10	10	3	3	20
Maximum immunity time to micro-breaks			ms	4	4	4	4	4	1
Power dissipated	At 20 °C (68 °F)		W	0.6	0.6	0.6	0.6	0.6	0.4
Direct mounting without contactor	With coil:	ac 24 to 250 V		–	LC1D40 to D150				–
		ac 100 to 250 V		–	–				LC1D40 to D115
		ac 380 to 415 V		LC1D40 to D150	–				–
Mounting with cabling adaptor LAD-4BB	With coil:	ac 24 to 250 V		–	LC1D09 to D38, DT20 to DT60				LC1D09 to D38, DT20 to DT60
		ac 380 to 415 V		LC1D09 to D38, DT20 to DT40	–				–
Total operating time at Uc (of the contactor)	Operating times depend on the type of contactor electromagnet and its control mode. The closing time "C" is measured from the moment the coil supply is switched on to initial contact of the main poles. The opening time "O" is measured from the moment the coil supply is switched off to the moment the main poles separate.								
				LC1D09 to D38, DT20 to DT60		LC1D40 to D65		LC1D80 and D95	
	With LA4DF, DL	N.O.	ms	20 to 30			28 to 34		28 to 43
N.C.		ms	16 to 24			20 to 24		18 to 32	
Cabling	Phillips N° 2 and Ø 6 mm Flexible or solid cable with or without cable end		mm ²	Min.: 1 x 1 (#12 AWG)					
			mm ²	Min.: 2 x 2.5 (#12 AWG)					

Catalog Number: page 111

Dimensions: pages 122, 123

Schematics: pages 126, 127

TeSys™ D-Line Contactors and Starters

Characteristics of Auxiliary Contacts, Timers, and Accessories

Electronic Serial Timer Modules for Contactors

Environment

Module type			LA4DT (On-delay)
Conforming to standards	CE	Meets the essential requirements of the LV & EMC directives	IEC 60255-5
Product certifications			UL, CSA
Protective treatment	Conforming to IEC 60068		"TH"
Degree of protection	Conforming to VDE 0106		Protection against direct finger contact IP 2X
Ambient air temperature around the device	Storage	°C	- 40 to + 80 (- 104 to + 176 °F)
	Operation	°C	- 25 to + 55 (- 77 to + 131 °F)
	For operation at U _c	°C	- 25 to + 70 (- 77 to + 158 °F)
Rated insulation voltage (U _i)	Conforming to IEC 60947-1	V	250
Cabling	Phillips N° 2 and Ø 6 mm Flexible or solid cable with or without cable end	mm ²	Min.: 1 x 1 Max.: 2 x 2.5

Control Circuit Characteristics

Built-in protection	On input		By varistor
	Suppression of contactor		By varistor
Rated control circuit voltage (U _c)		V	ac or dc 24 to 250
Permissible variation			0.8 to 1.1 U _c
Type of control			By mechanical contact only

Time Delay Characteristics

Timing ranges		s	0.1 to 2; 1.5 to 30; 25 to 500
Repeat accuracy	0 to 40 °C (104 °F)		± 3% (10 ms minimum)
Reset time	During the time delay period	ms	150
	After the time delay period	ms	50
Immunity to micro-breaks	During the time delay period	ms	10
	After the time delay period	ms	2
Indication of time delay	By LED		Illuminates during time delay period

Switching Characteristics (solid state type)

Maximum power dissipated		W	2
Leakage current		mA	< 5
Residual voltage		V	3.3
Overvoltage protection			3 kV; 0.5 N·m
Electrical durability	In millions of operating cycles		30

Operating Diagrams

LA4DT "On-delay" electronic timers

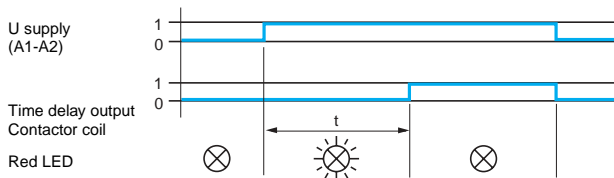

Catalog Number: page 111

Dimensions: pages 122, 123

Schematics: pages 126, 127

TeSys™ D-Line Contactors and Starters

Characteristics of Auxiliary Contacts, Timers, and Accessories

Control Modules, Coil Suppressor Modules and Mechanical Latch Blocks for Contactors

Environment

Conforming to standards			IEC 60947-5-1
Product certifications			UL, CSA
Protective treatment	Conforming to IEC 60068		"TH"
Degree of protection	Conforming to VDE 0106		Protection against direct finger contact IP 2X
Ambient air temperature around the device	Storage	°C	- 40 to + 80 (- 104 to + 176 °F)
	Operation	°C	- 25 to + 55 (- 77 to + 131 °F)
	Permissible for operation at U _c	°C	- 25 to + 70 (- 77 to + 158 °F)

"Auto - Man - Stop" Control Modules

Recommendation	The Auto - Man selector switch must only be operated with the Start - Stop ("O" "I") switch in position "O"		
Rated insulation voltage	Conforming to IEC 60947-5-1	V	250
Rated operational voltage	Conforming to IEC 60947-5-1	V	250
Protection	Against electric shocks	kV	2
Built-in protection	Contactors coil suppression		By varistor
Indication	By integral LED		Illuminates when the contactor coil is energized
Electrical durability	In operating cycles		20,000

Coil Suppressor Modules

Module type			LA4DA LAD4RC	LA4DB LAD4T	LA4DC	LA4DE LAD4V
Type of protection			RC circuit	Bidirectional peak limiting diode	Diode	Varistor
Rated control circuit voltage (U _c)		V	ac 24 to 415	ac or dc 24 to 72	dc 12 to 250	ac or dc 24 to 250
Maximum peak voltage			3 U _c	2 U _c	U _c	2 U _c
Natural RC frequency	24/48 V	Hz	400	-	-	-
	50/127 V	Hz	200			
	110/240 V	Hz	100	-	-	-
	380/415 V	Hz	150	-	-	-

Mechanical Latch Blocks

Mechanical latch block type			LA6DK10	LAD6K10	LA6DK20
For mounting on contactor			LC1D40 to D65, LP1D65	LC1D09 to D38, DT20 to DT60	LC1D80 to D150 LP1D80 and LC1D115
Certification			UL, CSA		UL, CSA
Rated insulation voltage	Conforming to IEC 60947-5-1	V	690		690
Rated control circuit voltage	ac 50/60 Hz and dc	V	24 to 415		24 to 415
Power required	For unlatching	ac	VA	25	
		dc	W	30	
Maximum operating rate	In operating cycles/hour		1200		1200
On-load factor			10%		10%
Mechanical durability at U _c	In millions of operating cycles		0.5		0.5

Catalog Number: pages 108, 110 - 112

Dimensions: pages 122, 123

Schematics: pages 126, 127

TeSys™ D-Line Contactors and Starters

Selection of Auxiliary Contact Blocks

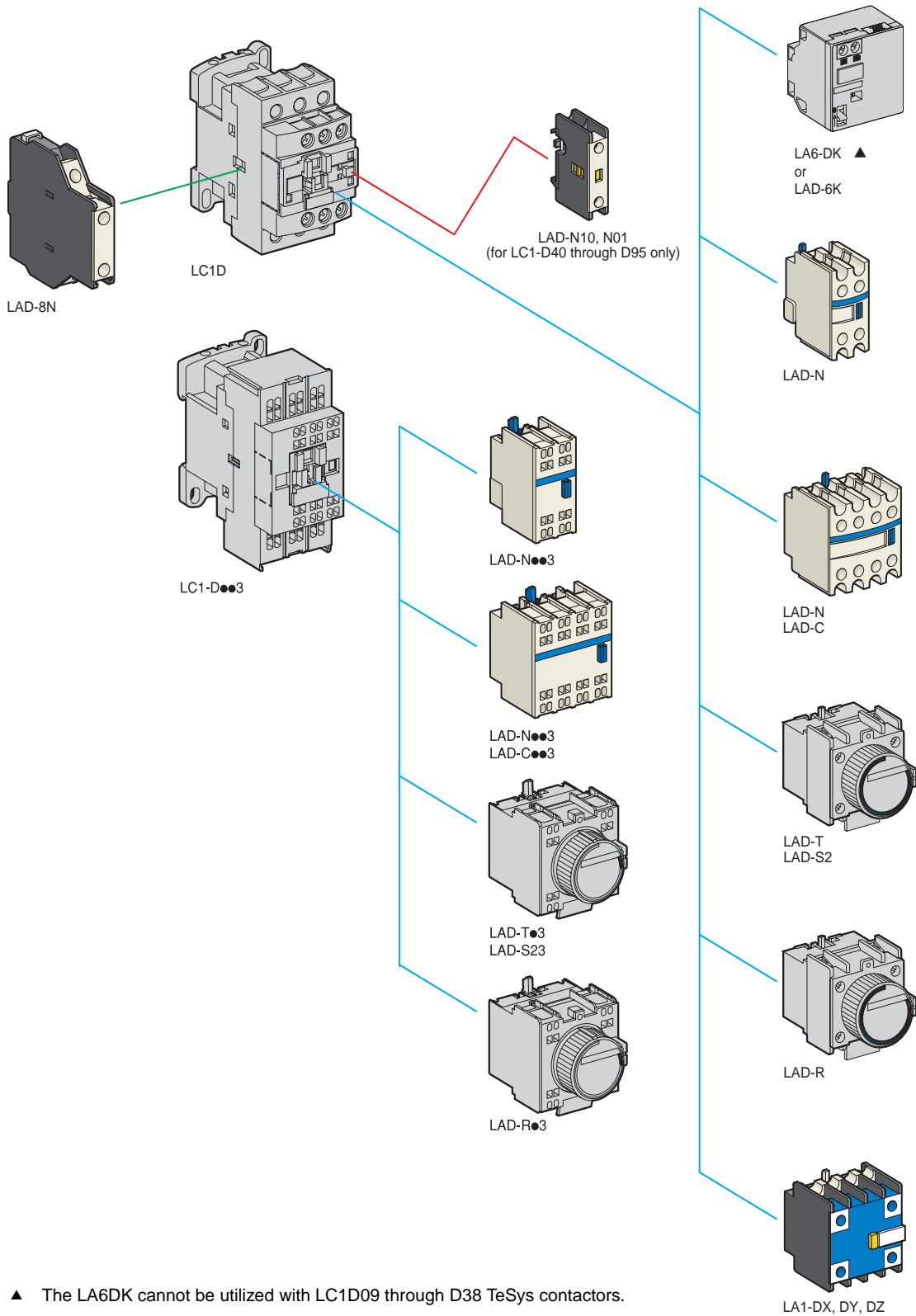





TeSys™ D-Line Contactors and Starters

Selection of Auxiliary Contact Blocks

Instantaneous Auxiliary Contact Blocks for Connection by Screw Clamp Terminals

For use in normal operating environments

Clip-on mounting	Number of contacts per block (see table below for maximum number of contacts)	Composition					Catalog Number	Weight lb (kg)
								
Front	1	-	-	-	1	-	LADN10 ♦	0.04 (0.020)
		-	-	-	-	1	LADN01 ♦	0.04 (0.020)
	2	-	-	-	1	1	LADN11	0.07 (0.030)
		-	-	-	2	-	LADN20	0.07 (0.030)
	4	-	-	-	-	2	LADN02	0.07 (0.030)
		-	-	-	2	2	LADN22	0.11 (0.050)
		-	-	-	1	3	LADN13	0.11 (0.050)
		-	-	-	4	-	LADN40	0.11 (0.050)
		-	-	-	-	4	LADN04	0.11 (0.050)
		-	-	-	3	1	LADN31	0.11 (0.050)
4 includes one N.O. and one N.C. make before break		-	-	-	2	2	LADC22	0.11 (0.050)
Side	2	-	-	-	1	1	LAD8N11 ●	0.07 (0.030)
		-	-	-	2	-	LAD8N20 ●	0.07 (0.030)
		-	-	-	-	2	LAD8N02 ●	0.07 (0.030)

For terminal referencing conforming to standard EN 50012 ◊

Front, on 3P contactors & 4P contactors 20 to 60A	2	-	-	-	1	1	LADN11G	0.07 (0.030)
	4	-	-	-	2	2	LADN22G	0.11 (0.050)
Front, on 4P contactors 80 to 200A	2	-	-	-	1	1	LADN11P	0.07 (0.030)
	4	-	-	-	2	2	LADN22P	0.11 (0.050)

With dust and damp protected terminals, for use in particularly harsh industrial environments

Front	2	-	2	-	-	-	LA1DX20	0.09 (0.040)
		2	-	-	-	-	LA1DX02	0.09 (0.040)
	4	-	2	2	-	-	LA1DY20 ▲	0.09 (0.040)
		-	2	-	2	-	LA1DZ40	0.11 (0.050)
		-	2	-	1	1	LA1DZ31	0.13 (0.060)

♦ For LC1D40 through LC1D95 only.

▲ Device with 4 shield bonding terminals.

● Mount on left side only of LC●D09 through D38 with AC coils. Not allowed on LC●D09 through D38 with DC coils.

◊ See page 126 for actual markings.

Instantaneous auxiliary contact blocks for connection by ring-tongue connectors

This type of connection is not possible for blocks with dust and damp protected contacts. For all other instantaneous auxiliary contact blocks, add the digit **6** to the end of the references selected above. Example: LADN10 becomes LADN106.

Instantaneous auxiliary contact blocks for connection by spring terminals

This type of connection is not possible for LAD8, LADN with 1 contact or blocks with dust and damp protected contacts. For all other contact blocks, add the digit **3** to the end of the references selected above. Example: LADN11 becomes LADN113.

Instantaneous auxiliary contact blocks for connection by Faston connectors

This type of connection is not possible for LAD8, LADN with 1 contact or blocks with dust and damp protected contacts. For all other contact blocks, add the digit **9** to the end of the references selected above. Example: LADN11 becomes LADN119.

Maximum Number of Auxiliary Contacts

Contactors		Instantaneous auxiliary contact blocks					Time delay Front mounted	
Type	Number of poles and size	Side mounted		Front mounted				
				1 contact	2 contacts	4 contacts		
ac	3P	LC1D09 to D38	1 on left-hand side	and	-	1	or 1	or 1
		LC1D40 to D95 (50/60 Hz)	1 on each side	or	2	and 1	or 1	or 1
		LC1D40 to D95 (50 or 60 Hz)	1 on each side	and	2	and 1	or 1	or 1
	4P	LC1D115 and D150	1 on left-hand side	and	-	1	or 1	or 1
		LC1DT20 to DT40	1 on left-hand side	and	-	1	or 1	or 1
		LC1D65 and D80	1 on each side	or	1	or 1	or 1	or 1
dc	3P	LC1D09 to D38	-	-	-	1	or 1	or 1
		LC1D40 to D95	-	-	1	or 1	or 1	or 1
		LC1D115 and D150	1 on left-hand side	and	-	1	or 1	or 1
	4P	LC1DT20 to DT40	1 on left-hand side	or	-	1	or 1	or 1
		LP1D65 and D80	-	-	2	and 1	or 1	or 1
		LC1D115	1 on each side	-	-	and 1	or 1	or 1
LC (1)	3P	LC1D09 to D38	-	-	-	1 (2)	-	-
	4P	LC1DT20 to DT40	1 on left-hand side	and	-	1	or 1	or 1

(1) LC: low consumption.

(2) Except LADN02.

In order to mount on an LAD8N on an LC1D40 to D95, a set of shims must be ordered separately, see page 114.

Characteristics: page 100-102

Dimensions: pages 122, 123

Schematics: pages 126, 127

TeSys™ D-Line Contactors and Starters

Selection of Time-Delay Blocks, and Mechanical-Latch Blocks

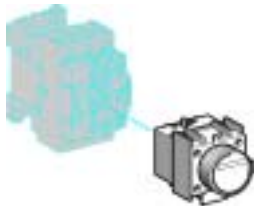

LADT●

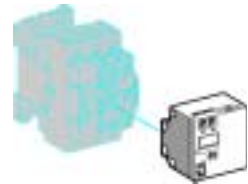

LA6DK●●

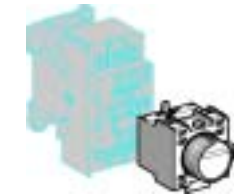

LADT●3

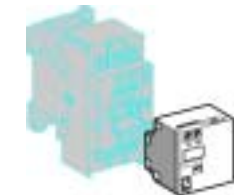

LA6DK●●



LA4SPX ▲

Time Delay Auxiliary Contact Blocks for Connection by Screw Clamp Terminals

Maximum number of auxiliary contact blocks that can be attached per contactor, see page 107.
Sealing cover to be ordered separately, see page 114.
LADT0 and LADR0: with extended scale from 0.1 to 0.6 s.
LADS2: with switching time of 40 ms ± 15 ms between opening of the N.C. contact and closing of the N.O. contact.

Clip-on Mounting	Number of Contacts	Time Delay		Catalog Number	Weight lb (kg)
		Type	Setting Range		
Front	1 N.O. + 1 N.C.	On-delay ♦	0.1 to 3 s	LADT0	(0.13) 0.060
			0.1 to 30 s	LADT2	(0.13) 0.060
			10 to 180 s	LADT4	(0.13) 0.060
			1 to 30 s	LADS2	(0.13) 0.060
		Off-delay ♦	0.1 to 3 s	LADR0	(0.13) 0.060
			0.1 to 30 s	LADR2	(0.13) 0.060
		10 to 180 s	LADR4	(0.13) 0.060	

♦ Also fit pre-TeSys Contactors.

Time delay auxiliary contact blocks for connection by ring-tongue connectors

Add the digit 6 to the end of the references selected above. Example: LADT0 becomes LADT06.

Time delay auxiliary contact blocks for connection by spring terminals

Add the digit 3 to the end of the references selected above. Example: LADT0 becomes LADT03.

Time delay auxiliary contact blocks for connection by Faston connectors

Add the digit 9 to the end of the references selected above. Example: LADT0 becomes LADT09.

Mechanical latch blocks (2)

Clip-on Mounting	Unlatching Control	For use on Contactor	Basic Reference. Complete with Code Indicating Control Voltage	Standard Voltages (1)	Weight lb (kg)
Front	Manual or electric	LC1D40 to D65 3P ac or dc LC1D65 4P ac LP1D65 4P dc	LA6DK10●	B E F M Q	(0.15) 0.070
		LC1D80 to D150 3P ac LC1D80 and D115 3P dc LP1D80 and LC1D115 4P dc	LA6DK20●	B E F M Q	(0.20) 0.090
		LC1D09 to D38 ac or dc LC1DT20 to DT60 ac or dc	LAD6K10●	B E F M Q	(0.15) 0.070

(1) Standard control circuit voltages (for other voltages please consult your Regional Sales Office).

Vdc 50/60 Hz,	24	32/36	42/48	60/72	100	110/127	220/240	256/277	380/415
Code	B	C	E	EN	K	F	M	U	Q

(2) The mechanical latching block must not be powered up at the same time as the contactor. The duration of the control signal for the mechanical latching block and the contactor should be ≥ 100 ms.

Characteristics: pages 100 - 102

Dimensions: pages 122, 123

Schematics: pages 126, 127

SERIPLEX® Module

Approvals	File E114926 CCN NRAQ	LR53531 Class 2252 01		
SERIPLEX	1 block per contactor Clip-on front mounting	Operates coils up to	Catalog Number	Weight – lb (kg.)
Contactor adaptor module ♦	LC1D09 to LC1D80	277 Vac	LA4SPX	0.160 (0.072)
	LP1D09 to LP1D80	24 Vdc		

♦ For more information, refer to SERIPLEX catalog 8330CT9601.

▲ Attaches similarly to all other accessories.

TeSys™ D-Line Contactors and Starters

Selection of Low Voltage Ride Through Module

SEMI F47 Low Voltage Ride Through Module

By ensuring SEMI F47 compliance of AC powered IEC contactors and relays, the Low Voltage Ride Through Modules can be used to increase the voltage sag immunity of semiconductor processing equipment. These modules make it possible for AC powered TELEMECANIQUE contactors and relays to exceed the requirements of SEMI F47, both in the magnitude and duration of a voltage sag event – even with accessories such as auxiliary contact blocks and pneumatic timers.

More and more wafer fabs are insisting that front-end wafer processing equipment comply with SEMI F47. Many of the contactors and pilot relays used on equipment, particularly in the EMO circuit, are not able to meet the standard. As a result, equipment can drop out during a voltage sag of 50% in magnitude and 200ms in duration, causing equipment shutdown.

The Low Voltage Ride Through Modules can be used with TELEMECANIQUE contactors from 9A through 80A, as well as the CAD series of control relays.

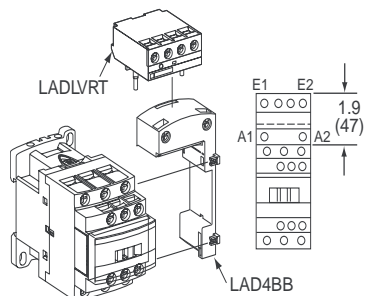

Contactors 32 A and less

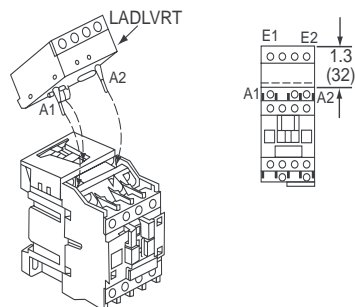

Contactors 40 A - 80 A

Dimensions

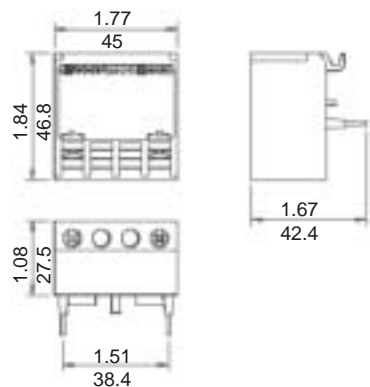

Typical Wiring Scheme for 3-Wire Control

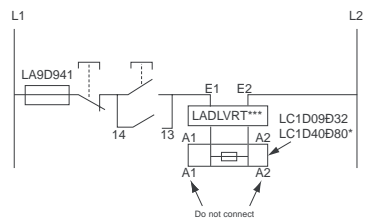

Selection

LADLVRT24V	LADLVRT120V	LADLVRT208V	Bracket	Fuse
For use on LC1: D09B7, D12B7, D18B7, D25B7	For use on LC1: D09G7, D12G7, D18G7, D25G7	For use on LC1: D09LE7, D12LE7, D18LE7, D25LE7	LAD4BB*	LA9D941
D32B7, D40B7, D50B7, D65B7, D80B7	D32G7, D40G7, D50G7, D65G7, D80B7	D32LE7, D40L7, D50L7, D65L7, D80B7	-	
CADxxxB7	CADxxxG7	CADxxxLE7	-	

* The Low Voltage Ride Through Module can be used with all TeSys control relays with 24 VAC, 120 VAC or 208 VAC dual frequency coils.

** LAD4BB must be used when the Low Voltage Ride Through Module is being used with contactors 32 A and less, and TeSys CAD Series of Control Relays.

Specifications

Continuous operating voltage range and line frequency	85–110% of the rated voltage at 47–63 Hz
Max. installed accessories	1 front mount and 1 side mount auxiliary device for contactors 1 auxiliary device for TeSys Control Relays
Dropout time	150 ms
Max. operation rate	20 operations/min. for LC1D09–LC1D32 30 operations/min. for LC1D40–LC1D80
Max. mechanical and electrical durability	250 000 operations
Leakage current capability	6 ma maximum as per IEC 61131
MTBF	100,000 hours
Standards	SEMI F47-0999, cULus, CE, UL 508 IEC 60947-5-1 (Control Circuit Devices and Switching Elements) IEC 60068 (Mechanical Environmental Testing) NSTA (Shipping and Handling) IEC 61000-4-2 Electrostatic Discharge IEC 61000-4-3 Electromagnetic Field IEC 61000-4-4 Fast Transient and Burst IEC 61000-4-5 Surge Immunity IEC 61000-4-6 Conducted RFI IEC 60068-2-6 Operational Vibration IEC 60068-2-27 Operational Shock
Pickup performance	per UL508 and IEC 60947
Storage temperature	-40 to +80 °C (- 104 to + 176 °F)
Operating temperature	0 to 40°C (32 to 104 °F) ambient surrounding ride through module
Relative humidity	5 to 95%, at 40°C (104 °F) non-condensing
Maximum operating altitude	3000 meters (9842.4 ft)

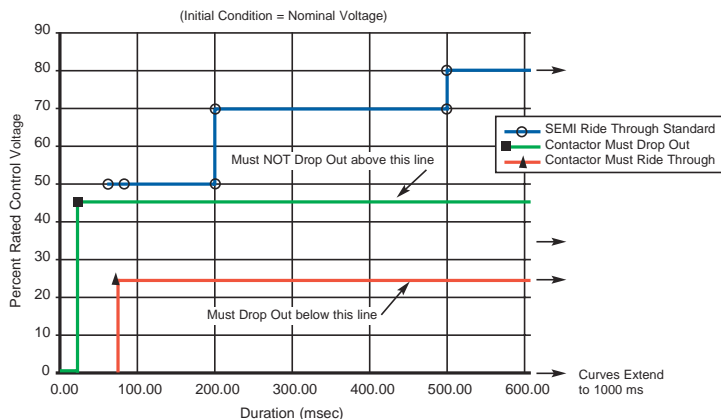

TeSys™ D-Line Contactors and Starters

Selection of Electronic Timers and Interface Modules

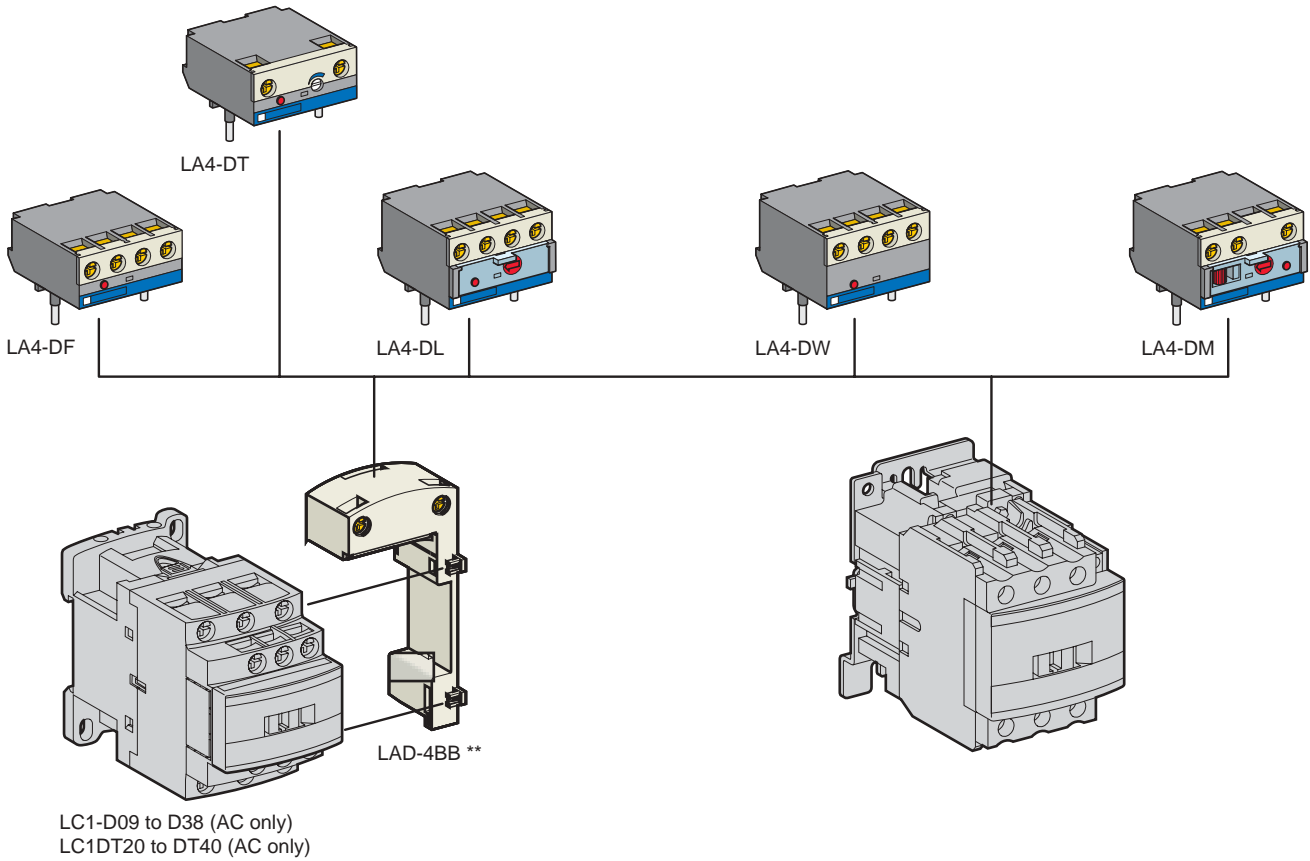

**See Cabling Accessories page 114.

TeSys™ D-Line Contactors and Starters

Selection of Electronic Timers and Interface Modules

Electronic Serial Timer Modules (1)

- 3-pole contactors LC1D40 to D150 and 4-pole contactors LC1D65 to D115: mounted directly across terminals A1 and A2 of contactor (screw mounting).

On-delay Type

Operational Voltage		Time	Catalog Number	Weight lb (kg)
AC 24 to 250 V	100 to 250 V			
LC1 D09 to D38 (3P) and DT20 to DT60 (4P)	LC1 D40 to D150 (3P)	0.1 to 2 s	LA4DT0U (2)	0.09 (0.040)
		1.5 to 30 s	LA4DT2U (2)	0.09 (0.040)
		25 to 500 s	LA4DT4U (2)	0.09 (0.040)

Interface Modules

- 3-pole contactors LC1D40 to D150 and 4-pole contactors LC1D65 to D115: mounted directly across terminals A1 and A2 of contactor (screw mounting).

Relay Interface

Operational Voltage		Supply voltage E1-E2 (dc)	Catalog Number	Weight lb (kg)
AC 24 to 250 V	AC 380 to 415 V			
–	LC1D09 to D150 (3P) and DT20 to DT60 (4P)	24 V	LA4DFBQ (2)	0.12 (0.055)
LC1D09 to D150 (3P) and DT20 to DT60 (4P)	–	24 V	LA4DFB (2)	0.11 (0.050)
		48 V	LA4DFE (2)	0.11 (0.050)

Relay Interface with Manual Override Switch (output forced “ON”)

Operational Voltage		Supply Voltage E1-E2 (dc)	Catalog Number	Weight lb (kg)
AC 24 to 250 V	AC 100 to 250 V			
LC1D09 to D150 (3P) and DT20 to DT60 (4P)	–	24 V	LA4DLB (2)	0.10 (0.045)
		48 V	LA4DLE (2)	0.10 (0.045)

Solid State Interface

LC1D09 to D38 (3P) and DT20 to DT60 (4P)	LC1D40 to D115 (3P)	24 V	LA4DWB (2)	0.10 (0.045)
---	---------------------	------	------------	--------------

Auto-Man-Stop Control Modules

For local override operation tests with two-position “Auto-Man” switch and “O-I” switch

- 3-pole contactors LC1D40 to D150 and 4-pole contactors LC1D65 to D115: mounted directly across terminals A1 and A2 of contactor (screw mounting).

Operational voltage		Catalog Number	Weight lb (kg)
AC 24 to 100 V	AC 100 to 250 V		
LC1D09 to D150 (3P) and DT20 to DT60 (4P)	–	LA4DMK (2)	0.09 (0.040)
–	LC1D40 to D150 (3P)	LA4DMU	0.09 (0.040)

(1) For 24 V operation, the contactor must be fitted with a 21 V coil (code Z7). See pages 117.

(2) Mounting these accessories to TeSys LC1D09 through D38 AC controlled and LC1DT20 through DT40 AC controlled contactors requires the use of the LAD4BB adaptor. This adaptor can not be used on TeSys contactors with DC coils.

Characteristics: pages 103 - 105

Dimensions: pages 122, 123

Schematics: pages 126, 127

TeSys™ D-Line Contactors and Starters

Selection of Coil Suppressor Modules

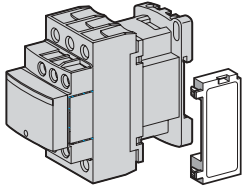

LAD4

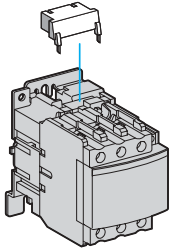

LA4D

RC Circuits (resistor-capacitor)

- Effective protection for circuits highly sensitive to "high frequency" interference. For use only in cases where the voltage is virtually sinusoidal, i.e. less than 5% total harmonic distortion.
- Voltage limited to 3 Uc maximum and oscillating frequency limited to 400 Hz maximum.
- Slight increase in drop-out time (1.2 to 2 times the normal time).

Mounting	For use with Contactor (1) Rating	Type		Catalog Number	Weight lb (kg)
		Vac	Vdc		
Clip-on (3)	D09 to D38 (3P) and DT20 to DT40	24 to 48	–	LAD4RCE	0.03 (0.012)
		110 to 250	–	LAD4RCU	0.03 (0.012)
Screw mounting(4)	D40 to D150 (3P) and D40 to D115 (4P)	24 to 48	–	LA4DA2E	0.04 (0.018)
		50 to 127	–	LA4DA2G	0.04 (0.018)
		110 to 250	–	LA4DA2U	0.04 (0.018)
		380 to 415	–	LA4DA2N	0.04 (0.018)

Varistors (peak limiting)

- Protection provided by limiting the transient voltage to 2 Uc max.
- Maximum reduction of transient voltage peaks.
- Slight increase in drop-out time (1.1 to 1.5 times the normal time).

Clip-on (3)	D09 to D38 (3P) (2) DT20 to DT40	24 to 48	–	LAD4VE	0.03 (0.012)
		50 to 127	–	LAD4VG	0.03 (0.012)
		110 to 250	–	LAD4VU	0.03 (0.012)
Screw connection to the contactor coil terminals	D40 to D115 (3P) and D40 to D115 (4P)	24 to 48	–	LA4DE2E	0.04 (0.018)
		50 to 127	–	LA4DE2G	0.04 (0.018)
		110 to 250	–	LA4DE2U	0.04 (0.018)
Screw connection of wire to the contactor coil terminals	D40 to D115 (3P) and D40 to D115 (4P)	–	24 to 48	LA4DE3E	0.04 (0.018)
		–	50 to 127	LA4DE3G	0.04 (0.018)
		–	110 to 250	LA4DE3U	0.04 (0.018)

Diodes

- No over voltage or oscillating frequency.
- Increase in drop-out time (6 to 10 times the normal time).
- Polarized component.

Screw mounting (4)	D40 to D95 (3P) D40 and D80 (4P)	–	24 to 250	LA4DC3U	0.04 (0.018)
--------------------	-------------------------------------	---	-----------	---------	--------------

Bidirectional peak limiting diode

- Protection provided by limiting the transient voltage to 2 Uc max.
- Maximum reduction of transient voltage peaks.

Clip-on (3)	D09 to D38 (3P) (2)	24	–	LAD4TB	0.03 (0.012)
	DT20 to DT40	72	–	LAD4TS	0.03 (0.012)
Screw mounting (4)	D40 to D95 (3P)	24	–	LA4DB2B	0.04 (0.018)
	D40 and D80 (4P)	72	–	LA4DB2S	0.04 (0.018)
	D40 to D95 (3P)	–	24	LA4DB3B	0.04 (0.018)
	D40 and D80 (4P)	–	72	LA4DB3S	0.04 (0.018)

- (1) For satisfactory protection, a suppressor module must be installed across the coil of each contactor.
- (2) From LC1D09 to D38 and LC1DT20 to DT40, dc and low consumption 3-pole contactors are fitted with built-in suppression as standard.
- (3) Clipping-on makes the electrical connection. The overall size of the contactor remains unchanged.
- (4) Mounting at the top of the contactor on coil terminals A1 and A2.

Characteristics: pages 100 - 102

Dimensions: pages 122, 123

Schematics: pages 126, 127

TeSys™ D-Line Contactors and Starters

Selection of Accessories for Contactors and Reversing Contactors

Accessories for Main Pole and Control Connections

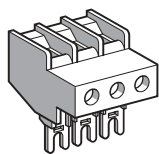

LA9D3260

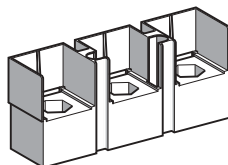

LA9D11550-

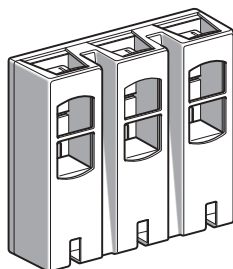

LA9D11560-

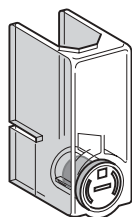

LA9D11570-

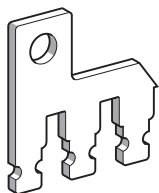

LA9D80962

Description		For Use on Contactors		Sold In Lots Of	Catalog Number	Weight lb (kg)
		AC	DC			
Connectors for cable, sizes (1 connector)	4-pole 10 mm ² (8 AWG)	D09, D12, DT20, DT25	D09, D12, DT20, DT25	1	LAD92560	0.67 (0.030)
	3-pole 25 mm ² (4 AWG)	D09 to D38	D09 to D38	1	LA9D3260	0.09 (0.040)
	4-pole 25 mm ² (4 AWG)	DT32 to DT40	DT32 to DT40	1	LAD96060	0.13 (0.060)
Connectors for cable, sizes (2 connectors)	3-pole 120 mm ² (250 MCM)	D115, D150	D115, D150	1	LA9D115603B	1.2 (0.560)
	4-pole 120 mm ² (250 MCM)	D115	D115	1	LA9D115604	1.6 (0.740)
Connector for lug type terminals (2 connectors)	3-pole	D115, D150	D115, D150	1	LA9D115503B	0.66 (0.300)
	4-pole	D115	D115	1	LA9D115504	0.80 (0.360)
Protective covers for lug type terminals	3-pole (1)	D115, D150	D115, D150	1	LA9D115703	0.55 (0.250)
	4-pole (1)	D115, D150	D115, D150	1	LA9D115704	0.66 (0.300)
Links for parallel connection of	2 poles	D09 to D38	D09 to D38	10	LA9D2561	0.13 (0.060)
		DT20 & DT25 (4P)	DT20 & DT25 (4P)	10	LA9D1261	0.03 (0.012)
		DT32 to DT40 (4P)	DT32 to DT40 (4P)	10	LAD96061	0.13 (0.060)
		D40 to D65	D40 to D65	2	LA9D40961	0.05 (0.021)
		D80, D95	D80	2	LA9D80961	0.13 (0.060)
	3 poles (star connection)	D09 to D38	D09 to D38	10	LAD9P3 (2)	0.01 (0.005)
		D80, D95	D80	1	LA9D80962	0.18 (0.080)
		DT20 to DT40	DT20 to DT40	2	LA9D1263	0.05 (0.024)
	4 poles	D40 to D65	D40 to D65	2	LA9D40963	0.15 (0.070)
		D80, D95	D80	2	LA9D80963	0.22 (0.100)
		Staggered coil connection	–	D40 to D80	10	LA9D09966
	Control circuit take-off from main pole	D40 to D65	D40 to D65	10	LA9D6567	0.02 (0.010)
D80, D95		D80	10	LA9D8067	0.02 (0.010)	
Spreaders for increasing the pole pitch to 45 mm	D115, D150	D115, D150	3	GV7AC03	0.4 (0.180)	

- (1) For 3-pole contactors: 1 set of 6 covers, for 4-pole contactors: 1 set of 8 covers.
 (2) Separate connecting bar for connecting 2 poles in parallel.

Dimensions: pages 122, 123

Schematics: pages 126, 127

TeSys™ D-Line Contactors and Starters

Selection of Accessories for Contactors and Reversing Contactors

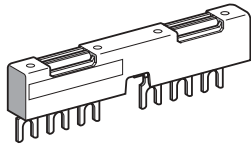

GV2G245

Sets of Contacts and Arc Chambers

Description	For Use on Contactors		Catalog Number	Weight lb (kg)
Set of contacts	3-pole	LC1D115	LA5D1158031	0.60 (0.260)
		LC1D150	LA5D150803	0.60 (0.260)
	4-pole	LC1D115004	LA5D115804	0.72 (0.330)
Arc chambers	3-pole	LC1D115	LA5D11550	0.87 (0.395)
		LC1D150	LA5D15050B	0.87 (0.395)
	4-pole	LC1D115004	LA5D115450B	1.03 (0.470)

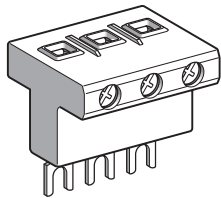

GV1G09

Cabling Accessories

For adapting existing wiring to a new product	LC1D09 to D38 and LC1DT20 to DT60 AC only	Without coil suppression		LAD4BB	0.04 (0.019)
		With coil suppression	ac 24 to 48 V	LAD4BBVE	0.03 (0.014)
			ac 50 to 127 V	LAD4BBVG	0.03 (0.014)
			ac 110 to 250 V	LAD4BBVU	0.03 (0.014)
Set of 63 A busbars for paralleling of contactors	2 contactors LC1D09 to D18 or D25 to D38		GV2G245	0.08 (0.036)	
	4 contactors LC1D09 to D18 or D25 to D38		GV2G445	0.17 (0.077)	
Terminal block for supply to:	One or more GV2G busbar sets		GV1G09	0.09 (0.040)	

Protection Accessories

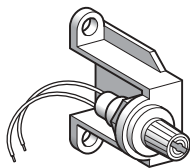

LA9D941

Description	Application	Sold in Lots Of	Catalog Number	Weight lb (kg)
Miniature fuse holder	5 x 20 with 4 A-250 V fuse	1	LA9D941	0.05 (0.025)
Sealing cover	For LADT, LADR	1	LA9D901	0.01 (0.005)
Safety cover preventing access to the moving contact carrier	LC1D09 to D38 and DT20 to DT60	1	LAD9ET1	0.06 (0.026)
	LC1D40 to D65	1	LAD9ET2	0.03 (0.012)
	LC1D80 and D95	1	LAD9ET3	0.008 (0.004)
	LC1D115 and D150	1	LAD9ET4	0.008 (0.004)

Marking Accessories



LAD9ET.

Description	Application	Sold in Lots Of	Catalog Number	Weight lb (kg)
Sheet of 80 blank labels self-adhesive, 8 x 33 (1)	Contactors (excluding 4-pole LC1-D65 to D115) LADN (4 contacts), LA6DK	10	LAD21	0.04 (0.020)
Sheet of 80 blank labels self-adhesive, 8 x 12 (1)	LADN (2 contacts), LADT, LADR, LRD	10	LAD22	0.04 (0.020)
Sheet of 80 blank labels for marking using plotter or 8 x 33 engraver	Contactors (excluding 4-pole LC1D65 to D115) LAD (4 contacts), LA6DK	10	LAD23	0.11 (0.050)
Sheet of 112 blank labels for marking using plotter or 8 x 12 mm engraver	All products	35	LAD24	0.44 (0.200)
Label holder snap-in, 8 x 22 mm	4-pole contactors LC1D65 and D80, LA6DK	100	LA9D92	0.002 (0.001)
Legend holder snap-in, 8 x 22 mm	LC1D09 to D38 LC1DT20 to D40 LAD●N (4 contacts) LAD●T, LAD●R	100	LAD90	0.002 (0.001)
Bag of 300 blank labels self-adhesive, 7 x 21 mm	On holder LA9D92	1	LA9D93	0.002 (0.001)
"SIS Label" label creation software	Multi-language version (EN, FR, GE) ▲	1	XBY2U	0.13 (0.060)

▲ System requirement: 486 processor or better; Windows 95, 98 or NT 4.0 or better.

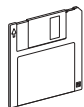

XBY1U

Mounting Accessories

Mounting plate	For replacement of LC1F115 or F150 by LC1D115 or D150	1	LA9D730	0.80 (0.360)
Set of shims	For fitting side mounting blocks LAD8N on LC1D40 to D95	1	LA9D511	0.04 (0.020)

(1) These legends are for sticking onto the safety cover of the contactors or add-on block, if fitted.

TeSys™ D-Line Contactors and Starters

D-line Voltage Code Table

D-line Voltage Code

Voltage	Frequency	D-line (see notes at end of table)		
		LC1D09 - D38 LC2D09 - D38 Notes D1, D3	LC1D40 - D95 LC2D40 - D95 Note D1	LC1D115 - D150 Note D1, D2, D4
5	Low Consump DC	AL	-	-
12	50/60	J7	-	-
	50	-	J5	-
	DC	JD	JD	-
	Low Consump DC	JL	-	-
	Wide Range DC	-	JW	-
20	50/60	-	Z7	-
	50	-	Z5	-
	60	-	Z6	-
	DC	-	-	-
24	Low Consump DC	ZL	-	-
	50/60	B7	B7	B7
	50	-	B5	B5
	60	-	B6	B6
	40-400	-	-	-
36	DC	BD	BD	BD
	Low Consump DC	BL	-	-
	Wide Range DC	-	BW	-
42	50/60	CC7	-	-
	DC	CD	CD	CD
	Wide Range DC	-	CW	-
48	50/60	D7	D7	D7
	50	-	D5	D5
	60	-	-	-
60	50/60	E7	E7	E7
	50	-	E5	E5
	60	-	E6	E6
	40-400	-	-	-
	DC	ED	ED	ED
72	Low Consump DC	EL	-	-
	Wide Range DC	-	EW	-
	50/60	EE7	-	-
96	DC	ND	ND	ND
	DC	SD	SD	SD
	Low Consump DC	SL	-	-
100	Wide Range DC	-	SW	-
	Low Consump DC	DL	-	-
100	50/60	K7	K7	-
	DC	-	-	-

D-line Voltage Code (Continued)

Voltage	Frequency	D-line (see notes at end of table)		
		LC1D09 - D38 LC2D09 - D38 Notes D1, D3	LC1D40 - D95 LC2D40 - D95 Note D1	LC1D115 - D150 Note D1, D2, D4
110	50/60	F7	F7	F7
	50	-	F5	F5
	60	-	F6	F6
	40-400	-	-	-
	DC	FD	FD	FD
	Low Consump DC	FL	-	-
110/127	Wide Range DC	-	FW	-
	40-400	-	-	-
115	50/60	FE7	FE7	FE7
	50	-	FE5	FE5
	40-400	-	-	-
120	50/60	G7	G7	G7
	50	-	-	-
	60	-	G6	G6
	40-400	-	-	-
	DC	-	-	-
125	Low Consump DC	-	-	-
	DC	GD	GD	GD
127	50/60	FC7	-	FC7
	60	-	G5	FC5
	40-400	-	-	-
155	DC	PD	-	-
174	DC	-	-	-
200	50/60	L7	L7	-
	DC	-	-	-
200/208	50/60	-	-	-
	60	-	-	-
	40-400	-	-	-
208	50/60	LE7	LE7	LE7
	60	-	L6	L6
	40-400	-	-	-
220	50/60	M7	M7	M7
	50	-	-	M5
	60	-	M6	M6
	40-400	-	-	-
	DC	MD	MD	MD
220/230	Low Consump DC	ML	-	-
	Wide Range DC	-	MW	-
220/240	50/60	-	-	-
	50	-	M5	-
	60	-	-	-
220/240	40-400	-	-	-
	DC	-	-	-

TeSys™ D-Line Contactors and Starters

D-line Voltage Code Table

D-line Voltage Code (Continued)

Voltage	Frequency	D-line (see notes at end of table)		
		LC1D09 - D38 LC2D09 - D38 Notes D1, D3	LC1D40 - D95 LC2D40 - D95 Note D1	LC1D115 - D150 Note D1, D2, D4
230	50/60	P7	P7	P7
	50	U7	P5	P5
	60	-	-	-
	40-400	-	-	-
	DC	-	-	-
230/240	50/60	-	-	-
240	50/60	U7	U7	U7
	50	-	U5	U5
	60	-	U6	U6
	40-400	-	-	-
	DC	-	-	-
250	DC	UD	UD	UD
	Low Consump DC	UL	-	-
256	50/60	-	-	-
	50	-	W5	-
277	50/60	W7	-	UE7
	50	-	W6	W6
	40-400	-	-	-
380	50/60	Q7	Q7	Q7
	50	-	-	Q5
	60	-	Q6	Q6
	40-400	-	-	-
380/400	50/60	-	-	-
	50	-	Q5	-
	60	-	-	-
	40-400	-	-	-
	DC	-	-	-
380/440	40-400	-	-	-
400	50/60	V7	V7	V7
	50	-	V5	V5
	40-400	-	-	-
400/415	50/60	-	-	-
415	50/60	N7	N7	N7
	50	-	N5	N5
	40-400	-	-	-
415-440	50	-	-	-
	40-400	-	-	-
440	50/60	R7	R7	R7
	50	-	R5	R5
	60	-	R6	R6
	40-400	-	-	-
	DC	RD	RD	RD
440/460	DC	-	-	-
460/480	60	-	-	-
480	50/60	T7	-	T7
	50	-	-	-
	60	-	T6	T6
	40-400	-	-	-
500	50/60	S7	-	S7
	50	-	S5	S5
	40-400	-	-	-
575	50/60	SC7	-	-
	60	-	S6	-

D-line Voltage Code (Continued)

Voltage	Frequency	D-line (see notes at end of table)		
		LC1D09 - D38 LC2D09 - D38 Notes D1, D3	LC1D40 - D95 LC2D40 - D95 Note D1	LC1D115 - D150 Note D1, D2, D4
600	50/60	X7	-	-
	60	X6	X6	-
	40-400	-	-	-
660	50	Y5	Y5	-
	60	-	-	-
660/690	50/60	-	-	-
Notes:				
D1 For operating ranges refer to technical data section of the D-line contactors. Ranges vary as a function of the current rating of the contactor and type of supply (AC/DC)				
D2 LC1-D150 Contactors utilize dual frequency 50/60 Hz. coils only. Single frequency coils are not available.				
D3 LC1D09-LC1D38 contactors with DC coil have integral suppression device (bi-directional diode) as standard.				
D4 D115 and D150 coils have integral suppression device fitted as standard.				

TeSys™ D-Line Contactors and Starters Selection of AC Coils

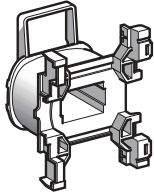

LXD1•

AC Coils for Contactors LC1D09 to D38 3-pole and 4-pole LC1DT20 to DT40

Specifications

Control circuit voltage U _c	Average resistance at 20 °C ± 10%	Inductance of closed circuit	Catalog Number (1)	Weight lb (kg)
V	Ω	H	50/60 Hz	

Average consumption at 20 °C (68 °F):

- inrush (cos φ = 0.75) 70 VA,

- sealed (cos φ = 0.3) 50 Hz: 7 VA, 60 Hz: 7.5 VA.

Operating range (θ ≤ 60 °C / 140 °F): 50 Hz: 0.8 to 1.1 U_c, 60 Hz: 0.85 to 1.1 U_c.

12	6.3	0.26	LXD1J7	0.15 (0.070)
21 (2)	5.6	0.24	LXD1Z7	0.15 (0.070)
24	6.19	0.26	LXD1B7	0.15 (0.070)
32	12.3	0.48	LXD1C7	0.15 (0.070)
36	12.83		LXD1CC7	0.15 (0.070)
42	19.15	0.77	LXD1D7	0.15 (0.070)
48	25	1	LXD1E7	0.15 (0.070)
60	34.6	–	LXD1EE7	0.15 (0.070)
100	100.4	–	LXD1K7	0.15 (0.070)
110	130	5.5	LXD1F7	0.15 (0.070)
115	129.8	–	LXD1FE7	0.15 (0.070)
120	159	6.7	LXD1G7	0.15 (0.070)
127	192.5	7.5	LXD1FC7	0.15 (0.070)
200	410.7	–	LXD1L7	0.15 (0.070)
208	417	16	LXD1LE7	0.15 (0.070)
220	539	22	LXD1M7	0.15 (0.070)
230	595	21	LXD1P7	0.15 (0.070)
240	645	25	LXD1U7	0.15 (0.070)
277	781	30	LXD1W7	0.15 (0.070)
380	1580	60	LXD1Q7	0.15 (0.070)
400	1810	64	LXD1V7	0.15 (0.070)
415	1938	74	LXD1N7	0.15 (0.070)
440	2242	79	LXD1R7	0.15 (0.070)
480	2300	85	LXD1T7	0.15 (0.070)
575	3432	119	LXD1SC7	0.15 (0.070)
600	3600	135	LXD1X7	0.15 (0.070)
690	5600	190	LXD1Y7	0.15 (0.070)

(1) The last two digits of the reference represent the voltage code.

(2) Voltage for special coils installed in contactors with serial timer modules, with 24 V supply.

TeSys™ D-Line Contactors and Starters

Selection of AC Coils

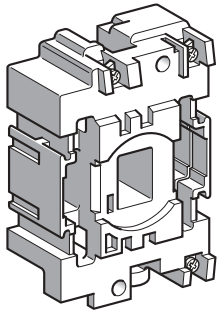

LX1D6

AC Coils for 3 or 4-pole Contactors LC1D40, D50, D65, D80, D95

Specifications

Control circuit voltage U _c	Average resistance at 20 °C ± 10%	Inductance of closed circuit	Catalog Number (1)	Average resistance at 20 °C ± 10%	Inductance of closed circuit	Catalog Number (1)	Weight lb (kg)
V	Ω	H	50 Hz	W	H	60 Hz	

Average consumption at 20 °C (68 °F):

- inrush (cos φ = 0.75) 50 Hz: 200 VA, 60 Hz: 220 VA,

- sealed (cos φ = 0.3) 50 Hz: 20 VA, 60 Hz: 22 VA.

Operating range (θ ≤ 55 °C / 131 °F): 0.85 to 1.1 U_c.

24	1.4	0.09	LX1D6B5	1.05	0.06	LX1D6B6	0.61 (0.280)
32	2.6	0.16	LX1D6C5	–	–	–	0.61 (0.280)
42	4.4	0.27	LX1D6D5	–	–	–	0.61 (0.280)
48	5.5	0.35	LX1D6E5	4.2	0.23	LX1D6E6	0.61 (0.280)
110	31	1.9	LX1D6F5	22	1.2	LX1D6F6	0.61 (0.280)
115	31	1.9	LX1D6FE5	–	–	–	0.61 (0.280)
120	–	–	–	28	1.5	LX1D6G6	0.61 (0.280)
127	41	2.4	LX1D6G5	–	–	–	0.61 (0.280)
208	–	–	–	86	4.3	LX1D6L6	0.61 (0.280)
220	–	–	–	98	4.8	LX1D6M6	0.61 (0.280)
220/230	127	7.5	LX1D6M5	–	–	–	0.61 (0.280)
230	133	8.1	LX1D6P5	–	–	–	0.61 (0.280)
240	152	8.7	LX1D6U5	120	5.7	LX1D6U6	0.61 (0.280)
256	166	10	LX1D6W5	–	–	–	0.61 (0.280)
277	–	–	–	157	8	LX1D6W6	0.61 (0.280)
380	–	–	–	300	14	LX1D6Q6	0.61 (0.280)
380/400	381	22	LX1D6Q5	–	–	–	0.61 (0.280)
400	411	25	LX1D6V5	–	–	–	0.61 (0.280)
415	463	26	LX1D6N5	–	–	–	0.61 (0.280)
440	513	30	LX1D6R5	392	19	LX1D6R6	0.61 (0.280)
480	–	–	–	480	23	LX1D6T6	0.61 (0.280)
500	668	38	LX1D6S5	–	–	–	0.61 (0.280)
575	–	–	–	675	33	LX1D6S6	0.61 (0.280)
600	–	–	–	775	36	LX1D6X6	0.61 (0.280)
660	1220	67	LX1D6Y5	–	–	–	0.61 (0.280)

Specifications

Average consumption at 20 °C (68 °F):

- inrush (cos φ = 0.75) 50/60 Hz: 245 VA at 50 Hz,

- sealed (cos φ = 0.3) 50/60 Hz: 26 VA at 50 Hz.

Operating range (θ ≤ 55 °C / 131 °F): 0.85 to 1.1 U_c.

						50/60 Hz	
24	–	–	–	1.22	0.08	LX1D6B7	0.61 (0.280)
42	–	–	–	3.5	0.25	LX1D6D7	0.61 (0.280)
48	–	–	–	5	0.32	LX1D6E7	0.61 (0.280)
110	–	–	–	26	1.7	LX1D6F7	0.61 (0.280)
115	–	–	–	–	–	LX1D6FE7	0.61 (0.280)
120	–	–	–	32	2	LX1D6G7	0.61 (0.280)
208	–	–	–	88.7	4.42	LC1D6LE7	0.61 (0.280)
220/230 (2)	–	–	–	102	6.7	LX1D6M7	0.61 (0.280)
230	–	–	–	115	7.7	LX1D6P7	0.61 (0.280)
230/240 (3)	–	–	–	131	8.3	LX1D6U7	0.61 (0.280)
380/400 (4)	–	–	–	310	20	LX1D6Q7	0.61 (0.280)
400	–	–	–	349	23	LX1D6V7	0.61 (0.280)
415	–	–	–	390	24	LX1D6N7	0.61 (0.280)
440	–	–	–	410	27	LX1D6R7	0.61 (0.280)

(1) The last two digits of the reference represent the voltage code.

(2) For use on 230 V 50 Hz, apply a coefficient of 0.6 to the mechanical durability of the contactor (see page 82). This coil can be used on 240 V at 60 Hz.

(3) This coil can be used on 220/240 V at 50 Hz and on 240 V only at 60 Hz.

(4) For use on 400 V 50 Hz, apply a coefficient of 0.6 to the mechanical durability of the contactor.

TeSys™ D-Line Contactors and Starters Selection of AC Coils

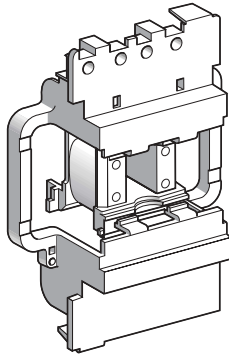

LX1D8..

AC Coils for 3 or 4-pole Contactors LC1D115

Control circuit voltage U _c	Average resistance at 20 °C ± 10%	Inductance of closed circuit	Catalog Number(1)	Average resistance at 20 °C ± 10%	Inductance of closed circuit	Catalog Number (1)	Weight lb (kg)
V	Ω	H	50 Hz	Ω	H	60 Hz	kg

Specifications

Average consumption at 20 °C (68 °F):
 - inrush (cos φ = 0.8) - 50 or 60 Hz: 300 VA,
 - sealed (cos φ = 0.3) - 50 or 60 Hz: 22 VA.
 Operating range (θ ≤ 55 °C / 131 °F): 0.85 to 1.1 U_c.

24	1.24	0.09	LX1D8B5	0.87	0.07	LX1D8B6	0.57 (0.260)
32	2.14	0.17	LX1D8C5	–	–	–	0.57 (0.260)
42	3.91	0.28	LX1D8D5	–	–	–	0.57 (0.260)
48	4.51	0.36	LX1D8E5	3.91	0.28	LX1D8E6	0.57 (0.260)
110	26.53	2.00	LX1D8F5	19.97	1.45	LX1D8F6	0.57 (0.260)
115	26.53	2.00	LX1D8FE5	–	–	–	0.57 (0.260)
120	–	–	–	24.02	1.70	LX1D8G6	0.57 (0.260)
127	32.75	2.44	LX1D8FC5	–	–	–	0.57 (0.260)
208	–	–	–	67.92	5.06	LX1D8L6	0.57 (0.260)
220	104.77	7.65	LX1D8M5	79.61	5.69	LX1D8M6	0.57 (0.260)
230	104.77	8.29	LX1D8P5	–	–	–	0.57 (0.260)
240	125.25	8.89	LX1D8U5	97.04	6.75	LX1D8U6	0.57 (0.260)
277	–	–	–	125.75	8.89	LX1D8W6	0.57 (0.260)
380	338.51	22.26	LX1D8Q5	243.07	17.04	LX1D8Q6	0.57 (0.260)
400	368.43	25.55	LX1D8V5	–	–	–	0.57 (0.260)
415	368.43	27.65	LX1D8N5	–	–	–	0.57 (0.260)
440	441.56	30.34	LX1D8R5	338.51	22.26	LX1D8R6	0.57 (0.260)
480	–	–	–	368.43	25.55	LX1D8T6	0.57 (0.260)
500	566.62	38.12	LX1D8S5	–	–	–	0.57 (0.260)

For 3 or 4-pole contactors LC1D115, D150

Specifications

Average consumption at 20 °C (68 °F):
 - inrush: cos φ = 0.9 - 280 to 350 VA,
 - sealed: cos φ = 0.9 - 2 to 18 VA.
 Operating range (θ ≤ 55 °C / 131 °F): 0.8 to 1.15 U_c.
 Coils with integral suppression device fitted as standard, class B.

						50/60 Hz	
24	–	–	–	147	3.03	LX1D8B7	0.64 (0.290)
32	–	–	–	301	8.28	LX1D8C7	0.64 (0.290)
42	–	–	–	498	13.32	LX1D8D7	0.64 (0.290)
48	–	–	–	1061	24.19	LX1D8E7	0.64 (0.290)
110	–	–	–	4377	109.69	LX1D8F7	0.64 (0.290)
115	–	–	–	4377	109.69	LX1D8FE7	0.64 (0.290)
120	–	–	–	4377	109.69	LX1D8G7	0.64 (0.290)
127	–	–	–	6586	152.65	LX1D8FC7	0.64 (0.290)
208	–	–	–	10 895	260.15	LX1D8LE7	0.64 (0.290)
220	–	–	–	9895	210.72	LX1D8M7	0.64 (0.290)
230	–	–	–	9895	210.72	LX1D8P7	0.64 (0.290)
240	–	–	–	9895	210.72	LX1D8U7	0.64 (0.290)
277	–	–	–	21 988	533.17	LX1D8UE7	0.64 (0.290)
380	–	–	–	21 011	482.42	LX1D8Q7	0.64 (0.290)
400	–	–	–	21 011	482.42	LX1D8V7	0.64 (0.290)
415	–	–	–	21 011	482.42	LX1D8N7	0.64 (0.290)
440	–	–	–	21 501	507.47	LX1D8R7	0.64 (0.290)
480	–	–	–	32 249	938.41	LX1D8T7	0.64 (0.290)
500	–	–	–	32 249	938.41	LX1D8S7	0.64 (0.290)

(1) The last two characters of the reference represent the voltage code.

TeSys™ D-Line Contactors and Starters

Selection of DC Coils

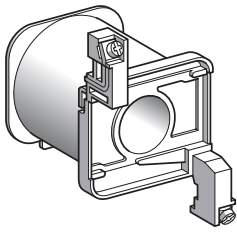

LX4D6**

DC Coils for 3-pole Contactors LC1D40 to D65 or 4-pole Contactors LP1D65

Control circuit voltage U _c	Average resistance at 20 °C ± 10%	Inductance of closed circuit	Catalog Number (1)	Weight lb (kg)
V	Ω	H		
Specifications				
Average consumption: 22 W. Operating range: 0.85 to 1.1 U _c .				
12	7.1	0.44	LX4D6JD	0.91 (0.415)
24	26.8	1.69	LX4D6BD	0.91 (0.415)
36	58	3.55	LX4D6CD	0.91 (0.415)
48	109	6.86	LX4D6ED	0.91 (0.415)
60	173	10.9	LX4D6ND	0.91 (0.415)
72	234	14.7	LX4D6SD	0.91 (0.415)
110	560	35.28	LX4D6FD	0.91 (0.415)
125	717	45.2	LX4D6GD	0.91 (0.415)
220	2255	142	LX4D6MD	0.91 (0.415)
250	2940	185	LX4D6UD	0.91 (0.415)
440	9080	572	LX4D6RD	0.91 (0.415)

For 3-pole contactors LC1D80 or 4-pole contactors LP1D80

Specifications				
Average consumption: 22 W. Operating range: 0.85 to 1.1 U _c .				
12	6.6	0.46	LX4D7JD	1.50 (0.680)
24	27	1.89	LX4D7BD	1.50 (0.680)
36	57	4	LX4D7CD	1.50 (0.680)
48	107	7.5	LX4D7ED	1.50 (0.680)
60	170	11.9	LX4D7ND	1.50 (0.680)
72	230	16.1	LX4D7SD	1.50 (0.680)
110	564	39.5	LX4D7FD	1.50 (0.680)
125	718	50.3	LX4D7GD	1.50 (0.680)
220	2215	155	LX4D7MD	1.50 (0.680)
250	2850	200	LX4D7UD	1.50 (0.680)
440	9195	640	LX4D7RD	1.50 (0.680)

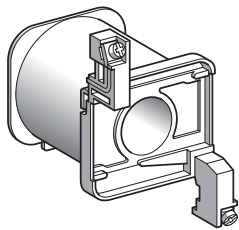

LX4D7**

(1) The last two characters of the reference represent the voltage code.

TeSys™ D-Line Contactors and Starters Selection of DC Coils

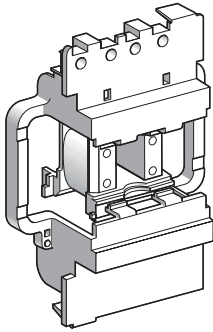

LX4D8-D

DC Coils for 3 or 4-pole Contactors LC1D115, D150

Control circuit voltage U _c	Average resistance at 20 °C ± 10%	Inductance of closed circuit	Catalog Number(1)	Weight lb (kg)
V	Ω	H		

Specifications

Consumption: inrush 270 to 365 W, sealed 2.4 to 5.1 W.
Operating range: 0.7 to 1.2 U_c.
Coils have integral suppression device as standard, class B.

24	147	3.03	LX4D8BD	0.66 (0.300)
48	1061	24.19	LX4D8ED	0.66 (0.300)
60	1673	38.44	LX4D8ND	0.66 (0.300)
72	2500	56.27	LX4D8SD	0.66 (0.300)
110	4377	109.69	LX4D8FD	0.66 (0.300)
125	6586	152.65	LX4D8GD	0.66 (0.300)
220	9895	210.72	LX4D8MD	0.66 (0.300)
250	18 022	345.40	LX4D8UD	0.66 (0.300)
440	21 501	684.66	LX4D8RD	0.66 (0.300)

(1) The last two characters of the reference represent the voltage code.

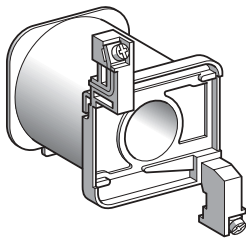

LX4D6••

Wide Range DC Coils for 3-pole Contactors LC1D40 to D65 or 4-pole Contactors LP1 to D65

Control circuit voltage U _c	Average resistance at 20 °C ± 10%	Inductance of closed circuit	Catalog Number(1)	Weight lb (kg)
V	Ω	H		

Specifications

Average consumption: 22 W.
Operating range: 0.75 to 1.2 U_c.
Coils with "TH" treatment as standard.

12	6.8	0.45	LX4D6JW	0.91 (0.415)
24	30	1.9	LX4D6BW	0.91 (0.415)
36	53	3.5	LX4D6CW	0.91 (0.415)
48	110	7.2	LX4D6EW	0.91 (0.415)
72	215	14.2	LX4D6SW	0.91 (0.415)
110	580	38.3	LX4D6FW	0.91 (0.415)
220	2120	140	LX4D6MW	0.91 (0.415)

For 3-pole contactors LC1D80 or 4-pole contactors LP1D80

Specifications

Average consumption: 23 W.
Operating range: 0.75 to 1.2 U_c.
Coils with "TH" treatment as standard.

12	6.2	0.49	LX4D7JW	1.50 (0.680)
24	23.5	1.75	LX4D7BW	1.50 (0.680)
36	51.9	4.18	LX4D7CW	1.50 (0.680)
48	94.2	7	LX4D7EW	1.50 (0.680)
72	204	15.7	LX4D7SW	1.50 (0.680)
110	483	36	LX4D7FW	1.50 (0.680)
220	1922	144	LX4D7MW	1.50 (0.680)

(1) The last two characters of the reference represent the voltage code.

TeSys™ D-Line Contactors and Starters

Dimensions for Type LC1D Contactors

D-Line Contactors AC Control Circuits

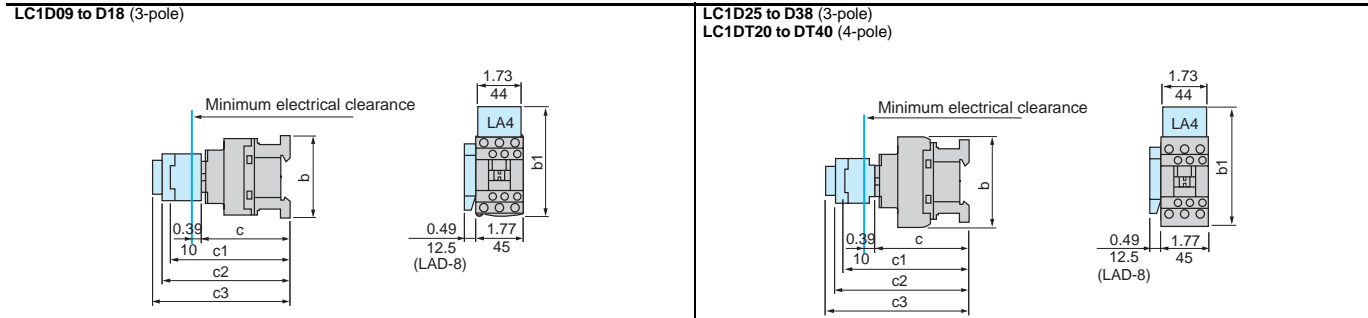

LC1		D09 to D18	D093 to D183	D099 to D189	D25 to D38	D253 and D323	DT20 and DT25	DT203 and DT253	DT32 to DT40	DT323 and DT403
b	without add-on blocks	3.03 (77)	3.89 (99)	3.14 (80)	3.36 (85)	3.89 (99)	3.34 (85)	3.89 (99)	3.58 (91)	4.13 (105)
b1	with LAD4BB	3.70 (94)	4.21 (107)	3.75 (95.5)	3.85 (98)	4.21 (107)	3.85 (98)	—	—	—
	with LA4D•2	4.33 (110) (1)	4.84 (123) (1)	4.30 (111.5) (1)	4.48 (114) (1)	4.84 (123) (1)	4.48 (114)	—	—	—
	with LA4DF, DT	4.68 (119) (1)	5.19 (132) (1)	4.76 (120.5) (1)	4.84 (123) (1)	5.19 (132) (1)	5.02 (129)	—	—	—
	with LA4DR, DW, DL	4.96 (126) (1)	5.67 (139) (1)	5.0 (127.5) (1)	5.11 (130) (1)	5.47 (139) (1)	7.48 (190)	—	—	—
c	without cover or add-on blocks	3.30 (84)	3.30 (84)	3.30 (84)	3.54 (90)	3.54 (90)	3.54 (90)	3.54 (90)	3.85 (98)	3.85 (98)
	with cover, without add-on blocks	3.38 (86)	3.38 (86)	3.38 (86)	3.62 (92)	3.62 (92)	3.62 (92)	3.62 (92)	3.93 (100)	3.93 (100)
c1	with LADN or C (two or four contacts)	4.60 (117)	4.60 (117)	4.60 (117)	4.84 (123)	4.84 (123)	4.84 (123)	4.84 (123)	5.15 (131)	5.15 (131)
c2	with LA6DK10, LAD6K10	5.07 (129)	5.07 (129)	5.07 (129)	5.31 (135)	5.31 (135)	5.31 (135)	5.31 (135)	5.62 (143)	5.62 (143)
c3	with LADT, R, S	5.39 (137)	5.39 (137)	5.39 (137)	5.62 (143)	5.62 (143)	5.62 (143)	5.62 (143)	5.94 (151)	5.94 (151)
	with LADT, R, S and sealing cover	5.55 (141)	5.59 (141)	5.55 (141)	5.78 (147)	5.78 (147)	5.78 (147)	5.78 (147)	6.10 (155)	6.10 (155)

(1) Including LAD4BB

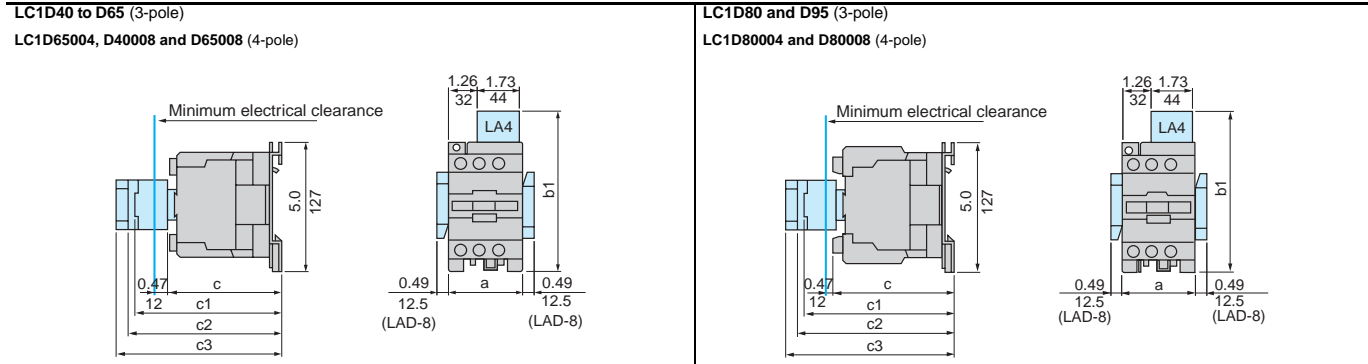

LC1		D40 to D65	D40008	D80 D65004	D95 D65008	D80004	D80008
a		2.95 (75)	3.34 (85)	3.34 (85)	3.34 (85)	96	96
b1	with LA4D•2	5.31 (135)	5.31 (135)	5.31 (135)	5.31 (135)	5.31 (135)	5.31 (135)
	with LA4DB3	—	—	5.31 (135)	—	—	—
	with LA4DF, DT	5.59 (142)	5.59 (142)	5.59 (142)	5.59 (142)	5.59 (142)	5.59 (142)
	with LA4DM, DR, DW, DL	5.90 (150)	5.90 (150)	5.90 (150)	5.90 (150)	5.90 (150)	5.90 (150)
c	without cover or add-on blocks	4.72 (114)	4.92 (125)	4.92 (125)	4.92 (125)	4.92 (125)	5.51 (140)
	with cover, without add-on blocks	4.68 (119)	—	5.11 (130)	5.11 (130)	—	—
c1	with LADN (one contact)	5.47 (139)	5.47 (139)	5.90 (150)	5.90 (150)	5.90 (150)	5.90 (150)
	with LADN or C (two or four contacts)	5.78 (147)	5.78 (147)	6.22 (158)	6.22 (158)	6.22 (158)	6.22 (158)
c2	with LA6DK	6.25 (159)	6.25 (159)	6.69 (170)	6.69 (170)	6.69 (170)	6.69 (170)
c3	with LADT, R, S	6.57 (167)	6.57 (167)	7.00 (178)	7.00 (178)	7.00 (178)	7.00 (178)
	with LADT, R, S and sealing cover	6.73 (171)	6.73 (171)	7.16 (182)	7.16 (182)	7.16 (182)	7.16 (182)

LC1		D115 D150	D115004	D115006	D150006	D1150046
a		4.72 (120)	5.90 (150)	4.72 (120)	4.72 (120)	6.10 (155)
b1	with LA4DA2	6.85 (174)	6.85 (174)	6.85 (174)	6.85 (174)	6.85 (174)
	with LA4DF, DT	7.28 (185)	7.28 (185)	7.28 (185)	7.28 (185)	7.28 (185)
	with LA4DM, DR, DL	7.40 (188)	7.40 (188)	7.40 (188)	7.40 (188)	7.40 (188)
	with LA4DW	7.40 (188)	7.40 (188)	7.40 (188)	—	7.40 (188)
c	without cover or add-on blocks	5.19 (132)	5.19 (132)	4.52 (115)	4.52 (115)	4.52 (115)
	with cover, without add-on blocks	5.35 (136)	—	—	—	—
c1	with LADN or C (two or four contacts)	5.90 (150)	5.90 (150)	5.90 (150)	5.90 (150)	5.90 (150)
c2	with LA6DK20	6.10 (155)	6.10 (155)	6.10 (155)	6.10 (155)	6.10 (155)
c3	with LADT, R, S	6.61 (168)	6.61 (168)	6.61 (168)	6.61 (168)	6.61 (168)
	with LADT, R, S and sealing cover	6.77 (172)	6.77 (172)	6.77 (172)	6.77 (172)	6.77 (172)

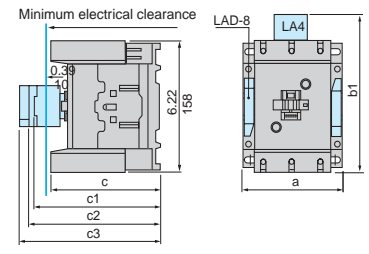

Selection: pages 142, 143 Characteristics: pages 84, 85 Schematics: pages 126, 127

TeSys™ D-Line Contactors and Starters Dimensions for Type LC1D Contactors

D-Line Contactors DC Control Circuit or Low Consumption

LC1D09 to D18 (3-pole)		LC1D25 to D38 (3-pole)					
LC1		D09 to D18	D093 to D183	D099 to D189	D25 to D38	D253 and D383	
b		3.03 (77)	3.89 (99)	3.30 (80)	3.34 (85)	3.89 (99)	
c	without cover or add-on blocks	3.66 (93)	3.66 (93)	3.66 (93)	3.89 (99)	3.89 (99)	
	with cover, without add-on blocks	3.76 (95)	3.76 (95)	3.76 (95)	3.97 (101)	3.97 (101)	
c1	with LADN or C (two or four contacts)	4.96 (126)	4.96 (126)	4.96 (126)	5.19 (132)	5.19 (132)	
c2	with LA6DK10	5.43 (138)	5.43 (138)	5.43 (138)	5.66 (144)	5.66 (144)	
c3	with LADT, R, S	5.76 (146)	5.76 (146)	5.76 (146)	5.98 (152)	5.98 (152)	
	with LADT, R, S and sealing cover	5.90 (150)	5.76 (146)	5.76 (146)	6.14 (156)	6.14 (156)	
LC1D20 to DT60 (4-pole)		DT20 and DT25 D098 and D128	DT203 and DT253 D0983 and D1283	DT32 to DT40 D188 to D258	DT323 and DT403 D1883 and D2583		
b		3.34 (85)	3.89 (99)	3.58 (91)	4.13 (105)		
c	with cover	3.56 (90)	3.56 (90)	3.54 (98)	3.54 (98)		
c1	with LADN or C (two or four contacts)	4.84 (123)	4.84 (123)	5.15 (131)	5.15 (131)		
c2	with LA6DK10	5.31 (135)	5.31 (135)	5.62 (143)	5.62 (143)		
c3	with LADT, R, S	5.62 (143)	5.62 (143)	5.94 (151)	5.94 (151)		
	with LADT, R, S and sealing cover	5.78 (147)	5.78 (147)	6.10 (155)	6.10 (155)		
LC1D40 to D65 (3-pole) LP1D65004, LP1D40008 to D65008 (4-pole)		LC1D80 and D95 (3-pole) LP1D80004, LP1D80008 (4-pole)					
LC1		LC1 D40 to D65	LP1D65004	LP1D40008 and D65008	LC1 D80 and D95	LP1 D80004	LP1 D80008
c	without cover or add-on blocks	6.73 (171)	6.73 (171)	7.46 (182)	7.40 (181)	7.40 (181)	–
	with cover, without add-on blocks	6.92 (176)	–	–	7.32 (186)	–	8.03 (204)
c1	with LADN (1 contact)	7.71 (196)	7.71 (196)	7.71 (196)	8.03 (204)	8.03 (204)	8.26 (210)
	with LADN or C (2 or 4 contacts)	7.95 (202)	7.95 (202)	7.95 (202)	8.26 (210)	8.26 (210)	8.70 (221)
c2	with LA6DK10	8.38 (213)	8.38 (213)	8.38 (213)	8.70 (221)	8.70 (221)	9.01 (229)
c3	with LADT, R, S	8.70 (221)	8.70 (221)	8.70 (221)	9.01 (229)	9.01 (229)	9.17 (233)
Selection: pages 92		Characteristics: pages 80 - 87		Schematics: pages 126, 127			

TeSys™ D-Line Contactors and Starters

Mounting Information for Type LC1D and LP1D Contactors

On mounting rail AM1DP200, DR200 or AM1DE200 (width 35 mm)
LC1D09 to D38, DT20 to DT60

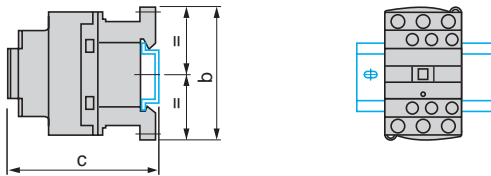

LC1	D09 to D18	D25 to D38	DT20 and DT25	DT32 to DT40
b	3.03 (77)	3.36 (85)	3.36 (85)	3.93 (100)
c (AM1DP200 or DR200) (1)	3.46 (88)	3.70 (94)	3.70 (94)	4.29 (109)
c (AM1DE200) (1)	3.77 (96)	4.01 (102)	4.01 (102)	4.60 (117)

dc control circuit

b	3.03 (77)	3.36 (85)	3.70 (94)	4.29 (109)
c (AM1DP200 or DR200) (1)	3.81 (97)	4.05 (103)	4.05 (103)	4.64 (118)
c (AM1DE200) (1)	4.13 (105)	4.33 (110)	4.37 (111)	4.84 (123)

(1) with safety cover

On two mounting rails DZ5MB at 120 mm center
LC1D115, D150

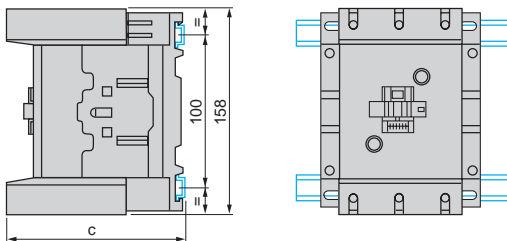

On two mounting rails DZ5MB at 120 mm center
LC1D40 to D95, LP1D40 to D80

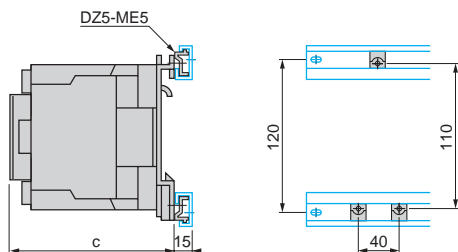

ac control circuit

LC1	D40 to D65	D80 and D95
c with cover	4.70 (119)	5.11 (130)

dc control circuit

LC1	D40 to D65	D80 and D95
c with cover	6.92 (176)	7.32 (186)
LP1	D40 and D65	D80
c	6.73 (171)	7.12 (181)

Selection: pages 88

Characteristics: pages 80 - 87

Schematics: pages 126, 127

On mounting rail AM1DL200 or DL201 (width 75 mm)
 On mounting rail AM1ED*** or AM1DE200 (width 35 mm)
LC1D40 to D95, LP1D40 to D80

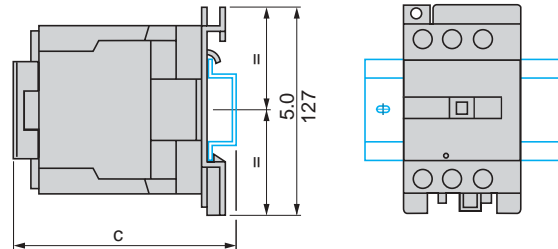

ac control circuit

LC1	D40 to D65	D80 and D95
c (AM1DL200) (1)	5.35 (136)	5.78 (147)
c (AM1DL201) (1)	4.96 (126)	5.39 (137)
c (AM1ED*** or DE200) (1)	4.96 (126)	5.39 (137)

dc control circuit

LC1	D40 to D65	D80 and D95
c (AM1DL200) (1)	7.59 (193)	7.99 (203)
c (AM1DL201) (1)	7.20 (183)	7.99 (203)

LP1	D40	D65	D80
c (AM1DL200)	7.40 (188)	7.40 (188)	7.78 (198)
c (AM1DL201)	7.00 (178)	7.00 (178)	7.78 (198)

(1) with safety cover

ac or dc control circuit

LC1	D115 and D150	D1156 and D1506
c (AM1DP200 or DR200)	134.5	117.5
c (AM1DE200 or ED***)	142.5	125.5

TeSys™ D-Line Contactors and Starters

Mounting Information for Type LC1D and LP1D Contactors

LC1D09 to D38 and LC1DT20 to DT60

On two mounting rails DZ5MB

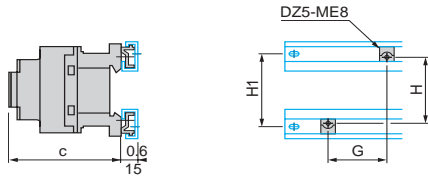

Control circuit:	ac		dc	
	D09 to D18	D25 to D38	D09 to D18	D25 to D38
LC1				
c with cover	3.38 (86)	3.62 (92)	3.76 (95)	3.97 (101)
G	1.37 (35)	1.37 (35)	1.37 (35)	1.37 (35)
H	2.36 (60)	2.36 (60)	2.36 (60)	2.36 (60)
H1	2.75 (70)	2.75 (70)	2.75 (70)	2.75 (70)
4-pole contactors				
Control circuit:	ac		dc	
	DT20 and DT25	DT32 to DT60	DT20 and DT25	DT32 to DT60
LC1				
c	3.62 (92)	3.93 (100)	3.97 (101)	4.29 (109)
G	5.31 (135)	1.57/1.96 (40/50)	1.37 (35)	1.37 (35)
H	2.36 (60)	2.36 (60)	2.36 (60)	2.36 (60)
H1	2.75 (70)	2.75 (70)	2.75 (70)	2.75 (70)

LC1D09 to D38 and LC1DT20 to DT60

On pre-slotted mounting plate AM1PA, PB, PC

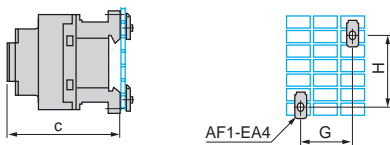

Control circuit:	ac		dc	
	D09 to D18	D25 to D38	D09 to D18	D25 to D38
LC1				
c with cover	3.38 (86)	3.62 (92)	3.76 (95)	3.97 (101)
G	1.37 (35)	1.37 (35)	1.37 (35)	1.37 (35)
c with cover	3.38 (86)	3.62 (92)	3.74 (95)	3.97 (101)
4-pole contactors				

LC1D40 to D95, LP1D40 to D80

On pre-slotted mounting plate AM1PA, PB, PC

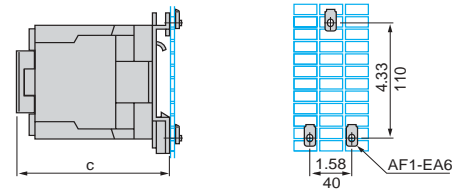

Control circuit:	ac				dc				
	DT20 and DT25	DT32 to DT60	DT20 and DT25	DT32 to DT60	LC1	D40 to D65	D80 and D95	D40 to D65	D80 and D95
LC1									
c	3.14 (80)	3.66 (93)	4.64 (118)	5.19 (132)	c with cover	4.68 (119)	5.11 (130)	6.92 (176)	7.32 (186)
G	1.37 (35)	1.37 (35)	1.37 (35)	1.37 (35)	LP1	-	-	D40 and D65	D80
H	2.36 (60)	2.36 (60)	2.36 (60)	2.36 (60)	c without cover	-	-	6.73 (171)	7.12 (181)

Note: Units with DC coils have round mounting holes ONLY and are spaced at 70 mm.

LC1D09 to D38 Panel mounted

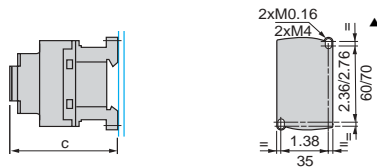

Control circuit:	ac		dc	
	D09 to D18	D25 to D38	D09 to D18	D25 to D38
LC1				
c with cover	3.38 (86)	3.62 (92)	3.76 (95)	3.97 (101)
4-pole contactors				

LC1D40 to D95, LP1D40 to D80 Panel mounted

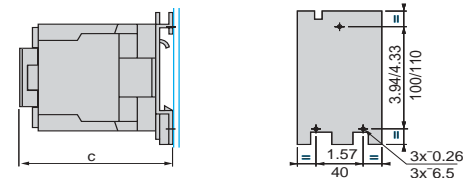

Control circuit:	ac				dc				
	DT20 and DT25	DT32 to DT60	DT20 and DT25	DT32 to DT60	LC1	D40 to D65	D80 and D95	D40 to D65	D80 and D95
LC1									
c with cover	3.54 (90)	3.85 (98)	3.54 (90)	3.85 (98)	c with cover	4.68 (119)	5.11 (130)	6.92 (176)	7.92 (186)
LP1	-	-	-	-	LP1	-	-	D40 and D65	D80
c without cover	-	-	-	-	c without cover	-	-	6.73 (171)	7.12 (181)

LC1D115, D150

Panel mounted

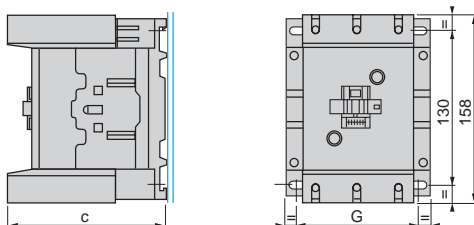

Control circuit:	D115	D1156	D150	D1506
LC1				
c	5.19 (132)	4.52 (115)	5.19 (132)	4.52 (115)
G (3-pole)	3.77/4.33 (96/110)	3.77/4.33 (96/110)	3.77/4.33 (96/110)	3.77/4.33 (96/110)
G (4-pole)	5.11/5.66 (130/144)	5.11/5.66 (130/144)	-	-

Selection: pages 88

Characteristics: pages 80 - 87

Schematics: pages 126, 127

▲ Units with DC coils have round mounting holes ONLY and are spaced at 70 mm.

TeSys™ D-Line Contactors and Starters

Schematics for Type LC1D Contactors

3-Pole Contactors

AC Magnetic 3-Pole Contactor with Overload Relay

LC1D09 to D150

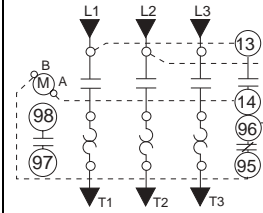
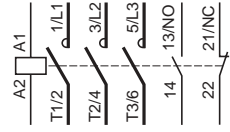

4-Pole Contactors

LC1 and LP1
D12004 to D80004
LC1D115004

LC1 and LP1
D12008 to D25008

LC1 and LP1
D40008 to D80008

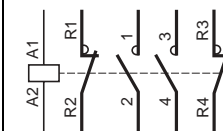
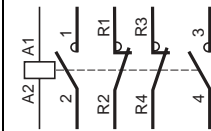
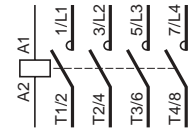

Front Mounting Add-on Contact Blocks Instantaneous Auxiliary Contacts

One N.O. LADN10 (1)	One N.C. LADN01 (1)	One N.O. + 1 N.C. LADN11	Two N.O. LADN20
Two N.C. LADN02	Two N.O. + two N.C. LADN22	One N.O. + three N.C. LADN13	Four N.O. LADN40
Four N.C. LADN04	Two N.O. + two N.C. including one N.O. + one N.C. make before break LADC22	Three N.O. + one N.C. LADN31	

Front Mounting Add-on Contact Blocks Instantaneous Auxiliary Contacts Conforming to Standard EN 50012

One N.O. + one N.C. LADN11G	One N.O. + one N.C. LADN11P	Two N.O. + two N.C. LADN22G	Two N.O. + two N.C. LADN22P

(1) Items in brackets are for blocks mounted on right-hand side of contactor.

Front Mounting Add-on Contact Blocks Dust and Damp Protected Instantaneous Auxiliary Contacts

Two N.O. (24-50 V) LA1DX20	Two N.C. (24-50 V) LA1DX02	Two N.O. (5-24 V) LA1DY20	Two N.O. protected (24-50 V) Two N.O. standard LA1DZ40

Front Mounting Add-on Contact Blocks Time-delay Auxiliary Contacts

On-delay one N.O. + one N.C. LADT	Off-delay one N.O. + one N.C. LADR	On-delay N.C. with one N.O. break before make LADS

Mechanical Latch Blocks

LA6DK10 and LA6DK20

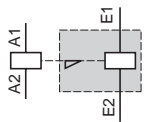

Side Mounting Add-on Contact Blocks Instantaneous Auxiliary Contacts

One N.O. + one N.C. LAD8N11 (1)	Two N.O. LAD8N20 (1)	Two N.C. LAD8N02 (1)

(1) Items in Brackets are for Blocks Mounted on Right-hand Side of Contactor

Electronic serial timer modules

On-delay LA4DT•U

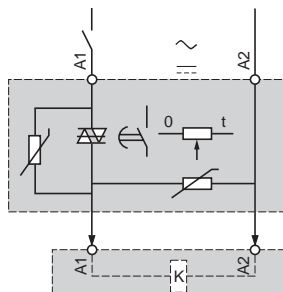

Auto-Man-Stop modules

LA4DM• (1) PLC

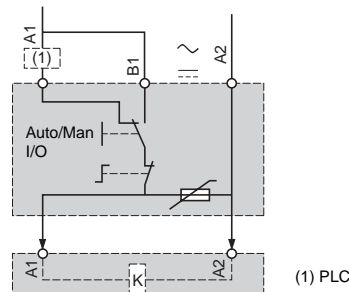

Interface Modules

Relay interface
LA4DF•

LA4DFBQ

Relay interface with
override switch LA4DL•

Solid state
LA4DWB•

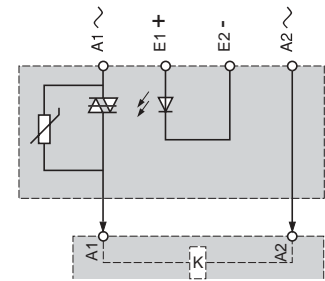
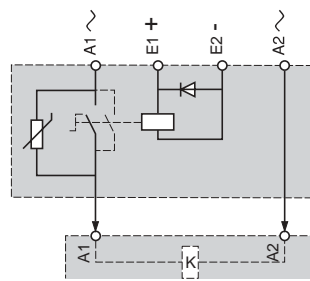
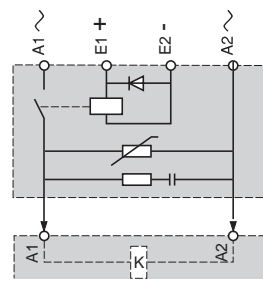
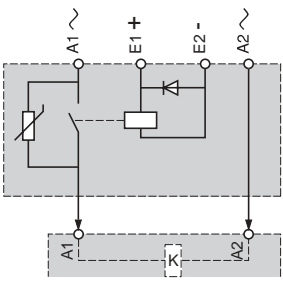

TeSys™ D-Line Contactors and Starters

Dimensions for Type LC2D Contactors

LC2D09 to D38
2 x LC1D09 to D38

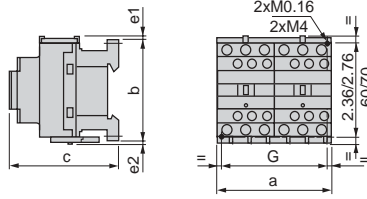

LC2DT20 to DT60
2 x LC1DT20 to DT60

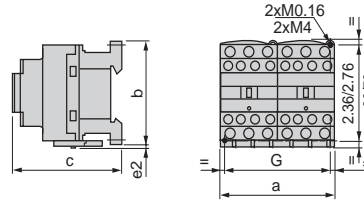

LC2 or 2 x LC1	a	b	c (1)	e1	e2	G
D09 to D18 ac	3.54 (90)	3.03 (77)	3.38 (86)	0.15 (4)	0.05 (1.5)	3.14 (80)
D093 to D183 ac	3.54 (90)	3.89 (99)	3.38 (86)	–	–	3.14 (80)
D09 to D18 dc	3.54 (90)	3.03 (77)	3.74 (95)	0.15 (4)	0.05 (1.5)	3.14 (80)
D093 to D183 dc	3.54 (90)	3.89 (99)	3.74 (95)	–	–	3.14 (80)
D12004	–	2.91 (74)	3.14 (80)	–	0.23 (6)	3.74 (95)
D25 to D38 ac	3.54 (90)	3.34 (85)	3.62 (92)	0.35 (9)	0.19 (5)	3.14 (80)
D253 to D383 ac	3.54 (90)	3.89 (99)	3.62 (92)	–	–	3.14 (80)
D25 to D32 dc	3.54 (90)	3.34 (85)	3.97 (101)	0.35 (9)	0.19 (5)	3.14 (80)
D253 to D383 dc	3.54 (90)	3.89 (99)	3.97 (101)	–	–	3.14 (80)
D25004	–	3.30 (84)	3.66 (93)	–	0.22 (7)	4.37 (111)

LC2 or 2 x LC1	a	b	c	G
DT20 and DT25	3.54 (90)	3.34 (85)	3.54 (90)	3.14 (80)
DT32 to DT60	3.54 (90)	3.58 (91)	3.85 (98)	3.14 (80)

e1 and e2: including cabling.
(1) With safety cover, without add-on block.

c, e2: including cabling.

LC2D40 to D65
2 x LC1D40 to D65

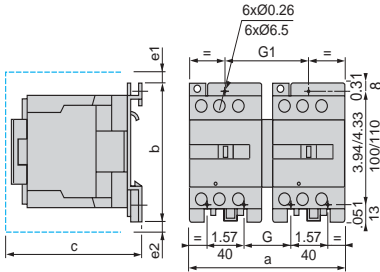

LC2 or 2 x LC1	a	b	c	e1	e2	G	G1
D40 to D65	6.49 (165)	5.0 (127)	5.6 (142)	0.49 (5)	–	1.96 (50)	3.54 (90)
D40004	7.16 (182)	5.0 (127)	5.2 (133)	–	0.78 (11)	2.24 (57)	3.81 (97)
D65004	7.16 (182)	5.0 (127)	5.2 (133)	–	0.78 (11)	2.24 (57)	3.81 (97)
D80 and D95	7.16 (182)	5.0 (127)	6.2 (158)	0.5 (13)	–	2.24 (57)	3.77 (96)
D80004	8.14 (207)	5.0 (127)	6.2 (158)	–	1.78 (20)	2.79 (71)	4.37 (111)

2 x LP1D40 and D65

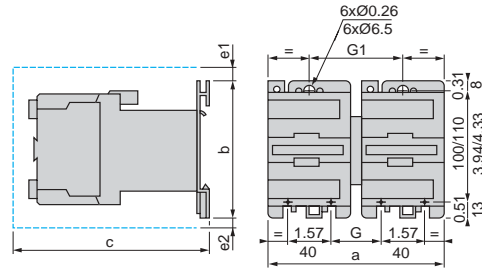

LC2 or 2 x LC1	a	b	c	e1	e2	G	G1
D40 to D65	7.16 (182)	5.0 (127)	7.4 (190)	1.19 (5)	0.43 (11)	2.2 (57)	3.8 (97)
D80 and D95	8.14 (207)	11.0 (127)	8.4 (215)	0.51 (13)	0.78 (20)	3.7 (96)	4.3 (111)

c, e1 and e2: including cabling.

c, e1 and e2: including cabling.

LC2D115 and D150
2 x LC1D115 and D150

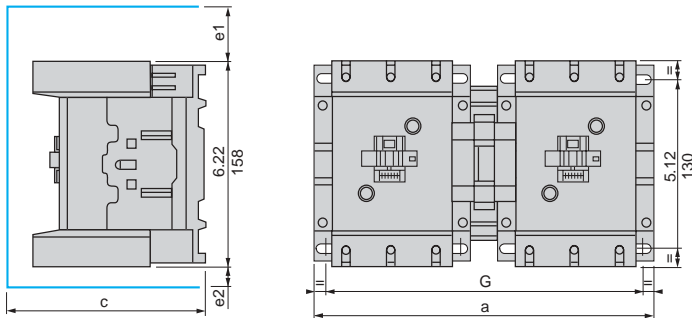

LC2 or 2 x LC1	a	c	e1	e2	G
D115, D150	10.5 (266)	5.9 (148)	2.2 (56)	0.7 (18)	9.5/10.0 (242/256)
D115004	13.1 (334)	5.9 (148)	–	2.4 (60)	12.2/12.7 (310/324)

c, e1 and e2: including cabling.

Selection: pages 93

Characteristics: pages 80, 87

Schematics: pages 129

TeSys™ D-Line Contactors and Starters Schematics for Type LC2D Contactors

Reversing contactors for motor control, horizontally mounted LC2D09 to D150

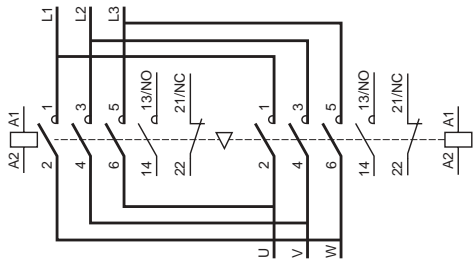

Reversing contactors for motor control with integral electrical interlocking (LAD9R1V)

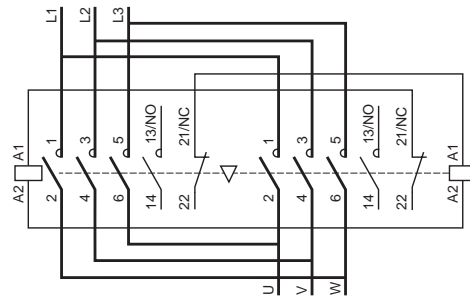

Reversing contactor with overload relay

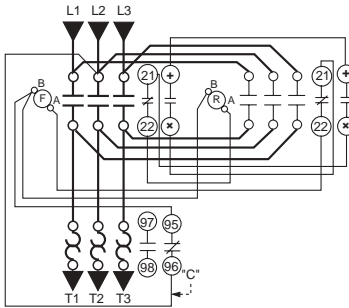

Changeover contactor pairs, horizontally mounted LC2DT20 to DT60

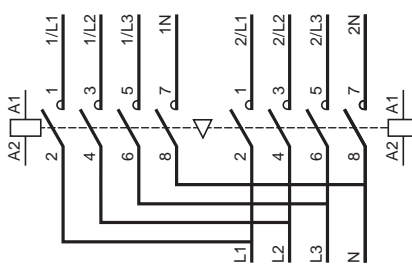

Electrical interlocking of contactors using:
mechanical interlock with integral electrical contacts LA9D***02

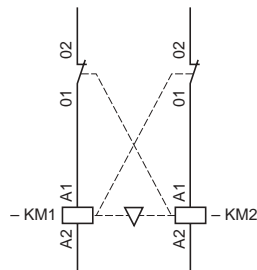
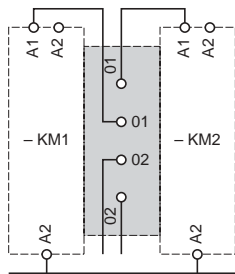

Mechanical interlock without integral electrical contacts LA9D***78, LAD9R1

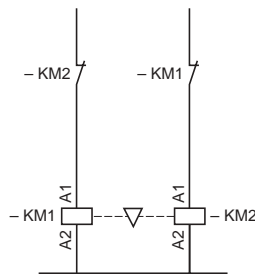

Low speed - High speed cabling kit

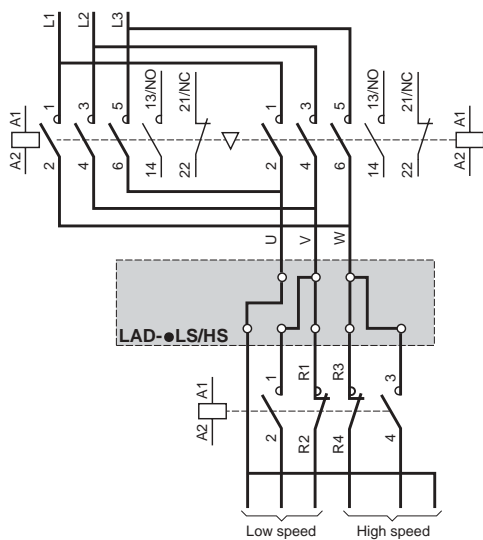

TeSys™ D-Line Contactors and Starters

LR2 and LR3D 3-pole Bimetallic Overload Relays

Description

D-Line 3-pole thermal overload relays are designed to protect ac circuits and motors against overloads, phase failure, long starting times and prolonged stalling of the motor.

LRD01 to 35

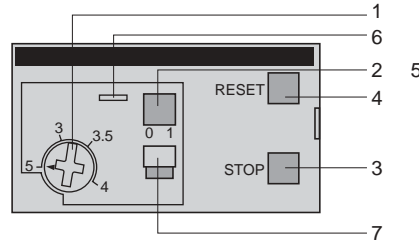

LRD3322 to 4369, LR2D

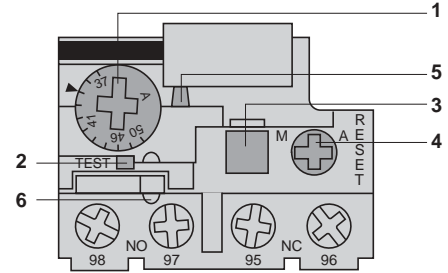

- 1 Adjustment dial Ir
- 2 Test button
Operation of the Test button allows:
 - checking of control circuit wiring,
 - simulation of relay tripping (actuates both the N.O. and N.C. contacts).
- 3 Stop button. Actuates the N.C. contact; does not affect the N.O. contact.
- 4 Reset button
- 5 Trip indicator
- 6 Setting locked by sealing the cover.
- 7 Selector for manual or automatic reset. Relays LRD01 to LRD35 are supplied with the selector in the manual position, protected by a cover. Deliberate action is required to move it to the automatic position.

Environment

Conforming to standards			IEC 60947-1, IEC 60947-4-1, NF C 63-650, VDE 0660, BS 4941
Product certifications			CSA, UL, Sichere Trennung, PTB except LAD4: UL, CSA.
Degree of protection	Conforming to VDE 0106		Protection against direct finger contact IP 2X
Protective treatment	Conforming to IEC 60068		"TH"
Ambient air temperature around the device	Storage	°C	- 60 to + 70 (- 140 to + 158 °F)
	Normal operation, without derating (IEC 60947-4-1)	°C	- 20 to + 60 (- 68 to + 140 °F)
	Minimum and maximum operating temperatures (with derating)	°C	- 40 to + 70 (- 104 to + 158 °F)
Operating positions without derating	In relation to normal, vertical mounting plane		Any position
Shock resistance	Permissible acceleration conforming to IEC 60068-2-7		15 gn - 11 ms
Vibration resistance	Permissible acceleration conforming to IEC 60068-2-6		6 gn
Dielectric strength at 50 Hz	Conforming to IEC 60255-5	kV	6
Impulse withstand voltage	Conforming to IEC 60801-5	kV	6

Auxiliary Contact Characteristics

Conventional rated thermal current		A	5 Amps AC; 1 Amp DC					
Maximum consumption of operating coils of controlled contactors (Occasional operating cycles of contact 95-96)	ac supply	V	24	48	110	220	380	600
		VA	100	200	400	600	600	600
	dc supply	V	24	48	110	220	440	—
		W	100	100	50	45	25	—
Short-circuit protection ●	By gG, BS or Class CC fuse. Max. rating or by GB2 circuit-breaker	A	5 maximum					
Connection to screw clamp terminals			Min - max c.s.a.					
Flexible cable with cable end	One or two conductors	AWG (mm ²)	18 - 14 (1 - 2.5)					
Solid cable without cable end	One or two conductors	AWG (mm ²)	18 - 14 (1 - 2.5)					
Flexible cable without cable end	One or two conductors	AWG (mm ²)	18 - 14 (1 - 2.5)					
Solid cable without cable end	One or two conductors	AWG (mm ²)	18 - 14 (1 - 2.5)					
Tightening torque		lb-in (N.m)	15 (1.7)					

- Select short circuit protection to meet the National Electrical Code or other local codes and standards.

Catalog Numbers: pages 134, 135 Dimensions: pages 138 - 140

TeSys™ D-Line Contactors and Starters LR2 and LR3D 3-pole Bimetallic Overload Relays

Electrical Characteristics of Power Circuit

Relay type			LRD 01 to 16 LR3 D01 to D16	LR2 D15••	LRD 21 to 35 LR3 D21 to D35	LR2 D25••	LRD 3322 to 33696 LR3 D3322 to D33696	LR2 D35••	LRD 4365 to 4369
Tripping class	To UL 508, IEC 60947-4-1		10	20	10	20	10	20	10
Rated insulation voltage (Ui)	Conforming to IEC 60947-4-1	V	690		690		1000		1000
	Conforming to UL, CSA	V	600		600		600		600 except LRD4369
Rated impulse withstand voltage (Uimp)		kV	6		6		6		6
Frequency limits	Of the operational current	Hz	0 to 400		0 to 400		0 to 400		0 to 400
Setting range	Depending on model	A	0.1 to 13		12 to 38		17 to 104		80 to 140

Connection to screw clamp terminals

Min - max c.s.a.

		AWG (mm ²)	14 - 8 (1.5 - 10)	14 - 8 (1.5 - 10)	10 - 2 (4 - 35)	10 - 1 (4 - 50)
Flexible cable without cable end	One conductor	AWG (mm ²)	14 - 8 (1.5 - 10)	16 - 10 (1 - 6) except LRD21: 16 - 12 (1 - 4)	10 - 2 (4 - 35)	10 - 2 (4 - 35)
Flexible cable with cable end	One conductor	AWG (mm ²)	16 - 10 (1 - 6)	14 - 8 (1.5 - 10) except LRD21: 16 - 10 (1 - 6)	12 - 2 (4 - 35)	10 - 1 (4 - 50)
Solid cable without cable end	One conductor	AWG (mm ²)	15.0 (1.7)	16.4 (1.85)	22.1 (2.5)	100 lb-in
Tightening torque		lb-in (N.m)				100 lb-in

Connection to spring terminals

Min - max c.s.a.

		AWG (mm ²)	14 - 12 (1.5 - 4)	-	14 - 12 (1.5 - 4)	-	-	-	-
Flexible cable without cable end	One conductor	AWG (mm ²)	14 - 12 (1.5 - 4)	-	14 - 12 (1.5 - 4)	-	-	-	-
Solid cable without cable end	One conductor	AWG (mm ²)	14 - 12 (1.5 - 4)	-	14 - 12 (1.5 - 4)	-	-	-	-

Operating Characteristics

Temperature compensation		°C °F	- 20 to + 60 - 68 to + 140	- 30 to + 60 - 86 to + 140	- 30 to + 60 - 86 to + 140	- 20 to + 60 - 68 to + 140
Tripping threshold	Conforming to IEC 60947-4-1	A	1.14 ± 0.06 In			
Sensitivity to phase failure	Conforming to IEC 60947-4-1		Tripping current 30% of In on one phase, the others at In			

Tripping curves

Average operating time
related to multiples of the
current setting

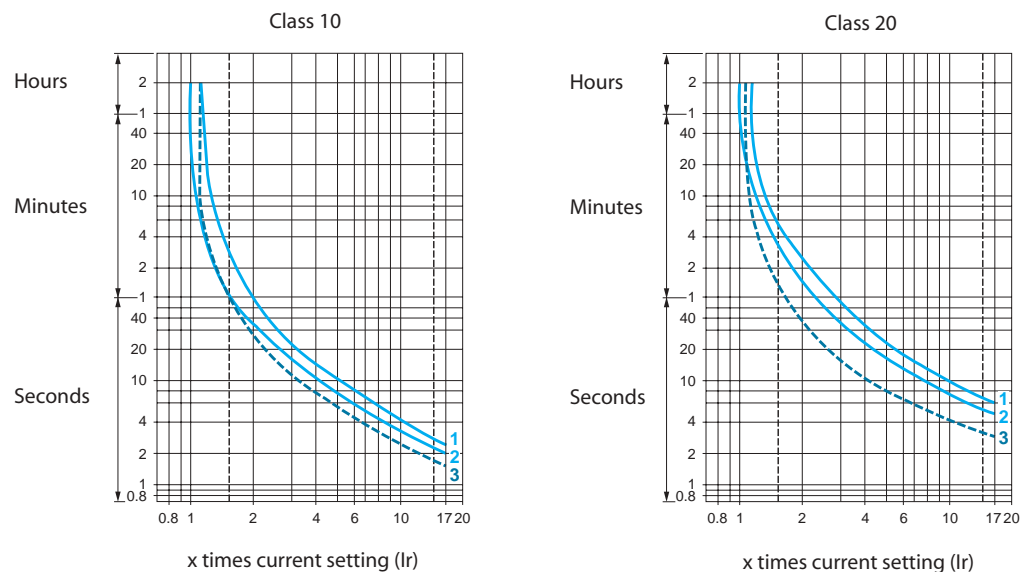

- 1 Balanced operation, 3-phase, from cold state.
- 2 Balanced operation, 2-phase, from cold state.
- 3 Balanced operation, 3-phase, after a long period at the set current (hot state).

Catalog Numbers: pages 134, 135

Dimensions: pages 138 - 140

TeSys™ D-Line Contactors and Starters

LR9D 3-pole Solid-state Overload Relays

Description

	<p>LR9D electronic thermal overload relays are designed for use with contactors LC1D115 and D150.</p> <p>In addition to the protection provided by model d thermal overload relays, (see page 130), they offer the following special features:</p> <ul style="list-style-type: none"> ● Protection against phase imbalance. ● Choice of starting class. ● Protection of unbalanced circuits. ● Protection of single-phase circuits. ● Alarm function to avoid tripping by load shedding. 	
	<p>LR9D5367 to D5569</p>	<p>LR9D67 and D69</p>

Environment

Conforming to standards			IEC 60947-4-1, 255-8, 255-17, VDE 0660 and EN 60947-4-1
Product certifications			UL 508, CSA 22-2
Degree of protection	Conforming to IEC 60529 and VDE 0106		IP 20 on front face with protective covers LA9D11570• or D11560•
Protective treatment	Standard version		"TH"
Ambient air temperature around the device (conforming to IEC 60255-8)	Storage	°C	- 40 to + 85 (- 104 to + 185 °F)
	Normal operation	°C	- 20 to + 55 (1) (- 68 to + 131 °F)
Maximum operating altitude	Without derating	ft/m	6562 (2000)
Operating positions without derating	In relation to normal, vertical mounting plane		Any position
Shock resistance	Permissible acceleration conforming to IEC 60068-2-27		13 gn - 11 ms
Vibration resistance	Permissible acceleration conforming to IEC 60068-2-6		2 gn - 5 to 300 Hz
Dielectric strength at 50 Hz	Conforming to IEC 60255-5	kV	6
Impulse withstand voltage	Conforming to IEC 61000-4-5	kV	6
Resistance to electrostatic discharge	Conforming to IEC 61000-4-2	kV	8
Resistance to radio-frequency conducted disturbances	Conforming to IEC 61000-4-3 and NF C 46-022	V/m	10
Resistance to fast transient currents	Conforming to IEC 61000-4-4	kV	2
Electromagnetic compatibility	Draft EN 50081-1 and 2, EN 50082-2	V	Meets requirements

Electrical characteristics of auxiliary contacts

Conventional thermal current		A	5					
Maximum consumption of operating coils of controlled contactors (Occasional operating cycles of contact 95-96)	ac supply	V	24	48	110	220	380	600
		VA	100	200	400	600	600	600
	dc supply	V	24	48	110	220	440	–
		W	100	100	50	45	25	–
Short-circuit protection ●	By gG, BS or Class CC fuse or by GB2 circuit-breaker	A	5					
Cabling	One or two conductors	AWG (mm²)	Minimum c.s.a.: 16 (1) / maximum c.s.a.: 14 (2.5)					
Flexible cable without cable end	Tightening torque	lb-in (N.m)	11 (1.2)					

- (1) For operation at 70 °C (158 °F), please consult your Regional Sales Office.
- Select short circuit protection to meet the National Electrical Code or other local codes and standards.

Catalog Numbers: pages 135

Dimensions: pages 138

TeSys™ D-Line Contactors and Starters LR9D 3-pole Solid-state Overload Relays

Electrical Characteristics of Power Circuit

Relay Type		LR9-D
Tripping Class	Conforming to UL 508, IEC 60947-4-1	10 or 20
Rated Insulation Voltage (Ui)	Conforming to IEC 60947-4-1	1000 V
	Conforming to UL, CSA	600 V
Rated Impulse Withstand Voltage (Uimp)		8 kV
Frequency Limits	Of the operational current	50-60 Hz For other frequencies, consult your Regional Sales Office. (1)
Setting Range	Depending on model	60-150 A
Power Circuit Connections	Width of terminal lug	0.787 in (20 mm)
	Clamping screw	M8
	Tightening torque	lb-ft 13 (18 N•m)

Operating Specifications

Temperature Compensation		-20 to +70 °C (- 68 to + 158 °F)
Tripping Threshold	Conforming to IEC 60947-4-1 Alarm	1.05 ± 0.06 In A
	Tripping	1.12 ± 0.06 In A
Sensitivity to Phase Failure	Conforming to IEC 60947-4-1	Tripping current 4 s ± 20% in the event of phase failure

Alarm Circuit Specifications

Rated Supply Voltage	dc supply	24 Vdc
Supply Voltage Limits		17 - 32 V
Current Consumption	No load	less than or equal to 5 mA
Switching Capacity		0 - 150 mA
Protection	Short-circuit and overload	Self-protected
Voltage Drop	Closed state	less than or equal to 2.5 V
Cabling	Flexible cable without cable end	20 - 16 AWG (0.5 - 1.5 mm ²)
Tightening Torque		4.0 lb-in (0.45 N•m)

Tripping Curve LR9-D

Average Operating Time Related to Multiples of the Current Setting

Tripping time in seconds

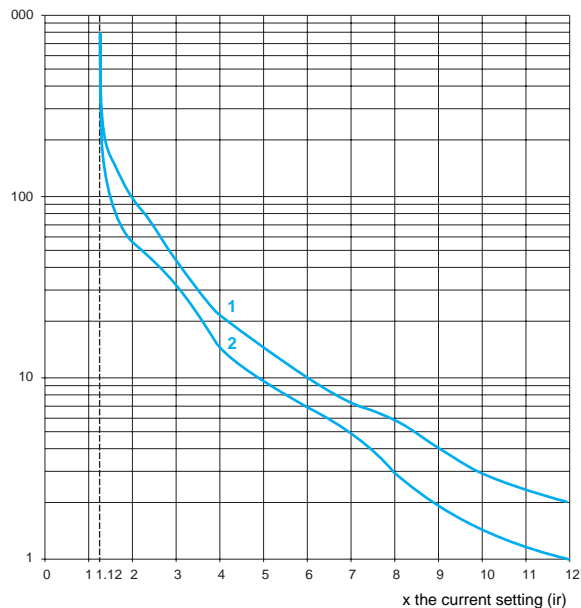

- 1 Cold state curve.
- 2 Hot state curve.

(1) For use of these relays with soft start units or variable speed controllers, please consult your Regional Sales Office.

Catalog Numbers: pages 135

Dimensions: pages 138

TeSys™ D-Line Contactors and Starters

Selection of 3-pole Class 10 Bimetallic Overload Relays

Differential (Single Phase Sensitive) Thermal Overload Relays

Compensated Relays with Manual or Automatic Reset, with Relay Trip Indicator, for ac or dc.

Short-circuit Protection for North American Applications			By Circuit Breaker	Select in Accordance with NEC and Local Codes
			By Fuses	

Relay Setting Range	Fuses to be used with Selected Relay			For use with Contactor LC1-	Catalog Number	Weight lb. (kg)
	aM	gG	BS88			

Class 10 with Connection by Screw Clamp Terminals

Relay Setting Range	aM	gG	BS88	For use with Contactor LC1-	Catalog Number	Weight lb. (kg)
A	A	A	A			
Class 10 with Connection by Screw Clamp Terminals						
0.10 to 0.16	0.25	2	–	D09 to D38 (2)	LRD01	0.27 (0.124)
0.16 to 0.25	0.5	2	–	D09 to D38 (2)	LRD02	0.27 (0.124)
0.25 to 0.40	1	2	–	D09 to D38 (2)	LRD03	0.27 (0.124)
0.40 to 0.63	1	2	–	D09 to D38 (2)	LRD04	0.27 (0.124)
0.63 to 1	2	4	–	D09 to D38 (2)	LRD05	0.27 (0.124)
1 to 1.6	2	4	6	D09 to D38 (2)	LRD06	0.27 (0.124)
1.6 to 2.5	4	6	10	D09 to D38 (2)	LRD07	0.27 (0.124)
2.5 to 4	6	10	16	D09 to D38 (2)	LRD08	0.27 (0.124)
4 to 6	8	16	16	D09 to D38 (2)	LRD10	0.27 (0.124)
5.5 to 8	12	20	20	D09 to D38 (2)	LRD12	0.27 (0.124)
7 to 10	12	20	20	D09 to D38 (2)	LRD14	0.27 (0.124)
9 to 13	16	25	25	D12 to D38 (2)	LRD16	0.27 (0.124)
12 to 18	20	35	32	D18 to D38 (2)	LRD21	0.27 (0.124)
16 to 24	25	50	50	D25 to D38 (2)	LRD22	0.27 (0.124)
23 to 32	40	63	63	D25 to D38 (2)	LRD32	0.27 (0.124)
30 to 38	50	80	80	D32 and D38 (2)	LRD35	0.27 (0.124)
17 to 25	25	50	50	D40 to D95	LRD3322	1.12 (0.510)
23 to 32	40	63	63	D40 to D95	LRD3353	1.12 (0.510)
30 to 40	40	100	80	D40 to D95	LRD3355	1.12 (0.510)
37 to 50	63	100	100	D40 to D95	LRD3357	1.12 (0.510)
48 to 65	63	100	100	D50 to D95	LRD3359	1.12 (0.510)
55 to 70	80	125	125	D50 to D95	LRD3361	1.12 (0.510)
63 to 80	80	125	125	D65 to D95	LRD3363	1.12 (0.510)
80 to 104	100	160	160	D80 and D95	LRD3365	1.12 (0.510)
80 to 104	125	200	160	D115 and D150	LRD4365	1.98 (0.900)
95 to 120	125	200	200	D115 and D150	LRD4367	1.98 (0.900)
110 to 140	160	250	200	D150	LRD4369	1.98 (0.900)
80 to 104	100	160	160	D115 and D150	LRD33656 (1)	2.20 (1.000)
95 to 120	125	200	200	D115 and D150	LRD33676 (1)	2.20 (1.000)
110 to 140	160	250	200	D115 and D150	LRD33696 (1)	2.20 (1.000)

Class 10 with Spring Terminal Connections (for direct mounting on the contactor only)

Relay Setting Range	aM	gG	BS88	For use with Contactor LC1-	Catalog Number	Weight lb. (kg)
0.10 to 0.16	0.25	2	–	D09 to D38 (2)	LRD013	6.31 (0.140)
0.16 to 0.25	0.5	2	–	D09 to D38 (2)	LRD023	6.31 (0.140)
0.25 to 0.40	1	2	–	D09 to D38 (2)	LRD033	6.31 (0.140)
0.40 to 0.63	1	2	–	D09 to D38 (2)	LRD043	6.31 (0.140)
0.63 to 1	2	4	–	D09 to D38 (2)	LRD053	6.31 (0.140)
1 to 1.6	2	4	6	D09 to D38 (2)	LRD063	6.31 (0.140)
1.6 to 2.5	4	6	10	D09 to D38 (2)	LRD073	6.31 (0.140)
2.5 to 4	6	10	16	D09 to D38 (2)	LRD083	6.31 (0.140)
4 to 6	8	16	16	D09 to D38 (2)	LRD103	6.31 (0.140)
5.5 to 8	12	20	20	D09 to D38 (2)	LRD123	6.31 (0.140)
7 to 10	12	20	20	D09 to D38 (2)	LRD143	6.31 (0.140)
9 to 13	16	25	25	D12 to D38 (2)	LRD163	6.31 (0.140)
12 to 18	20	35	32	D18 to D38 (2)	LRD213	6.31 (0.140)
16 to 24	25	50	50	D25 to D38 (2)	LRD223	6.31 (0.140)

Class 10 with Ring-Tongue Terminals for LRD01 through LRD35 (load side terminals only)

Select the appropriate overload relay with screw clamp terminals from the table above and add **6** to the end of the reference.

Example: LRD01 becomes LRD016.

Thermal Overload Relays for use on single phase loads

Class 10 with connection by screw clamp terminals

Change the prefix in the references above from LRD (except LRD4●●●) to LR3D. Example: LRD01 becomes LR3D01.

Thermal Overload Relays for use on 1000 V Supplies

Class 10 with connection by screw clamp terminals

For relays LRD-01 to LRD-35 only, for an operating voltage of 1000 V, and only for independent mounting, the reference becomes LRD33 A66. Example: LRD12 becomes LRD3312A66.

Order an LA7D3064 terminal block separately; see page 137.

- (1) These are special separate mounted versions of the LRD43 overload relays for the LC1D115 and D150 contactors. Part number includes overload relay, terminal block and 6 connectors (unit is not UL/CSA approved).
- (2) When used with D25-D38 contactors, order spacer clip (part number W816366180111). See page 137.



LRD08



LRD21



LRD33



LRD083

TeSys™ D-Line Contactors and Starters

Selection of 3-pole Class 20 Bimetallic and Class 10 Solid-state Overload Relays

Differential (Single Phase Sensitive) Thermal Overload Relays

Compensated relays with manual or automatic reset, with relay trip indicator, for ac or dc LR2-D1508 to 2553: independent mounting either by ordering a terminal block LA7D1064 or LA7D2064, or by ordering the relay pre-assembled; in this case, add the suffix LA7 to the reference.
Example: LR2D1508 becomes LR2D1508LA7.

Short-circuit Protection for North American Applications				By Circuit Breaker		Select in Accordance with NEC and Local Codes	
				By Fuses		Maximum 400% of Motor FLA	
Relay Setting Range	Fuses to be used with the Selected Relay			For use with Contactor		Catalog Number	Weight lb. (kg)
	aM	gG	BS88	LC1			
A	A	A	A				

Class 20 for Connection by Screw Clamp Terminals

2.5 to 4	6	10	16	D09 to D38 (2)	LRD1508 (3)	0.42 (0.190)
4 to 6	8	16	16	D09 to D38 (2)	LRD1510 (3)	0.42 (0.190)
5.5 to 8	12	20	20	D09 to D38 (2)	LRD1512 (3)	0.42 (0.190)
7 to 10	16	20	25	D09 to D38 (2)	LRD1514 (3)	0.42 (0.190)
9 to 13	16	25	25	D12 to D38 (2)	LRD1516 (3)	0.42 (0.190)
12 to 18	25	35	40	D18 to D38 (2)	LRD1521 (3)	0.42 (0.190)
17 to 25	32	50	50	D25 and D38 (2)	LRD1522 (3)	0.42 (0.190)
23 to 28	40	63	63	D25 and D38 (2)	LRD1530 (3)	0.76 (0.345)
25 to 32	40	63	63	D25 and D38 (2)	LRD1532 (3)	0.76 (0.345)
17 to 25	32	50	50	D40 to D95	LRD3522	1.18 (0.535)
23 to 32	40	63	63	D40 to D95	LRD3553	1.18 (0.535)
30 to 40	50	100	80	D40 to D95	LRD3555	1.18 (0.535)
37 to 50	63	100	100	D50 to D95	LRD3557	1.18 (0.535)
48 to 65	80	125	100	D50 to D95	LRD3559	1.18 (0.535)
55 to 70	100	125	125	D65 to D95	LRD3561	1.18 (0.535)
63 to 80	100	160	125	D80 and D95	LRD3563	1.18 (0.535)



LRD15

Solid-state Differential Thermal Overload Relays

Compensated relays, with relay trip indicator, for ac or dc, for direct mounting on contactor or independent mounting (1).

Relay Setting Range	Fuses to be used with Selected Relay (4)		For Direct Mounting Beneath Contactor LC1	Catalog Number	Weight lb. (kg)
	aM	gG			
A	A	A			

Class 10 for Connection using Bars or Connectors

60 to 100	100	160	D115 and D150	LR9D5367	1.95 (0.885)
90 to 150	160	250	D115 and D150	LR9D5369	1.95 (0.885)

Class 20 for Connection using Bars or Connectors

60 to 100	125	160	D115 and D150	LR9D5567	1.95 (0.885)
90 to 150	200	250	D115 and D150	LR9D5569	1.95 (0.885)

Solid-state Thermal Overload Relays for use with Balanced/Unbalanced Loads (Single Phase)

Compensated relays, with separate outputs for alarm and tripping.

Relay Setting Range	Fuses to be used with Selected Relay (4)		For Direct Mounting Beneath Contactor LC1	Catalog Number	Weight lb. (kg)
	aM	gG			
A	A	A			

Class 10 or 20 Selectable with Connection using Bars or Connectors

60 to 100	100	160	D115 and D150	LR9D67	1.98 (0.900)
90 to 150	160	250	D115 and D150	LR9D69	1.98 (0.900)

- (1) Power terminals can be protected against direct finger contact by the addition of shrouds and/or insulated terminal blocks, to be ordered separately (see page 113).
- (2) For use with D25-D38 contactors, order spacer clip (part number W816366180111). See page 137.
- (3) These overloads are available without single phase sensitivity. To order, change the LRD prefix to LR3D and add A1 to the end of the number. Example: LRD1508 becomes LR3D1508A1
- (4) Select short circuit protection to meet the National Electrical Code or other local codes and standards.

Other Versions Thermal overload relays for resistive circuits in category AC-1. Please consult your Regional Sales Office.



LR2D35

TeSys™ D-Line Contactors and Starters

Selection of Overload Relay Accessories

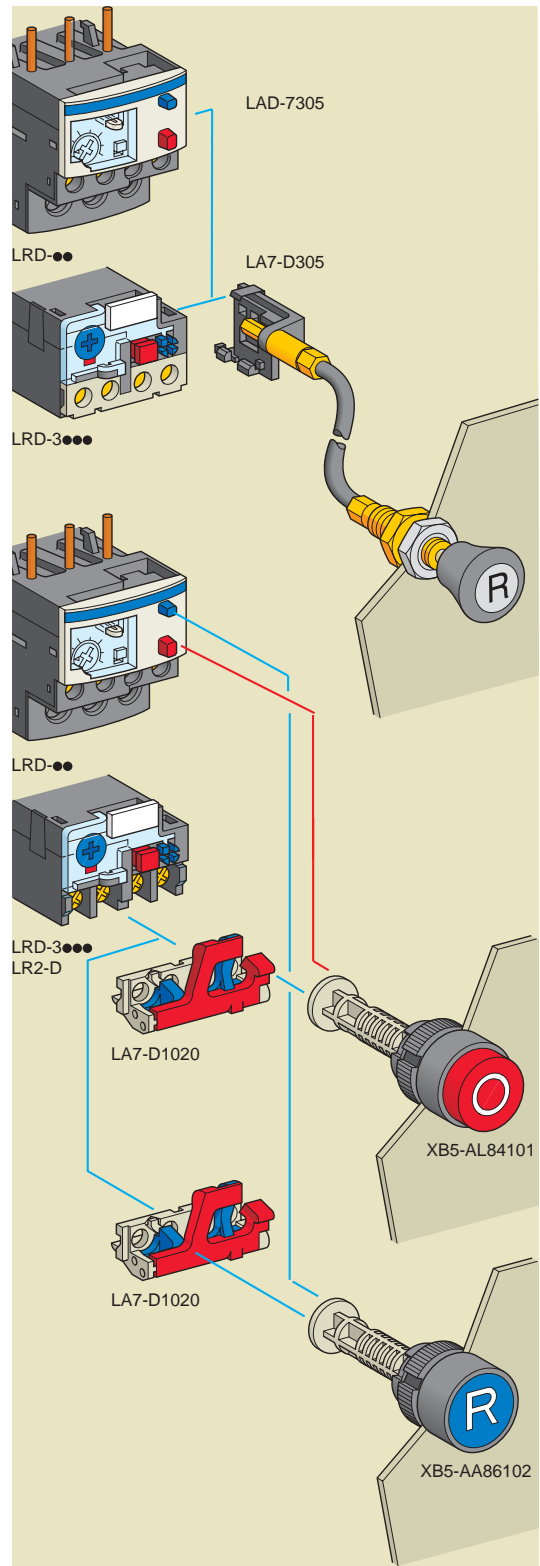
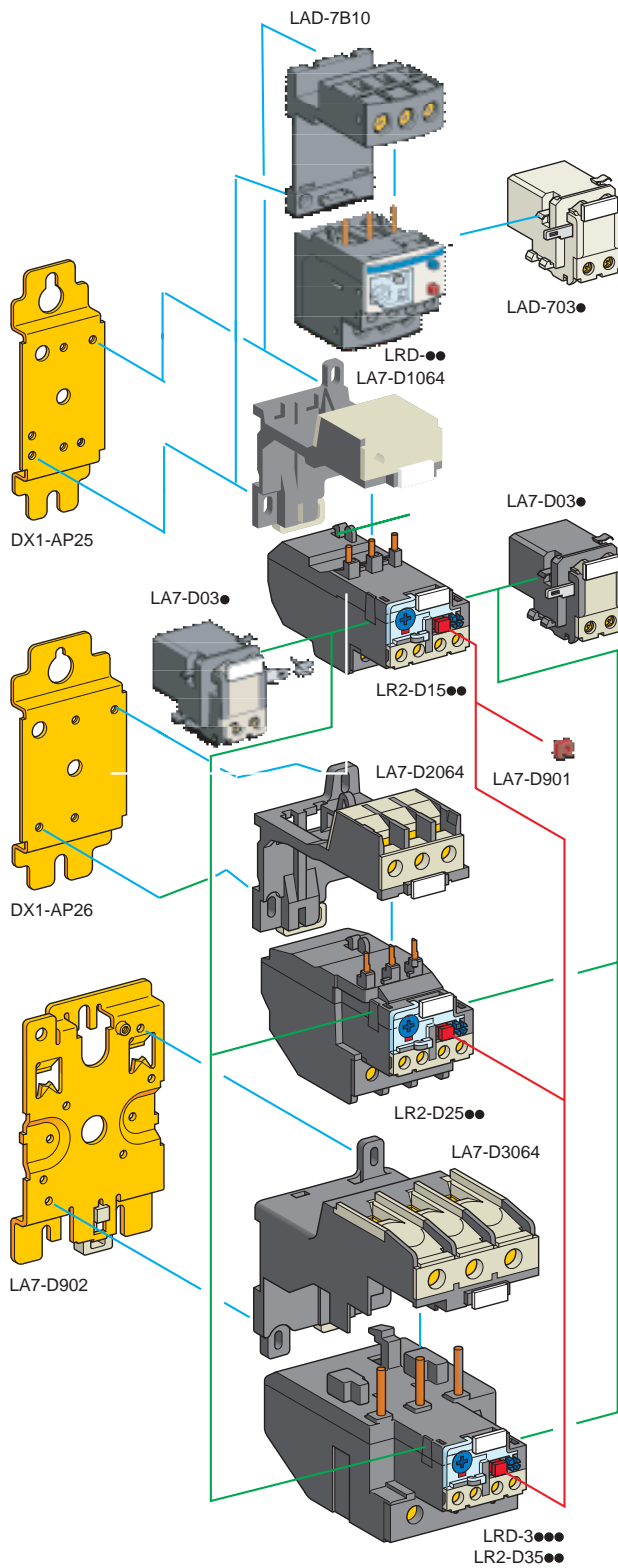

TeSys™ D-Line Contactors and Starters

Selection of Overload Relay Accessories

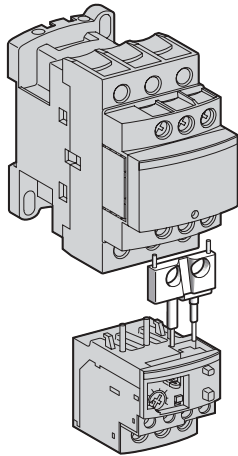

LAD7C

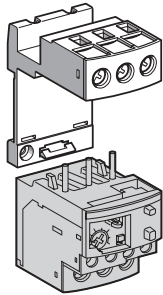

LAD7B10



Overload Relay and Spacer (W816366180111)

Accessories (to be ordered separately)

Description	For use on:	Sold in Lots of:	Catalog Number	Weight lb. (kg)
Pre-wiring kit allowing direct connection of the N.C. contact of relay LRD01 to 35 or LR3D01 to D35 to the contactor	LC1D09 to D18	10	LAD7C1	0.002 (0.004)
	LC1D25 to D38	10	LAD7C2	0.003 (0.007)
Separate Mount Kits	LRD01 to 35 and LR3D01 to D35	1	LAD7B10	0.100 (0.22)
Terminal blocks (1) for separate mounting on 35 mm rail (AM1DP200) or screw mounting; for mounting centers, see pages 138 to 140.	LRD15●●	1	LAD7B105	0.100 (0.22)
	LR2D15●●	1	LA7D1064	0.100 (0.22)
	LR2D25●●	1	LA7D2064	0.120 (0.26)
	LRD3●●●, LR3D3●●●, LR2D35●●	1	LA7D3064 (2)	0.370 (0.82)
Terminal block adapter for mounting a relay beneath an LC1D115 or D150 contactor	LRD3●●●, LR3D3●●●, LRD35●●	1	LA7D3058	0.080 (0.18)
Mounting plates (3) for screw mounting on 110 mm center	LRD01 to 35, LR3D01 to D35. LR2D15●●	10	DX1AP25	0.065 (0.14)
	LR2D25●●	10	DX1AP26	0.082 (0.18)
	LRD3●●●, LR3D3●●●, LR2D35●●	1	LA7D902	0.130 (0.29)
Marker holder snap in	All relays except LRD01 to 35 and LR3D01 to D35 (4)	100	LA7D903	0.001 (0.002)
Bag of 400 labels (blank, self-adhesive, 7 x 16 mm)	–	1	LA9D91	0.001 (0.002)
Stop button locking device	All relays except LRD01 to 35. LR3D01 to D35 and LR9D	10	LA7D901	0.005 (0.01)
Remote stop or electrical reset device (5)	LRD01 to 35 and LR3D01 to D35	1	LAD703• (6)	0.090 (0.20)
Remote tripping or electrical reset device (5)	All relays except LRD01 to 35 and LR3D01 to D35	1	LA7D03• (6)	0.090 (0.20)
Block of insulated terminals	LR9D	2	LA9F103	0.560 (1.23)
Spacer	Mounting small overload relays to LC1D25 and LC1D32	10	W816366180111	0.050 (0.023)

Remote Control

"Reset" Function

By flexible cable (length = 0.5 m / 1.64 ft.)	LRD01 to 35 and LR3D01 to D35	1	LAD7305	0.075 (0.17)
	All relays except LRD01 to 35 and LR3D01 to D35	1	LA7D305	0.075 (0.17)

"Stop" and/or "Reset" Functions

The terminal protection shroud must be removed and the following three products must be ordered separately.

Adapter for door interlock mechanism	All relays except LRD01 to 35 and LR3D01 to D35	1	LA7D1020	0.005 (0.01)
Operating head for spring return push button	Stop All relays	1	XB5AL84101	0.027 (0.06)
	Reset All relays	1	XB5AA86102	0.027 (0.06)

- (1) Terminal blocks are supplied with terminals protected against direct finger contact and screws in the open, "ready-to-tighten" position.
- (2) To order a terminal block (separate mount kit) with ring-tongue terminals, the catalog number becomes **LA7D30646**.
- (3) Requires separate mount terminal block corresponding to the type of relay.
- (4) For LRD01 to 35 (see page 114).
- (5) The time for which the coil of remote tripping or electrical resetting device **LA7D03** or **LAD703** can remain energized depends on its rest time: 1 s pulse duration with 9 s rest time; 5 s pulse duration with 30 s rest time; 10 s pulse duration with 90 s rest time; maximum pulse duration of 20 s with a rest time of 300 s. Minimum pulse time: 200 ms.
- (6) Reference to be completed by adding the code indicating control circuit voltage. Standard control circuit voltages (for other voltages, please consult your Regional Sales Office).

Volts	12	24	48	96	110	220/230	380/400	415/440
50/60 Hz	–	B	E	–	F	M	Q	N
Consumption, inrush and sealed: < 100 VA								
dc	J	B	E	DD	F	M	–	–

Consumption, inrush and sealed: < 100 W.

TeSys™ D-Line Contactors and Starters

Dimensions for 3-pole Bi-metallic and Solid-state Overload Relays

D-Line Thermal Overload Relays

LRD-01-35

Direct mounting beneath contactors with screw

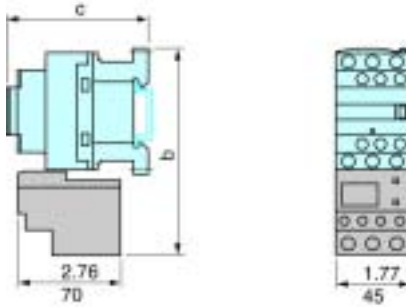

LRD-013-353

Direct mounting beneath contactors with spring terminal connections

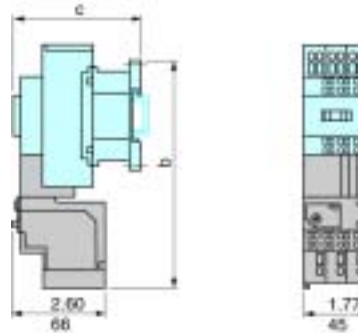

Dual Dimensions: Inches
mm

LC1•	D09 - D18	D25 - D38	LC1•	D093 - 383
b	4.84 (123)	5.39 (137)	b	4.84 (123)
c	See pages 122, 123.		c	See pages 122, 123.

LRD-3***

Direct mounting beneath contactors
LC1-D40 to D95 and LP1-D40 to D80

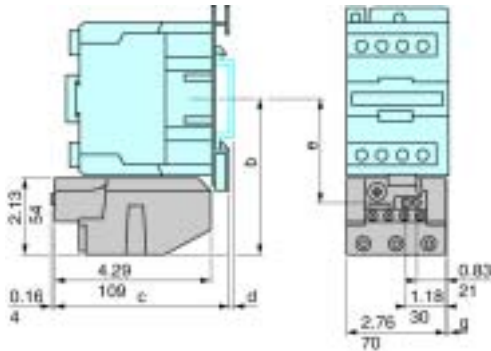

AM1•	DL201	DL200					
d	0.28 (7)	0.67 (17)	b	c	e	g(3P)	g(4P)
ac control circuit:							
LC1D40	4.37 (111)	4.69 (119)	2.85 (72.4)	0.18 (4.5)	0.51 (13)		
LC1D50	4.37 (111)	4.69 (119)	2.85 (72.4)	0.18 (4.5)	-		
LC1D65	4.37 (111)	4.69 (119)	2.85 (72.4)	0.18 (4.5)	0.51 (13)		
LC1D80	4.55 (115.5)	4.88 (124)	3.03 (76.9)	0.37 (9.5)	0.87 (22)		
LC1D95	4.55 (115.5)	4.88 (124)	3.03 (76.9)	0.37 (9.5)	-		
dc control circuit:							
LC1D40, LP1D40	4.37 (111)	6.93 (176)	2.85 (72.4)	0.18 (4.5)	0.51 (13)		
LC1D50	4.37 (111)	6.93 (176)	2.85 (72.4)	0.18 (4.5)	-		
LC1D65, LP1D65	4.37 (111)	6.93 (176)	2.85 (72.4)	0.18 (4.5)	0.51 (13)		
LC1D80, D95, LP1D80	4.55 (115.5)	7.06 (179.4)	3.03 (76.9)	0.37 (9.5)	0.87 (22)		

LRD4***

Direct mounting beneath contactors
LC1D115 and D150

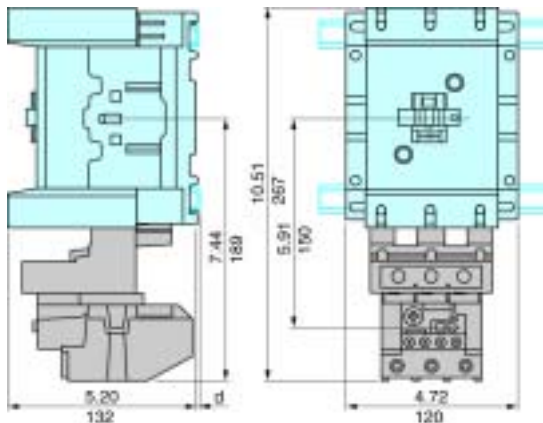

LR9D

Direct mounting beneath contactors
LC1D115 and D150

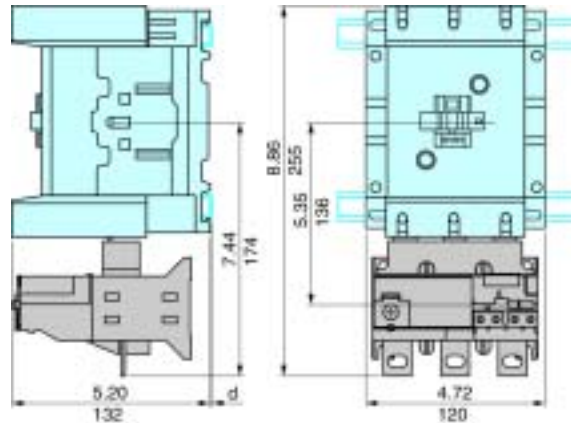

AM1DL200 and DR200	AM1DE200 and ED***	AM1DP200 and DR200	AM1DE200 and ED***
d	0.10 (2.5)	d	0.41 (10.5)

Characteristics: pages 130 - 133

Catalog Number: pages 134, 135

TeSys™ D-Line Contactors and Starters

Mounting Information for Bimetallic and Solid-state Overload Relays

D-Line Thermal Overload Relays

LRD-01-35

Independent mounting on 50 mm centers or on rail AM1DP200 or DE200

Independent mounting on 110 mm centers

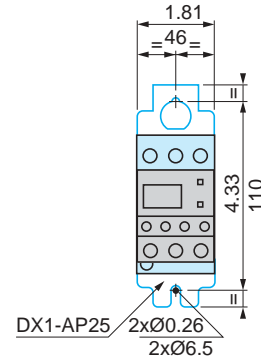
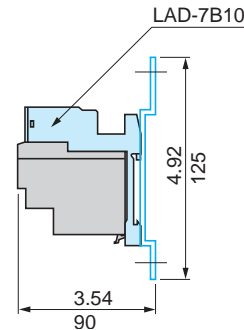
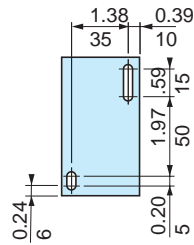
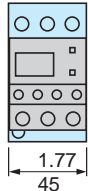
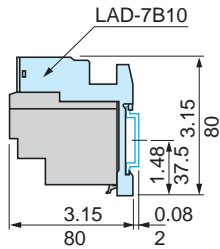

Remote tripping or electrical reset

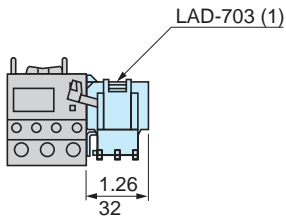

Dual Dimensions: $\frac{\text{Inches}}{\text{mm}}$

(1) Can only be mounted on RH side of relay LRD-01 to 35

LRD15**

Independent mounting on 50 mm centers or on rail AM1DP200 or DE200

Remote tripping or electrical reset

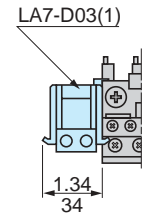
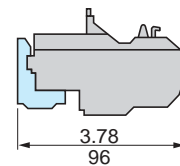
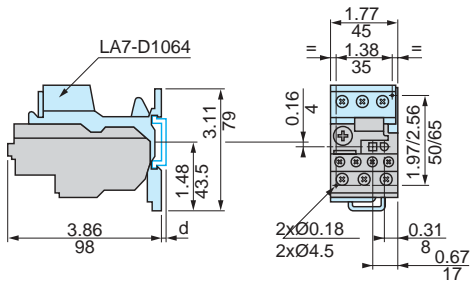

AM1DP200 **AM1DE200**

d 0.08 (2) 0.37 (9.5)

(1) Can be mounted on RH or LH side of relay LRD15**

LR2D25**

Independent mounting on 50 mm centers or on rail AM1DP200 or DE200

Remote tripping or electrical reset

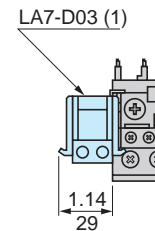
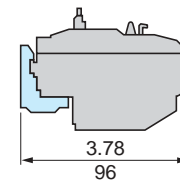
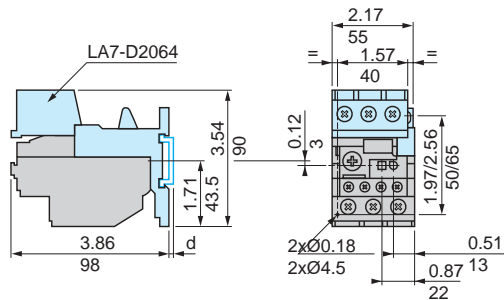

AM1DP200 **AM1DE200**

d 0.08 (2) 0.37 (9.5)

(1) Can be mounted on RH or LH side of relay LR2D25**

Characteristics: pages 130 - 133 Catalog Number: pages 134, 135

TeSys™ D-Line Contactors and Starters

Mounting Information for Bimetallic and Solid-state Overload Relays

D-Line Thermal Overload Relays

LRD3*** and LR2D35**

Independent mounting on 50 mm centers or on rail AM1DP200 or DE200

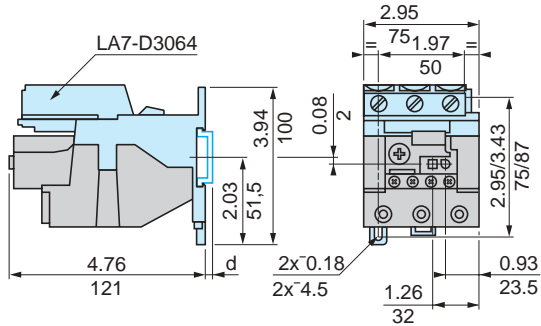

LRD3***, LR2D35** and LR9D

Remote tripping or electrical reset

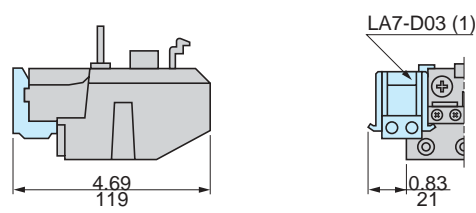

AM1DP200

AM1DE200

d 0.08 (2)

0.37 (9.5)

(1) Can be mounted on RH or LH side of relay LR23***, LR2D35** or LR9D

LR2D and LRD3***

Adapter for door interlock mechanism LA7D1020

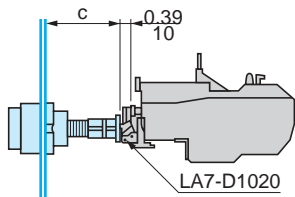

c: adjustable from 0.67 to 4.72 in. (17 to 120 mm)

Stop

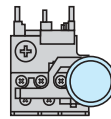

Reset

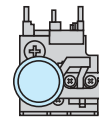

LRD, LR2D and LR9D

"Reset" by flexible cable LA7D305 and LAD7305
Mounting with cable straight

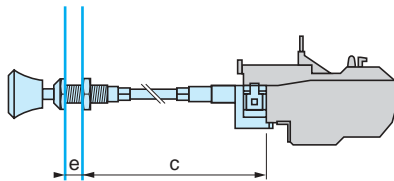

c: up to 21.6in (550 mm)

e: up to .79in (20 mm)

Mounting with cable bent

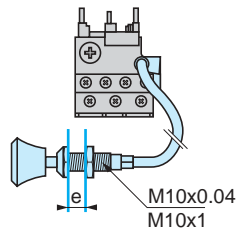

e: up to 0.79in (20 mm)

Characteristics: pages 130 - 133

Catalog Number: pages 134, 135

TeSys™ D-Line Contactors and Starters

Capacitor-switching Contactors (International Applications Only)

For Switching 3-phase Capacitor Banks used for Power Factor Correction - Selection

Standard Contactors

Capacitors, together with the circuits to which they are connected, form oscillatory circuits which can, at the moment of switch-on, give rise to high transient currents (> 180 In) at high frequencies (1 to 15 kHz).

As a general rule, the peak current on energizing is lower when:

- the mains inductances are high,
- the line transformer ratings are low,
- the transformer short-circuit voltage is high,
- the ratio between the sum of the ratings of the capacitors already switched into the circuit and that of the capacitors to be switched in is small (for multiple step capacitor banks).

In accordance with standards IEC 60070, NF C 54-100, VDE 0560, the switching contactor must be able to withstand a continuous current of 1.43 times the rated current of the capacitor bank step being switched.
The rated operational powers given in the tables opposite take this overload into account.

Short-circuit protection is normally provided by gL type HPC fuses rated at 1.7 to 2 In.

Contactor Applications

Operating Conditions

Capacitors are directly switched. **The values of peak current at switch-on must not exceed the values indicated opposite.**

An inductor may be inserted in each of the three phases supplying the capacitors to reduce the peak current, if necessary. Inductance values are determined according to the selected operating temperature.

Power factor correction by a single-step capacitor bank

The use of a choke inductor is unnecessary; the inductance of the mains supply is adequate to limit the peak to a value compatible with the contactor characteristics.

Power factor correction by a multiple-step capacitor bank

Select a special contactor as defined on page 142.

If a standard contactor is used, it is essential to insert a choke inductor in each of the three phases of each step.

Maximum operational power of contactors

Standard Contactors

Maximum operating rate: 120 operating cycles/hour.
Electrical durability at maximum load: 100,000 operating cycles.
With choke inductors connected, where necessary.

Operational power at 50/60 Hz						Maximum Peak Current	Contactor Size
$\theta \leq 40\text{ }^{\circ}\text{C} / 104\text{ }^{\circ}\text{F} (1)$			$\theta \leq 55\text{ }^{\circ}\text{C} / 131\text{ }^{\circ}\text{F} (1)$				
220 V	400 V	600 V	220 V	400 V	600 V		
240 V	440 V	690 V	240 V	440 V	690 V		
kVAR	kVAR	kVAR	kVAR	kVAR	kVAR	A	
6	11	15	6	11	15	560	LC1D09, D12
9	15	20	9	15	20	850	LC1D18
11	20	25	11	20	25	1600	LC1D25
14	25	30	14	25	30	1900	LC1D32, D38
17	30	37	17	30	37	2160	LC1D40
22	40	50	22	40	50	2160	LC1D50
22	40	50	22	40	50	3040	LC1D65
35	60	75	35	60	75	3040	LC1D80, D95
50	90	125	38	75	80	3100	LC1D115
60	110	135	40	85	90	3300	LC1D150
70	125	160	50	100	100	3500	LC1F185
80	140	190	60	110	110	4000	LC1F225
90	160	225	75	125	125	5000	LC1F265
100	190	275	85	140	165	6500	LC1F330
125	220	300	100	160	200	8000	LC1F400
180	300	400	125	220	300	10 000	LC1F500
250	400	600	190	350	500	12 000	LC1F630
250	400	600	190	350	500	14 200	LC1F800

(1) Upper limit of temperature category conforming to IEC 70.

TeSys™ D-Line Contactors and Starters

Capacitor-switching Contactors (International Applications Only)

For Switching 3-phase Capacitor Banks, used for Power Factor Correction
Direct Connection without Choke Inductors - References



LC1DFK11..

Special Contactors

Special contactors **LC1D•K** are designed for switching 3-phase, single or multiple-step capacitor banks; they conform to standards IEC 60070 and 60831, NFC 54-100, VDE 0560, UL and CSA.

Contactors Applications

Specification

Contactors fitted with a block of early make poles and damping resistors, limiting the value of the current on closing to 60 In max. This current limitation increases the life of all the components of the installation, in particular that of the fuses and capacitors. The patented design of the add-on block (No. 90 119-20) ensures safety and long life of the installation.

Operating Conditions

There is no need to use choke inductors for either single or multiple-step capacitor banks.
Short-circuit protection must be provided by gl type fuses rated at 1.7 to 2 In.

Maximum Operational Power

The power values given in the selection table below are for the following operating conditions.

Prospective Peak Current at Switch-on	LC1D•K		200 In				
Maximum Operating Rate	LC1DFK, DGK, DLK, DMK, DPK		240 operating cycles/hour				
	LC1DTK, DWK		100 operating cycles/hour				
Electrical Durability at Nominal Load	All Contactor Ratings		400 V	300,000 operating cycles			
			690 V	200,000 operating cycles			
Operational Power at 50/60 Hz (1)			Instantaneous Auxiliary Contacts	Tightening Torque on Cable End	Basic Reference. Complete with Code Indicating Control Circuit Voltage (2)	Weight lb. (kg)	
$\theta \leq 55\text{ }^{\circ}\text{C} / 131\text{ }^{\circ}\text{F}$ (3)							
220 V	400 V	660 V		lb-in (N.m)	LC1DFK11..	0.94 (0.430)	
240 V	440 V	690 V					
kVAR	kVAR	kVAR	N.O.	N.C.			
6.7	12.5	18	1	1	11 (1.2)	LC1DFK11..	0.94 (0.430)
			–	2	11 (1.2)	LC1DFK02..	0.94 (0.430)
8.5	16.7	24	1	1	15 (1.7)	LC1DGK11..	0.99 (0.450)
			–	2	15 (1.7)	LC1DGK02..	0.99 (0.450)
10	20	30	1	1	17 (1.9)	LC1DLK11..	1.3 (0.600)
			–	2	17 (1.9)	LC1DLK02..	1.3 (0.600)
15	25	36	1	1	22 (2.5)	LC1DMK11..	1.4 (0.630)
			–	2	22 (2.5)	LC1DMK02..	1.4 (0.630)
20	33.3	48	1	2	44 (5)	LC1DPK12..	2.9 (1.300)
25	40	58	1	2	44 (5)	LC1DTK12..	2.9 (1.300)
40	60	92	1	2	80 (9)	LC1DWK12..	3.6 (1.650)

Switching of multiple step capacitor banks (with equal or different power ratings).

The correct contactor for each step is selected from the above table, according to the power rating of the step to be switched.

Example: 50 kVAR 3-step capacitor bank. Temperature 50 °C (122 °F) and U = 400 V or 440 V.

One 25 kVAR step: contactor LC1-DMK, one 15 kVAR step: contactor LC1-DGK and one 10 kVAR step: contactor LC1-DFK.

(1) Operational power of the contactor according to the schematic on page 143.

(2) Standard control circuit voltages.

Volts	24	42	48	110	115	220	230	240	380	400	415	440
50/60 Hz	B7	D7	E7	F7	FE7	M7	P7	U7	Q7	V7	N7	R7

For other voltages between 24 and 440 V, please consult your Regional Sales Office

(3) The average temperature over a 24-hour period, in accordance with standards IEC 60070 and 60831, is 45 °C (113 °F).

TeSys™ D-Line Contactors and Starters Capacitor-switching Contactors (International Applications Only)

For Switching 3-phase Capacitor Banks, used for Power Factor Correction
Dimensions, Schematics - References

Dimensions

LC1DFK, DGK

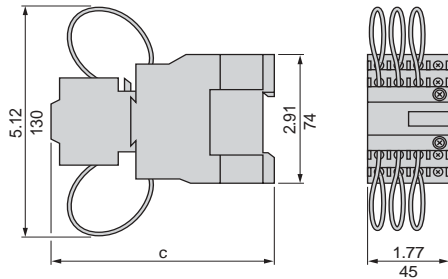

LC1	c	Type of Mounting
DFK	117	LC1D12 See pages 124, 125
DGK	122	LC1D18 See pages 124, 125

LC1DPK, DTK

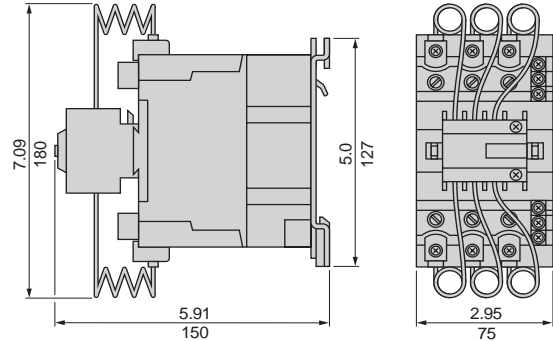

LC1	Type of Mounting
DPK	LC1D40 See pages 124, 125
DTK	LC1D50 See pages 124, 125

LC1DLK, DMK

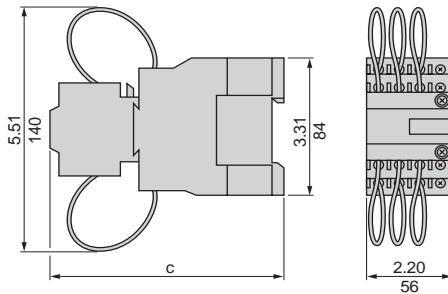

LC1	c	Type of Mounting
DLK	117	LC1D25 See pages 124, 125
DMK	122	LC1D32 See pages 124, 125

LC1DWK

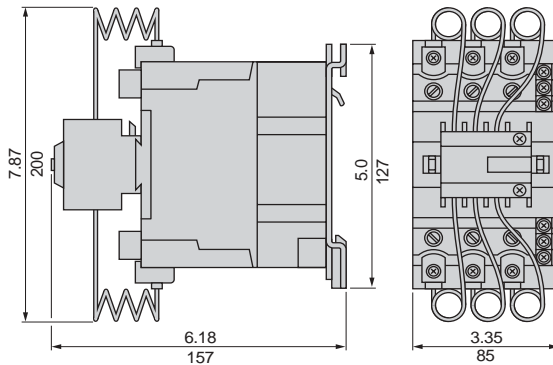

LC1	Type of Mounting
DWK	LC1D80 See pages 124, 125

Schematics

LC1D•K

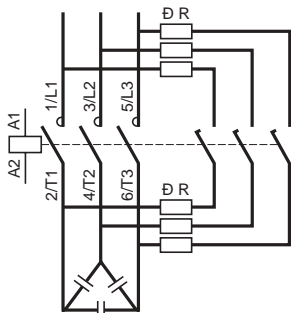

Cabling (maximum permissible c.s.a.)

R = Pre-wired resistor connections

Contactor type LC1	DFK		DGK		DLK		DMK		DPK, DTK		DWK	
	1	2	1	2	1	2	1	2	1	2	1	2
Number of conductors												
Flexible cable with cable end AWG (mm ²)	14 (2.5)	16 (1.5)	12 (4)	14 (2.5)	12 (4)	12 (4)	10 (6)	12 (4)	6 (16)	10 (6)	1 (50)	4 (25)
Solid cable without cable end AWG (mm ²)	12 (4)	12 (4)	10 (6)	10 (6)	8 (10)	10 (6)	6 (16)	8 (10)	4 (25)	6 (16)	1 (50)	2 (35)

TeSys™ D-Line Contactors and Starters

Plate-mounted Starters LC4D (International Applications Only)



LC4D09A**

AC D.O.L. Starters, Plate Mounted, for Motor Control 4 to 37 kW, (1), with Isolating Device, Pre-Assembled - References

Utilization Category ac-3						Operational Current	Fuses to be Fitted by the Customer		Basic Reference. Complete with Code Indicating Control Circuit Voltage (2)	Weight lb (kg)
Standard Power Ratings of 3-phase Motors 50/60 Hz							440 V up to	Size		
220 V	380 V				660 V	A				A
230 V	400 V	415 V	440 V	500 V	690 V					
kW	kW	kW	kW	kW	kW					
2.2	4	4	4	5.5	–	9	10 x 38	12	LC4D09A**	1.9 (0.870)
3	5.5	5.5	5.5	7.5	–	12	10 x 38	16	LC4D12A**	1.9 (0.870)
4	7.5	9	9	10	–	18	10 x 38	20	LC4D18A**	2.5 (1.150)
5.5	11	11	11	15	–	25	10 x 38	25	LC4D25A**	3.5 (1.580)
7.5	15	15	15	18.5	18.5	32	14 x 51	32	LC4D32A**	5.8 (2.630)
11	18.5	22	22	22	30	40	14 x 51	40	LC4D40**	6.5 (2.930)
15	22	25	30	30	33	50	22 x 58	63	LC4D50**	7.0 (3.200)
18.5	30	37	37	37	37	65	22 x 58	80	LC4D65**	7.4 (3.340)
22	37	45	45	55	45	80	22 x 58	80	LC4D80**	8.0 (3.650)

Specifications

Pre-wired power and control circuit connections.

3-pole isolating device

- (1) Thermal overload relay to be ordered separately (see pages 134, 135).
- (2) Standard control circuit voltages.

Volts	24	42	48	110	220	230	240	380	400	415	440
50/60 Hz	B7	D7	E7	F7	M7	P7	U7	Q7	V7	N7	R7

For other voltages, please consult your Regional Sales Office.

TeSys™ D-Line Contactors and Starters

Plate-mounted Starters LC4D (International Applications Only)

D.O.L. Starters, Plate Mounted, for Motor Control
4 to 37 kW, with Isolating Device, Pre-assembled - Dimensions, Schematics

Dimensions

D.O.L. Starters

Plate Mounted, Pre-assembled

LC4D09 to D25A

LC4D32A

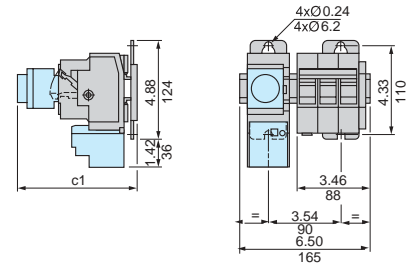
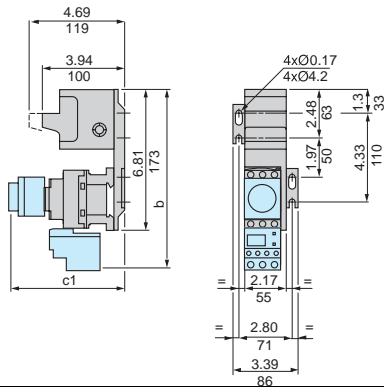

LC4	D09A to D18A	D25A
b	8.58 (218)	8.70 (221)
c1 without cover or add-on blocks	3.70 (94)	3.93 (100)
with cover, without add-on block	3.77 (96)	4.01 (102)
with LADN or C (two or four contacts)	5.0 (127)	5.23 (133)
with LA6DK10	5.47 (139)	5.70 (145)
with LADT, R, S	5.78 (147)	6.02 (153)
with LADT, R, S and sealing cover	5.94 (151)	6.18 (157)

LC4	D32A
c1 without cover or add-on blocks	3.93 (100)
with cover, without add-on block	4.01 (102)
with LADN or C (two or four contacts)	5.23 (133)
with LA6DK10	5.70 (145)
with LADT, R, S	6.02 (153)
with LADT, R, S and sealing cover	6.18 (157)

LC4-D40 to D80

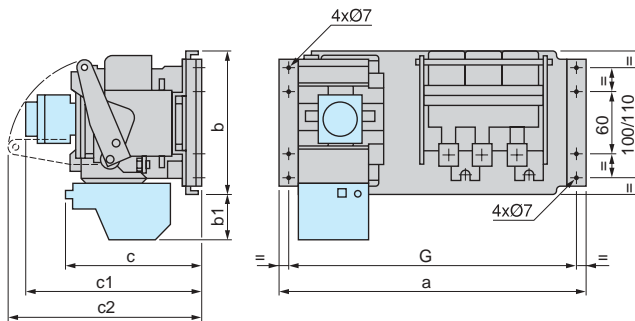

LC4	D40 to D65	D80
a	11.0 (281)	12.2 (311)
b	5.6 (143)	5.6 (143)
c	5.1 (130)	5.5 (140)
c1 without cover or add-on blocks	4.8 (124)	5.3 (135)
with cover, without add-on block	5.2 (129)	5.5 (140)
with LA1-DN (one contact)	6.1 (149)	6.3 (160)
with LAD-N or C (two or four contacts)	6.4 (157)	6.6 (168)
with LA6-DK	6.6 (169)	7.0 (180)
with LAD-T, R, S	6.9 (177)	7.4 (188)
with LAD-T, R, S and sealing cover	7.12 (181)	7.5 (192)
c2	3.9 (100)	7.0 (178)

D.O.L. Starters

LC4-D09A to D80

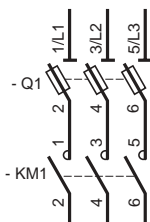

TeSys™ D-Line Contactors and Starters

AC Wye-delta Starters LC3D (International Applications Only)

5.5 to 132 kW, (1), without Isolating Device, Pre-assembled - References

NOTE: Wiring methods differ from typical North American practice.
Contains UL listed, CSA certified, CE marked components.
Assemblies are not UL Listed or CSA Certified.



LC3D32A●●

Standard Power Ratings of Squirrel Cage Motors				Auxiliary Contacts Available on Each Contactor			Star Delta Mechanical Interlock	Catalog Number Complete with Code Indicating Control Circuit Voltage (2)	Weigh lb. (kg)
				line	delta	star			
Line Voltage - Delta Connection				KM2	KM3	KM1			
220/ 230 V	380/ 400 V	415 V	440 V						
kW	kW	kW	kW						

Plate Mounted

Maximum Operating Rate: 30 starts/hour. Maximum starting time: 30 seconds.

4	7.5	7.5	7.5	-	-	-	-(3)	-	1	With	LC3D09A●●	3.4 (1.530)
5.5	11	11	11	-	-	-	-(3)	-	1	With	LC3D12A●●	3.4 (1.530)
11	18.5	22	22	-	-	-	-(3)	-	1	With	LC3D18A●●	3.8 (1.730)
15	25	30	30	-	-	-	-(3)	-	1	With	LC3D32A●●	4.5 (2.030)
18.5	37	37	37	-	1	1	-(3)	-	1	Without	LC3D40●●	9.6 (4.360)
										With	LC3D40●●A64	9.9 (4.500)
30	55	59	59	-	1	1	-(3)	-	-(3)	Without	LC3D50●●	9.6 (4.360)
										With	LC3D50●●A64	9.9 (4.500)
37	75	75	75	-	1	1	-(3)	-	-(3)	Without	LC3D80●●	11.5 (5.200)
										With	LC3D80●●A64	12.0 (5.400)
63	110	110	110	-	1	1	-(3)	-	-(3)	Without	LC3D115●● (4)	26.0 (11.800)
										With	LC3D115●●A64 (4)	26.7 (12.100)
75	132	132	147	-	1	1	-(3)	-	1 (3)	Without	LC3D150●● (4)	26.7 (12.100)
										With	LC3D150●●A64 (4)	26.7 (12.100)

Rail Mounted (35 mm DIN rail)

Maximum Operating Rate: 12 starts/hour. Maximum starting time: 30 seconds.

3	5.5	5.5	5.5	-	-	-	-	-	1	With	LC3K06●●	1.6 (0.740)
4	7.5	7.5	7.5	-	-	-	-	-	1	With	LC3K09●●	1.6 (0.740)
Maximum operating rate: 30 starts/hour. Maximum starting time: 30 seconds.												
4	7.5	7.5	7.5	-	-	-	-(3)	-	1	With	LC3D090A●●	3.4 (1.530)
5.5	11	11	11	-	-	-	-(3)	-	1	With	LC3D120A●●	3.4 (1.530)
11	18.5	22	22	-	-	-	-(3)	-	1	With	LC3D180A●●	3.8 (1.730)
15	25	30	30	-	-	-	-(3)	-	1	With	LC3D320A●●	4.5 (2.030)

(1) Protection must be provided by the addition of an overload relay, to be ordered separately. Select appropriate overload relay for setting at 0.58 of the full load rated motor current (see pages 134 and 135).

(2) Standard control circuit voltages

Volts ac 50/60 Hz	24	36	42	48	110	220	230	240	380	400	415	440
Wye-delta Starters LC3K06 and K09												
Code	B7	C7	D7	E7	F7	M7	P7	U7	-	V7	N7	R7
Wye-delta starters LC3D09A to D150, LC3D090A to D320A												
Code	B7	-	D7	E7	F7	M7	P7	U7	Q7	V7	N7	R7

For other voltages, please consult your Regional Sales Office.

(3) One auxiliary contact block type LADN can also be installed, see page 107.

(4) These starters consist of contactors LC1D115 or D150 without connectors.

TeSys™ D-Line Contactors and Starters

AC Wye-delta Starters LC3D (International Applications Only)

Wye-delta Starting

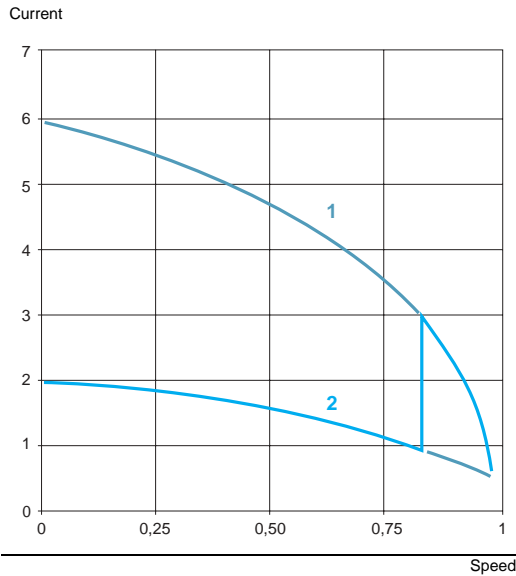

This method of starting is applicable to motors on which all six stator terminals are accessible and whose delta connection voltage corresponds to the mains voltage.

Wye-delta starting should be used for motors starting on no-load or having a low load torque and gradual build-up: the starting torque in star connection is reduced to one third of the direct starting torque, i.e. about 50% of the rated torque; the starting current in star connection is about 1.8 to 2.6 times the rated current.

The transition from wye to delta connection must occur when the machine has run up to speed. A too rapid build-up in load torque would cause the stabilized run-up speed to be too low and would therefore eliminate any advantage in this method of starting: this is the case with certain machines whose load torque depends on the machine speed (a characteristic of centrifugal machines, for example).

All wye-delta starters are supplied with a special LA2DS2 or LA2KT2 time delay relay which imposes a delay on the delta contactor during the transition period in order to allow the star contactor sufficient breaking time.

For ratings D115 and D150, this function is performed by a time delay auxiliary contact block LA2DT2 and a control relay.

- 1 Starting in direct delta connection
- 2 Starting in wye connection

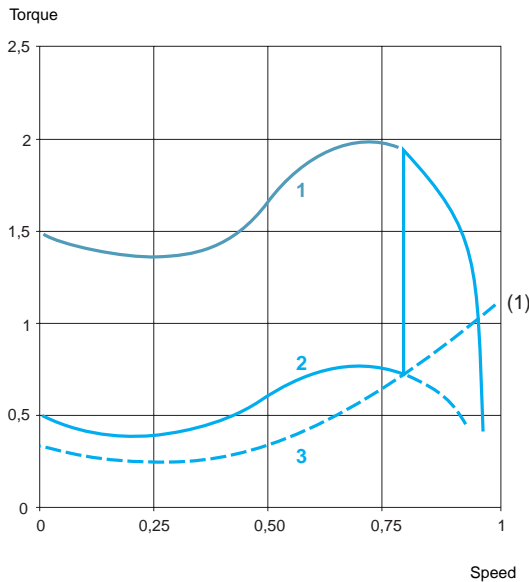

- 1 Starting in direct delta connection
- 2 Starting in star connection
- 3 Machine resistive torque

(1) Motor manufacturers generally specify machine load torques.
Example: maximum resistive torque on completion of star-delta start (expressed as a proportion of the rated torque).

TeSys™ D-Line Contactors and Starters

AC Wye-delta Starter Kits (International Applications Only)

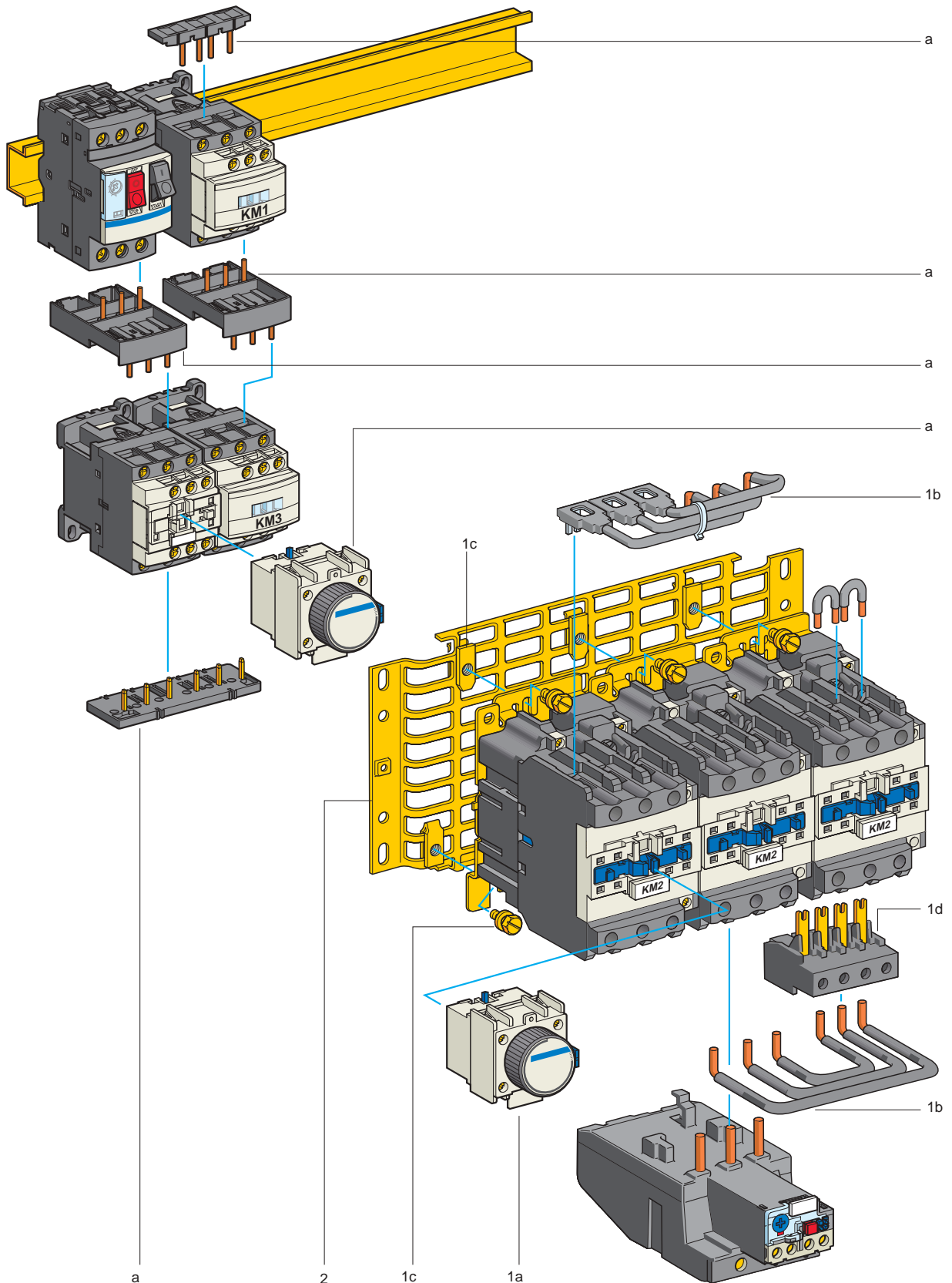

TeSys™ D-Line Contactors and Starters

AC Wye-delta Starter Kits (International Applications Only)

Wye-delta Starters, for Motor Control, 7.5 to 132 kW (1), without Mechanical Interlock, for Customer Assembly (on plate or on mounting rail) (2) - References

Starters for Direct Combination with Circuit-breaker

Maximum Operating Rate: 30 starts/hour. Maximum starting time: 30 seconds					
Standard Power Ratings of Squirrel Cage Motors (3) Mains Voltage-delta		Motor Thermal-magnetic MCB	Catalog Number Complete with Code Indicating Control Circuit Voltage (4)		
400/415 V kW	440 V kW		line	delta	star
			KM2	KM3	KM1
7.5	7.5	GV2ME20	LC1D09**	LC1D09**	LC1D09**
–	9	GV2ME20	LC1D12**	LC1D12**	LC1D09**
9	11	GV2ME21	LC1D12**	LC1D12**	LC1D09**
11	–	GV2ME22	LC1D18**	LC1D18**	LC1D09**
15	15	GV2ME32	LC1D18**	LC1D18**	LC1D09**

Separate Parts

Description	Illustration Item No.	Catalog Number	Weight lb. (kg)
Mounting Kit comprising: Power circuit connections and 1 time delay contact block LADS2	a	LAD912GV	0.29 (0.130)

Starters for Mounting Separately from Upstream Protection

Maximum Operating Rate : 30 starts/hour. Maximum starting time: 30 seconds							
Standard power ratings of squirrel cage motors (3) Mains voltage-delta				Contactors (basic references to be completed with code indicating the voltage) (4)			Separate Parts (see below)
220/230 V	380/400 V	415 V	440 V	line	delta	star	Component Type
kW	kW	kW	kW	KM2	KM3	KM1	
4	7.5	7.5	7.5	LC1D09**	LC1D09**	LC1D09**	D09
5.5	11	11	11	LC1D12**	LC1D12**	LC1D09**	D12
11	18.5	22	22	LC1D18**	LC1D18**	LC1D09**	D18
15	25	30	30	LC1D32**	LC1D32**	LC1D18**	D32
18.5	37	37	37	LC1D40**	LC1D40**	LC1D40**	D40
30	55	59	59	LC1D50**	LC1D50**	LC1D40**	D50
37	75	75	75	LC1D80**	LC1D80**	LC1D50**	D80
63	110	110	110	LC1D115**	LC1D115**	LC1D80**	D115
75	132	132	147	LC1D150**	LC1D150**	LC1D115**	D150

Separate Parts

Description	Illustration Item No.	For use on	Catalog Number	Weight lb. (kg)
Mounting Kit comprising: - 1 time delay contact block LADS2 (D09 to D80) (3) - power circuit connections (D09 to D80) - screws and clamps for attaching contactors to the plate (D40 to D80) - terminal block (D09 to D32)	1 a 1 b 1 c 1 d	D09 to D18	LAD91217	0.40 (0.180)
		D32	LAD93217	0.65 (0.310)
		D40	LA9D4017	0.83 (0.380)
		D50	LA9D5017	1.06 (0.480)
		D80	LA9D8017	1.5 (0.680)
Equipment Mounting Plate	2	D09, D12, D18	LA9D12974	0.33 (0.150)
		D32	LA9D32974	0.40 (0.180)
		D40 and D50	LA9D40973	0.66 (0.300)
		D80	LA9D80973	0.66 (0.300)

- (1) Protection must be provided by the addition of a thermal overload relay, to be ordered separately. Select appropriate overload relay for setting at 0.58 of the rated motor current, see pages 134 and 135.
- (2) For mounting, assembly and cabling: refer to installation instructions supplied with the equipment.
- (3) See comments on page 147.
- (4) See page 115.

TeSys™ D-Line Contactors and Starters

AC Wye-delta Starter Kits (International Applications Only)

Wye-delta Starters - Dimensions, Schematics

Dimensions for Wye-delta Starters

On mounting rail AM1-DP, pre-assembled
LC3-D090A to D320A

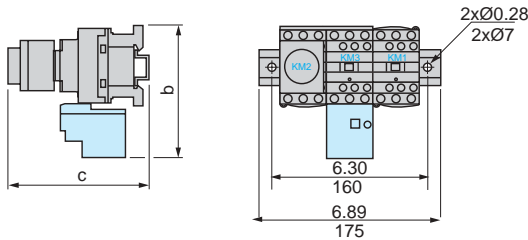

LC3	D090A to D180A	D320A
b	6.0 (153)	5.6 (137)
c	with LAD-S	5.9 (145)
	with LAD-S and sealing cover	5.8 (149)

Schematics

LC3-K, LC3-D09A to D80 / LC3D090A to D320A

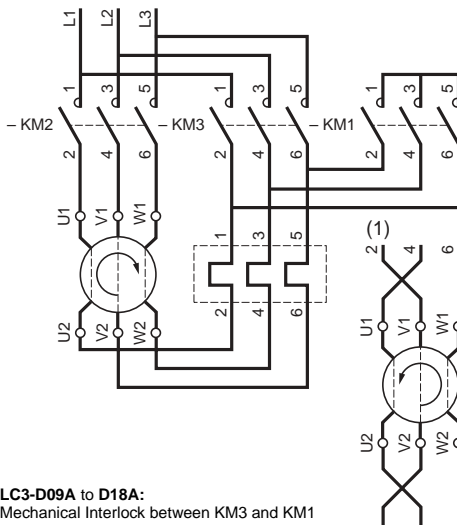

LC3-K

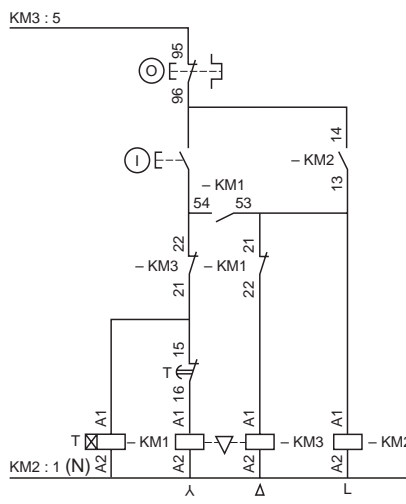

LC3-D

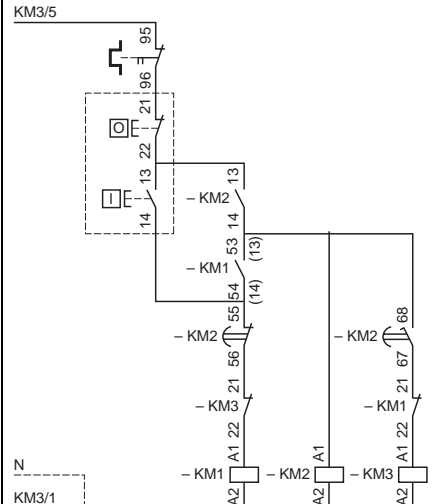

LC3-D09A to D18A:
Mechanical Interlock between KM3 and KM1

(1) Recommended cabling for reversal of motor rotation (Standard motor, viewed from shaft end)

For LC3D50, D80

LC3-D115 and D150

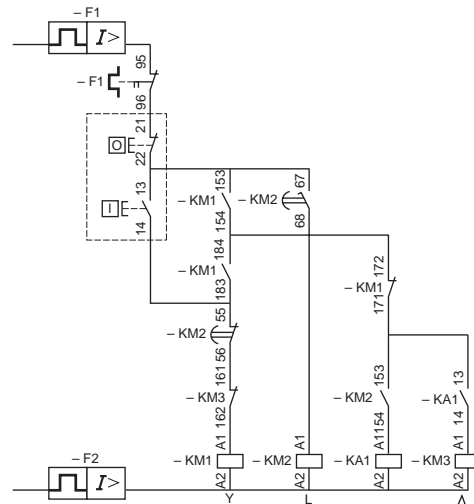
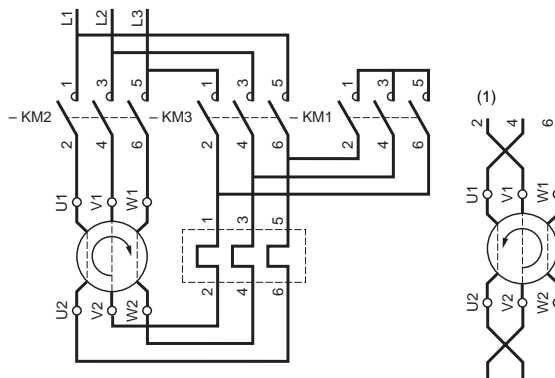

(1) Recommended cabling for reversal of motor rotation (Standard motor, viewed from shaft end)

TeSys™ D-Line Contactors and Starters Enclosed Contactors and Starters

Horsepower Ratings for North American Applications of D-Line Products in Metal Enclosures

D-line enclosed full voltage starters are available in Type 1 and Type 12/3R enclosures through 50 hp at 460 Vac.
See pages 106 to 112 for a complete selection of D-line accessories. See page 155 for Insta-Kit accessories.



E154118
CCN NLDX
CCN NLDX7



LR23506 41
Class 3211 04

Enclosed full voltage non-reversing starters

Max. Horsepower Ratings (AC3) 3 Phase				Auxiliary Contacts		Current Rating of Contactor	Catalog Number Type 1	Weight kg (lb.)	Catalog Number Type 12/3R	Weight kg (lb.)
200 V	230 V	460 V	575V	N.O.	N.C.					
2	2	5	7½	1	...	9	LE1D093A62(1)(2)(3)(4)(5)	3.1 (6.9)	LE1D093A72(1)(2)(3)(4)(5)	3.5 (7.7)
3	3	7½	10	1	...	12	LE1D123A62(1)(2)(3)(4)(5)	3.1 (6.9)	LE1D123A72(1)(2)(3)(4)(5)	3.5 (7.7)
5	5	10	15	1	...	18	LE1D183A62(1)(2)(3)(4)(5)	3.1 (6.9)	LE1D183A72(1)(2)(3)(4)(5)	3.5 (7.7)
5	7½	15	20	1	...	25	LE1D253A62(1)(2)(3)(4)(5)	3.3 (7.3)	LE1D253A72(1)(2)(3)(4)(5)	3.6 (8.1)
7½	10	20	25	1	...	32	LE1D323A62(1)(2)(3)(4)(5)	3.3 (7.3)	LE1D323A72(1)(2)(3)(4)(5)	3.6 (8.1)
10	10	30	30	1	1	40	LE1D403A62(1)(2)(3)(4)(5)	5.1 (11.4)	LE1D403A72(1)(2)(3)(4)(5)	5.5 (12.3)
10	15	30	40	1	1	50	LE1D503A62(1)(2)(3)(4)(5)	5.1 (11.4)	LE1D503A72(1)(2)(3)(4)(5)	5.5 (12.3)
15	20	40	50	1	1	65	LE1D653A62(1)(2)(3)(4)(5)	7.4 (16.5)	LE1D653A72(1)(2)(3)(4)(5)	7.8 (17.4)
20	20	50	60	1	1	80	LE1D803A62(1)(2)(3)(4)(5)	7.6 (16.8)	LE1D803A72(1)(2)(3)(4)(5)	8.0 (17.8)

Enclosed full voltage reversing starters

Max. Horsepower Ratings (AC3) 3 Phase				Auxiliary Contacts		Current Rating of Contactor	Catalog Number Type 1	Weight kg (lb.)	Catalog Number Type 12/3R	Weight kg (lb.)
200 V	230 V	460 V	575 V	N.O.	N.C.					
2	2	5	7½	2	2	9	LE2D093A62(1)(2)(3)(4)(5)	4.5 (10)	LE2D093A72(1)(2)(3)(4)(5)	4.9 (10.8)
3	3	7½	10	2	2	12	LE2D123A62(1)(2)(3)(4)(5)	4.5 (10)	LE2D123A72(1)(2)(3)(4)(5)	4.9 (10.8)
5	5	10	15	2	2	18	LE2D183A62(1)(2)(3)(4)(5)	4.5 (10)	LE2D183A72(1)(2)(3)(4)(5)	4.9 (10.8)
5	7½	15	20	2	2	25	LE2D253A62(1)(2)(3)(4)(5)	4.5 (10)	LE2D253A72(1)(2)(3)(4)(5)	4.9 (10.8)
7½	10	20	25	2	2	32	LE2D323A62(1)(2)(3)(4)(5)	4.5 (10)	LE2D323A72(1)(2)(3)(4)(5)	4.9 (10.8)
10	10	30	30	2	2	40	LE2D403A62(1)(2)(3)(4)(5)	4.5 (10)	LE2D403A72(1)(2)(3)(4)(5)	4.9 (10.8)
10	15	30	40	2	2	50	LE2D503A62(1)(2)(3)(4)(5)	4.5 (10)	LE2D503A72(1)(2)(3)(4)(5)	4.9 (10.8)
15	20	40	50	2	2	65	LE2D653A62(1)(2)(3)(4)(5)	4.5 (10)	LE2D653A72(1)(2)(3)(4)(5)	4.9 (10.8)
20	20	50	60	2	2	80	LE2D803A62(1)(2)(3)(4)(5)	4.5 (10)	LE2D803A72(1)(2)(3)(4)(5)	4.9 (10.8)

NOTE: Use of control circuit transformers requires Insta-Kit wiring.

- Control Power Transformer: Select letter from below for primary voltage of CPT.

Control Power Transformer Primary Voltage Code Table

Voltage	No Transformer used	208	240	480	600
Code	O	L	M	T	X

- Contactor/starter coil voltage: Select coil voltage from table below.

NOTE: If control transformer is used, the only options available are 24 or 120 volts as the secondary of the transformer.

Contactor Coil Voltage Table

Voltage	24	120	208	240	480	600
AC	B	G	L	U	T	X

- Coil Frequency: Select: 7 = dual frequency coils (50/60 Hz), 6 = 60 Hz.

NOTE: For 9 to 32 A contactors, only dual frequency coils are available. For 40 to 80 A contactors, the 24 V to 240 V coils are dual frequency only (50/60 Hz.). The 480 V to 600 V coils are 60 Hz. only.

- Overload relay type: Select: 0 = No overload relay, 1 = Trip Class 10, 2 = Trip Class 20.
- Overload relay range: Select code from page 152.

NOTE: If no overload relay is required, leave this portion of the catalog number blank.

TeSys™ D-Line Contactors and Starters

Enclosed IEC Non-Combination Starters



LE2D093A62

Enclosed starter overload relay selection table

Code	Range	For use on Contactors
01	0.1–0.16	LC1D09–D32 ▲
02	0.16–0.25	LC1D09–D32 ▲
03	0.25–0.40	LC1D09–D32 ▲
04	0.40–0.63	LC1D09–D32 ▲
05	0.63–1.0	LC1D09–D32 ▲
06	1.0–1.6	LC1D09–D32 ▲
07	1.6–2.5	LC1D09–D32 ▲
08	2.5–4	LC1D09–D32
10	4–6	LC1D09–D32
12	5.5–8	LC1D09–D32
14	7–10	LC1D09–D32
16	9–13	LC1D12–D32
21	12–18	LC1D18–D32
22	16–24 ▲ 17–25 ■	LC1D25–D32 ▲ LC1D40–80 ■
30	23–28	LC1D25–D32 ■
32	25–32 ▲ 23–32 ■	LC1D25–D32
53	30–38	LC1D40–D80
55	30–40	LC1D40–D80
57	37–50	LC1D40–D80
59	48–65	LC1D40–D80
61	55–70	LC1D40–D80
63	63–80	LC1D40–80

- ▲ Available in Class 10 only
- Available in Class 20 only

NOTE: Use of control circuit transformers requires Insta-Kit wiring.

- Control Power Transformer: Select letter from below for primary voltage of CPT.

Control Power Transformer Primary Voltage Code Table

Voltage	No Transformer used	208	240	480	600
Code	O	L	M	T	X

- Contactor/starter coil voltage: Select coil voltage from table below.

NOTE: If control transformer is used, the only options available are 24 or 120 volts as the secondary of the transformer.

Contactor Coil Voltage Table

Voltage	24	120	208	240	480	600
AC	B	G	L	U	T	X

- Coil frequency: Select: 7 = dual frequency for all starter coil selections except for 480 V or 600 V coils, on 40 A - 80 A starters select 6, 60 Hz only.
- Overload relay type: Select: 0 = No overload relay, 1 = Trip Class 10, 2 = Trip Class 20.
- Overload relay range: Select code from page 155.

NOTE: If no overload relay is required, leave this portion of the catalog number blank.

TeSys™ D-Line Contactors and Starters Enclosed IEC Combination Starters

Horsepower Ratings for North American Applications of D-Line Products in Metal Enclosures with Fusible Disconnect Switch or Circuit Breaker
IEC combination starters combine the requirements of motor overload and short circuit protection in one convenient compact package. All devices provide Type 2 Coordination through 30 hp at 460 V. Devices are available in Type 1 and Type 12/3R enclosures.

NOTE: Use tables and notes from page 152 to complete the catalog numbers. See pages 106 to 112 for a complete selection of D-line accessories. See page 155 for Insta-Kit accessories.



E154118
CCN NLDX
CCN NLDX7



LR23506 41
Class 3211 04

Enclosed full voltage non-reversing fusible combination starters

Max. Horsepower Ratings (AC3) 3 Phase				Fuse Clip Rating		Auxiliary Contacts		Current Rating of Contactor	Catalog Number Type 1	Weight kg (lb.)	Catalog Number Type 12/3R	Weight kg (lb.)
200 V	230 V	460 V	575 V	Amperes	UL Class	N.O.	N.C.					
2	2	5	7½	30 A	CC	1	...	9	LE1D096B62(1)(2)(3)(4)(5)	8.1 (18)	LE1D096B72(1)(2)(3)(4)(5)	8.1 (18)
3	3	7½	10	30 A	CC	1	...	12	LE1D126B62(1)(2)(3)(4)(5)	8.1 (18)	LE1D126B72(1)(2)(3)(4)(5)	8.1 (18)
5	5	10	15	30 A	J	1	...	18	LE1D186B62(1)(2)(3)(4)(5)	8.1 (18)	LE1D186B72(1)(2)(3)(4)(5)	8.1 (18)
5	7½	15	20	30 A	J	1	...	25	LE1D256B62(1)(2)(3)(4)(5)	8.1 (18)	LE1D256B72(1)(2)(3)(4)(5)	8.1 (18)
7½	10	20	25	60 A	J	1	...	32	LE1D326C62(1)(2)(3)(4)(5)	11.7 (26)	LE1D326C72(1)(2)(3)(4)(5)	11.7 (26)
10	10	30	30	60 A	J	1	1	40	LE1D406C62(1)(2)(3)(4)(5)	12.6 (28)	LE1D406C72(1)(2)(3)(4)(5)	12.6 (28)

Enclosed full voltage reversing fusible combination starters

Max. Horsepower Ratings (AC3) 3 Phase				Fuse Clip Rating		Auxiliary Contacts		Current Rating of Contactor	Catalog Number Type 1	Weight kg (lb.)	Catalog Number Type 12/3R	Weight kg (lb.)
200 V	230 V	460 V	575 V	Amperes	UL Class	N.O.	N.C.					
2	2	5	7½	30 A	CC	2	2	9	LE2D096B62(1)(2)(3)(4)(5)	11.7 (26)	LE2D096B72(1)(2)(3)(4)(5)	11.7 (26)
3	3	7½	10	30 A	CC	2	2	12	LE2D126B62(1)(2)(3)(4)(5)	11.7 (26)	LE2D126B72(1)(2)(3)(4)(5)	11.7 (26)
5	5	10	15	30 A	J	2	2	18	LE2D186B62(1)(2)(3)(4)(5)	11.7 (26)	LE2D186B72(1)(2)(3)(4)(5)	11.7 (26)
5	7½	15	20	30 A	J	2	2	25	LE2D256B62(1)(2)(3)(4)(5)	11.7 (26)	LE2D256B72(1)(2)(3)(4)(5)	11.7 (26)
7½	10	20	25	60 A	J	2	2	32	LE2D326C62(1)(2)(3)(4)(5)	12.2 (27)	LE2D326C72(1)(2)(3)(4)(5)	12.2 (27)
10	10	30	30	60 A	J	2	2	40	LE2D406C62(1)(2)(3)(4)(5)	14.0 (31)	LE2D406C72(1)(2)(3)(4)(5)	14.0 (31)

Enclosed full voltage non-reversing circuit breaker combination starters

Max. Horsepower Ratings (AC3) 3 Phase				Auxiliary Contacts		Circuit Breaker Maximum Current Rating	Current Rating of Contactor	Catalog Number Type 1	Weight kg (lb.)	Catalog Number Type 12/3R	Weight kg (lb.)
200 V	230 V	460 V	575 V	N.O.	N.C.						
2	2	5	7½	1	-	15 A	9	LE1D097D62(1)(2)(3)(4)(5)	9.0 (20)	LE1D097D72(1)(2)(3)(4)(5)	9.0 (20)
3	3	7½	10	1	-	15 A	12	LE1D127D62(1)(2)(3)(4)(5)	9.0 (20)	LE1D127D72(1)(2)(3)(4)(5)	9.0 (20)
5	5	10	15	1	-	30 A	18	LE1D187E62(1)(2)(3)(4)(5)	9.0 (20)	LE1D187E72(1)(2)(3)(4)(5)	9.0 (20)
5	7½	15	20	1	-	30 A	25	LE1D257E62(1)(2)(3)(4)(5)	9.0 (20)	LE1D257E72(1)(2)(3)(4)(5)	9.0 (20)
7½	10	20	25	1	-	50 A	32	LE1D327F62(1)(2)(3)(4)(5)	12.2 (27)	LE1D327F72(1)(2)(3)(4)(5)	12.2 (27)
10	10	30	30	1	1	50 A	40	LE1D407F62(1)(2)(3)(4)(5)	13.0 (29)	LE1D407F72(1)(2)(3)(4)(5)	13.0 (29)

Enclosed full voltage reversing circuit breaker combination starters

Max. Horsepower Ratings (AC3) 3 Phase				Auxiliary Contacts		Circuit Breaker Maximum Current Rating	Current Rating of Contactor	Catalog Number Type 1	Weight kg (lb.)	Catalog Number Type 12/3R	Weight kg (lb.)
200 V	230 V	460 V	575 V	N.O.	N.C.						
2	2	5	7½	2	2	15 A	9	LE2D097D62(1)(2)(3)(4)(5)	10.8 (24)	LE2D097D72(1)(2)(3)(4)(5)	10.8 (24)
3	3	7½	10	2	2	15 A	12	LE2D127D62(1)(2)(3)(4)(5)	10.8 (24)	LE2D127D72(1)(2)(3)(4)(5)	10.8 (24)
5	5	10	15	2	2	30 A	18	LE2D187E62(1)(2)(3)(4)(5)	12.6 (28)	LE2D187E72(1)(2)(3)(4)(5)	12.6 (28)
5	7½	15	20	2	2	30 A	25	LE2D257E62(1)(2)(3)(4)(5)	12.6 (28)	LE2D257E72(1)(2)(3)(4)(5)	12.6 (28)
7½	10	20	25	2	2	50 A	32	LE2D327F62(1)(2)(3)(4)(5)	12.6 (28)	LE2D327F72(1)(2)(3)(4)(5)	12.6 (28)
10	10	30	30	2	2	50 A	40	LE2D407F62(1)(2)(3)(4)(5)	14.4 (32)	LE2D407F72(1)(2)(3)(4)(5)	14.4 (32)

TeSys™ D-Line Contactors and Starters

Enclosed IEC Combination Starters



LE1D406C72



LE1D097D62

Enclosed starter overload relay selection table

Code	Range	For use on Contactors
01	0.1–0.16	LC1D09–D32 ▲
02	0.16–0.25	LC1D09–D32 ▲
03	0.25–0.40	LC1D09–D32 ▲
04	0.40–0.63	LC1D09–D32 ▲
05	0.63–1.0	LC1D09–D32 ▲
06	1.0–1.6	LC1D09–D32 ▲
07	1.6–2.5	LC1D09–D32 ▲
08	2.5–4	LC1D09–D32
10	4–6	LC1D09–D32
12	5.5–8	LC1D09–D32
14	7–10	LC1D09–D32
16	9–13	LC1D12–D32
21	12–18	LC1D18–D32
22	16–24	LC1D25–D32
30	23–28	LC1D25–D32 ■
32	23–32	LC1D25–D32
53	30–38	LC1D40–D80
55	30–40	LC1D40–D80
57	37–50	LC1D40–D80
59	48–65	LC1D40–D80
61	55–70	LC1D40–D80

- ▲ Available in Class 10 only
- Available in Class 20 only

NOTE: Use of control circuit transformers requires Insta-Kit wiring.

- Control Power Transformer: Select letter from below for primary voltage of CPT.

Control Power Transformer Primary Voltage Code Table

Voltage	No Transformer used	208	240	480	600
Code	O	L	M	T	X

- Contactors/starter coil voltage: Select coil voltage from table below.

NOTE: If control transformer is used, the only options available are 24 or 120 volts as the secondary of the transformer.

Contactors Coil Voltage Table

Voltage	24	120	208	240	480	600
AC	B	G	L	U	T	X

- Coil frequency: Select: 7 = dual frequency for all starter coil selections except for 480 V or 600 V coils, on 40 A - 80 A starters select 6, 60 Hz only.
- Overload relay type: Select: 0 = No overload relay, 1 = Trip Class 10, 2 = Trip Class 20.
- Overload relay range: Select code from page 155.

NOTE: If no overload relay is required, leave this portion of the catalog number blank.

TeSys™ D-Line Contactors and Starters Enclosed IEC Combination Starters

Factory Modifications and Insta-Kit Selection

Add the Factory Modification Code to the end of the catalog number created from pages 151 and 152. Only one operator scheme (factory modification code or field-installable Insta-Kit option) can be used. Only the combinations of operators and pilot lights shown below can be ordered. Pilot lights will be at the coil voltage indicated in the catalog number for the starter.

LA9FF4TK	All Others	
 E61239 CCN XPTQ CCN XPTQ7	 E154118 CCN NLDX CCN NLDX7	 LR23506 41 Class 3211 04

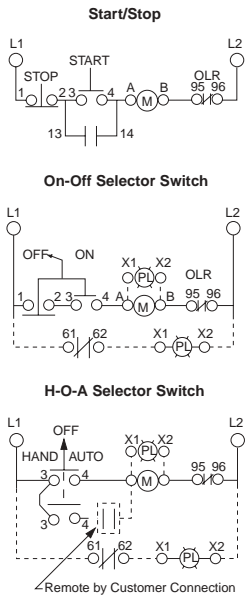

Description	Factory Modification Code ▲	Insta-Kits (for field installation)
Control Units Only		
For-Rev-Stop Push Button	A06L	LA9CA06LT
Start/Stop Push Button	A06G	LA9CA06GT
I/O (Start/Stop) Push Button	N/A	N/A
I/O Push Button (double touch)	A06I	LA9CA06IO
Emergency Stop	N/A	N/A
Start / Mushroom Head Stop Push Button	A06X	LA9CA06XT
Hand-Off-Auto Selector Switch	A06E	LA9CA06ET
On/off Selector Switch	A06D	LA9CA06DT
Pilot Lights only		
LED Pilot light, 24, 120 or 240 V	A16S	LA9CA16ST ★
Green-Red Pilot Light, 120 V ■	A06S	LA9CA06ST
Green-Red Transformer Pilot Light, 120, 208/240, 480 or 600 V ■	A06F	LA9CA06FT ★
Available combination of control units and pilot lights		
Hand-Off-Auto Selector Switch, 120 V LED Pilot Light	A16U	LA9CA16UT ★
Start/Stop Push Button w/ 24, 120 or 240 V LED Pilot Light	A16V	LA9CA16VT ★
On/off Selector w/ 24, 120 or 240 V LED Pilot Light	A16W	LA9CA16WT ★
Start/Stop Push Button w/ Green-Red Transformer Pilot Light	A06N	LA9CA06NT ★
Start/Stop Push Button w/Green-Red Pilot Light	A06G	LA9CA06VT
Hand-Off-Auto Selector Switch w/Green-Red Pilot Light 120 V	A06U	LA9CA06UT
Hand-Off-Auto Selector Switch w/Green-Red Transformer Pilot Light	A06J	LA9CA06JT ★
On/Off Selector w/Green-Red Pilot Light	A06W	LA9CA06WT
On/Off Selector w/Green-Red Transformer Pilot Light	A06H	LA9CA06HT ★
Control Power Transformer		
Standard VA, 2 fuses in Primary, 1 Fuse in secondary	A206P	◆
50 VA extra, 2 fuses in Primary, 1 Fuse in secondary	A207P	◆
100 VA extra, 2 fuses in Primary, 1 Fuse in secondary	A208P	◆
Local / Remote Adapter, 3-wire ●	-	LA9AADIS3
Local / Remote Adapter, 4-wire ●	-	LA9AADIS4
Local / Remote Adapter, 5-wire ●	-	LA9AADIS5
Local / Remote Adapter, 7-wire ●	-	LA9AADIS7

- ▲ Add these forms to the catalog number selected on pages 151 or 152. The numbers as shown are for use in NEMA 1 Enclosures. For uses in NEMA 12/3R change the 6 to a 7 (ex A06U becomes A07U). The change DOES NOT apply to control power transformer forms or Insta-Kits.
- Pilot lights are wired such that the light is on when the contactor is energized. For non-LED type pilot lights, a green lens is installed on the unit when shipped. A red lens is included for use as applicable.
- ◆ Select Insta-Kit from table below.
- ★ Complete the catalog number for the Insta-Kit by selecting the voltage code from the appropriate tables below.
- 3-wire adapter required when START/STOP pushbutton remote station is used in conjunction with START/STOP local control OR if local pilot light only is used.
- 4-wire adapter required when FOR/REV/STOP is required for both local and remote control.
- 5-wire adapter required when START/STOP pushbutton with pilot light remote station OR pilot light only remote is used with START/STOP pushbutton local control.
- 7-wire adapter required for remote control only applications.

Total VA	Insta-Kit Catalog Number	Weight / kg (lb.)
50	LA9TFD32 ★	0.80 (1.75)
100	LA9TFD80 ★	1.45 (3.25)

Voltage Codes for pilot lights

Voltage (Vac)	24	120	208/240	480	600
Code	B	G	M	T	X

Voltage Codes for control power transformers

Primary Voltage	120	208	240	480	600	208	240	480	600
Secondary Voltage	24					120			
Code	E	D	C	B	A	L	M	T	X

TeSys™ D-Line Contactors and Starters

Dimensions for Enclosed Combination and Non-Combination IEC Starters

Combination Starter Dimensions with Rotary Disconnect Handle - Type 1

Knockout Schedule

Knockout	Conduit Size, in. (mm)
A	0.50 (12.7)
B	1.00 (25.4); 1.25 (31.8)
C	0.50 (12.7); 0.75 (19.05)

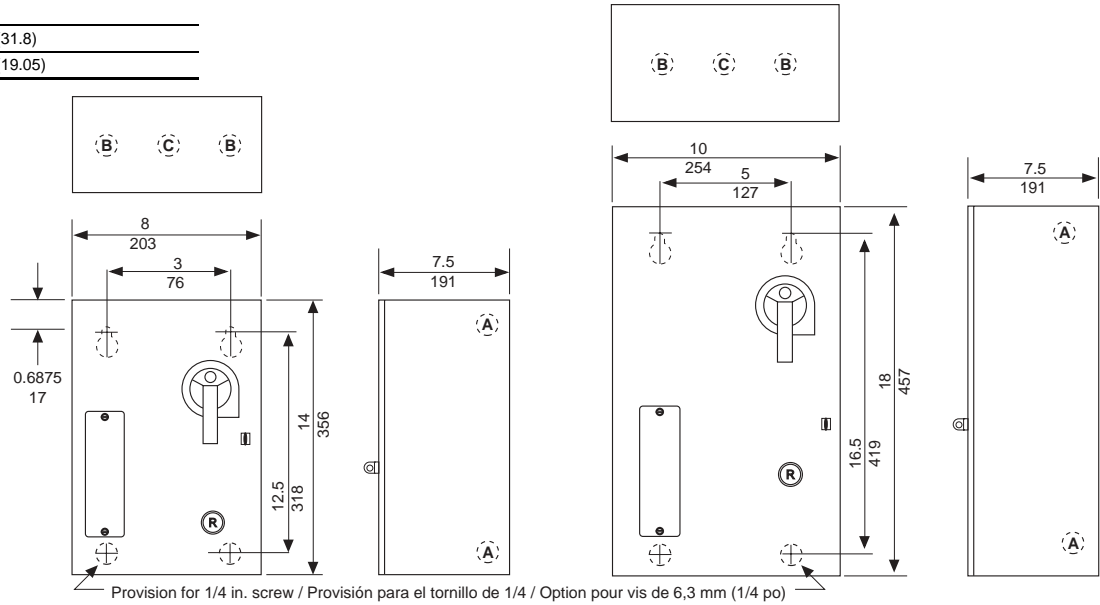

Dual Dimensions: $\frac{\text{Inches}}{\text{mm}}$

D09-25 (FVNR)

D09-40 (FVR); D32-40 (FVNR)

Type 12

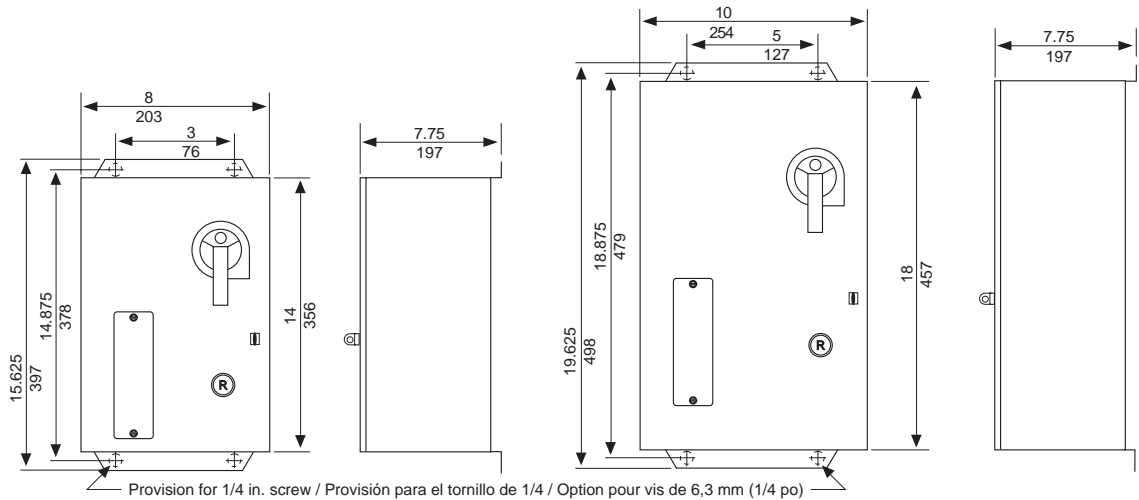

D09-25 (FVNR)

D09-40 (FVR); D32-40 (FVNR)

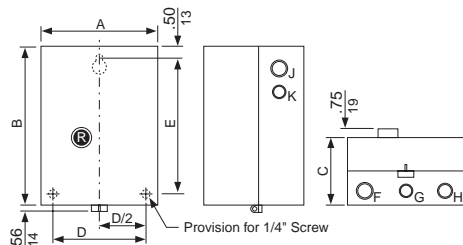

Non-combination Starter Dimensions

Non-reversing	Reversing	TYPE 1										TYPE 12/3R	
		A	B	C	D	E	F	G	H	J	K	D	E
D09-25	...	6.77 172	10.04 255	6.25 158	5.38 136	9.00 228	1-1/4 25.4-31.7	1/2-3/4 12.7-19	-	1-1/4 25.4-6.3	1/2-3/4 12.7-19	5.38 13.6	11.37 288
D32-50	D09-32	8.66 220	10.83 275	7.21 183	7.25 184	9.75 247	1 1/4-1 1/2 31.7-38.1	1/2-3/4 12.7-19	1-1 1/4 25.4-31.7	1-1/4 25.4-6.3	1/2-3/4 12.7-19	5.38 13.6	12.15 308
D65-80	D40-80	10.63 270	13.98 355	7.21 183	9.22 234	12.94 328	1 1/4-1 1/2 31.7-38.1	1/2-3/4 12.7-19	1-1 1/4 25.4-31.7	1-1 1/4 25.4-6.3	1/2-3/4 12.7-19	5.38 13.6	15.30 385

TeSys™ D-Line Contactors and Starters

Schematics for Enclosed IEC Non-Combination Starters

Non-Reversing, Non-Combination 3-Phase Starter

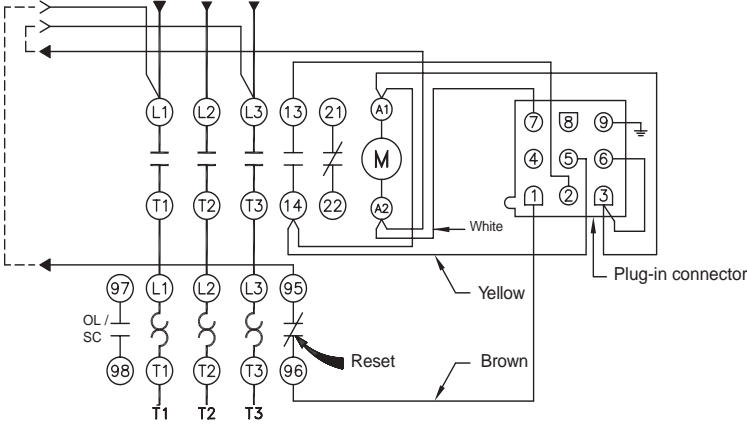

Reversing, Non-Combination 3-Phase Starter

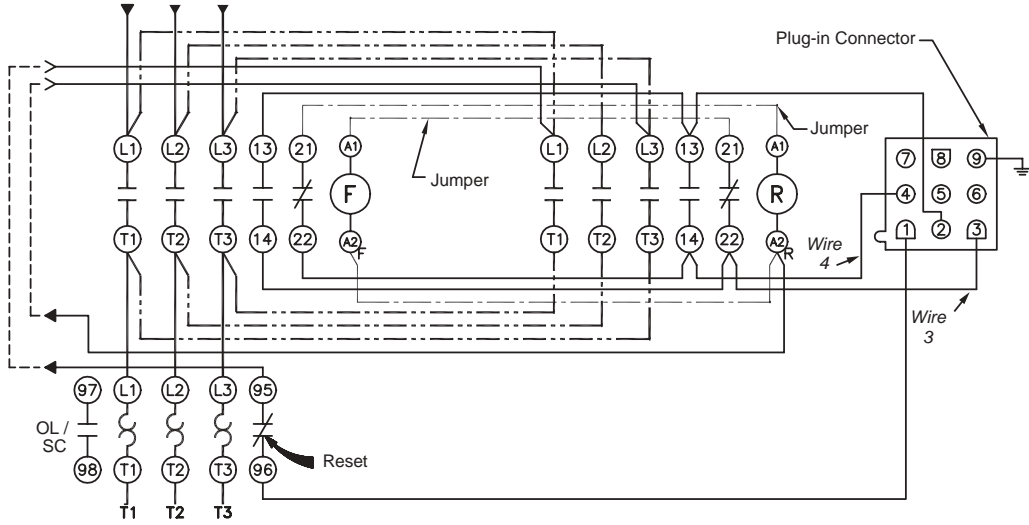

TeSys™ D-Line Contactors and Starters

Enclosed Contactors LE1D and LE2D

International Applications Only

D.O.L. AC Starters for Motor Control (1) 2.2 to 45 kW, without Isolator Device

Characteristics

Conforming to standards	IEC 60947-4-1 and IEC 60439-1, VDE 0660-102, EN 60947
Degree of protection to IEC 60529	IP 659: LE2K, IP 657: LE●D09 to D35 and IP 557: LE●D405 to D955
Ambient air temperature	For operation: - 5 to + 40 °C (- 41 to + 104 °F)
Operating positions	Identical to positions for contactors
Material	Poly carbonate (2): LE2K and LE●D09 to D35. Sheet steel: LE●D405 to D955

Non-reversing Starters

Standard Power Ratings of 3-phase Motors 50/60 Hz in Category AC-3 (kW)						Maximum Current I the up to	Catalog Number, Complete with Control Circuit Voltage Code (3)	Standard Voltages	Weight lbs (kg)
220 230 V	380 400 V	415V	440 V	500 V	660 690 V				
2.2	4	4	4	5.5	5.5	9	LE1D09●●	F7 P7 V7	2.03 (0.92)
3	5.5	5.5	5.5	7.5	7.5	12	LE1D12●●	F7 P7 V7	2.03 (0.92)
4	7.5	9	9	10	10	18	LE1D18●●	F7 P7 V7	2.24 (1.015)
5.5	11	11	11	15	15	25	LE1D25●●	F7 P7 V7	2.24 (1.015)
7.5	15	15	15	18.5	18.5	35	LE1D35●●	F7 P7 V7	9.53 (4.320)
11	18.5	22	22	22	30	40	LE1D405●●	F7 P7 V7	10.63 (4.82)
15	22	25	30	30	33	50	LE1D505●●	F7 P7 V7	10.69 (4.85)
18.5	30	37	37	37	37	65	LE1D655●●	F7 P7 V7	10.69 (4.85)
22	37	45	45	55	45	80	LE1D805●●	F7 P7 V7	11.33 (5.14)
25	45	45	45	55	45	95	LE1D955●●	F7 P7 V7	12.0 (5.44)



LE1D12●●

Reversing Starters

1.5	2.2	2.2	3	–	–	6	LE2K065●●	F7 P7 V7	2.38 (1.08)
2.2	4	4	4	–	–	9	LE2K095●●	F7 P7 V7	2.38 (1.08)
–	–	–	–	5.5	5.5	9	LE2D09●●	F7 P7 V7	4.63 (2.100)
–	–	–	–	5.5	5.5	9	LE2D09●●	F7 P7 V7	4.63 (2.100)
3	5.5	5.5	5.5	7.5	7.5	12	LE2D12●●	F7 P7 V7	4.63 (2.100)
4	7.5	9	9	10	10	18	LE2D18●●	F7 P7 V7	5.31 (2.410)
5.5	11	11	11	15	15	25	LE2D25●●	F7 P7 V7	5.66 (2.570)
7.5	15	15	15	18.5	18.5	35	LE2D35●●	F7 P7 V7	9.0 (4.100)
11	18.5	22	22	22	30	40	LE2D405●●	F7 P7 V7	11.6 (5.270)
15	22	25	30	30	33	50	LE2D505●●	F7 P7 V7	12.06 (5.470)
18.5	30	37	37	37	37	65	LE2D655●●	F7 P7 V7	12.06 (5.470)
22	37	45	45	55	45	80	LE2D805●●	F7 P7 V7	14.77 (6.700)
25	45	45	45	55	45	95	LE2D955●●	F7 P7 V7	15.43 (7.000)



LE2D12●●

- (1) Protection must be provided by addition of an overload relay, to be ordered separately, see pages 134 and 135.
- (2) Avoid placing this material in contact with harsh substances (detergents, chlorinated solvents, ketones, alcohol, aromatic hydrocarbons).
- (3) Standard control circuit voltages.

Volts AC 50/60 Hz	24	42	48	110	115	220	230	240	380	400	415	440
LE2K	B7	D7	E7	F7	–	M7	P7	U7	Q7	V7	N7	R7
LE1, LE2D	B7	D7	E7	F7	FE7	M7	P7	U7	Q7	V7	N7	R7

For other voltages please consult your Regional Sales Office.

- (4) Selection according to the number of operating cycles, please consult your Regional Sales Office.

TeSys™ D-Line Contactors and Starters

Enclosed Contactors LE1D and LE2D



LE1D12••A04

D.O.L. AC Starters for Motor Control (1) 2.2 to 45 kW without Isolator Device, Non-reversing

Description

Standard versions comprise:

- For non-reversing starters:
 - 1 green Start button "I",
 - 1 red Stop/Reset button "O".
- For reversing starters:
 - 1 Start button ↑,
 - 1 Start button ↓,
 - 1 red Stop/Reset button.
- LE2K:
- LE2D09 to D35:
 - 1 2-position spring return selector switch "I"- "II",
 - 1 red Stop/Reset button "O".
- LE2D405 to D955:
 - 1 blue Reset button "R".



LE1D12••A05

Forms (installed by Telemecanique)

Description	For Use On	Suffix to be Added to Starter Catalog Number (2)
No push buttons on cover	LE1D09 through D955 LE2D09 through D955	A04
1 green Start button "I" 1 green Start button "II" 1 red Stop/Reset button "O"	LE2D405 through D955	A11
1 blue Reset button "R"	LE1D09 through D955 LE2K06 and K09 LE2D09 through D35	A05
1 3-position stay put selector switch ("I"- "O"- "II") ("I": Automatic Start; "O": Stop; "II": Manual Start) 1 blue Reset button "R"	LE1D09 through D35	A09
1 2-position stay put selector switch ("O"- "I") ("O": Stop; "I": Manual Start) 1 blue Reset button "R"	LE1D09 through D35	A13
1 3-position stay put selector switch "O"- "I" with spring return to center position ("I": Manual start; "O": Stop, stay put) 1 blue Reset button "R"	LE1D09 through D35	A35
1 neutral terminal Fitted as standard on LE1 and LE2D18 to D955 starters ordered with 220 V (M7), 230 V (P7) or 240 V (U7) control circuit voltage.	LE1D09 through D955 LE2K06 and K09 LE2D09 through D955	A59



LE1D12••A09

Accessories (installed by the customer)

Description	For Use On	Catalog Number	Weight lbs (kg)
Start pushbutton latching device for stay-put operation (Start-Stop)	LE1D405 through D955	LA9D09907	0.13 (0.06)

(1) See previous page.

(2) Example: **LE1D093F7A04**

Other versions: Combination of 2 accessories, please consult your Regional Sales Office.



LE1D12••A13



LE1D12••A35

TeSys™ D-Line Contactors and Starters

Enclosed Contactors with Fused Disconnect Switch LE2, LE4, and LE8

International
Applications Only

D.O.L. AC Starters for Motor Control (1), 2.2 to 45 kW with Isolator Device

Characteristics

Conforming to standards	IEC 60947-4-1 and IEC 60439-1, VDE 0660-102, EN 60947
Degree of protection to IEC 529	IP 659: LE•K, IP 657: LE•D09 to D35 and IP 55: LE•D406 to D806
Ambient air temperature	For operation: - 5 to + 40 °C (- 41 to + 104 °F)
Operating positions	Identical to positions for contactors
Material	Poly carbonate (2): LE•K and LE•D09 to D35. Sheet steel: LE•D406 to D806

Non-reversing Starters



LE4D12**



LE8D12**

Standard Power Ratings of 3-phase Motors 50/60 Hz in Category AC-3 (kW)						Operational Current (A) 440 V up to	Fuses to be fitted by the customer		Catalog Number, Complete with Control Circuit Voltage Code (3)	Weigh lbs (kg)
220 230 V	380 400 V	415V	440 V	500 V	660 690 V		Size	Type aM A		
1.5	2.2	2.2	3	-	-	6	10 X 38	10	LE4K065**	3.19 (1.45)
2.2	4	4	4	-	-	9	10 X 38	12	LE4K095**	3.19 (1.45)
2.2	4	4	4	5.5	-	9	10 X 38	12	or LE4D09** (4)	4.32 (1.96)
3	5.5	5.5	5.5	7.5	-	12	10 X 38	16	LE4D09**	4.32 (1.96)
4	7.5	9	9	10	-	18	10 X 38	20	LE4D12**	4.32 (1.96)
5.5	11	11	11	15	-	25	10 X 38	25	LE4D18**	4.85 (2.20)
7.5	15	15	15	18.5	18.5	35	14 X 51	32	LE4D25**	4.85 (2.20)
11	18.5	22	22	22	30	40	14 X 51	40	LE4D35**	11.4 (5.19)
15	22	25	30	30	33	50	22 X 58	63	LE4D406**	12.7 (5.77)
18.5	30	37	37	37	37	65	22 X 58	80	LE4D506**	14.2 (6.44)
22	37	45	45	55	45	80	22 X 58	80	LE4D656**	14.7 (6.67)
									LE4D806** (5)	15.6 (7.10)

Reversing Starters

1.5	2.2	2.2	3	-	-	6	10 X 38	10	LE8K065**	3.52 (1.60)
2.2	4	4	4	-	-	9	10 x 38	12	LE8K095**	3.52 (1.60)
-	-	-	-	5.5	-	9	10 x 38	12	or LE8D09** (4)	7.82 (3.55)
3	5.5	5.5	5.5	7.5	-	12	10 x 38	16	LE8D09**	7.82 (3.55)
4	7.5	9	9	10	-	18	10 x 38	20	LE8D12**	7.82 (3.55)
5.5	11	11	11	15	-	25	10 x 38	25	LE8D18**	8.16 (3.70)
7.5	15	15	15	18.5	18.5	35	14 x 51	32	LE8D25**	10.3 (4.67)
11	18.5	22	22	22	30	40	14 x 51	40	LE8D35**	12.8 (5.80)
15	22	25	30	30	33	50	22 x 58	63	LE2D406**	31.24 (14.17)
18.5	30	37	37	37	37	65	22 x 58	80	LE2D506**	32.40 (14.17)
22	37	45	45	55	45	80	22 x 58	80	LE2D656**	32.56 (14.77)
									LE2D806**	35.30 (16.00)

- (1) Protection must be provided by addition of an overload relay, to be ordered separately, see pages 134 and 135.
- (2) Avoid placing this material in contact with harsh substances (detergents, chlorinated solvents, ketones, alcohol, aromatic hydrocarbons).
- (3) Standard control circuit voltages.

Volts AC 50/60 Hz	24	42	48	110	115	220	230	240	380	400	415	440
LE•K	B7	D7	E7	F7	-	M7	P7	U7	Q7	V7	N7	R7
LE•D	B7	D7	E7	F7	FE7	M7	P7	U7	Q7	V7	N7	R7

For other voltages please consult your Regional Sales Office.

- (4) Selection according to dimensions and the number of operating cycles, please consult your Regional Sales Office.
- (5) Supplied with 3 cable entries.

TeSys™ D-Line Contactors and Starters

Enclosed Reversing Starters with Fused Disconnect Switch LE2, LE4 and LE8

International
Applications Only

D.O.L. AC Starters for Motor Control (1) 2.2 to 45 kW with Isolator Device



LE4D12••A04

Description

Standard versions comprise:

- For non-reversing starters:
 - LE4K and LE4D09 to D656: 1 green Start button "I",
1 red Stop/Reset button "O".
 - LE4D806: no pushbuttons on cover.
- For reversing starters:
 - LE8K: 1 Start button ↑,
1 Start button ↓,
1 red Stop/Reset button.
 - LE8D09 to D35: 1 2-position spring return selector switch "I"- "II",
1 red Stop/Reset button "O".
 - LE2D406 to D806: no pushbuttons on cover

Protection	Power Circuit	Control Circuit
LE4 and LE8K	1 3-pole isolating device	None
LE4 and LE8D09 to D35	1 3-pole isolating device	+ 1 additional pole LA8D254
LE4 and LE2D406 to D806	1 3-pole isolating device	+ 1 circuit-breaker GB2CB08



LE4D12••A05

Forms (installed by Telemecanique)

Description	For Use On	Suffix to be Added to Starter Catalog Number (2)
No push buttons on cover	LE4D09 through D656 LE8D09 through D35	A04
1 green Start button "I" 1 green Start button "II" 1 red Stop/Reset button "O"	LE2D406 through D806	A11
1 blue Reset button "R"	LE4D09 through D806 LE8K06 and K09 LE2D406 through D806	A05
1 neutral terminal Fitted as standard on LE4D18 to D806, LE8D18 to D35 and LE4D406 to D806 starters ordered with 220 V (M7), 230 V (P7) or 240 V (U7) control circuit voltage.	LE4K06 and K09 LE4D09 through D806 LE8K06 and K09 LE8D09 through D35 LE2D406 through D806	A59

Accessories (installed by the customer)

Description	For Use On	Catalog Number	Weight lbs (kg)
Start pushbutton latching device for stay-put operation (Start-Stop)	LE4D406 through D656	LA9D09907	0.13 (0.06)

(1) See previous page.

(2) Example: **LE4D09F7A04**

Other versions: Combination of 2 accessories, please consult your Regional Sales Office.

TeSys™ D-Line Contactors and Starters

Wye-delta Starters LE3D (International Applications Only)

Wye-Delta Starters for Motor Control from 4 to 75 kW, without Off-Load Isolator (1) - References

Selection



LE3D12**

Standard Power Ratings of Squirrel Cage Motors Mains Voltage - Delta Connection (kW)				Catalog Number, Complete with Control Circuit Voltage Code (2)	Normal Control Circuit Voltage Code	Weight lbs (kg)
220 V	380 V	415V	440 V			
Maximum operating rate in starts/hour: LE3-K: 12 and LE3-D: 30. Maximum starting time: 30 seconds. (4)						
3	5.5	5.5	5.5	LE3K065**	F7 M7 Q7	3.22 (1.46)
4	7.5	7.5	7.5	LE3K095**	F7 M7 Q7	3.22 (1.46)
				or LE3D09**	F7 M7 Q7	8.05 (3.65)
5.5	11	11	11	LE3D12**	F7 M7 Q7	8.05 (3.65)
11	18.5	22	22	LE3D18**	F7 M7 Q7	8.27 (3.75)
15	25	30	30	LE3D32**	F7 M7 Q7	11.38 (5.16)
18.5	37	37	37	LE3D405**	F7 M7 Q7	17.99 (8.16)
30	55	59	59	LE3D505**	F7 M7 Q7	17.97 (8.15)
37	75	75	75	LE3D805**	F7 M7 Q7	30.87 (14.00)

Specifications

Enclosure	LE3D09 through D80	Metal Enclosure, IP 559
Control (2 push buttons mounted on enclosure cover)	LE3D09 through D18	1 green start button "I" 1 red stop/reset button "O"
No push buttons on cover	LE3D32 through D80	-
Connections	LE3K06 and K09	Pre-wired power and control circuit connections

A timer LA2-DS2 imposes a delay of 40 ms ± 15 ms on the delta contactor at the moment of changeover to ensure that the star contactor has sufficient breaking time.

Forms (installed by Telemecanique)

Description	For Use On	Suffix to be Added to Starter Catalog Number (5)
No push buttons on cover	LE3D09 through D18	A04
1 blue reset button "R"	LE3D09 through D80	A05
1 green start button "I" 1 red stop/reset button "O"	LE3D32 through D80	A06
1 neutral terminal Fitted as standard on starters ordered with 240 V (U7) control circuit voltage.	LE3K06 and K09 LE3D09 through D80	A59
Mechanical interlock Fitted as standard on starters LE3K and LE3D09 to D35	LE3D405 TO D150	A64

Control Circuit Voltage Codes

LE3-K (6)																
Control Voltage 50/60 Hz	12	24	36	42	48	110	127	220/230	230	230-240	380/400	400	400/415	440	500	660/690
Code	J7	B7	C7	D7	E7	F7	FC7	M7	P7	U7	Q7	V7	N7	R7	S7	Y7
LE3-D (6)																
Control Voltage 50/60 Hz	24	42	48	110	220/230	230	240	380/400	400	415	440					
Code	B7	D7	E7	F7	M7	P7	U7	Q7	V7	N7	R7					

- (1) Overload protection by thermal overload relay, to be ordered separately. Select appropriate overload relay for setting at 0.58 the full load rated motor current.
 - (2) Standard control circuit voltages (variable delivery time, please consult your Regional Sales Office).
 - (4) Selection according to size and number of operating cycles (see AC-3 curves, page 20).
 - (5) Example: LE3-D095F7A04.
 - (6) Other voltages: For LE3-K, please consult your Regional Sales Office.
- Other versions: Combination of 2 accessories, please consult your Regional Sales Office.

TeSys™ D-Line Contactors and Starters

Wye-delta Starters with Fused Disconnect Switch LE3D (International Applications Only)

International Applications Only

NOTE: Wiring methods differ from typical North American practice. Contains UL Listed, CSA Certified, and CE marked components. Assemblies are not UL Listed or CSA Certified.



LE6D12**

Standard power ratings of squirrel cage motors Mains voltages - delta connection				Fuses to be installed by customer		Catalog Number ■ ▼	Weight
220 V	380 V	415 V	440 V	Size	Type aM		
kW	kW	kW	kW		A		kg (lb.)
Maximum operating rate: 30 starts/hour. Maximum starting time: 30 seconds.							
4	7.5	7.5	7.5	10 x 38	20	LE6D09**	3.900 (8.598)
5.5	11	11	11	10 x 38	25	LE6D12**	3.900 (8.598)
11	18.5	22	22	14 x 51	40	LE6D18**	4.850 (10.692)
15	25	30	30	22 x 58	63	LE6D326**	7.650 (16.865)
18.5	37	37	37	22 x 58	80	LE3D406**	16.90 (37.256)
30	55	59	59	22 x 58	125	LE3D506**	17.00 (37.478)
37	75	75	75	0	160	LE3D806**	27.50 (60.626)

Specifications

Enclosure	LE3D09 to LE3D80	Metal enclosure, degree of protection IP 559
Control (2 pushbuttons on enclosure cover)	LE3D09 and LE3D12	1 green Start button "I" 1 red Stop/Reset button "O"
No pushbuttons on cover	LE3D18 to LE3D80	–
Isolator with external operator	LE3D09 and LE3D12	1 3-pole isolator + 1 additional pole LA8D254
	LE3D18 to LE3D80	1 3-pole isolator and 1 circuit breaker GB2-CB08
Connections	LE3D09 to LE3D80	Pre-wired power and control circuit connections

A timer LA2DS2 imposes a delay of 40 ms ± 15 ms on the delta contactor at the moment of changeover to ensure that the star contactor has sufficient breaking time.

- Overload protection by means of bimetallic overload relay, to be ordered separately. Select appropriate overload relay for setting at 0.58 of the full-load rated motor current.
- ▼ Complete catalog number with appropriate coil selection code below.

Coil Selection

50/60 Hz	24	42	48	110	220/230	230	240	380/400	400	415	440
Voltage Code	B7	D7	E7	F7	M7	P7	U7	Q7	V7	N7	R7



LE6D12**A04

Forms (installed by Telemecanique)

Description	For use on	Suffix to be added to starter catalog number ●
No pushbuttons on cover	LE3D09 to LE3D12	A04
1 blue Reset button "R"	LE3D09 to LE3D80	A05
1 green Start button "I" 1 red Stop/Reset button "O"	LE3D18 to LE3D80	A06
1 neutral terminal Fitted as standard on starters ordered with 240 V (U7) control supply	LE3D09 to LE3D80	A59
Mechanical interlock Fitted as standard on starters LE6D09 to D18	LE3D326 to D80	A64

- For example: LE3D096F7A04.



LE6D12**A05

TeSys™ D-Line Contactors and Starters

Spare Parts and Accessories (International Applications Only)



ZB5AA331

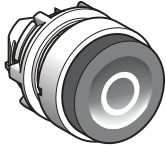

ZB5AL432

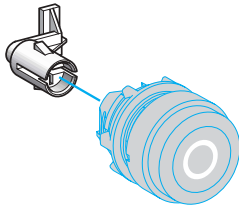

LAD9091



ZB5AD•

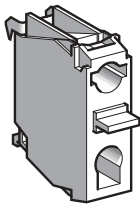

ZENL1111

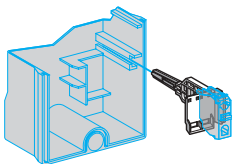

LAD91809

Operating Heads for Start and Stop/Reset Pushbuttons

Description	For use on	Catalog Number	Weight – kg (lb.)
Flush green "I" (1)	LE1D09 to D35	ZB5AA331	0.018 (0.040)
Projecting red "O" (1)	LE1D09 to D35	ZB5AL432	0.019 (0.042)
Mounting kit for head ZB5AL432	LE1D09 and D12	LAD9091	0.002 (0.004)
	LE1D18 to D35	LAD91810	0.003 (0.006)

Operating Heads for Reset Pushbuttons

Flush blue "R" (2)	LE1D09 to D35	ZB5AA0	0.022 (0.048)
		ZBA639 (3)	0.001 (0.002)
Mounting kit for head ZB5AA0 + ZBA639	LE1D09 and D12	LAD9092	0.002 (0.004)
	LE1 or LE2D18 to D35	LAD91810	0.003 (0.006)
	LE3, LE6, LE4 or LE8D09 to D35	LAD9T4	0.004 (0.008)

Operating Heads for Selector Switches

Description	For use on	Catalog Number	Weight – kg (lb.)
3 position stay put	LE1D09 to D35	ZB5AD3	0.024 (0.053)
2 position stay put	LE1D09 to D35	ZB5AD2	0.024 (0.053)
3 position spring return to center	LE1D09 to D35	ZB5AD5	0.024 (0.053)

Contact Blocks

1 N.O. spring return	LE1D09 to D35	ZENL1111	0.010 (0.022)
1 N.C. spring return	LE1D09 to D35	ZENL1121	0.010 (0.022)
Contact block support	LE1D09 and D12	LAD90909	0.008 (0.017)
	LE•D18 to D35 (4)	LAD91809	0.014 (0.031)

- (1) Remember to order mounting kit **LAD9091** or **LAD91810**, depending on the size.
- (2) Remember to order mounting kit **LAD9092**.
- (3) Sold in lots of 10.
- (4) LE1, LE2, LE3, LE4, LE6 or LE8.

TeSys™ D-Line Contactors and Starters
Spare Parts and Accessories (International Applications Only)



DE1DS1A04



DE1DS1A05



DE1DS1



DE1DS1A13

Empty Enclosures for D.O.L. Starters Without Isolator Device

For use with	Push button operating head(s) or blanking plug(s) mounted on the cover	Catalog Number	Weight
			kg (lb.)
LE1D09, D12	Without	DE1DS1A04	0.300 (0.66)
	1 flush blue head "R"	DE1DS1A05	0.300 (0.66)
	1 flush green head "I" 1 projecting red head "O"	DE1DS1	0.300 (0.66)
	1 flush blue head "R" 1 switch	DE1DS1A13	0.300 (0.66)
LE1D18 to D35	Without	DE1DS2A04	0.500 (1.10)
	1 flush blue head "R"	DE1DS2A05	0.500 (1.10)
	1 flush green head "I" 1 projecting red head "O"	DE1DS2	0.500 (1.10)
	1 flush blue head "R" 1 switch	DE1DS2A13	0.500 (1.10)

TeSys™ D-Line Contactors and Starters LE-D Dimensions (International Applications Only)

Enclosed D-line Starters Without Fused Disconnect Switch

LE1D09 and D12	LE1D18 to D35 LE2D09 to D35	LE1D405 to D655
c1	c1 LE1D LE2D	c1
Standard version 5.05 (128.5)	Standard version 6.0 (153.5) 6.3 (160)	Standard version 6.33 (161)
Version A04 4.7 (120)	Version A04 5.7 (145) 5.7 (145)	Version A04 5.9 (150)
Version A05 5.05 (128.5)	Version A05 6.0 (153.5) 6.0 (153.5)	Version A05 6.33 (161)
Version A09 5.31 (135)	Version A09 6.3 (160) —	
Version A13 5.31 (135)	Version A13 6.3 (160) —	
Version A35 5.31 (135)	Version A35 6.3 (160) —	

LE2D095, LE2D125, LE2D185, LE2D255

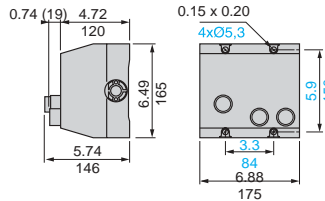

Dual Dimensions: Inches
mm

LE1D805 and D955 LE2D405 to D655	LE2D805 and D955
c1 LE1D LE2D	c1
Standard version 6.9 (176) 6.9 (176)	Standard version 7.6 (194)
Version A04 6.5 (165) 6.5 (165)	Version A04 7.48 (190)
Version A05 6.9 (176) —	Version A05 7.6 (194)
Version A11 — 6.9 (176)	

Knock-outs or Blanking Plugs for Cable Glands

Type of Enclosure	At top		At bottom	
	PG	ISO	PG	ISO
LE1D09 and D12	2 x 13 or 2 x 16	2 x 20 I	2 x 13 or 2 x 16	2 x 20 I
LE1D18 to D35 and LE2D09 to D35	2 x 16 or 2 x 21	2 x 20 I or 2 x 25 I	2 x 16 or 2 x 21	2 x 20 I or 2 x 25 I
LE2D405	1 x 13 and 1 x 21	1 x 20 I and 1 x 25 I	1 x 13 and 2 x 21	1 x 20 I and 2 x 25 I
LE1D405 to D655 and LE2D505 and D655	1 x 13 and 1 x 29	1 x 20 I and 1 x 32 I	1 x 13 and 2 x 29	1 x 20 I and 2 x 32 I
LE1 or LE2D805 and D955	1 x 13 and 1 x 36	1 x 20 I and 1 x 40 I	1 x 13 and 2 x 36	1 x 20 I and 2 x 40 I
LE2K	2 x 13 and 2 x 16	4 x 20 I	2 x 13 and 2 x 16	4 x 20 I

(millimeters x 0.0394 = inches)

TeSys™ D-Line Contactors and Starters

LE-D Dimensions (International Applications Only)

Enclosed D-line Starters With Fused Disconnect Switch

LE4K06 and K09
LE8K06 and K09

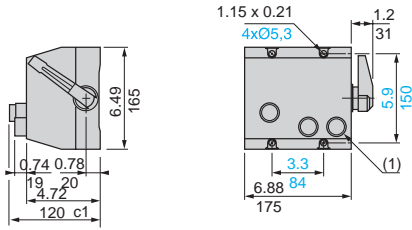

LE4D09 to D35
LE8D09 to D35

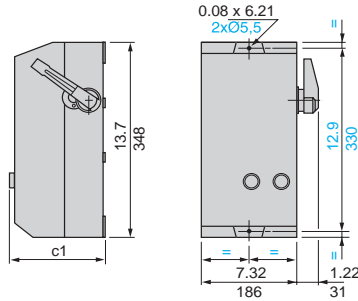

	c1		c1	
	LE4K	LE8K	LE4D	LE8D
Standard version	5.74 (146)	5.74 (146)	6.90 (175.5)	7.16 (182)
Version A05	—	5.47 (139)	6.57 (167)	6.57 (167)
Version A05			6.90 (175.5)	6.90 (175.5)

(1) For LE8 only.

LE4D406 to D656

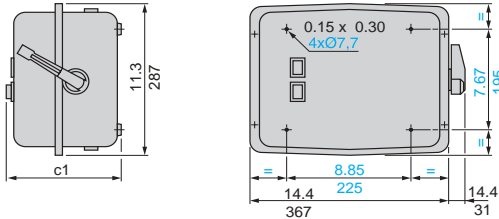

Dual Dimensions: Inches
mm

	c1
Standard version	7.91 (201)
Version A04	7.48 (190)
Version A05	7.91 (201)

LE2D406 to D806

LE4D806

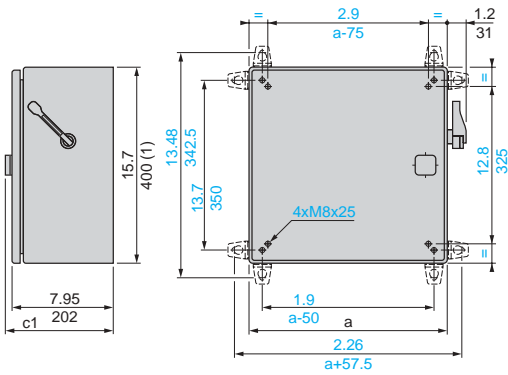

LE2	a	
D406, D506, D656	11.8 (300)	
D806	15.7 (400)	
LE4	a	
D806	15.7 (400)	
c1'		
LE2D	LE4D	
Standard version	8.58 (218)	8.58 (218)
Version A05	8.58 (218)	8.58 (218)
Version A11	—	8.58 (218)

(1) + 14 mm with blanking plugs

Knock-outs or Blanking Plugs for Cable Glands

Type of Enclosure	At top		At bottom	
	PG	ISO	PG	ISO
LE4 and LE8D09 to D35	2 x 13 or 2 x 16 or 2 x 21 or 2 x 29	2 x 20 I or 2 x 25 I or 2 x 32 I or 2 x 40 I	2 x 13 or 2 x 16 or 2 x 21 or 2 x 29	2 x 20 I or 2 x 25 I or 2 x 32 I or 2 x 40 I
LE2D09 to D35	1 x 16 or 2 x 21	2 x 20 I or 2 x 25 I	2 x 16 or 2 x 21	2 x 20 I or 2 x 25 I
LE2D406 and LE4D406	1 x 13 and 1 x 21	1 x 20 I and 1 x 25 I	1 x 13 and 2 x 21	1 x 20 I and 2 x 25 I
LE1D506 to D656 and LE4D506 and D656	1 x 13 and 1 x 29	1 x 20 I and 1 x 32 I	1 x 13 and 2 x 29	1 x 20 I and 2 x 32 I
LE2D806 and LE4D806	1 x 13 and 1 x 36	1 x 20 I and 1 x 40 I	1 x 13 and 2 x 36	1 x 20 I and 2 x 40 I
LE4K, LE8K	2 x 13 and 2 x 16	4 x 20 I	2 x 13 and 2 x 16	4 x 20 I

(millimeters x 0.0394 = inches)

TeSys™ D-Line Contactors and Starters LE-K Dimensions (International Applications Only)

Enclosed K-line Starters Without Fused Disconnect Switch

LE3K065, K095

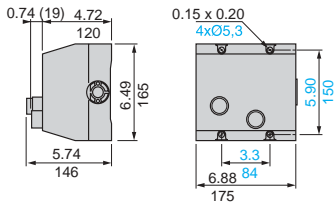

LE3D09 to D35

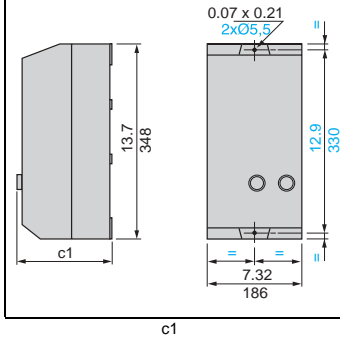

Standard version	6.90 (175.5)
Version A04	6.57 (167)
Version A05	6.90 (175.5)

LE3D405 to D505

Dimensions shown in millimeters
(millimeters x 0.0394 = inches)

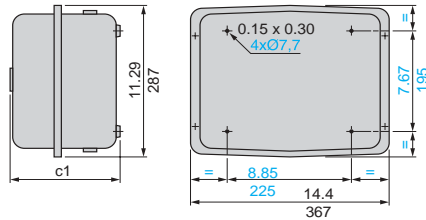

Dual Dimensions: Inches
mm

	c1
Standard version	7.48 (190)
Version A05	7.63 (194)
Version A06	7.63 (194)

LE3D805 to D150

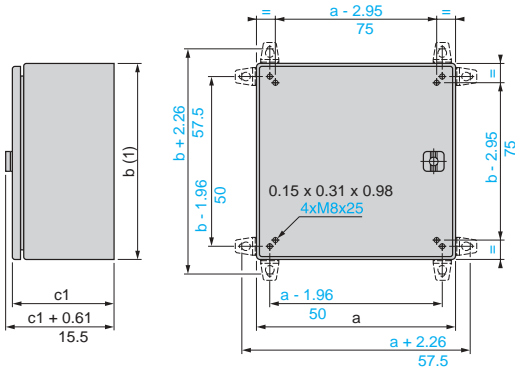

LE3	a	b
D805	15.7 (400)	15.7 (400)
D1155	19.6 (500)	23.6 (600)
D1505	19.6 (500)	23.6 (600)

	c1	LE3D805	LE3D1155, D150
Standard version		7.95 (202)	9.92 (252)
Version A05		8.58 (218)	-
Version A06		8.58 (218)	10.55 (268)

(1) + 14 mm with blanking plugs

Knock-outs or Blanking Plugs for Cable Glands

Type of Enclosure	At top		At bottom	
	PG	ISO	PG	ISO
LE3D09 to D35	2 x 13 or 2 x 16 or 2 x 21 or 2 x 29	2 x 20 I or 2 x 25 I or 2 x 32 I or 2 x 40 I	2 x 13 or 2 x 16 or 2 x 21 or 2 x 29	2 x 20 I or 2 x 25 I or 2 x 32 I or 2 x 40 I
LE3D405	1 x 29	1 x 32 I	1 x 29, 2 x 13 and 2 x 21	1 x 32 I, 2 x 20 I and 2 x 25 I
LE3D505	1 x 36	1 x 40 I	1 x 36, 2 x 13 and 2 x 29	1 x 40 I, 2 x 20 I and 2 x 32 I
LE3D805	1 x 36	1 x 40 I	2 x 13 and 3 x 36	2 x 20 I and 3 x 40 I
LE3K	2 x 13 and 2 x 16	4 x 20 I	2 x 13 and 2 x 16	4 x 20 I

(millimeters x 0.0394 = inches)

TeSys™ D-Line Contactors and Starters

LG1K and LG1D Dimensions (International Applications Only)

Starters Without Isolator

LE6D09 to D18

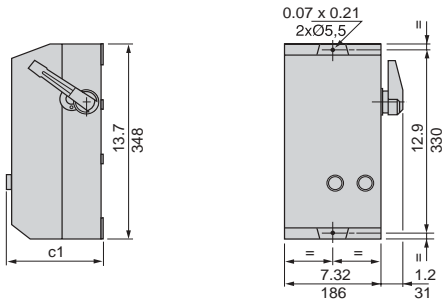

c1

Standard version	6.90 (175.5)
Version A04	6.57 (167)
Version A05	6.90 (175.5)

LE3D326

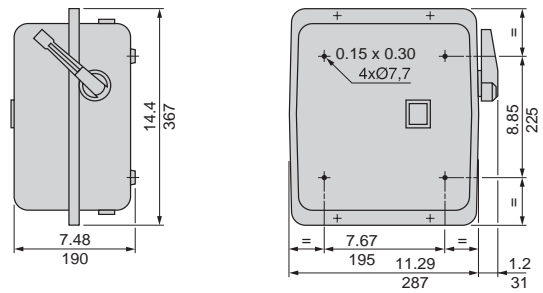

LE3D406 to D806

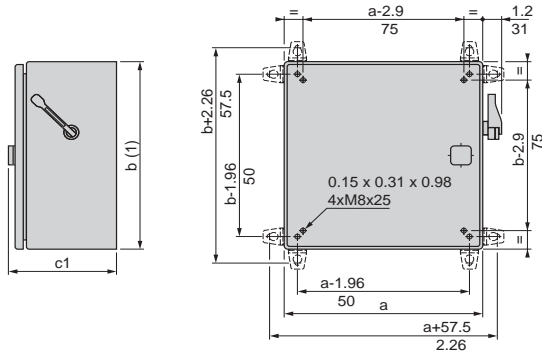

Dual Dimensions: Inches
mm

	a	b	c1
LE3			
D406, D506	15.7 (400)	19.6 (500)	8.58 (218)
D806	19.6 (500)	27.5 (700)	10.6 (269)

(1) + 14 mm with blanking plugs

Knock-outs or Blanking Plugs for Cable Glands

Type of Enclosure	At top		At bottom	
	PG	ISO	PG	ISO
LE6D09 to D18	2 x 13 or 2 x 16 or 2 x 21 or 2 x 29	2 x 20 I or 2 x 25 I or 2 x 32 I or 2 x 40 I	2 x 13 or 2 x 16 or 2 x 21 or 2 x 29	2 x 20 I or 2 x 25 I or 2 x 32 I or 2 x 40 I
LE3D326	1 x 21	1 X 32 I	2 x 13, 2 x 16 and 1 x 21	2 x 20 I, 2 x 25 I and 1 x 32 I
LE3D406	1 x 29	1 X 32 I	2 x 13, 2 x 21 and 1 x 29	2 x 20 I, 2 x 25 I and 1 x 32 I
LE3D506	1 x 36	1 x 40 I	2 x 13, 2 x 29 and 1 x 36	1 x 40 I, 2 x 20 I and 2 x 32 I
LE3D806	1 x 36	1 x 40 I	2 x 13 and 3 x 36	2 x 20 I and 3 x 40 I

(millimeters x 0.0394 = inches)

TeSys™ D-Line Contactors and Starters

LE1K and LE1D Wiring Diagrams (International Applications Only)

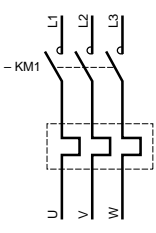
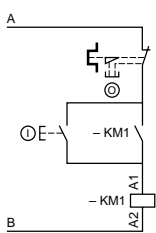
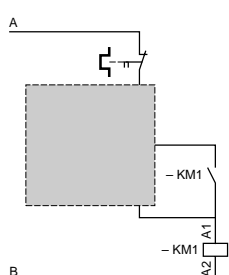
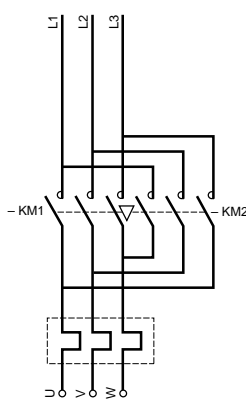
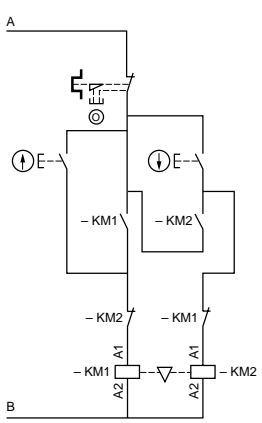
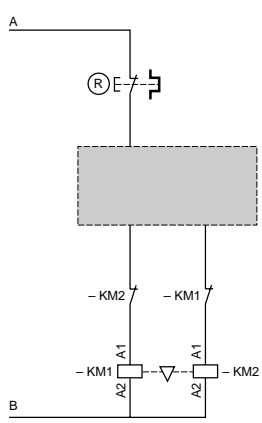
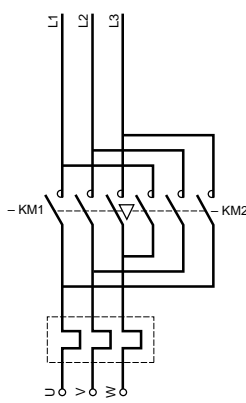
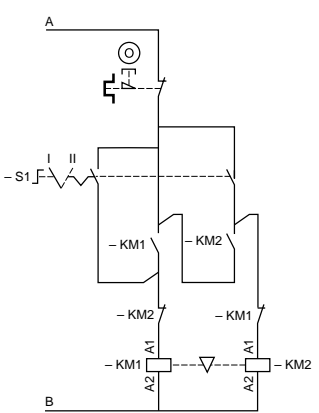
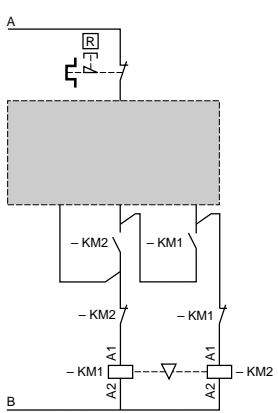
<p>LE1D09 to D955</p> 	<p>LE1D09 to D955</p> 	<p>Form A04 or A05</p> 		
<p>LE2K06, K09</p> 	<p>LE2K06, K09</p> 	<p>Form A05</p> 		
<p>LE2D09 to D955</p> 	<p>LE2D09 to D35</p> 	<p>LE2D405 to D955 LE2D09 to D955 with Forms A04 or A05</p> 		
<p>Connections</p>		<p>A</p>	<p>B</p>	
<p>220 V, 230 V, 240 V</p>		<p>LE2K, LE1 and LE2D09 and D12</p>	<p>L3</p>	<p>Neutral</p>
<p>380 V, 400 V, 415 V, 440 V</p>		<p>All products</p>	<p>L3</p>	<p>Neutral terminal</p>
<p>Other voltages</p>		<p>LE1 and LE2D09 to D35</p>	<p>Terminal 1</p>	<p>Terminal 2</p>
<p>LE2K, LE1 and LE2D405 and D955</p>		<p>Direct connection</p>	<p>Direct connection</p>	<p>Direct connection</p>

TeSys™ D-Line Contactors and Starters

LE2K and LE2D Wiring Diagrams (International Applications Only)

LE6D09 to D18

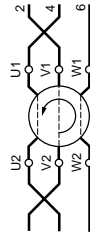
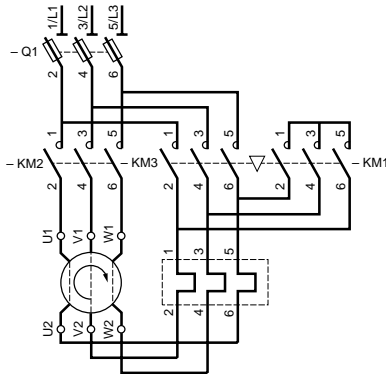

Recommended cabling for reversal of motor rotation (standard motor, viewed from shaft end).

LE6D09 to D18

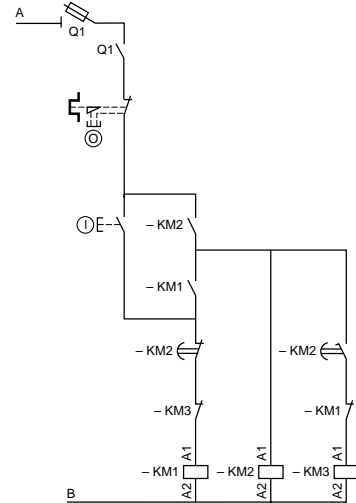

LE3D326 to D806

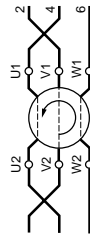
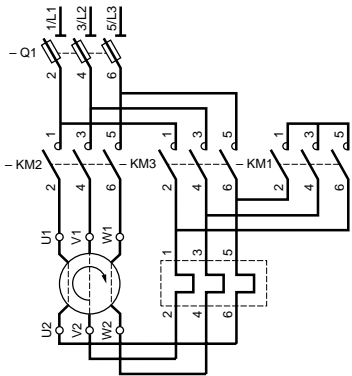

Recommended cabling for reversal of motor rotation (standard motor, viewed from shaft end).

LE3D326 to D806

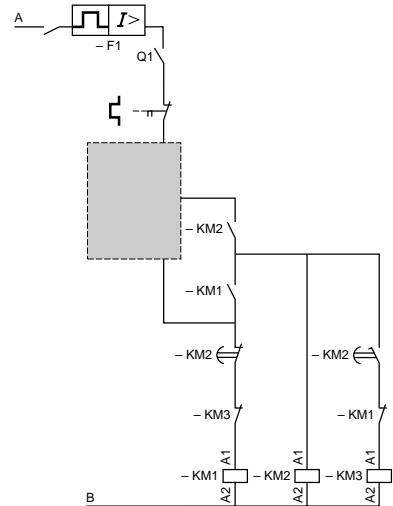

Connections	A	B
220 V, 230 V, 240 V	LE6D09 and D12	L3
	LE6D18 to LE3D806	Neutral terminal
380 V, 400 V, 415 V, 440 V	All products	L3
Other voltages	LE6D09 to D18	Terminal 1
	LE3D326 to D806	Terminal 2
		Direct connection
		Direct connection

TeSys™ D-Line Contactors and Starters

LE4K, LE4D, LE8K, and LE2D Dimensions (International Applications Only)

LE3K065 and K095

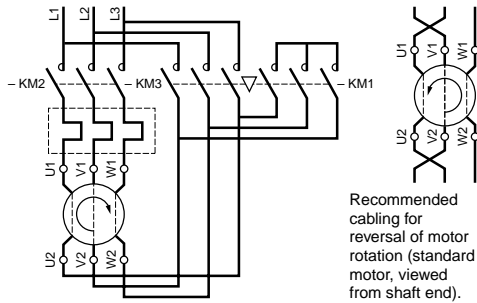

LE3K065 and K095

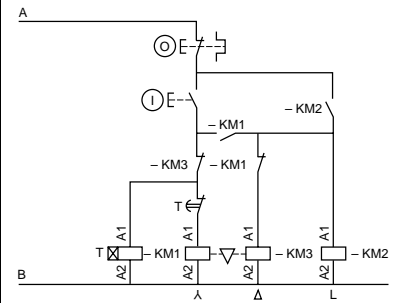

LE3D09 to D805

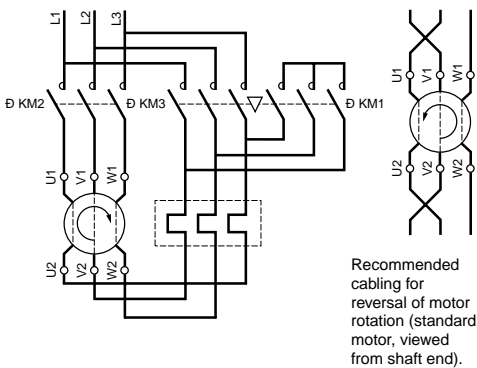

LE3D09 to D35

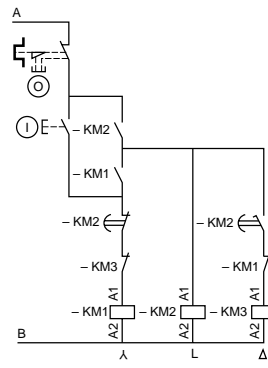

LE3D405 to D805

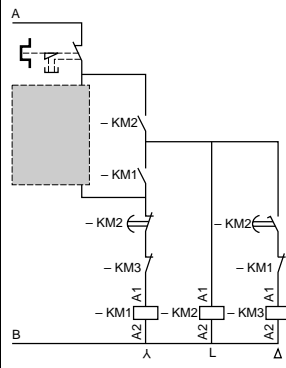

Note: In accordance with current installation regulations, short-circuit protection must be provided by fused or a circuit-breaker.

LE3D115 and D150

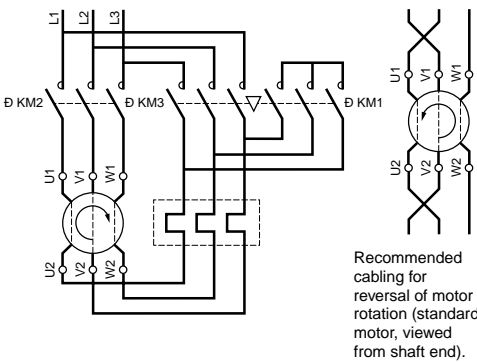

LE3D115 and D150

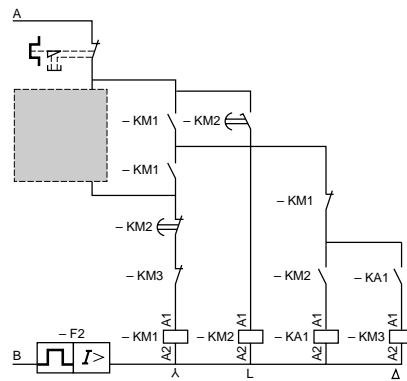

Connections		A	B
220 V, 230 V, 240 V	LD09 and D12	L3	Neutral
	LE3D18 to D150	L3	Neutral terminal
380 V, 400 V, 415 V, 440 V	All products	L3	L1
Other voltages	LE3D09 to D35	Terminal 1	Terminal 2
	LE3K and LE3D405 to D150	Direct connection	Direct connection

TeSys™ D-Line Contactors and Starters

LG1K, LG1D, LG7K, LG7D, and LG8K Dimensions (International Applications Only)

<p>LE4K06, K09 LE4D09 to D806</p>	<p>LE4K06, K09</p>	<p>LE4D09 to D35</p>	<p>LE4D406 to D656</p>	<p>LE4D806 LE4D09 to D656 with Form A04 or A05</p>	
<p>LE8K06, K09</p>	<p>LE8K06, K09</p>	<p>Form A05</p>			
<p>LE8D09 to LE2D806</p>	<p>LE8D09 to D35</p>	<p>LE2D406 to D806</p>			
<p>Connections</p>		<p>A</p>	<p>B</p>		
<p>220 V, 230 V, 240 V</p>		<p>LE4 and LE8K, LE4 and LE8D09 and D12</p>	<p>L3</p>	<p>Neutral</p>	
<p>380 V, 400 V, 415 V, 440 V</p>		<p>LE4D18 to D806, LE8D18 to D35 and LE2D406 to D806</p>	<p>L3</p>	<p>Neutral terminal</p>	
<p>Other voltages</p>		<p>LE4 and LE8D09 to D35</p>	<p>Terminal 1</p>	<p>Terminal 2</p>	
<p>LE4 and LE2D406 and D806</p>		<p>Direct connection</p>	<p>Direct connection</p>		

TeSys™ D-Line Contactors and Starters Cross-Reference Table

3-Pole AC Contactors(1)

Connection for Cables with or without Cable End		for Ring Terminal Type		for Slip on Connectors	
Old Catalog No.	New Catalog No.	Old Catalog No.	New Catalog No.	Old Catalog No.	New Catalog No.
LC1D0900	LC1D09	LC1D09006	LC1D096	LC1D09009	LC1D099
LC1D0910	LC1D09	LC1D09106	LC1D096	LC1D09109	LC1D099
LC1D0901	LC1D09	LC1D09016	LC1D096	LC1D09019	LC1D099
LC1D1200	LC1D12	LC1D12006	LC1D126	LC1D12009	LC1D129
LC1D1210	LC1D12	LC1D12106	LC1D126	LC1D12109	LC1D129
LC1D1201	LC1D12	LC1D12016	LC1D126	LC1D12019	LC1D129
LC1D1800	LC1D18	LC1D18006	LC1D186		
LC1D1810	LC1D18	LC1D18106	LC1D186		
LC1D1801	LC1D18	LC1D18016	LC1D186		
LC1D2500	LC1D25	LC1D25006	LC1D256		
LC1D2510	LC1D25	LC1D25106	LC1D256		
LC1D2501	LC1D25	LC1D25016	LC1D256		
LC1D3200	LC1D32	LC1D32006	LC1D326		
LC1D3210	LC1D32	LC1D32106	LC1D326		
LC1D3201	LC1D32	LC1D32016	LC1D326		
LC1D3810	LC1D38	LC1D38106	LC1D386		
LC1D3801	LC1D38	LC1D38016	LC1D386		
LC1D4011	LC1D40	LC1D40116	LC1D406		
LC1D5011	LC1D50	LC1D50116	LC1D506		
LC1D6511	LC1D65	LC1D65116	LC1D656		
LC1D8011	LC1D80	LC1D80116	LC1D806		
LC1D9511	LC1D95	LC1D95116	LC1D956		
LC1D11500	LC1D115	LC1D115006	LC1D1156		
LC1D15000	LC1D150	LC1D150006	LC1D1506		



4-Pole AC Contactors (1)

LC1D12004	LC1DT25	LC1D120046	LC1DT256
LC1D12008	LC1D128	LC1D120086	LC1D1286
LC1D25004	LC1DT40	LC1D250046	LC1DT406
LC1D25008	LC1D258	LC1D250086	LC1D2586

(1) Coil voltages: codes to be added to the end of the new catalog numbers

Volts - 50/60 Hz	24	48	220	230	380	400
Voltage Code	B7	E7	M7	P7	Q7	V7

3-Pole DC Contactors (2)

LP1D0910	LC1D09	LP1D09106	LC1D096	LP1D09109	LC1D099
LP1D0901	LC1D09	LP1D09016	LC1D096	LP1D09019	LC1D099
LP1D1210	LC1D12	LP1D12106	LC1D126	LP1D12109	LC1D129
LP1D1201	LC1D12	LP1D12016	LC1D126	LP1D12019	LC1D129
LP1D1810	LC1D18	LP1D18106	LC1D186		
LP1D1801	LC1D18	LP1D18016	LC1D186		
LP1D2510	LC1D25	LP1D25106	LC1D256		
LP1D2501	LC1D25	LP1D25016	LC1D256		
LP1D3210	LC1D32	LP1D32106	LC1D326		
LP1D3201	LC1D32	LP1D32016	LC1D326		
LP1D4011	LC1D40	LP1D40116	LC1D406		
LP1D5011	LC1D50	LP1D50116	LC1D506		
LP1D6511	LC1D65	LP1D65116	LC1D656		
LP1D8011	LC1D80	LP1D80116	LC1D806		
LP1D11500	LC1D115	LC1D115006	LC1D1156		
LP1D15000	LC1D150	LC1D150006	LC1D1506		

4-Pole DC Contactors (2)

LP1D12004	LC1DT25	LC1D120046	LC1DT256
LP1D12008	LC1D128	LC1D120086	LC1D1286
LP1D25004	LC1DT40	LC1D250046	LC1DT406
LP1D25008	LC1D258	LC1D250086	LC1D2586

(2) Coil voltages: codes to be added to the end of the new catalog numbers

Volts dc	24	48	72
Voltage Code	BD	ED	SD



TeSys™ D-Line Contactors and Starters

Cross-Reference Table

3-Pole Contactors, Low Consumption (1)

Connection for Cables with or without Cable End		for Lugs or Bars		for Faston Connectors	
Old Catalog No.	New Catalog No.	Old Catalog No.	New Catalog No.	Old Catalog No.	New Catalog No.
LP4D0910	LC1D09				
LP4D0901	LC1D09				
LP4D1210	LC1D12				
LP4D1201	LC1D12				
LP4D1810	LC1D18				
LP4D1801	LC1D18				
LP4D2500	LC1D25				

3-Pole Reversing Contactors, Low Consumption (1)

LP5D0910	LC2D09
LP5D1210	LC2D12
LP5D1810	LC2D18
LP5D2500	LC2D25

(1) Coil voltages: codes to be added to the end of the new catalog numbers

Low Consumption Volts	24	48	72
Code	BL	EL	SL

3-Pole Reversing Contactors, AC

LC2D0901	LC2D09	LC2D09016	LC2D096	LC2D09019	LC2D099
LC2D1201	LC2D12	LC2D12016	LC2D126	LC2D12019	LC2D129
LC2D1801	LC2D18	LC2D18016	LC2D186		
LC2D2501	LC2D25	LC2D25016	LC2D256		
LC2D3201	LC2D32	LC2D32016	LC2D326		
LC2D3801	LC2D38	LC2D38016	LC2D386		
LC2D4011	LC2D40	LC2D115006	LC2D1156		
LC2D5011	LC2D50	LC2D150006	LC2D1506		
LC2D6511	LC2D65				
LC2D8011	LC2D80				
LC2D9511	LC2D95				
LC2D11500	LC2D115				
LC2D15000	LC2D150				

4-Pole Changeover Contactors, AC

LC2D12004	LC2DT25	LC2D120046	LC2DT256
LC2D25004	LC2DT40	LC2D250046	LC2DT406

3-Pole Reversing Contactors, DC

LP2D0901	LC2D09	LP2D09016	LC2D0906	LP2D09109	LC2D099
LP2D1201	LC2D12	LP2D12016	LC2D126	LP2D12019	LC2D129
LP2D1801	LC2D18	LP2D18016	LC2D186		
LP2D2501	LC2D25	LP2D25016	LC2D256		
LP2D3201	LC2D32	LP2D32016	LC2D326		

4-Pole Changeover Contactors, DC

LP2D12004	LC2DT25	LP2D120046	LC2DT256
LP2D25004	LC2DT40	LP2D250046	LC2DT406

Contact Blocks

LA1DN10	LADN10	LA1DN11M	LA1DN11G	LA2DT0	LADT0
LA1DN01	LADN01	LA1DN11P	LADN11P	LA2DT2	LADT2
LA1DN11	LADN11	LA1DN11G	LADN11G	LA2DT4	LADT4
LA1DN20	LADN20	LA1DN22M	LADN22G	LA2DS2	LADS2
LA1DN02	LADN02	LA1DN13M	LADN22G	LA3DR0	LADR0
LA8DN11	LAD8N11	LA1DN31M	LADN31G	LA3DR2	LADR2
LA8DN20	LAD8N20	LA1DN22P	LADN22P	LA3DR4	LADR4
LA1DN22	LADN22	LA1DN13P	LADN31P		
LA1DN13	LADN13	LA1DN31P	LADN31P		
LA1DN40	LADN40	LA1DN22G	LADN22G		
LA1DN04	LADN04	LN1DN11	LADN11		
LA1DN31	LADN31				
LA1DC22	LADC22				

TeSys™ D-Line Contactors and Starters Cross-Reference Table

Thermal Overload Relays



For Use with Balanced Loads		For Use with Unbalanced (Single Phase) Loads		For Use on 1000V Supplies	
Old Catalog No.	New Catalog No.	Old Catalog No.	New Catalog No.	Old Catalog No.	New Catalog No.
LR2D1301	LRD01	LR3D1301	LR3D01	LR2D3301A66	LRD3301A66
LR2D1302	LRD02	LR3D1302	LR3D02	LR2D3302A66	LRD3302A66
LR2D1303	LRD03	LR3D1303	LR3D03	LR2D3303A66	LRD3303A66
LR2D1304	LRD04	LR3D1304	LR3D04	LR2D3304A66	LRD3304A66
LR2D1305	LRD05	LR3D1305	LR3D05	LR2D3305A66	LRD3305A66
LR2D1306	LRD06	LR3D1306	LR3D06	LR2D3306A66	LRD3306A66
LR2D13X6	LRD06	LR3D13X6	LR3D06	LR2D33X6A66	LRD33X6A66
LR2D1307	LRD07	LR3D1307	LR3D07	LR2D3307A66	LRD3307A66
LR2D1308	LRD08	LR3D1308	LR3D08	LR2D3308A66	LRD3308A66
LR2D1310	LRD10	LR3D1310	LR3D10	LR2D3310A66	LRD3310A66
LR2D1312	LRD12	LR3D1312	LR3D12	LR2D3312A66	LRD3312A66
LR2D1314	LRD14	LR3D1314	LR3D14	LR2D3314A66	LRD3314A66
LR2D1316	LRD16	LR3D1316	LR3D16	LR2D3316A66	LRD3316A66
LR2D1321	LRD21	LR3D1321	LR3D21	LR2D3321A66	LRD3321A66
LR2D1322	LRD22	LR3D1322	LR3D22	LR2D3322A66	LRD3322A66
LR2D2353	LRD32	LR3D2353	LR3D32		
LR2D2355	LRD35	LR3D2355	LR3D35		
LR2D1508	LRD1508				
LR2D1510	LRD1510				
LR2D1512	LRD1512				
LR2D1514	LRD1514				
LR2D1516	LRD1516				
LR2D1521	LRD1521				
LR2D1522	LRD1522				
	LRD1530 (1)				
LR2D2553	or				
	LRD1532 (1)				
LR2D3322	LRD3322	LR3D3322	LR3D3322		
LR2D3353	LRD3353	LR3D3353	LR3D3353		
LR2D3355	LRD3355	LR3D3355	LR3D3355		
LR2D3357	LRD3357	LR3D3357	LR3D3357		
LR2D3359	LRD3359	LR3D3359	LR3D3359		
LR2D3361	LRD3361	LR3D3361	LR3D3361		
LR2D3363	LRD3363	LR3D3363	LR3D3363		
LR2D3365	LRD3365	LR3D3365	LR3D3365		
LR2D4365	LRD4365				
LR2D4367	LRD4367				
LR2D4369	LRD4369				

(1) Depends on actual Full Load Current.

TeSys™ D-Line Contactors and Starters

TeSys™ F-Line

Contactors, Overload Relays, and Accessories

Catalog

04

File 8502

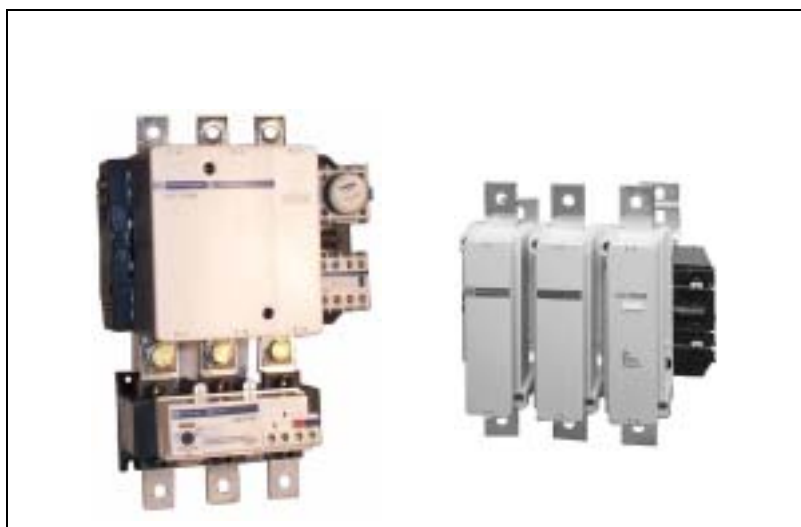

CONTENTS

Description	Page
General Information	181
Contactors	
Characteristics	182
Selection	188
Mechanical Interlocks and Power Connections	190
Auxiliary Contacts and Timers	194
Accessories, and Spare Parts	196
F-line Voltage Code Table	200
Replacement Coils	202
Dimensions and Mounting	210
Schematics	216
Solid State Overload Relays	
Characteristics	218
Selection	220
Accessories	221
Dimensions and Mountings	222
Wiring Diagrams and Special Functions	224
CR1F/CR1B Magnetic Latching Contactors	
Characteristics	225
Selection	230
Accessories – Selection	231
Mechanical Interlocks and Power Connections	232
Coils and Spare Parts	234
Dimensions and Mounting	239
Schematics	245

TeSys™ F-Line Contactors and Starters

TeSys™ F-Line Contactors and Starters General Information

The F-line contactors and overload relays offer proven performance for resistive loads or large motor starting applications such as fans, crushers, pumps, compressors and overhead cranes. They offer high reliability with long mechanical and electrical life and the most complete line of accessories in the industry.

Contactor Ratings



F-line contactors and overload relays are available in the USA market for inductive motor applications up to 800 full load Amps and resistive loads up to 1000 Amps. They offer motor control and overload protection for motors rated up to 800 horsepower at 480 Vac or 900 horsepower at 600 Vac.

- 2 pole, 3 pole and 4 pole Contactors and Magnetic Latching Contactors
- AC or DC operating coils
- Includes UL listing, CSA Certification and CE mark
- Both North American and international terminal markings
- Replacement parts available
 - Contact Kits
 - Arc Chambers
 - Operating Coils
- Easily installed accessories
 - Auxiliary contact blocks with serrated wiping action
 - Front mount dust tight auxiliary contact blocks
 - Pneumatic time delay blocks
- Solid State Overload Relays

Class 10 or class 20 overload relays are available from 30 to 630 Amperes. They are ambient compensated and include single phase sensitivity for phase unbalance and phase loss protection. They also include the following features: Isolated N.C. trip contact, N.O. alarm contact, manual reset button, rotary dial for adjustable current settings with tamper resistant window, test trip button, momentary stop button and trip indicator.

TeSys™ F-Line Contactors and Starters Characteristics



Contactors Type LC1F (115 to 800A) Control Circuit: AC or DC Supply

Type			LC1F115	LC1F150	LC1F185	LC1F225	LC1F265	
Environment								
Rated insulation voltage (Vi)	Conforming to IEC 60947-4-1/IEC 60947-4	V	1000	1000	1000	1000	1000	
	Conforming to VDE 0110 gr C	V	1500	1500	1500	1500	1500	
Rated impulse withstand voltage (Vimp)	Test with coil not connected to the power circuit	kV	8	8	8	8	8	
Conforming to standards	 Meets the essential requirements of the LV & EMC directives		IEC 60947-4, NFC 63-110, VDE 0660, BS 5424, JEM 1038					
Approvals	 E164862 NLDX  LR43364 3211 04		ASE, CSA, UL, BV, GL, LROS, USSR, NORSK VERITAS, RINA					
Degree of protection	Conforming to IEC 60529		IP 20 front face with shrouds LA9F					
	Conforming to VDE 0106		Protection against direct finger contact with shrouds LA9F					
Protective treatment	Standard version		"TH"					
Ambient air temperature around the device	Storage		- 60 to + 80 °C (- 76 to +176 °F)					
	Operation		- 5 to + 55 °C (23 to + 131 °F) for operation at 80 to 110% of nominal control voltage					
	Permissible at Vc ♦		- 40 to + 70 °C (- 40 to + 158 °F) for operation at nominal control voltage					
Maximum operating altitude	Without derating		3000 m (9800 ft.)					
Operating positions	Without derating		± 30° possible, in relation to normal vertical mounting plane					
Shock resistance ■ 1/2 sine wave = 11 ms	Contacteur open		9 gn	9 gn	7 gn	7 gn	6 gn	
	Contacteur closed		13 gn	13 gn	15 gn	15 gn	15 gn	
Vibration resistance ■ 5 to 300 Hz	Contacteur open		2 gn	2 gn	2 gn	2 gn	2 gn	
	Contacteur closed		6 gn	6 gn	5 gn	5 gn	5 gn	
Pole Characteristics ▲								
Number of poles			3 or 4	3 or 4	3 or 4	3 or 4	3 or 4	
Rated operational current (Ie) (Ve ≤ 440 V)	In AC-3, q ≤ 55 °C (131 °F)	A	115	150	185	225	265	
	In AC-1, q ≤ 40 °C (104 °F)	A	200	250	275	315	350	
Rated operational voltage (Ve)	Up to	V	1000	1000	1000	1000	1000	
Frequency limits	Of the operational current ▼	Hz	16 ^{2/3} to 200	16 ^{2/3} to 200	16 ^{2/3} to 200	16 ^{2/3} to 200	16 ^{2/3} to 200	
Conventional rated thermal current	θ ≤ 40 °C (104 °F)	A	200	250	275	315	350	
Rated making capacity	I rms to IEC 60947-4-1	A	1400	1700	2100	2460	2940	
Rated breaking capacity	I rms conforming to IEC 60947-4-1	up to 440 V	A	1300	1500	1800	2050	2450
		500 V	A	1100	1200	1600	1850	2200
		660 to 690 V	A	900	1100	1200	1350	1700
		1000 V	A	400	450	600	780	800
Permissible short time rating from cold state, no current flowing for preceding 60 minutes θ ≤ 40 °C (104 °F)	For 1 s	A	1100	1200	1500	1800	2200	
	For 5 s	A	1100	1200	1500	1800	2200	
	For 10 s	A	1100	1200	1500	1800	2200	
	For 30 s	A	640	700	920	1000	1230	
	For 1 min	A	520	600	740	850	950	
	For 3 min	A	400	450	500	560	620	
	For 10 min	A	320	350	400	440	480	
Short-circuit protection	By circuit breaker		Select in accordance with NEC and local codes					
	By fuses		Max 400% of motor FLA					
Average impedance per pole	At Ith and 50 Hz	mΩ	0.40	0.40	0.36	0.36	0.32	
Power dissipation per pole for the above operational currents	AC-3	W	6	9	12	18	22	
	AC-1	W	18	25	26	35	39	
Mechanical durability at nominal voltage	Millions of operations		10	10	10	10	10	
Maximum operating rate	≤ 55°C (131°F)	ops/HR	2400	2400	2400	2400	2400	
Cabling	Cable size (min-max)	AWG	#14 to 2/0	#6 to 3/0	#6 to 3/0	—	#6 to 300mcm	
	Lug		DZ2FF	DZ2FG	DZ2FG	—	DZ2FH	
Tightening torque using DZ2F•• Lug	Bolt lug to contactor	lb.-in	89	160	160	—	310	
	Wire pressure screw	lb.-in	120	200	200	—	275	

- ♦ In these conditions, for ratings F115 to F225, it is recommended to use LX9F coils.
- In the least favorable direction, without change of contact state (coil at Vc).
- ▲ Paralleling of poles must be carried out only in accordance with the fuse manufacturer's recommendations.
- ▼ Sine wave without interference, above these values, please consult your Local Square D Field Sales Office.

TeSys™ F-Line Contactors and Starters Characteristics

Contactors Type LC1F (115 to 800 A) Control Circuit: AC or DC Supply

Type			LC1F330	LC1F400	LC1F500	LC1F630	LC1F780	LC1F800	
Environment									
Rated insulation voltage (Vi)	Conforming to IEC 60947-4-1/IEC 60947-4	V	1000	1000	1000	1000	1000	1000	
	Conforming to VDE 0110 gr C	V	1500	1500	1500	1500	1500	1500	
Rated impulse withstand voltage (Vimp)	Test with coil not connected to the power circuit	kV	8	8	8	8	8	8	
Conforming to standards	 Meets the essential requirements of the LV & EMC directives		IEC 60947-4, NFC 63-110, VDE 0660, BS 5424, JEM 1038						
Approvals	 E164862 NLDX  LR 43364 3211 04		ASE, CSA C22.2 No.14, UL 508, BV, GL, LROS, USSR, NORSK VERITAS, RINA						
Degree of protection	Conforming to IEC 60529		IP 20 front face with shrouds LA9F						
	Conforming to VDE 0106		Protection against direct finger contact with shrouds LA9F						
Protective treatment	Standard version		"TH"						
Ambient air temperature around the device	Storage		- 60 to + 80°C (- 76 to +176°F)						
	Operation		- 5 to + 55°C (23 to + 131°F) for operation at 80 to 110% of nominal control voltage						
	Permissible at Vc		- 40 to + 70°C (- 40 to + 158°F) for operation at nominal control voltage						-5 to +55°C (23-131 °F)
Maximum operating altitude	Without derating		3000 m (9800 ft.)						
Operating positions	Without derating		± 30° possible, in relation to normal vertical mounting plane						
Shock resistance ■ 1/2 sine wave = 11 ms	Contactors open		6 gn	6 gn	9 gn	6 gn	5 gn	6 gn	
	Contactors closed		15 gn	15 gn	15 gn	15 gn	15 gn	15 gn	
Vibration resistance ■ 5 to 300 Hz	Contactors open		2 gn	1.5 gn	2 gn	2 gn	2.5 gn	2 gn	
	Contactors closed		5 gn	5 gn	4 gn	4 gn	5.5 gn	4 gn	
Pole Characteristics ▲									
Number of poles			3 or 4	2, 3 or 4	2, 3 or 4	2, 3 or 4	3 or 4	3	
Rated operational current (Ie) (Ve ≤ 440 V)	In AC-3, q ≤ 55 °C (131 °F)	A	330	400	500	630	780	800	
	In AC-1, q ≤ 40 °C (104 °F)	A	400	500	700	1000	1600	1000	
Rated operational voltage (Ve)	Up to	V	1000	1000	1000	1000	1000	1000	
Frequency limits	Of the operational current ▼	Hz	16 ^{2/3} to 200	16 ^{2/3} to 200	16 ^{2/3} to 200	16 ^{2/3} to 200	16 ^{2/3} to 200	16 ^{2/3} to 200	
Conventional rated thermal current	θ ≤ 40 °C (104 °F)	A	400	500	700	1000	1600	1000	
Rated making capacity	I rms to IEC 60947-4-1	A	3600	4500	5550	6740	8550	8200	
Rated breaking capacity	I rms conforming to IEC 60947-4-1	up to 440 V	A	3000	4000	5000	6300	7100	7400
		500 V	A	2810	3500	4500	5400	6100	6200
		660 to 690 V	A	2350	3050	3560	4600	5200	5400
		1000 V	A	1150	1200	2500	3200	3800	3850
Permissible short time rating from cold state, no current flowing for preceding 60 minutes θ ≤ 40 °C (104 °F)	For 1 s	A	2650	3600	4200	5050	6250	5100	
	For 5 s	A	2650	3600	4200	5050	6250	5100	
	For 10 s	A	2650	3600	4200	5050	6250	5100	
	For 30 s	A	1800	2400	3200	4400	5600	4400	
	For 1 min	A	1300	1700	2400	3400	4600	3400	
	For 3 min	A	900	1200	1500	2200	3000	2200	
	For 10 min	A	750	1000	1200	1600	2200	1600	
Short-circuit protection	By circuit breaker		Select in accordance with NEC and local codes						
	By fuses		Max 400% of motor FLA						
Average impedance per pole	At 1th and 50 Hz	mΩ	0.28	0.28	0.18	0.12	0.10	0.12	
Power dissipation per pole for the above operational currents	AC-3	W	31	45	45	48	60	77	
	AC-1	W	44	70	88	120	250	120	
Mechanical durability at nominal voltage	Millions of operations		10	10	10	5	5	5	
Maximum operating rate	≤ 55°C (131°F)	ops/HR	2400	2400	2400	1200	1200	1200	
Cabling	Cable size (min-max)	AWG	#6 to 300mcm	#4 to 500mcm	2 x #2 to 600mcm	3 x #2 to 600mcm	4 x 1/0 to 750mcm	3 x #2 to 600mcm	
	Lug		DZ2FH	DZ2FJ	DZ2FK	DZ2FL	DZ2FX	DZ2FL	
Tightening torque using DZ2F•• Lug	Bolt lug to contactor	lb.-in	310	310	310	510	510	510	
	Wire pressure screw	lb.-in	275	500	500	500	500	500	

- In the least favorable direction, without change of contact state (coil at Vc).
- ▲ Paralleling of poles must be carried out only in accordance with the fuse manufacturer's recommendations.
- ▼ Sine wave without interference, above these values, please consult your Local Square D Field Sales Office.

TeSys™ F-Line Contactors and Starters

Characteristics

Contactors Type LC1F (115 to 800 A) Control Circuit: AC Supply

Type			LC1F115	LC1F150	LC1F185	LC1F225	LC1F265	LC1F330	
Control Circuit Characteristics (LX1/LX8 type coils)									
Rated control circuit voltage (Vc)	50 or 60 Hz	V	24 to 1000	24 to 1000	24 to 1000	24 to 1000	48 to 1000	48 to 1000	
Control voltage limits ($\theta \leq 55^\circ\text{C}$ [131 °F])	50 or 60 Hz coils	Operational	0.85 to 1.1 Vc	0.85 to 1.1 Vc	0.85 to 1.1 Vc	0.85 to 1.1 Vc	–	–	
		Drop-out	0.35 to 0.55 Vc	0.35 to 0.55 Vc	0.35 to 0.55 Vc	0.35 to 0.55 Vc	–	–	
	40 to 400 Hz coils	Operational	–	–	–	–	0.85 to 1.1 Vc	0.85 to 1.1 Vc	
		Drop-out	–	–	–	–	0.35 to 0.55 Vc	0.35 to 0.55 Vc	
Average consumption at 20 °C (68 °F) and at Vc	AC 50 Hz Inrush	50 Hz coil	VA	550	550	805	805	–	–
		40 to 400 Hz coil	VA	–	–	–	–	650	650
		Power factor		0.3	0.3	0.3	0.3	0.9	0.9
	AC 50 Hz Sealed	50 Hz coil	VA	45	45	55	55	–	–
		40 to 400 Hz coil	VA	–	–	–	–	10	10
		Power factor		0.3	0.3	0.3	0.3	0.9	0.9
	AC 60 Hz Inrush	60 Hz coil	VA	660	660	970	970	–	–
		40 to 400 Hz coil	VA	–	–	–	–	650	650
		Power factor		0.3	0.3	0.3	0.3	0.9	0.9
	AC 60 Hz Sealed	60 Hz coil	VA	55	55	66	66	–	–
		40 to 400 Hz coil	VA	–	–	–	–	10	10
		Power factor		0.3	0.3	0.3	0.3	0.9	0.9
Heat dissipation		W	12 to 16	12 to 16	18 to 24	18 to 24	8	8	
Operating time ■	Closing "C"	ms	23 to 35	23 to 35	20 to 35	20 to 35	40 to 65	40 to 65	
	Opening "O"	ms	5 to 15	5 to 15	7 to 15	7 to 15	100 to 170	100 to 170	
Mechanical durability to Vc in millions of operating cycles			10	10	10	10	10	10	
Maximum operating rate at ambient temperature $\leq 55^\circ\text{C}$ (131 °F)	In operating cycles per hour		2400	2400	2400	2400	2400	2400	
Cabling				Min/max					
	Solid or stranded cable	1 or 2 conductors	AWG	16/12	16/12	16/12	16/12	16/12	16/12
				Min/max c.s.a.					
	Stranded cable without cable end	1 or 2 conductors	mm ²	1/4	1/4	1/4	1/4	1/4	1/4
	Stranded cable with cable end	1 conductor	mm ²	1/4	1/4	1/4	1/4	1/4	1/4
		2 conductors	mm ²	1/2.5	1/2.5	1/2.5	1/2.5	1/2.5	1/2.5
Solid cable without cable end	1 or 2 conductors	mm ²	1/4	1/4	1/4	1/4	1/4	1/4	
Tightening torque		N•m/lb-in	1.2/10	1.2/10	1.2/10	1.2/10	1.2/10	1.2/10	
Mechanical latching	The LA6DK mechanical latch blocks cannot be mounted on LC1F contactors, for similar operation use CR1F magnetic latching contactors (see page 226).								

- The closing time "C" is measured from the moment the coil supply is switched on to initial contact of the main poles.
The opening time "O" is measured from the moment the coil supply is switched off to the moment the main poles separate.

TeSys™ F-Line Contactors and Starters Characteristics

Contactors Type LC1F (115 to 800 A) Control Circuit: AC Supply

Type			LC1F400	LC1F500	LC1F630	LC1F780	LC1F800	
Control Circuit Characteristics (LX1/LX8 type coils)								
Rated control circuit voltage (Vc)	50 or 60 Hz		V	48 to 1000	48 to 1000	48 to 1000	110 to 500	110 to 440
Control voltage limits ($\theta \leq 55^\circ\text{C}$ [131 °F])	50 or 60 Hz coils	Operational		–	–	–	–	–
		Drop-out		–	–	–	–	–
	40 to 400 Hz coils	Operational		0.85 to 1.1 Vc	0.85 to 1.1 Vc	0.85 to 1.1 Vc	0.85 to 1.1 Vc	0.7 to 1.3 Vc
		Drop-out		0.3 to 0.5 Vc	0.3 to 0.5 Vc	0.25 to 0.5 Vc	0.2 to 0.4 Vc	0.3 to 0.5 Vc
Average consumption at 20 °C (68 °F) and at Vc	AC 50 Hz Inrush	50 Hz coil	VA	–	–	–	–	–
		40 to 400 Hz coil	VA	1075	1100	1650	2100	1300
		Power factor		0.9	0.9	0.9	0.9	–
	AC 50 Hz Sealed	50 Hz coil	VA	–	–	–	–	–
		40 to 400 Hz coil	VA	15	18	22	50	15
		Power factor		0.9	0.9	0.9	0.9	–
	AC 60 Hz Inrush	60 Hz coil	VA	–	–	–	–	–
		40 to 400 Hz coil	VA	1075	1100	1650	2100	1300
		Power factor		0.9	0.9	0.9	0.9	–
	AC 60 Hz Sealed	60 Hz coil	VA	–	–	–	–	–
		40 to 400 Hz coil	VA	15	18	22	50	15
		Power factor		0.9	0.9	0.9	0.9	–
Heat dissipation			W	14	18	20	2 x 22	25
Operating time ■	Closing "C"		ms	40 to 75	40 to 75	40 to 80	40 to 80	40 to 80
	Opening "O"		ms	100 to 170	100 to 170	100 to 200	130 to 230	20 to 40
Mechanical durability to Vc in millions of operating cycles				10	10	5	5	5
Maximum operating rate at ambient temperature $\leq 55^\circ\text{C}$ (131 °F)	In operating cycles per hour			2400	2400	1200	600	600
Cabling				Min/max				
	Solid or stranded cable	1 or 2 conductors	AWG	16/12	16/12	16/12	16/12	16/12
				Min/max c.s.a.				
	Stranded cable without cable end	1 or 2 conductors	mm ²	1/4	1/4	1/4	1/4	1/4
	Stranded cable with cable end	1 conductor	mm ²	1/4	1/4	1/4	1/4	1/4
		2 conductors	mm ²	1/2.5	1/2.5	1/2.5	1/2.5	1/2.5
Solid cable without cable end	1 or 2 conductors	mm ²	1/4	1/4	1/4	1/4	1/4	
Tightening torque			N•m/lb-in	1.2/10	1.2/10	1.2/10	1.2/10	1.2/10
Mechanical latching	The LA6DK mechanical latch blocks cannot be mounted on LC1F contactors, for similar operation use CR1F magnetic latching contactors (see page 226).							

- The closing time "C" is measured from the moment the coil supply is switched on to initial contact of the main poles.
The opening time "O" is measured from the moment the coil supply is switched off to the moment the main poles separate.

TeSys™ F-Line Contactors and Starters

Characteristics

Contactors Type LC1F (115 to 800 A) Control Circuit: DC Supply

Type			LC1F115	LC1F150	LC1F185	LC1F225	LC1F265	LC1F330	
Control Circuit Characteristics (LX4/LX8 type coils)									
Rated control circuit voltage (Vc)	DC	V	24 to 460	24 to 460	24 to 460	24 to 460	24 to 460	24 to 460	
Control voltage limits ($\theta \leq 55\text{ }^{\circ}\text{C}$ [131 °F])	Operational		0.85 to 1.1 Vc	0.85 to 1.1 Vc	0.85 to 1.1 Vc	0.85 to 1.1 Vc	0.85 to 1.1 Vc	0.85 to 1.1 Vc	
	Drop-out		0.15 to 0.2 Vc	0.15 to 0.2 Vc	0.1 to 0.2 Vc	0.15 to 0.2 Vc	0.15 to 0.2 Vc	0.15 to 0.2 Vc	
Average consumption at 20 °C (68 °F) and at Vc	DC	Inrush	W	560	560	800	800	750	750
		Sealed	W	4.5	4.5	5	5	5	5
Average operating time ■	Closing "F"	ms		30 to 40	30 to 40	30 to 40	30 to 40	40 to 50	40 to 50
	Opening "O"	ms		30 to 50	30 to 50	30 to 50	30 to 50	40 to 65	40 to 65
Note: The arcing time depends on the circuit switched by the poles. For normal 3-phase applications, the arcing time is usually less than 10 ms. The load is isolated from the supply after a time equal to the sum of the opening time and the arcing time.									
Mechanical durability at Vc	In millions of operating cycles			10	10	10	10	10	
Maximum operating rate at ambient temperature $\leq 55\text{ }^{\circ}\text{C}$ (131 °F)	In operating cycles/hour			2400	2400	2400	2400	2400	
Cabling	Solid or stranded cable		1 or 2 conductors	AWG	16/12	16/12	16/12	16/12	16/12
					Min/max				
					Min/max c.s.a.				
	Stranded cable without cable end	1 conductor	mm ²	1/4	1/4	1/4	1/4	1/4	1/4
		2 conductors	mm ²	1/4	1/4	1/4	1/4	1/4	1/4
	Stranded cable with cable end	1 conductor	mm ²	1/4	1/4	1/4	1/4	1/4	1/4
2 conductors		mm ²	1/2.5	1/2.5	1/2.5	1/2.5	1/2.5	1/2.5	
Solid cable without cable end	1 conductor	mm ²	1/4	1/4	1/4	1/4	1/4	1/4	
	2 conductors	mm ²	1/4	1/4	1/4	1/4	1/4	1/4	
Tightening torque			N•m /lb-in	1.2/10	1.2/10	1.2/10	1.2/10	1.2/10	
Mechanical latching	The LA6DK mechanical latch blocks cannot be mounted on LC1F contactors, for similar operation use CR1F magnetic latching contactors (see page 226).								

- Operating times depend on the type of contactor electromagnet and its control mode.
The closing time "C" is measured from the moment the coil supply is switched on to initial contact of the main poles.
The opening time "O" is measured from the moment the coil supply is switched off to the moment the main poles separate.

TeSys™ F-Line Contactors and Starters Characteristics

Contactors Type LC1F (115 to 800 A) Control Circuit: DC Supply

Type			LC1F400	LC1F500	LC1F630	LC1F780	LC1F800	
Control Circuit Characteristics (LX4/LX8 type coils)								
Rated control circuit voltage (Vc)	DC		V	48 to 460	48 to 460	48 to 460	110 to 460	110 to 440
Control voltage limits ($\theta \leq 55^\circ\text{C}$ [131 °F])	Operational			0.85 to 1.1 Vc	0.85 to 1.1 Vc	0.85 to 1.1 Vc	0.85 to 1.1 Vc	0.7 to 1.3 Vc
	Drop-out			0.2 to 0.35 Vc	0.2 to 0.35 Vc	0.2 to 0.35 Vc	0.2 to 0.4 Vc	0.3 to 0.5 Vc
Average consumption at 20 °C (68 °F) and at Vc	DC	Inrush	W	1000	1100	1600	2 x 1000	1300
		Sealed	W	6	6	9	2 x 21	15
Average operating time ■	Closing "F"	ms		50 to 60	50 to 60	60 to 70	70 to 80	40 to 80
	Opening "O"	ms		45 to 60	45 to 60	40 to 50	100 to 130	20 to 40
Note: The arcing time depends on the circuit switched by the poles. For normal 3-phase applications, the arcing time is usually less than 10 ms. The load is isolated from the supply after a time equal to the sum of the opening time and the arcing time.								
Mechanical durability at Vc	In millions of operating cycles			10	10	5	5	5
Maximum operating rate at ambient temperature $\leq 55^\circ\text{C}$ (131 °F)	In operating cycles/hour			2400	2400	1200	600	600
Cabling	Solid or stranded cable		1 or 2 conductors	AWG	16/12	16/12	16/12	16/12
					Min/max			
					Min/max c.s.a.			
	Stranded cable without cable end	1 conductor	mm ²	1/4	1/4	1/4	1/4	1/4
		2 conductors	mm ²	1/4	1/4	1/4	1/4	1/4
	Stranded cable with cable end	1 conductor	mm ²	1/4	1/4	1/4	1/4	1/4
2 conductors		mm ²	1/2.5	1/2.5	1/2.5	1/2.5	1/2.5	
Solid cable without cable end	1 conductor	mm ²	1/4	1/4	1/4	1/4	1/4	
	2 conductors	mm ²	1/4	1/4	1/4	1/4	1/4	
Tightening torque			N•m /lb-in	1.2/10	1.2/10	1.2/10	1.2/10	1.2/10
Mechanical latching	The LA6DK mechanical latch blocks cannot be mounted on LC1F contactors, for similar operation use CR1F magnetic latching contactors (see page 226).							

- Operating times depend on the type of contactor electromagnet and its control mode.
The closing time "C" is measured from the moment the coil supply is switched on to initial contact of the main poles.
The opening time "O" is measured from the moment the coil supply is switched off to the moment the main poles separate.

TeSys™ F-Line Contactors and Starters

Selection – Contactors



LC1F225



LC1F630

Control Circuit: AC or DC
 Kilowatt Ratings for International Applications

2-, 3-, and 4-Pole Contactors

Standard power ratings of 3-phase motors 50/60 Hz in category AC-3							Maximum current ($\theta \leq 40^\circ\text{C}$ [104 °F])		Number of poles	Catalog Number ▲ ▼ Panel mount with screws ■	Weight lb (kg)
220 V 230 V	380 V 400 V	415 V	440 V	660 V 500 V	690 V	1000 V	AC-3 up to 400 V	AC-1 up to 400 V			
kW	kW	kW	kW	kW	kW	kW	A	A			
30	55	59	59	75	80	65	115	200	3	LC1F115●●	7.56 (3.430)
									4	LC1F1154●●	8.44 (3.830)
40	75	80	80	90	100	65	150	250	3	LC1F150●●	7.56 (3.430)
									4	LC1F1504●●	8.44 (3.830)
55	90	100	100	110	110	100	185	275	3	LC1F185●●	10.2 (4.650)
									4	LC1F1854●●	12.0 (5.450)
63	110	110	110	129	129	100	225	315	3	LC1F225●●	10.5 (4.750)
									4	LC1F2254●●	12.2 (5.550)
75	132	140	140	160	160	147	265	350	3	LC1F265●●	16.4 (7.440)
									4	LC1F2654●●	18.8 (8.540)
100	160	180	200	200	220	160	330	400	3	LC1F330●●	18.9 (8.600)
									4	LC1F3304●●	20.9 (9.500)
110	200	220	250	257	280	185	400	500	2	LC1F4002●●	17.6 (8.000)
									3	LC1F400●●	20.0 (9.100)
									4	LC1F4004●●	22.5 (10.200)
147	250	280	295	355	335	335	500	700	2	LC1F5002●●	21.5 (9.750)
									3	LC1F500●●	25.0 (11.350)
									4	LC1F5004●●	28.5 (12.950)
200	335	375	400	400	450	450	630	1000	2	LC1F6302●●	34.2 (15.500)
									3	LC1F630●●	41.0 (18.600)
220	400	425	425	450	475	450	780	1600	4	LC1F6304●●	47.4 (21.500)
									3	LC1F780●●	87.1 (39.500)
250	450	450	450	450	475	450	800	1000	4	LC1F7804●●	105.8 (48.000)
									3	LC1F800●●	41.3 (18.750)

Note: For auxiliary contact blocks and modules (see pages 195 to 196).

■ The power terminals may be protected by the addition of shrouds, to be ordered separately except LC1F780. For power terminal lugs, see page 199.

▲ Use voltage codes on page 200 "Voltage Codes Table" to complete catalog number.

▼ The following coil types include one normally open holding circuit contact incorporated in the design of the coil for 3-wire control applications:

LX1FF, FG, FJ, FK, FL, LX1FX0422 to FH3802. The following coil types require an additional LA•DN1•, LADN2•, LADN31, or LADN4.

Auxiliary contact block: LX1FH0202 to 0362, LX1FH4402 to 10002, LX8F8•W, LX1FX, LX1FX, LX9FF, FG, LX9FH•••2, LX9FJ, FK, FL, LX4FF, FG FH, FJ, FK, FL.

TeSys™ F-Line Contactors and Starters Selection – Contactors



LC1F225



LC1F630

Control Circuit: AC or DC
Horsepower Ratings for North American Applications

2-, 3-, and 4-Pole Contactors

Standard power ratings of 3-phase motors 50/60 Hz in category AC-3				Maximum current (θ ≤ 40 °C [104 °F])		Number of poles	Catalog Number ▲ ▼	Weight lb (kg)
				AC-3	AC-1			
200 V 208 V	220 V 240 V	460 V 480 V	575 V 600 V	A	A		Panel mount with screws ■	
HP	HP	HP	HP					
30	40	75	100	115	200	3	LC1F115**	7.56 (3.430)
						4	LC1F1154**	8.44 (3.830)
40	50	100	125	150	250	3	LC1F150**	7.56 (3.430)
						4	LC1F1504**	8.44 (3.830)
50	60	125	150	185	275	3	LC1F185**	10.2 (4.650)
						4	LC1F1854**	12.0 (5.450)
Current Rated				225	315	3	LC1F225**	10.5 (4.750)
						4	LC1F2254**	12.2 (5.550)
60	75	150	175	265	350	3	LC1F265**	16.4 (7.440)
						4	LC1F2654**	18.8 (8.540)
75	100	200	250	330	400	3	LC1F330**	18.9 (8.600)
						4	LC1F3304**	20.9 (9.500)
100	125	250	300	400	500	2	LC1F4002**	17.6 (8.000)
						3	LC1F400**	20.0 (9.100)
						4	LC1F4004**	22.5 (10.200)
						2	LC1F5002**	21.5 (9.750)
150	200	400	500	500	700	3	LC1F500**	25.0 (11.350)
						4	LC1F5004**	28.5 (12.950)
250	300	600	800	630	1000	2	LC1F6302**	34.2 (15.500)
						3	LC1F630**	41.0 (18.600)
						4	LC1F6304**	47.4 (21.500)
						3	LC1F780**	87.1 (39.500)
Current Rated				780	1600	4	LC1F7804**	105.8 (48.000)
						3	LC1F800**	41.3 (18.750)
—	450	800	900	800	1000	3		

Note: For auxiliary contact blocks and modules (see pages 195 to 196).

- The power terminals may be protected by the addition of shrouds, to be ordered separately except **LC1F780**. For power terminal lugs, see page 199.
- ▲ Use voltage codes on page 200 "Voltage Codes Table" to complete catalog number.
- ▼ The following coil types include one normally open holding circuit contact incorporated in the design of the coil for 3-wire control applications: LX1FF, FG, FJ, FK, FL, LX1FX0422 to FH3802. The following coil types require an additional LA•DN1•, LADN2•, LADN31, or LADN4. Auxiliary contact block: LX1FH0202 to 0362, LX1FH4402 to 10002, LX8F8•W, LX1FX, LX1FX, LX9FF, FG, LX9FH•••2, LX9FJ, FK, FL, LX4FF, FG FH, FJ, FK, FL.

TeSys™ F-Line Contactors and Starters

Mechanical Interlocks and Power Connections

Components for Assembling 3-Pole Reversing Contactors and Changeover Contactor Pairs, for Customer Assembly

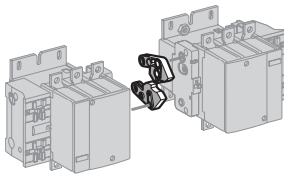
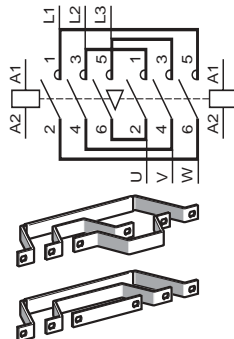
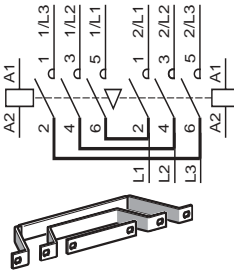
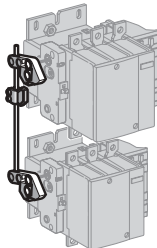
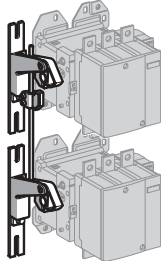
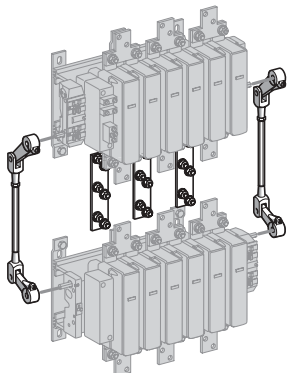
Horizontally mounted	Mechanical interlocks	Sets of power connections	
<p>Reversers assembled using 2 contactors of identical rating, type:</p> <p>LC1F115 LC1F150 LC1F185 LC1F225 LC1F265 LC1F330 LC1F400 LC1F500 LC1F630 LC1F800</p>	<p>LA9F•970</p> 	<p>Reversing contactors</p> <p>LA9F•••76</p> 	<p>3-pole changeover contactor pairs ■</p> <p>LA9F•••82</p> 
<p>Reversers assembled using 2 contactors of identical rating, type:</p> <p>LC1F115 LC1F150 LC1F185 LC1F225 LC1F265 LC1F330 LC1F400 LC1F500 LC1F630 LC1F800</p>	<p>LA9FF4F LA9FG4G</p> 	<p>LA9FH4H LA9FJ4J LA9FK4K LA9FL4L</p> 	
<p>LC1F780</p>	<p>LA9FX970</p> 		

■ For 4-pole changeover contactor pairs, see pages 193 and 194.

TeSys™ F-Line Contactors and Starters Mechanical Interlocks and Power Connections

Components for Assembling 3-Pole Reversing Contactors and Changeover Contactor Pairs, for Customer Assembly.

How to order:

Components are available for customer assembly of F-line reversing contactors and changeover contactors. For example the following components must be ordered to build a 75 HP @ 460 V reversing contactor with a 120 V/60 Hz coil:

Quantity	Catalog number	Description
2	LC1F115G6	Contactors
6	DZ2FF1	Lugs
2	LA1DN•1	Auxiliary Contact Block
1	LA9FF976	Power Connections
1	LA9FF970	Mechanical Interlock

Using 2 contactors of identical rating

Contactor Type ■	Set of power connections		Mechanical interlock	
	Catalog Number	Weight lb (kg)	Kit Catalog Number	Weight lb (kg)
For assembly of 3-pole reversing contactors for motor control				
Horizontally mounted				
LC1F115	LA9FF976	1.3 (0.600)	LA9FF970	0.13 (0.060)
LC1F150	LA9F15076	1.3 (0.600)	LA9FF970	0.13 (0.060)
LC1F185	LA9FG976	1.7 (0.780)	LA9FG970	0.13 (0.060)
LC1F225	LA9F22576	3.3 (1.500)	LA9FG970	0.13 (0.060)
LC1F265	LA9FH976	3.3 (1.500)	LA9FJ970	0.31 (0.140)
LC1F330	LA9FJ976	4.6 (2.100)	LA9FJ970	0.31 (0.140)
LC1F400	LA9FJ976	4.6 (2.100)	LA9FJ970	0.31 (0.140)
LC1F500	LA9FK976	5.2 (2.350)	LA9FJ970	0.31 (0.140)
LC1F630 or F800	LA9FL976	(8.4 3.800)	LA9FL970	0.33 (0.150)
Vertically mounted				
LC1F115 or F150	●	–	LA9FF4F	0.76 (0.345)
LC1F185	●	–	LA9FG4G	0.77 (0.350)
LC1F225	●	–	LA9FG4G	0.77 (0.350)
LC1F265 or F330	●	–	LA9FH4H	2.34 (1.060)
LC1F400	●	–	LA9FJ4J	2.64 (1.200)
LC1F500	●	–	LA9FK4K	2.64 (1.200)
LC1F630 or F800	●	–	LA9FL4L	2.64 (1.220)
LC1F780	▲	–	LA9FX970 ▲	13.4 (6.100)
For assembly of 3-pole changeover contactor pairs ♦				
Horizontally mounted				
LC1F115	LA9FF982	1.0 (0.460)	LA9FF970	0.13 (0.060)
LC1F150	LA9F15082	1.0 (0.460)	LA9FF970	0.13 (0.060)
LC1F185	LA9FG982	1.3 (0.610)	LA9FG970	0.13 (0.060)
LC1F225	LA9F22582	2.6 (1.200)	LA9FG970	0.13 (0.060)
LC1F265	LA9FH982	2.6 (1.200)	LA9FJ970	0.31 (0.140)
LC1F330	LA9FJ982	4.0 (1.800)	LA9FJ970	0.31 (0.140)
LC1F400	LA9FJ982	4.0 (1.800)	LA9FJ970	0.31 (0.140)
LC1F500	LA9FK982	5.1 (2.300)	LA9FJ970	0.31 (0.140)
LC1F630 or F800	LA9FL982	7.5 (3.400)	LA9FL970	0.33 (0.150)
Vertically mounted				
LC1F115 or F150	●	–	LA9FF4F	0.76 (0.345)
LC1F185	●	–	LA9FG4G	0.77 (0.350)
LC1F225	●	–	LA9FG4G	0.77 (0.350)
LC1F265 or F330	●	–	LA9FH4H	2.34 (1.060)
LC1F400	●	–	LA9FJ4J	2.64 (1.200)
LC1F500	●	–	LA9FK4K	2.64 (1.200)
LC1F630 or F800	●	–	LA9FL4L	2.64 (1.220)
LC1F780	▼	–	LA9FX970 ▼	17.2 (7.800)

■ To order the 2 contactors: see pages 188 and 189. Order 2 contact blocks LA1DN•1 to obtain electrical interlocking between the 2 contactors: see pages 194 and 195.

● All power connections are to be made by the customer, except for contactors type LC1F780.

▲ Double mechanical interlock mechanism with 2 interlock connecting rods and 3 power connecting links.

♦ For assembly of 4-pole changeover contactor pairs, see pages 192 and 193.

▼ Double mechanical interlock mechanism with 2 interlock connecting rods and 4 power connecting links.

TeSys™ F-Line Contactors and Starters Mechanical Interlocks and Power Connections

Components for Assembling 3- and 4-Pole Changeover Contactor Pairs, for Customer Assembly

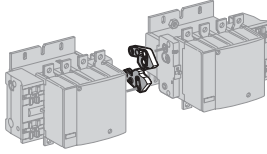
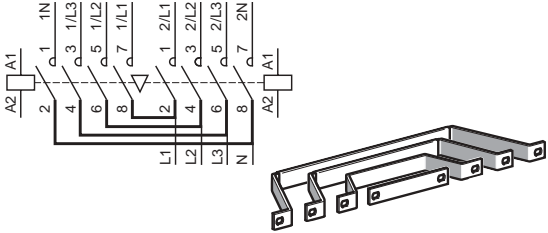
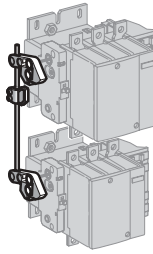
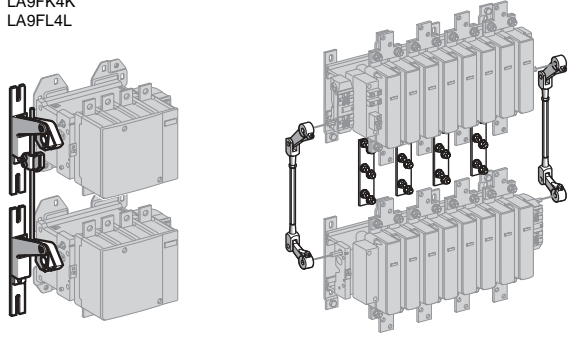
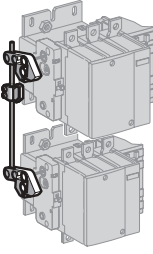
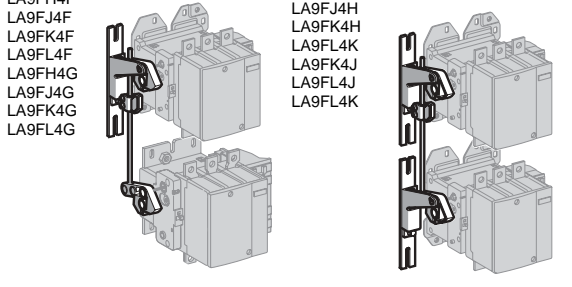
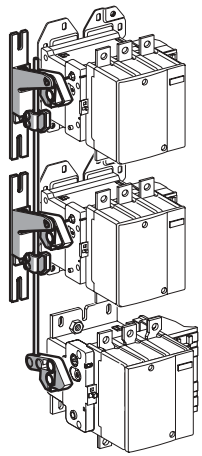
Horizontally mounted	Mechanical interlocks	Sets of power connections
<p>Reversers assembled using 2 contactors of identical rating, type:</p> <p>LA9F•970</p> <p>LC1F1154 LC1F1504 LC1F1854 LC1F2254 LC1F2654 LC1F3304 LC1F4004 LC1F5004 LC1F6304</p>		<p>4-pole changeover contactor pairs ■ LA9F•••77</p> 
Vertically mounted	Mechanical interlocks	
<p>Reversers assembled using 2 contactors of identical rating, type:</p> <p>LA9FF4F LA9FG4G</p> <p>LC1F1154 LC1F1504 LC1F1854 LC1F2254 LC1F2654 LC1F3304 LC1F4004 LC1F5004 LC1F6304</p>		<p>LA9FH4H LA9FJ4J LA9FK4K LA9FL4L</p> <p>LA9FX971</p> 
<p>Reversers assembled using 2 contactors of different ratings, type:</p> <p>LA9FG4F</p> <p>LC1F115 or F1154 LC1F150 or F1504 LC1F185 or F1854 LC1F225 or F2254 LC1F265 or F2654 LC1F330 or F3304 LC1F400 or F4004 LC1F500 or F5004 LC1F630 or F6304 LC1F800</p>		<p>LA9FH4F LA9FJ4F LA9FK4F LA9FL4F LA9FH4G LA9FJ4G LA9FK4G LA9FL4G</p> <p>LA9FJ4H LA9FK4H LA9FL4K LA9FL4J LA9FL4K</p> 
<p>Reversers assembled using 3 contactors of identical or different ratings, type:</p> <p>LA9F•4•4•</p> <p>LC1F115 or F1154 LC1F150 or F1504 LC1F185 or F1854 LC1F225 or F2254 LC1F265 or F2654 LC1F330 or F3304 LC1F400 or F4004 LC1F500 or F5004 LC1F630 or F6304 LC1F800</p>		

Warning: the contactor ratings must be in decreasing size from top to bottom (largest size at top and smallest size at bottom).

■ For 3-pole changeover contactor pairs, see pages 190 and 191.

TeSys™ F-Line Contactors and Starters Mechanical Interlocks and Power Connections

Components for Assembling 3 and 4-Pole Changeover Contactor Pairs, for Customer Assembly

For additional information see **How to Order** on page 191.

Using 2 contactors of identical rating

For assembly of 4-pole changeover contactor pairs ▲				
Contactor Type ■	Set of power connections		Mechanical Interlock	
	Catalog Number	Weight lb (kg)	Kit Catalog Number	Weight lb (kg)
Horizontally mounted				
LC1F1154	LA9FF977	1.0 (0.460)	LA9FF970	0.13 (0.060)
LC1F1504	LA9F15077	1.0 (0.460)	LA9FF970	0.13 (0.060)
LC1F1854	LA9FG977	1.3 (0.610)	LA9FG970	0.13 (0.060)
LC1F2254	LA9F22577	2.6 (1.200)	LA9FG970	0.13 (0.060)
LC1F2654	LA9FH977	2.6 (1.200)	LA9FJ970	0.30 (0.140)
LC1F3304	LA9FJ977	4.0 (1.800)	LA9FJ970	0.30 (0.140)
LC1F4004	LA9FJ977	4.0 (1.800)	LA9FJ970	0.30 (0.140)
LC1F5004	LA9FK977	5.1 (2.300)	LA9FJ970	0.30 (0.140)
LC1F6304	LA9FL977	7.5 (3.400)	LA9FL970	0.33 (0.150)
Vertically mounted				
LC1F1154 or F1504	●	–	LA9FF4F	0.76 (0.345)
LC1F1854	●	–	LA9FG4G	0.77 (0.350)
LC1F2254	●	–	LA9FG4G	0.77 (0.350)
LC1F2654 or F3304	●	–	LA9FH4H	2.33 (1.060)
LC1F4004	●	–	LA9FJ4J	2.64 (1.200)
LC1F5004	●	–	LA9FK4K	2.64 (1.200)
LC1F6304	●	–	LA9FL4L	2.70 (1.220)
LC1F7804	◆	–	LA9FX971♦	17.2 (7.800)

Using 2 contactors of different ratings

For assembly of 3 or 4-pole changeover contactor pairs			
Contactor Type ■	Mechanical Interlock		
	Kit Catalog Number	Weight lb (kg)	
Vertically mounted			
	at bottom	at top	
LC1F115 or F1154 or LC1F150 or F1504		LC1F185 or F1854	LA9FG4F 0.77 (0.350)
		LC1F225 or F2254	LA9FG4F 0.77 (0.350)
		LC1F265 or F2654	LA9FH4F 1.92 (0.870)
		LC1F330 or F3304	LA9FH4F 1.92 (0.870)
		LC1F400 or F4004	LA9FJ4F 2.05 (0.930)
		LC1F500 or F5004	LA9FK4F 2.07 (0.940)
		LC1F630, F6304 or F800	LA9FL4F 2.07 (0.940)
LC1F185 or F1854 or LC1F225 or F2254		LC1F265 or F2654	LA9FH4G 1.90 (0.860)
		LC1F330 or F3304	LA9FH4G 1.90 (0.860)
		LC1F400 or F4004	LA9FJ4G 2.07 (0.940)
		LC1F500 or F5004	LA9FK4G 2.07 (0.940)
	LC1F630, F6304 or F800	LA9FL4G 2.09 (0.950)	
LC1F265 or F2654 or LC1F330 or F3304		LC1F400 or F4004	LA9FJ4H 2.50 (1.130)
		LC1F500 or F5004	LA9FK4H 2.50 (1.130)
		LC1F630, F6304 or F800	LA9FL4H 2.51 (1.140)
LC1F400 or F4004		LC1F500 or F5004	LA9FK4J 2.64 (1.200)
		LC1F630, F6304 or F800	LA9FL4J 2.70 (1.210)
LC1F500 or F5004		LC1F630, F6304 or F800	LA9FL4K 2.70 (1.210)

- ▲ For assembly of 3-pole changeover contactor pairs, see pages 190 and 191.
 - To order the 2 contactors: see pages 188 and 189. Order 2 contact blocks **LADN•1** to obtain electrical interlocking between the 2 contactors: see pages 194 and 195.
 - All power connections are to be made by the customer, except for contactors type **LC1F780**.
 - ◆ Double mechanical interlock mechanism with 2 interlock connecting rods and 4 power connecting links.
- For assembly of reversers using 3 contactors, vertically mounted, see pages 191 and 192.

TeSys™ F-Line Contactors and Starters Auxiliary Contacts and Timers

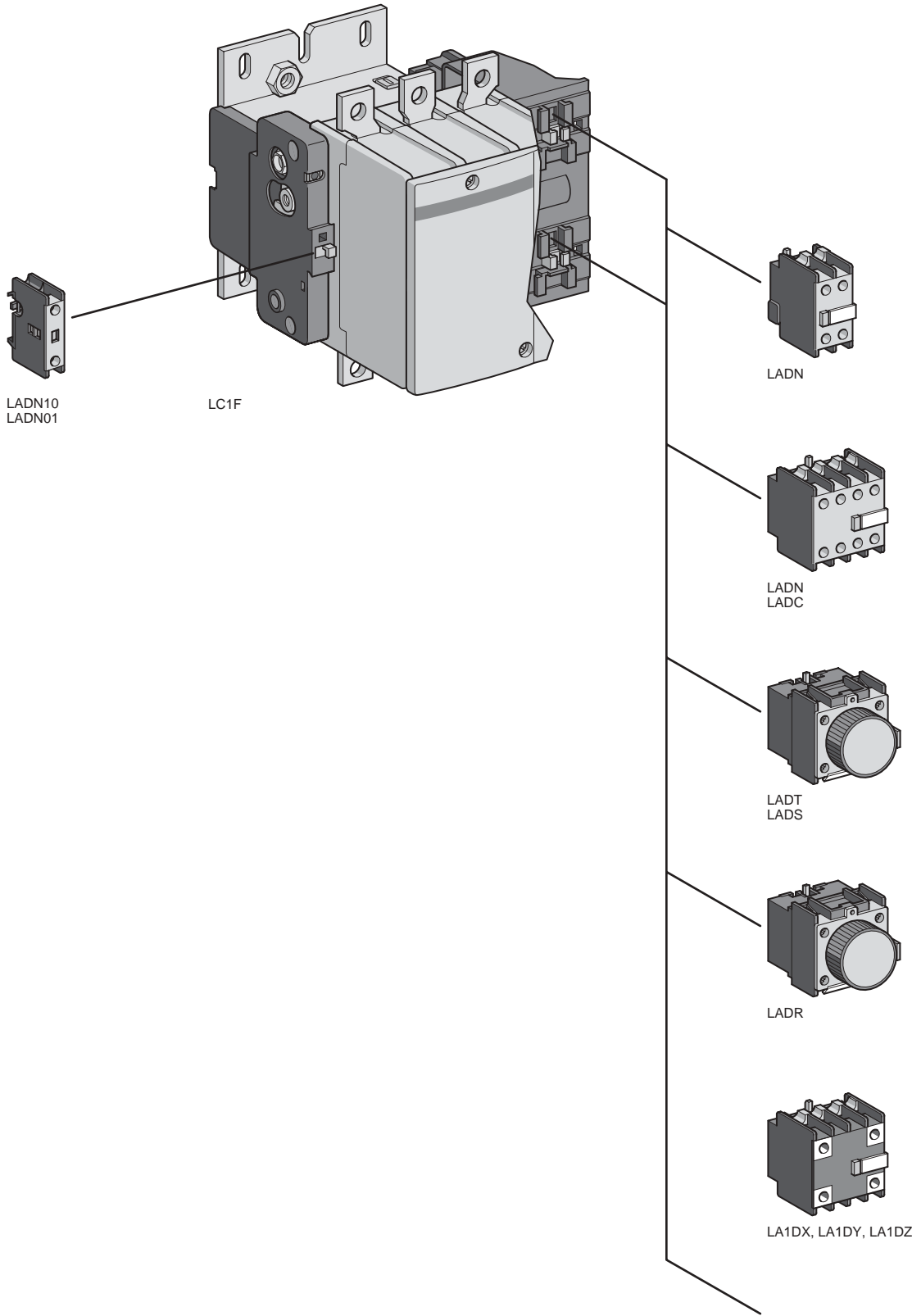



TeSys™ F-Line Contactors and Starters Auxiliary Contacts and Timers

Contactors and Reversing Contactors Type LC1F Auxiliary Contact Blocks and Interface Module

Instantaneous Auxiliary Contact Blocks



For use in normal operating environments

Number of contacts	Max. number of blocks per contactor	Auxiliary Contacts				Catalog Number	Weight lb (kg)
		Side clip-on mounting					
				N.O.	N.C.		
1	1	–	–	1	–	LADN10	0.04 (0.020)
		–	–	–	1	LADN01	0.04 (0.020)
2	2	–	–	1	1	LADN11	0.07 (0.030)
		–	–	2	–	LADN20	0.07 (0.030)
4	2	–	–	–	2	LADN02	0.07 (0.030)
		–	–	2	2	LADN22	0.11 (0.050)
		–	–	1	3	LADN13	0.11 (0.050)
		–	–	4	–	LADN40	0.11 (0.050)
		–	–	–	4	LADN04	0.11 (0.050)
		–	–	3	1	LADN31	0.11 (0.050)
		–	–	2	2 ■	LADC22	0.11 (0.050)
With terminal referencing conforming to standard EN 50012 ◊							
2	2	–	–	1	1	LADN11P	0.07 (0.030)
		–	–	1	1	LADN11G	0.07 (0.030)
4	2	–	–	2	2	LADN22P	0.11 (0.050)
		–	–	2	2	LADN22G	0.11 (0.050)

◊ See page 216 for actual markings.

Instantaneous Auxiliary Contact Blocks With Dust and Damp Protected Contacts

For use in harsh industrial environments

Number of contacts	Max. number of blocks per contactor	Auxiliary Contacts				Catalog Number	Weight lb (kg)
		Side clip-on mounting					
				N.O.	N.C.		
2	2	2	–	–	–	LA1DX20	0.09 (0.040)
		2	2	–	–	LA1DY20	0.09 (0.040)
4	2	2	–	2	–	LA1DZ40	0.11 (0.050)
		2	–	1	1	LA1DZ31	0.11 (0.050)

Time Delay Auxiliary Contacts

Number of Contacts	Max. number of blocks per contactor	Time delay		Catalog Number	Weight lb (kg)
		Side clip-on mounting			
		Type	Range (s)		
1 N.O. + 1 N.C.	2	OnDelay	0.1 to 3 ▲	LADT0	0.13 (0.060)
			0.1 to 30	LADT2	0.13 (0.060)
			10 to 180	LADT4	0.13 (0.060)
			1 to 30 ▼	LADS2	0.13 (0.060)
		OffDelay	0.1 to 3 ▲	LADR0	0.13 (0.060)
			0.1 to 30	LADR2	0.13 (0.060)
			10 to 180	LADR4	0.13 (0.060)

- Sealed dust tight contacts.
- ◆ Ground terminal connections.
- Including 1 N.O. + 1 N.C. make before break.
- ▲ With extended scale from 0.1 to 0.6 s.
- ▼ With switching time of 40 ms ± 15 ms between opening of the N.C. contact and closing of the N.O. contact.

TeSys™ F-Line Contactors and Starters Accessories and Spare Parts

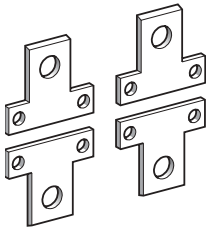
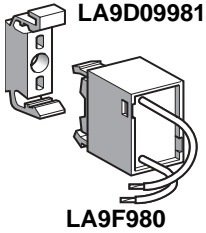

LA9F602

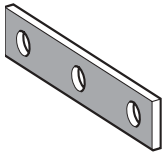

LA9F601



DZ3FA3

Contactors and Reversing Contactors Type LC1F Suppressor Blocks and Cabling Accessories

Suppressor Blocks

Type of Suppressor	Specifications	Coil Voltage Range	Catalog Number	Weight lb (kg)
RC (Resistor-Capacitor)	Used on AC only Limits transients to 3X Uc max. Increases contactor drop out time 10 to 30 %	24 - 48	LA4FRCE	0.07 (0.030)
		50 - 110	LA4FRCF	0.07 (0.030)
		127 - 240	LA4FRCP	0.07 (0.030)
		265 - 415	LA4FRCV	0.07 (0.030)
Varistor	Used on AC or DC Limits Transients to 2 X Uc max.	24 - 48	LA4FVE	0.07 (0.030)
		50 - 110	LA4FVF	0.07 (0.030)
		127 - 240	LA4FVP	0.07 (0.030)
		265 - 415	LA4FVV	0.07 (0.030)
Bi-directional Diode	Used on AC or DC Limits Transients to 2.5 X Uc max.	24 - 48	LA4FTE	0.07 (0.030)
		50 - 110	LA4FTF	0.07 (0.030)
		127 - 240	LA4FTP	0.07 (0.030)
		265 - 415	LA4FTV	0.07 (0.030)
Diode	Used on DC only No overvoltage Polarity sensitive Increases contactor drop out time 300-400%	24 - 48	LA4FDE	0.07 (0.030)
		55 - 110	LA4FDF	0.07 (0.030)
		125 - 250	LA4FDP	0.07 (0.030)
		280 - 440	LA4FDV	0.07 (0.030)
Mounting bracket (for 35mm DIN rail or panel mounting) for suppressor block			LA9D09981	0.02 (0.010)

Cabling Accessories

Links for parallel connection of poles (in pairs)				
For use on 4-pole contactors	Set of 4 links	Weight lb (kg)		
	Set Catalog Number			
LC1F1154	LA9FF602	0.44 (0.200)		
LC1F1504, F1854	LA9FG602	0.77 (0.350)		
LC1F2254, F2654, F3304, F4004	LA9FH602	2.20 (1.000)		
LC1F5004	LA9FK602	3.85 (1.750)		
LC1F6304	LA9FL602	6.61 (3.000)		
Links for "star" connection of 3 poles				
LC1F115	LA9FF601	0.08 (0.035)		
LC1F150, F185	LA9FG601	0.11 (0.050)		
LC1F225, F265, F330, F400	LA9FH601	0.26 (0.120)		
LC1F500	LA9FK601	0.40 (0.180)		
LC1F630, F800	LA9FL601	1.21 (0.550)		
Control circuit voltage take-off from power terminals				
For use on contactors	Mounted on bolt size	Sold in lots of	Unit Catalog Number	Weight lb (kg)
LC1F115	M6	10	DZ3FA3	0.008 (0.004)
LC1F150, F185	M8	10	DZ3GA3	0.008 (0.004)
LC1F225 to F500	M10	10	DZ3HA3	0.013 (0.006)
LC1F630, F800	M12	10	DZ3JA3	0.019 (0.009)

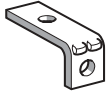

LA9F•981

Contactors and Reversing Contactors Type LC1F
Suppressor Blocks and Cabling Accessories

Right-Angled Connectors

For contactors or thermal overload relays					
For use on		Connector		Set of 3 Connectors	
Contactors	Thermal Overload Relays	Width	Type	Set Catalog Number	Weight lb (kg)
LC1F115	LR•F5•67, LR1F105, F125	0.59" (15 mm)	Rear	LA9FF981	0.13 (0.060)
			Side	LA9FF979	0.53 (0.240)
			Large s. area	LA9FF980	0.33 (0.150)
LC1F150, F185	LR•F5•69, F5•71	0.79" (20 mm)	Rear	LA9FG981	0.18 (0.080)
			Side	LA9FG979	0.77 (0.350)
			Large s. area	LA9FG980	0.44 (0.200)
LC1F225, F265, F330, F400	LR•F6•73, F6•75, F6•77	0.98" (25 mm)	Rear	LA9FJ981	0.95 (0.430)
			Side	LA9FJ979	1.65 (0.750)
			Large s. area	LA9FJ980	1.08 (0.490)
LC1F500	LR•F7•79, F7•81	1.18" (30 mm)	Rear	LA9FK981	1.06 (0.480)
			Side	LA9FK979	2.03 (0.920)
			Large s. area	LA9FK980	1.76 (0.800)
LC1F630, F800	LR•F8•83, F8•85	1.57" (40 mm)	Rear	LA9FL981	2.67 (1.210)
			Side	LA9FL979	5.66 (2.570)
			Large s. area	LA9FL980	7.03 (3.190)

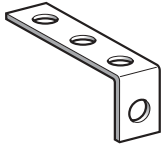

LA9F•979

Connection Accessories

For reversing contactors or star-delta contactors combined with a thermal overload relay				
For use on		Width of	Set of 3 bus bars	
Contactors	Thermal Overload Relays	Connector Plates	Set Catalog Number	Weight lb (kg)
LC1F115	LR9F5357, F5363 F5367, F5369	0.59" (15 mm)	LA7F401	0.24 (0.110)
LC1F150 and F185	LR9F5357, F5363 F5367, F5369	0.79" (20 mm)	LA7F402	0.24 (0.110)
LC1F225 and F265	LR9F5371	0.98" (25 mm)	LA7F403	0.35 (0.160)
LC1F330 and F400	LR9F7375 and F7379	0.98" (25 mm)	LA7F404	0.35 (0.160)
LC1F400	LR9F7381	0.98" (25 mm)	LA7F404	0.35 (0.160)
LC1F500	LR9F7375, F7379 F7381	1.18" (30 mm)	LA7F405	0.60 (0.270)
LC1F630	LR9F7381	1.57" (40 mm)	LA7F406	1.30 (0.600)

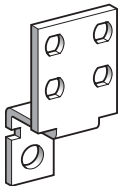

LA9F•980

TeSys™ F-Line Contactors and Starters Accessories and Spare Parts

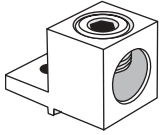

DZ2F●●

Contactors and Reversing Contactors Type LC1F Cabling Accessories and Spare Parts

Lug Kits

Lugs can be ordered either individually (for 2-pole and 4-pole contactors) or in sets of 6 (for 3-pole contactors). Mounting hardware is provided with the contactors, not the kits.

Single lug	Set of six lugs	Cable size AWG range	Suitable for contactor LC1●●●● / CR1●●●●	Suitable for overload relay LR9●●●● ▲
DZ2FF1	DZ2FF6	14 to 2/0	F115	none
DZ2FG1	DZ2FG6	6 to 3/0	F150, F185	F5●57, F5●63, F5●67, F5●69
DZ2FH1	DZ2FH6	6 to 300 MCM	F265, F330	LR9F●71
DZ2FJ1	DZ2FJ6	4 to 500 MCM	F400	none
DZ2FK1	DZ2FK6	2x2 to 600 MCM	F500	F7●75, F7●79
DZ2FL● ■	DZ2FL6	3x2 to 600 MCM	F630, F800	F7●81
DZF2FX1	DZ2FX6	4x1/0 to 750 MCM	F780	none

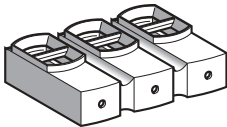

LA9F103

Insulated Terminal Blocks

For use on 3-pole contactors	Cable Size AWG Range	Set of 2 blocks	
		Set Catalog Number	Weight lb (kg)
LC1F115, F150, F185 (provides IP20 touch-safe protection)	#6 to 300 mcm	LA9F103	1.23 (0.560)

Power Terminal Protection Shrouds

These clear plastic protective shrouds are an effective means to meet international touch-safe requirements for power terminals. They are designed to be used with power cables that have been bolted to the terminal. Note: The protection shrouds do not attach to contactors or overloads utilizing **DZ2F** lug kits.

For use with 2-, 3-, and 4-pole contactors	Number of shrouds per set	Set Catalog Number	Weight lb (kg)
LC1F115	6	LA9F701	0.55 (0.250)
LC1F150, F185 CR1F150, F185	6	LA9F702	0.55 (0.250)
LC1F225, F265, F330, F400 and F4002, F500 and F5002 CR1F265, F400 and F500	6	LA9F703	0.55 (0.250)
LC1F630, F6302 and F800 CR1F630	6	LA9F704	0.55 (0.250)
LC1F1154	8	LA9F706	0.66 (0.300)
LC1F1504 and F1854	8	LA9F707	0.66 (0.300)
LC1F2254, F2654, F3304, F4004, F5004	8	LA9F708	0.66 (0.300)
LC1F6304	8	LA9F709	0.66 (0.300)

- ▲ When direct mounting the **LR9F** to an **LC1F** or **CR1F** contactor, lugs of different sizes may be required. See page 220 for additional information.
- For 3-pole F630 contactors, order **DZ2FL1** for L1 and T3, **DZ2FL2** for L2 and T2, and **DZ2PL3** for L3 and T1 terminals.
For 4-pole F6304 contactors, order **DZ2FL1** for L1 and T4, **DZ2FL2** for L2, T2, L3 and T3, and **DZ2FL3** for L4 and T1 terminals.

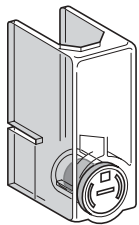

LA9F701

TeSys™ F-Line Contactors and Starters Accessories and Spare Parts

Contactors and Reversing Contactors Type LC1F Spare Parts

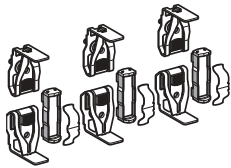

LA5FG431

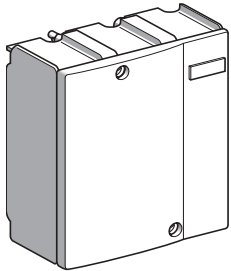

LA5F40050

Main Contact Sets

Per pole: 2 stationary contacts and 1 moving contact, 2 deflectors, 1 leaf spring, screws and washers

For contactor	Type	Replacement for	Catalog Number	Weight lb (kg)
2-pole	LC1F4002	2 poles	LA5F400802	3.00 (1.350)
	LC1F5002	2 poles	LA5F500802	4.30 (1.950)
	LC1F6302	2 poles	LA5F630802	10.3 (4.700)
3-pole	LC1F115, F150	3 poles	LA5FF431	0.60 (0.270)
	LC1F185, F225	3 poles	LA5FG431	0.77 (0.350)
	LC1F265	3 poles	LA5FH431	1.45 (0.660)
	LC1F330, F400	3 poles	LA5F400803	4.40 (2.000)
	LC1F500	3 poles	LA5F500803	6.50 (2.950)
	LC1F630	3 poles	LA5F630803	13.4 (6.100)
	LC1F780	1 pole	LA5F780801 ■	10.4 (4.700)
4-pole	LC1F800	3 poles	LA5F800803	29.1 (13.200)
	LC1F1504, F1154	4 poles	LA5FF441	13.4 (6.100)
	LC1F1854, F2254	4 poles	LA5FG441	0.80 (0.360)
	LC1F2654	4 poles	LA5FH441	1.20 (0.465)
	LC1F3304, F4004	4 poles	LA5F400804	1.94 (0.880)
	LC1F5004	4 poles	LA5F500804	5.95 (2.700)
	LC1F6304	4 poles	LA5F630804	8.59 (3.900)
	LC1F7804	1 pole	LA5F780801 ■	17.9 (8.150)
		4 poles	LA5F780804	10.36 (4.700)
				38.1 (17.300)

Arc Chambers

For contactor	Type	Replacement for	Catalog Number	Weight lb (kg)
2-pole	LC1F4002	2 poles	LA5F400250	1.91 (0.870)
	LC1F5002	2 poles	LA5F500250	2.75 (1.250)
	LC1F6302	2 poles	LA5F630250	4.62 (2.100)
3-pole	LC1F115	3 poles	LA5F11550	1.08 (0.490)
	LC1F150	3 poles	LA5F15050	1.08 (0.490)
	LC1F185	3 poles	LA5F18550	1.47 (0.670)
	LC1F225	3 poles	LA5F22550	1.47 (0.670)
	LC1F265	3 poles	LA5F26550	2.03 (0.920)
	LC1F330	3 poles	LA5F33050	2.90 (1.300)
	LC1F400	3 poles	LA5F40050	2.90 (1.300)
	LC1F500	3 poles	LA5F50050	4.08 (1.850)
	LC1F630	3 poles	LA5F63050	6.94 (3.150)
	LC1F780	1 pole	LA5F780150 ■	4.63 (2.100)
LC1F800	3 poles	LA5F80050	6.94 (3.150)	
4-pole	LC1F1154	4 poles	LA5F115450	1.45 (0.660)
	LC1F1504	4 poles	LA5F150450	1.45 (0.660)
	LC1F1854	4 poles	LA5F185450	2.00 (0.910)
	LC1F2254	4 poles	LA5F225450	2.20 (1.000)
	LC1F2654	4 poles	LA5F265450	2.70 (1.220)
	LC1F3304	4 poles	LA5F330450	3.83 (1.740)
	LC1F4004	4 poles	LA5F400450 ◆	3.83 (1.740)
	LC1F5004	4 poles	LA5F500450 ◆	5.51 (2.500)
	LC1F6304	4 poles	LA5F630450 ▲	9.26 (4.200)
LC1F7804	1 pole	LA5F780150 ■	9.63 (2.100)	

- Comprising 2 identical items per pole.
- ◆ Comprising two 2-pole arc chambers.
- ▲ Comprising single-pole arc chambers.

TeSys™ F-Line Contactors and Starters

F-line Voltage Code Table

F-line Voltage Code

Voltage	Frequency	F-line (see notes at end of table)				
		LC1F115 - F225 Note F1, F2	LC1F265 - F400 Note F1, F2	LC1F500 - F630 Note F1, F2	LC1F780 Note F1, F2	LC1F800 Note F1, F2, F3
5	Low Consump DC	-	-	-	-	-
12	50/60	-	-	-	-	-
	50	-	-	-	-	-
	DC	-	-	-	-	-
	Low Consump DC	-	-	-	-	-
	Wide Range DC	-	-	-	-	-
20	50/60	-	-	-	-	-
	50	-	-	-	-	-
	60	-	-	-	-	-
	DC	-	-	-	-	-
	Low Consump DC	-	-	-	-	-
24	50/60	-	-	-	-	-
	50	B5	-	-	-	-
	60	B6	-	-	-	-
	40-400	-	B7 Note F4	-	-	-
	DC	BD	BD Note F4	-	-	-
	Low Consump DC	-	-	-	-	-
	Wide Range DC	-	-	-	-	-
36	50/60	-	-	-	-	-
	DC	-	-	-	-	-
	Wide Range DC	-	-	-	-	-
42	50/60	-	-	-	-	-
	50	D5	-	-	-	-
	60	-	-	-	-	-
48	50/60	-	-	-	-	-
	50	E5	-	-	-	-
	60	E6	-	-	-	-
	40-400	E7	E7	E7	-	-
	DC	ED	ED	ED	-	-
	Low Consump DC	-	-	-	-	-
60	50/60	-	-	-	-	-
	DC	-	-	-	-	-
72	DC	-	-	-	-	-
	Low Consump DC	-	-	-	-	-
	Wide Range DC	-	-	-	-	-

F-line Voltage Code

Voltage	Frequency	F-line (see notes at end of table)				
		LC1F115 - F225 Note F1, F2	LC1F265 - F400 Note F1, F2	LC1F500 - F630 Note F1, F2	LC1F780 Note F1, F2	LC1F800 Note F1, F2, F3
96	Low Consump DC	-	-	-	-	-
100	50/60	-	-	-	-	-
	DC	-	-	-	-	-
110	50/60	-	-	-	-	-
	50	F5	-	-	-	-
	60	F6	-	-	-	-
	40-400	F7	F7	F7	F7	-
	DC	FD	FD	FD	FD	FW
	Low Consump DC	-	-	-	-	-
	Wide Range DC	-	-	-	-	-
110/127	40-400	-	-	-	-	FE7
115	50/60	-	-	-	-	-
	50	FE5	-	-	-	-
	40-400	FE7	FE7	FE7	FE7	-
120	50/60	-	-	-	-	-
	50	-	-	-	-	-
	60	G6	-	-	-	-
	40-400	G7	G7 Note F5	F7	F7	-
	DC	-	-	-	-	FW
	Low Consump DC	-	-	-	-	-
	125	DC	GD	GD	GD	GD
127	50/60	-	-	-	-	-
	60	G5	-	-	-	-
155	40-400	G7	G7	G7	G7	-
174	DC	-	-	-	-	-
200	50/60	-	-	-	-	-
	DC	-	-	-	-	-
200/208	50/60	-	-	-	-	-
	60	L6	-	-	-	-
	40-400	-	L7	L7	L7	-
208	50/60	-	-	-	-	-
	60	-	-	-	-	-
	40-400	L7	-	-	-	-

TeSys™ F-Line Contactors and Starters

F-line Voltage Code Table

F-line Voltage Code

Voltage	Frequency	F-line (see notes at end of table)				
		LC1F115 - F225 Note F1, F2	LC1F265 - F400 Note F1, F2	LC1F500 - F630 Note F1, F2	LC1F780 Note F1, F2	LC1F800 Note F1, F2, F3
220	50/60	-	-	-	-	-
	50	M5	-	-	-	-
	60	M6	-	-	-	-
	40-400	M7	M7	M7	M7	-
	DC	-	MD	MD	MD	-
	Low Consump DC	-	-	-	-	-
	Wide Range DC	-	-	-	-	-
220/230	50/60	-	-	-	-	-
	50	-	-	-	-	-
	60	-	-	-	-	-
	40-400	-	-	-	-	-
	DC	MD	-	-	-	-
220/240	40-400	-	-	-	-	P7
	DC	-	-	-	-	MW
230	50/60	-	-	-	-	-
	50	P5	-	-	-	-
	60	-	-	-	-	-
	40-400	P7	P7	P7	P7	-
	DC	-	-	-	-	-
230/240	50/60	-	-	-	-	-
	50/60	-	-	-	-	-
240	50	U5	-	-	-	-
	60	U6	-	-	-	-
	40-400	U7	U7	U7	U7	-
	DC	-	-	-	-	-
	DC	UD	UD	UD	UD	-
250	Low Consump DC	-	-	-	-	-
	50/60	-	-	-	-	-
256	50	-	-	-	-	-
	50	-	-	-	-	-
277	50/60	-	-	-	-	-
	50	W5	-	-	-	-
	40-400	-	W7	W7	W7	-
380	50/60	-	-	-	-	-
	50	Q5	-	-	-	-
	60	Q6	-	-	-	-
	40-400	Q7	Q7	Q7	Q7	-
380/400	50/60	-	-	-	-	-
	50	-	-	-	-	-
	60	-	-	-	-	-
	40-400	-	-	-	-	-
	DC	-	-	-	-	QW
380/440	40-400	-	-	-	-	V7

F-line Voltage Code

Voltage	Frequency	F-line (see notes at end of table)				
		LC1F115 - F225 Note F1, F2	LC1F265 - F400 Note F1, F2	LC1F500 - F630 Note F1, F2	LC1F780 Note F1, F2	LC1F800 Note F1, F2, F3
400	50/60	-	-	-	-	-
	50	V5	-	-	-	-
	40-400	V7	V7	V7	V7	-
400/415	50/60	-	-	-	-	-
415	50/60	-	-	-	-	-
	50	N5	-	-	-	-
	40-400	N7	N7	N7	N7	-
415-440	50	-	-	-	-	-
	40-400	-	-	-	-	-
440	50/60	-	-	-	-	-
	50	-	-	-	-	-
	60	R6	-	-	-	-
	40-400	R7	R7	R7	R7	-
	DC	-	RD	RD	RD	-
440/460	DC	RD	-	-	-	-
460/480	60	Q5	-	-	-	-
480	50/60	-	-	-	-	-
	50	-	-	-	-	-
	60	-	-	-	N7	-
	40-400	-	S7, Note F4	-	-	-
500	50/60	-	-	-	-	-
	50	S5	-	-	-	-
	40-400	S7	S7	S7	S7	-
575	50/60	-	-	-	-	-
	60	-	-	-	-	-
600	50/60	-	-	-	-	-
	60	-	-	-	-	-
	40-400	-	-	X7	-	-
660	50	-	-	-	-	-
	60	Y6	-	-	-	-
660/690	50/60	-	-	-	-	-

F-line Notes:

- F1 For operating ranges refer to technical data section of the F-line contactors. Ranges vary as a function of the supply (AC/DC).
- F2 For non-stock voltage codes, order contactor and coil separately. See page 234 for coils.
- F3 Built in surge suppressor included on LC1F800 coils.
- F4 For use with LC1F265 and LC1F330 only.
- F5 For LC1F400 contactor with 120 Vac coil, use F7 code.

TeSys™ F-Line Contactors and Starters

Selection - Coils

Contactors Type LC1F

Coils for LC1F115 to F225, AC supply 50 to 60 Hz

Maximum ambient air temperature: 55 °C (131 °F); above this, use an **LX9F** coil, see page 208 to 209.
 Operating cycles/hour ($\theta \leq 55$ °C [131 °F]): ≤ 2400 .

Control Circuit Voltage		Average resistance at 20 °C (68 °F) $\pm 10\%$	Inductance of Closed Circuit	Voltage Code	Catalog Number	Weight lb (kg)
Vc 50 Hz	Vc 60 Hz					
V	V	Ω	H			

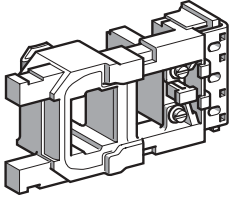

LX1FF...

For Contactors LC1F115 and LC1F150

24	–	0.27	0.04	B5	LX1FF024	0.95 (0.430)
42	–	0.94	0.13	–	LX1FF042	0.95 (0.430)
–	48	0.78	0.11	E6	LX1FF040	0.95 (0.430)
48	–	1.17	0.16	E5	LX1FF048	0.95 (0.430)
–	110	4.55	0.59	F6	LX1FF092	0.95 (0.430)
–	115/120	4.77	0.64	G6	LX1FF095	0.95 (0.430)
110/115	–	6.38	0.86	F5	LX1FF110	0.95 (0.430)
127	–	9.14	1.15	G5	LX1FF127	0.95 (0.430)
–	200/208	14.5	1.87	L6	LX1FF162	0.95 (0.430)
–	220	18.4	2.38	M6	LX1FF184	0.95 (0.430)
–	230/240	18.9	2.5	U6	LX1FF187	0.95 (0.430)
220/230	265/277	28.1	3.44	M5	LX1FF220	0.95 (0.430)
240	–	31.1	4.1	U5	LX1FF240	0.95 (0.430)
–	380	57.2	7.05	Q6	LX1FF316	0.95 (0.430)
–	415	67.9	8.21	N6	LX1FF340	0.95 (0.430)
–	440	72.6	9.21	R6	LX1FF360	0.95 (0.430)
380/400	460/480	86.9	10.3	Q5	LX1FF380	0.95 (0.430)
415/440	–	95.1	12	N5	LX1FF415	0.95 (0.430)
500	–	141	17	S5	LX1FF500	0.95 (0.430)
–	660	172	20.3	Y6	LX1FF550	0.95 (0.430)
660	–	254	28.9	Y5	LX1FF660	0.95 (0.430)
–	1000	414	48.9	–	LX1FF850	0.95 (0.430)
1000	–	610	68.5	–	LX1FF1000	0.95 (0.430)

Specifications

Average consumption at 20 °C (68 °F):
 - inrush 50 Hz: 550 VA; 60 Hz: 660 VA.
 - sealed 50 Hz: 45 VA; 60 Hz: 55 VA, $\cos \varphi = 0.32$.
 Heat dissipation: 12 to 16 W
 Operating time at Vc: closing = 23 to 35 ms; Opening = 5 to 15 ms

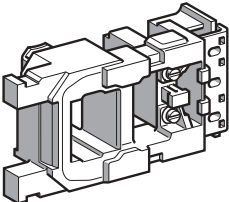

LX1FG...

For Contactors LC1F185 and LC1F225

24	–	0.18	0.03	B5	LX1FG024	1.21 (0.550)
42	–	0.57	0.09	–	LX1FG042	1.21 (0.550)
–	48	0.47	0.08	E6	LX1FG040	1.21 (0.550)
48	–	0.71	0.12	E5	LX1FG048	1.21 (0.550)
–	110	2.74	0.44	F6	LX1FG092	1.21 (0.550)
–	115/120	2.87	0.49	G6	LX1FG095	1.21 (0.550)
110/115	–	4.18	0.65	F5	LX1FG110	1.21 (0.550)
127	–	5.35	0.86	G5	LX1FG127	1.21 (0.550)
–	200/208	8.8	1.41	L6	LX1FG162	1.21 (0.550)
–	220	11.1	1.8	M6	LX1FG184	1.21 (0.550)
–	230/240	11.4	1.87	U6	LX1FG187	1.21 (0.550)
220/230	265/277	16.5	2.59	M5	LX1FG220	1.21 (0.550)
240	–	20.1	3.09	U5	LX1FG240	1.21 (0.550)
–	380	34	5.32	Q6	LX1FG316	1.21 (0.550)
–	415	40.8	6.2	N6	LX1FG340	1.21 (0.550)
–	440	43.5	6.94	R6	LX1FG360	1.21 (0.550)
380/400	460/480	51.3	7.75	Q5	LX1FG380	1.21 (0.550)
415/440	–	62.3	9.06	N5	LX1FG415	1.21 (0.550)
500	–	82.7	12.8	S5	LX1FG500	1.21 (0.550)
–	660	103	15.3	Y6	LX1FG550	1.21 (0.550)
660	–	154	21.8	Y5	LX1FG660	1.21 (0.550)
–	1000	249	36.6	–	LX1FG850	1.21 (0.550)
1000	–	370	51.6	–	LX1FG1000	1.21 (0.550)

Specifications

Average consumption at 20 °C (68 °F):
 - inrush 50 Hz: 805 VA; 60 Hz: 970 VA.
 - sealed 50 Hz: 55 VA; 60 Hz: 66 VA, $\cos \varphi = 0.34$.
 Heat dissipation: 18 to 24 W
 Operating time at Vc: closing = 20 to 35 ms; Opening = 7 to 15 ms

Contactors Type LC1F
Coils for LC1F265 to F500, AC supply 40 to 400 Hz

Low sealed consumption.
Operate on networks with harmonic numbers ≤ 7
Operating cycles/hour ($\theta \leq 55\text{ °C}$ [131 °F]) ≤ 2400.

Control circuit voltage Vc V	Average resistance at 20 °C (68 °F) ±10%		Inductance of Closed Circuit H	Voltage Code	Catalog Number	Weight lb (kg)
	Inrush Ω	Sealed Ω				

For Contactors LC1F265 and LC1F330

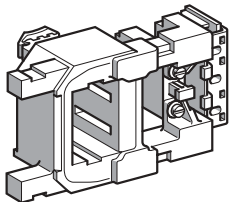

LX1FH...2

24	0.8	20	■	B7	LX1FH0242	1.65 (0.750)
48	2.96	72	■	E7	LX1FH0482	1.65 (0.750)
110/115	18.7	415	■	F7	LX1FH1102	1.65 (0.750)
120/127	22.9	536	■	G7	LX1FH1272	1.65 (0.750)
200/208	57.8	1285	■	L7	LX1FH2002	1.65 (0.750)
220/230	71.6	1621	■	M7	LX1FH2202	1.65 (0.750)
240	71.6	1621	■	U7	LX1FH2402	1.65 (0.750)
277	114.3	2425	■	W7	LX1FH2772	1.65 (0.750)
380/415	222	5075	■	Q7	LX1FH3802	1.65 (0.750)
480/500	345	7990	■	S7	LX1FH5002	1.65 (0.750)
600/660	521	11 988	■	X7	LX1FH6002	1.65 (0.750)
1000	1218	30 124	■	-	LX1FH10002	1.65 (0.750)

Specifications

Average consumption at 20 °C (68 °F) for 50 or 60 Hz and $\cos \varphi = 0.9$:
- inrush: 600 to 700 VA.
- sealed: 8 to 10 VA.
Heat dissipation: 8 W
Operating time at Vc: closing = 40 to 65 ms; Opening = 100 to 170 ms

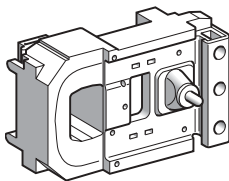

LX1FJ...3

For Contactor LC1F400

48	1.6	29.5	0.18	E7	LX1FJ048	2.20 (1.000)
110/120	9.8	230	1.35	F7	LX1FJ110	2.20 (1.000)
127	12.8	280	1.75	G7	LX1FJ127	2.20 (1.000)
200/208	30	815	4.1	L7	LX1FJ200	2.20 (1.000)
220/230	37	1030	5.1	M7	LX1FJ220	2.20 (1.000)
230/240	47.5	1320	6.4	U7	LX1FJ240	2.20 (1.000)
265/277	61	1700	8.1	W7	LX1FJ280	2.20 (1.000)
380/400	120	3310	15.8	Q7	LX1FJ380	2.20 (1.000)
415/480	145	4070	19.4	N7	LX1FJ415	2.20 (1.000)
500	190	4980	25.5	S7	LX1FJ500	2.20 (1.000)
550/600	243	6310	27.4	X7	LX1FJ600	2.20 (1.000)
1000	720	19 420	84.6	-	LX1FJ1000	2.20 (1.000)

Specifications

Average consumption at 20 °C (68 °F) for 50 or 60 Hz and $\cos \varphi = 0.9$:
- inrush: 1000 to 1150 VA.
- sealed: 12 to 18 VA.
Heat dissipation: 14 W
Operating time at Vc: closing = 40 to 75 ms; Opening = 100 to 170 ms

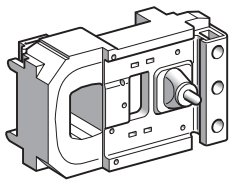

LX1FK...3

For Contactor LC1F500

48	1.9	33.5	0.19	E7	LX1FK048	2.53 (1.150)
110/120	9.55	260	1.25	F7	LX1FK110	2.53 (1.150)
127	11.5	315	1.5	G7	LX1FK127	2.53 (1.150)
200/208	29	735	3.75	L7	LX1FK200	2.53 (1.150)
220/230	35.5	915	4.55	M7	LX1FK220	2.53 (1.150)
230/240	44.5	1160	5.75	U7	LX1FK240	2.53 (1.150)
265/277	56.5	1490	7.3	W7	LX1FK280	2.53 (1.150)
380/400	112	2980	14.7	Q7	LX1FK380	2.53 (1.150)
415/480	143	3730	18.4	N7	LX1FK415	2.53 (1.150)
500	172	4590	22.8	S7	LX1FK500	2.53 (1.150)
550/600	232	5660	23.9	X7	LX1FK600	2.53 (1.150)
1000	679	16 960	72	-	LX1FK1000	2.53 (1.150)

Specifications

Average consumption at 20 °C (68 °F) for 50 or 60 Hz, $\cos \varphi = 0.9$:
- inrush: 1050 to 1150 VA.
- sealed: 16 to 20 VA.
Heat dissipation: 18 W
Operating time at Vc: closing = 40 to 75 ms; Opening = 100 to 170 ms

■ Please consult your Local Square D Field Sales Office.

TeSys™ F-Line Contactors and Starters

Selection - Coils

Contactors Type LC1F

Coils for LC1F630 to F800, AC supply 40 to 400 Hz

Low sealed consumption.
Operate on networks with harmonic numbers ≤ 7 .

Control circuit voltage Vc	Average resistance at 20 °C (68 °F) $\pm 10\%$		Inductance of Closed Circuit	Voltage Code	Catalog Number	Weight lb (kg)
	Inrush	Sealed				
V	Ω	Ω	H			

For Contactor LC1F630

48	1.1	17.1	0.09	E7	LX1FL048	3.30 (1.500)
110/120	6.45	165	1.85	F7	LX1FL110	3.30 (1.500)
127	8.1	205	1.05	G7	LX1FL127	3.30 (1.500)
200/208	20.5	605	2.65	L7	LX1FL200	3.30 (1.500)
220/240	25.5	730	3.35	M7	LX1FL220	3.30 (1.500)
265/277	31	900	4.1	W7	LX1FL260	3.30 (1.500)
380/400	78	2360	10.5	Q7	LX1FL380	3.30 (1.500)
415/480	96	2960	13	N7	LX1FL415	3.30 (1.500)
500	120	3660	16.5	S7	LX1FL500	3.30 (1.500)
550/600	155	4560	19.5	X7	LX1FL600	3.30 (1.500)
1000	474	12 880	56.2	-	LX1FL1000	3.30 (1.500)

Specifications

Average consumption at 20 °C (68 °F) for 50 or 60 Hz, $\cos \phi = 0.9$:
 - inrush: 1500 to 1730 VA.
 - sealed: 20 to 25 VA.
 Operating cycles/hour ($\theta \leq 55$ °C [131 °F]): 1200.
 Heat dissipation: 20 W
 Operating time at Vc: closing = 40 to 80 ms; Opening = 100 to 200 ms

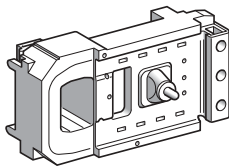

LX1FL●●●

For Contactor LC1F780

Replacement rectifier for use with LX1FX●●● coils: DR5TX5S.

110/120	4.95 ▲	230 ▲	0.21	F7	LX1FX110 ■	6.61 (3.000)
127	6.1 ▲	280 ▲	0.26	G7	LX1FX127 ■	6.61 (3.000)
200/208	15.5 ▲	750 ▲	0.66	L7	LX1FX200 ■	6.61 (3.000)
220/240	19.5 ▲	920 ▲	0.82	M7	LX1FX220 ■	6.61 (3.000)
265/277	29.8 ▲	1330 ▲	1.25	W7	LX1FX280 ■	6.61 (3.000)
380	60.9 ▲	2780 ▲	2.3	Q7	LX1FX380 ■	6.61 (3.000)
415/480	74.3 ▲	3340 ▲	2.8	N7	LX1FX415 ■	6.61 (3.000)
500	92 ▲	4180 ▲	3.5	S7	LX1FX500 ■	6.61 (3.000)

Specifications

Average consumption at 20 °C (68 °F) for 50 or 60 Hz, $\cos \phi = 0.9$:
 - inrush: 1900 to 2300 VA.
 - sealed: 44 to 55 VA.
 Operating cycles/hour ($\theta \leq 55$ °C [131 °F]): 600.
 Heat dissipation: 2 x 22 W
 Operating time at Vc: closing = 40 to 80 ms; Opening = 130 to 230 ms

For Contactor LC1F800

110/127	-	-	-	FW	LX4F8FW *	3.64 (1.650)
220/240	-	-	-	MW	LX4F8MW *	3.64 (1.650)
380/440	-	-	-	QW	LX4F8QW *	3.64 (1.650)

Specifications

Operating cycles/hour ($\theta \leq 55$ °C [131 °F]): 600.
 Heat dissipation: 25 W
 Operating time at Vc: closing = 40 to 80 ms; Opening = 20 to 40 ms

- Catalog number includes a set of 2 identical coils, to be connected in series.
- ▲ Value for the 2 coils in series.
- * Coil circuit requires a separately mounted rectifier catalog number DR5 TE4U.

Contactors Type LC1F
Coils for LC1F115 to F400, DC supply

Low sealed consumption.
Operate on networks with harmonic numbers ≤ 7.
Operating cycles/hour ($\theta \leq 55\text{ °C}$ [131 °F]) ≤ 2400.

Control circuit voltage Vc	Average resistance at 20 °C (68 °F) ±10%		Inductance of Closed Circuit	Voltage Code	Catalog Number	Weight lb (kg)
	Inrush	Sealed				
V	Ω	Ω	H			

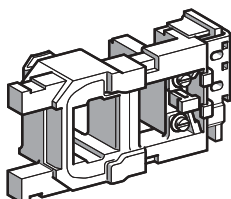

LX4FF●●●

For Contactors LC1F115 and LC1F150

24	1.12	177	11	BD	LX4FF024	0.95 (0.430)
48	4.52	715	42.7	ED	LX4FF048	0.95 (0.430)
110	21.7	2940	179	FD	LX4FF110	0.95 (0.430)
125	26.8	3560	223	GD	LX4FF125	0.95 (0.430)
220/230	84	11 100	704	MD	LX4FF220	0.95 (0.430)
250	105	13 000	868	UD	LX4FF250	0.95 (0.430)
440/460	301	48 200	4000	RD	LX4FF440	0.95 (0.430)

Specifications

Average consumption:
- inrush: 543 to 665 W.
- sealed: 3.94 to 4.83 W.
Operating time at Vc: closing = 30 to 40 ms; Opening = 30 to 50 ms

For Contactors LC1F185 and LC1F225

24	0.79	169	14.9	BD	LX4FG024	1.21 (0.550)
48	3.2	662	55.3	ED	LX4FG048	1.21 (0.550)
110	14.9	2810	241	FD	LX4FG110	1.21 (0.550)
125	19.	3320	289	GD	LX4FG125	1.21 (0.550)
220/230	57.7	10 200	890	MD	LX4FG220	1.21 (0.550)
250	76.	12 400	1140	UD	LX4FG250	1.21 (0.550)
440/460	223	39 700	4210	RD	LX4FG440	1.21 (0.550)

Specifications

Average consumption:
- inrush: 737 to 902 W.
- sealed: 4.13 to 5.07 W.
Operating time at Vc: closing = 30 to 40 ms; Opening = 30 to 50 ms

For Contactors LC1F265 and LC1F330

24	0.9	192	26.3	BD	LX4FH024	1.63 (0.740)
48	3.49	707	92.9	ED	LX4FH048	1.63 (0.740)
110	16.8	3180	424	FD	LX4FH110	1.63 (0.740)
125	20.8	3840	530	GD	LX4FH125	1.63 (0.740)
220/230	65.7	11 500	1590	MD	LX4FH220	1.63 (0.740)
250	84	13 900	1910	UD	LX4FH250	1.63 (0.740)
440/460	255	44 000	7570	RD	LX4FH440	1.63 (0.740)

Specifications

Average consumption:
- inrush: 655 to 803 W.
- sealed: 3.68 to 4.53 W.
Operating time at Vc: closing = 40 to 50 ms; Opening = 40 to 65 ms

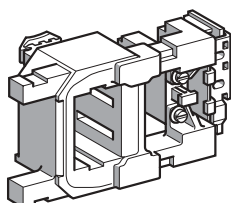

LX4FH●●●

For Contactor LC1F400

48	2.5	558	56	ED	LX4FJ048	2.14 (0.970)
110	12.7	2660	270	FD	LX4FJ110	2.14 (0.970)
125	15.8	3130	330	GD	LX4FJ125	2.14 (0.970)
220	47	8820	910	MD	LX4FJ220	2.14 (0.970)
250	61	10 500	1200	UD	LX4FJ250	2.14 (0.970)
440	236	33 750	4435	RD	LX4FJ440	2.14 (0.970)

Specifications

Average consumption:
- inrush: 920 to 1140 W.
- sealed: 4 to 7.5 W.
Operating time at Vc: closing = 50 to 60 ms; Opening = 45 to 60 ms

TeSys™ F-Line Contactors and Starters Selection - Coils

Contactors Type LC1F Coils for LC1F500 to F800, DC Supply

Low sealed consumption.

Control circuit voltage Vc	Average resistance at 20 °C (68 °F) ±10%		Inductance of Closed Circuit	Voltage Code	Catalog Number	Weight lb (kg)
	Inrush	Sealed				
V	Ω	Ω	H			

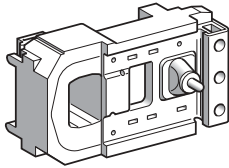

LX4FK...

For Contactor LC1F500

48	2.35	515	67	ED	LX4FK048	2.40 (1.080)
110	11.5	2450	280	FD	LX4FK110	2.40 (1.080)
125	15	2930	400	GD	LX4FK125	2.40 (1.080)
220	44	8150	1080	MD	LX4FK220	2.40 (1.080)
250	56	9650	1350	UD	LX4FK250	2.40 (1.080)
440	225	31 300	5270	RD	LX4FK440	2.40 (1.080)

Specifications

Average consumption:
 - inrush: 990 to 1220 W.
 - sealed: 4.5 to 8 W.
 Operating cycles/hour ($\theta \leq 55$ °C [131 °F]): 2400
 Operating time at Vc: closing = 50 to 60 ms; Opening = 45 to 60 ms

For Contactor LC1F630

48	1.7	353	40.5	ED	LX4FL048	3.21 (1.450)
110	8.1	1680	180	FD	LX4FL110	3.21 (1.450)
125	10	2110	230	GD	LX4FL125	3.21 (1.450)
220	31	5160	650	MD	LX4FL220	3.21 (1.450)
250	38	6080	815	UD	LX4FL250	3.21 (1.450)
440	152	23 120	2910	RD	LX4FL440	3.21 (1.450)

Specifications

Average consumption:
 - inrush: 1420 to 1920 W.
 - sealed: 6.5 to 72.5 W.
 Operating cycles/hour ($\theta \leq 55$ °C [131 °F]): 1200
 Operating time at Vc: closing = 60 to 70 ms; Opening = 40 to 50 ms

For contactor LC1F780

110	6.1 ▲	280 ▲	0.26	FD	LX4FX110 ■	6.61 (3.000)
125	7.7 ▲	410 ▲	0.33	GD	LX4FX125 ■	6.61 (3.000)
220	24.6 ▲	1100 ▲	1	MD	LX4FX220 ■	6.61 (3.000)
250	29.8 ▲	1330 ▲	1.25	UD	LX4FX250 ■	6.61 (3.000)
440	92 ▲	4180 ▲	3.5	RD	LX4FX440 ■	6.61 (3.000)

Specifications

Average consumption:
 - inrush: 1960 to 2420 W.
 - sealed: 42 to 52 W.
 Operating cycles/hour ($\theta \leq 55$ °C [131 °F]): 600
 Operating time at Vc: closing = 70 to 80 ms; Opening = 100 to 130 ms

For Contactor LC1F800

110/127	–	–	–	FW	LX4F8FW *	3.64 (1.650)
220/240	–	–	–	MW	LX4F8MW *	3.64 (1.650)
380/440	–	–	–	QW	LX4F8QW *	3.64 (1.650)

Specifications

Operating cycles/hour ($\theta \leq 55$ °C [131 °F]): 600
 Heat dissipation: 25 W
 Operating time at Vc: closing = 40 to 80 ms; Opening = 20 to 40 ms

- Catalog number includes a set of 2 identical coils, to be connected in series.
- ▲ Value of the 2 coils in series.
- * Coil circuit requires a separately mounted rectifier catalog number DR5 TE4U.

Contactors Type LC1F
Coils for LC1F115 to F330 (specific applications ■)
AC Supply, 40 to 400 Hz

Low sealed consumption.
High tolerance to inrush voltage drops.
Immune to micro-breaks (mains supply or contact chain).
Operate on networks with harmonic numbers ≤ 7.

Control circuit voltage Vc	Average resistance at 20 °C (68 °F) ±10%		Inductance of Closed Circuit	Voltage Code	Catalog Number	Weight lb (kg)
	Inrush	Sealed				
V	Ω	Ω	H			

For Contactors LC1F115 and LC1F150

48	3.03	80.2	0.3	E7	LX9FF048	0.95 (0.430)
110/115	14.8	579	2.08	F7	LX9FF110	0.95 (0.430)
127	19	746	2.65	G7	LX9FF127	0.95 (0.430)
220/230	59.4	2190	7.7	M7	LX9FF220	0.95 (0.430)
240	73.5	2750	9.68	U7	LX9FF240	0.95 (0.430)
380/400	173	6540	23	Q7	LX9FF380	0.95 (0.430)
415/440	218	8460	30	N7	LX9FF415	0.95 (0.430)
500	262	10 300	36	S7	LX9FF500	0.95 (0.430)

Specifications

Average consumption at 20 °C (68 °F):
- inrush: 690 to 855 VA.
- sealed: 6.6 to 8.1 VA.
Heat dissipation: 5.9 to 7.2 W.
Operating time at Vc: Closing = 35 ms; Opening = 130 ms.
Operating cycles/hour (θ ≤ 55 °C [131 °F]): < 2400.

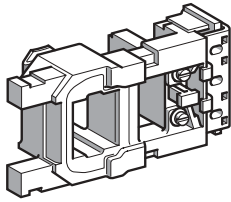

LX9FF...

For Contactors LC1F185 and LC1F225

48	2.2	60	0.23	E7	LX9FG048	1.21 (0.550)
110/115	10.4	411	1.46	F7	LX9FG110	1.21 (0.550)
127	13	520	1.85	G7	LX9FG127	1.21 (0.550)
220/230	42.1	1680	5.84	M7	LX9FG220	1.21 (0.550)
240	50.6	2060	7.22	U7	LX9FG240	1.21 (0.550)
380/400	128	4730	16.4	Q7	LX9FG380	1.21 (0.550)
415/440	157	5930	20.6	N7	LX9FG415	1.21 (0.550)
500	194	7550	26.3	S7	LX9FG500	1.21 (0.550)

Specifications

Average consumption at 20 °C (68 °F):
- inrush: 950 to 1180 VA.
- sealed: 8.9 to 10.9 VA.
Heat dissipation: 8 to 9.8 W.
Operating time at Vc: Closing = 35 ms; Opening = 130 ms.
Operating cycles/hour (θ ≤ 55 °C [131 °F]): < 2400.

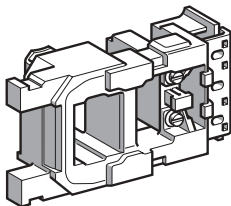

LX9FG...

For Contactors LC1F265 and LC1F330

48	2.96	72	▲	–	LX9FH0482	1.65 (0.750)
110/115	18.7	415	▲	–	LX9FH1102	1.65 (0.750)
120/127	22.9	156	▲	–	LX9FH1272	1.65 (0.750)
220/230	71.6	1621	▲	–	LX9FH2202	1.65 (0.750)
380/415	222	5075	▲	–	LX9FH3802	1.65 (0.750)
500	345	7990	▲	–	LX9FH5002	1.65 (0.750)

Specifications

Average consumption at 20 °C (68 °F):
- inrush: 560 to 660 VA.
- sealed: 8 to 10 VA.
Heat dissipation: 8.4 to 10.4 W.
Operating time at Vc: Closing = 45 ms; Opening = 25 ms.
Operating cycles/hour (θ ≤ 55 °C [131 °F]): < 3600.

- Application examples:
 - Hoisting (inching, high operating rate).
 - Normal Standby (distributed power supplies).
 These coils are specifically designed for use at high ambient temperature (mounting in MCCs, non ventilated enclosures, etc.).
- ▲ Please consult your Local Square D Field Sales Office.

TeSys™ F-Line Contactors and Starters

Selection - Coils

Contactors Type LC1F

Coils for LC1F400 to F630 (specific applications)

AC Supply, 40 to 400 Hz

Coils with short operating times (at Vc): Closing: 60 ms
Opening: 50 ms (c side); 20 ms (a side)

Coils for high operating rates (θ ≤ 70 °C [158 °F]): 3600 operating cycles/hour
1800 for LC1F630

Coils with low inrush consumption

Control circuit voltage Vc	Average resistance at 20 °C (68 °F) ±10%		Inductance of closed circuit	Rectifier Catalog Number ■	Coil	
	Inrush	Sealed			Catalog Number	Weight lb (kg)
V	Ω	Ω	H			

For Contactor LC1F400

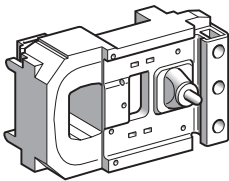

LX9FJ...

48	4.03	43	0.22	DR5TF4V	LX9FJ917	2.14 (0.970)
110	25.7	246	1.3	DR5TE4U	LX9FJ925	2.14 (0.970)
127	32.3	302	1.7	DR5TE4U	LX9FJ926	2.14 (0.970)
220/230	99.5	919	5	DR5TE4U	LX9FJ931	2.14 (0.970)
380/415	311	3011	15	DR5TE4S	LX9FJ936	2.14 (0.970)
440	386	3690	19	DR5TE4S	LX9FJ937	2.14 (0.970)
500	478	4380	23	DR5TE4S	LX9FJ938	2.14 (0.970)

Specifications

Average consumption:
- inrush: 500 VA.
- sealed: 23 VA.
Heat dissipation: 11.4 to 13.9 W.

For Contactor LC1F500

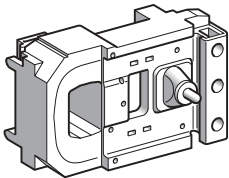

LX9FK...

48	3.73	30.7	0.18	DR5TF4V	LX9FK917	2.38 (1.080)
110	24	204	1.1	DR5TE4U	LX9FK925	2.38 (1.080)
127	29.8	250	1.4	DR5TE4U	LX9FK926	2.38 (1.080)
220/230	89.9	770	4	DR5TE4U	LX9FK931	2.38 (1.080)
380/415	274	2075	12	DR5TE4S	LX9FK936	2.38 (1.080)
440	361	3060	16	DR5TE4S	LX9FK937	2.38 (1.080)
500	448	3750	19	DR5TE4S	LX9FK938	2.38 (1.080)

Specifications

Average consumption:
- inrush: 550 VA.
- sealed: 31 VA.
Heat dissipation: 15 to 18.3 W.

For Contactor LC1F630

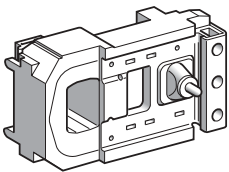

LX9FL...

48	2.81	20.8	0.17	DR5TF4V	LX9FL917	3.20 (1.450)
110	13.5	114	0.77	DR5TE4U	LX9FL924	3.20 (1.450)
127	20.8	167	1.2	DR5TE4U	LX9FL926	3.20 (1.450)
220	52	425	2.9	DR5TE4U	LX9FL930	3.20 (1.450)
220/240	64.5	518	3.6	DR5TE4U	LX9FL931	3.20 (1.450)
380/400	163	1360	8.8	DR5TE4S	LX9FL935	3.20 (1.450)
415/440	204	1670	11	DR5TE4S	LX9FL936	3.20 (1.450)
500	312	2510	17	DR5TE4S	LX9FL938	3.20 (1.450)

Specifications

Average consumption:
- inrush: 830 VA.
- sealed: 47 VA.
Heat dissipation: 22.8 to 27.8 W.

■ Rectifier to be ordered separately; weight of rectifier: 0.100 kg (0.22 lbs).

Contactors Type LC1F
Coils for LC1F400 to F630 (specific applications)
DC Supply

Coils with short operating times (at Vc): Closing: 60 ms
Opening: 20 ms

Coils with high operating rates
($\theta \leq 70^\circ\text{C}$ [158 °F]): 3600 operating cycles/hour
1800 for LC1F630

Coils with low inrush consumption

Control circuit voltage Vc	Average resistance at 20 °C (68 °F) $\pm 10\%$		Inductance of closed circuit	Resistor	Coil	
	Inrush	Sealed		Quantity and Catalog Number ■	Catalog Number	Weight lb (kg)
V	Ω	Ω	H			

For Contactor LC1F400

48	5.11	99	0.27	1 x DR2SC0047	LX9FJ918	2.14 (0.970)
110	32.3	632	1.7	1 x DR2SC0330	LX9FJ926	2.14 (0.970)
125	39.4	760	2	1 x DR2SC0390	LX9FJ927	2.14 (0.970)
220	123	2320	6.1	1 x DR2SC1200	LX9FJ932	2.14 (0.970)
440/460	478	9080	23	1 x DR2SC4700	LX9FJ938	2.14 (0.970)

Specifications

Average consumption:
- inrush: 430 W.
- sealed: 22 W.

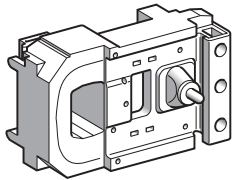

LX9FJ...

For Contactor LC1F500

48	4.67	76.7	0.22	1 x DR2SC0039	LX9FK918	2.38 (1.080)
110	29.8	470	1.4	1 x DR2SC0220	LX9FK926	2.38 (1.080)
125	37.4	637	1.7	1 x DR2SC0330	LX9FK927	2.38 (1.080)
220	115	1935	5.1	1 x DR2SC1000	LX9FK932	2.38 (1.080)
440/460	448	7050	19	1 x DR2SC3300	LX9FK938	2.38 (1.080)

Specifications

Average consumption:
- inrush: 470 W.
- sealed: 29 W.

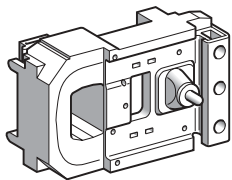

LX9FK...

For Contactor LC1F630

48	3.43	52.9	0.20	2 x DR2SC0047	LX9FL918	3.20 (1.450)
110	17.2	272	0.98	2 x DR2SC0270	LX9FL925	3.20 (1.450)
125	20.8	333	1.2	2 x DR2SC0330	LX9FL926	3.20 (1.450)
220	64.5	1018	3.6	2 x DR2SC1000	LX9FL931	3.20 (1.450)
440/460	260	4010	14	2 x DR2SC3900	LX9FL937	3.20 (1.450)

Specifications

Average consumption:
- inrush: 733 W.
- sealed: 48 W.

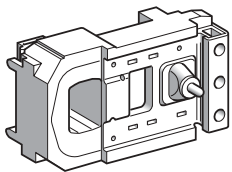

LX9FL...

■ Resistors to be ordered separately, weight of resistor: 0.030 kg (0.06 lbs).

TeSys™ F-Line Contactors and Starters

Dimensions and Mounting

Contactors Type LC1F

Dimensions

Dimensions shown in mm (mm x 0.0394 = inches)

LC1F115 to F330

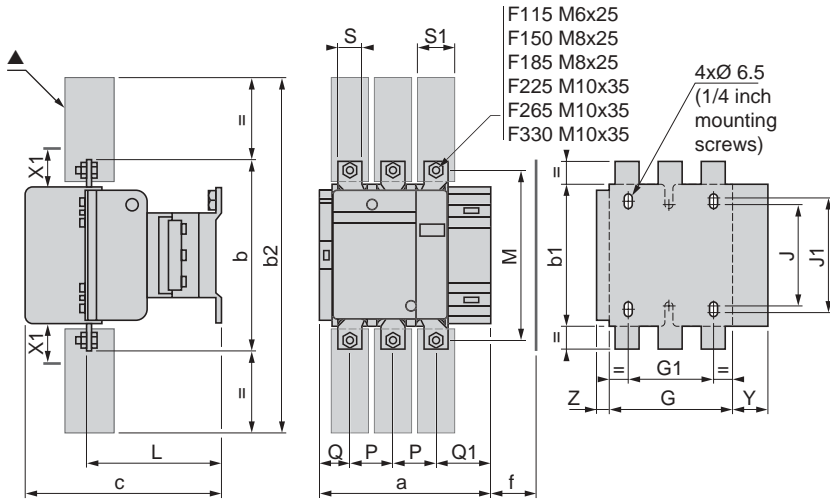

X1 (mm) = Minimum electrical clearance according to operating voltage and breaking capacity

	200 to 500 V	600 to 1000 V
LC1F115, LC1F150	10	15
LC1F185	10	15
LC1F225, LC1F265	10	15
LC1F330	10	15

- ▲ Power terminal protection shroud (see page 198).
- f Minimum distance required for coil removal.

LC1-		a	b	b1	b2	c	f	G	G1	J	J1	L	M	P	Q	Q1	S	S1	Y	Z
F115	3P	163.5	162	137	265	171	131	106	80	106	120	107	147	37	29.5	60	20	26	44	13.5
	4P	200.5	162	137	265	171	131	143	80	106	120	107	147	37	29.5	60	20	26	44	13.5
F150	3P	163.5	170	137	301	171	131	106	80	106	120	107	150	40	26	57.5	20	34	44	13.5
	4P	200.5	170	137	301	171	131	143	80	106	120	107	150	40	26	55.5	20	34	44	13.5
F185	3P	168.5	174	137	305	181	130	111	80	106	120	113.5	154	40	29	59.5	20	34	44	13.5
	4P	208.5	174	137	305	181	130	151	80	106	120	113.5	154	40	29	59.5	20	34	44	13.5
F225	3P	168.5	197	137	364	181	130	111	80	106	120	113.5	172	48	21	51.5	25	44.5	44	13.5
	4P	208.5	197	137	364	181	130	151	80	106	120	113.5	172	48	17	47.5	25	44.5	44	13.5
F265	3P	201.5	203	145	375	213	147	142	96	106	120	141	178	48	39	66.5	25	44.5	38	21.5
	4P	244.5	203	145	375	213	147	190	96	106	120	141	178	48	34	66.5	25	44.5	38	21.5
F330	3P	213	206	145	375	219	147	154.5	96	106	120	145	181	48	43	74	25	44.5	38	20.5
	4P	261	206	145	375	219	147	202.5	96	106	120	145	181	48	43	74	25	44.5	38	20.5

f = minimum distance required for coil removal

LC1F400 and F500

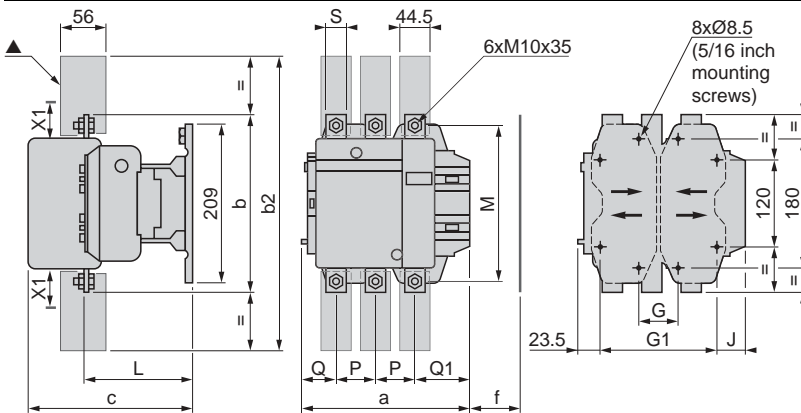

Dimensions shown in mm
mm x 0.0394 = inches

X1 (mm) = Minimum electrical clearance according to operating voltage and breaking capacity

	200 to 500 V	600 to 1000 V
LC1F400	15	20
LC1F500	15	20

- ▲ Power terminal protection shroud (see page 198).
- f Minimum distance required for coil removal.

LC1-		a	b	b2	c	f	G*	G min	G max	G1 ■	G1 min	G1 max	J	L	M	P	Q	Q1	S
F400	2P	213	206	375	219	119	80	66	102	170	156	192	19.5	145	181	48	69	96	25
	3P	213	206	375	219	119	80	66	102	170	156	192	19.5	145	181	48	43	74	25
	4P	261	206	375	219	119	80	66	150	170	156	240	67.5	145	181	48	43	74	25
F500	2P	233	238	400	232	141	80	66	120	170	156	210	39.5	146	208	55	76	102	30
	3P	233	238	400	232	141	80	66	120	170	156	210	39.5	146	208	55	46	77	30
	4P	288	238	400	232	141	140	66	175	230	156	265	34.5	146	208	55	46	77	30

■ Supplied.

TeSys™ F-Line Contactors and Starters Dimensions and Mounting

Contactors Type LC1F Dimensions

Dimensions shown in mm (mm x 0.0394 = inches)

LC1F630 and F800

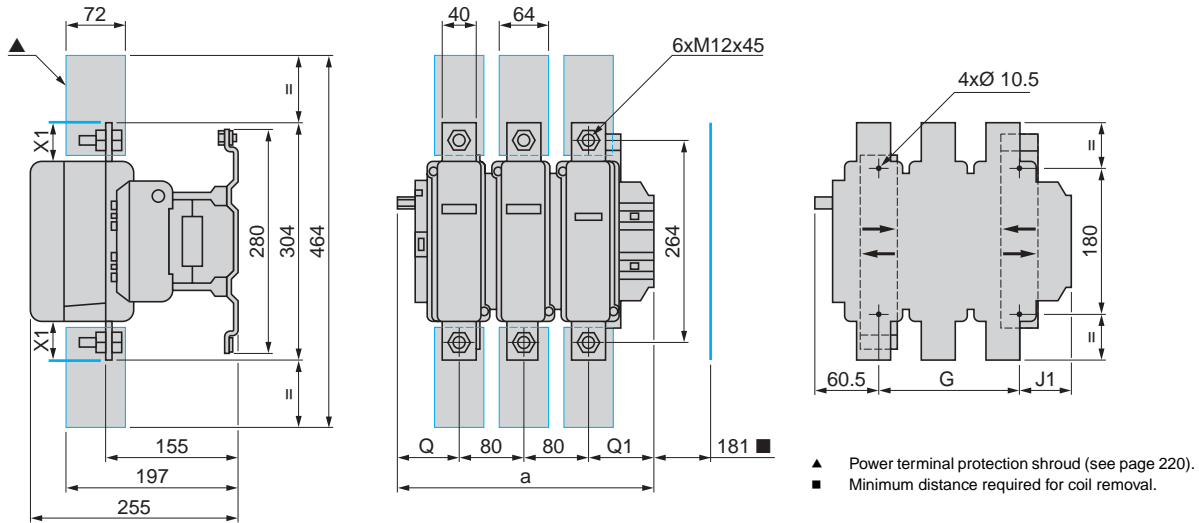

		a	G supplied	G min	G max	J1	Q	Q1	X1 (mm) = Minimum electrical clearance according to operating voltage and breaking capacity				
LC1F630	2P	309	180	100	195	68.5	102	127	Voltage	200 to 500 V	690 to 1000 V	200 to 690 V	1000 V
LC1F630	3P	309	180	100	195	68.5	60	89	LC1F630	20	30	–	–
LC1F800	3P	309	180	100	195	68.5	60	89	LC1F800	–	–	10	20
LC1F630	4P	389	240	150	275	68.5	60	89					

LC1F780

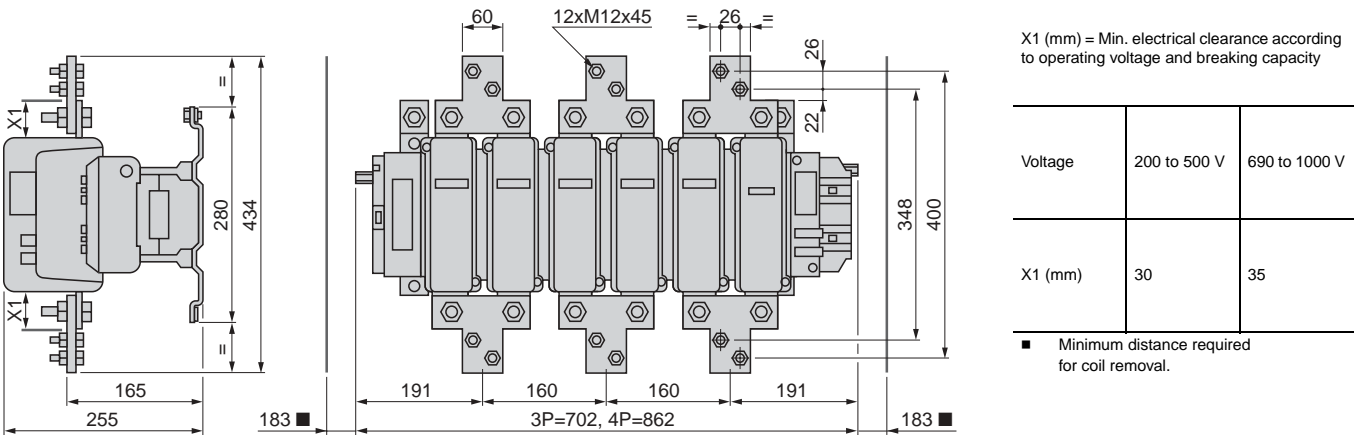

Mounting holes of LC1F7804

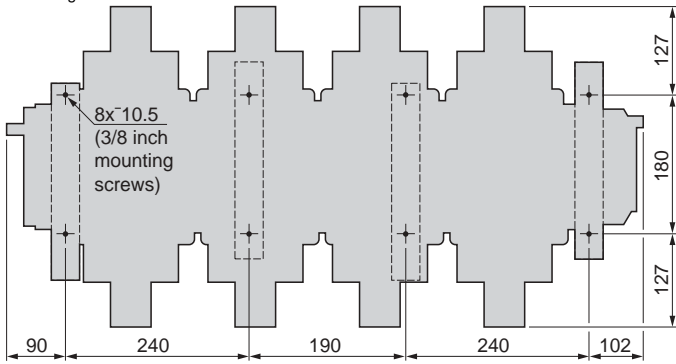

Mounting holes of LC1F780

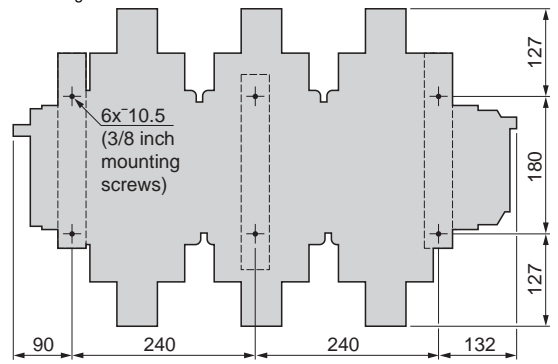

TeSys™ F-Line Contactors and Starters

Dimensions and Mounting

Reversing contactors and changeover contactor pairs LC2F

Horizontally mounted

Dimensions shown in mm (mm x 0.0394 = inches)

For customer assembly, see pages 190 to 193.

2 x LC1F115 to LC1F330

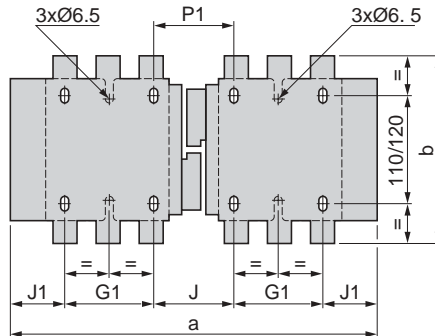
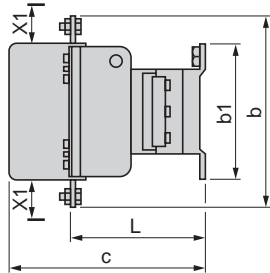

2 x LC1F400, F500, F630, F800

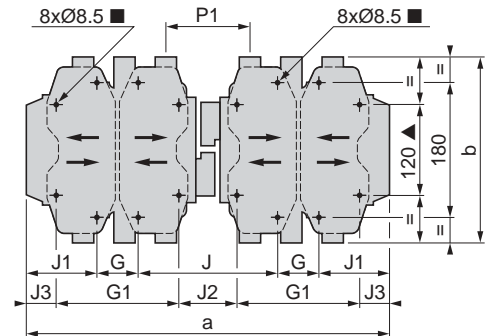

X1 (mm) = Minimum electrical clearance according to operational voltage and breaking capacity

	200 to 500 V	660 to 1000 V	200 to 690 V	1000 V
LC1F115, LC1F150	10	15	-	-
LC1F185	10	15	-	-
LC1F225, LC1F265	10	15	-	-
LC1F330	10	15	-	-
LC1F400	15	20	-	-
LC1F500	15	20	-	-
LC1F630	20	30	-	-
LC1F800	-	-	10	20

2 x		a	b	b1	c	G	G1	J	J1	J2	J3	L	P1
LC1F115	3P	345	162	137	171	-	80	71	57	-	-	107	77
	4P	419	162	137	171	-	80	108	75.5	-	-	107	77
LC1F150	3P	345	170	137	171	-	80	71	57	-	-	107	71
	4P	422	170	137	171	-	80	111	75.5	-	-	107	71
LC1F185	3P	357	174	137	181	-	80	78	59.5	-	-	113.5	78
	4P	437	174	137	181	-	80	118	79.5	-	-	113.5	78
LC1F225	3P	357	197	137	181	-	80	78	59.5	-	-	113.5	62
	4P	437	197	137	181	-	80	118	79.5	-	-	113.5	54
LC1F265	3P	425	203	145	213	-	96	109	61.5	-	-	141	100
	4P	521	203	145	213	-	96	157	85.5	-	-	141	100
LC1F330	3P	447	206	145	219	-	96	124	65.5	-	-	145	107
	4P	543	206	145	219	-	96	172	89.5	-	-	145	107
LC1F400	3P	446	206	209	219	80	170	157	64.5	67	19.5	145	107
	4P	542	206	209	219	80	170	157	112.5	67	67.5	145	107
LC1F500	3P	485	238	209	232	80	170	156	84.5	66	39.5	146	112
	4P	595	238	209	232	140	230	156	79.5	66	34.5	146	112
LC1F630	3P	636	304	280	255	180	-	139	68.5	-	-	155	137
	4P	796	304	280	255	240	-	139	88.5	-	-	155	137
LC1F800	3P	636	304	280	255	180	-	139	68.5	-	-	155	137

■ Except LC1F630 and LC1F800: 4 x Ø 10.5.

▲ Except LC1F630 and LC1F800

TeSys™ F-Line Contactors and Starters Dimensions and Mounting

Reversing contactors and changeover contactor pairs LC2F Vertically mounted

Dimensions shown in mm (mm x 0.0394 = inches)

For customer assembly, with mechanical interlock (MI) LA9F***.

2 x LC1 identical or different ratings (LC1F115 to LC1F225 and LC1F630 and LC1F800). See pages 190 to 193.

Assembly A

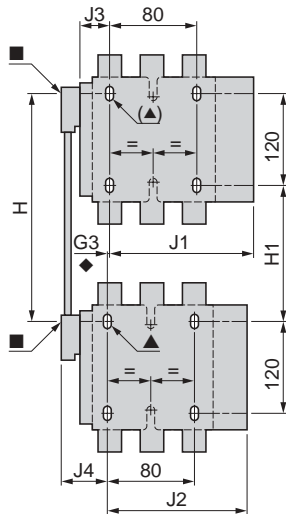

- Mechanical interlock shaft.
- ▲ 4 x Ø6.5 for LC1F115 to LC1F225
- ◆ For assembly of contactors of different ratings only.
- ▼ Mechanical interlock guide bracket.
- * 4 x Ø8.5 for LC1F400, LC1F500 or 4 x Ø10.5 for LC1F630, LC1F800.
- 4 x Ø6.5 for LC1F265.

Assembly B

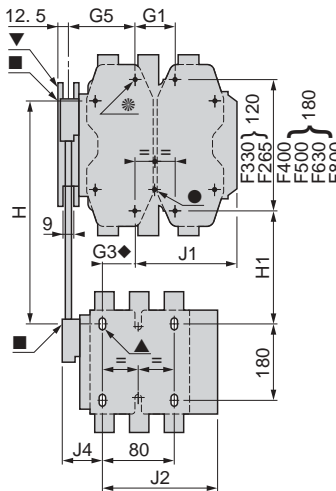

Assembly C

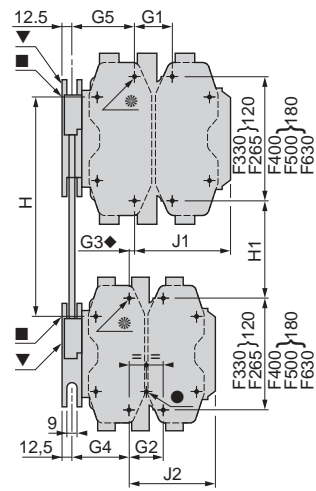

Assembly A (F800 in 3-pole only)

MI	G3		H		H1		J1	
Catalog #	3P	4P	min	max	min	max	3P	4P
LA9FF4F	0	0	200	310	80	190	137	155.5
LA9FG4F	3	4	210	300	90	180	139.5	159.5
LA9FG4G	0	0	220	310	100	190	139.5	159.5

	J2		J3		J4	
	3P	4P	3P	4P	3P	4P
LA9FF4F	137	155.5	48.5	67	48.5	67
LA9FG4F	137	155.5	53	73	54	69
LA9FG4G	139.5	159.5	53	73	53	73

For customer assembly, mounting recommended on AM1EC*** uprights, 2 x LC1F780

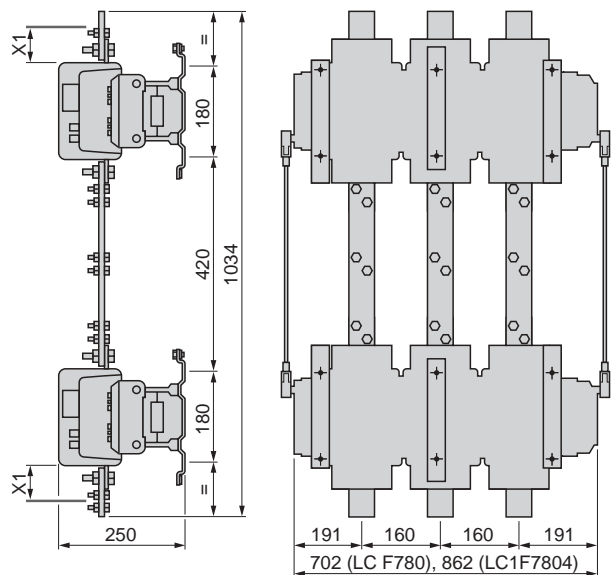

X1 and mounting holes, see page 211.

Assembly B (F800 in 3-pole only)

MI	G1		G3		G5		H	
Catalog #	3P	4P	3P	4P	3P	4P	min	max
LA9FH4F	96	96	21	27	60	83	240	380
LA9FJ4F	80	80	45	26	83	83	250	380
LA9FK4F	80	140	45	26	83	83	270	380
LA9FL4F	180	240	35	17	74	74	310	380
LA9FH4G	96	96	19	23	60	83	250	380
LA9FJ4G	80	80	42	22	83	83	250	380
LA9FK4G	80	140	42	22	83	83	270	380
LA9FL4G	180	240	33	13	74	74	310	380

	H1		J1		J2		J4	
	min	max	3P	4P	3P	4P	3P	4P
LA9FH4F	110	250	157.5	181.5	137	155.5	48.5	67
LA9FJ4F	80	210	144.5	192.5	137	155.5	48.5	67
LA9FK4F	100	210	164.5	219.5	137	155.5	48.5	67
LA9FL4F	140	210	248.5	328.5	137	155.5	48.5	67
LA9FH4G	120	250	157.5	181.5	139.5	159.5	53	73
LA9FJ4G	90	220	144.5	192.5	139.5	159.5	53	73
LA9FK4G	110	220	164.5	219.5	139.5	159.5	53	73
LA9FL4G	150	220	248.5	328.5	139.5	159.5	53	73

Assembly C (F800 in 3-pole only)

MI	G1		G2		G3		G4		G5	
Catalog #	3P	4P	3P	4P	3P	4P	3P	4P	3P	4P
LA9FH4H	96	96	96	96	0	0	60	83	60	83
LA9FJ4H	80	80	96	96	23	0	60	83	83	83
LA9FK4H	80	140	96	96	23	0	60	83	83	83
LA9FL4H	180	240	96	96	14	9▼	60	83	74	74
LA9FJ4J	80	80	80	80	0	0	83	83	83	83
LA9FK4J	80	140	80	80	0	0	83	83	83	83
LA9FL4J	180	240	80	80	9▼	9▼	83	83	74	74
LA9FK4K	80	140	80	140	0	0	83	83	83	83
LA9FL4K	180	240	80	140	9▼	9▼	83	83	74	74
LA9FL4L	180	240	180	240	0	0	74	74	74	74

	H		H1		J1		J2	
	min	max	min	max	3P	4P	3P	4P
LA9FH4H	250	380	130	260	157.5	181.5	157.5	181.5
LA9FJ4H	260	380	110	230	144.5	192.5	157.5	181.5
LA9FK4H	280	380	130	230	164.5	219.5	157.5	181.5
LA9FL4H	330	380	170	220	248.5	328.5	157.5	181.5
LA9FJ4J	260	380	60	200	144.5	192.5	144.5	192.5
LA9FK4J	280	380	100	200	164.5	219.5	144.5	192.5
LA9FL4J	325	380	140	195	248.5	329.5	144.5	192.5
LA9FK4K	300	380	120	200	164.5	329.5	164.5	219.5
LA9FL4K	345	380	160	195	248.5	328.5	164.5	219.5
LA9FL4L	380	380	200	200	248.5	328.5	248.5	328.5

▼ In this case, G4 is greater than G5

TeSys™ F-Line Contactors and Starters

Dimensions and Mounting

Contactors Type LC1F Mounting

Dimensions shown in mm (mm x 0.0394 = inches)

LC1F115 to LC1F330

On panel

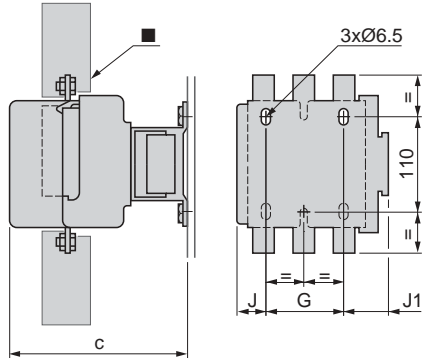

On pre-slotted mounting plate **AM1PA, AM1PB, AM1PC**

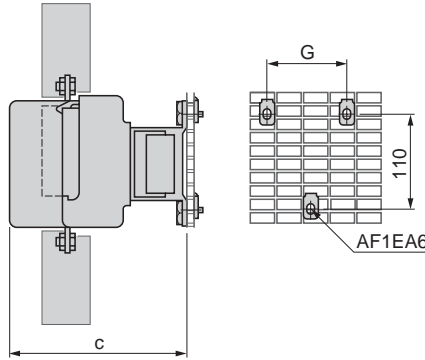

On rails **DZ5MB** on 120 mm center

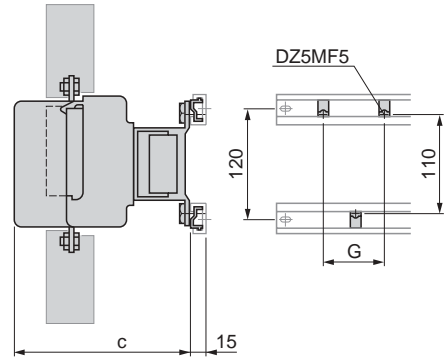

		LC1F115, LC1F150	LC1F185, LC1F225	LC1 F265	LC1 F330
c ▲	3P	171	181	213	219
	4P	171	181	213	219
G	3P	80	80	96	96
	4P	80	80	96	96
J	3P	26.5	29	44.5	44.5
	4P	45	49	68.5	68.5
J1	3P	57	59.5	61.5	61.5
	4P	75.5	79.5	85.5	85.5

		LC1F115, LC1F150	LC1F185, LC1F225	LC1 F265	LC1 F330
c ▲	3P	171	181	213	219
	4P	171	181	213	219
G	3P	80	80	96	96
	4P	80	80	96	96

		LC1F115, LC1F150	LC1F185, LC1F225	LC1 F265	LC1 F330
c ▲	3P	171	181	213	219
	4P	171	181	213	219
G	3P	80	80	96	96
	4P	80	80	96	96

- Power terminal protection shroud (see page 198)
- ▲ See X1, minimum electrical clearance on pages 210 and 211.

LC1F

On 2 notched rails **AM1-EC**...

LC1F115 to LC1F330

LC1F400 to LC1F800

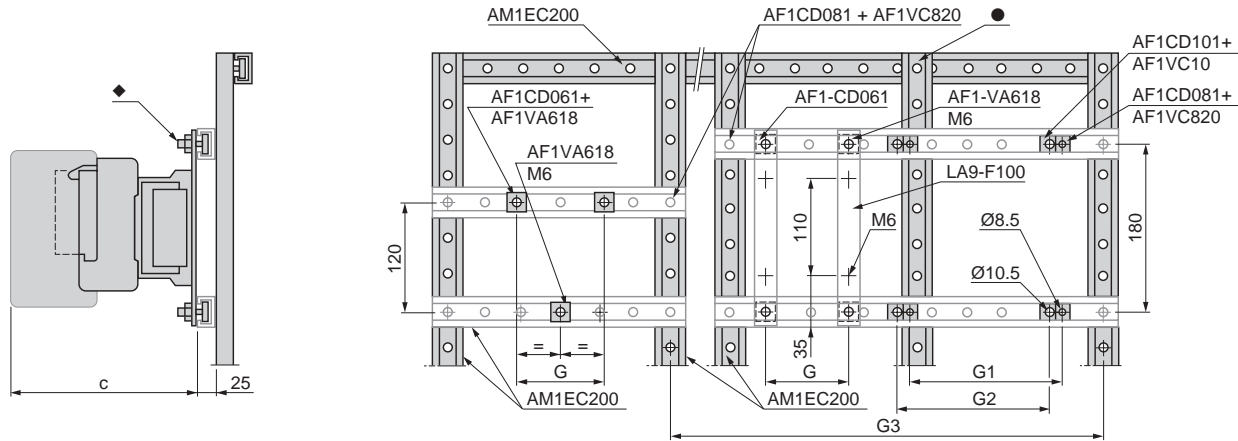

		LC1F115, LC1F150	LC1F185, LC1F225	LC1F265	LC1F330	LC1F400	LC1F500	LC1F630	LC1F780	LC1F800
c	3P	165 ▼	176	207	213	219	232	255	255	255
	4P	165 ▼	176	207	213	219	232	255	255	—
G (M6)	3P	80	80	96	96	—	—	—	—	—
	4P	80	80	96	96	—	—	—	—	—
G1 (Ø 8.5)	3P	—	—	—	—	80	80	—	—	—
	4P	—	—	—	—	80	140	—	—	—
G2 (Ø 10.5)	3P	—	—	—	—	—	—	180	See page 211	—
	4P	—	—	—	—	—	—	240	1/129	—

- ◆ **AF1CD**... and **AF1VA**...
- This **AM1EC200** upright is required when G2 or G3 is greater than 700 mm.
- ▼ Add 6 mm with timer block on **LC1F**.

TeSys™ F-Line Contactors and Starters Dimensions and Mounting

Contactors Type LC1F Cabling Accessories

Dimensions shown in mm (mm x 0.0394 = inches)

Paralleling links (set of 4)
LA9FF, FG, FH602

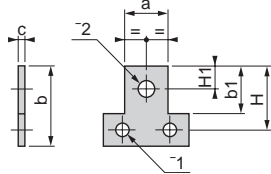

LA9FK, LA9FL602

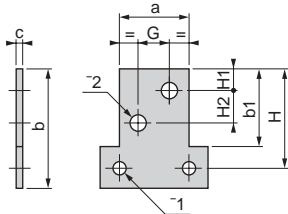

	LA9FF602	LA9FG602	LA9FH602	LA9FK602	LA9FL602
a	25	30	40	50	60
b	45	55	60	85	100
b1	30	35	40	55	65
c	4	5	8	10	10
G	-	-	-	22	26
H	37.5	45	52.5	70	85
H1	12.5	15	15	14	17
H2	-	-	-	22	26
Ø1	6.5	9	11	11	13
Ø2	11	11	13	11	14

Bars for 3-pole star connection LA9F•601

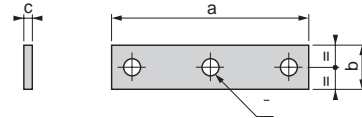

	LA9FF601	LA9FG601	LA9FH601	LA9FK601	LA9FL601
a	89	100	121	140	200
b	15	20	20	30	40
c	3	3	5	5	8
Ø	6.5 x 8.5	8.5 x 10.5	10.5 x 13	11	13

Brackets LA9F•981 (set of 3) for back connection

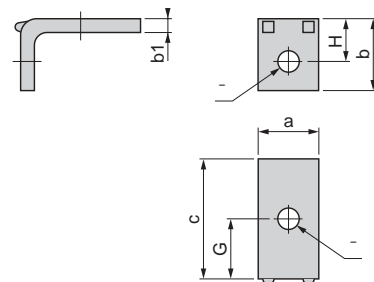

	LA9FF981	LA9FG981	LA9FJ981	LA9FK981	LA9FL981
a	15	20	25	30	40
b	18	23	29	35	48
b1	3	3	4	5	8
c	42	45	55	52	86
G	24	26	32.5	26	45
H	10.5	13	16.5	20	28
Ø	6.5	9	11	11	13

Brackets LA9F•979 (set of 3) for side connection

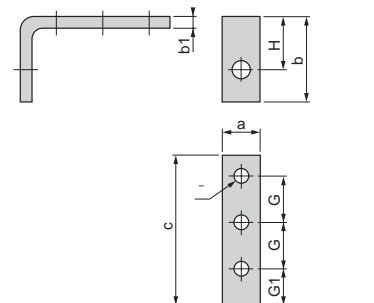

	LA9FF979	LA9FG979	LA9FJ979	LA9FK979	LA9FL979
a	15	20	25	30	40
b	54	58	63.5	68	117
b1	5	5	6	6	10
c	80	92	120	120	130
G	24	28	37	37	37.5
G1	20	22	29	29	35
H	36	39	41	42	76
Ø	6.5	9	11	11	13

Wide range brackets LA9F•980 (set of 3)

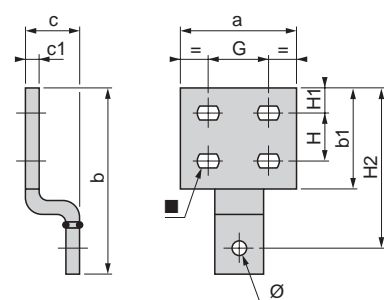

	LA9FF980	LA9FG980	LA9FJ980	LA9FK980	LA9FL980
a	35	40	50	60	100
b	70.5	82.5	98.5	114	154
b1	40	45	55	65	85
c	29	29	33	33	43
c1	3	3	5	5	10
G	18	20	25	29	53
H	18	20	22	26	40
H1	10	12	14	17	20
H2	60.5	72.5	84.5	97	132
Ø	6.5	9	11	11	13
■	Ø7 x 10	Ø9 x 12	Ø11 x 14	Ø12.5 x 15	Ø12.5 x 15

TeSys™ F-Line Contactors and Starters Schematics

Contactors Type LC1F Schematics

2-, 3-, and 4-pole contactors

LC1F115 to LC1F630 (coil LX1F AC)

LC1F115 to LC1F630 (coil LX4F DC)
LC1F115 to LC1F265 (coil LX9F AC)
LC1F800 (coil LX8F AC/DC)

LC1F780, 3- and 4-poles AC or DC

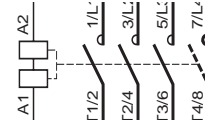
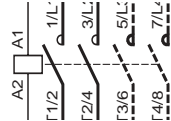
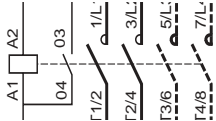

Front-mounting contact blocks

Instantaneous auxiliary contacts

1 N.O. LA1DN10 ■

1 N.C. LA1DN01 ■

1 N.O. + 1 N.C. LA1DN11

2 N.O. LA1DN20

2 N.C. LA1DN02

2 N.O. + 2 N.C. LA1DN22

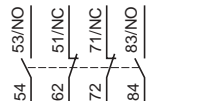
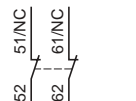
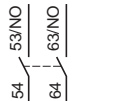
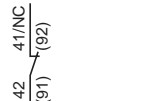
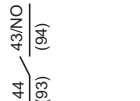

1 N.O. + 3 N.C. LA1DN13

4 N.O. LA1DN40

4 N.C. LA1DN04

2 N.O. + 2 N.C. including 1 N.O. + 1 N.C. make before break LA1DC22

3 N.O. + 1 N.C. LA1DN31

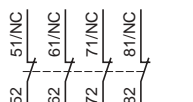
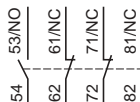

■ Items in brackets are for blocks mounted on right-hand side of contactor.

Front-mounting contact blocks

Instantaneous auxiliary contacts with terminal referencing conforming to standard EN 50012 (References: pages 218 and 219)

1 N.O. + 1 N.C. LA1DN11P

1 N.O. + 1 N.C. LA1DN11G

1 N.O. + 1 N.C. LA1DN11M

2 N.O. + 2 N.C. LA1DN22P

2 N.O. + 2 N.C. LA1DN22G

2 N.O. + 2 N.C. LA1DN22M

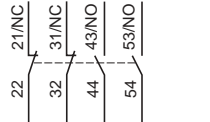
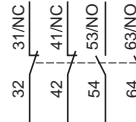
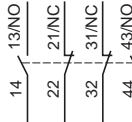
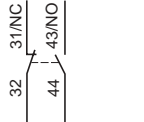
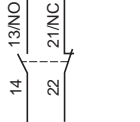

Front-mounting contact blocks

Dust and damp protected instantaneous auxiliary contacts

2 N.O. (24-50 V) LA1DX20

2 N.O. (5-24 V) LA1DY20

2 N.O. protected (24-50 V) + 2 N.O. standard LA1DZ40

2 N.O. protected (24-50 V) + 1 N.O. + 1 N.C. standard LA1DZ31

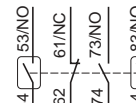
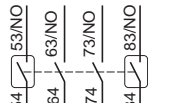
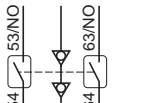

Front-mounting contact blocks

Time delay auxiliary contacts

OnDelay 1 N.O. + 1 N.C. LA2DT•

Off Delay 1 N.O. + 1 N.C. LA3DR•

On Delay N.C. contact with N.O. break before make contact LA2DS•

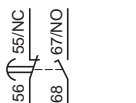
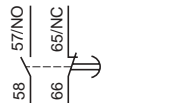
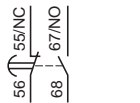

Interface module

LA4FWB

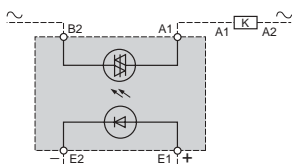

Standard AC coils

LX1FF, FG, FJ to LX1FL
LX1FH0422 to LX1FH3802

LX1FH0202 to LX1FH0362
LX1FH4402 to LX1FH10002
LX8F8•W (AC / DC)

LX1FX

Rectifier supplied and attached to the contactor

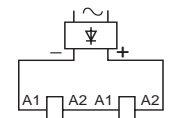
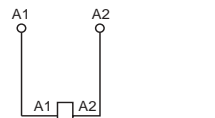
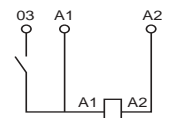

Special AC coils

LX9FF, LX9FG

LX9FH•••2

LX9FJ, LX9FK, LX9FL

DC coils

LX4FF, FG, FH, FJ, FK, FL, FX ■

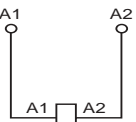
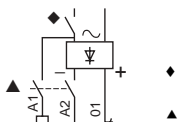
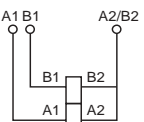
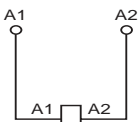

- ◆ Breaking on AC side
Drop-out time 50 ms
- ▲ Breaking on DC side
Drop-out time 20 ms

■ 2 coils in series

Reversing Contactors and Changeover Contactors

Reversing contactors for motor control, horizontally mounted
2 x LC1F

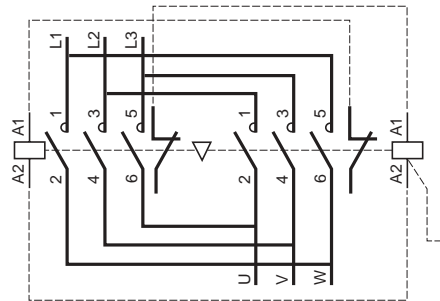

Dashed lines indicate suggested customer wiring to electrically interlock coils using quantity of 2 LA1DN•1 auxiliary contact blocks.

Reversing contactors for motor control, vertically mounted
2 x LC1F

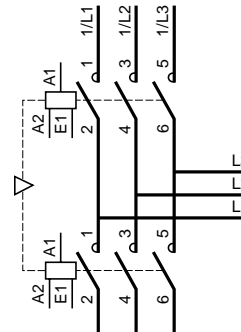

Changeover contactor pairs for distribution, horizontally mounted
2 x LC1F

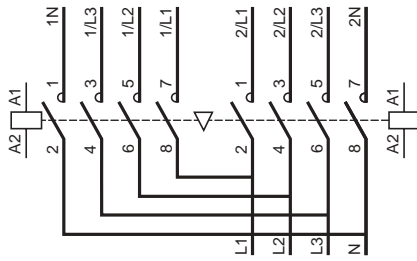

Changeover contactor pairs for distribution, vertically mounted
2 x LC1F

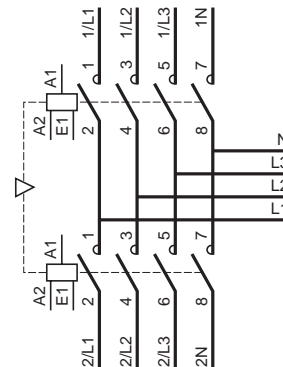

Electrical interlocking of reversers with:
mechanical interlock LA9F•••
without integrated electrical contacts

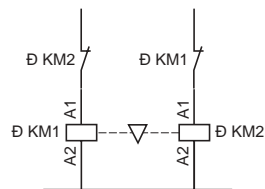

Note: Must use quantity of 2 LA1DN•1 auxiliary contact blocks to provide electrical interlocking of coils. See diagram with dashed lines above.

TeSys™ F-Line Contactors and Starters

LR9F Solid State Overload Relays - Characteristics

Introduction

The LR9F solid state overload relay provides the accurate, repeatable protection of a solid state device, while still maintaining the ease of installation of a traditional overload relay.

The LR9F provides protection against:

- Motor Overload
- Failure or Phase unbalance of 30% or greater
- Prolonged starting times
- Locked rotor conditions

The LR9F overload relays have 8 current ranges, spanning 30 amps up to 630 amps. They are available in Class 10 trip or Class 20 trip models. The device is manually reset via a clearly labeled button on the front face. A separate attachment is available for remote reset or test tripping of the relay. All units incorporate both a normally open and normally closed contact for control circuit wiring.

The LR9F is designed to directly mount on the load side of a LC1F contactor, minimizing space and wiring time. Lugs for the LR9F are ordered separately (see page 220 for selection). For LR9F relays up to 185 amps, an interposing touch-safe terminal block may be ordered in place of lugs, making power wiring even easier.

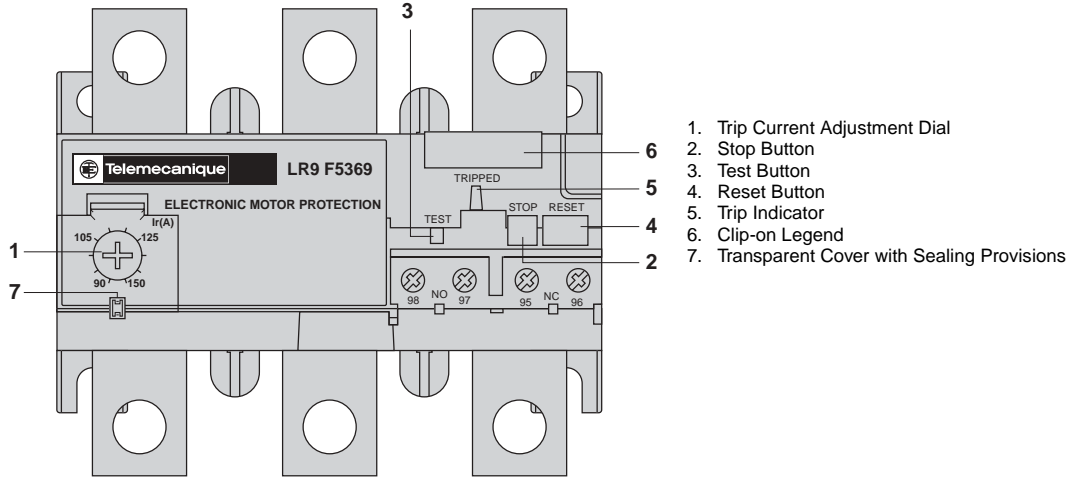

LR9F Tripping Curve

Average operating times depending on multiples of the current setting

Class 10

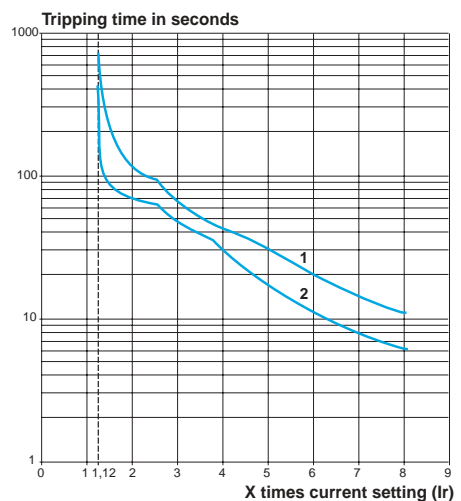
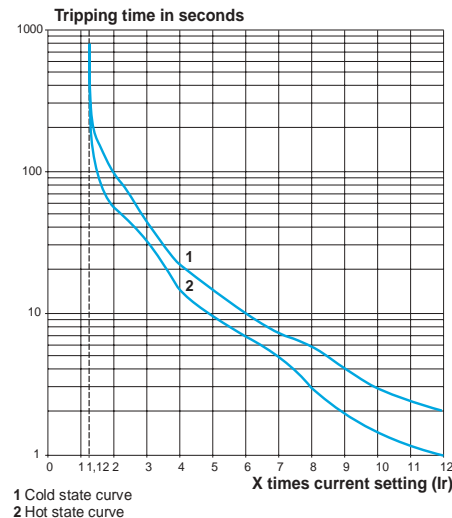

Class 20



TeSys™ F-Line Contactors and Starters

LR9F Solid State Overload Relays - Characteristics

Environment

Conforming to standards	 Meets the essential requirements of LV & EMC directives.		IEC 60947-1, 60947-4-1, 255-8, and VDE 0660EN 60947-1. 60947-4-1
Approvals	 EI64353 NKCR  LR43364 3211 03		UL508; CSA 22-2, No.14; PTB Pending
Degree of protection	Conforming to VDE 0106		IP 20 - Protection against direct finger contact with LA9F103 insulated terminal blocks or LA9F7/LA7F7 shrouds
Protective treatment	Standard version		"TH"
Ambient air temperature around the device (conforming to IEC 60255-8)	Storage		-40 to + 85 °C (-40 to +185 °F)
	Normal operation		-20 to + 55 °C (-4 to +131 °F)
Maximum operating altitude	Without derating	m	2000
Operating positions without derating	In relation to normal vertical mounting plane		All positions
Shock resistance	Permissible acceleration conforming to IEC 60068-2-7		13 g - 11 ms
Vibration resistance	Permissible acceleration conforming to IEC 60068-2-6		2 g
Dielectric strength at 50 Hz	Conforming to IEC 60255-5	kV	6
Impulse withstand voltage	Conforming to IEC 60801-5	kV	4
Resistance to electrostatic discharges	Conforming to IEC 60801-2	kV	8 (in air) 6 (in indirect mode)
Resistance to radio-frequency conducted disturbances	Conforming to IEC 60801-3 and NF C 46-022	V/m	10
Resistance to fast transient currents	Conforming to IEC 60801-4	kV	2
Electromagnetic compatibility	EN50081-1 & 2, EN50082-2		Meets test requirements

Power Circuit Characteristics

Relay Type		LR9F	F5•57	F5•63 F5•67 F5•69	F5•71	F7•75	F7•79	F7•81
Rated insulation voltage (Vi)	Conforming to IEC 60947-4	V	1000					
Rated operational voltage (Ve)	Conforming to VDE 0110 gr C	V	1000					
Rated impulse withstand voltage (Vimp)	Conforming to IEC 60947-1	kV	8					
Rated operational current (Ie)		A	30 to 630					
Frequency limits	Of the operating current	Hz	50/60					
Power circuit connections	Width of terminal lug	mm (in)	20 (0.78)	25 (0.98)	25 (0.98)	30 (1.18)	40 (1.57)	40 (1.57)
	Clamping screw		M6	M8	M10	M10	M10	M12
	Tightening torque	lb • in N • m	90 10	160 18	310 35	310 35	310 35	515 58

Auxiliary contact characteristics

Rated thermal current		A	5					
Control circuit connections	Stranded cable without cable end	1 conductor	mm ²	Minimum		Maximum		
				1 x 0.75	1 x 4.0			
		2 conductors	mm ²	2 x 1.0	2 x 2.5			
				1 conductor	AWG	1 x 18	2 x 12	
	2 conductors	AWG	2 x 16	2 x 14				
			Stranded cable with cable end	1 conductor	mm ²	1 x 0.75	1 x 2.5	
	2 conductors	2 x 1.0				2 x 1.5		
	Solid cable	1 conductor	mm ²	1 x 0.75	1 x 2.5			
				2 conductors	2 x 1.0	2 x 1.0		
	Tightening torque	lb • in	11					
N • m		1.2						
Maximum sealed consumption of coils on controlled contactors	AC control	V	24	48	110	220	380	600
		VA	100	200	400	600	600	600
	DC control	V	24	48	110	220	440	-
		W	100	100	50	45	25	-

TeSys™ F-Line Contactors and Starters

LR9F Solid State Overload Relays - Selection



LR9F53...

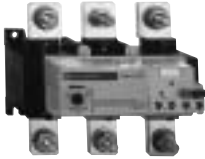

LR9F73...

Three-Phase Overload Relays ■

Current Setting Range Amps	For Direct Mounting To Contactor LC1.../CR1F...	Class 10 Trip ▲ Catalog Number	Class 20 Trip ▲ Catalog Number
30 to 50	F115 to F185	LR9F5357	LR9F5557
48 to 80	F115 to F185	LR9F5363	LR9F5563
60 to 100	F115 to F185	LR9F5367	LR9F5567
90 to 150	F115 to F185	LR9F5369	LR9F5569
132 to 220	F185 ♦, F265	LR9F5371	LR9F5571
200 to 330	F265 to F500	LR9F7375	LR9F7575
300 to 500	F265 to F500	LR9F7379	LR9F7579
380 to 630	F400 to F630	LR9F7381	LR9F7581

- When mounting overload relays **LR9F5•57** to **LR9F5•71** directly beneath the contactor it is recommended that the relays be additionally supported by a mounting plate. For sizes **LR9F5•75** to **LR9F7•81** use of the supporting mounting plate is mandatory. See page 221 for selection table.
- ▲ IEC standard 60947-4 specifies the following trip times when the overload relay senses 7.2 times the setting current:
Class 10: between 4 and 10 seconds
Class 20: between 6 and 20 seconds
- ♦ Interconnection kit **LA7F407** is required to mount an **LR9F•71** to an **LC1F185**.

Lug Kits

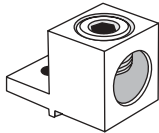

DZ2F..

Lugs can be ordered either individually or in sets of six. In some cases the LR9F overload relay mounted directly on the bottom of LC1F contactor will require a different size lug than the contactor itself. Refer to the table below to select the appropriate size lug for your choice of contactor and overload. If all 6 lugs (three for line side of contactor, three for load side of overload relay) are the same, Square D offers a pre-packaged set of six lugs. If the two sizes are different, order 3 of each size lug. Mounting hardware (screws, washers, nuts) are provided with the contactors and overload relays, not with the lugs.

Overload Relay	Directly mounted to contactor LC1....	Cable size AWG range		Lug Catalog Number	
		Line side (of contactor)	Load side (of overload)	Line side (of contactor)	Load side (of overload)
LR9F5•57 to F5•69	F115	14 to 2/0	6 to 3/0	3 ea. DZ2FF1	3 ea. DZ2FG1
LR9F5•57 to F5•71	F150 or F185	6 to 3/0		1 ea. DZ2FG6	
LR9F5•71	F265	6 to 300 MCM		1 ea. DZ2FH6	
LR9F7•75 to F7•79	F265 or F330	6 to 300 MCM	4 to 500 MCM	3 ea. DZ2FH1	★
LR9F7•75 to F7•81	F400	4 to 500 MCM	4 to 500 MCM	3 ea. DZ2FJ1	★
LR9F7•75 to F7•81	F500	2 x 2 to 600 MCM	4 to 500 MCM	3 ea. DZ2FK1	★
LR9F7•81	F630	3 x 2 to 600 MCM	4 to 500 MCM	DZ2FL1 DZ2FL2 DZ2FL3	★

★ Customer to obtain from local supplier.

Insulated Terminal Blocks

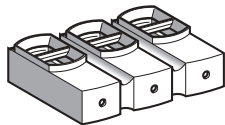

LR9F73...

For contactors LC1F115, LC1F150, and LC1F185, an available touch-safe terminal block may be used in place of lugs for power connections

Insulated terminal block	Cable size AWG range	Suitable for contactor LC1.../CR1....	Suitable for overload relay LR9.....
LA9F103	#6 to 300 MCM	F115, F150, F185	5•57, F5•63, F5•67, F5•69

TeSys™ F-Line Contactors and Starters

LR9F Solid State Overload Relays - Accessories

Mounting Plate for Overload Relay

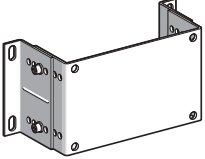
 <p>LA7F90•</p>	Provides overload relay support when mounted directly to F-Line Contactor For use with relays:	Catalog Number
	LR9F5•57, F5•63, F5•67, F5•69 and F5•71	LA7F901
	LR9F7•75, F7•79 and F7•81	LA7F902

Power Terminal Protection Shrouds, Single-Pole

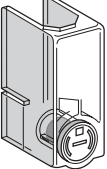
 <p>LA9F70•</p>	These clear plastic protection shrouds are an effective means to meet international touch-safe requirements for power terminals. They are designed to be used with power cables that have been bolted to the terminal. <i>NOTE: The protection shrouds do not attach to contactors or overload relays utilizing DZ2F lug kits.</i>	
	For use with relays	Catalog Number
	LR9F5•57	LA9F701
	LR9F5•63, F5•67, F5•69	LA9F702
	LR9F5•71	LA9F705
LR9F7•75, F7•79, F7•81	LA9F703	

Power Terminal Protection Shrouds, 3-Poles

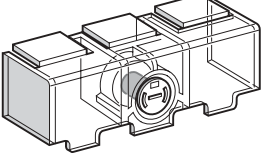
 <p>LA7F70•</p>	For use with relays	Catalog Number
	LR9F5•57, F5•63, F5•67, F5•69	LA7F701
	LR9F5•71	LA7F702
	LR9F7•75, F7•79, F7•81	LA7F703

Connection Accessories Required (for mounting overload relays beneath reversing contactors)

Application		Set of 3 bars Catalog Number
For relays	For contactor	
LR9F5•57, F5•63, F5•67, F5•69	LC1F115	LA7F401
LR9F5•57, F5•63	LC1F150 and F185	LA7F402
LR9F5•71	LC1F185	LA7F407
LR9F5•71	LC1F265	LA7F403
LR9F7•75, F7•79	LC1F265 to F400	LA7F404
LR9F7•81	LC1F400	LA7F404
LR9F7•75, F7•79, F7•81	LC1F500	LA7F405
LR9F7•81	LC1F630	LA7F406
Marking accessories		
Description	Sold in units of:	Catalog Number
Marker holder, snap-in	100	LA7D903

Control Accessories

Description	Sold in lots of	Catalog Number						
Remote electrical reset snap-on module ■	1	LA7D03• ▲						
Remote reset function control by flexible cable (length = 0.5 m / 0.02")	1	LA7D305						
Locking Device for "Stop" button	10	LA7D901						
Remote Stop and/or Reset function control	Adaptor for door mounted operator	1						
	Rod (snap-off end to obtain required length, between 17 and 120 mm)	1						
	Operating head for spring return pushbutton	1						
Standard control circuit voltages								
Volts	12	24	48	96	110	220/230	380/400	415/440
AC 50/60 Hz	–	B	E	–	F	M	Q	N
Consumption, inrush and sealed: < 100 VA								
DC	J	B	E	DD	F	M	–	–
Consumption, inrush and sealed: < 100 W								

■ Part number to be completed by adding coil voltage code.

▲ The time for which the coil of remote electrical reset device LA7D03 can remain energized depends on its rest time: 1 s pulse duration with 9 s rest time; 5 s pulse duration with 30 s rest time; 10 s pulse duration with 90 s rest time: maximum pulse duration of 20 s with rest time of 300 s. Minimum impulse time: 200 ms.

TeSys™ F-Line Contactors and Starters

LR9F Solid State Overload Relays - Dimensions

Common side view

LR9F5-71

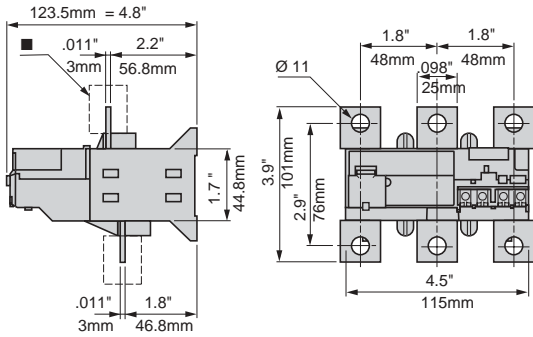

■ Terminal shroud LA9F70•.

LR9F5•57, F5•63, F5•67, F5•69

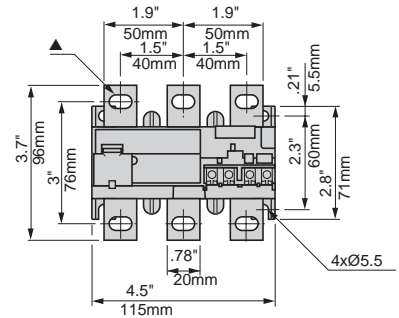

▲ 6.5 x 13.5 for LR9F5•57 and 8.5 x 13.5 for LR9F5•63, F5•67, F5•69.

Common side view

LR9F7•75, F7•79, F7•81

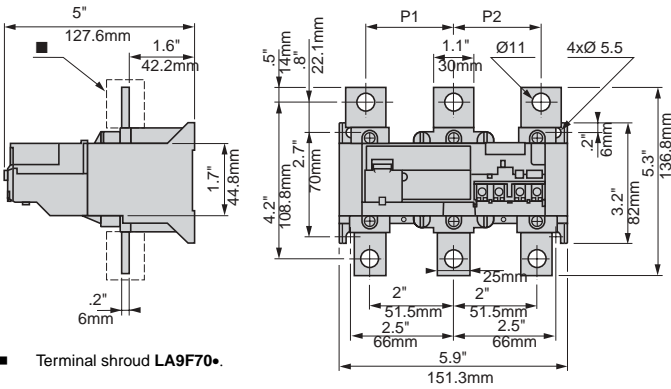

■ Terminal shroud LA9F70•.

LR9F7•81 (for mounting beneath LC1F630)

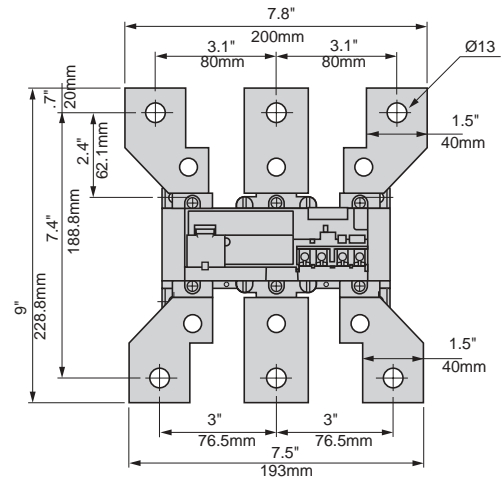

	P1	P2
LR9F7•75	48	48
LR9F7•79, F7•81	55	55

TeSys™ F-Line Contactors and Starters LR9F Solid State Overload Relays - Mounting

Direct mounting beneath contactor LC1F

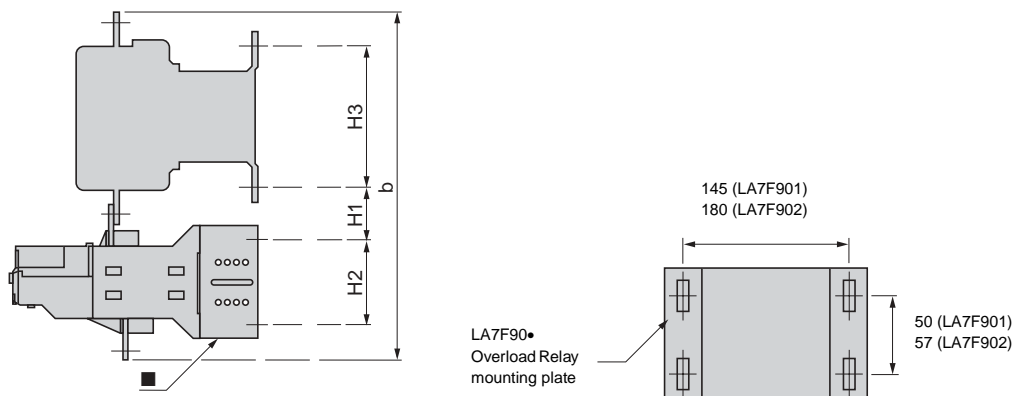

LC1 contactors	With LR9 relays	b	H1	H2	H3
F115	F5•57, F5•63, F5•67, F5•69	240	30	76	120
F150	F5•57, F5•63, F5•67, F5•69	246	30	76	120
F185	F5•57, F5•63, F5•67, F5•69	250	30	76	120
F225	F5•71	273	40	76	120
	F7•75, F7•79	308	50	108.8	120
F265	F5•71	279	40	76	120
	F7•75, F7•79	314	60	108.8	120
F330	F7•75, F7•79	317	60	108.8	120
F400	F7•75, F7•79, F7•81	317	60	108.8	180
F500	F7•75, F7•79, F7•81	346	70	108.8	180
F630	F7•81	510	110	108.8	180

Direct mounting beneath reversing contactors or star-delta contactors

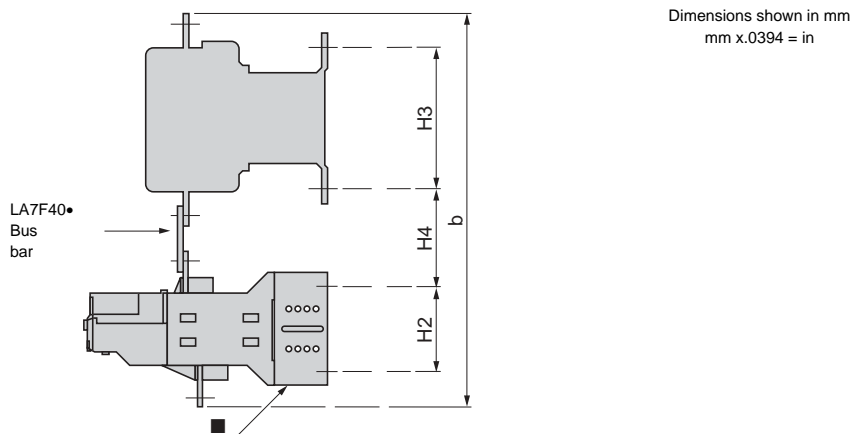

LC1 contactors	With LR9 relays	b	H4	H2	H3
F115	F5•57, F5•63, F5•67, F5•69	279	60	76	120
F150	F5•57, F5•63, F5•67, F5•69	283	60	76	120
F185	F5•57, F5•63, F5•67, F5•69	285	60	76	120
F225	F5•71	319	80	76	120
	F7•75, F7•79	360	100	108.8	120
F265	F5•71	332	90	76	120
	F7•75, F7•79	363	100	108.8	120
F330	F7•75, F7•79	364	100	108.8	120
F400	F7•75, F7•79, F7•81	364	100	108.8	180
F500	F7•75, F7•79, F7•81	390	110	108.8	180
F630	F7•81	509	120	108.8	180

■ Relay mounting plate, see page 221.

TeSys™ F-Line Contactors and Starters

LR9F Solid State Overload Relays - Wiring Diagrams

Wiring Diagram LR9F

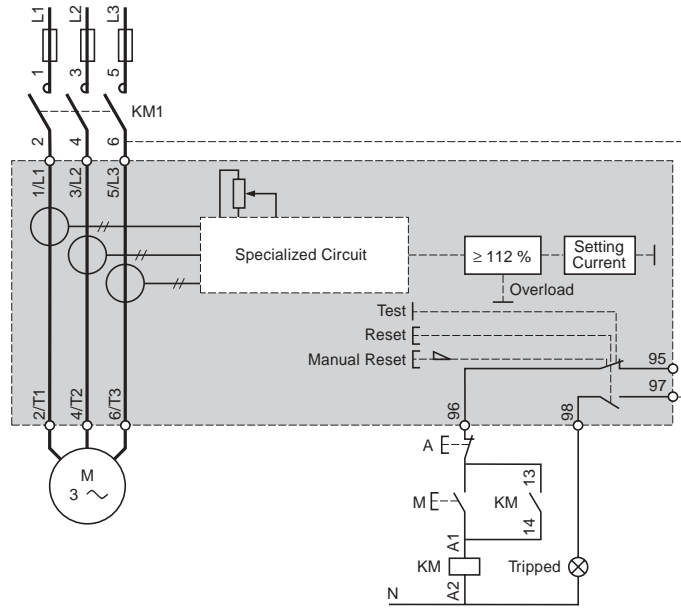

Setting the special functions of LR9F thermal overload relays

Setting the Relay

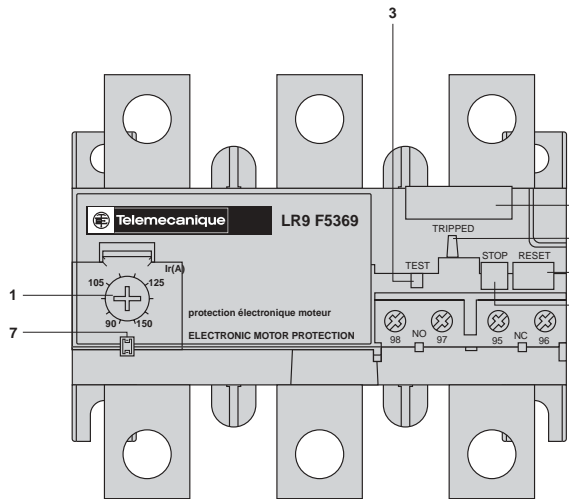

- Lift the transparent cover (7) to gain access to the settings and controls.
- Adjust relay by turning dial (1), which is graduated directly in amperes.
- The setting can be locked by sealing of the cover (7).

2: Stop Function

- The Stop function is obtained by pressing the red "STOP" button (2).
- Pressing the "STOP" button actuates the N.C. contact, but does not affect the N.O. contact.
- The "STOP" button can be locked by installing a "U" clip (catalog number LA7D901).

3: Test Function

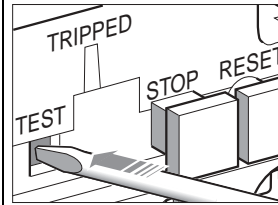

Test

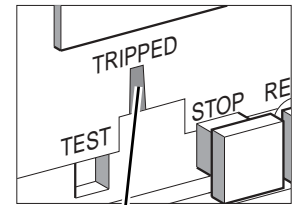

Trip Indicator

- The Test function is activated by pressing the red "TEST" button (3) with a screwdriver.
- Pressing the "TEST" button simulates tripping of the relay and actuates both N.O. and N.C. contacts, and also actuates the trip indicator (5).

CR1F/CR1B Contactors and Accessories

Magnetic Latching Contactors – Characteristics

Magnetic latching contactors of both block and bar mounted types include a special electromagnet which enables them to remain in the “on” position when the coil is no longer energized.

The special properties of magnetic latching contactors make them suitable for a large number of applications:

Properties

- Retention of the sequence memory in automatic control equipment in the event of a control circuit failure.
- Energy saving, since the source of supply to the coil does not need to supply current when the contactor is latched in the closed state.
- Change of state from “Closed” to “Open” by current signal through the coil.
- Unaffected by line interference.
- Utilization of contactors beyond their breaking capacity as operations are performed off Load.
- Contactors are silent in the latched position.

Applications

- Refineries, power stations, excitation circuits.
- Contactors remaining in the closed state for long periods.
Example: refineries, power supplies, low voltage distribution.
- Selective opening control.
- No unwanted opening and closing of the main power poles.
- Current carrying at voltages up to 1000 Volts.

Operation of the electromagnet

CR1F contactors

CR1F magnetic latching contactors include a double coil with 3 terminals comprising a latching winding and an unlatching winding. The 2 windings have a common point which can necessitate special wiring precautions when the latching supply is separate from the unlatching supply.

The power supplies may be AC or DC. For DC operation, the polarities indicated must be complied with.

Operating precautions:

- the 2 windings must not be energized simultaneously,
- a winding must not be energized continuously,
- supply to the coils must be via momentary contacts.

Manual opening: If the control voltage is not present, the contactor can be unlatched manually.

CR1B contactors

CR1B magnetic latching contactors included a single coil, supplied with DC or AC through a rectifier.

Latching is obtained by direct supply of the coil in one direction of current flow.



Unlatching is obtained by a reverse current, adjusted by resistors.

LC1D contactors

For applications using smaller contactor sizes than those described in the following pages, it is possible to obtain the same function by the addition of a mechanical latching block type **LA6DK**, which can be mounted on **LC1D** contactors (information on D-line contactors starts on page 79).

CR1F/CR1B Contactors and Accessories

Magnetic Latching Contactors – Characteristics

Type		CR1F150	CR1F185	CR1F265	CR1F400	CR1F500	CR1F630	CR1BL	CR1BM	CR1BP	CR1BR		
Environment													
Rated insulation voltage (Vi)	Conforming to IEC 60947-4-1, BS 775, 60947-4	V	1000	1000	1000	1000	1000	1000	1000	1000	1000	1000	
	Conforming to VDE 0110 grC	V	1500	1500	1500	1500	1500	1500	1500	1500	1500	1500	
Conforming to standards	 Meets the essential requirements of the LV & EMC directives		IEC 60947-4, NFC 63-110, VDE 0660, BS 5424, JEM 1038										
Approvals	 E164862 NLDX ▾  LR43364 3211 04 ▾		ASE, CSA, UL, BV, GL, LROS, USSR, NORSE VERITAS, RINA										
Degree of protection	Conforming to IEC 60529		IP 20 front face with shrouds LA9F										
	Conforming to VDE 0106		Protection against direct finger contact with shrouds LA9F										
Protective treatment	Standard version		"TH"						"TC"				
	Special version		-						"TH"				
Ambient air temperature around the device	Storage		-60 to +80 °C (-76 to +176 °F)										
	For operation at Vc		-15 to +70 °C (5 to +158 °F)						-15 to +60 °C (5 to +158 °F)				
Maximum operating altitude	Without derating		3000m (9800 ft.)										
Operating positions	Without derating		± 5° in relation to normal vertical mounting position						± 30° in relation to normal vertical mounting position				

Pole characteristics

Number of poles			3 or 4	3 or 4	3 or 4	3 or 4	3 or 4	3 or 4	3 or 4	1, 2, 3 or 4	1, 2, 3 or 4	1, 2, 3 or 4	1, 2, 3 or 4
Rated operational current (Ie) (Ve ≤ 440 V)	AC-3, q ≤ 40 °C (104 °F)	A	150	185	265	400	500	630	750	1000	1500	1800	
	AC-1, q ≤ 40 °C (104 °F)	A	250	275	350	500	700	1000	800	1250	2000	2750	
	AC-4, q ≤ 40 °C (104 °F)	A	138	170	245	370	460	560	700	800	1250	1500	
Rated operational current (Ve)	Up to	V	1000	1000	1000	1000	1000	1000	1000	1000	1000	1000	
Frequency limits (sine wave)	of the operational current	Hz	25 to 200	25 to 200	25 to 200	25 to 200	25 to 200	25 to 200	25 to 200	50 to 60	50 to 60	50 to 60	50 to 60
Rated making capacity	I rms	A	1700	2100	2940	4500	5500	6740	10 000	10 000	15 000	18 000	
Rated breaking capacity	I rms	220 to 440 V	A	1500	1800	2450	4000	5000	6300	10 000	10 000	15 000	18 000
		500 V	A	1200	1600	2200	3500	4500	5400	9000	9000	12 000	15 000
		660/690 V	A	1100	1200	1700	3000	3560	4600	8000	8000	9000	11 000
		1000 V	A	450	600	800	1200	2500	3200	4000	4000	5000	6000
Permissible short time rating from cold state, no current flowing for preceding 60 minutes at q ≤ 40 °C (104 °F)	For 1 s	A	1200	1500	2200	3600	4200	5050	9600	9600	12 000	15 000	
	For 5 s	A	1200	1500	2200	3600	4200	5050	9600	9600	12 000	15 000	
	For 10 s	A	1200	1500	2200	3600	4200	5050	7000	8000	9600	12 000	
	For 30 s	A	700	920	1230	2400	3200	4400	4800	5200	6400	8000	
	For 1 min	A	600	740	950	1700	2400	3400	3500	3800	5200	6300	
	For 3 min	A	450	500	620	1200	1500	2200	2100	2400	3600	4400	
Short-circuit protection by fuses q ≤ 440 V ●	Motor circuit AC-3 (type aM)	A	160	200	315	400	500	630	800	1200	800 x 2 ♦	1000 x 2 ♦	
	AC-1 circuit (type gl, BS 88)	A	250	315	400	500	800	1000	800	1200	1000 x 2 ♦	1200 x 2 ♦	
Average impedance per pole	At Ith and 50 Hz	mΩ	0.45	0.36	0.32	0.28	0.18	0.12	0.18	0.18	0.13	0.09	
Power dissipated per pole for the above operational currents	AC-3	W	6	12	22	45	45	48	88	180	290	360	
	AC-1	W	18	26	39	70	88	120	115	280	520	680	
Cabling	Cable size (min - max)	AWG	#6 to 3/0	#6 to 3/0	#6 to 300mcm	#4 to 500mcm	2 x #2 to 600mcm	3 x #2 to 600mcm	-	-	-	-	
	Lug		DZ2 FG	DZ2 FG	DZ2 FH	DZ2 FJ	DZ2 FK	DZ2 FL	-	-	-	-	
Tightening torque using DZ2F●● Lug	Bolt lug to contactor	lb-in	160	160	310	310	310	510	-	-	-	-	
	Wire pressure screw	lb-in	200	200	275	500	500	500	-	-	-	-	
Bus bar connections	Number of bars		-	-	-	-	-	-	2	2	3	4	
	Bar c.s.a.	mm in	-	-	-	-	-	-	50 x 5 1.9 x 0.2	80 x 5 3.1 x 0.2	100 x 5 3.9 x 0.2	100 x 10 3.9 x 0.2	
	Bolt diameter		-	-	-	-	-	-	4 x Ø 8	4 x Ø 10	4 x Ø 10	4 x Ø 10	
	Tightening torque	lb-in	-	-	-	-	-	-	185	310	310	310	

- ▼ CR1F150 to CR1F630 only. CR1B contactors are not UL listed or CSA certified.
- ♦ Paralleling of poles must be carried out only in accordance with the fuse manufacturer's recommendations.
- Select short circuit protection to meet the National Electrical Code or other local codes and standards.

CR1F/CR1B Contactors and Accessories

Magnetic Latching Contactors – Characteristics

Type	CR1F150	CR1F185	CR1F265	CR1F400	CR1F500	CR1F630	CR1BL	CR1BM	CR1BP	CR1BR			
Control circuit characteristics													
Rated control circuit voltage (Vc)	AC 50 or 60 Hz	V	48 to 415				110 to 500						
	AC 400 Hz	V	48 to 220				110 to 500						
	DC	V	48 to 220				110 to 500						
	DC low consumption	V	48 to 220				–						
Control voltage limits AC and DC	Energization		0.85 to 1.1 Vc										
	De-energization		0.85 to 1.1 Vc										
Max. operating rate at ambient temperature ≤ 40 °C (104 °F)	In operating cycles/hour		600						120				
	In millions of operating cycles		1										
Average consumption	Energization	1-pole	VA	–	–	–	–	–	–	650	650	650	650
		2-pole	VA	–	–	–	–	–	–	1100	1100	1100	1100
		3-pole	VA	1100	1600	1650	1450	1650	2100	1650	1650	1650	1650
		4-pole	VA	1100	1600	1650	1450	1650	2100	1850	1850	1850	1850
50/60 Hz	De-energization	1-pole	VA	–	–	–	–	–	–	110	110	110	110
		2-pole	VA	–	–	–	–	–	–	125	125	125	125
		3-pole	VA	7.3	8	9	12	9.5	8	165	165	165	165
		4-pole	VA	7.3	8	9	12	9.5	8	175	175	175	175
400 Hz and DC	Energization	1-pole	VA	–	–	–	–	–	–	600	600	600	600
		2-pole	VA	–	–	–	–	–	–	1000	1000	1000	1000
		3-pole	VA	1260	1750	1800	1600	1800	2300	1500	1500	1500	1500
		4-pole	VA	1260	1750	1800	1600	1800	2300	1700	1700	1700	1700
	De-energization	1-pole	VA	–	–	–	–	–	–	100	100	100	100
		2-pole	VA	–	–	–	–	–	–	115	115	115	115
		3-pole	VA	10	11	12	16	13	11	150	150	150	150
		4-pole	VA	10	11	12	16	13	11	160	160	160	160
DC low consumption	Energization	3/4-pole	W	500	500	500	500	550	620	–	–	–	–
	De-energization	3/4-pole	W	15	20	40	70	60	45	–	–	–	–
Average operating time at Vc ▲	Energization	ms	35 to 40	35 to 40	45 to 50	40 to 75	40 to 80	40 to 80	100 to 150	100 to 150	100 to 150	100 to 150	
	De-energization	ms	50 to 100	50 to 100	50 to 100	50 to 100	50 to 100	50 to 100	20 to 40	20 to 40	20 to 40	20 to 40	

▲ The closing time is measured from the moment the coil supply is switched on to initial contact of the main poles. The opening time is measured from the moment the coil supply is switched off to the moment the main poles separate.

NOTE: The arcing time depends on the circuit switched by the poles. For normal 3-phase applications the arcing time is usually less than 10 ms. The load is isolated from the supply after a time equal to the sum of the opening time and the arcing time.

Auxiliary contact characteristics

Type		LA1D for contactors CR1F	ZC4GM for contactors CR1B
Conventional rated thermal current		A	20
Rated insulation voltage (Vi)	Conforming to IEC 60947-5-1	V	660
	Conforming to VDE 0110 grC	V	750
Cabling	Flexible or solid conductor with or without cable end	mm ²	1 x 1 min/2 x 2.5 max (1 - #16 min / 2 - #14 max)
			2 min/4 max (#14 min / #10 max)

Operational power of contacts LA1D for contactors CR1F

	AC supply					
	V	48	110/127	220/230	380/400	600
1 million operating cycles	VA	300	400	480	500	500
Occasional making capacity	VA	2600	7000	13 000	15 000	9000

DC supply

Electrical durability (valid for up to 1200 operating cycles/h) on an inductive load such as the coil of an electromagnet without economy resistor, the time constant increasing with the load.

	V	48	110	220	440	600
W	90	75	68	61	58	
W	700	400	260	220	170	

Operational power of contacts ZC4GM for contactors CR1B

	AC supply					
	V	110/127	220	380	415/440	500
1 million operating cycles	VA	2000	4000	4000	4000	3500
Occasional making capacity	VA	14000	23000	35000	45000	35000

DC supply

Electrical durability (valid for up to 1200 operating cycles/h) on an inductive load such as the coil of an electromagnet without economy resistor, the time constant increasing with the load.

	V	110	120	440	500
W	250	250	230	200	
W	1600	800	400	360	

CR1F/CR1B Contactors and Accessories

Magnetic Latching Contactors – Characteristics

For Utilization Category AC-1 and According to Required Electrical Durability
Maximum Operational Current (on-load factor ≥ 0.95)

Maximum operating rate: 120 operating cycles/hour											
Contactor size		CR1 F150	CR1 F185	CR1 F265	CR1 F400	CR1 F500	CR1 F630	CR1 BL	CR1 BM	CR1 BP	CR1 BR
Cable c.s.a.	mm ²	120 (250 MCM)	150 (300 MCM)	185 (350 MCM)	–	–	–	–	–	–	–
Number of bars		–	–	–	2	2	2	2	2	3	4
Bar c.s.a.		mm in	–	–	30 x 5 1.18 x 0.2	40 x 5 1.57 x 0.2	60 x 5 2.36 x 0.2	50 x 5 1.96 x 0.2	80 x 5 3.14 x 0.2	100 x 5 3.93 x 0.2	100 x 5 3.93 x 0.2
Operational current in category AC-1 at ambient temperature	$\leq 40\text{ }^{\circ}\text{C}$ (104 °F) A	250	275	350	500	700	1000	800	1250	2000	2750
	$\leq 55\text{ }^{\circ}\text{C}$ (131 °F) A	250	275	300	430	580	850	700	1100	1750	2400
	$\leq 70\text{ }^{\circ}\text{C}$ (158 °F) A	170	180	250	340	500	700	600	900	1500	2000

Increase in Operational Current by Paralleling of Poles

Apply the following multiplying factors to the current values given above; these factors take into account the often unbalanced current distribution between poles:

- 2 poles in parallel: K = 1.6
- 3 poles in parallel: K = 2.25
- 4 poles in parallel: K = 2.8

Electrical durability ($V_e \leq 440\text{ V}$)

NOTE: For 660 V, multiply the number of operating cycles by 0.8.

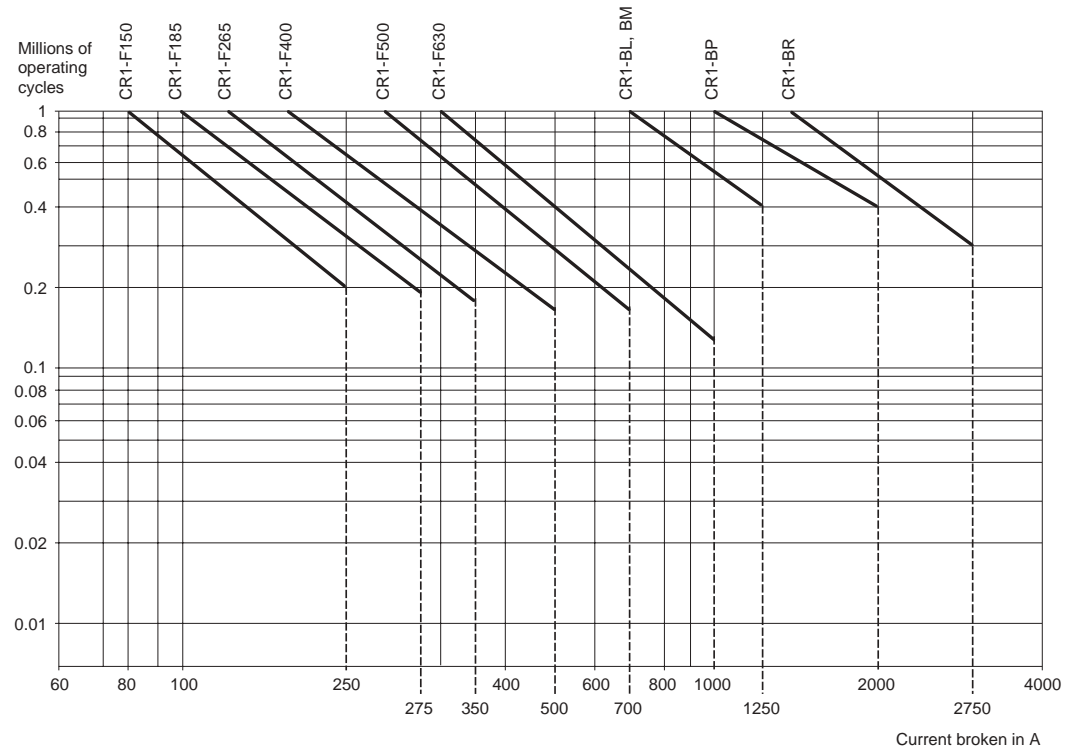

Example

$V_e = 220\text{ V}$, $I_e = 200\text{ A}$, $q = 40\text{ }^{\circ}\text{C}$ (104 °F), $I_c = I_e = 200\text{ A}$. 600,000 operating cycles required.

The above selection curves show the contactor rating needed: **CR1F400**.

CR1F/CR1B Contactors and Accessories

Magnetic Latching Contactors – Characteristics

For Switching the Primaries of 3-Phase Transformers

International applications only (not UL Listed or CSA certified for transformer switching)

Operating Conditions

Maximum ambient temperature: 55 °C (131 °F)

Maximum operational voltage: 1000 V, 50 to 60 Hz

When a transformer is switched on, there is generally an initial current surge which reaches its peak value almost instantaneously and then decreases in a largely exponential manner to quickly reach its steady state value.

The value of this current depends on:

- The characteristics of the magnetic circuit and of the windings (cross sectional area of the core, rated inductance, number of turns, size of the windings).
- the performance of the magnetic laminations used (residual induction and saturation inductance).
- the magnetic state of the circuit and the instantaneous value of the AC mains voltage at the moment of switch-on.

The inrush current at the moment of switch-on can reach 20 to 40 times the rated current for the various kVA power ratings in the tables below. This value is independent of the “no-load” or “on-load” state of the transformer (the tables are based on 30 In).

The peak magnetizing current of the transformer must be lower than the values given in the tables below.

Contactor Selection

Maximum Operating Rate: 120 operating cycles /hour							
Contactor size		CR1F150	CR1F185	CR1F265	CR1F400	CR1F500	CR1F630
Maximum permissible closing current peak	A	1700	2800	3500	5500	6800	9000
Maximum operational power in kVA ■	220 to 230 V	25	40	50	75	100	140
	380 to 400 V	50	75	90	130	170	225
	415 to 440 V	55	80	100	140	190	250
	500 V	65	95	110	170	225	280
	660 V	80	120	140	200	270	315
	1000 V	100	150	200	250	375	470
Contactor size		CR1BL	CR1BM	CR1BP	CR1BR		
Maximum permissible closing current peak	A	18 000	18 000	24 000	30 000		
Maximum operational power in kVA ■	220 to 230 V	230	230	300	380		
	380 to 400 V	400	400	530	660		
	415 to 440 V	450	450	560	700		
	500 V	480	480	600	750		
	660 V	600	600	800	950		
	1000 V	700	700	1000	1200		

■ Maximum operational power corresponding to a current peak at switch-on of 30 In.

CR1F/CR1B Contactors and Accessories

Magnetic Latching Contactors – AC or DC – Selection



CR1F1854•



CR1F500



CR1BP33

Maximum thermal current in category AC-1	Rated operational current in category AC-3	Power Poles			Auxiliary Contacts		Catalog Number ▼	Weight lb (kg)
A	A	N.O.	N.O.	N.C.				
250	150	3	–	–	CR1F150•	0.14 (3.500)		
		4	–	–	CR1F1504•	0.15 (3.800)		
275	185	3	–	–	CR1F185•	0.18 (4.600)		
		4	–	–	CR1F1854•	0.21 (5.400)		
350	265	3	–	–	CR1F265•	0.29 (7.400)		
		4	–	–	CR1F2654•	0.33 (8.500)		
500	400	3	–	–	CR1F400•	0.36 (9.100)		
		4	–	–	CR1F4004•	0.40 (10.200)		
700	500	3	–	–	CR1F500•	0.44 (11.300)		
		4	–	–	CR1F5004•	0.51 (12.900)		
1000	630	3	–	–	CR1F630•	0.73 (18.600)		
		4	–	–	CR1F6304•	0.84 (21.500)		
800	750	1	1	2	CR1BL31•12	1.26 (32.000)		
			2	1	CR1BL31•21	1.26 (32.000)		
			3	–	CR1BL31•30	1.26 (32.000)		
		2	1	2	CR1BL32•12	1.77 (45.000)		
			2	1	CR1BL32•21	1.77 (45.000)		
			3	–	CR1BL32•30	1.77 (45.000)		
		3	1	2	CR1BL33•12	2.30 (58.000)		
			2	1	CR1BL33•21	2.30 (58.000)		
			3	–	CR1BL33•30	2.30 (58.000)		
		4	1	2	CR1BL34•12	2.83 (72.000)		
			2	1	CR1BL34•21	2.83 (72.000)		
			3	–	CR1BL34•30	2.83 (72.000)		
1250	1000	1	1	2	CR1BM31•12	1.22 (31.000)		
			2	1	CR1BM31•21	1.22 (31.000)		
			3	–	CR1BM31•30	1.22 (31.000)		
		2	1	2	CR1BM32•12	1.73 (44.000)		
			2	1	CR1BM32•21	1.73 (44.000)		
			3	–	CR1BM32•30	1.73 (44.000)		
		3	1	2	CR1BM33•12	2.24 (57.000)		
			2	1	CR1BM33•21	2.24 (57.000)		
			3	–	CR1BM33•30	2.24 (57.000)		
		4	1	2	CR1BM34•12	2.79 (71.000)		
			2	1	CR1BM34•21	2.79 (71.000)		
			3	–	CR1BM34•30	2.79 (71.000)		
2000	1500	1	1	2	CR1BP31•12	1.61 (41.000)		
			2	1	CR1BP31•21	1.61 (41.000)		
			3	–	CR1BP31•30	1.61 (41.000)		
		2	1	2	CR1BP32•12	2.55 (65.000)		
			2	1	CR1BP32•21	2.55 (65.000)		
			3	–	CR1BP32•30	2.55 (65.000)		
		3	1	2	CR1BP33•12	3.70 (94.000)		
			2	1	CR1BP33•21	3.70 (94.000)		
			3	–	CR1BP33•30	3.70 (94.000)		
		4	1	2	CR1BP34•12	4.72 (120.000)		
			2	1	CR1BP34•21	4.72 (120.000)		
			3	–	CR1BP34•30	4.72 (120.000)		
2750	1800	1	1	2	CR1BR31•12	2.05 (52.000)		
			2	1	CR1BR31•21	2.05 (52.000)		
			3	–	CR1BR31•30	2.05 (52.000)		
		2	1	2	CR1BR32•12	3.34 (85.000)		
			2	1	CR1BR32•21	3.34 (85.000)		
			3	–	CR1BR32•30	3.34 (85.000)		
		3	1	2	CR1BR33•12	5.07 (129.000)		
			2	1	CR1BR33•21	5.07 (129.000)		
			3	–	CR1BR33•30	5.07 (129.000)		
		4	1	2	CR1BR34•12	6.29 (160.000)		
			2	1	CR1BR34•21	6.29 (160.000)		
			3	–	CR1BR34•30	6.29 (160.000)		

▼ For standard control circuit voltages, see page 231.

CR1F/CR1B Contactors and Accessories Magnetic Latching Contactors – Accessories – Selection



LA1DN22

For Contactors CR1F

Description	Number of contacts or shrouds	For use on	Catalog Number	Weight lb (kg)
Instantaneous auxiliary contacts	1 to 9	CR1F	LA1D ■	1.27 (0.580)
Time delay auxiliary contacts	2 to 4	CR1F	LA•D ■	1.27 (0.580)
Insulated Terminal Blocks provides IP20 touch-safe protection	Set of 2 blocks	CR1F150 and CR1F185 AWG cable size #6 to 300mcm	LA9F103	0.66 (0.300)

■ For selection, see pages 194 through 197.

Lug Kits

Lugs can be ordered either individually (for 2- and 4-pole contactors) or in sets of 6 (for 3-pole contactors). Mounting hardware is provided with the contactors, not the kits.



LA•DT, DS

Single lug	Set of six lugs	Cable size AWG range	Suitable for contactor LC1••••/CR1••••	Suitable for overload relay LR9••••▲
DZ2FF1	DZ2FF6	14 to 2/0	F115	none
DZ2FG1	DZ2FG6	6 to 3/0	F150, F185	F5•57, F5•63, F5•67, F5•69
DZ2FH1	DZ2FH6	6 to 300 MCM	F265, F330	LR9F•71
DZ3FJ1	DZ3FJ6	4 to 500 MCM	F400	none
DZ2FK1	DZ2FK6	2 x 2 to 600 MCM	F500	F7•75, F7•79
DZ2FL•◆	DZ2FL6	3 x 2 to 600 MCM	F630, F800	F7•81
DZ2FX	DZ2FX6	4 x 1/0 to 750 MCM	F780	none

▲ When direct mounting the LR9F to an LC1F or CR1F contactor, lugs of different sizes may be required. See page 220 for additional information.

◆ For 3-pole F630 contactors, order DZ2FL1 for L1 and T3, DZ2FL2 for L2 and T2 and DZ2PL3 for L3 and T1 terminals.

For 4-pole F6304 contactors, order DZ2FL1 for L1 and T4, DZ2FL2 for L2, T2, L3 and T3 and DZ2FL3 for L4 and T1 terminals.

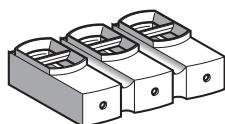

LA9F103

Description	Application	Catalog Number
Mechanical interlock and power connections	For assembly of reversing contactors and changeover contactor pairs	See pages 190 to 193.

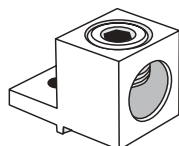

DZ2F••

For Contactors CR1B

Description	Application	Catalog number	Weight lb (kg)
Mechanical interlock with mounting accessories ▼	For vertical assembly of reversing contactors and changeover contactor pairs	EZ2LB0601	3.44 (1.560)
Kit containing 2 bar mounting brackets	For mounting on 120 or 150 mm center (4.72" or 5.91")	LA9B103	3.57 (1.620)

▼ Positive mechanical interlocking between two vertically-mounted contactors with identical or different ratings. Connecting rods and cranks assembled on right-hand side, crank pins on the pole side. Vertical mounting center distance between the two contactors: 600 mm (23.62").

Coil Selection

Volts	48	110	125	127	220	230	240	250	380	400	415	440	500
For contactors CR1F													
AC 50/60 Hz	E7	F7	–	G7	M7	M7	U7	–	Q7	Q7	N7	–	–
AC 400 Hz	E7	F7	–	G7	M7	M7	–	–	–	–	–	–	–
DC	E7	F7	–	G7	M7	M7	–	–	–	–	–	–	–
DC low consumption	EZ7	FZ7	–	GZ7	MZ7	–	–	–	–	–	–	–	–
For contactors CR1B													
AC 50 to 400 Hz	F	–	G	M	M	U	–	Q	V	N	R	S	–
DC	FD	GD	–	MD	–	UD	VcD	–	–	–	RD	SD	–

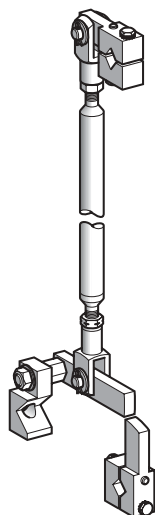

EZ2LB0601

CR1F/CR1B Contactors and Accessories

Magnetic Latching Contactors – Mechanical Interlocks and Power Connections

Horizontally or Vertically Mounted

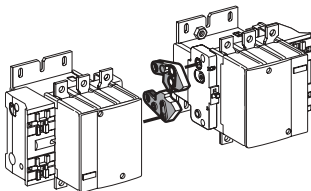
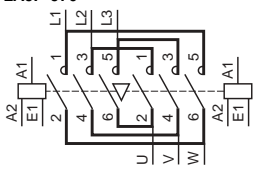
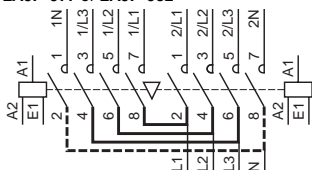
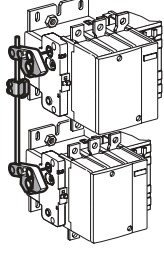
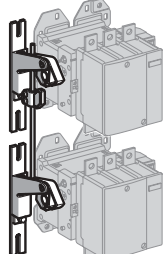
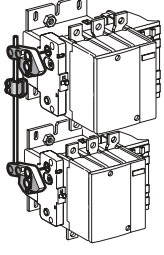
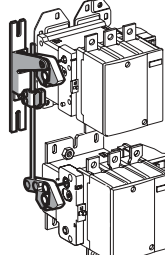
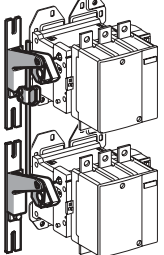
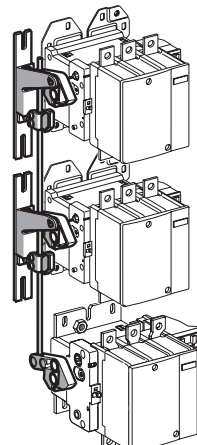
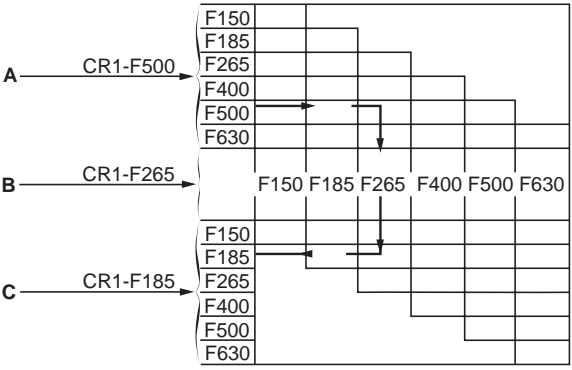
Horizontally mounted	Mechanical interlocks	Sets of power connections	
<p>Reversers assembled using 2 contactors of identical rating type:</p> <p>CR1F150 CR1F185 CR1F265 CR1F400 CR1F500 CR1F630</p>	<p>LA9F•970</p> 	<p>Reversing contactors LA9F•976</p>  <p>3 or 4-pole changeover contactor pairs LA9F•977 or LA9F•982</p> 	
Vertically mounted	Mechanical interlocks		
<p>Reversers assembled using 2 contactors of identical rating type:</p> <p>CR1F150 CR1F185 CR1F265 CR1F400 CR1F500 CR1F630</p>	<p>LA9FF4F LA9FG4G</p> <p>Assembly A</p> 	<p>LA9FH4H LA9FJ4J LA9FK4K LA9FL4L</p> <p>Assembly C</p> 	
<p>Reversers assembled using 2 contactors of different ratings type:</p> <p>CR1F150 CR1F185 CR1F265 CR1F400 CR1F500 CR1F630</p>	<p>LA9FG4F</p> <p>Assembly A</p> 	<p>LA9FH4F LA9FJ4F LA9FK4F LA9FL4F LA9FH4G LA9FJ4G LA9FK4G LA9FL4G</p> <p>Assembly B</p> 	<p>LA9FJ4H LA9FK4H LA9FL4H LA9FK4J LA9FL4J LA9FK4K</p> <p>Assembly C</p> 
<p>Reversers assembled using 3 contactors of identical or different ratings</p>	<p>LA9F•4•4•</p> 	 <p>Warning: the contactor ratings must be in descending order from top to bottom.</p>	

CR1F/CR1B Contactors and Accessories

Magnetic Latching Contactors – Mechanical Interlocks and Power Connections

Components for Assembling Reversing Contactors and Changeover Pairs CR1F

Reversers assembled using 2 contactors of identical rating

	Contactor Type	Set of power connections		Mechanical Interlock	
		Catalog Number	Weight lb (kg)	Kit Catalog Number	Weight lb (kg)
For assembly of 3-pole reversing contactors for motor control ■	Horizontally mounted				
	CR1F150	LA9FF976	0.02 (0.600)	LA9FF970	0.13 (0.060)
	CR1F185	LA9FG976	0.03 (0.780)	LA9FG970	0.13 (0.060)
	CR1F265	LA9FH976	0.05 (1.500)	LA9FJ970	0.31 (0.140)
	CR1F400	LA9FJ976	0.08 (2.100)	LA9FJ970	0.31 (0.140)
	CR1F500	LA9FK976	0.09 (2.350)	LA9FJ970	0.31 (0.140)
	CR1F630	LA9FL976	0.15 (3.800)	LA9FL970	0.33 (0.150)
	Vertically mounted				
	CR1F150	●		LA9FF4F	0.76 (0.345)
	CR1F185	●		LA9FG4G	0.77 (0.350)
	CR1F265	●		LA9FH4H	2.33 (1.060)
	CR1F400	●		LA9FJ4J	2.64 (1.200)
	CR1F500	●		LA9FK4K	2.64 (1.200)
	CR1F630	●		LA9FL4L	2.68 (1.220)
For assembly of 4-pole changeover contactor pairs for distribution	Horizontally mounted				
	CR1F1504	LA9FF977	0.01 (0.460)	LA9FF970	0.13 (0.060)
	CR1F1854	LA9FG977	0.02 (0.610)	LA9FG970	0.13 (0.060)
	CR1F2654	LA9FH977	0.04 (1.200)	LA9FJ970	0.31 (0.140)
	CR1F4004	LA9FJ977	0.07 (1.800)	LA9FJ970	0.31 (0.140)
	CR1F5004	LA9FK977	0.09 (2.300)	LA9FJ970	0.31 (0.140)
	CR1F6304	LA9FL977	0.13 (3.400)	LA9FL970	0.33 (0.150)
	Vertically mounted				
	CR1F1504	●		LA9FF4F	0.76 (0.345)
	CR1F1854	●		LA9FG4G	0.77 (0.350)
	CR1F2654	●		LA9FH4H	2.33 (1.060)
	CR1F4004	●		LA9FJ4J	2.64 (1.200)
	CR1F5004	●		LA9FK4K	2.64 (1.200)
	CR1F6304	●		LA9FL4L	2.68 (1.220)

Reversers assembled using 2 contactors of different ratings

	Contactor Type (vertically-mounted) ▲	Set of Power Connections		Mechanical Interlock		
		Catalog Number		Kit Catalog Number	Weight (kg) (kg x 2.2 = lbs)	
For assembly of 3 or 4-pole changeover contactor pairs for distribution	at bottom	at top				
	CR1F150 or F1504		CR1F185 or F1854		LA9FG4F	0.77 (0.350)
			CR1F265 or F2654		LA9FH4F	1.92 (0.870)
			CR1F400 or F4004		LA9FJ4F	2.05 (0.930)
			CR1F500 or F5004		LA9FK4F	2.07 (0.940)
			CR1F630 or F6304		LA9FL4F	2.07 (0.940)
	CR1F185 or F1854		CR1F265 or F2654		LA9FH4G	1.89 (0.860)
			CR1F400 or F4004		LA9FJ4G	2.07 (0.940)
			CR1F500 or F5004		LA9FK4G	2.07 (0.940)
			CR1F630 or F6304		LA9FL4G	2.09 (0.950)
	CR1F265 or F2654		CR1F400 or F4004		LA9FJ4H	2.49 (1.130)
			CR1F500 or F5004		LA9FK4H	2.49 (1.130)
			CR1F630 or F6304		LA9FL4H	2.51 (1.140)
	CR1F400 or F4004		CR1F500 or F5004		LA9FK4J	2.64 (1.200)
			CR1F630 or F6304		LA9FL4J	2.66 (1.210)
CR1F500 or F5004		CR1F630 or F6304		LA9FL4K	2.66 (1.210)	
For assembly of 3 or 4-pole reversing contactors	Using 3 contactors (vertically mounted) of identical or different rating		Mechanical interlock kit catalog number ♦			
	The contactor ratings must be in descending order from top to bottom		LA9F•4•4•			

- A 3-pole reversing contactor for motor control can be converted into a 3-pole changeover contactor pair by removing the upper connecting links.
- All power connections to be made by the customer.
- ▲ With identical or different number of poles. Power connections to be made by the customer.
- ♦ Complete the catalog number by replacing the first dot with the code for the upper contactor, the second dot with the code for the middle contactor, and the third dot with the code for the lower contactor; see the table below for the codes for the contactors.

Contactors	CR1F150	CR1F185	CR1F265	CR1F400	CR1F500	CR1F630
Code	F	G	H	J	K	L

For example, mechanical interlock for reversing contactor made up of 3 different contactors: CR1F500 top, CR1F265 middle, and CR1F185 lower: LA9F•4•4• becomes LA9FK4H4G.

CR1F/CR1B Contactors and Accessories

Magnetic Latching Contactors – Coils for Contactors CR1F

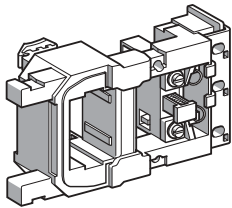

LX0FF009

Standard Coils

Usual voltages		Resistance of winding at 20 °C (68 °F)		Catalog Number	Voltage Code	Weight lb (kg)
50 to 400 Hz or DC	50 Hz, 60 Hz	Latching	Unlatching			
V	V	Ω	Ω			
For contactors CR1F150						
48	–	1.98	230.8	LX0FF005	E7	0.97 (0.440)
110	–	9.35	1453	LX0FF006	F7	0.97 (0.440)
127	–	11.61	1788	LX0FF007	G7	0.97 (0.440)
208	–	23.50	4098	LX0FF020	L7	0.97 (0.440)
220/230	–	37.55	5139	LX0FF008	M7	0.97 (0.440)
–	240	45.16	6544	LX0FF009	U7	0.97 (0.440)
–	380/400	114.10	12447	LX0FF010	Q7	0.97 (0.440)
–	415	139.50	16717	LX0FF011	N7	0.97 (0.440)
For contactors CR1F185						
48	–	1.42	220	LX0FG005	E7	1.23 (0.560)
110	–	6.92	1339	LX0FG006	F7	1.23 (0.560)
127	–	8.45	1676	LX0FG007	G7	1.23 (0.560)
208	–	21.30	3169	LX0FG020	L7	1.23 (0.560)
220/230	–	26.27	4729	LX0FG008	M7	1.23 (0.560)
–	240	32.95	4729	LX0FG009	U7	1.23 (0.560)
–	380/400	82.29	11885	LX0FG010	Q7	1.23 (0.560)
–	415	102.30	14305	LX0FG011	N7	1.23 (0.560)
For contactors CR1F265						
48	–	1.34	183.4	LX0FH005	E7	1.71 (0.780)
110	–	6.90	1031	LX0FH006	F7	1.71 (0.780)
127	–	8.56	1325	LX0FH007	G7	1.71 (0.780)
208	–	20.20	2654	LX0FH020	L7	1.71 (0.780)
220/230	–	25.77	4090	LX0FH008	M7	1.71 (0.780)
–	240	33.03	5002	LX0FH009	U7	1.71 (0.780)
–	380/400	78.39	11803	LX0FH010	Q7	1.71 (0.780)
–	415	102.9	15006	LX0FH011	N7	1.71 (0.780)
For contactors CR1F400						
48	–	1.32	90.5	LX0FJ005	E7	2.47 (1.120)
110	–	8.09	813	LX0FJ006	F7	2.47 (1.120)
127	–	9.79	1027	LX0FJ007	G7	2.47 (1.120)
208	–	24.40	2643	LX0FJ020	L7	2.47 (1.120)
220/230	–	30.14	3309	LX0FJ008	M7	2.47 (1.120)
–	240	37.02	4074	LX0FJ009	U7	2.47 (1.120)
–	380/400	94.80	9380	LX0FJ010	Q7	2.47 (1.120)
–	415	121.10	11 763	LX0FJ011	N7	2.47 (1.120)
For contactors CR1F500						
48	–	1.57	166	LX0FK005	E7	2.70 (1.220)
110	–	7.53	916	LX0FK006	F7	2.70 (1.220)
127	–	9.56	1159	LX0FK007	G7	2.70 (1.220)
208	–	23.60	2981	LX0FK020	L7	2.70 (1.220)
220/230	–	28.81	3733	LX0FK008	M7	2.70 (1.220)
–	240	35.67	4595	LX0FK009	U7	2.70 (1.220)
–	380/400	89.56	10 570	LX0FK010	Q7	2.70 (1.220)
–	415	112.06	13 256	LX0FK011	N7	2.70 (1.220)
For contactors CR1F630						
48	–	0.87	204	LX0FL005	E7	3.21 (1.460)
110	–	5.20	1423	LX0FL006	F7	3.21 (1.460)
127	–	6.45	1830	LX0FL007	G7	3.21 (1.460)
208	–	20.20	2961	LX0FL020	L7	3.21 (1.460)
220/230	–	25.36	4603	LX0FL008	M7	3.21 (1.460)
–	240	25.36	5658	LX0FL009	U7	3.21 (1.460)
–	380/400	60.95	10 676	LX0FL010	Q7	3.21 (1.460)
–	415	77.97	13 003	LX0FL011	N7	3.21 (1.460)

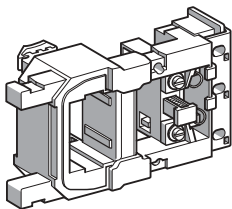

LX0FH009

CR1F/CR1B Contactors and Accessories

Magnetic Latching Contactors – Coils for Contactors CR1F

Special Coils

Coils with two windings with common point, allowing the use of two separate power sources for latching and unlatching.

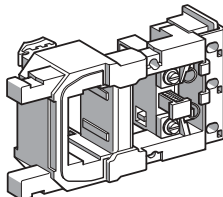

LX0FF020

For contactors	Coil voltages at 50 Hz, 60 Hz, 400 Hz or DC		Resistance of winding at $\theta = 20\text{ }^{\circ}\text{C}$ (68 $^{\circ}\text{F}$)		Catalog Number	Voltage code	Weight lb (kg)
	Latching	Unlatching	Latching	Unlatching			
	V	V	Ω	Ω			
CR1F150	220	24	29.5	39.5	LX0FF224	MB7	0.01 (0.440)
CR1F185	220	24	26.5	19	LX0FG224	MB7	0.02 (0.560)
CR1F265	220	24	26	29.5	LX0FH224	MB7	0.03 (0.780)
CR1F400	220	24	30	23	LX0FJ224	MB7	0.04 (1.120)
CR1F500	220	24	29	26	LX0FK224	MB7	0.05 (1.220)
CR1F630	220	24	26	41	LX0FL224	MB7	0.06 (1.460)

Coils with Low-Inrush Consumption

Usual voltages DC	Resistance of winding at $\theta = 20\text{ }^{\circ}\text{C}$ (68 $^{\circ}\text{F}$)		Catalog Number	Voltage code	Weight lb (kg)
	Latching	Unlatching			
	Ω	Ω			
For contactors CR1F150					
48	4.56	140.56	LX0FF055	EZ7	0.01 (0.440)
110	22.37	706.44	LX0FF056	FZ7	0.01 (0.440)
127	35.54	1086.36	LX0FF057	GZ7	0.01 (0.440)
220	89.85	3342.51	LX0FF058	MZ7	0.01 (0.440)
For contactors CR1F185					
48	5.19	106.54	LX0FG055	EZ7	0.02 (0.570)
110	25.50	536.26	LX0FG056	FZ7	0.02 (0.570)
127	32.75	732.64	LX0FG057	GZ7	0.02 (0.570)
220	102.44	2378.62	LX0FG058	MZ7	0.02 (0.570)
For contactors CR1F265					
48	5.19	74.26	LX0FH055	EZ7	0.03 (0.800)
110	25	364.61	LX0FH056	FZ7	0.03 (0.800)
127	30.98	458.45	LX0FH057	GZ7	0.03 (0.800)
220	97.89	1344.46	LX0FH058	MZ7	0.03 (0.800)
For contactors CR1F400					
48	5.05	36.36	LX0FJ055	EZ7	0.04 (1.150)
110	25.39	171.49	LX0FJ056	FZ7	0.04 (1.150)
127	31.86	221.20	LX0FJ057	GZ7	0.04 (1.150)
220	98.19	648.79	LX0FJ058	MZ7	0.04 (1.150)
For contactors CR1F500					
48	4.42	41	LX0FK055	EZ7	0.05 (1.270)
110	22.74	193.36	LX0FK056	FZ7	0.05 (1.270)
127	28.25	313.60	LX0FK057	GZ7	0.05 (1.270)
220	85.12	918.68	LX0FK058	MZ7	0.05 (1.270)
For contactors CR1F630					
48	3.94	59.17	LX0FL055	EZ7	0.06 (1.500)
110	19.36	365.33	LX0FL056	FZ7	0.06 (1.500)
127	25.39	452.27	LX0FL057	GZ7	0.06 (1.500)
220	74.44	1071.43	LX0FL058	MZ7	0.06 (1.500)

CR1F/CR1B Contactors and Accessories

Magnetic Latching Contactors – Coils for Contactors CR1B

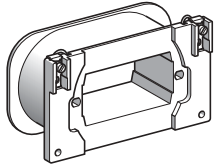

WB1KB...

Coils with "TC" Treatment ♦

Usual voltages		Resistance at $\theta = 20\text{ }^{\circ}\text{C}$ (68 °F)	Catalog Number	Weight lb (kg)
DC	AC 50 to 400 Hz			
V	V	Ω		
For contactors CR1B•31				
–	110 to 120	19.7	WB1KB140	2.47 (1.120)
110 to 125	–	25.2	WB1KB134	2.47 (1.120)
–	220 to 240	77.2	WB1KB136	2.47 (1.120)
220	–	94	WB1KB139	2.47 (1.120)
250	–	128	WB1KB125	2.47 (1.120)
–	380 to 400	197	WB1KB126	2.47 (1.120)
–	415 to 440	257	WB1KB138	2.47 (1.120)
For contactors CR1B•32				
–	110	9.6	WB1KB133	2.47 (1.120)
110	120 to 127	11.4	WB1KB121	2.47 (1.120)
125	–	19.7	WB1KB140	2.47 (1.120)
–	220/230	32.5	WB1KB124	2.47 (1.120)
220	240	49.7	WB1KB122	2.47 (1.120)
250	–	77.2	WB1KB136	2.47 (1.120)
–	380 to 400	128	WB1KB125	2.47 (1.120)
–	415 to 440	160	WB1KB137	2.47 (1.120)
For contactors CR1B•33				
–	110	7.2	WB1KB123	2.47 (1.120)
110	120 to 127	9.6	WB1KB133	2.47 (1.120)
125	–	11.4	WB1KB121	2.47 (1.120)
220	240	32.5	WB1KB124	2.47 (1.120)
250	–	61	WB1KB135	2.47 (1.120)
–	380 to 415	94	WB1KB139	2.47 (1.120)
–	440	128	WB1KB125	2.47 (1.120)
For contactors CR1B•34				
–	110	5.8	WB1KB132	2.47 (1.120)
110	120 to 127	7.2	WB1KB123	2.47 (1.120)
125	–	11.4	WB1KB121	2.47 (1.120)
–	220/230	25.2	WB1KB134	2.47 (1.120)
–	240	32.5	WB1KB124	2.47 (1.120)
250	–	49.7	WB1KB122	2.47 (1.120)
–	380	77.2	WB1KB136	2.47 (1.120)
–	400 to 440	94	WB1KB139	2.47 (1.120)

Coils with "TH" Treatment ▼

Add suffix TH to the above catalog numbers; for example, **WB1KB140TH**.

- ♦ "TC" treatment is standard environmental protection equivalent to tropicalization.
 - ▼ "TH" treatment is improved environmental protection equivalent to fungus-proof and insect-proof.
- See page 10 for additional information regarding protective treatments.

CR1F/CR1B Contactors and Accessories

Magnetic Latching Contactors – Coils for Contactors CR1B

Accessories for use with coils



DR2SC0220

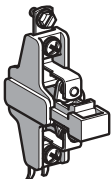

ZC4GM2

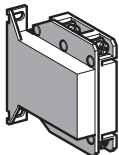

DR5TE1U

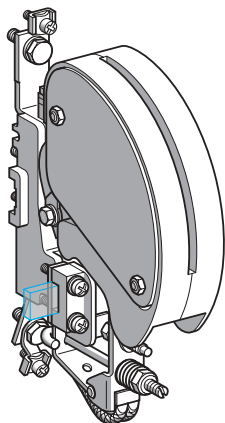

PR4FB0014

Coils ("TC" or "TH")	Additional resistors ■				Automatic coil cut-out contact ▲		Rectifier ♦
	R1	Catalog Number	R2	Catalog Number	No.	Catalog Number	Catalog Number
	Ω		Ω				
For contactors CR1B•31							
WB1KB140	68	DR2SC0068	47	DR2SC0047	2	ZC4GM2 or ZC4GM8	DR5TE1U
WB1KB134	68	DR2SC0068	68	DR2SC0068	2	ZC4GM2 or ZC4GM8	–
WB1KB136	220	DR2SC0220	180	DR2SC0180	2	ZC4GM2 or ZC4GM8	DR5TE1U
WB1KB139	270	DR2SC0270	220	DR2SC0220	2	ZC4GM2 or ZC4GM8	–
WB1KB125	330	DR2SC0330	270	DR2SC0270	3	ZC4GM2 or ZC4GM8	–
WB1KB126	470	DR2SC0470	470	DR2SC0470	3	ZC4GM2 or ZC4GM8	DR5TE1S
WB1KB138	1000	DR2SC1000	470	DR2SC0470	3	ZC4GM2 or ZC4GM8	DR5TE1S
For contactors CR1B•32							
WB1KB133	10	DR2SC0010	33	DR2SC0033	1	PR4FB0011	DR5TE1U
WB1KB121	47	DR2SC0047	39	DR2SC0039	1	PR4FB0010	DR5TE1U
WB1KB140	100	DR2SC0100	47	DR2SC0047	1	PR4FB0009	–
WB1KB124	120	DR2SC0120	120	DR2SC0120	1	PR4FB0007	DR5TE1U
WB1KB122	220	DR2SC0220	150	DR2SC0150	1	PR4FB0007	DR5TE1U
WB1KB136	330	DR2SC0330	220	DR2SC0220	1	PR4FB0006	–
WB1KB125	470	DR2SC0470	470	DR2SC0470	1	PR4FB0005	DR5TE1S
WB1KB137	680	DR2SC0680	560	DR2SC0560	1	PR4FB0004	DR5TE1S
For contactors CR1B•33							
WB1KB123	39	DR2SC0039	27	DR2SC0027	1	PR4FB0012	DR5TE1U
WB1KB133	47	DR2SC0047	39	DR2SC0039	1	PR4FB0011	DR5TE1U
WB1KB121	56	DR2SC0056	47	DR2SC0047	1	PR4FB0010	–
WB1KB124	180	DR2SC0180	120	DR2SC0120	1	PR4FB0008	DR5TE1U
WB1KB135	270	DR2SC0270	270	DR2SC0270	1	PR4FB0006	–
WB1KB139	470	DR2SC0470	390	DR2SC0390	1	PR4FB0005	DR5TE1S
WB1KB125	680	DR2SC0680	470	DR2SC0470	1	PR4FB0004	DR5TE1S
For contactors CR1B•34							
WB1KB132	33	DR2SC0033	27	DR2SC0027	1	PR4FB0014	DR5TE1U
WB1KB123	47	DR2SC0047	33	DR2SC0033	1	PR4FB0012	DR5TE1U
WB1KB121	56	DR2SC0056	56	DR2SC0056	1	PR4FB0010	–
WB1KB134	150	DR2SC0150	120	DR2SC0120	1	PR4FB0008	DR5TE1U
WB1KB124	180	DR2SC0180	150	DR2SC0150	1	PR4FB0007	DR5TE1U
WB1KB122	270	DR2SC0270	220	DR2SC0220	1	PR4FB0007	–
WB1KB136	390	DR2SC0390	390	DR2SC0390	1	PR4FB0006	DR5TE1S
WB1KB139	560	DR2SC0560	470	DR2SC0470	1	PR4FB0005	DR5TE1S

■ Weight of resistors DR2SC••••: 0.030 kg (0.07 lbs).

▲ Weight of automatic coil cut-out contacts: ZC4GM•: 0.030 kg (0.07 lbs) and PR4FB00••: 0.600 kg (1.32 lbs).

♦ Weight of rectifier DR5TE1•: 0.100 kg (0.22 lbs). The rectifier is for use on AC only.

CR1F/CR1B Contactors and Accessories

Magnetic Latching Contactors – Accessories and Replacement Parts

For Contactors CR1F

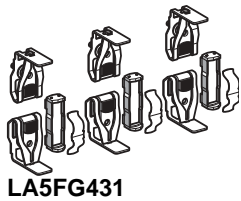

LA5FG431

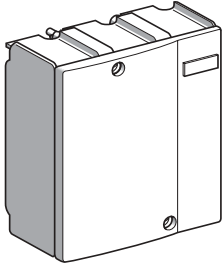

LA5F40050

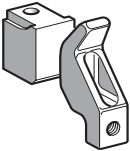

PA1LB80
(PALB76 + PA1LB75)

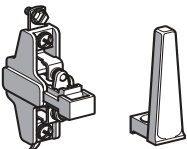

ZC4GM1 PA1LB89

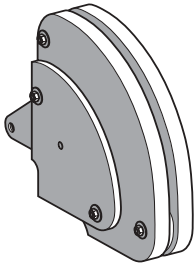

PA1LB50

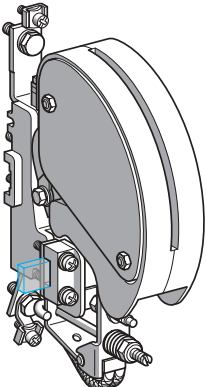

PR4FB00**

Description	For Contactors	Catalog Number	Weight lb (kg)			
Sets of contacts for 3 or 4 poles ♦	3-pole	CR1F150	LA5FF431	0.59 (0.270)		
		CR1F185	LA5FG431	0.77 (0.350)		
		CR1F265	LA5FH431	1.45 (0.660)		
		CR1F400	LA5F400803	1.45 (0.660)		
		CR1F500	LA5F500803	1.45 (0.660)		
		CR1F630	LA5F630803	1.45 (0.660)		
	4-pole	CR1F1504	LA5FF441	0.79 (0.360)		
		CR1F1854	LA5FG441	1.02 (0.465)		
		CR1F2654	LA5FH441	1.94 (0.880)		
		CR1F4004	LA5F400804	1.02 (0.465)		
		CR1F5004	LA5F500804	1.02 (0.465)		
		CR1F6304	LA5F630804	1.02 (0.465)		
		Arc chambers	3-pole	CR1F150	LA5F15050	1.08 (0.490)
				CR1F185	LA5F18550	1.47 (0.670)
CR1F265	LA5F26550			2.02 (0.920)		
CR1F400	LA5F40050			2.86 (1.300)		
CR1F500	LA5F50050			4.07 (1.850)		
4-pole	CR1F630		LA5F63050	6.94 (3.150)		
	CR1F1504		LA5F150450	1.45 (0.660)		
	CR1F1854		LA5F185450	2.00 (0.910)		
	CR1F2654		LA5F265450	2.68 (1.220)		
	CR1F4004		LA5F400450	3.83 (1.740)		
CR1F5004	LA5F500450	5.51 (2.500)				
CR1F6304	LA5F630450	9.25 (4.200)				

♦ Set containing the following (per pole): 2 fixed contacts, 1 moving contact, 2 deflectors, 1 back-plate, clamping screws and washers.

For Contactors CR1B

Description	For contactors	Number of sets required per pole	Unit catalog Number of set	Weight lb (kg)
Set of contacts (1 moving contact, 1 fixed contact)	CR1BL	1	PA1LB80	0.92 (0.420)
	CR1BM	1	PA1LB80	0.92 (0.420)
	CR1BP	2	PA1LB80	0.92 (0.420)
	CR1BR	3	PA1LB80	0.92 (0.420)

Description	For contactors	Composition	Catalog Number	Weight lb (kg)
Moving contact only (for one finger)	All ratings	–	PA1LB75	0.48 (0.220)
Fixed contact only (for one finger)	All ratings	–	PA1LB76	0.44 (0.200)
Blow-out horn only (for one finger)	All ratings	–	PA1LB89	0.26 (0.120)
Arc chambers (for a single pole)	CR1BL	–	PA1LB50	8.15 (3.700)
	CR1BM	–	PA1LB50	8.15 (3.700)
	CR1BP	–	PA1PB50	13.6 (6.200)
	CR1BR	–	PA1RB50	18.7 (8.500)
Auxiliary contact blocks	All ratings	1 N.O. contact normal	ZC4GM1	0.06 (0.030)
	All ratings	1 N.C. contact normal	ZC4GM2	0.06 (0.030)
	All ratings	1 N.O. contact gold flashed	ZC4GM9	0.06 (0.030)
	All ratings	1 N.C. contact gold flashed	ZC4GM8	0.06 (0.030)
N.C. pole for automatic cut-out coil	All ratings	–	PR4FB00** ■	1.32 (0.600)
Set of moving and fixed contacts for N.C. pole	All ratings	–	PV1FA80	0.07 (0.035)
Arc chamber for N.C. pole	All ratings	–	PN1FB50	0.48 (0.220)
Electromagnet	All ratings	–	ET1KB50	23.3 (10.600)

Description	For contactors	No. of parts required	Catalog number	Weight lb (kg)
Return springs for moving part of electromagnet	CR1B (1 pole)	1	DV1RT292	0.11 (0.050)
	CR1B (2, 3 or 4 poles)	2	DV1RT292	0.11 (0.050)
N.O. pole springs	CR1BL, BM or BP	1 per pole	DV1RC201	0.04 (0.020)
	CR1BR	1 per pole	DV1RC155	0.04 (0.020)

■ Select complete catalog number from page 259.

CR1F/CR1B Contactors and Accessories

Magnetic Latching Contactors Type CR1F – Dimensions

Dimensions shown in millimeters (mm x .0394 = inches)

CR1F150 to CR1F500

Common side view

CR1F150, CR1F185, CR1F265

CR1F400, CR1F500

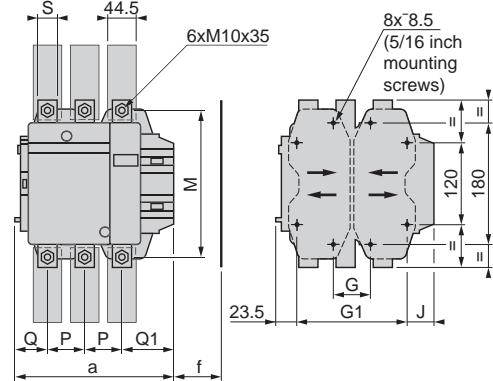
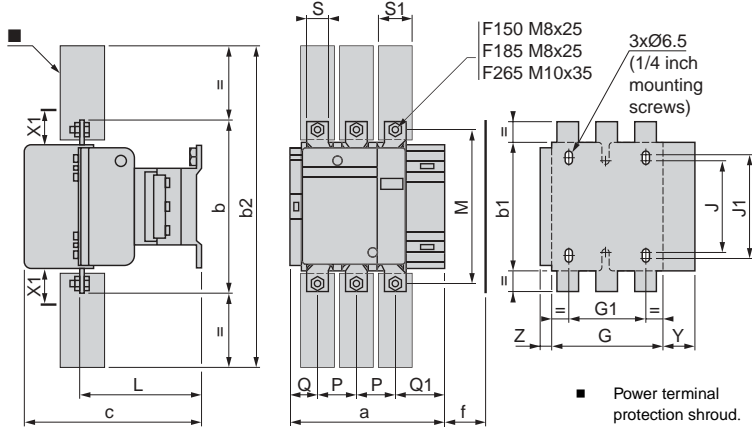

	CR1F150		CR1F185		CR1F265	
	3 Pole	4 Pole	3 Pole	4 Pole	3 Pole	4 Pole
a	163.5	201.5	168.5	208.5	201.5	244.5
b	170	170	174	174	203	203
b1	137	137	137	137	145	145
b2	301	301	305	305	370	370
c	171	171	181	181	213	213
f	131	131	130	130	147	147
G	106	143	111	151	142	190
G1	80	80	80	80	96	96
J	106	106	106	106	106	106
J1	120	120	120	120	120	120
L	107	107	113.5	113.5	141	141
M	150	150	154	154	178	178
P	40	40	40	40	48	48
Q	26	26	29	29	39	34
Q1	57.5	55.5	59.5	59.5	66.5	66.5
S	20	20	20	20	25	25
S1	27	27	34	34	38	38
Y	44	44	38.5	30.5	30.5	21.5
Z	13.5	13.5	13.5	13.5	15.5	15.5

f = minimum distance required for coil removal

X1: Minimum electrical clearance according to operational voltage and breaking capacity

Voltage in V	200 to 500		660 to 1000	
	CR1F150	CR1F185	CR1F265	CR1F500
CR1F150	10	15	15	20
CR1F185	10	15	15	20
CR1F265	10	15	15	20

	CR1F400		CR1F500	
	3 Pole	4 Pole	3 Pole	4 Pole
a	213	261	233	288
b	206	206	238	238
b2	375	375	400	400
c	219	219	232	232
f	146	146	150	150
G supplied	80	80	80	140
G max	102	150	120	175
G1 supplied	170	170	170	230
G1 min	156	156	156	156
G1 max	192	240	210	265
J1	12	60	32	27
L	145	145	146	146
M	181	181	208	208
P	48	48	55	55
Q	43	43	47	47
Q1	74	74	77	77
S	25	25	30	30

f = minimum distance required for coil removal

X1: Minimum electrical clearance according to operational voltage and breaking capacity

Voltage in V	200 to 500		660 to 1000	
	CR1F400	CR1F500	CR1F500	CR1F500
CR1F400	15	20	20	20
CR1F500	15	20	20	20

CR1F630

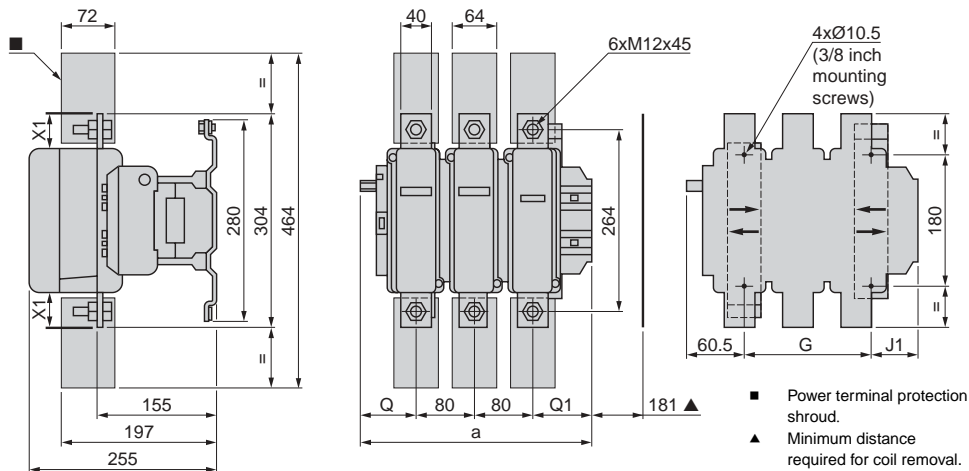

	CR1F630	
	3 P	4 P
a	309	389
G supplied	180	240
G min	100	150
G max	195	275
J1	61	81
Q	60	60
Q1	89	89

X1: Minimum electrical clearance according to operational voltage and breaking capacity

Voltage in V	X1	
	200 to 500	690 to 1000
200 to 500	20	30
690 to 1000	20	30

CR1F/CR1B Contactors and Accessories

Magnetic Latching Contactors Type CR1F – Mounting

Dimensions shown in millimeters (mm x.0394 = inches)

CR1F150 to F265

On panel

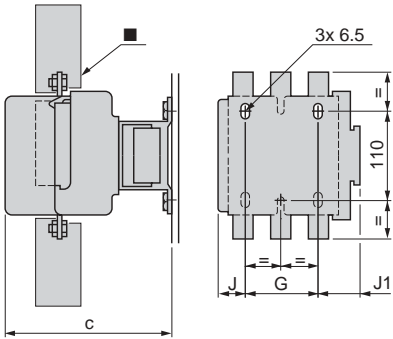

On pre-slotted mounting plate **AM1PA, AM1PB, AM1PC**

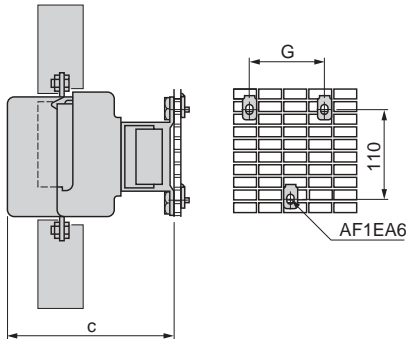

On rails **DZ5MB** at 120 mm mounting center

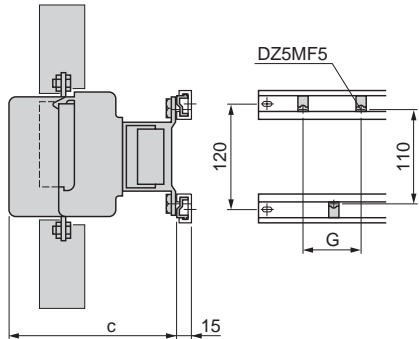

■ Power terminal protection shroud.

		CR1F150	CR1F185	CR1F265
c	3P	171	181	213
	4P	171	181	213
G	3P	80	80	96
	4P	80	80	96
J	3P	26.5	29	44.5
	4P	45	49	68.5
J1	3P	57	59.5	61.5
	4P	75.5	79.5	85.5

		CR1F150	CR1F185	CR1F265
c	3P	171	181	213
	4P	171	181	213
G	3P	80	80	96
	4P	80	80	96

		CR1F150	CR1F185	CR1F265
c	3P	171	181	213
	4P	171	181	213
G	3P	80	80	96
	4P	80	80	96

CR1F150 to F650

On 2 notched uprights **AM1EC...**

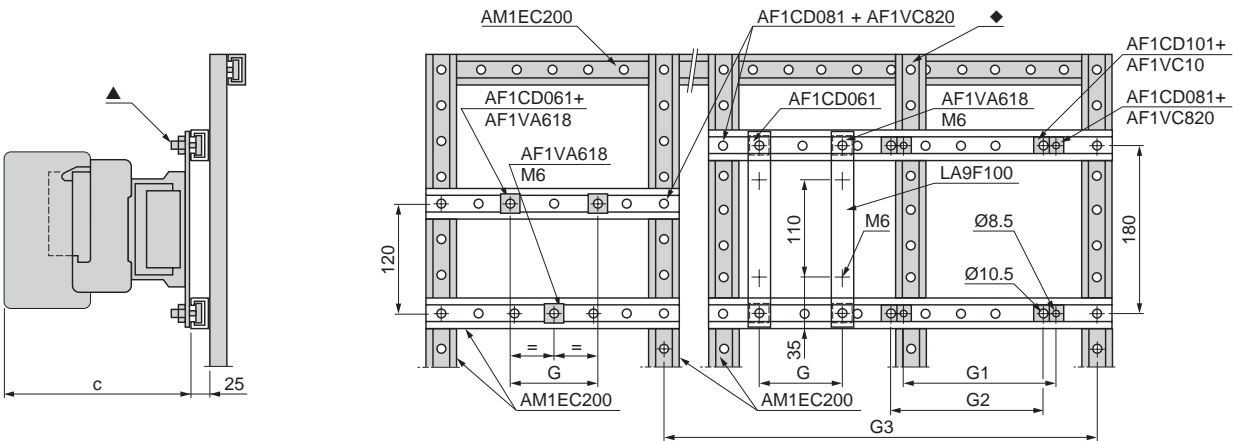

▲ AF1CD... or AF1VA...

◆ This upright **AM1EC200** is required when G2 or G3 is greater than 700 mm.

		CR1F150	CR1F185	CR1F265	CR1F400	CR1F500	CR1F630
c	3P	171	181	213	213	226	250
	4P	171	181	213	213	226	250
G (M6)	3P	80	80	96	-	-	-
	4P	80	80	96	-	-	-
G1 (Ø 8.5)	3P	-	-	-	80	80	-
	4P	-	-	-	80	140	-
G2 (Ø 10.5)	3P	-	-	-	-	-	180
	4P	-	-	-	-	-	240

CR1F/CR1B Contactors and Accessories

Magnetic Latching Contactors Type CR1F – Mounting

Dimensions shown in millimeters (mm x .0394 = inches)

Reversing contactors
2 x CR1F150 to CR1F265
Horizontally mounted

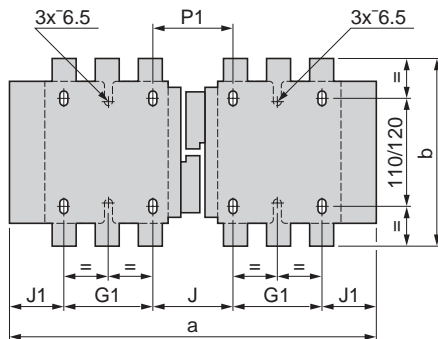

Reversing contactors
2 x CR1F400 to CR1F630

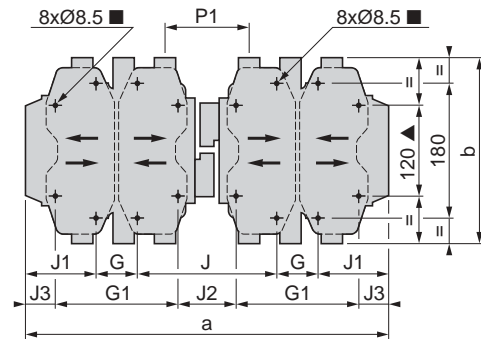

■ Except F630: 4 x Ø 10.5.
▲ Except F630.

2 x CR1-		a	b	G	J	J1	P1
F150	3P	345	170	80	71	57	71
	4P	422	170	80	111	75.5	71
F185	3P	357	174	80	78	59.5	78
	4P	437	174	80	118	79.5	78
F265	3P	425	203	96	109	61.5	100
	4P	521	203	96	157	85.5	100

2 x CR1-		a	b	G	G1	J	J1	J2	J3	P1
F400	3P	446	206	80	170	157	64.5	67	19.5	107
	4P	542	206	80	170	157	112.5	67	67.5	107
F500	3P	485	238	80	170	156	84.5	66	39.5	112
	4P	595	238	140	230	156	79.5	66	34.5	112
F630	3P	636	304	180	-	139	68.5	-	-	137
	4P	796	304	240	-	139	88.5	-	-	137

CR1F/CR1B Contactors and Accessories

Magnetic Latching Contactors Type CR1F – Mounting

Dimensions shown in millimeters (mm x .0394 = inches)

Changeover contactor pairs

Vertically mounted with mechanical interlock LA9F***

2 contactors CR1F of identical or different ratings (CR1F150 to CR1F630), see page 240.

Assembly A

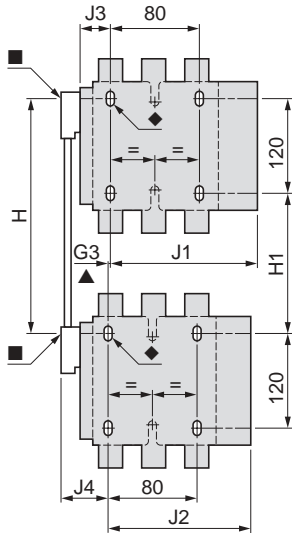

Assembly B

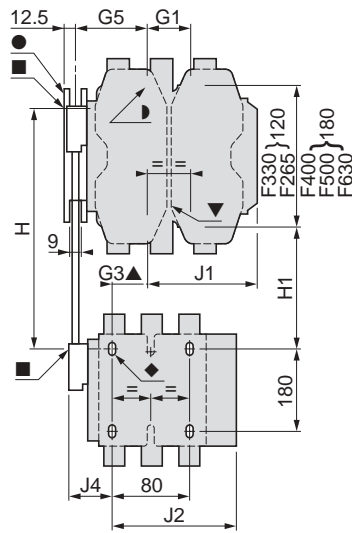

Assembly C

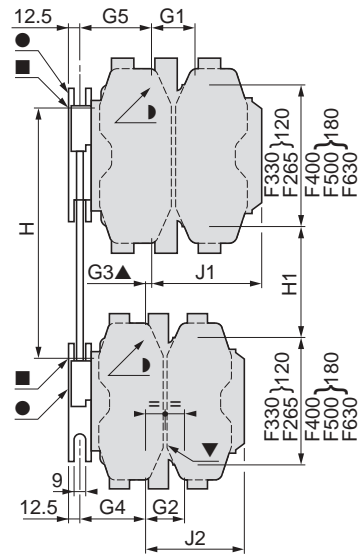

- Mechanical interlock shaft.
- ▲ For assembly of contactors with different ratings only.
- ◆ 3 x Ø 6.5 mm for CR1F150 to F265.
- ▼ 3 x Ø 6.5 mm for CR1F265.
- Mechanical interlock guide bracket.
- 4 x Ø 8.5 mm for CR1F400, F500 or 4 x Ø 10.5 mm.

Assembly Type	A			B								C									
	FF4F	FG4F	FG4G	FH4F	FJ4F	FK4F	FL4F	FH4G	FJ4G	FK4G	FL4G	FH4H	FJ4H	FK4H	FL4H	FJ4J	FK4J	FL4J	FK4K	FL4K	FL4L
LA9-	3P	-	-	96	80	80	180	96	80	80	180	96	80	80	180	80	80	180	80	180	180
	4P	-	-	96	80	140	240	96	80	140	240	96	80	140	240	80	140	240	140	240	240
G1	3P	-	-	-	-	-	-	-	-	-	-	60	60	60	60	83	83	83	83	83	74
	4P	-	-	-	-	-	-	-	-	-	-	83	83	83	83	83	83	83	83	83	74
G2	3P	-	-	-	-	-	-	-	-	-	-	60	83	83	74	83	83	74	83	74	74
	4P	-	-	-	-	-	-	-	-	-	-	83	83	83	74	83	83	74	83	74	74
G3	3P	0	3	21	45	45	35	19	42	42	33	250	250	270	310	250	250	270	310	310	380
	4P	0	4	27	26	26	17	23	22	22	13	380	380	380	380	380	380	380	380	380	380
G4	3P	-	-	-	-	-	-	-	-	-	-	110	80	100	140	120	90	110	150	150	130
	4P	-	-	-	-	-	-	-	-	-	-	250	210	210	210	250	220	220	220	220	260
G5	3P	-	-	60	83	83	74	60	83	83	74	130	110	130	170	60	100	140	120	160	200
	4P	-	-	83	83	83	74	83	83	83	74	260	230	230	220	200	200	195	200	195	200
H	min	200	210	240	250	270	310	250	250	270	310	380	380	380	380	380	380	380	380	380	380
	max	310	300	310	380	380	380	380	380	380	380	130	110	130	170	60	100	140	120	160	200
H1	min	80	90	100	110	80	100	140	120	90	150	260	230	230	220	200	200	195	200	195	200
	max	190	180	190	250	210	210	210	250	220	220	149.5	137	157	24	137	157	241	157	244	241
J1	3P	133	134	134	149.5	137	157	241	149.5	137	157	149.5	137	157	24	137	157	241	157	244	241
	4P	145	146	146	164.5	185	212	321	164.5	185	212	164.5	185	212	321	185	212	321	212	321	321
J2	3P	133	133	134	183	133	183	133	134	134	134	142.5	149.5	149.5	149.5	137	137	137	157	157	241
	4P	145	145	146	145	145	145	145	146	146	146	164.5	164.5	164.5	164.5	185	185	185	212	212	312
J3	3P	48.5	53	53	-	-	-	-	-	-	-	-	-	-	-	-	-	-	-	-	-
	4P	67	73	73	-	-	-	-	-	-	-	-	-	-	-	-	-	-	-	-	-
J4	3P	48.5	54	53	48.5	48.5	48.5	48.5	53	53	53	-	-	-	-	-	-	-	-	-	-
	4P	67	69	73	67	67	67	67	73	73	73	-	-	-	-	-	-	-	-	-	-

* In this case G4 is larger than G5.

CR1F/CR1B Contactors and Accessories

Magnetic Latching Contactors Type CR1F – Mounting

Dimensions shown in millimeters (mm x .0394 = inches)

Common side view

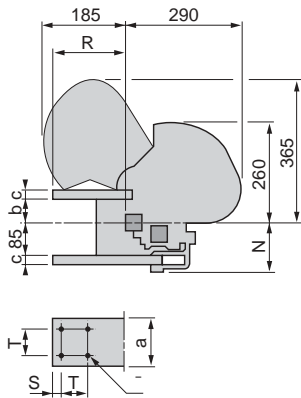

Single-pole, 2-pole, or 3-pole contactors

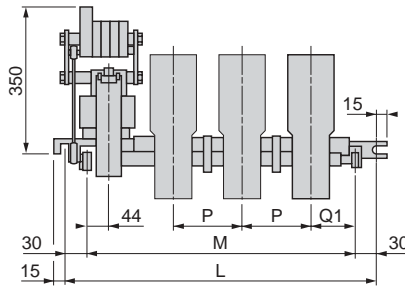

4-pole contactors

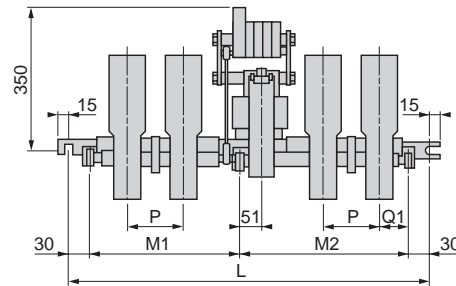

Number of poles	CR1BL				CR1BM				CR1BP				CR1BR			
	1	2	3	4	1	2	3	4	1	2	3	4	1	2	3	4
a	50	50	50	50	63	63	63	63	100	100	100	100	125	125	125	125
b	59	59	59	59	55	55	55	55	55	55	55	55	50	50	50	50
c	16	16	16	16	20	20	20	20	20	20	20	20	25	25	25	25
L	345	445	540	760	345	445	540	760	385	540	760	1065	445	635	885	1065
M	285	385	480	–	285	385	480	–	325	480	700	–	385	575	825	–
M1	–	–	–	308	–	–	–	308	–	–	–	455	–	–	–	455
M2	–	–	–	392	–	–	–	392	–	–	–	550	–	–	–	550
N	121	121	121	121	125	125	125	125	125	125	125	125	130	130	130	130
P	100	100	100	100	100	100	100	100	150	150	150	150	195	195	195	195
Q1	100	100	100	100	100	100	100	100	110	110	110	110	123	123	123	123
R	122	122	122	122	157	157	157	157	173	173	173	173	173	173	173	173
S	10	10	10	10	17	17	17	17	20	20	20	20	20	20	20	20
T	30	30	30	30	30	30	30	30	60	60	60	60	60	60	60	60
Ø	9	9	9	9	11	11	11	11	11	11	11	11	11	11	11	11

Electrical safety clearance

Values X1 and X2 are given for a breaking capacity of 10 In (3-phase AC current).

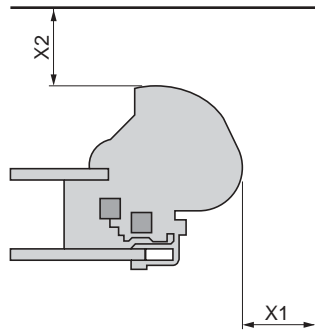

3-phase AC voltage		CR1BL	CR1BM	CR1BP	CR1BR
380-415-440 V	X1	100	100	150	200
	X2	150	150	200	250
500 V	X1	100	100	150	200
	X2	150	150	220	250
600 V	X1	150	150	200	200
	X2	200	200	250	250
1000 V	X1	200	200	200	250
	X2	250	250	250	300

Mechanical interlock

for assembly of vertically mounted reversing contactors

EZ2LB0601

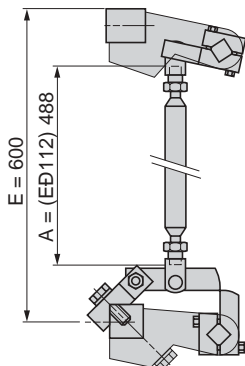

CR1F/CR1B Contactors and Accessories

Magnetic Latching Contactors Type CR1B – Adjustment Characteristics

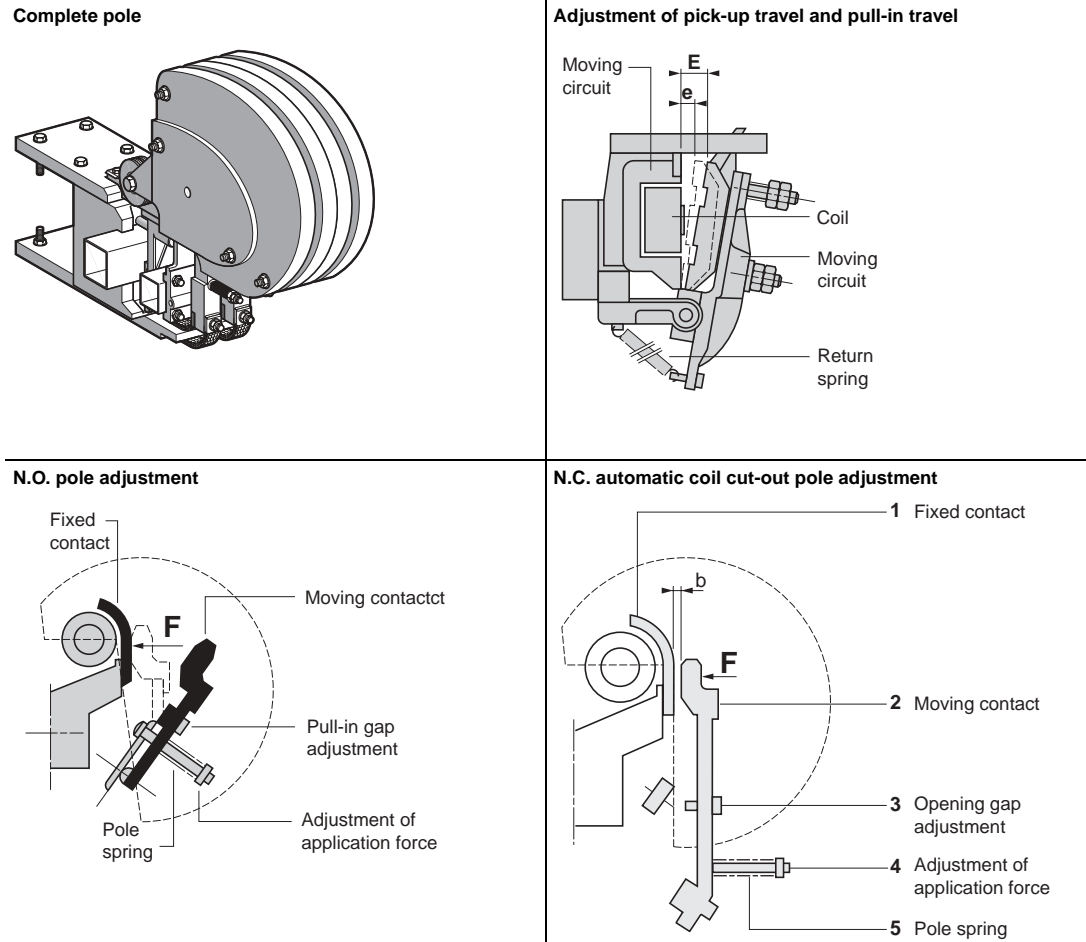

AC or DC supply with economy resistor (and rectifier on AC supply)

Contactor Type			CR1BL	CR1BM	CR1BP	CR1BR
Electromagnet (EB5KB50)	Pick-up travel (E)	mm ♦	30	30	30	30
	Pull-in travel (e)	mm ♦	10	10	10	10
Coil WB1KB	Pull-in voltage	V	0.75 Vc	0.75 Vc	0.75 Vc	–
	Drop-out voltage	V	0.3 to 0.5	0.3 to 0.5	0.3 to 0.5	0.3 to 0.5
N.O. power pole (PA1)	Application force (F) to contact per pole	daN / lb	30/67	30/67	30/67 ■	30/67 ▲
N.C. automatic coil cut-out pole (PR4)	Application force (F)	daN / lb	0.9/2	0.9/2	0.9/2	0.9/2
	Opening gap (b) with electromagnet closed	mm ♦	3.5 ± 0.5	3.5 ± 0.5	3.5 ± 0.5	3.5 ± 0.5

- ♦ millimeters x 0.394 = inches.
- Each pole has 2 contacts: the force must be applied evenly to each of these contacts.
- ▲ Each pole has 3 contacts: the force must be applied evenly to each of these contacts.

CR1F/CR1B Contactors and Accessories

Magnetic Latching Contactors Type CR1F – Schematics

Contactors Type CR1F

3-pole CR1F••33

4-pole CR1F••34

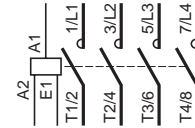
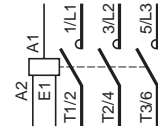

Front mounting add-on contact blocks - Instantaneous auxiliary contacts (References: pages 16 and 17)

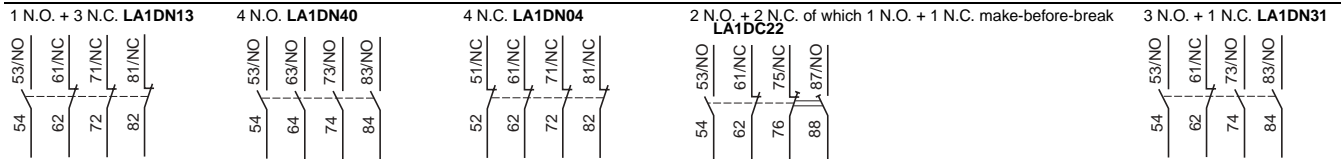
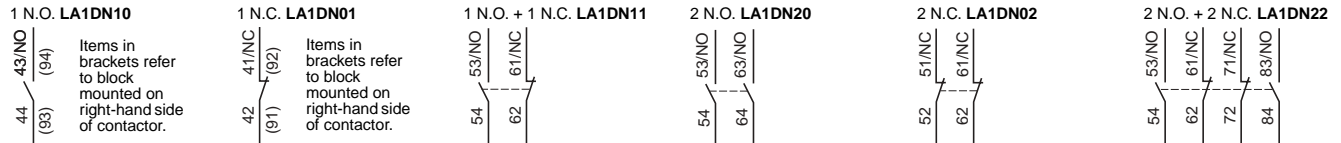

Front mounting add-on contact blocks - Instantaneous auxiliary contacts conforming to standard EN 50012 (References: pages 218 to 219)

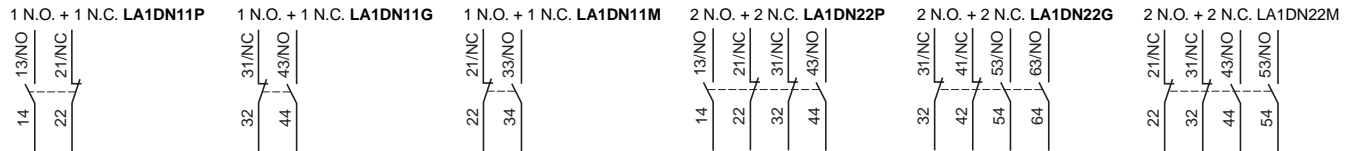

Front mounting add-on contact blocks - Dust and damp protected instantaneous auxiliary contacts (References: pages 218 to 219)

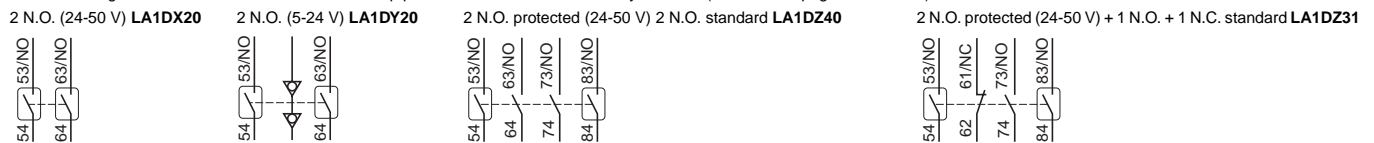

Front mounting add-on contact blocks - Time delay auxiliary contacts (References: pages 218 to 219)

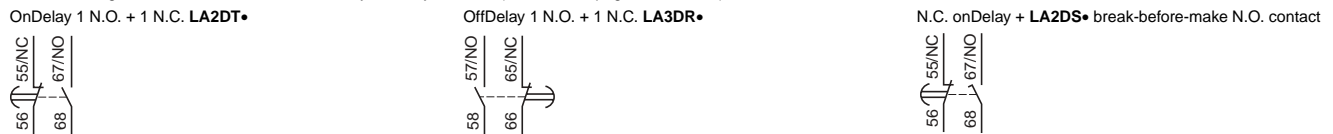

3-pole reversing contactors 2 x CR1F150 to CR1F630

4-pole reversing contactors 2 x CR1F1504 to CR1F6304

Horizontally mounted

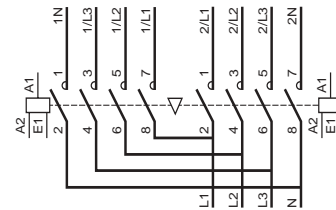
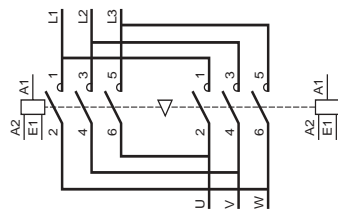

Vertically mounted contactors using 2 contactors of identical or different rating

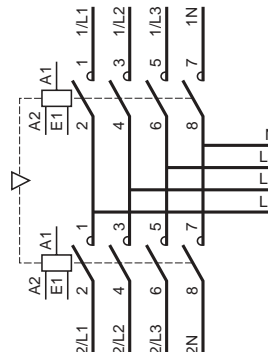
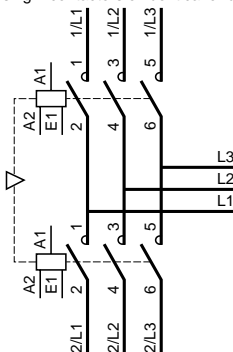

CR1F/CR1B Contactors and Accessories

Magnetic Latching Contactors Type CR1F – Schematics

Contactors Type CR1B

CR1B•31•12



CR1B•31•21

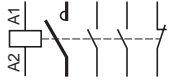

CR1B•31•30

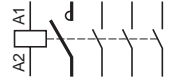

CR1B•32•12

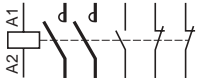

CR1B•32•21

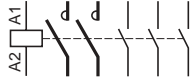

CR1B•32•30

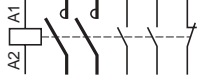

CR1B•33•12

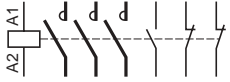

CR1B•33•21

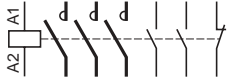

CR1B•33•30

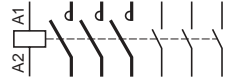

CR1B•34•12

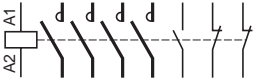

CR1B•34•21

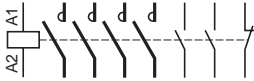

CR1B•34•30



Wiring schematics

Contactors CR1F and CR1B with thermal overload relay

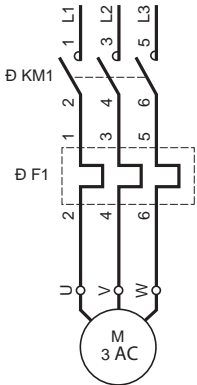

Contactors CR1F

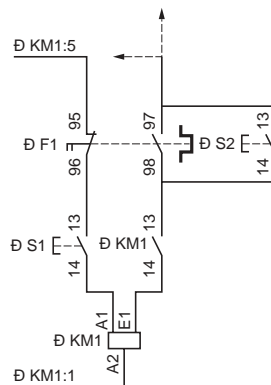

Contactors CR1B

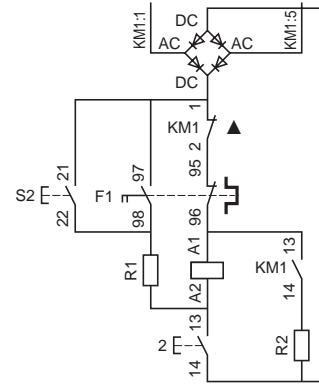

▲: automatic coil cut-out contact ZC4GM or PR4FB00••
 S1: latching pushbutton
 S2: unlatching pushbutton

Coils for contactors CR1F

Pushbutton control

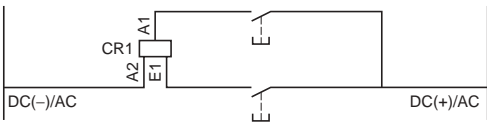

Switch control

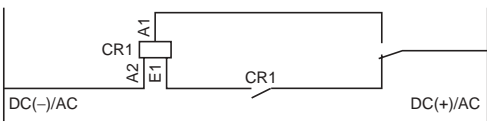

Schematic of internal circuit

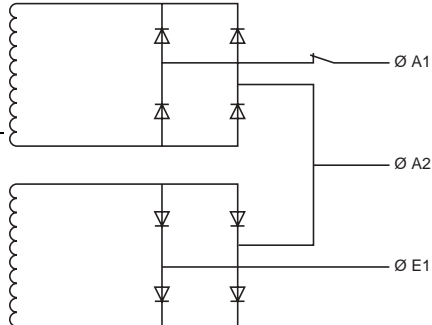

Warning: terminal A2 is common to both windings in all cases.

A		DZ3HA3	196	LA4DE3U	112	LA6DK10	108
AB1G	56, 72	DZ3JA3	196	LAD4RCU	112	LA6DK20	108
AB1R	56, 72	DZF2FX1	198	LAD4RCE	112	LA7D03	137, 221
AM1DP200	56, 72	E		LAD4TB	112	LA7D1020	137, 221
AM1ED200	56, 72	ET1KB50	238	LAD4TS	112	LA7D1064	137
C		EZ2LB0601	231	LAD4VE	112	LA7D2064	137
CR1BL31	230	G		LAD4VG	112	LA7D305	137, 221
CR1BL32	230	GV1G09	114	LAD4VU	112	LA7D3064	137
CR1BL33	230	GV2G245	114	LA4DFBQ	111	LA7D3058	137
CR1BL34	230	GV2G445	114	LA4DFB	111	LA7D901	137, 221
CR1BM31	230	GV2ME01	177	LA4DFE	111	LA7D902	137
CR1BM32	230	GV2ME02	177	LA4DLB	111	LA7D903	137, 221
CR1BM33	230	GV2ME03	177	LA4DLE	111	LA7F401	197, 221
CR1BM34	230	GV2ME04	177	LA4DMK	111	LA7F402	197, 221
CR1BP31	230	GV2ME05	177	LA4DMU	111	LA7F403	197, 221
CR1BP32	230	GV2ME06	177	LA4DT0U	111	LA7F404	197, 221
CR1BP33	230	GV2ME07	177	LA4DT2U	111	LA7F405	197, 221
CR1BP34	230	GV2ME08	177	LA4DT4U	111	LA7F406	197, 221
CR1BR31	230	GV2ME10	177	LA4DWB	111	LA7F407	221
CR1BR32	230	GV2ME14	177	LA4FRCE	196	LA7F701	221
CR1BR33	230	GV2ME16	177	LA4FRCF	196	LA7F702	221
CR1BR34	230	GV2ME20	177	LA4FRCP	196	LA7F703	221
CR1F150	230	GV2ME21	177	LA4FRCV	196	LA7F901	221
CR1F1504	230	GV2ME22	177	LA4FRVE	196	LA7F902	221
CR1F185	230, 233	GV2ME32	177	LA4FRVF	196	LA7K0064	63
CR1F1854	230, 233	GV3A01	177	LA4FRVP	196	LA9AADIS3	155
CR1F265	230, 233	GV3A02	177	LA4FRVV	196	LA9AADIS4	155
CR1F2654	230, 233	GV3A03	177	LA4FTE	196	LA9AADIS5	155
CR1F400	230, 233	GV3A05	177	LA4FTF	196	LA9AADIS7	155
CR1F4004	230, 233	GV3A06	177	LA4FTP	196	LA9B103	231
CR1F500	230, 233	GV3A08	177	LA4FTV	196	LA9CA06DT	155
CR1F5004	230, 233	GV3A09	177	LA4FDE	196	LA9CA06ET	155
CR1F630	230, 233	GV3A7	177	LA4FDF	196	LA9CA06FT	155
CR1F6304	230, 233	GV3ME06	177	LA4FDP	196	LA9CA06GT	155
D		L		LA4FDV	196	LA9CA06HT	155
DE1DS1	166	LA	231	LA4KA1U	56	LA9CA06IO	155
DE1DS1A04	166	LA1D	231	LA4KC1B	56	LA9CA06JT	155
DE1DS1A05	166	LA1DN11G	176	LA4KC1E	56	LA9CA06LT	155
DE1DS1A13	166	LA1DX02	107	LA4KE1B	56	LA9CA06NT	155
DE1DS2	166	LA1DX20	107, 195, 216, 245	LA4KE1E	56	LA9CA06ST	155
DE1DS2A04	166	LA1DY20	107, 195, 216, 245	LA4KE1FC	56	LA9CA06T	155
DE1DS2A05	166	LA1DZ31	107, 195, 216, 245	LA4KE1UG	56	LA9CA06VT	155
DE1DS2A13	166	LA1DZ40	107, 195, 216, 245	LA4SPX	108	LA9CA06WT	155
DR2SC0010	237	LA1KN02	55, 72	LA5D1158031	114	LA9CA16ST	155
DR2SC0027	237	LA1KN023	55, 72	LA5D115803	114	LA9CA16T	155
DR2SC0033	237	LA1KN027	55, 72	LA5D115804	114	LA9CA16VT	155
DR2SC0039	209, 237	LA1KN02M	55, 72	LA5D11550	114	LA9CA16WT	155
DR2SC0047	209, 237	LA1KN04	55	LA5D15050B	114	LA9D09907	160
DR2SC0056	237	LA1KN043	55	LA5D115450B	114	LA9D09966	113
DR2SC0068	237	LA1KN047	55	LA5F115450	199	LA9D09980	196
DR2SC0100	237	LA1KN11	55, 72	LA5F11550	199	LA9D09981	196
DR2SC0120	237	LA1KN113	55, 72	LA5F150450	199, 238	LA9D91	137
DR2SC0150	237	LA1KN117	55, 72	LA5F15050	199, 238	LA9D11502	98
DR2SC0180	237	LA1KN11M	55, 72	LA5F185450	199, 238	LA9D115503B	113
DR2SC0220	209, 237	LA1KN11P	55, 72	LA5F18550	199, 238	LA9D115504	113
DR2SC0270	209, 237	LA1KN13	55	LA5F225450	199	LA9D115603B	113
DR2SC0330	209, 237	LA1KN133	55	LA5F22550	199	LA9D115604	113
DR2SC0390	209, 237	LA1KN137	55	LA5F265450	199, 238	LA9D115703	113
DR2SC0470	237	LA1KN13M	55	LA5F26550	199, 238	LA9D11569	98
DR2SC0560	237	LA1KN20	55, 72	LA5F330450	199	LA9D115704	113
DR2SC0680	237	LA1KN203	55, 72	LA5F33050	199	LA9D1260	113
DR2SC1000	209, 237	LA1KN207	55, 72	LA5F400250	199	LA9D1261	113
DR2SC1200	209	LA1KN22	55	LA5F400450	199, 238	LA9D1263	113
DR2SC3300	209	LA1KN223	55	LA5F40050	199, 238	LA9D12974	149
DR2SC3900	209	LA1KN227	55	LA5F400802	199	LA9D2561	113
DR2SC4700	209	LA1KN22M	55	LA5F400803	199, 238	LA9D11569	98
DR5TE1S	237	LA1KN22P	55	LA5F400804	199, 238	LA9D3260	113
DR5TE1U	237	LA1KN31	55	LA5F500250	199	LA9D32974	149
DV1RC155	238	LA1KN313	55	LA5F500450	199, 238	LA9D4002	98
DV1RC201	238	LA1KN317	55	LA5F50050	199, 238	LA9D40961	113
DV1RT292	238	LA1KN31M	55	LA5F500802	199	LA9D40963	113
DX1AP25	56, 72, 134, 137	LA1KN40	55	LA5F500803	199, 238	LA9D4017	149
DX1AP26	134	LA1KN403	55	LA5F500804	199, 238	LA9D40961	113
DZ2FF1	198, 220	LA1KN407	55	LA5F630250	199	LA9D40963	113
DZ2FF6	198	LA2KT2E	55, 72	LA5F630450	199, 238	LA9D40973	149
DZ2FG1	198	LA2KT2U	55, 72	LA5F63050	199, 238	LA9D5017	149
DZ2FG6	198, 220	LA4DA2E	112	LA5F630802	199	LA9D50978	98
DZ2FH1	198, 220	LA4DA2G	112	LA5F630803	199, 238	LA9D511	114
DZ2FH6	198, 220	LA4DA2U	112	LA5F630804	199, 238	LA9D6567	113
DZ2FJ1	198, 220	LA4DA2N	112	LA5F780150	199	LA9D6569	98
DZ2FJ6	198	LA4DB2B	112	LA5F780801	199	LA9D730	114
DZ2FK1	198, 220	LA4DB2S	112	LA5F780803	199	LA9D8002	98
DZ2FK6	198	LA4DB3B	112	LA5F780804	199	LA9D8017	149
DZ2FL	198	LA4DB3S	112	LA5F80050	199	LA9D8067	113
DZ2FL1	220	LA4DC1U	112	LA5F800803	199	LA9D8069	98
DZ2FL2	220	LA4DC3U	112	LA5FF431	199, 238	LA9D80961	113
DZ2FL3	220	LA4DE2E	112	LA5FF441	199, 238	LA9D80962	113
DZ2FL6	198	LA4DE2G	112	LA5FG431	199, 238	LA9D80963	113
DZ2FX6	198	LA4DE2U	112	LA5FG441	199, 238	LA9D80973	149
DZ3FA3	196	LA4DE3E	112	LA5FH431	199, 238	LA9D80978	98
DZ3GA3	196	LA4DE3G	112	LA5FH441	199, 238	LA9D90	56, 72

Catalog Number Index

LA9D901	114	LA9FL980	197	LC1D12	88, 91, 149, 175, 176	LC1F630	188, 189
LA9D92	114	LA9FL981	197	LC1D123	89, 91	LC1F6302	188, 189
LA9D93	114	LA9FL982	191	LC1D126	90, 92, 175	LC1F6304	188, 189
LA9D941	114	LA9FX970	191	LC1D128	91, 175	LC1F780	188, 189
LA9D973	56, 72	LA9FX971u	193	LC1D1283	91	LC1F7804	188, 189
LA9D9PVG	98	LA9K0969	56, 72	LC1D1286	92	LC1F800	188, 189
LA9E01	56, 72	LA9K0970	56, 72	LC1D129	175	LC1K0601	43
LA9E02	56, 72	LA9P5152	114	LC1D150	88, 91, 149, 175	LC1K06013	43
LA9F	233	LA9TD32	155	LC1D1506	90, 92, 175	LC1K06015	43
LA9F103	137, 198, 231	LA9TD80	155	LC1D18	88, 91, 149, 175, 176	LC1K06017	43
LA9F15076	191	LAD21	114	LC1D183	89, 91	LC1K0610	43
LA9F15077	193	LAD22	114	LC1D186	90, 92, 175	LC1K06103	43
LA9F15082	191	LAD23	114	LC1D25	88, 91, 175, 176	LC1K06105	43
LA9F22576	191	LAD24	114	LC1D253	89, 91	LC1K06107	43
LA9F22577	193	LAD3PVP	98	LC1D256	90, 92, 175	LC1K09004	46
LA9F22582	191	LAD4	112	LC1D258	91, 175	LC1K090043	46, 47
LA9F701	198, 221	LAD4BB	109, 111, 114	LC1D2583	91	LC1K090045	46
LA9F702	198, 221	LAD4BBVE	114	LC1D2586	92, 175	LC1K090047	46
LA9F703	198, 221	LAD4BBVU	114	LC1D32	88, 91, 149, 175	LC1K09008	46
LA9F704	198	LAD4BBVU	114	LC1D323	89	LC1K090083	46, 47
LA9F705	221	LAD6K10	108	LC1D326	90, 92, 175	LC1K090085	46
LA9F706	198	LAD8N11	107, 176	LC1D38	88, 91, 175	LC1K090087	46
LA9F707	198	LAD8N20	107, 176	LC1D383	89	LC1K0901	43, 46
LA9F708	198	LAD8N02	107	LC1D386	90, 92, 175	LC1K09013	43, 46, 47
LA9F709	198	LAD7C	137	LC1D40	88, 91, 149, 175	LC1K09015	43, 46
LA9F980	196	LAD7C2	137	LC1D40004	91	LC1K09017	43, 46
LA9FF4F	191, 193, 233	LAD7B10	137	LC1D400046	92	LC1K0910	43, 46
LA9FF601	196	LAD7B105	137	LC1D40008	91	LC1K09103	43, 46, 47
LA9FF602	196	LAD7305	137	LC1D400086	92	LC1K09105	43, 46
LA9FF970	191, 193, 233	LAD703	137	LC1D406	90, 92, 175	LC1K09107	43, 46
LA9FF976	191, 233	LAD8	100	LC1D50	88, 91, 149, 175	LC1K1201	43
LA9FF977	193, 233	LAD9091	165	LC1D506	90, 175	LC1K12013	43
LA9FF979	197	LAD9092	165	LC1D6LE7	118	LC1K12015	43
LA9FF980	197	LAD91217	149	LC1D65	88, 91, 175	LC1K12017	43
LA9FF981	197	LAD912GVq	149	LC1D65004	91	LC1K1210	43
LA9FF982	191	LAD91810	165	LC1D800046	92	LC1K12103	43
LA9FG4F	193, 233	LAD93217	149	LC1D65008	91	LC1K12105	43
LA9FG4G	191, 193, 233	LAD96060	113	LC1D800086	92	LC1K12107	43
LA9FG601	196	LAD9P3	113	LC1D806	90, 92, 175	LC1K1601	43
LA9FG602	196	LAD9ECT1	114	LC1D80	88, 91, 149, 175	LC1K16013	43
LA9FG970	191, 193, 233	LAD9ET1	114	LC1D80004	91	LC1K16015	43
LA9FG976	191, 233	LAD9ET2	114	LC1D800046	92	LC1K16017	43
LA9FG977	193, 233	LAD9ET3	114	LC1D80008	91	LC1K1610	43
LA9FG979	197	LAD9ET4	114	LC1D800086	92	LC1K16103	43
LA9FG980	197	LAD9R1	98	LC1D806	90, 92, 175	LC1K16105	43
LA9FG981	197	LAD9R1V	98	LC1D95	88, 91, 92, 175	LC1K16107	43
LA9FG982	193	LAD9T4	165	LC1D956	90, 175	LC2D09	93, 176
LA9FH4F	193, 233	LAD9V1	98	LC1DFK02	142	LC2D0906	176
LA9FH4G	193, 233	LAD9V10	98	LC1DFK11	142	LC2D093	94
LA9FH4H	191, 193, 233	LAD9V11	98	LC1DGGK2	142	LC2D096	95, 176
LA9FH601	196	LAD9V12	98	LC1DGK11	142	LC2D099	176
LA9FH602	196	LAD9V13	98	LC1DLK02	142	LC2D115	176
LA9FH976	191, 233	LAD9V2	98	LC1DLK11	142	LC2D11500	93
LA9FH977	193, 233	LAD9V5	98	LC1DMK02	142	LC2D115004	96
LA9FH982	191	LAD9V6	98	LC1DMK11	142	LC2D1150046 ²²	97
LA9FJ4F	193, 233	LADC22	107, 176, 195	LC1DPK12	142	LC2D1156	95, 176
LA9FJ4G	193, 233	LADLVRT	109	LC1DT188	91	LC2D12	93, 176
LA9FJ4H	193, 233	LADN01	107, 176, 195	LC1DT1886	92	LC2D123	94
LA9FJ4J	191, 193, 233	LADN02	107, 176, 195	LC1DT20	91	LC2D126	95, 176
LA9FJ970	191, 193, 233	LADN04	107, 176, 195	LC1DT203	91	LC2D129	176
LA9FJ976	191, 233	LADN10	107, 176, 195	LC1DT206	92	LC2D150	176
LA9FJ977	193, 233	LADN11	107, 176, 195	LC1DT25	91, 175	LC2D15000	93
LA9FJ979	197	LADN11G	107, 176, 195	LC1DT253	91	LC2D1506	95, 176
LA9FJ980	197	LADN11P	107, 176, 195	LC1DT256	92, 175	LC2D18	93, 176
LA9FJ981	197	LADN13	107, 176, 195	LC1DT2583	91	LC2D183	94
LA9FJ982	191	LADN20	107, 176, 195	LC1DT32	91	LC2D186	95, 176
LA9FK4F	193, 233	LADN22	107, 176, 195	LC1DT323	91	LC2D25	93, 176
LA9FK4G	193, 233	LADN22G	107, 176, 195	LC1DT326	92	LC2D253	94
LA9FK4H	193, 233	LADN22P	107, 176, 195	LC1DT40	91, 175	LC2D256	95, 176
LA9FK4J	193, 233	LADN31	107, 176, 195	LC1DT403	91	LC2D32	93, 176
LA9FK4K	191, 193, 233	LADN31G	176	LC1DT406	92, 175	LC2D323	94
LA9FK601	196	LADN31P	176	LC1DTK12	142	LC2D326	95, 176
LA9FK602	196	LADN40	107, 176, 195	LC1DVK12	142	LC2D38	93, 176
LA9FK976	191, 233	LADRO	108, 176, 195	LC1F115	188, 189	LC2D383	94
LA9FK977	193, 233	LADR2	108, 176, 195	LC1F1154	188, 189	LC2D386	95, 176
LA9FK979	197	LADR4	108, 176, 195	LC1F150	188, 189	LC2D40	93, 176
LA9FK980	197	LADS2	108, 176, 195	LC1F1504	188, 189	LC2D50	93, 176
LA9FK981	197	LADT0	108, 176, 195	LC1F185	188, 189	LC2D65	93, 176
LA9FK982	191	LADT2	108, 176, 195	LC1F1854	188, 189	LC2D65004	96
LA9FL4F	193, 233	LADT4	108, 176, 195	LC1F225	188, 189	LC2D650046	97
LA9FL4G	193, 233	LC1D09	88, 91, 149, 175, 176	LC1F2254	188, 189	LC2D80	93, 176
LA9FL4H	193, 233	LC1D093	89, 91	LC1F265	188, 189	LC2D80004	96
LA9FL4J	193, 233	LC1D096	90, 92, 175	LC1F2654	188, 189	LC2D800046	97
LA9FL4K	193, 233	LC1D098	91	LC1F330	188, 189	LC2D95	93, 176
LA9FL4L	191, 193, 233	LC1D0983	91	LC1F3304	188, 189	LC2DT20	96, 97
LA9FL601	196	LC1D0986	92	LC1F400	188, 189	LC2DT25	96, 97, 176
LA9FL602	196	LC1D099	175	LC1F4002	188, 189	LC2DT256	176
LA9FL970	191, 193, 233	LC1D115	88, 91, 149, 175	LC1F4004	188, 189	LC2DT32	96, 97
LA9FL976	191, 233	LC1D115004	91	LC1F500	188, 189	LC2DT40	96, 97, 176
LA9FL977	193, 233	LC1D1150046	92	LC1F5002	188, 189	LC2DT406	176
LA9FL979	197	LC1D1156	90, 92, 175	LC1F5004	188, 189	LC2DT60	96, 97

LC2K0601	48	LC8K090045	51	LE2D256	162	LP1K090047	47
LC2K06013	48	LC8K090047	51	LE2D256B6	153	LP1K09008	47
LC2K06015	48	LC8K0901	49, 51	LE2D256B7	153	LP1K090085	47
LC2K06017	48	LC8K09015	49, 51	LE2D257E6	153	LP1K090087	47
LC2K0610	48	LC8K09017	49, 51	LE2D257E7	153	LP1K0901	45, 47
LC2K06103	48	LC8K0910	49, 51	LE2D323A6	151	LP1K09013	45
LC2K06105	48	LC8K09105	49, 51	LE2D323A7	151	LP1K09015	45, 47
LC2K06107	48	LC8K09107	49, 51	LE2D326	162	LP1K09017	45, 47
LC2K09004	51	LC8K1201	49	LE2D326C6	153	LP1K0910	45, 47
LC2K090043	51	LC8K12015	49	LE2D326C7	153	LP1K09103	45
LC2K090045	51	LC8K12017	49	LE2D327F6	153	LP1K09105	45, 47
LC2K090047	51	LC8K1210	49	LE2D327F7	153	LP1K09107	45, 47
LC2K0901	48, 51	LC8K12105	49	LE2D35	159	LP1K1201	45
LC2K09013	48, 51	LC8K12107	49	LE2D403A6	151	LP1K12013	45
LC2K09015	48, 51	LE1D09	159	LE2D403A7	151	LP1K12015	45
LC2K09017	48, 51	LE1D093A6	151	LE2D406	159, 162	LP1K12017	45
LC2K0910	48, 51	LE1D093A7	151	LE2D406C6	153	LP1K1210	45
LC2K09103	48, 51	LE1D096B6	153	LE2D406C7	153	LP1K12103	45
LC2K09105	48, 51	LE1D096B7	153	LE2D407F6	153	LP1K12105	45
LC2K09107	48, 51	LE1D097D6	153	LE2D407F7	153	LP1K12107	45
LC2K1201	48	LE1D097D7	153	LE2D503A6	151	LP2D40004	96
LC2K12013	48	LE1D12	159	LE2D503A7	151	LP2400046	97
LC2K12015	48	LE1D123A6	151	LE2D506	159, 162	LP2D80004	96
LC2K12017	48	LE1D126B6	153	LE2D653A6	151	LP2D800046	97
LC2K1210	48	LE1D126B7	153	LE2D653A7	151	LP2K0601	50
LC2K12103	48	LE1D127D6	153	LE2D656	159	LP2K06015	50
LC2K12105	48	LE1D127D7	153	LE2D803A6	151	LP2K06017	50
LC2K12107	48	LE1D18	159	LE2D803A7	151	LP2K06103	50
LC2K1601	48	LE1D183A6	151	LE2D805	159	LP2K06105	50
LC2K16013	48	LE1D183A7	151	LE2D806	159	LP2K06107	50
LC2K16015	48	LE1D186B7	153	LE2D655	161	LP2K09004	52
LC2K16017	48	LE1D187E6	153	LE2D656	162	LP2K090045	52
LC2K1610	48	LE1D187E7	153	LE2D805	163	LP2K090047	52
LC2K16103	48	LE1D25	159	LE2D806	162	LP2K09013	50, 52
LC2K16105	48	LE1D253A6	151	LE2D955	159	LP2K09015	50, 52
LC2K16107	48	LE1D253A7	151	LE2K065	159	LP2K09017	50, 52
LC3D090A	146	LE1D256B6	153	LE2K095	159	LP2K09103	50, 52
LC3D09A	146	LE1D256B7	153	LE3D09	163	LP2K09105	50, 52
LC3D115	146	LE1D257E7	153	LE3D12	163	LP2K09107	50, 52
LC3D120A	146	LE1D323A6	151	LE3D32	163	LP2K12013	50
LC3D12A	146	LE1D323A7	151	LE3D405	163	LP2K12015	50
LC3D150	146	LE1D326C6	153	LE3D406	164	LP2K12017	50
LC3D180A	146	LE1D326C7	153	LE3D505	163	LP2K1210 3	50
LC3D18A	146	LE1D327F6	153	LE3D506	164	LP2K12105	50
LC3D320A	146	LE1D327F7	153	LE3D805	163	LP2K12107	50
LC3D32A	146	LE1D35	159	LE3D806	164	LP4K0601	68
LC3D40	146	LE1D403A6	151	LE3K065	163	LP4K06013	68
LC3D50	146	LE1D403A7	151	LE3K095	163	LP4K06015	68
LC3D80	146	LE1D405	159	LE4K065	159	LP4K06017	68
LC3K06	146	LE1D406C6	153	LE4K095	159	LP4K0610	68
LC3K09	146	LE1D406C7	153	LE4D09	159	LP4K06103	68
LC4D09A	144	LE1D407F6	153	LE4D09	159	LP4K06105	68
LC4D12A	144	LE1D407F7	153	LE4D12	159	LP4K06107	68
LC4D18A	144	LE1D503A6	151	LE4D18	159	LP4K09004	70
LC4D25A	144	LE1D503A7	151	LE4D25	159	LP4K090043	70
LC4D32A	144	LE1D505	159	LE4D35	159	LP4K090045	70
LC4D40	144	LE1D653A6	151	LE4D406	159	LP4K090047	70
LC4D50	144	LE1D653A7	151	LE4D506	159	LP4K09008	70
LC4D65	144	LE1D655	159	LE4D656	159	LP4K090083	70
LC4D80	144	LE1D803A6	151	LE4D806	159	LP4K090085	70
LC7K0601	44	LE1D803A7	151	LE6D09	164	LP4K090087	70
LC7K06015	44	LE1D805	159	LE6D12	164	LP4K0901	68, 70
LC7K06017	44	LE1D955	159	LE6D18	164	LP4K09013	68, 70
LC7K0610	44	LE2D09	159	LE6D326	164	LP4K09015	68, 70
LC7K06105	44	LE2D093A6	151	LE8K065	159, 162	LP4K09017	68, 70
LC7K06107	44	LE2D093A7	151	LE8K095	159, 162	LP4K0910	68, 70
LC7K09004	46	LE2D096	162	LE8D09	159	LP4K09103	68, 70
LC7K090045	46	LE2D096B6	153	LE8D12	159	LP4K09105	68, 70
LC7K090047	46	LE2D096B7	153	LE8D18	159	LP4K09107	68, 70
LC7K09008	46	LE2D097D6	153	LE8D25	159	LP4K1201	68
LC7K090085	46	LE2D097D7	153	LE8D35	159	LP4K12013	68
LC7K090087	46	LE2D12	159	LP1D40004	91, 92	LP4K12015	68
LC7K0901	44, 46	LE2D123A6	151	LP1D40008	91, 92	LP4K12017	68
LC7K09015	44, 46	LE2D123A7	151	LP1D65004	91	LP4K1210	68
LC7K09017	44, 46	LE2D126	162	LP1D800046	92	LP4K12103	68
LC7K0910	44, 46	LE2D126B6	153	LP1D65008	91	LP4K12105	68
LC7K09105	44, 46	LE2D126B7	153	LP1D650086	92	LP4K12107	68
LC7K09107	44, 46	LE2D127D6	153	LP1D80004	91	LP5K0601	69
LC7K1201	44	LE2D127D7	153	LP1D800046	92	LP5K06013	69
LC7K12015	44	LE2D18	159	LP1D80008	91	LP5K06015	69
LC7K12017	44	LE2D183A6	151	LP1D800086	92	LP5K06017	69
LC7K1210	44	LE2D183A7	151	LP1K0601	45	LP5K0610	69
LC7K12105	44	LE3D18	163	LP1K06013	45	LP5K06103	69
LC7K12107	44	LE2D186	162	LP1K06015	45	LP5K06105	69
LC8K0601	49	LE2D186B6	153	LP1K06017	45	LP5K06107	69
LC8K06015	49	LE2D186B7	153	LP1K0610	45	LP5K09004	71
LC8K06017	49	LE2D187E6	153	LP1K06103	45	LP5K090043	71
LC8K0610	49	LE2D187E7	153	LP1K06105	45	LP5K090045	71
LC8K06105	49	LE2D25	159	LP1K06107	45	LP5K090047	71
LC8K06107	49	LE2D253A6	151	LP1K09004	47	LP5K0901	69, 71
LC8K09004	51	LE2D253A7	151	LP1K090045	47	LP5K09013	69, 71

Catalog Number Index

LP5K09015	69, 71	LRD1510	177	LX0FJ008	234	LX1D8F7	119
LP5K09017	69, 71	LRD1512	177	LX0FJ009	234	LX1D8FC5	119
LP5K0910	69, 71	LRD1514	177	LX0FJ010	234	LX1D8FC7	119
LP5K09103	69, 71	LRD1516	177	LX0FJ011	234	LX1D8FE5	119
LP5K09105	69, 71	LRD1521	177	LX0FJ020	234	LX1D8FE7	119
LP5K09107	69, 71	LRD1522	177	LX0FJ055	235	LX1D8G6	119
LP5K1201	69	LRD1530	177	LX0FJ056	235	LX1D8G7	119
LP5K12013	69	LRD1531	177	LX0FJ057	235	LX1D8L6	119
LP5K12015	69	LRD16	177	LX0FJ058	235	LX1D8LE7	119
LP5K12017	69	LRD163	134	LX0FJ224	235	LX1D8M5	119
LP5K1210	69	LRD21	177	LX0FK005	234	LX1D8M6	119
LP5K12103	69	LRD213	134	LX0FK006	234	LX1D8M7	119
LP5K12105	69	LRD22	177	LX0FK007	234	LX1D8N5	119
LP5K12107	69	LRD223	134	LX0FK008	234	LX1D8N7	119
LR2K0301	63	LRD32	177	LX0FK009	234	LX1D8P5	119
LR2K0302	63	LRD3301A66	177	LX0FK010	234	LX1D8P7	119
LR2K0303	63	LRD3302A66	177	LX0FK011	234	LX1D8Q5	119
LR2K0304	63	LRD3303A66	177	LX0FK020	234	LX1D8Q6	119
LR2K0305	63	LRD3304A66	177	LX0FK055	235	LX1D8Q7	119
LR2K0306	63	LRD3305A66	177	LX0FK056	235	LX1D8R5	119
LR2K0307	63	LRD3306A66	177	LX0FK057	235	LX1D8R6	119
LR2K0308	63	LRD3307A66	177	LX0FK058	235	LX1D8R7	119
LR2K0310	63	LRD3308A66	177	LX0FK224	235	LX1D8S5	119
LR2K0312	63	LRD3310A66	177	LX0FL005	234	LX1D8S7	119
LR2K0314	63	LRD3312A66	177	LX0FL006	234	LX1D8T6	119
LR2K0316	63	LRD3314A66	177	LX0FL007	234	LX1D8T7	119
LR2K0321	63	LRD3316A66	177	LX0FL008	234	LX1D8U5	119
LR2K0322	63	LRD3321A66	177	LX0FL009	234	LX1D8U6	119
LR3D01	177	LRD3322	177	LX0FL010	234	LX1D8U7	119
LR3D02	177	LRD3322A66	177	LX0FL011	234	LX1D8UE7	119
LR3D03	177	LRD3353	177	LX0FL020	234	LX1D8V5	119
LR3D04	177	LRD3355	177	LX0FL055	235	LX1D8V7	119
LR3D05	177	LRD3357	177	LX0FL056	235	LX1D8W6	119
LR3D06	177	LRD3359	177	LX0FL057	235	LX1FF024	202
LR3D07	177	LRD3361	177	LX0FL058	235	LX1FF040	202
LR3D08	177	LRD3363	177	LX0FL224	235	LX1FF042	202
LR3D10	177	LRD3365	177	LX1D6B5	118	LX1FF048	202
LR3D12	177	LRD33X6A66	177	LX1D6B6	118	LX1FF092	202
LR3D14	177	LRD35	177	LX1D6B7	118	LX1FF095	202
LR3D16	177	LRD3522	135	LX1D6C5	118	LX1FF1000	202
LR3D21	177	LRD4365	177	LX1D6D5	118	LX1FF110	202
LR3D22	177	LRD4367	177	LX1D6D7	118	LX1FF127	202
LR3D32	177	LRD4369	177	LX1D6E5	118	LX1FF162	202
LR3D3322	177	LR9D5367	135	LX1D6E6	118	LX1FF184	202
LR3D3353	177	LR9D5369	135	LX1D6E7	118	LX1FF187	202
LR3D3355	177	LR9D5567	135	LX1D6F5	118	LX1FF220	202
LR3D3357	177	LR9D5569	135	LX1D6F6	118	LX1FF240	202
LR3D3359	177	LR9D67	135	LX1D6F7	118	LX1FF316	202
LR3D3361	177	LR9D69	135	LX1D6FE5	118	LX1FF340	202
LR3D3363	177	LX0FF005	234	LX1D6FE7	118	LX1FF360	202
LR3D3365	177	LX0FF006	234	LX1D6G5	118	LX1FF380	202
LR3D35	177	LX0FF007	234	LX1D6G6	118	LX1FF415	202
LR9F5357	220	LX0FF008	234	LX1D6G7	118	LX1FF500	202
LR9F5363	220	LX0FF009	234	LX1D6L6	118	LX1FF550	202
LR9F5367	220	LX0FF010	234	LX1D6M5	118	LX1FF660	202
LR9F5369	220	LX0FF011	234	LX1D6M6	118	LX1FF850	202
LR9F5371	220	LX0FF020	234	LX1D6M7	118	LX1FG024	202
LR9F5557	220	LX0FF055	235	LX1D6N5	118	LX1FG040	202
LR9F5563	220	LX0FF056	235	LX1D6N7	118	LX1FG042	202
LR9F5567	220	LX0FF057	235	LX1D6P5	118	LX1FG048	202
LR9F5569	220	LX0FF058	235	LX1D6P7	118	LX1FG092	202
LR9F5571	220	LX0FF224	235	LX1D6Q5	118	LX1FG095	202
LR9F7375	220	LX0FG005	234	LX1D6Q6	118	LX1FG1000	202
LR9F7379	220	LX0FG006	234	LX1D6Q7	118	LX1FG110	202
LR9F7381	220	LX0FG007	234	LX1D6R5	118	LX1FG127	202
LR9F7575	220	LX0FG008	234	LX1D6R6	118	LX1FG162	202
LR9F7579	220	LX0FG009	234	LX1D6R7	118	LX1FG184	202
LR9F7581	220	LX0FG010	234	LX1D6S5	118	LX1FG187	202
LRD01	177	LX0FG011	234	LX1D6S6	118	LX1FG220	202
LRD013	134	LX0FG020	234	LX1D6T6	118	LX1FG240	202
LRD02	177	LX0FG055	235	LX1D6U5	118	LX1FG316	202
LRD023	134	LX0FG056	235	LX1D6U6	118	LX1FG340	202
LRD03	177	LX0FG057	235	LX1D6U7	118	LX1FG360	202
LRD033	134	LX0FG058	235	LX1D6V5	118	LX1FG380	202
LRD04	134	LX0FG224	235	LX1D6V7	118	LX1FG415	202
LRD043	134	LX0FH005	234	LX1D6W5	118	LX1FG500	202
LRD05	177	LX0FH006	234	LX1D6W6	118	LX1FG550	202
LRD053	134	LX0FH007	234	LX1D6X6	118	LX1FG660	202
LRD06	177	LX0FH008	234	LX1D6Y5	118	LX1FG850	202
LRD063	134	LX0FH009	234	LX1D8B5	119	LX1FH0482	203
LRD07	177	LX0FH010	234	LX1D8B6	119	LX1FH10002	203
LRD073	134	LX0FH011	234	LX1D8B7	119	LX1FH1102	203
LRD08	177	LX0FH020	234	LX1D8C5	119	LX1FH1272	203
LRD083	134	LX0FH055	235	LX1D8C7	119	LX1FH2002	203
LRD10	177	LX0FH056	235	LX1D8D5	119	LX1FH2202	203
LRD103	134	LX0FH057	235	LX1D8D7	119	LX1FH2402	203
LRD12	177	LX0FH058	235	LX1D8E5	119	LX1FH2772	203
LRD123	134	LX0FH224	235	LX1D8E6	119	LX1FH3802	203
LRD14	134	LX0FJ005	234	LX1D8E7	119	LX1FH5002	203
LRD143	134	LX0FJ006	234	LX1D8F5	119	LX1FH6002	203
LRD1508	177	LX0FJ007	234	LX1D8F6	119	LX1FJ048	203

LX1FJ1000	203	LX4FF048	205	LX9FL931	208, 209
LX1FJ110	203	LX4FF110	205	LX9FL935	208
LX1FJ127	203	LX4FF125	205	LX9FL936	208
LX1FJ200	203	LX4FF220	205	LX9FL937	209
LX1FJ220	203	LX4FF250	205	LX9FL938	208
LX1FJ240	203	LX4FF440	205	LXD1B7	117
LX1FJ280	203	LX4FG024	205	LXD1C7	117
LX1FJ380	203	LX4FG048	205	LXD1CC7	117
LX1FJ415	203	LX4FG110	205	LXD1D7	117
LX1FJ500	203	LX4FG125	205	LXD1E7	117
LX1FJ600	203	LX4FG220	205	LXD1EE7	117
LX1FK048	203	LX4FG250	205	LXD1F7	117
LX1FK1000	203	LX4FG440	205	LXD1FC7	117
LX1FK110	203	LX4FH024	205	LXD1FE7	117
LX1FK127	203	LX4FH048	205	LXD1G7	117
LX1FK200	203	LX4FH110	205	LXD1J7	117
LX1FK220	203	LX4FH125	205	LXD1K7	117
LX1FK240	203	LX4FH220	205	LXD1L7	117
LX1FK280	203	LX4FH250	205	LXD1LE7	117
LX1FK380	203	LX4FH440	205	LXD1M7	117
LX1FK415	203	LX4FJ048	205	LXD1N7	117
LX1FK500	203	LX4FJ110	205	LXD1P7	117
LX1FK600	203	LX4FJ125	205	LXD1Q7	117
LX1FL048	204	LX4FJ220	205	LXD1R7	117
LX1FL1000	204	LX4FJ250	205	LXD1SC7	117
LX1FL110	204	LX4FJ440	205	LXD1T7	117
LX1FL127	204	LX4FK048	206	LXD1U7	117
LX1FL200	204	LX4FK110	206	LXD1V7	117
LX1FL220	204	LX4FK125	206	LXD1W7	117
LX1FL260	204	LX4FK220	206	LXD1X7	117
LX1FL380	204	LX4FK250	206	LXD1Y7	117
LX1FL415	204	LX4FK440	206	LXD1Z7	117
LX1FL500	204	LX4FL048	206	P	
LX1FL600	204	LX4FL110	206	PA1LB50	238
LX1FX110	204	LX4FL125	206	PA1LB75	238
LX1FX127	204	LX4FL220	206	PA1LB76	238
LX1FX200	204	LX4FL250	206	PA1LB80	238
LX1FX220	204	LX4FL440	206	PA1LB89	238
LX1FX280	204	LX4FX110	206	PA1PB50	238
LX1FX380	204	LX4FX125	206	PA1RB50	238
LX1FX415	204	LX4FX220	206	PN1FB50	238
LX1FX500	204	LX4FX250	206	PR4FB00	238
LX4D6BD	120	LX4FX440	206	PR4FB0004	237
LX4D6BW	121	LX9FF048	207	PR4FB0005	237
LX4D6CD	120	LX9FF110	207	PR4FB0006	237
LX4D6CW	121	LX9FF127	207	PR4FB0007	237
LX4D6ED	120	LX9FF220	207	PR4FB0008	237
LX4D6EW	121	LX9FF240	207	PR4FB0009	237
LX4D6FD	120	LX9FF380	207	PR4FB0010	237
LX4D6FW	121	LX9FF415	207	PR4FB0011	237
LX4D6GD	120	LX9FF500	207	PR4FB0012	237
LX4D6JD	120	LX9FG048	207	PR4FB0014	237
LX4D6JW	121	LX9FG110	207	W	
LX4D6MD	120	LX9FG127	207	WB1KB121	236
LX4D6MW	121	LX9FG220	207	WB1KB122	236
LX4D6ND	120	LX9FG240	207	WB1KB123	236
LX4D6RD	120	LX9FG380	207	WB1KB124	236
LX4D6SD	120	LX9FG415	207	WB1KB125	236
LX4D6SW	121	LX9FG500	207	WB1KB126	236
LX4D6UD	120	LX9FH0482	207	WB1KB132	236
LX4D7BD	120	LX9FH1102	207	WB1KB133	236
LX4D7BW	121	LX9FH1272	207	WB1KB134	236
LX4D7CD	120	LX9FH2202	207	WB1KB135	236
LX4D7CW	121	LX9FH3802	207	WB1KB136	236
LX4D7ED	120	LX9FH5002	207	WB1KB137	236
LX4D7EW	121	LX9FJ917	208	WB1KB138	236
LX4D7FD	120	LX9FJ918	209	WB1KB139	236
LX4D7FW	121	LX9FJ925	208	WB1KB140	236
LX4D7GD	120	LX9FJ926	208, 209	W816366180111	137
LX4D7JD	120	LX9FJ927	209	X	
LX4D7JW	121	LX9FJ931	208	XYB1U	114
LX4D7MD	120	LX9FJ932	209	XB5AL84101	137
LX4D7MW	121	LX9FJ936	208	XB5AA86102	137
LX4D7ND	120	LX9FJ937	208	Z	
LX4D7RD	120	LX9FJ938	208, 209	ZA2BA8602	221
LX4D7SD	120	LX9FK917	208	ZA2BZ13	221
LX4D7SW	121	LX9FK918	209	ZB5AA0	165
LX4D7UD	120	LX9FK925	208	ZB5AA331	165
LX4D8BD	121	LX9FK926	208, 209	ZB5AL432	165
LX4D8ED	121	LX9FK927	209	ZB5A639	165
LX4D8FD	121	LX9FK931	208	ZB5AD2	165
LX4D8GD	121	LX9FK932	209	ZB5AD3	165
LX4D8MD	121	LX9FK936	208	ZB5AD5	165
LX4D8ND	121	LX9FK937	208	ZC4GM1	238
LX4D8RD	121	LX9FK938	208, 209	ZC4GM2	237, 238
LX4D8SD	121	LX9FL917	208	ZC4GM8	237, 238
LX4D8UD	121	LX9FL918	209	ZC4GM9	238
LX4F8FW	204, 206	LX9FL924	208		
LX4F8MW	204, 206	LX9FL925	209		
LX4F8QW	204, 206	LX9FL926	208, 209		
LX4FF024	205	LX9FL930	208		

Schneider Electric
8001 Highway 64 East
Knightdale, NC 27545
1-888-SquareD
(1-888-778-2733)
www.SquareD.com

Schneider Canada Inc.
19 Waterman Avenue,
M4B 1 Y2
Toronto, Ontario
1-800-565-6699
www.schneider-electric.ca

Catalog No. 8502CT9901R5/03 January 2004 © 2001-2004 Schneider Electric All Rights Reserved
Replaces 8502CT9901R9/02 dated 11/02.

X-ON Electronics

Largest Supplier of Electrical and Electronic Components

Click to view similar products for [Industrial Relays](#) category:

Click to view products by [Schneider](#) manufacturer:

Other Similar products are found below :

[6-1618400-7](#) [686-117111](#) [686-120111](#) [EV250-4A-02](#) [EV250-6A-01](#) [FCA-125-CX8](#) [FCA-410-138](#) [8-1618393-1](#) [GCA32A208VAC60HZ](#)
[GCA32A220VAC50/60HZ](#) [GCA32A230VAC50/60HZ](#) [GCA32A240VAC50/60HZ](#) [GCA32A48VAC60HZ](#) [GCA63A120VAC50/60HZ](#)
[GCA63A208VAC60HZ](#) [GCA63A220VAC60HZ](#) [GCA63A230VAC50/60HZ](#) [GCA63A240VAC50/60HZ](#) [GCA63A277VAC60HZ](#)
[GCA63A48VAC60HZ](#) [GCA63A500VAC50/60HZ](#) [GCA63A600VAC60HZ](#) [GCA800A200VACDC](#) [GCA95A110VAC50/60HZ](#)
[GCA95A120VAC50/60HZ](#) [GCA95A12VDC](#) [GCA95A240VAC50/60HZ](#) [GCA95A24VAC50/60HZ](#) [GCA95A48VAC60HZ](#) [ACC530U20](#)
[ACC730U30](#) [1395832-1](#) [RM699BV-3011-85-1005](#) [RMIA210230AC](#) [RMIA45024AC](#) [1423675-8](#) [B07B032AC1-0329](#) [B329](#) [1617807-1](#)
[N417](#) [P25-E5019-1](#) [P30C42A12D1-120](#) [2-1618398-1](#) [PBO-18A1218](#) [2307497](#) [RPYA00324LT](#) [RPYA003A120LT](#) [KR-4539-1](#)
[RT334012WG](#) [S160156115](#)