

November 2015

Carbon Emission  
**CO<sub>2</sub>** 1.86g  
MLCC(02A104M) 1piece

RoHS+Halogen  
Compliant  
*Ecoparts*

# MULTILAYER CERAMIC CAPACITORS



SAMSUNG  
ELECTRO-MECHANICS





## We declare that all our MLCCs are produced in accordance with EU ROHS and REACH Directive.

### 1. RoHS Compliance and restriction of Br

The following restricted materials are not used in packaging materials as well as products in compliance with the law and restriction.  
- Cd, Pb, Hg, Cr6+, As, Br and the compounds, PCB, asbestos

### 2. No use of materials breaking Ozone layer

The following ODS materials are not used in our fabrication process.  
- ODS material : Freon, Haron, 1-1-1 TCE, CCl<sub>4</sub>, HCFC

If you want more detailed Information, Please Visit Samsung Electro-mechanics Website  
[<http://www.semlcr.com>]

Please, see the last page of this catalog for our environmental certification list.

# CONTENTS

Part Numbering System .....	4	Part Numbering System
Standard & High Capacitors .....	6	Standard & High Capacitors
Super Small Size Capacitors .....	30	Super Small Size Capacitors
High-Q Capacitors .....	35	High-Q Capacitors
Medium-High Voltage Capacitors .....	36	Medium-High Voltage Capacitors
Array Type Capacitors .....	47	Array Type Capacitors
Low ESL Capacitors .....	50	Low ESL Capacitors
Reliability Test Condition .....	53	Reliability Test Condition
Premium Capacitors for Automotive Applications .....	60	Premium Capacitors for Automotive Applications
Packaging Specification .....	72	Packaging Specification
Application Manual for Surface Mounting .....	76	Application Manual for Surface Mounting

# Part Numbering System

**CL 10 A 106 M P 8 N N N C**  
**1 2 3 4 5 6 7 8 9 10 11**

**1. SERIES CODE** \_\_\_\_\_

CL = Multi layer Ceramic Capacitors

**2. SIZE CODE** — inch (mm) \_\_\_\_\_

02 = 01005(0402)    21 = 0805(2012)    43 = 1812(4532)  
 03 = 0201(0603)    31 = 1206(3216)    55 = 2220(5750)  
 05 = 0402(1005)    32 = 1210(3225)  
 10 = 0603(1608)    42 = 1808(4520)

**3. DIELECTRIC CODE** \_\_\_\_\_

Class I	Class II
C = COG	A = X5R    F = Y5V B = X7R    X = X6S Y = X7S    Z = X7T

**4. CAPACITANCE CODE** \_\_\_\_\_

Capacitance expressed in pF. 2 significant digits plus number of zeros.  
 example) 106 =  $10 \times 10^6 = 10000000\text{pF}$   
 For Values < 10pF, Letter R denotes decimal point  
 example) 1R5 = 1.5pF

**5. TOLERANCE CODE** \_\_\_\_\_

B =  $\pm 0.1\text{pF}$     F =  $\pm 1\text{pF}, \pm 1\%$ \*    K =  $\pm 10\%$   
 C =  $\pm 0.25\text{pF}$     G =  $\pm 2\%$     M =  $\pm 20\%$   
 D =  $\pm 0.5\text{pF}$     J =  $\pm 5\%$     Z =  $+80/-20\%$

\*For Values  $\leq 10\text{pF}$ , F =  $\pm 1\text{pF}$   
 Values  $> 10\text{pF}$ , F =  $\pm 1\%$

**6. RATED VOLTAGE CODE** \_\_\_\_\_

R = 4V    O = 16V    B = 50V    E = 250V    H = 630V    K = 3000V  
 Q = 6.3V    A = 25V    C = 100V    F = 350V    I = 1000V  
 P = 10V    L = 35V    D = 200V    G = 500V    J = 2000V

**7. THICKNESS CODE** \_\_\_\_\_

2 = 0.20mm    A = 0.65mm    F = 1.25mm    L = 3.20mm    S = 1.35mm  
 3 = 0.30mm    C = 0.85mm    H = 1.60mm    M = 1.15mm    U = 1.80mm  
 5 = 0.50mm    D = 1.00mm    I = 2.00mm    P = 1.15mm    V = 2.50mm  
 8 = 0.80mm    E = 1.10mm    J = 2.50mm    Q = 1.25mm    Y = 1.25mm  
 9 = 0.90mm

**8. INNER ELECTRODE / TERMINATION / PLATING CODE** \_\_\_\_\_

A = Normal Product Pd / Ag / Ni barrier / Sn 100%  
 N = Normal Product Ni / Cu / Ni barrier / Sn 100%  
 G = Normal Product Cu / Cu / Ni barrier / Sn 100%  
 L = Low profile Ni / Cu / Ni barrier / Sn 100%  
 S = Normal Product Ni / Cu / Soft termination / Ni barrier / Sn 100%

**9. PRODUCT CODE** \_\_\_\_\_

N = Normal  
 A = Array(4-element)  
 B = Array(4-element)  
 L = LICC  
 J = SLIC

		*Size tolerance					
Code	Size	01005(0402)	0201(0603)	0402(1005)	0603(1608)	0805(2012)	1206(3216)
	S		$\pm 0.03$	$\pm 0.05$	$\pm 0.07$	$\pm 0.07$	
Q		$\pm 0.05$	$\pm 0.07$	$\pm 0.10$	$\pm 0.15$	$\pm 0.15$	
R		$\pm 0.07$	$\pm 0.09$	$\pm 0.15$	$\pm 0.15$	$\pm 0.20$	
U		$\pm 0.09$		$\pm 0.20$	$\pm 0.25$	$\pm 0.30$	
Z				$\pm 0.40$	$\pm 0.30$		
9				$\pm 0.30$			

**10. CONTROL CODE** \_\_\_\_\_

N = Reserved for future use

**11. PACKAGING CODE** \_\_\_\_\_

B = Bulk    O = Cardboard Tape, 10" Reel    E = Embossed Type, 7" Reel  
 P = Bulk Case    D = Cardboard Tape, 13" Reel (10,000ea)    G = Embossed Type, 7" Reel (3,000ea)  
 C = Cardboard Tape, 7" Reel    L = Cardboard Tape, 13" Reel (15,000ea)    F = Embossed Type, 13" Reel  
 H = Cardboard Tape, 7" Reel (15,000ea)    S = Embossed Type, 10" Reel  
 8 = Cardboard Tape, 7" Reel    Z = Cardboard Type, 7" Reel (Chip aligned for horizontal SMT)  
 Y = Cardboard Type, 7" Reel (Chip aligned for vertical SMT)

**Class I** (Temperature Compensation)

Symbol	EIA Code	Operation Temperature Range(℃)	Temperature Coefficient Range(ppm/℃)
C	C0G	-55 ~ +125	0±30

**\*Class II** (High Dielectric Constant)

Symbol	EIA Code	Operation Temperature Range(℃)	Capacitance Change(ΔC%)
A	X5R	-55 ~ + 85	±15
B	X7R	-55 ~ +125	±15
X	X6S	-55 ~ +105	±22
F	Y5V	-30 ~ + 85	-82 ~ +22
Y	X7S	-55 ~ +125	±22
Z	X7T	-55 ~ +125	-33 ~ +22

★★

Series	TC	Capacitance Step											
E-3	Y5V	1.0				2.2				4.7			
E-6	X5R	1.0	1.5	2.2	3.3	4.7	6.8						
	X7R												
	X6S												
	X7S												
	X7T												
E-12	C0G	1.0	1.2	1.5	1.8	2.2	2.7	3.3	3.9	4.7	5.6	6.8	8.2

★★★

Size	Code	Thickness(mm)	Spec(mm)	Size	Code	Thickness(mm)	Spec(mm)
01005(0402)	2	0.20	±0.02	1210(3225)	C	0.85	±0.10*
0201(0603)	3	0.30	±0.03		g	0.90	±0.10*
0402(1005)	3	0.30	±0.03*		F	1.25	±0.20
	5	0.50	±0.05		S	1.35	±0.15
0603(1608)	5	0.50	+0.0/-0.1*		H	1.60	±0.20
	8	0.80	±0.10		U	1.80	±0.20*
0805(2012)	A	0.65	±0.10		I	2.00	±0.20
	C	0.85	±0.10		J	2.50	±0.20
	C	0.85	±0.10*		V	2.50	±0.30
	M	1.15	±0.10		1808(4520)	F	1.25
	F	1.25	±0.10	H		1.60	±0.20
	Q	1.25	±0.15	I		2.00	±0.20
		Y	1.25	±0.20	F	1.25	±0.20
1206(3216)	C	0.85	±0.15	1812(4532)	H	1.60	±0.20
	C	0.85	±0.10*		I	2.00	±0.20
	E	1.10	±0.15		J	2.50	±0.20
	E	1.10	±0.10*	2220(5750)	L	3.20	±0.30
	P	1.15	±0.10*		H	1.60	±0.20
	M	1.15	±0.15		I	2.00	±0.20
	F	1.25	±0.15		J	2.50	±0.20
	H	1.60	±0.20		L	3.00	±0.30

■ \* Mark is only applicable to "L" code, 12<sup>th</sup> code in part number.

■ Please discuss with sales person with regard to Pd products.

Part Numbering System

Standard & High Capacitors

Super Small Size Capacitors

High-Q Capacitors

Medium-High Voltage Capacitors

Array Type Capacitors

Low ESL Capacitors

Reliability Test Condition

Premium Capacitors for Automotive Applications

Packaging Specification

Application Manual for Surface Mounting



# Standard & High Capacitors



## Feature

- Wide selection of size : from 0402 to 2220
- Highly reliable tolerance and high speed automatic chip placement on PCBs
- Wide capacitance range
- Wide temperature compensation and voltage range : from COG to Y5V and from 6.3V to 50V
- Highly reliable performance
- Highly resistant termination metal
- Tape & reel for surface mount assembly

## Application

- HHP, DSC, DVC, LCD, TV, Memory Module, PDA, Game Machine
- Desktop PC, Note PC, HHP, DC-DC Converter, DSC
- Tuner (Product code C is suitable.)

## Structure and Dimensions



Size Code	EIA Code	Dimension(mm)				
		L	W	T	Thickness Code	BW
05	0402	1.00±0.05	0.50±0.05	0.50±0.05	5	0.25±0.10
10	0603	1.60±0.10	0.80±0.10	0.50±0.0/-0.1(*)	5	0.30±0.20
		1.60±0.10	0.80±0.10	0.80±0.10	8	
21	0805	2.00±0.10	1.25±0.10	0.85±0.10	C	0.5±0.2/-0.3
		2.00±0.10	1.25±0.10	1.15±0.10	M	
		2.00±0.10	1.25±0.10	1.25±0.10	F	
		2.00±0.15	1.25±0.15	1.25±0.15	Q	
		2.00±0.20	1.25±0.20	1.25±0.20	Y	
31	1206	3.20±0.20	1.60±0.20	0.60±0.10(*)	6	0.50±0.30
		3.20±0.15	1.60±0.15	0.85±0.15	C	
		3.20±0.20	1.60±0.20	0.85±0.10(*)	C	
		3.20±0.20	1.60±0.20	1.15±0.10(*)	P	
		3.20±0.15	1.60±0.15	1.25±0.15	F	
32	1210	3.20±0.20	1.60±0.20	1.60±0.20	H	0.60±0.30
		3.20±0.30	2.50±0.20	0.85±0.10(*)	C	
		3.20±0.30	2.50±0.20	0.90±0.10(*)	9	
		3.20±0.30	2.50±0.20	1.60±0.20	H	
		3.20±0.30	2.50±0.20	1.80±0.20(*)	U	
		3.20±0.30	2.50±0.20	2.00±0.20	I	
42	1808	3.20±0.30	2.50±0.20	2.50±0.20	J	0.80±0.30
		3.20±0.40	2.50±0.30	2.50±0.30	V	
		4.50±0.40	2.00±0.20	1.25±0.20	F	
43	1812	4.50±0.40	2.00±0.20	1.40±0.20	G	0.80±0.30
		4.50±0.40	2.00±0.20	2.00±0.20	I	
		4.50±0.40	3.20±0.30	1.25±0.20	F	
55	2220	4.50±0.40	3.20±0.30	2.50±0.20	J	0.80±0.30
		4.50±0.40	3.20±0.30	3.20±0.30	L	
		5.70±0.40	5.00±0.40	2.50±0.20	J	
		5.70±0.40	5.00±0.40	3.20±0.30	L	1.00±0.30

■ \* Mark is only applicable to "L" code, 12<sup>th</sup> code in part number.

**Standard & High Capacitance (COG)**

Size(mm)	Vr(V)	Capacitance																					
		pF									nF												
		0.5	1	10	22	47	100	220	330	470	560	1	2.2	3.3	4.7	6.8	10	22	27	33	47	68	100
0402(1005)	25	[Shaded]																					
	50	[Shaded]																					
0603(1608)	25	[Shaded]																					
	50	[Shaded]																					
0805(2012)	25												[Shaded]										
	50	[Shaded]																					
1206(3216)	16																			[Shaded]			
	25												[Shaded]										
	50	[Shaded]																					
1210(3225)	50												[Shaded]										
1812(4532)	25																			[Shaded]			
	50												[Shaded]										
2220(5750)	50												[Shaded]										

- Part Numbering System
- Standard & High Capacitors
- Super Small Size Capacitors
- High-Q Capacitors
- Medium-High Voltage Capacitors
- Array Type Capacitors
- Low ESL Capacitors
- Reliability Test Condition
- Premium Capacitors for Automotive Applications
- Packaging Specification
- Application Manual for Surface Mounting





Standard & High Capacitance-Low Profile (X5R)

Size(mm)	Tmax (mm)	Vr(V)	Capacitance ( $\mu$ F)						
			1	2.2	4.7	10	22	47	
0402(1005)	0.33	6.3	X6S		(Tmax=0.35)				
		10							
		16							
0603(1608)	0.5	6.3							
		10							
		16							
		25							
0805(2012)	0.7	10							
		16							
		25							
	0.85	25							
		0.95	4					(Tmax=1.0)	
			6.3					(Tmax=1.0)	
0.95	10								
	16								
	25					X6S			
1206(3216)	0.7	10							
		0.95	6.3						
	10								
	16								
	25						X6S		
	50		(Tmax=1.0)		(Tmax=1.0)				
	100		(Tmax=1.0)						
1210(3225)	0.95	16							
		2.0	25						
	35								
	50								

- Part Numbering System
- Standard & High Capacitors
- Super Small Size Capacitors
- High-Q Capacitors
- Medium-High Voltage Capacitors
- Array Type Capacitors
- Low ESL Capacitors
- Reliability Test Condition
- Premium Capacitors for Automotive Applications
- Packaging Specification
- Application Manual for Surface Mounting



**Standard & High Capacitance (X7R)**

Size(mm)	Vr(V)	Capacitance ( $\mu F$ )										
		0.1	0.22	0.47	1	2.2	4.7	10	22	47	100	
0402(1005)	6.3	[Bar chart showing capacitance range from 0.1 to 100 $\mu F$ ]										
	10	[Bar chart showing capacitance range from 0.1 to 100 $\mu F$ , with 'X7S' label]										
	16	[Bar chart showing capacitance range from 0.1 to 100 $\mu F$ ]										
0603(1608)	6.3	[Bar chart showing capacitance range from 0.1 to 100 $\mu F$ ]										
	10	[Bar chart showing capacitance range from 0.1 to 100 $\mu F$ ]										
	16	[Bar chart showing capacitance range from 0.1 to 100 $\mu F$ ]										
	25	[Bar chart showing capacitance range from 0.1 to 100 $\mu F$ ]										
	50	[Bar chart showing capacitance range from 0.1 to 100 $\mu F$ ]										
0805(2012)	6.3	[Bar chart showing capacitance range from 0.1 to 100 $\mu F$ ]										
	10	[Bar chart showing capacitance range from 0.1 to 100 $\mu F$ ]										
	16	[Bar chart showing capacitance range from 0.1 to 100 $\mu F$ ]										
	25	[Bar chart showing capacitance range from 0.1 to 100 $\mu F$ , with 'X7S' label]										
	35	[Bar chart showing capacitance range from 0.1 to 100 $\mu F$ ]										
	50	[Bar chart showing capacitance range from 0.1 to 100 $\mu F$ ]										
1206(3216)	6.3	[Bar chart showing capacitance range from 0.1 to 100 $\mu F$ ]										
	10	[Bar chart showing capacitance range from 0.1 to 100 $\mu F$ ]										
	16	[Bar chart showing capacitance range from 0.1 to 100 $\mu F$ ]										
	25	[Bar chart showing capacitance range from 0.1 to 100 $\mu F$ ]										
	35	[Bar chart showing capacitance range from 0.1 to 100 $\mu F$ ]										
	50	[Bar chart showing capacitance range from 0.1 to 100 $\mu F$ ]										
1210(3225)	6.3	[Bar chart showing capacitance range from 0.1 to 100 $\mu F$ , with 'X7T' label]										
	10	[Bar chart showing capacitance range from 0.1 to 100 $\mu F$ ]										
	16	[Bar chart showing capacitance range from 0.1 to 100 $\mu F$ ]										
	25	[Bar chart showing capacitance range from 0.1 to 100 $\mu F$ ]										
	50	[Bar chart showing capacitance range from 0.1 to 100 $\mu F$ ]										

- Part Numbering System
- Standard & High Capacitors
- Super Small Size Capacitors
- High-Q Capacitors
- Medium-High Voltage Capacitors
- Array Type Capacitors
- Low ESL Capacitors
- Reliability Test Condition
- Premium Capacitors for Automotive Applications
- Packaging Specification
- Application Manual for Surface Mounting



**Standard & High capacitance (Y5V)**

Size(mm)	Vr(V)	Capacitance ( $\mu$ F)									
		0.1	0.22	0.47	1	2.2	4.7	10	22	47	
0402(1005)	6.3										
	10										
	16										
	25										
0603(1608)	6.3										
	10										
	16										
	25										
	50										
0805(2012)	6.3										
	10										
	16										
	25										
	50										
1206(3216)	10										
	16										
	25										
	50										
1210(3225)	6.3										
	10										
	16										
	25										
	35										
	50										

**Standard & High capacitance - Low Profile (Y5V)**

Size(mm)	Vr(V)	Capacitance ( $\mu$ F)						
		1	2.2	4.7	10	22	47	
0805(2012)	6.3							
	10							

Product Lineup (Standard & High Capacitors-C0G)

	Part Number	Size L x W (mm)	Capacitance	Rated Voltage (Vdc)	Capacitance Tolerance	Thickness Max.(mm)
1	CL05C0R5CB5NNN □	1.00×0.50	0.5pF	50	±0.25pF	0.55
2	CL05CR75CB5NNN □		0.75pF	50	±0.25pF	0.55
3	CL05C010CB5NNN □		1.0pF	50	±0.25pF	0.55
4	CL05C1R2CB5NNN □		1.2pF	50	±0.25pF	0.55
5	CL05C1R5CB5NNN □		1.5pF	50	±0.25pF	0.55
6	CL05C1R8CB5NNN □		1.8pF	50	±0.25pF	0.55
7	CL05C020CB5NNN □		2.0pF	50	±0.25pF	0.55
8	CL05C2R2CB5NNN □		2.2pF	50	±0.25pF	0.55
9	CL05C2R4CB5NNN □		2.4pF	50	±0.25pF	0.55
10	CL05C2R5CB5NNN □		2.5pF	50	±0.25pF	0.55
11	CL05C2R7CB5NNN □		2.7pF	50	±0.25pF	0.55
12	CL05C030CB5NNN □		3.0pF	50	±0.25pF	0.55
13	CL05C3R3CB5NNN □		3.3pF	50	±0.25pF	0.55
14	CL05C3R5CB5NNN □		3.5pF	50	±0.25pF	0.55
15	CL05C3R6CB5NNN □		3.6pF	50	±0.25pF	0.55
16	CL05C3R9CB5NNN □		3.9pF	50	±0.25pF	0.55
17	CL05C040CB5NNN □		4.0pF	50	±0.25pF	0.55
18	CL05C4R3CB5NNN □		4.3pF	50	±0.25pF	0.55
19	CL05C4R7CB5NNN □		4.7pF	50	±0.25pF	0.55
20	CL05C050DB5NNN □		5.0pF	50	±0.5pF	0.55
21	CL05C5R6DB5NNN □		5.6pF	50	±0.5pF	0.55
22	CL05C060DB5NNN □		6.0pF	50	±0.5pF	0.55
23	CL05C6R2DB5NNN □		6.2pF	50	±0.5pF	0.55
24	CL05C6R8DB5NNN □		6.8pF	50	±0.5pF	0.55
25	CL05C070DB5NNN □		7.0pF	50	±0.5pF	0.55
26	CL05C080DB5NNN □		8.0pF	50	±0.5pF	0.55
27	CL05C8R2DB5NNN □		8.2pF	50	±0.5pF	0.55
28	CL05C090DB5NNN □		9.0pF	50	±0.5pF	0.55
29	CL05C9R1DB5NNN □		9.1pF	50	±0.5pF	0.55
30	CL05C100JB5NNN □		10pF	50	±5%	0.55
31	CL05C110JB5NNN □		11pF	50	±5%	0.55
32	CL05C120JB5NNN □		12pF	50	±5%	0.55
33	CL05C130JB5NNN □		13pF	50	±5%	0.55
34	CL05C150JB5NNN □		15pF	50	±5%	0.55
35	CL05C160JB5NNN □		16pF	50	±5%	0.55
36	CL05C180JB5NNN □		18pF	50	±5%	0.55
37	CL05C200JB5NNN □		20pF	50	±5%	0.55
38	CL05C220JA5NNN □		22pF	25	±5%	0.55
39	CL05C220JB5NNN □		22pF	50	±5%	0.55
40	CL05C240JB5NNN □		24pF	50	±5%	0.55
41	CL05C270JB5NNN □		27pF	50	±5%	0.55
42	CL05C270JA5NNN □		27pF	25	±5%	0.55
43	CL05C300JB5NNN □		30pF	50	±5%	0.55
44	CL05C330JB5NNN □		33pF	50	±5%	0.55
45	CL05C360JB5NNN □		36pF	50	±5%	0.55
46	CL05C390JB5NNN □		39pF	50	±5%	0.55
47	CL05C430JB5NNN □		43pF	50	±5%	0.55
48	CL05C470JB5NNN □		47pF	50	±5%	0.55
49	CL05C510JB5NNN □		51pF	50	±5%	0.55
50	CL05C560JB5NNN □		56pF	50	±5%	0.55

※ □ mark means packaging code. If you want to learn the code or quantity in detail, please see p74.

Part Numbering System

Standard & High Capacitors

Super Small Size Capacitors

High-Q Capacitors

Medium-High Voltage Capacitors

Array Type Capacitors

Low ESL Capacitors

Reliability Test Condition

Premium Capacitors for Automotive Applications

Packaging Specification

Application Manual for Surface Mounting



**Product Lineup (Standard & High Capacitors-C0G)**

	Part Number	Size L x W (mm)	Capacitance	Rated Voltage (Vdc)	Capacitance Tolerance	Thickness Max.(mm)
51	CL05C620JB5NNN □	1.00×0.50	62pF	50	±5%	0.55
52	CL05C680JB5NNN □		68pF	50	±5%	0.55
53	CL05C750JB5NNN □		75pF	50	±5%	0.55
54	CL05C820JB5NNN □		82pF	50	±5%	0.55
55	CL05C910JB5NNN □		91pF	50	±5%	0.55
56	CL05C101JB5NNN □		100pF	50	±5%	0.55
57	CL05C121JB5NNN □		120pF	50	±5%	0.55
58	CL05C151JB5NNN □		150pF	50	±5%	0.55
59	CL05C181JB5NNN □		180pF	50	±5%	0.55
60	CL05C201JB5NNN □		200pF	50	±5%	0.55
61	CL05C221JB5NNN □		220pF	50	±5%	0.55
62	CL05C271JB5NNN □		270pF	50	±5%	0.55
63	CL05C331JB5NNN □		330pF	50	±5%	0.55
64	CL05C391JB5NNN □		390pF	50	±5%	0.55
65	CL05C471JB5NNN □		470pF	50	±5%	0.55
66	CL05C471JO5NNN □		470pF	16	±5%	0.55
67	CL05C681JB5NNN □		680pF	50	±5%	0.55
68	CL05C821JB5NNN □		820pF	50	±5%	0.55
69	CL05C102JB5NNN □		1nF	50	±5%	0.55
70	CL05C102JA5NNN □		1nF	25	±5%	0.55
71	CL05C102JO5NNN □		1nF	16	±5%	0.55
1	CL10C0R3CB8NNN □	1.60×0.80	0.3pF	50	±0.25pF	0.90
2	CL10C0R5CB8NNN □		0.5pF	50	±0.25pF	0.90
3	CL10CR75CB8NNN □		0.75pF	50	±0.25pF	0.90
4	CL10C010CB8NNN □		1.0pF	50	±0.25pF	0.90
5	CL10C1R2CB8NNN □		1.2pF	50	±0.25pF	0.90
6	CL10C1R5CB8NNN □		1.5pF	50	±0.25pF	0.90
7	CL10C1R8CB8NNN □		1.8pF	50	±0.25pF	0.90
8	CL10C020CB8NNN □		2.0pF	50	±0.25pF	0.90
9	CL10C2R2CB8NNN □		2.2pF	50	±0.25pF	0.90
10	CL10C2R4CB8NNN □		2.4pF	50	±0.25pF	0.90
11	CL10C2R5CB8NNN □		2.5pF	50	±0.25pF	0.90
12	CL10C2R7CB8NNN □		2.7pF	50	±0.25pF	0.90
13	CL10C030CB8NNN □		3.0pF	50	±0.25pF	0.90
14	CL10C3R3CB8NNN □		3.3pF	50	±0.25pF	0.90
15	CL10C3R5CB8NNN □		3.5pF	50	±0.25pF	0.90
16	CL10C3R6CB8NNN □		3.6pF	50	±0.25pF	0.90
17	CL10C3R9CB8NNN □		3.9pF	50	±0.25pF	0.90
18	CL10C040CB8NNN □		4.0pF	50	±0.25pF	0.90
19	CL10C4R3CB8NNN □		4.3pF	50	±0.25pF	0.90
20	CL10C4R7CB8NNN □		4.7pF	50	±0.25pF	0.90
21	CL10C050DB8NNN □		5.0pF	50	±0.5pF	0.90
22	CL10C5R6DB8NNN □		5.6pF	50	±0.5pF	0.90
23	CL10C060DB8NNN □		6.0pF	50	±0.5pF	0.90
24	CL10C6R2DB8NNN □		6.2pF	50	±0.5pF	0.90
25	CL10C6R8DB8NNN □		6.8pF	50	±0.5pF	0.90
26	CL10C070DB8NNN □		7.0pF	50	±0.5pF	0.90
27	CL10C7R5DB8NNN □		7.5pF	50	±0.5pF	0.90
28	CL10C080DB8NNN □		8.0pF	50	±0.5pF	0.90
29	CL10C8R2DB8NNN □		8.2pF	50	±0.5pF	0.90

※ □ mark means packaging code. If you want to learn the code or quantity in detail, please see p74.



**Product Lineup (Standard & High Capacitors-C0G)**

	Part Number	Size L x W (mm)	Capacitance	Rated Voltage (Vdc)	Capacitance Tolerance	Thickness Max.(mm)
30	CL10C090DB8NNN □	1.60×0.80	9.0 pF	50	±0.5pF	0.90
31	CL10C9R1DB8NNN □		9.1 pF	50	±0.5pF	0.90
32	CL10C100JB8NNN □		10 pF	50	±5%	0.90
33	CL10C110JB8NNN □		11 pF	50	±5%	0.90
34	CL10C120JB8NNN □		12 pF	50	±5%	0.90
35	CL10C130JB8NNN □		13 pF	50	±5%	0.90
36	CL10C140JB8NNN □		14 pF	50	±5%	0.90
37	CL10C150JB8NNN □		15 pF	50	±5%	0.90
38	CL10C160JB8NNN □		16 pF	50	±5%	0.90
39	CL10C180JB8NNN □		18 pF	50	±5%	0.90
40	CL10C200JB8NNN □		20 pF	50	±5%	0.90
41	CL10C220JB8NNN □		22 pF	50	±5%	0.90
42	CL10C240JB8NNN □		24 pF	50	±5%	0.90
43	CL10C250JB8NNN □		25 pF	50	±5%	0.90
44	CL10C270JB8NNN □		27 pF	50	±5%	0.90
45	CL10C300JB8NNN □		30 pF	50	±5%	0.90
46	CL10C330JB8NNN □		33 pF	50	±5%	0.90
47	CL10C360JB8NNN □		36 pF	50	±5%	0.90
48	CL10C390JB8NNN □		39 pF	50	±5%	0.90
49	CL10C430JB8NNN □		43 pF	50	±5%	0.90
50	CL10C470JB8NNN □		47 pF	50	±5%	0.90
51	CL10C510JB8NNN □		51 pF	50	±5%	0.90
52	CL10C560JB8NNN □		56 pF	50	±5%	0.90
53	CL10C620JB8NNN □		62 pF	50	±5%	0.90
54	CL10C680JB8NNN □		68 pF	50	±5%	0.90
55	CL10C750JB8NNN □		75 pF	50	±5%	0.90
56	CL10C820JB8NNN □		82 pF	50	±5%	0.90
57	CL10C910JB8NNN □		91 pF	50	±5%	0.90
58	CL10C101JB8NNN □		100 pF	50	±5%	0.90
59	CL10C111JB8NNN □		110 pF	50	±5%	0.90
60	CL10C121JB8NNN □		120 pF	50	±5%	0.90
61	CL10C131JB8NNN □		130 pF	50	±5%	0.90
62	CL10C151JB8NNN □		150 pF	50	±5%	0.90
63	CL10C161JB8NNN □		160 pF	50	±5%	0.90
64	CL10C181JB8NNN □		180 pF	50	±5%	0.90
65	CL10C201JB8NNN □		200 pF	50	±5%	0.90
66	CL10C221JB8NNN □		220 pF	50	±5%	0.90
67	CL10C241JB8NNN □		240 pF	50	±5%	0.90
68	CL10C271JB8NNN □		270 pF	50	±5%	0.90
69	CL10C301JB8NNN □		300 pF	50	±5%	0.90
70	CL10C331JB8NNN □		330 pF	50	±5%	0.90
71	CL10C361JB8NNN □		360 pF	50	±5%	0.90
72	CL10C391JB8NNN □		390 pF	50	±5%	0.90
73	CL10C431JB8NNN □		430 pF	50	±5%	0.90
74	CL10C471JB8NNN □		470 pF	50	±5%	0.90
75	CL10C511JB8NNN □		510 pF	50	±5%	0.90
76	CL10C561JB8NNN □		560 pF	50	±5%	0.90
77	CL10C621JB8NNN □		620 pF	50	±5%	0.90
78	CL10C681JB8NNN □		680 pF	50	±5%	0.90
79	CL10C751JB8NNN □		750 pF	50	±5%	0.90

Part Numbering System

Standard & High Capacitors

Super Small Size Capacitors

High-Q Capacitors

Medium-High Voltage Capacitors

Array Type Capacitors

Low ESL Capacitors

Reliability Test Condition

Premium Capacitors for Automotive Applications

Packaging Specification

Application Manual for Surface Mounting

※ □ mark means packaging code. If you want to learn the code or quantity in detail, please see p74.



**Product Lineup (Standard & High Capacitors-C0G)**

	Part Number	Size L x W (mm)	Capacitance	Rated Voltage (Vdc)	Capacitance Tolerance	Thickness Max.(mm)
80	CL10C821JB8NNN □	1.60×0.80	820 pF	50	±5%	0.90
81	CL10C102JB8NNN □		1 nF	50	±5%	0.90
82	CL10C182JB8NNN □		1.8 nF	50	±5%	0.90
83	CL10C222JB8NNN □		2.2 nF	50	±5%	0.90
84	CL10C562JB8NNN □		5.6 nF	50	±5%	0.90
85	CL10C103JA8NNN □		10 nF	25	±5%	0.90
1	CL21CR47CBANNN □	2.00×1.25	0.47 pF	50	±0.25 pF	0.75
2	CL21C0R5CBANNN □		0.5 pF	50	±0.25 pF	0.75
3	CL21C010CBANNN □		1.0 pF	50	±0.25 pF	0.75
4	CL21C1R2CBANNN □		1.2 pF	50	±0.25 pF	0.75
5	CL21C1R5CBANNN □		1.5 pF	50	±0.25 pF	0.75
6	CL21C1R8CBANNN □		1.8 pF	50	±0.25 pF	0.75
7	CL21C020CBANNN □		2.0 pF	50	±0.25 pF	0.75
8	CL21C2R2CBANNN □		2.2 pF	50	±0.25 pF	0.75
9	CL21C2R4CBANNN □		2.4 pF	50	±0.25 pF	0.75
10	CL21C2R5CBANNN □		2.5 pF	50	±0.25 pF	0.75
11	CL21C2R7CBANNN □		2.7 pF	50	±0.25 pF	0.75
12	CL21C030CBANNN □		3.0 pF	50	±0.25 pF	0.75
13	CL21C3R2CBANNN □		3.2 pF	50	±0.25 pF	0.75
14	CL21C3R3CBANNN □		3.3 pF	50	±0.25 pF	0.75
15	CL21C3R6CBANNN □		3.6 pF	50	±0.25 pF	0.75
16	CL21C3R9CBANNN □		3.9 pF	50	±0.25 pF	0.75
17	CL21C040CBANNN □		4.0 pF	50	±0.25 pF	0.75
18	CL21C4R7CBANNN □		4.7 pF	50	±0.25 pF	0.75
19	CL21C5R6DBANNN □		5.6 pF	50	±0.5 pF	0.75
20	CL21C060DBANNN □		6.0 pF	50	±0.5 pF	0.75
21	CL21C6R8DBANNN □		6.8 pF	50	±0.5 pF	0.75
22	CL21C070DBANNN □		7.0 pF	50	±0.5 pF	0.75
23	CL21C7R5DBANNN □		7.5 pF	50	±0.5 pF	0.75
24	CL21C080DBANNN □		8.0 pF	50	±0.5 pF	0.75
25	CL21C8R2DBANNN □		8.2 pF	50	±0.5 pF	0.75
26	CL21C090DBANNN □		9.0 pF	50	±0.5 pF	0.75
27	CL21C100JBANNN □		10 pF	50	±5%	0.75
28	CL21C120JBANNN □		12 pF	50	±5%	0.75
29	CL21C130JBANNN □		13 pF	50	±5%	0.75
30	CL21C140JBANNN □		14 pF	50	±5%	0.75
31	CL21C150JBANNN □		15 pF	50	±5%	0.75
32	CL21C160JBANNN □		16 pF	50	±5%	0.75
33	CL21C180JBANNN □		18 pF	50	±5%	0.75
34	CL21C200JBANNN □		20 pF	50	±5%	0.75
35	CL21C220JBANNN □		22 pF	50	±5%	0.75
36	CL21C240JBANNN □		24 pF	50	±5%	0.75
37	CL21C250JBANNN □		25 pF	50	±5%	0.75
38	CL21C270JBANNN □		27 pF	50	±5%	0.75
39	CL21C300JBANNN □		30 pF	50	±5%	0.75
40	CL21C330JBANNN □		33 pF	50	±5%	0.75
41	CL21C360JBANNN □		36 pF	50	±5%	0.75
42	CL21C390JBANNN □		39 pF	50	±5%	0.75
43	CL21C430JBANNN □		43 pF	50	±5%	0.75
44	CL21C470JBANNN □		47 pF	50	±5%	0.75
45	CL21C510JBANNN □		51 pF	50	±5%	0.75

※ □ mark means packaging code. If you want to learn the code or quantity in detail, please see p74.

Product Lineup (Standard & High Capacitors-C0G)

	Part Number	Size L x W (mm)	Capacitance	Rated Voltage (Vdc)	Capacitance Tolerance	Thickness Max.(mm)
46	CL21C560JBANNN □	2.00×1.25	56 pF	50	±5%	0.75
47	CL21C620JBANNN □		62 pF	50	±5%	0.75
48	CL21C680JBANNN □		68 pF	50	±5%	0.75
49	CL21C750JBANNN □		75 pF	50	±5%	0.75
50	CL21C820JBANNN □		82 pF	50	±5%	0.75
51	CL21C910JBANNN □		91 pF	50	±5%	0.75
52	CL21C101JBANNN □		100 pF	50	±5%	0.75
53	CL21C111JBANNN □		110 pF	50	±5%	0.75
54	CL21C121JBANNN □		120 pF	50	±5%	0.75
55	CL21C131JBANNN □		130 pF	50	±5%	0.75
56	CL21C151JBANNN □		150 pF	50	±5%	0.75
57	CL21C161JBANNN □		160 pF	50	±5%	0.75
58	CL21C181JBANNN □		180 pF	50	±5%	0.75
59	CL21C201JBANNN □		200 pF	50	±5%	0.75
60	CL21C221JBANNN □		220 pF	50	±5%	0.75
61	CL21C241JBANNN □		240 pF	50	±5%	0.75
62	CL21C271JBANNN □		270 pF	50	±5%	0.75
63	CL21C301JBANNN □		300 pF	50	±5%	0.75
64	CL21C331JBANNN □		330 pF	50	±5%	0.75
65	CL21C361JBANNN □		360 pF	50	±5%	0.75
66	CL21C391JBANNN □		390 pF	50	±5%	0.75
67	CL21C431JBANNN □		430 pF	50	±5%	0.75
68	CL21C471JBANNN □		470 pF	50	±5%	0.75
69	CL21C511JBANNN □		510 pF	50	±5%	0.75
70	CL21C561JBANNN □		560 pF	50	±5%	0.75
71	CL21C621JBCNNN □		620 pF	50	±5%	0.95
72	CL21C681JBCNNN □		680 pF	50	±5%	0.95
73	CL21C751JBCNNN □		750 pF	50	±5%	0.95
74	CL21C821JBCNNN □		820 pF	50	±5%	0.95
75	CL21C102JBCNNN □		1 nF	50	±5%	0.95
76	CL21C122JBFNNN □		1.2 nF	50	±5%	1.35
77	CL21C152JBFNNN □		1.5 nF	50	±5%	1.35
78	CL21C182JBFNNN □		1.8 nF	50	±5%	1.35
79	CL21C222JBFNNN □		2.2 nF	50	±5%	1.35
80	CL21C332JAFNNN □		3.3 nF	25	±5%	1.35
81	CL21C332JBFNNN □		3.3 nF	50	±5%	1.35
82	CL21C392JAANNN □		3.9 nF	25	±5%	0.75
83	CL21C392JBFNNN □		3.9 nF	50	±5%	1.35
84	CL21C472JBFNNN □	4.7 nF	50	±5%	1.35	
85	CL21C562JBFNNN □	5.6 nF	50	±5%	1.35	
86	CL21C822JAFNNN □	8.2 nF	25	±5%	1.35	
87	CL21C103JBFNNN □	10 nF	50	±5%	1.35	
88	CL21C333JAFNNN □	33 nF	25	±5%	1.35	
1	CL31C0R5CBCNNN □	3.20×1.60	0.5 pF	50	±0.25 pF	1.00
2	CL31C010CBCNNN □		1.0 pF	50	±0.25 pF	1.00
3	CL31C1R5CBCNNN □		1.5 pF	50	±0.25 pF	1.00
4	CL31C1R8CBCNNN □		1.8 pF	50	±0.25 pF	1.00
5	CL31C020CBCNNN □		2.0 pF	50	±0.25 pF	1.00
6	CL31C2R2CBCNNN □		2.2 pF	50	±0.25 pF	1.00
7	CL31C2R7CBCNNN □		2.7 pF	50	±0.25 pF	1.00

※ □ mark means packaging code. If you want to learn the code or quantity in detail, please see p74.

Part Numbering  
System

Standard &  
High Capacitors

Super Small Size  
Capacitors

High-Q  
Capacitors

Medium-High  
Voltage Capacitors

Array Type  
Capacitors

Low ESL  
Capacitors

Reliability Test  
Condition

Premium Capacitors  
for Automotive  
Applications

Packaging  
Specification

Application Manual  
for Surface Mounting



**Product Lineup (Standard & High Capacitors-C0G)**

	Part Number	Size L x W (mm)	Capacitance	Rated Voltage (Vdc)	Capacitance Tolerance	Thickness Max.(mm)	
8	CL31C030CBCN <input type="checkbox"/>	3.20×1.60	3.0 pF	50	±0.25 pF	1.00	
9	CL31C3R3CBCN <input type="checkbox"/>		3.3 pF	50	±0.25 pF	1.00	
10	CL31C040CBCN <input type="checkbox"/>		4.0 pF	50	±0.25 pF	1.00	
11	CL31C4R7CBCN <input type="checkbox"/>		4.7 pF	50	±0.25 pF	1.00	
12	CL31C100JBCN <input type="checkbox"/>		10 pF	50	±5%	1.00	
13	CL31C120JBCN <input type="checkbox"/>		12 pF	50	±5%	1.00	
14	CL31C150JBCN <input type="checkbox"/>		15 pF	50	±5%	1.00	
15	CL31C180JBCN <input type="checkbox"/>		18 pF	50	±5%	1.00	
16	CL31C200JBCN <input type="checkbox"/>		20 pF	50	±5%	1.00	
17	CL31C220JBCN <input type="checkbox"/>		22 pF	50	±5%	1.00	
18	CL31C270JBCN <input type="checkbox"/>		27 pF	50	±5%	1.00	
19	CL31C300JBCN <input type="checkbox"/>		30 pF	50	±5%	1.00	
20	CL31C330JBCN <input type="checkbox"/>		33 pF	50	±5%	1.00	
21	CL31C390JBCN <input type="checkbox"/>		39 pF	50	±5%	1.00	
22	CL31C470JBCN <input type="checkbox"/>		47 pF	50	±5%	1.00	
23	CL31C510JBCN <input type="checkbox"/>		51 pF	50	±5%	1.00	
24	CL31C560JBCN <input type="checkbox"/>		56 pF	50	±5%	1.00	
25	CL31C680JBCN <input type="checkbox"/>		68 pF	50	±5%	1.00	
26	CL31C750JBCN <input type="checkbox"/>		75 pF	50	±5%	1.00	
27	CL31C820JBCN <input type="checkbox"/>		82 pF	50	±5%	1.00	
28	CL31C101JBCN <input type="checkbox"/>		100 pF	50	±5%	1.00	
29	CL31C121JBCN <input type="checkbox"/>		120 pF	50	±5%	1.00	
30	CL31C151JBCN <input type="checkbox"/>		150 pF	50	±5%	1.00	
31	CL31C181JBCN <input type="checkbox"/>		180 pF	50	±5%	1.00	
32	CL31C221JBCN <input type="checkbox"/>		220 pF	50	±5%	1.00	
33	CL31C271JBCN <input type="checkbox"/>		270 pF	50	±5%	1.00	
34	CL31C331JBCN <input type="checkbox"/>		330 pF	50	±5%	1.00	
35	CL31C391JBCN <input type="checkbox"/>		390 pF	50	±5%	1.00	
36	CL31C471JBCN <input type="checkbox"/>		470 pF	50	±5%	1.00	
37	CL31C561JBCN <input type="checkbox"/>		560 pF	50	±5%	1.00	
38	CL31C681JBCN <input type="checkbox"/>		680 pF	50	±5%	1.00	
39	CL31C821JBCN <input type="checkbox"/>		820 pF	50	±5%	1.00	
40	CL31C102JBCN <input type="checkbox"/>		1 nF	50	±5%	1.00	
41	CL31C122JBCN <input type="checkbox"/>		1.2 nF	50	±5%	1.00	
42	CL31C152JBCN <input type="checkbox"/>		1.5 nF	50	±5%	1.00	
43	CL31C182JBCN <input type="checkbox"/>		1.8 nF	50	±5%	1.00	
44	CL31C222JBCN <input type="checkbox"/>		2.2 nF	50	±5%	1.00	
45	CL31C272JBFN <input type="checkbox"/>		2.7 nF	50	±5%	1.40	
46	CL31C332JBFN <input type="checkbox"/>		3.3 nF	50	±5%	1.40	
47	CL31C472JBFN <input type="checkbox"/>		4.7 nF	50	±5%	1.40	
48	CL31C682JBHN <input type="checkbox"/>		6.8 nF	50	±5%	1.80	
49	CL31C103JAFN <input type="checkbox"/>		10 nF	25	±5%	1.40	
50	CL31C223JBHN <input type="checkbox"/>		22 nF	50	±5%	1.80	
51	CL31C333JBHN <input type="checkbox"/>		33 nF	50	±5%	1.80	
52	CL31C473JBHN <input type="checkbox"/>		47 nF	50	±5%	1.80	
53	CL31C683JAHN <input type="checkbox"/>		68 nF	25	±5%	1.80	
54	CL31C104JAHN <input type="checkbox"/>		100 nF	25	±5%	1.80	
1	CL32C472JBFN <input type="checkbox"/>		3.20×2.50	4.7 nF	50	±5%	1.45
2	CL32C103JBFN <input type="checkbox"/>			10 nF	50	±5%	1.45
3	CL32C223JBHN <input type="checkbox"/>			22 nF	50	±5%	1.80
4	CL32C333JBHN <input type="checkbox"/>			33 nF	50	±5%	1.80
5	CL32C473JBHN <input type="checkbox"/>			47 nF	50	±5%	1.80

※  mark means packaging code. If you want to learn the code or quantity in detail, please see p74.

Product Lineup (Standard & High Capacitors-X5R)

	Part Number	Size L x W (mm)	Capacitance	Rated Voltage (Vdc)	Capacitance Tolerance	Thickness Max.(mm)
1	CL05A223KO5NNN□	1.00×0.50	22 nF	16	±10%	0.55
2	CL05A104KA5NNN□		0.1 μF	25	±10%	0.55
3	CL05A104KO5NNN□		0.1 μF	16	±10%	0.55
4	CL05A104KP5NNN□		0.1 μF	10	±10%	0.55
5	CL05A224KA5NNN□		0.22 μF	25	±10%	0.55
6	CL05A224KP5NNN□		0.22 μF	10	±10%	0.55
7	CL05A334KA5NNN□		0.33 μF	25	±10%	0.55
8	CL05A334KP5NNN□		0.33 μF	10	±10%	0.55
9	CL05A474KA5NNN□		0.47 μF	25	±10%	0.55
10	CL05A474KO5NNN□		0.47 μF	16	±10%	0.55
11	CL05A474KP5NNN□		0.47 μF	10	±10%	0.55
12	CL05A474KQ5NNN□		0.47 μF	6.3	±10%	0.55
13	CL05A474KR5NNN□		0.47 μF	4	±10%	0.55
14	CL05A105KA5NQ□		1 μF	25	±10%	0.60
15	CL05A105KO5NNN□		1 μF	16	±10%	0.55
16	CL05A105KO3LQ□		1 μF	16	±10%	0.33
17	CL05A105KP5NNN□		1 μF	10	±10%	0.55
18	CL05A105KP3LNN□		1 μF	10	±10%	0.33
19	CL05A105KQ5NNN□		1 μF	6.3	±10%	0.55
20	CL05A105KQ3LNN□		1 μF	6.3	±10%	0.33
21	CL05A105KR5NNN□		1 μF	4	±10%	0.55
22	CL05A105KR3LNN□		1 μF	4	±10%	0.33
23	CL05A225MA5NUN□		2.2 μF	25	±20%	0.70
24	CL05A225KO5NQ□		2.2 μF	16	±10%	0.60
25	CL05A225MP5NS□		2.2 μF	10	±20%	0.57
26	CL05A225KP3LR□		2.2 μF	10	±10%	0.33
27	CL05A225MQ5NN□		2.2 μF	6.3	±20%	0.55
28	CL05A225KQ3LR□		2.2 μF	6.3	±10%	0.33
29	CL05A225MR5NN□		2.2 μF	4	±20%	0.55
30	CL05A225KR3LR□		2.2 μF	4	±10%	0.33
31	CL05A475MO5NUN□		4.7 μF	16	±20%	0.70
32	CL05A475MP5NR□		4.7 μF	10	±20%	0.65
33	CL05A475MQ5NR□		4.7 μF	6.3	±20%	0.65
34	CL05A475MQ3LUN□		4.7 μF	6.3	±20%	0.35
35	CL05A106MP5NUN□		10 μF	10	±20%	0.70
36	CL05A106MQ5NUN□		10 μF	6.3	±20%	0.70
37	CL05A106MR5NR□		10 μF	4	±20%	0.65
38	CL05A156MR5NUN□		15 μF	4	±20%	0.70
39	CL05A226MR5NZ□		22 μF	4	±20%	0.90
1	CL10A474KB8NNN□	1.60×0.80	0.47 μF	50	±10%	0.90
2	CL10A474KA8NNN□		0.47 μF	25	±10%	0.90
3	CL10A474KP8NNN□		0.47 μF	10	±10%	0.90
4	CL10A474KQ8NNN□		0.47 μF	6.3	±10%	0.90
5	CL10A474KR8NNN□		0.47 μF	4	±10%	0.90
6	CL10A105KB8NNN□		1 μF	50	±10%	0.90
7	CL10A105KA5LNN□		1 μF	25	±10%	0.50
8	CL10A105KA8NNN□		1 μF	25	±10%	0.90
9	CL10A105KO8NNN□		1 μF	16	±10%	0.90
10	CL10A105KO5LNN□		1 μF	16	±10%	0.50
11	CL10A105KP8NNN□		1 μF	10	±10%	0.90
12	CL10A105KP5LNN□		1 μF	10	±10%	0.50
13	CL10A105KQ8NNN□		1 μF	6.3	±10%	0.90
14	CL10A105KQ5LNN□		1 μF	6.3	±10%	0.50

Part Numbering System

Standard & High Capacitors

Super Small Size Capacitors

High-Q Capacitors

Medium-High Voltage Capacitors

Array Type Capacitors

Low ESL Capacitors

Reliability Test Condition

Premium Capacitors for Automotive Applications

Packaging Specification

Application Manual for Surface Mounting

※ □ mark means packaging code. If you want to learn the code or quantity in detail, please see p74.



**Product Lineup (Standard & High Capacitors-X5R)**

	Part Number	Size L x W (mm)	Capacitance	Rated Voltage (Vdc)	Capacitance Tolerance	Thickness Max.(mm)
15	CL10A105KR8NNN □	1.60×0.80	1 μF	4	±10%	0.90
16	CL10A105KR5LNN □		1 μF	4	±10%	0.50
17	CL10A105KA5LNN □		1 μF	25	±10%	0.50
18	CL10A225KA8NNN □		2.2 μF	25	±10%	0.90
19	CL10A225KA5LNN □		2.2 μF	25	±10%	0.50
20	CL10A225KO8NNN □		2.2 μF	16	±10%	0.90
21	CL10A225KO5LNN □		2.2 μF	16	±10%	0.50
22	CL10A225KP8NNN □		2.2 μF	10	±10%	0.90
23	CL10A225KP5LNN □		2.2 μF	10	±10%	0.50
24	CL10A225KQ8NNN □		2.2 μF	6.3	±10%	0.90
25	CL10A225KQ5LNN □		2.2 μF	6.3	±10%	0.50
26	CL10A225KR8NNN □		2.2 μF	4	±10%	0.90
27	CL10A225KR5LNN □		2.2 μF	4	±10%	0.50
28	CL10A335KQ8NNN □		3.3 μF	6.3	±10%	0.90
29	CL10A335KR8NNN □		3.3 μF	4	±10%	0.90
30	CL10A475KA8NQN □		4.7 μF	25	±10%	0.95
31	CL10A475KO8NNN □		4.7 μF	16	±10%	0.90
32	CL10A475KP8NNN □		4.7 μF	10	±10%	0.90
33	CL10A475KP5LNN □		4.7 μF	10	±10%	0.50
34	CL10A475KQ5LNN □		4.7 μF	6.3	±10%	0.50
35	CL10A475KQ8NNN □		4.7 μF	6.3	±10%	0.90
36	CL10A475KR5LNN □		4.7 μF	4	±10%	0.50
37	CL10A475KR8NNN □		4.7 μF	4	±10%	0.90
38	CL10A106KR8NNN □		10 μF	4	±10%	0.90
39	CL10A106MR5LRN □		10 μF	4	±20%	0.50
40	CL10A106KQ8NNN □		10 μF	6.3	±10%	0.90
41	CL10A106MQ5LRN □		10 μF	6.3	±20%	0.50
42	CL10A106MP8NNN □		10 μF	10	±20%	0.90
43	CL10A106MO8NQN □		10 μF	16	±20%	0.95
44	CL10A106MA8NRRN □		10 μF	25	±20%	1.00
45	CL10A226MR8NRRN □	22 μF	4	±20%	1.00	
46	CL10A226MQ8NRRN □	22 μF	6.3	±20%	1.00	
47	CL10A226MP8NRRN □	22 μF	10	±20%	1.00	
48	CL10A226MP8NUN □	22 μF	10	±20%	1.05	
49	CL10A476MR8NZN □	47 μF	4	±20%	1.10	
50	CL10A476MQ8CZN □	47 μF	6.3	±20%	1.10	
1	CL21A105KBQNNN □	2.00×1.25	1 μF	50	±10%	1.40
2	CL21A105KAFNNN □		1 μF	25	±10%	1.35
3	CL21A105KA6LNN □		1 μF	25	±10%	0.70
4	CL21A105KOFNNN □		1 μF	16	±10%	1.35
5	CL21A105KO6LNN □		1 μF	16	±10%	0.70
6	CL21A105KQFNNN □		1 μF	6.3	±10%	1.35
7	CL21A105KRFNNN □		1 μF	4	±10%	1.35
8	CL21A225KBQNNN □		2.2 μF	50	±10%	1.40
9	CL21A225KAFNNN □		2.2 μF	25	±10%	1.35
10	CL21A225KO6LNN □		2.2 μF	16	±10%	0.70
11	CL21A225KOFNNN □		2.2 μF	16	±10%	1.35
12	CL21A225KPFNNN □		2.2 μF	10	±10%	1.35
13	CL21A225KQFNNN □		2.2 μF	6.3	±10%	1.35
14	CL21A225KRFNNN □		2.2 μF	4	±10%	1.35
15	CL21A475KBQNNN □		4.7 μF	50	±10%	1.40

※ □ mark means packaging code. If you want to learn the code or quantity in detail, please see p74.



Product Lineup (Standard & High Capacitors-X5R)

	Part Number	Size L x W (mm)	Capacitance	Rated Voltage (Vdc)	Capacitance Tolerance	Thickness Max.(mm)
16	CL21A475KAQNNN□	2.00×1.25	4.7μF	25	±10%	1.40
17	CL21A475KACL RN□		4.7μF	25	±10%	0.95
18	CL21A475KOFNNN□		4.7μF	16	±10%	1.35
19	CL21A475KOCLNN□		4.7μF	16	±10%	0.95
20	CL21A475KPFNNN□		4.7μF	10	±10%	1.35
21	CL21A475KPCLNN□		4.7μF	10	±10%	0.95
22	CL21A475KQFNNN□		4.7μF	6.3	±10%	1.35
23	CL21A475KQCLNN□		4.7μF	6.3	±10%	0.95
24	CL21A475KRFNNN□		4.7μF	4	±10%	1.35
25	CL21A475KRCLNN□		4.7μF	4	±10%	0.95
26	CL21A106KAYNNN□		10μF	25	±10%	1.45
27	CL21A106KACL RN□		10μF	25	±10%	0.95
28	CL21A106KA7LQN□		10μF	25	±10%	0.80
29	CL21A106KOFNNN□		10μF	16	±10%	1.35
30	CL21A106KQNNN□		10μF	16	±10%	1.40
31	CL21A106KOCL RN□		10μF	16	±10%	0.95
32	CL21A106KOCL3R□		10μF	16	±10%	0.95
33	CL21A106KPFNNN□		10μF	10	±10%	1.35
34	CL21A106KPCLQN□		10μF	10	±10%	0.95
35	CL21A106KQFNNN□		10μF	6.3	±10%	1.35
36	CL21A106KQCLNN□		10μF	6.3	±10%	0.95
37	CL21A106KRFNNN□		10μF	4	±10%	1.35
38	CL21A106KRCLNN□		10μF	4	±10%	0.95
39	CL21A226MAQNNN□		22μF	25	±20%	1.40
40	CL21A226MPQNNN□		22μF	10	±20%	1.40
41	CL21A226MPCL RN□		22μF	10	±20%	0.95
42	CL21A226MQNNN□		22μF	6.3	±20%	1.40
43	CL21A226MQCL RN□		22μF	6.3	±20%	0.95
44	CL21A226MRQNNN□		22μF	4	±20%	1.40
45	CL21A226MRCL RN□		22μF	4	±20%	0.95
46	CL21A336MQELNN□		33μF	6.3	±20%	1.20
47	CL21A336MQ9LNN□		33μF	6.3	±20%	1.00
48	CL21A336MRELNN□	33μF	4	±20%	1.20	
49	CL21A336MR9LNN□	33μF	4	±20%	1.00	
50	CL21A476MQYNNN□	47μF	6.3	±20%	1.45	
51	CL21A476MRYNNN□	47μF	4	±20%	1.45	
52	CL21A476MQ9L RN□	47μF	6.3	±20%	1.00	
1	CL31A225KC9LNN□	3.20×1.60	2.2μF	100	±10%	1.00
2	CL31A475KBHNNN□		4.7μF	50	±10%	1.80
3	CL31A475KB9LNN□		4.7μF	50	±10%	1.00
4	CL31A475KAHNNN□		4.7μF	25	±10%	1.80
5	CL31A475KACL NN□		4.7μF	25	±10%	0.95
6	CL31A475KOHNNN□		4.7μF	16	±10%	1.80
7	CL31A475KOCL NN□		4.7μF	16	±10%	0.95
8	CL31A475KPHNNN□		4.7μF	10	±10%	1.80
9	CL31A475KQHNNN□		4.7μF	6.3	±10%	1.80
10	CL31A475KRHNNN□		4.7μF	4	±10%	1.80
11	CL31A106KBHNNN□		10μF	50	±10%	1.80
12	CL31A106KAHNNN□		10μF	25	±10%	1.80
13	CL31A106KACL NN□		10μF	25	±10%	0.95
14	CL31A106KOHNNN□		10μF	16	±10%	1.80

※ □ mark means packaging code. If you want to learn the code or quantity in detail, please see p74.

Part Numbering  
System

Standard &  
High Capacitors

Super Small Size  
Capacitors

High-Q  
Capacitors

Medium-High  
Voltage Capacitors

Array Type  
Capacitors

Low ESL  
Capacitors

Reliability Test  
Condition

Premium Capacitors  
for Automotive  
Applications

Packaging  
Specification

Application Manual  
for Surface Mounting



**Product Lineup (Standard & High Capacitors-X5R)**

	Part Number	Size L x W (mm)	Capacitance	Rated Voltage (Vdc)	Capacitance Tolerance	Thickness Max.(mm)
15	CL31A106KOCLNN □	3.20×1.60	10 $\mu$ F	16	±10%	0.95
16	CL31A106KPHNNN □		10 $\mu$ F	10	±10%	1.80
17	CL31A106KPCLNN □		10 $\mu$ F	10	±10%	0.95
18	CL31A106KQHNNN □		10 $\mu$ F	6.3	±10%	1.80
19	CL31A106KRHNNN □		10 $\mu$ F	4	±10%	1.80
20	CL31A156KQHNNN □		15 $\mu$ F	6.3	±10%	1.80
21	CL31A156KRHNNN □		15 $\mu$ F	4	±10%	1.80
22	CL31A226KAHNNN □		22 $\mu$ F	25	±10%	1.80
23	CL31A226KOHNNN □		22 $\mu$ F	16	±10%	1.80
24	CL31A226KOCLNN □		22 $\mu$ F	16	±10%	0.95
25	CL31A226KPHNNN □		22 $\mu$ F	10	±10%	1.80
26	CL31A226KPCLNN □		22 $\mu$ F	10	±10%	0.95
27	CL31A226KQHNNN □		22 $\mu$ F	6.3	±10%	1.80
28	CL31A476KPHNNN □		47 $\mu$ F	10	±10%	1.80
29	CL31A476MQHNNN □		47 $\mu$ F	6.3	±20%	1.80
30	CL31A476MRHNNN □		47 $\mu$ F	4	±20%	1.80
31	CL31A107MQHNNN □		100 $\mu$ F	6.3	±20%	1.80
32	CL31A107MRHNNN □		100 $\mu$ F	4	±20%	1.80
33	CL31A107MPHNNN □		100 $\mu$ F	10	±20%	1.80
1	CL32A106KQCLNN □		3.20×2.50	10 $\mu$ F	6.3	±10%
2	CL32A106KRCLNN □	10 $\mu$ F		4	±10%	0.95
3	CL32A106KBULNN □	10 $\mu$ F		50	±10%	2.00
4	CL32A106KAJNNN □	10 $\mu$ F		25	±10%	2.70
5	CL32A106KAULNN □	10 $\mu$ F		25	±10%	2.00
6	CL32A106KOJNNN □	10 $\mu$ F		16	±10%	2.70
7	CL32A106KPJNNN □	10 $\mu$ F		10	±10%	2.70
8	CL32A226KAJNNN □	22 $\mu$ F		25	±10%	2.70
9	CL32A226KOJNNN □	22 $\mu$ F		16	±10%	2.70
10	CL32A226KOCLNN □	22 $\mu$ F		16	±10%	0.95
11	CL32A226KPJNNN □	22 $\mu$ F		10	±10%	2.70
12	CL32A226KQJNNN □	22 $\mu$ F		6.3	±10%	2.70
13	CL32A226MQCLNN □	22 $\mu$ F		6.3	±20%	0.95
14	CL32A226KRJNNN □	22 $\mu$ F		4	±10%	2.70
15	CL32A226MRCLNN □	22 $\mu$ F		4	±20%	0.95
16	CL32A476KOJNNN □	47 $\mu$ F		16	±10%	2.70
17	CL32A476KPJNNN □	47 $\mu$ F		10	±10%	2.70
18	CL32A476MQJNNN □	47 $\mu$ F		6.3	±20%	2.70
19	CL32A476MRJNNN □	47 $\mu$ F		4	±20%	2.70
20	CL32A107MPVNNN □	100 $\mu$ F		10	±20%	2.80
21	CL32A107MQVNNN □	100 $\mu$ F		6.3	±20%	2.80
22	CL32A107MRVNNN □	100 $\mu$ F		4	±20%	2.80
23	CL32A157MQVNNN □	150 $\mu$ F		6.3	±20%	2.80
24	CL32A227MQVNNN □	220 $\mu$ F		6.3	±20%	2.80
1	CL43A476MQJNNN □	4.50×3.20	47 $\mu$ F	6.3	±20%	2.70
2	CL43A476MRJNNN □		47 $\mu$ F	4	±20%	2.70
3	CL43A107KQLNNN □		100 $\mu$ F	6.3	±10%	3.50
4	CL43A107KRLNNN □		100 $\mu$ F	4	±10%	3.50

※ □ mark means packaging code. If you want to learn the code or quantity in detail, please see p74.

Product Lineup (Standard & High Capacitors-X6S)

	Part Number	Size L x W (mm)	Capacitance	Rated Voltage (Vdc)	Capacitance Tolerance	Thickness Max.(mm)
1	CL05X224KP5NNN □	1.00×0.50	0.22 $\mu$ F	10	±10%	0.55
2	CL05X224KQ5NNN □		0.22 $\mu$ F	6.3	±10%	0.55
3	CL05X474KP5NNN □		0.47 $\mu$ F	10	±10%	0.55
4	CL05X474KQ5NNN □		0.47 $\mu$ F	6.3	±10%	0.55
5	CL05X474MR5NNN □		0.47 $\mu$ F	4	±20%	0.55
6	CL05X684JQ5NNN □		0.68 $\mu$ F	6.3	±5%	0.55
7	CL05X105KA5NQN □		1 $\mu$ F	25	±10%	0.60
8	CL05X105KP5NNN □		1 $\mu$ F	10	±10%	0.55
9	CL05X105MQ3LNN □		1 $\mu$ F	6.3	±20%	0.33
10	CL05X225MP5NUN □		2.2 $\mu$ F	10	±20%	0.70
11	CL05X475MQ5NUN □		4.7 $\mu$ F	6.3	±20%	0.70
12	CL05X106MR5NUN □		10 $\mu$ F	4	±20%	0.70
1	CL10X474KA8NNN □	1.60×0.80	0.47 $\mu$ F	25	±10%	0.90
2	CL10X474KO8NNN □		0.47 $\mu$ F	16	±10%	0.90
3	CL10X474KP8NNN □		0.47 $\mu$ F	10	±10%	0.90
4	CL10X474KQ8NNN □		0.47 $\mu$ F	6.3	±10%	0.90
5	CL10X474KR8NNN □		0.47 $\mu$ F	4	±10%	0.90
6	CL10X105KA8NNN □		1 $\mu$ F	25	±10%	0.90
7	CL10X105KO8NNN □		1 $\mu$ F	16	±10%	0.90
8	CL10X105KP8NNN □		1 $\mu$ F	10	±10%	0.90
9	CL10X105KQ8NNN □		1 $\mu$ F	6.3	±10%	0.90
10	CL10X105KR8NNN □		1 $\mu$ F	4	±10%	0.90
11	CL10X225KO8NNN □		2.2 $\mu$ F	16	±10%	0.90
12	CL10X225KP8NNN □		2.2 $\mu$ F	10	±10%	0.90
13	CL10X225KQ8NNN □		2.2 $\mu$ F	6.3	±10%	0.90
14	CL10X225KR8NNN □		2.2 $\mu$ F	4	±10%	0.90
15	CL10X475KA8NQN □		4.7 $\mu$ F	25	±10%	0.95
16	CL10X475KO8NQN □		4.7 $\mu$ F	16	±10%	0.95
17	CL10X475KP5NNN □		4.7 $\mu$ F	10	±10%	0.90
18	CL10X475KQ8NNN □		4.7 $\mu$ F	6.3	±10%	0.90
19	CL10X475KR8NNN □		4.7 $\mu$ F	4	±10%	0.90
20	CL10X106MP8NNN □		10 $\mu$ F	10	±20%	0.90
21	CL10X106KQ8NNN □		10 $\mu$ F	6.3	±10%	0.90
22	CL10X106KR8NNN □		10 $\mu$ F	4	±10%	0.90
1	CL21X105KAFNNN □	2.00×1.25	1 $\mu$ F	25	±10%	1.35
2	CL21X105KOFNNN □		1 $\mu$ F	16	±10%	1.35
3	CL21X105KPFNNN □		1 $\mu$ F	10	±10%	1.35
4	CL21X105KQFNNN □		1 $\mu$ F	6.3	±10%	1.35
5	CL21X105KRFNNN □		1 $\mu$ F	4	±10%	1.35
6	CL21X225KAFNNN □		2.2 $\mu$ F	25	±10%	1.35
7	CL21X225KOFNNN □		2.2 $\mu$ F	16	±10%	1.35
8	CL21X225KPFNNN □		2.2 $\mu$ F	10	±10%	1.35
9	CL21X225KQFNNN □		2.2 $\mu$ F	6.3	±10%	1.35
10	CL21X225KRFNNN □		2.2 $\mu$ F	4	±10%	1.35
11	CL21X475KAQNNN □		4.7 $\mu$ F	25	±10%	1.40
12	CL21X475KOFNNN □		4.7 $\mu$ F	16	±10%	1.35
13	CL21X475KPFNNN □		4.7 $\mu$ F	10	±10%	1.35
14	CL21X475KQFNNN □		4.7 $\mu$ F	6.3	±10%	1.35

※ □ mark means packaging code. If you want to learn the code or quantity in detail, please see p74.

Part Numbering  
System

Standard &  
High Capacitors

Super Small Size  
Capacitors

High-Q  
Capacitors

Medium-High  
Voltage Capacitors

Array Type  
Capacitors

Low ESL  
Capacitors

Reliability Test  
Condition

Premium Capacitors  
for Automotive  
Applications

Packaging  
Specification

Application Manual  
for Surface Mounting



**Product Lineup (Standard & High Capacitors-X6S)**

	Part Number	Size L x W (mm)	Capacitance	Rated Voltage (Vdc)	Capacitance Tolerance	Thickness Max.(mm)
15	CL21X475KRFNNN □	2.00×1.25	4.7 μF	4	±10%	1.35
16	CL21X106KACLRN □		10 μF	25	±10%	0.95
17	CL21X106KAYNNN □		10 μF	25	±10%	1.45
18	CL21X106KOYNNN □		10 μF	16	±10%	1.45
19	CL21X106KPCLNN □		10 μF	10	±10%	0.95
20	CL21X106KPYNNN □		10 μF	10	±10%	1.45
21	CL21X106KQQNNN □		10 μF	6.3	±10%	1.40
22	CL21X106KRQNNN □		10 μF	4	±10%	1.40
23	CL21X106KRCLNN □		10 μF	4	±10%	0.95
24	CL21X226MQQNNN □		22 μF	6.3	±20%	1.40
25	CL21X226MRQNNN □		22 μF	4	±20%	1.40
26	CL21X476MRYNNN □		47 μF	4	±20%	1.45
1	CL31X475KAHNNN □		3.20×1.60	4.7 μF	25	±10%
2	CL31X475KACLNN □	4.7 μF		25	±10%	0.95
3	CL31X475KOHNNN □	4.7 μF		16	±10%	1.80
4	CL31X475KPHNNN □	4.7 μF		10	±10%	1.80
5	CL31X475MQHNNN □	4.7 μF		6.3	±20%	1.80
6	CL31X475KRHNNN □	4.7 μF		4	±10%	1.80
7	CL31X106KACLNN □	10 μF		25	±10%	0.95
8	CL31X106KAHNNN □	10 μF		25	±10%	1.80
9	CL31X106KOHNNN □	10 μF		16	±10%	1.80
10	CL31X106KPHNNN □	10 μF		10	±10%	1.80
11	CL31X106KQHNNN □	10 μF		6.3	±10%	1.80
12	CL31X106KRHNNN □	10 μF		4	±10%	1.80
13	CL31X226KOHNNN □	22 μF		16	±10%	1.80
14	CL31X226KPHNNN □	22 μF		10	±10%	1.80
15	CL31X226KQHNNN □	22 μF		6.3	±10%	1.80
16	CL31X226KRHNNN □	22 μF		4	±10%	1.80
17	CL31X107MQHNNN □	100 μF		6.3	±20%	1.80
18	CL31X107MRHNNN □	100 μF		4	±20%	1.80
1	CL32X106KAUNNN □	3.20×2.50	10 μF	25	±10%	2.00
2	CL32X106KOJNNN □		10 μF	16	±10%	2.70
3	CL32X106KPJNNN □		10 μF	10	±10%	2.70
4	CL32X106KQJNNN □		10 μF	6.3	±10%	2.70
5	CL32X106KRJNNN □		10 μF	4	±10%	2.70
6	CL32X226KAJNNN □		22 μF	25	±10%	2.70
7	CL32X226KOJNNN □		22 μF	16	±10%	2.70
8	CL32X226KPJNNN □		22 μF	10	±10%	2.70
9	CL32X226KQJNNN □		22 μF	6.3	±10%	2.70
10	CL32X226KRJNNN □		22 μF	4	±10%	2.70
11	CL32X476MPJNNN □		47 μF	10	±20%	2.70
12	CL32X476KQJNNN □		47 μF	6.3	±10%	2.70
13	CL32X476KRJNNN □		47 μF	4	±10%	2.70
14	CL32X107MQVNNN □		100 μF	6.3	±20%	2.80
15	CL32X107MRVNNN □		100 μF	4	±20%	2.80

※ □ mark means packaging code. If you want to learn the code or quantity in detail, please see p74.

**Product Lineup (Standard & High Capacitors-X7R, X7S)**

	Part Number	Size L x W (mm)	Capacitance	Rated Voltage (Vdc)	Capacitance Tolerance	Thickness Max.(mm)
1	CL05B151KB5NNN □	1.00×0.50	150pF	50	±10%	0.55
2	CL05B181KB5NNN □		180pF	50	±10%	0.55
3	CL05B221KB5NNN □		220pF	50	±10%	0.55
4	CL05B271KB5NNN □		270pF	50	±10%	0.55
5	CL05B331KB5NNN □		330pF	50	±10%	0.55
6	CL05B391KB5NNN □		390nF	50	±10%	0.55
7	CL05B471KB5NNN □		470pF	50	±10%	0.55
8	CL05B561KB5NNN □		560pF	50	±10%	0.55
9	CL05B681KB5NNN □		680pF	50	±10%	0.55
10	CL05B102KB5NNN □		1nF	50	±10%	0.55
11	CL05B122KB5NNN □		1.2nF	50	±10%	0.55
12	CL05B152KB5NNN □		1.5nF	50	±10%	0.55
13	CL05B182KB5NNN □		1.8nF	50	±10%	0.55
14	CL05B222KB5NNN □		2.2nF	50	±10%	0.55
15	CL05B272KB5NNN □		2.7nF	50	±10%	0.55
16	CL05B332KB5NNN □		3.3nF	50	±10%	0.55
17	CL05B472KB5NNN □		4.7nF	50	±10%	0.55
18	CL05B562KB5NNN □		5.6nF	50	±10%	0.55
19	CL05B682KB5NNN □		6.8nF	50	±10%	0.55
20	CL05B822KB5NNN □		8.2nF	50	±10%	0.55
21	CL05B103KB5NNN □		10nF	50	±10%	0.55
22	CL05B123KA5NNN □		12nF	25	±10%	0.55
23	CL05B153KA5NNN □		15nF	25	±10%	0.55
24	CL05B223KA5NNN □		22nF	25	±10%	0.55
25	CL05B273KO5NNN □		27nF	16	±10%	0.55
26	CL05B333KO5NNN □		33nF	16	±10%	0.55
27	CL05B393KO5NNN □		39nF	16	±10%	0.55
28	CL05B473KO5NNN □		47nF	16	±10%	0.55
29	CL05B563KO5NNN □		56nF	16	±10%	0.55
30	CL05B683KO5NNN □		68nF	16	±10%	0.55
31	CL05B823KO5NNN □		82nF	16	±10%	0.55
32	CL05B104KO5NNN □		100nF	16	±10%	0.55
33	CL05B224KO5NNN □		220nF	16	±10%	0.55
34	CL05B474KP5NNN □		470nF	10	±10%	0.55
35	CL05B105KQ5NQN □		1μF	6.3	±10%	0.60
1	CL05Y474KP5NNN □	1.00×0.50	470nF	10	±10%	0.55
37	CL10B101KB8NNN □	1.60×0.80	100pF	50	±10%	0.90
38	CL10B121KB8NNN □		120pF	50	±10%	0.90
39	CL10B151KB8NNN □		150pF	50	±10%	0.90
40	CL10B181KB8NNN □		180pF	50	±10%	0.90
41	CL10B201KB8NNN □		200pF	50	±10%	0.90
42	CL10B221KB8NNN □		220pF	50	±10%	0.90
43	CL10B271KB8NNN □		270pF	50	±10%	0.90
44	CL10B331KB8NNN □		330pF	50	±10%	0.90
45	CL10B391KB8NNN □		390pF	50	±10%	0.90
46	CL10B471KB8NNN □		470pF	50	±10%	0.90
47	CL10B561KB8NNN □		560pF	50	±10%	0.90
48	CL10B681KB8NNN □		680pF	50	±10%	0.90
49	CL10B751KB8NNN □		750pF	50	±10%	0.90
50	CL10B821KB8NNN □		820pF	50	±10%	0.90
51	CL10B102KB8NNN □		1nF	50	±10%	0.90
52	CL10B122KB8NNN □		1.2nF	50	±10%	0.90

※ □ mark means packaging code. If you want to learn the code or quantity in detail, please see p74.

Part Numbering System

Standard & High Capacitors

Super Small Size Capacitors

High-Q Capacitors

Medium-High Voltage Capacitors

Array Type Capacitors

Low ESL Capacitors

Reliability Test Condition

Premium Capacitors for Automotive Applications

Packaging Specification

Application Manual for Surface Mounting



**Product Lineup (Standard & High Capacitors-X7R)**

	Part Number	Size L x W (mm)	Capacitance	Rated Voltage (Vdc)	Capacitance Tolerance	Thickness Max.(mm)	
53	CL10B152KB8NNN □	1.60×0.80	1.5nF	50	± 10%	0.90	
54	CL10B182KB8NNN □		1.8nF	50	± 10%	0.90	
55	CL10B202KB8NNN □		2nF	50	± 10%	0.90	
56	CL10B222KB8NNN □		2.2nF	50	± 10%	0.90	
57	CL10B332KB8NNN □		3.3nF	50	± 10%	0.90	
58	CL10B392KB8NNN □		3.9nF	50	± 10%	0.90	
59	CL10B472KB8NNN □		4.7nF	50	± 10%	0.90	
60	CL10B562KB8NNN □		5.6nF	50	± 10%	0.90	
61	CL10B682KB8NNN □		6.8nF	50	± 10%	0.90	
62	CL10B822KB8NNN □		8.2nF	50	± 10%	0.90	
63	CL10B103JB8NNN □		10nF	50	± 5%	0.90	
64	CL10B123KB8NNN □		12nF	50	± 10%	0.90	
65	CL10B153KB8NNN □		15nF	50	± 10%	0.90	
66	CL10B183KB8NNN □		18nF	50	± 10%	0.90	
67	CL10B223KB8NNN □		22nF	50	± 10%	0.90	
68	CL10B273KB8NNN □		27nF	50	± 10%	0.90	
69	CL10B333JB8NNN □		33nF	50	± 5%	0.90	
70	CL10B393KB8NNN □		39nF	50	± 10%	0.90	
71	CL10B473KB8NNN □		47nF	50	± 10%	0.90	
72	CL10B563KB8NNN □		56nF	50	± 10%	0.90	
73	CL10B683KB8NNN □		68nF	50	± 10%	0.90	
74	CL10B823KB8NNN □		82nF	50	± 10%	0.90	
75	CL10B104KB8NNN □		100nF	50	± 10%	0.90	
76	CL10B124KO8NNN □		120nF	16	± 10%	0.90	
77	CL10B154KA8NNN □		150nF	25	± 10%	0.90	
78	CL10B224KA8NNN □		220nF	25	± 10%	0.90	
79	CL10B474KA8NNN □		470nF	25	± 10%	0.90	
80	CL10B684KO8NNN □		680nF	16	± 10%	0.90	
81	CL10B105KA8NNN □		1μF	25	± 10%	0.90	
82	CL10B225KP8NNN □		2.2μF	10	± 10%	0.90	
1	CL21B151KBANNN □		2.00×1.25	150pF	50	± 10%	0.75
2	CL21B181KBANNN □			180pF	50	± 10%	0.75
3	CL21B221KBANNN □	220pF		50	± 10%	0.75	
4	CL21B331KBANNN □	330pF		50	± 10%	0.75	
5	CL21B391KBANNN □	390pF		50	± 10%	0.75	
6	CL21B471KBANNN □	470pF		50	± 10%	0.75	
7	CL21B511KBANNN □	510pF		50	± 10%	0.75	
8	CL21B561KBANNN □	560pF		50	± 10%	0.75	
9	CL21B681KBANNN □	680pF		50	± 10%	0.75	
10	CL21B821KBANNN □	820pF		50	± 10%	0.75	
11	CL21B102KBANNN □	1nF		50	± 10%	0.75	
12	CL21B122KBANNN □	1.2nF		50	± 10%	0.75	
13	CL21B152KBANNN □	1.5nF		50	± 10%	0.75	
14	CL21B182KBANNN □	1.8nF		50	± 10%	0.75	
15	CL21B202KBANNN □	2nF		50	± 10%	0.75	
16	CL21B222KBANNN □	2.2nF		50	± 10%	0.75	
17	CL21B272KBANNN □	2.7nF		50	± 10%	0.75	
18	CL21B332KBANNN □	3.3nF		50	± 10%	0.75	
19	CL21B472KBANNN □	4.7nF		50	± 10%	0.75	
20	CL21B562KBANNN □	5.6nF		50	± 10%	0.75	
21	CL21B682KBANNN □	6.8nF		50	± 10%	0.75	

※ □ mark means packaging code. If you want to learn the code or quantity in detail, please see p74.



**Product Lineup (Standard & High Capacitors-X7R)**

	Part Number	Size L x W (mm)	Capacitance	Rated Voltage (Vdc)	Capacitance Tolerance	Thickness Max.(mm)
22	CL21B103KBANNN □	2.00×1.25	10nF	50	±10%	0.75
23	CL21B123KBANNN □		12nF	50	±10%	0.75
24	CL21B153KBANNN □		15nF	50	±10%	0.75
25	CL21B333KBANNN □		33nF	50	±10%	0.75
26	CL21B393KBANNN □		39nF	50	±10%	0.75
27	CL21B473KBANNN □		47nF	50	±10%	0.75
28	CL21B563KBCNNN □		56nF	50	±10%	0.95
29	CL21B683KAANNN □		68nF	25	±10%	0.75
30	CL21B683JBCNNN □		68nF	50	±5%	0.95
31	CL21B683KBFNNN □		68nF	50	±10%	1.35
32	CL21B823KBCNNN □		82nF	50	±10%	0.95
33	CL21B823KBFNNN □		82nF	50	±10%	1.35
34	CL21B104KACNNN □		100nF	25	±10%	0.95
35	CL21B104KBCNNN □		100nF	50	±10%	0.95
36	CL21B104KBFNNN □		100nF	50	±10%	1.35
37	CL21B124KBFNNN □		120nF	50	±10%	1.35
38	CL21B124KACNNN □		120nF	25	±10%	0.95
39	CL21B154KOANNN □		150nF	16	±10%	0.75
40	CL21B154KBFNNN □		150nF	50	±10%	1.35
41	CL21B224KBFNNN □		220nF	50	±10%	1.35
42	CL21B334KAFNNN □		330nF	25	±10%	1.35
43	CL21B474KAFNNN □		470nF	25	±10%	1.35
44	CL21B684KOFNNN □		680nF	16	±10%	1.35
45	CL21B105KBFNNN □		1μF	50	±10%	1.35
46	CL21B155KAFNNN □		1.5μF	25	±10%	1.35
47	CL21B225KAFNNN □		2.2μF	25	±10%	1.35
48	CL21B475KQNNN □		4.7μF	6.3	±10%	1.40
49	CL21B475KAFNNN □		4.7μF	25	±10%	1.35
50	CL21B106KQNNN □		10μF	16	±10%	1.40
1	CL31B221KBCNNN □		3.20×1.60	220pF	50	±10%
2	CL31B331KBCNNN □	330pF		50	±10%	1.00
3	CL31B471KBCNNN □	470pF		50	±10%	1.00
4	CL31B561KBCNNN □	560pF		50	±10%	1.00
5	CL31B152KBCNNN □	1.5nF		50	±10%	1.00
6	CL31B222KBCNNN □	2.2nF		50	±10%	1.00
7	CL31B332KBCNNN □	3.3nF		50	±10%	1.00
8	CL31B472KBCNNN □	4.7nF		50	±10%	1.00
9	CL31B473KBCNNN □	47nF		50	±10%	1.00
10	CL31B562KBCNNN □	5.6nF		50	±10%	1.00
11	CL31B682KBCNNN □	6.8nF		50	±10%	1.00
12	CL31B822KBCNNN □	8.2nF		50	±10%	1.00
13	CL31B103KBCNNN □	10nF		50	±10%	1.00
14	CL31B123KBCNNN □	12nF		50	±10%	1.00
15	CL31B153KBCNNN □	15nF		50	±10%	1.00
16	CL31B223KBCNNN □	22nF		50	±10%	1.00
17	CL31B333KBCNNN □	33nF		50	±10%	1.00
18	CL31B683KBCNNN □	68nF		50	±10%	1.00
19	CL31B104KBCNNN □	100nF		50	±10%	1.00
20	CL31B154KBCNNN □	150nF		50	±10%	1.00
21	CL31B224KBFNNN □	220nF		50	±10%	1.40
22	CL31B334KBFNNN □	330nF		50	±10%	1.40

※ □ mark means packaging code. If you want to learn the code or quantity in detail, please see p74.

- Part Numbering System
- Standard & High Capacitors
- Super Small Size Capacitors
- High-Q Capacitors
- Medium-High Voltage Capacitors
- Array Type Capacitors
- Low ESL Capacitors
- Reliability Test Condition
- Premium Capacitors for Automotive Applications
- Packaging Specification
- Application Manual for Surface Mounting



**Product Lineup (Standard & High Capacitors-X7R)**

	Part Number	Size L x W (mm)	Capacitance	Rated Voltage (Vdc)	Capacitance Tolerance	Thickness Max.(mm)	
23	CL31B334KACNNN □	3.20×1.60	330nF	25	± 10%	1.00	
24	CL31B474KBHNNN □		470nF	50	± 10%	1.80	
25	CL31B474MAFNNN □		470nF	25	± 20%	1.40	
26	CL31B684KOCNNN □		680nF	16	± 10%	1.00	
27	CL31B684KBHNNN □		680nF	50	± 10%	1.80	
28	CL31B105KBHNNN □		1 $\mu$ F	50	± 10%	1.80	
29	CL31B225KAHNNN □		2.2 $\mu$ F	25	± 10%	1.80	
30	CL31B335KAHNNN □		3.3 $\mu$ F	25	± 10%	1.80	
31	CL31B475KBHNNN □		4.7 $\mu$ F	50	± 10%	1.80	
32	CL31B106KBHNNN □		10 $\mu$ F	50	± 10%	1.80	
33	CL31B226KPHNNN □		22 $\mu$ F	10	± 10%	1.80	
1	CL32B104KBFNNN □		3.20×2.50	100nF	50	± 10%	1.45
2	CL32B154KBFNNN □			150nF	50	± 10%	1.45
3	CL32B224KBFNNN □	220nF		50	± 10%	1.45	
4	CL32B334KBFNNN □	330nF		50	± 10%	1.45	
5	CL32B474KBFNNN □	470nF		50	± 10%	1.45	
6	CL32B105KBHNNN □	1 $\mu$ F		50	± 10%	1.80	
7	CL32B225KBJNNN □	2.2 $\mu$ F		50	± 10%	2.70	
8	CL32B225KAINNN □	2.2 $\mu$ F		25	± 10%	2.20	
9	CL32B475KBJNNN □	4.7 $\mu$ F		50	± 10%	2.70	
10	CL32B475KBUYNN □	4.7 $\mu$ F		50	± 10%	2.00	
11	CL32B475KOINNN □	4.7 $\mu$ F		16	± 10%	2.20	
12	CL32B106KLJNNN □	10 $\mu$ F		35	± 10%	2.70	
13	CL32B106KAULNN □	10 $\mu$ F		25	± 10%	2.00	
14	CL32B106KPINNN □	10 $\mu$ F		10	± 10%	2.20	
15	CL32B226KAJNNN □	22 $\mu$ F		25	± 10%	2.70	
16	CL32B476MQJNN □	47 $\mu$ F		6.3	± 20%	2.70	

※ □ mark means packaging code. If you want to learn the code or quantity in detail, please see p74.

**Product Lineup (Standard & High Capacitors-Y5V)**

	Part Number	Size L x W (mm)	Capacitance	Rated Voltage (Vdc)	Capacitance Tolerance	Thickness Max.(mm)
1	CL05F224ZO5NNN □	1.00×0.50	0.22 $\mu$ F	16	+80/-20%	0.55
2	CL05F224ZP5NNN □		0.22 $\mu$ F	10	+80/-20%	0.55
3	CL05F224ZQ5NNN □		0.22 $\mu$ F	6.3	+80/-20%	0.55
4	CL05F474ZP5NNN □		0.47 $\mu$ F	10	+80/-20%	0.55
5	CL05F474ZQ5NNN □		0.47 $\mu$ F	6.3	+80/-20%	0.55
6	CL05F105ZQ5NNN □		1 $\mu$ F	6.3	+80/-20%	0.55
1	CL10F474ZB8NNN □	1.60×0.80	0.47 $\mu$ F	50	+80/-20%	0.90
2	CL10F474ZA8NNN □		0.47 $\mu$ F	25	+80/-20%	0.90
3	CL10F474ZO8NNN □		0.47 $\mu$ F	16	+80/-20%	0.90
4	CL10F474ZP8NNN □		0.47 $\mu$ F	10	+80/-20%	0.90
5	CL10F105ZO8NNN □		1 $\mu$ F	16	+80/-20%	0.90
6	CL10F105ZP8NNN □		1 $\mu$ F	10	+80/-20%	0.90
7	CL10F225ZP8NNN □		2.2 $\mu$ F	10	+80/-20%	0.90
8	CL10F225ZQ8NNN □		2.2 $\mu$ F	6.3	+80/-20%	0.90
9	CL10F475ZQ8NNN □		4.7 $\mu$ F	6.3	+80/-20%	0.90
1	CL21F105ZBFNNN □	2.00×1.25	1 $\mu$ F	50	+80/-20%	1.35
2	CL21F105ZAFNNN □		1 $\mu$ F	25	+80/-20%	1.35
3	CL21F105ZOFNNN □		1 $\mu$ F	16	+80/-20%	1.35
4	CL21F225ZAFNNN □		2.2 $\mu$ F	25	+80/-20%	1.35
5	CL21F225ZOFNNN □		2.2 $\mu$ F	16	+80/-20%	1.35
6	CL21F475ZQFNNN □		4.7 $\mu$ F	6.3	+80/-20%	1.35
7	CL21F475ZOFNNN □		4.7 $\mu$ F	16	+80/-20%	1.35
8	CL21F475ZPFNNN □		4.7 $\mu$ F	10	+80/-20%	1.35
9	CL21F106ZPFNNN □		10 $\mu$ F	10	+80/-20%	1.35
10	CL21F106ZPCLNN □		10 $\mu$ F	10	+80/-20%	0.95
11	CL21F106ZQFNNN □		10 $\mu$ F	6.3	+80/-20%	1.35
12	CL21F106ZQCLNN □		10 $\mu$ F	6.3	+80/-20%	0.95
1	CL31F475ZOFNNN □	3.20×1.60	4.7 $\mu$ F	16	+80/-20%	1.40
2	CL31F475ZPFNNN □		4.7 $\mu$ F	10	+80/-20%	1.40
3	CL31F475ZQFNNN □		4.7 $\mu$ F	6.3	+80/-20%	1.40
4	CL31F106ZOHNNN □		10 $\mu$ F	16	+80/-20%	1.80
5	CL31F106ZPHNNN □		10 $\mu$ F	10	+80/-20%	1.80
6	CL31F106ZQHNNN □		10 $\mu$ F	6.3	+80/-20%	1.80
7	CL31F226ZPHNNN □		22 $\mu$ F	10	+80/-20%	1.80
8	CL31F226ZQHNNN □		22 $\mu$ F	6.3	+80/-20%	1.80
1	CL32F106ZAHNNN □	3.20×2.50	10 $\mu$ F	25	+80/-20%	1.80
2	CL32F106ZOELNN □		10 $\mu$ F	16	+80/-20%	1.20
3	CL32F226ZPJNNN □		22 $\mu$ F	10	+80/-20%	2.70
4	CL32F226ZPJLNN □		22 $\mu$ F	10	+80/-20%	2.70
5	CL32F476ZQINNN □		47 $\mu$ F	6.3	+80/-20%	2.20
6	CL32F107ZQJNNN □		100 $\mu$ F	6.3	+80/-20%	2.70

※ □ mark means packaging code. If you want to learn the code or quantity in detail, please see p74.

- Part Numbering System
- Standard & High Capacitors
- Super Small Size Capacitors
- High-Q Capacitors
- Medium-High Voltage Capacitors
- Array Type Capacitors
- Low ESL Capacitors
- Reliability Test Condition
- Premium Capacitors for Automotive Applications
- Packaging Specification
- Application Manual for Surface Mounting

# Super Small Size Capacitors



## Feature

- Small chip size
- 02 and 03 series (High-Q) MLCC shows very low ESR value.
- 02 and 03 Series are suited to only reflow soldering
- 02 and 03 Series are suited to miniature RF module, portable equipment and high frequency circuit

## Application

- VCO, Tuner, RF Module
- MCM Module
- Mobile phone, Wireless LAN, Note PC

## Structure and Dimensions



Code	EIA Code	Dimension (mm)			
		L	W	T	BW
02	01005	$0.4 \pm 0.02$	$0.2 \pm 0.02$	$0.2 \pm 0.02$	$0.10 \pm 0.03$
03	0201	$0.6 \pm 0.03$	$0.3 \pm 0.03$	$0.3 \pm 0.03$	$0.15 \pm 0.05$

**Super Small Size Capacitance Table (C0G)**

TC	Size (mm)	Vr(V)	Capacitance (pF)							
			0.5	1	10	22	47	100	220	330
C0G	01005(0402)	6.3								
		16								
	0201(0603)	25								
		50								

**Super Small Size Capacitance Table (High-Q)**

TC	Size (mm)	Vr(V)	Capacitance (pF)							
			0.2	1	10	15	27	33	47	100
C0G	01005(0402)	25								
	0201(0603)	25								
		50								

**Super Small Size Capacitance Table (X7R,X6S)**

TC	Size (mm)	Vr(V)	Capacitance (nF)							
			0.1	0.22	0.47	1	2.2	3.3	4.7	10
X7R	01005(0402)	10								
	0201(0603)	10								
		16								
		25								
		50								
X6S	0201(0603)	4								

**Super Small Size Capacitance Table (X5R, Y5V)**

TC	Size (mm)	Vr(V)	Capacitance (μF)							
			0.01	0.1	0.22	0.47	1	2.2	4.7	10
X5R	01005(0402)	6.3								
		10								
		16								
	0201(0603)	4								
		6.3								
		10								
		16								
	25									
Y5V	0201(0603)	6.3								

Part Numbering System

Standard & High Capacitors

Super Small Size Capacitors

High-Q Capacitors

Medium-High Voltage Capacitors

Array Type Capacitors

Low ESL Capacitors

Reliability Test Condition

Premium Capacitors for Automotive Applications

Packaging Specification

Application Manual for Surface Mounting



**Product Lineup (Super Small Size Capacitors-C0G)**

	Part Number	Size L x W (mm)	Capacitance	Rated Voltage (Vdc)	Capacitance Tolerance	Thickness Max.(mm)	
1	CL02C0R5CO2ANN □	0.40×0.20	0.5 pF	16	±0.25 pF	0.22	
2	CL02C010CO2ANN □		1.0 pF	16	±0.25 pF	0.22	
3	CL02C1R2CO2ANN □		1.2 pF	16	±0.25 pF	0.22	
4	CL02C1R5CO2ANN □		1.5 pF	16	±0.25 pF	0.22	
5	CL02C1R8CO2ANN □		1.8 pF	16	±0.25 pF	0.22	
6	CL02C020CO2ANN □		2.0 pF	16	±0.25 pF	0.22	
7	CL02C2R2CO2ANN □		2.2 pF	16	±0.25 pF	0.22	
8	CL02C2R7CO2ANN □		2.7 pF	16	±0.25 pF	0.22	
9	CL02C030CO2ANN □		3.0 pF	16	±0.25 pF	0.22	
10	CL02C3R3CO2ANN □		3.3 pF	16	±0.25 pF	0.22	
11	CL02C3R9CO2ANN □		3.9 pF	16	±0.25 pF	0.22	
12	CL02C4R7CO2ANN □		4.7 pF	16	±0.25 pF	0.22	
13	CL02C5R6DO2ANN □		5.6 pF	16	±0.5 pF	0.22	
14	CL02C6R8DO2ANN □		6.8 pF	16	±0.5 pF	0.22	
15	CL02C8R2DO2ANN □		8.2 pF	16	±0.5 pF	0.22	
16	CL02C090DO2ANN □		9.0 pF	16	±0.5 pF	0.22	
17	CL02C100JO2ANN □		10 pF	16	±5%	0.22	
18	CL02C150JO2ANN □		15 pF	16	±5%	0.22	
19	CL02C180JO2ANN □		18 pF	16	±5%	0.22	
20	CL02C220JO2ANN □		22 pF	16	±5%	0.22	
21	CL02C270JO2ANN □		27 pF	16	±5%	0.22	
22	CL02C330JO2ANN □		33 pF	16	±5%	0.22	
23	CL02C390JO2ANN □		39 pF	16	±5%	0.22	
24	CL02C470JO2ANN □		47 pF	16	±5%	0.22	
25	CL02C560JQ2ANN □		56 pF	6.3	±5%	0.22	
26	CL02C680JQ2ANN □		68 pF	6.3	±5%	0.22	
27	CL02C820JQ2ANN □		82 pF	6.3	±5%	0.22	
28	CL02C101JO2ANN □		100 pF	16	±5%	0.22	
29	CL02C101JQ2ANN □		100 pF	6.3	±5%	0.22	
1	CL02C0R5BO2GNN □	0.40×0.20	0.5 pF	16	±0.25 pF	0.22	High-Q
2	CL02C010BO2GNN □		1.0 pF	16	±0.25 pF	0.22	High-Q
3	CL02C1R2BO2GNN □		1.2 pF	16	±0.25 pF	0.22	High-Q
4	CL02C1R5BO2GNN □		1.5 pF	16	±0.25 pF	0.22	High-Q
5	CL02C1R8BO2GNN □		1.8 pF	16	±0.25 pF	0.22	High-Q
6	CL02C2R2BO2GNN □		2.2 pF	16	±0.25 pF	0.22	High-Q
7	CL02C2R7BO2GNN □		2.7 pF	16	±0.25 pF	0.22	High-Q
8	CL02C3R3BO2GNN □		3.3 pF	16	±0.25 pF	0.22	High-Q
9	CL02C3R9BO2GNN □		3.9 pF	16	±0.25 pF	0.22	High-Q
10	CL02C4R7BO2GNN □		4.7 pF	16	±0.25 pF	0.22	High-Q
11	CL02C5R6BO2GNN □		5.6 pF	16	±0.25 pF	0.22	High-Q
12	CL02C6R8BO2GNN □		6.8 pF	16	±0.25 pF	0.22	High-Q
13	CL02C8R2BO2GNN □		8.2 pF	16	±0.25 pF	0.22	High-Q
14	CL02C100JO2GNN □		10 pF	16	±5%	0.22	High-Q
15	CL02C120JO2GNN □		12 pF	16	±5%	0.22	High-Q
16	CL02C150JO2GNN □		15 pF	16	±5%	0.22	High-Q
17	CL02C180JO2GNN □		18 pF	16	±5%	0.22	High-Q
18	CL02C220JO2GNN □		22 pF	16	±5%	0.22	High-Q
19	CL02C270JO2GNN □		27 pF	16	±5%	0.22	High-Q
1	CL03C0R5CA3GNN □	0.60×0.30	0.5 pF	25	±0.25 pF	0.33	High-Q
2	CL03C010CA3GNN □		1.0 pF	25	±0.25 pF	0.33	High-Q
3	CL03C1R2CA3GNN □		1.2 pF	25	±0.25 pF	0.33	High-Q
4	CL03C1R5CA3GNN □		1.5 pF	25	±0.25 pF	0.33	High-Q

※ □ mark means packaging code. If you want to learn the code or quantity in detail, please see p74.



**Product Lineup (Super Small Size Capacitors-C0G)**

	Part Number	Size L x W (mm)	Capacitance	Rated Voltage (Vdc)	Capacitance Tolerance	Thickness Max.(mm)	
5	CL03C1R8CA3GNN □	0.60×0.30	1.8 pF	25	±0.25 pF	0.33	High-Q
6	CL03C020CA3GNN □		2.0 pF	25	±0.25 pF	0.33	High-Q
7	CL03C2R2CA3GNN □		2.2 pF	25	±0.25 pF	0.33	High-Q
8	CL03C2R7CA3GNN □		2.7 pF	25	±0.25 pF	0.33	High-Q
9	CL03C030CA3GNN □		3.0 pF	25	±0.25 pF	0.33	High-Q
10	CL03C3R3CA3GNN □		3.3 pF	25	±0.25 pF	0.33	High-Q
11	CL03C3R9CA3GNN □		3.9 pF	25	±0.25 pF	0.33	High-Q
12	CL03C4R7CA3GNN □		4.7 pF	25	±0.25 pF	0.33	High-Q
13	CL03C5R6DA3GNN □		5.6 pF	25	±0.5 pF	0.33	High-Q
14	CL03C6R8DA3GNN □		6.8 pF	25	±0.5 pF	0.33	High-Q
15	CL03C8R2DA3GNN □		8.2 pF	25	±0.5 pF	0.33	High-Q
16	CL03C090DA3GNN □		9.0 pF	25	±0.5 pF	0.33	High-Q
17	CL03C100JA3GNN □		10 pF	25	±5%	0.33	High-Q
18	CL03C150JA3ANN □		15 pF	25	±5%	0.33	
19	CL03C180JA3ANN □		18 pF	25	±5%	0.33	
20	CL03C220JA3ANN □		22 pF	25	±5%	0.33	
21	CL03C270JA3ANN □		27 pF	25	±5%	0.33	
22	CL03C330JA3ANN □		33 pF	25	±5%	0.33	
23	CL03C390JA3ANN □		39 pF	25	±5%	0.33	
24	CL03C470JA3ANN □		47 pF	25	±5%	0.33	
25	CL03C101JB3ANN □		100 pF	50	±5%	0.33	
26	CL03C101JA3ANN □		100 pF	25	±5%	0.33	

Part Numbering System

Standard & High Capacitors

Super Small Size Capacitors

High-Q Capacitors

Medium-High Voltage Capacitors

Array Type Capacitors

Low ESL Capacitors

Reliability Test Condition

Premium Capacitors for Automotive Applications

Packaging Specification

Application Manual for Surface Mounting

**Product Lineup (Super Small Size Capacitors-X7R,X6S)**

	Part Number	Size L x W (mm)	Capacitance	Rated Voltage (Vdc)	Capacitance Tolerance	Thickness Max.(mm)	
1	CL02B101KP2NNN □	0.40×0.20	100 pF	10	±10%	0.22	
2	CL02B221KP2NNN □		220 pF	10	±10%	0.22	
3	CL02B271KP2NNN □		270 pF	10	±10%	0.22	
4	CL02B331KP2NNN □		330 pF	10	±10%	0.22	
5	CL02B391KP2NNN □		390 pF	10	±10%	0.22	
6	CL02B471KP2NNN □		470 pF	10	±10%	0.22	
7	CL02B681KP2NNN □		680 pF	10	±10%	0.22	
8	CL02B102KP2NNN □		1 nF	10	±10%	0.22	
1	CL03B151KA3NNN □	0.60×0.30	150 pF	25	±10%	0.33	
2	CL03B221KA3NNN □		220 pF	25	±10%	0.33	
3	CL03B271KO3NNN □		270 pF	16	±10%	0.33	
4	CL03B331KA3NNN □		330 pF	25	±10%	0.33	
5	CL03B471KA3NNN □		470 pF	25	±10%	0.33	
6	CL03B561KO3NNN □		560 pF	16	±10%	0.33	
7	CL03B681KA3NNN □		680 pF	25	±10%	0.33	
8	CL03B821KO3NNN □		820 pF	16	±10%	0.33	
9	CL03B102KA3NNN □		1 nF	25	±10%	0.33	
10	CL03B152KP3NNN □		1.5 nF	10	±10%	0.33	
11	CL03B332KP3NNN □		3.3 nF	10	±10%	0.33	
12	CL03B392KP3NNN □		3.9 nF	10	±10%	0.33	
13	CL03B472KP3NNN □		4.7 nF	10	±10%	0.33	
14	CL03B682KP3NNN □		6.8 nF	10	±10%	0.33	
15	CL03B103KP3NNN □		10 nF	10	±10%	0.33	
1	CL03X104KQ3NNN □			100 nF	6.3	±20%	0.33
2	CL03X105MR3CSN □			1 μF	4	±20%	0.35
3	CL03X105MR3NRN □			1 μF	4	±20%	0.39

※ □ mark means packaging code. If you want to learn the code or quantity in detail, please see p74.



**Product Lineup (Super Small Size Capacitors-X5R)**

	Part Number	Size L x W (mm)	Capacitance	Rated Voltage (Vdc)	Capacitance Tolerance	Thickness Max.(mm)
1	CL02A151KQ2NNN □	0.40×0.20	150 pF	6.3	±10%	0.22
2	CL02A221KQ2NNN □		220 pF	6.3	±10%	0.22
3	CL02A331KQ2NNN □		330 pF	6.3	±10%	0.22
4	CL02A471KQ2NNN □		470 pF	6.3	±10%	0.22
5	CL02A681KQ2NNN □		680 pF	6.3	±10%	0.22
6	CL02A102KQ2NNN □		1 nF	6.3	±10%	0.22
7	CL02A152KQ2NNN □		1.5 nF	6.3	±10%	0.22
8	CL02A222KQ2NNN □		2.2 nF	6.3	±10%	0.22
9	CL02A332KQ2NNN □		3.2 nF	6.3	±10%	0.22
10	CL02A472KQ2NNN □		4.7 nF	6.3	±10%	0.22
11	CL02A682KQ2NNN □		6.8 nF	6.3	±10%	0.22
12	CL02A103KQ2NNN □		10 nF	6.3	±10%	0.22
13	CL02A104KQ2NNN □		100 nF	6.3	±10%	0.22
14	CL02A224MR2NNN □		220 nF	4	±20%	0.22
15	CL02A224MQ2NNN □		220 nF	6.3	±20%	0.22
1	CL03A103KA3NNN □	0.60×0.30	10 nF	25	±10%	0.33
2	CL03A223KQ3NNN □		22 nF	6.3	±10%	0.33
3	CL03A473KQ3NNN □		47 nF	6.3	±10%	0.33
4	CL03A104MA3NNN □		100 nF	25	±20%	0.33
5	CL03A104KO3NNN □		100 nF	16	±10%	0.33
6	CL03A104KP3NNN □		100 nF	10	±10%	0.33
7	CL03A104KQ3NNN □		100 nF	6.3	±10%	0.33
8	CL03A224KQ3NNN □		220 nF	6.3	±10%	0.33
9	CL03A224KP3NNN □		220 nF	10	±10%	0.33
10	CL03A105MO3NRR □		1 nF	16	±20%	0.39
11	CL03A105MQ3CSN □		1 μF	6.3	±20%	0.35
12	CL03A105MP3NSN □		1 μF	10	±20%	0.35
13	CL03A225MR3CRN □		2.2 μF	4	±20%	0.39
14	CL03A225MQ3CRN □		2.2 μF	6.3	±20%	0.39

※ □ mark means packaging code. If you want to learn the code or quantity in detail, please see p74.



## Feature

- High Q and low ESR in high frequency range
- Tight tolerance available
- High efficiency and low power consumption in RF circuit
- Can be applied to power amplifier module for base-station and GHz range communications

## Application

- Base Station
- Set Top Box
- Wireless Equipment
- GPS, Bluetooth

## Structure and Dimensions

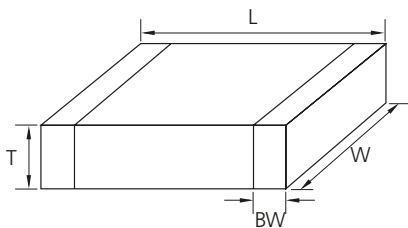

Code	EIA Code	Rated Voltage	Dimension (mm)			
			L	W	T	BW
05	0402	50V	1.00±0.05	0.50±0.05	0.50±0.05	0.25±0.10
10	0603	50/100V	1.60±0.10	0.80±0.10	0.80±0.10	0.30±0.20
		250V	1.60±0.15	0.80±0.15	0.65±0.10	0.30±0.20
21	0805	250V	2.00±0.15	1.25±0.15	0.85±0.15	0.50+0.20/-0.30

## Capacitance Table (High-Q capacitor)

TC	Size (mm)	Vr(V)	Capacitance (pF)											
			0.2	0.5	1	10	15	27	33	47	68	100	150	220
COG	0402(1005)	50	[Shaded area indicating capacitance range]											
		50	[Shaded area indicating capacitance range]											
	0603(1608)	100	[Shaded area indicating capacitance range]											
		250	[Shaded area indicating capacitance range]											
	0805(2012)	250	[Shaded area indicating capacitance range]											

Part Numbering System

Standard & High Capacitors

Super Small Size Capacitors

High-Q Capacitors

Medium-High Voltage Capacitors

Array Type Capacitors

Low ESL Capacitors

Reliability Test Condition

Premium Capacitors for Automotive Applications

Packaging Specification

Application Manual for Surface Mounting

# Medium-High Voltage Capacitors



## Feature

- Highly reliable performance
- Operating at high voltage level
- Wide voltage level: from 100V to 3000V
- High withstanding voltage
- Tape & reel surface mount assembly

## Application

- Switching Power Circuit(SMPS)
- Lighting Ballast, LCD back lighting inverter
- DC-DC converter input filter, snubber circuit
- Phone, Fax, Modem
- Network(IEEE802.3)

## Structure and Dimensions



Code	EIA Code	Dimension (mm)				
		L	W	T	Thickness Code	BW
10	0603	1.60±0.10	0.80±0.10	0.80±0.10	8	0.3±0.2
21	0805	2.00±0.10	1.25±0.10	1.25±0.10	F	0.5+0.2/-0.3
		2.00±0.10	1.25±0.10	0.85±0.10	C	
31	1206	2.00±0.10	1.25±0.10	0.65±0.10	A	0.5±0.3
		3.20±0.20	1.60±0.20	1.60±0.20	H	
		3.20±0.15	1.60±0.15	1.25±0.15	F	
32	1210	3.20±0.15	1.60±0.15	0.85±0.15	C	0.6±0.3
		3.20±0.30	2.50±0.20	2.50±0.20	J	
		3.20±0.30	2.50±0.20	1.60±0.20	H	
42	1808	3.20±0.30	2.50±0.20	1.25±0.20	F	0.8±0.3
		4.50±0.40	2.00±0.20	2.00±0.20	I	
		4.50±0.40	2.00±0.20	1.60±0.20	H	
43	1812	4.50±0.40	2.00±0.20	1.25±0.20	F	0.8±0.3
		4.50±0.40	3.20±0.30	2.50±0.20	J	
		4.50±0.40	3.20±0.30	1.60±0.20	H	
55	2220	4.50±0.40	3.20±0.30	1.25±0.20	F	1.0±0.3
		5.70±0.40	5.00±0.40	2.50±0.20	J	
		5.70±0.40	5.00±0.40	1.60±0.20	H	

Medium-High Voltage capacitance Table (C0G)

Vr(V)	Size(mm)	Capacitance																									
		(pF)						(nF)																			
		330	390	470	560	680	820	1	1.2	1.5	1.8	2.2	2.7	3.3	3.9	4.7	5.6	6.8	8.2	10	12	15	18	22	27	33	47
100V	0603(1608)	■																									
	0805(2012)	■																									
	1206(3216)	■																									
	1210(3225)															■											
	1812(4532)											■															
	2220(5750)	■																									
200V	0603(1608)	■																									
	0805(2012)	■																									
	1206(3216)	■																									
	1210(3225)															■											
	1812(4532)											■															
	2220(5750)	■																									
250V	0603(1608)	■																									
	0805(2012)	■																									
	1206(3216)	■																									
	1210(3225)															■											
	1812(4532)											■															
	2220(5750)	■																									
500V	1206(3216)	■																									
	1210(3225)															■											
	1812(4532)											■															
	2220(5750)	■																									
630V	0805(2012)	■																									
	1206(3216)	■																									
	1210(3225)															■											
	1812(4532)											■															
	2220(5750)	■																									

- Part Numbering System
- Standard & High Capacitors
- Super Small Size Capacitors
- High-Q Capacitors
- Medium-High Voltage Capacitors
- Array Type Capacitors
- Low ESL Capacitors
- Reliability Test Condition
- Premium Capacitors for Automotive Applications
- Packaging Specification
- Application Manual for Surface Mounting



**Medium-High Voltage capacitance Table (COG)**

Vr(V)	Size(mm)	Capacitance																							
		(pF)															(nF)								
		47	56	68	82	100	120	150	180	220	270	330	390	470	560	680	820	1	1.2	1.5	1.8	2.2	2.7	3.3	3.9
1KV	1206(3216)	[Bar from 47 to 470 pF]																							
	1210(3225)	[Bar from 270 to 680 pF]																							
	1812(4532)	[Bar from 390 to 1800 pF]																							
	2220(5750)	[Bar from 2200 to 3600 pF]															3.6nF								
2KV	1206(3216)	[Bar from 47 to 120 pF]																							
	1210(3225)	[Bar from 47 to 470 pF]																							
	1808(4520)	[Bar from 47 to 270 pF]																							
	1812(4532)	[Bar from 47 to 1800 pF]																							
	2220(5750)	[Bar from 390 to 680 pF]																							
3KV	1808(4520)	[Bar from 47 to 150 pF]																							
	1812(4532)	[Bar from 120 to 390 pF]																							
	2220(5750)	[Bar from 390 to 680 pF]																							

Medium-High Voltage capacitance Table (X7R)

Vr(V)	Size(mm)	Capacitance (nF)															
		4.7	10	15	22	33	47	68	100	150	220	330	470	680	1000	1500	2200
100V	0603(1608)	[Bar chart showing capacitance range for 0603(1608) at 100V]															
	0805(2012)	[Bar chart showing capacitance range for 0805(2012) at 100V]															
	1206(3216)	[Bar chart showing capacitance range for 1206(3216) at 100V]															
	1210(3225)	[Bar chart showing capacitance range for 1210(3225) at 100V]															
	1812(4532)	[Bar chart showing capacitance range for 1812(4532) at 100V]															
	2220(5750)	[Bar chart showing capacitance range for 2220(5750) at 100V]															
200V	0805(2012)	[Bar chart showing capacitance range for 0805(2012) at 200V]															
	1206(3216)	[Bar chart showing capacitance range for 1206(3216) at 200V]															
	1210(3225)	[Bar chart showing capacitance range for 1210(3225) at 200V]															
	1812(4532)	[Bar chart showing capacitance range for 1812(4532) at 200V]															
	2220(5750)	[Bar chart showing capacitance range for 2220(5750) at 200V]															
250V	0805(2012)	[Bar chart showing capacitance range for 0805(2012) at 250V]															
	1206(3216)	[Bar chart showing capacitance range for 1206(3216) at 250V]															
	1210(3225)	[Bar chart showing capacitance range for 1210(3225) at 250V]															
	1812(4532)	[Bar chart showing capacitance range for 1812(4532) at 250V]															
	2220(5750)	[Bar chart showing capacitance range for 2220(5750) at 250V]															
350V	1206(3216)	(Tmax=1.0) (Tmax (Tmax =1.25)=1.8)															
500V	1206(3216)	[Bar chart showing capacitance range for 1206(3216) at 500V]															
	1210(3225)	[Bar chart showing capacitance range for 1210(3225) at 500V]															
	1812(4532)	[Bar chart showing capacitance range for 1812(4532) at 500V]															
	2220(5750)	[Bar chart showing capacitance range for 2220(5750) at 500V]															
630V	1206(3216)	[Bar chart showing capacitance range for 1206(3216) at 630V]															
	1210(3225)	[Bar chart showing capacitance range for 1210(3225) at 630V]															
	1812(4532)	[Bar chart showing capacitance range for 1812(4532) at 630V]															
	2220(5750)	[Bar chart showing capacitance range for 2220(5750) at 630V]															

- Part Numbering System
- Standard & High Capacitors
- Super Small Size Capacitors
- High-Q Capacitors
- Medium-High Voltage Capacitors
- Array Type Capacitors
- Low ESL Capacitors
- Reliability Test Condition
- Premium Capacitors for Automotive Applications
- Packaging Specification
- Application Manual for Surface Mounting





Product Lineup (Medium-High Voltage Capacitors-C0G)

	Part Number	Size L x W (mm)	Capacitance	Rated Voltage (Vdc)	Capacitance Tolerance	Thickness Max.(mm)
1	CL10C100JC8NNN □	1.60×0.80	10 pF	100	±5%	0.90
2	CL10C150JC8NNN □		15 pF	100	±5%	0.90
3	CL10C330JC8NNN □		33 pF	100	±5%	0.90
4	CL10C390JC8NNN □		39 pF	100	±5%	0.90
5	CL10C470JC8NNN □		47 pF	100	±5%	0.90
6	CL10C560JC8NNN □		56 pF	100	±5%	0.90
7	CL10C101JC8NNN □		100 pF	100	±5%	0.90
8	CL10C121JC8NNN □		120 pF	100	±5%	0.90
9	CL10C151JC8NNN □		150 pF	100	±5%	0.90
10	CL10C331JC8NNN □		330 pF	100	±5%	0.90
11	CL10C331JD8NNN □		330 pF	200	±5%	0.90
12	CL10C331JE8NNN □		330 pF	250	±5%	0.90
13	CL10C391JD8NNN □		390 pF	200	±5%	0.90
14	CL10C391JE8NNN □		390 pF	250	±5%	0.90
15	CL10C471JC8NNN □		470 pF	100	±5%	0.90
16	CL10C471JD8NNN □		470 pF	200	±5%	0.90
17	CL10C471JE8NNN □		470 pF	250	±5%	0.90
18	CL10C561JD8NNN □		560 pF	200	±5%	0.90
19	CL10C561JE8NNN □		560 pF	250	±5%	0.90
20	CL10C681JC8NNN □		680 pF	100	±5%	0.90
21	CL10C681JD8NNN □		680 pF	200	±5%	0.90
22	CL10C681JE8NNN □		680 pF	250	±5%	0.90
23	CL10C821JC8NNN □		820 pF	100	±5%	0.90
24	CL10C102JC8NNN □		1 nF	100	±5%	0.90
25	CL10C122JC8NNN □		1.2 nF	100	±5%	0.90
1	CL21C100JCANNN □	2.00×1.25	10 pF	100	±5%	0.75
2	CL21C120JCANNN □		12 pF	100	±5%	0.75
3	CL21C150JCANNN □		15 pF	100	±5%	0.75
4	CL21C150JDCNNN □		15 pF	200	±5%	0.95
5	CL21C180JCANNN □		18 pF	100	±5%	0.75
6	CL21C180JDCNNN □		18 pF	200	±5%	0.95
7	CL21C220JCANNN □		22 pF	100	±5%	0.75
8	CL21C270JCANNN □		27 pF	100	±5%	0.75
9	CL21C270JHFNNN □		27 pF	630	±5%	1.35
10	CL21C330JCANNN □		33 pF	100	±5%	0.75
11	CL21C330JDCNNN □		33 pF	200	±5%	0.95
12	CL21C330JHFNNN □		33 pF	630	±5%	1.35
13	CL21C390JDCNNN □		39 pF	200	±5%	0.95
14	CL21C470JCANNN □		47 pF	100	±5%	0.75
15	CL21C470JDCNNN □		47 pF	200	±5%	0.95
16	CL21C470JHFNNN □		47 pF	630	±5%	1.35
17	CL21C560JCCNNN □		56 pF	100	±5%	0.95
18	CL21C560JDCNNN □		56 pF	200	±5%	0.95
19	CL21C680JCANNN □		68 pF	100	±5%	0.75
20	CL21C680JDCNNN □		68 pF	200	±5%	0.95
21	CL21C680JHFNNN □		68 pF	630	±5%	1.35
22	CL21C820JCCNNN □		82 pF	100	±5%	0.95
23	CL21C101JCANNN □		100 pF	100	±5%	0.75
24	CL21C101JDCNNN □		100 pF	200	±5%	0.95
25	CL21C101JECNNN □		100 pF	250	±5%	0.95

※ □ mark means packaging code. If you want to learn the code or quantity in detail, please see p74.

Part Numbering System

Standard & High Capacitors

Super Small Size Capacitors

High-Q Capacitors

Medium-High Voltage Capacitors

Array Type Capacitors

Low ESL Capacitors

Reliability Test Condition

Premium Capacitors for Automotive Applications

Packaging Specification

Application Manual for Surface Mounting



**Product Lineup (Medium-High Voltage Capacitors-C0G)**

	Part Number	Size L x W (mm)	Capacitance	Rated Voltage (Vdc)	Capacitance Tolerance	Thickness Max.(mm)
26	CL21C121JDCNNN □	2.00×1.25	120pF	200	±5%	0.95
27	CL21C151JCANNN □		150pF	100	±5%	0.75
28	CL21C151JHFNNN □		150pF	630	±5%	1.35
29	CL21C221JCANNN □		220pF	100	±5%	0.75
30	CL21C221JDCNNN □		220pF	200	±5%	0.95
31	CL21C331JCANNN □		330pF	100	±5%	0.75
32	CL21C471JCCNNN □		470pF	100	±5%	0.95
33	CL21C561JCCNNN □		560pF	100	±5%	0.95
34	CL21C561JHFNNN □		560pF	630	±5%	1.35
35	CL21C681JCCNNN □		680pF	100	±5%	0.95
36	CL21C102JCFNNN □		1nF	100	±5%	1.35
37	CL21C102JDFNNN □		1nF	200	±5%	1.35
38	CL21C272JDFNNN □		2.7nF	200	±5%	1.35
39	CL21C272JEFNNN □		2.7nF	250	±5%	1.35
40	CL21C472JCFNNN □		4.7nF	100	±5%	1.35
1	CL31C150JGFNNN □		3.20×1.60	15pF	500	±5%
2	CL31C180JGFNNN □	18pF		500	±5%	1.40
3	CL31C220JGFNNN □	22pF		500	±5%	1.40
4	CL31C220JHNNN □	22pF		2000	±5%	1.80
5	CL31C270JGFNNN □	27pF		500	±5%	1.40
6	CL31C330JGFNNN □	33pF		500	±5%	1.40
7	CL31C390JGFNNN □	39pF		500	±5%	1.40
8	CL31C470JGFNNN □	47pF		500	±5%	1.40
9	CL31C470JHFNNN □	47pF		630	±5%	1.40
10	CL31C470JIFNNN □	47μF		1000	±5%	1.40
11	CL31C470JHNNN □	47pF		2000	±5%	1.80
12	CL31C560JGFNNN □	56pF		500	±5%	1.40
13	CL31C680JCCNNN □	68pF		100	±5%	1.00
14	CL31C680JGFNNN □	68pF		500	±5%	1.40
15	CL31C680JHFNNN □	68pF		630	±5%	1.40
16	CL31C680JIFNNN □	68pF		1000	±5%	1.40
17	CL31C820JGFNCN □	82pF		500	±5%	1.40
18	CL31C101JGFNNN □	100pF		500	±5%	1.40
19	CL31C101JHFNNN □	100pF		630	±5%	1.40
20	CL31C101JIFNNN □	100pF		1000	±5%	1.40
21	CL31C101JHNNN □	100pF		2000	±5%	1.80
22	CL31C121JGFNNN □	120pF		500	±5%	1.40
23	CL31C151JGFNNN □	150pF		500	±5%	1.40
24	CL31C181JGFNNN □	180pF		500	±5%	1.40
25	CL31C221JGFNNN □	220pF		500	±5%	1.40
26	CL31C271JGFNNN □	270pF		500	±5%	1.40
27	CL31C271JCCNNN □	270pF		100	±5%	1.00
28	CL31C331JGFNNN □	330pF		500	±5%	1.40
29	CL31C331JHNNN □	330pF		1000	±5%	1.80
30	CL31C391JCCNNN □	390pF		100	±5%	1.00
31	CL31C471JGFNNN □	470pF		500	±5%	1.40
32	CL31C471JHFNNN □	470pF		630	±5%	1.40
33	CL31C471JIFNNN □	470pF		1000	±5%	1.40
34	CL31C561JCCNNN □	560pF		100	±5%	1.00
35	CL31C561JGFNNN □	560pF		500	±5%	1.40
36	CL31C681JGFNNN □	680pF		500	±5%	1.80
37	CL31C821JHNNN □	820pF		630	5%	1.80

※ □ mark means packaging code. If you want to learn the code or quantity in detail, please see p74.

Product Lineup (Medium-High Voltage Capacitors-C0G)

	Part Number	Size L x W (mm)	Capacitance	Rated Voltage (Vdc)	Capacitance Tolerance	Thickness Max.(mm)	
36	CL31C102JCCNNN □	3.20×1.60	1nF	100	±5%	1.00	
37	CL31C102JGHNNN □		1nF	500	±5%	1.80	
38	CL31C152JCCNNN □		1.5nF	100	±5%	1.00	
39	CL31C222JCCNNN □		2.2nF	100	±5%	1.00	
40	CL31C332JGHNNN □		3.3nF	500	±5%	1.80	
41	CL31C332JHHNNN □		3.3nF	630	±5%	1.80	
42	CL31C392JCHNNN □		3.9nF	100	±5%	1.80	
43	CL31C822JDHNNN □		8.2nF	200	±5%	1.80	
44	CL31C822JEHNNN □		8.2nF	250	±5%	1.80	
45	CL31C183JCHNNN □		18nF	100	±5%	1.80	
1	CL32C101JFFNNN □		3.20×2.50	100pF	2000	±5%	1.45
2	CL32C471JJJNNN □			470pF	2000	±5%	2.70
3	CL32C821JIJNNN □	820pF		1000	±5%	2.70	
4	CL32C103JGJNNN □	10nF		500	±5%	2.70	
5	CL32C103JHJNNN □	10nF		630	±5%	2.70	
6	CL32C273JDJNNN □	27nF		200	±5%	2.70	
7	CL32C273JEJNNN □	27nF		250	±5%	2.70	
8	CL32C563JCJNNN □	56nF		100	±5%	2.70	
1	CL42C100JKFNNN □	4.50×2.00	10pF	3000	±5%	1.45	
2	CL42C151JKINNN □		150pF	3000	±5%	2.20	
3	CL42C221JJHNNN □		220pF	2000	±5%	1.80	
1	CL43C391JKJNNN □	4.50×3.20	390pF	3000	±5%	2.70	
2	CL43C102JIHNNN □		1nF	1000	±5%	1.80	
3	CL43C122JIINNN □		1.2nF	1000	±5%	2.20	
4	CL43C182JIJNNN □		1.8nF	1000	±5%	2.70	
5	CL43C182JJJNNN □		1.8nF	2000	±5%	2.70	
6	CL43C223JGJNNN □		22nF	500	±5%	2.70	
7	CL43C223JHJNNN □		22nF	630	±5%	2.70	
8	CL43C473JDJNNN □		47nF	200	±5%	2.70	
9	CL43C473JEJNNN □		47nF	250	±5%	2.70	
10	CL43C563JCJNNN □		56nF	100	±5%	2.70	
1	CL55C102JJJNNN □	5.70×5.00	1nF	2000	±5%	2.70	
2	CL55C102JKJNNN □		1nF	3000	±5%	2.70	
3	CL55C362JIJNNN □		3.6nF	1000	±5%	2.70	
4	CL55C223JGJNNN □		22nF	500	±5%	2.70	
5	CL55C223JHJNNN □		22nF	630	±5%	2.70	
6	CL55C473JDJNNN □		47nF	200	±5%	2.70	
7	CL55C473JEJNNN □		47nF	250	±5%	2.70	
8	CL55C683JCJNNN □		68nF	100	±5%	2.70	

※ □ mark means packaging code. If you want to learn the code or quantity in detail, please see p74.

Part Numbering System

Standard & High Capacitors

Super Small Size Capacitors

High-Q Capacitors

Medium-High Voltage Capacitors

Array Type Capacitors

Low ESL Capacitors

Reliability Test Condition

Premium Capacitors for Automotive Applications

Packaging Specification

Application Manual for Surface Mounting



**Product Lineup (Medium-High Voltage Capacitors-X7R)**

	Part Number	Size L x W (mm)	Capacitance	Rated Voltage (Vdc)	Capacitance Tolerance	Thickness Max.(mm)
1	CL10B102KC8NNN □	1.60 x 0.80	1nF	100	±10%	0.90
2	CL10B472KC8NNN □		4.7nF	100	±10%	0.90
3	CL10B103KC8NNN □		10nF	100	±10%	0.90
4	CL10B104KC8NNN □		100nF	100	±10%	0.90
1	CL21B221KDCNNN □	2.00×1.25	220pF	200	±10%	0.95
2	CL21B221KCANNN □		220pF	100	±10%	0.75
3	CL21B331KDCNNN □		330pF	200	±10%	0.95
4	CL21B471KCANNN □		470pF	100	±10%	0.75
5	CL21B102KDCNNN □		1nF	200	±10%	0.95
6	CL21B102KCANNN □		1nF	100	±10%	0.75
7	CL21B222KDCNNN □		2.2nF	200	±10%	0.95
8	CL21B222KCANNN □		2.2nF	100	±10%	0.75
9	CL21B332KCANNN □		3.3nF	100	±10%	0.75
10	CL21B472KDCNNN □		4.7nF	200	±10%	0.95
11	CL21B472KCANNN □		4.7nF	100	±10%	0.75
12	CL21B682KCANNN □		6.8nF	100	±10%	0.75
13	CL21B103KDCNNN □		10nF	200	±10%	0.95
14	CL21B103KCANNN □		10nF	100	±10%	0.75
15	CL21B153KEFNNN □		15nF	250	±10%	1.35
16	CL21B153KDFNNN □		15nF	200	±10%	1.35
17	CL21B153KCCNNN □		15nF	100	±10%	0.95
18	CL21B223KCFNNN □		22nF	100	±10%	1.35
19	CL21B473KCFNNN □		47nF	100	±10%	1.35
20	CL21B683KCFNNN □		68nF	100	±10%	1.35
21	CL21B154KCFNNN □		150nF	100	±10%	1.35
22	CL21B224KCFNNN □		220nF	100	±10%	1.35
1	CL31B221KGFNNN □	3.20×1.60	220pF	500	±10%	1.40
2	CL31B471KGFNNN □		470pF	500	±10%	1.40
3	CL31B471KDCNNN □		470pF	200	±10%	1.00
4	CL31B102KJHNNN □		1nF	2000	±10%	1.80
5	CL31B102KIFNNN □		1nF	1000	±10%	1.40
6	CL31B102KGFNNN □		1nF	500	±10%	1.40
7	CL31B102KHFNNN □		1nF	630	±10%	1.40
8	CL31B152KGFNNN □		1.5nF	500	±10%	1.40
9	CL31B152KJHNNN □		1.5nF	2000	±10%	1.80
10	CL31B222KIFNNN □		2.2nF	1000	±10%	1.40
11	CL31B222KDCNNN □		2.2nF	200	±10%	1.00
12	CL31B222KGFNNN □		2.2nF	500	±10%	1.40
13	CL31B222KJHNNN □		2.2nF	2000	±10%	1.80
14	CL31B332KGFNNN □		3.3nF	500	±10%	1.40
15	CL31B332KIFNNN □		3.3nF	1000	±10%	1.40
16	CL31B472KGFNNN □		4.7nF	500	±10%	1.40

※ □ mark means packaging code. If you want to learn the code or quantity in detail, please see p74.

**Product Lineup (Medium-High Voltage Capacitors-X7R)**

	Part Number	Size L x W (mm)	Capacitance	Rated Voltage (Vdc)	Capacitance Tolerance	Thickness Max.(mm)	
17	CL31B472KDCNNN □	3.20×1.60	4.7nF	200	±10%	1.00	
18	CL31B682KGFNNN □		6.8nF	500	±10%	1.40	
19	CL31B103KHFNNN □		10nF	630	±10%	1.40	
20	CL31B103KGFNNN □		10nF	500	±10%	1.40	
21	CL31B103KFCSNN □		10nF	350	±10%	1.00	
22	CL31B153KDCNNN □		15nF	200	±10%	1.00	
23	CL31B153KFCSNN □		15nF	350	±10%	1.00	
24	CL31B153KCCNNN □		15nF	100	±10%	1.00	
25	CL31B153KGFNNN □		15nF	500	±10%	1.40	
26	CL31B153KHFNNN □		15nF	630	±10%	1.40	
27	CL31B223KDCNNN □		22nF	200	±10%	1.00	
28	CL31B223KCCNNN □		22nF	100	±10%	1.00	
29	CL31B223KFCSNN □		22nF	350	±10%	1.00	
30	CL31B223KGHNNN □		22nF	500	±10%	1.80	
31	CL31B223KHHNNN □		22nF	630	±10%	1.80	
32	CL31B333KDFNNN □		33nF	200	±10%	1.40	
33	CL31B333KFESNN □		33nF	350	±10%	1.25	
34	CL31B333KCCNNN □		33nF	100	±10%	1.00	
35	CL31B333KGHNNN □		33nF	500	±10%	1.80	
36	CL31B333KHHNNN □		33nF	630	±10%	1.80	
37	CL31B473KDFNNN □		47nF	200	±10%	1.40	
38	CL31B473KFHSNN □		47nF	350	±10%	1.80	
39	CL31B473KCCNNN □		47nF	100	±10%	1.00	
40	CL31B473KEHNNN □		47nF	250	±10%	1.80	
41	CL31B683KEHNNN □		68nF	250	±10%	1.80	
42	CL31B104KDHNNN □		100nF	200	±10%	1.80	
43	CL31B104KCFNNN □		100nF	100	±10%	1.40	
44	CL31B104KEHNNN □		100nF	250	±10%	1.80	
45	CL31B154KCHNNN □		150nF	100	±10%	1.80	
46	CL31B105KCHNNN □		1μF	100	±10%	1.80	
47	CL31B155KCHNNN □		1.5μF	100	±10%	1.80	
48	CL31B225KCHNNN □		2.2μF	100	±10%	1.80	
1	CL32B102KJFNNN □		3.20×2.50	1nF	2000	±10%	1.45
2	CL32B472KHFNNN □			4.7nF	630	±10%	1.45
3	CL32B472KIFNNN □			4.7nF	1000	±10%	1.45
4	CL32B682KIFNNN □			6.8nF	1000	±10%	1.45
5	CL32B103KCFNNN □			10nF	100	±10%	1.45
6	CL32B153KGFNNN □			15nF	500	±10%	1.45
7	CL32B223KGFNNN □			22nF	500	±10%	1.45
8	CL32B333KHHNNN □			33nF	630	±10%	1.80
9	CL32B333KGHNNN □			33nF	500	±10%	1.80
10	CL32B473KHHNNN □			47nF	630	±10%	1.80

Part Numbering System

Standard & High Capacitors

Super Small Size Capacitors

High-Q Capacitors

Medium-High Voltage Capacitors

Array Type Capacitors

Low ESL Capacitors

Reliability Test Condition

Premium Capacitors for Automotive Applications

Packaging Specification

Application Manual for Surface Mounting

※ □ mark means packaging code. If you want to learn the code or quantity in detail, please see p74.

## Product Lineup (Medium-High Voltage Capacitors-X7R)

	Part Number	Size L x W (mm)	Capacitance	Rated Voltage (Vdc)	Capacitance Tolerance	Thickness Max.(mm)
11	CL32B473KDHNNN □	3.20×2.50	47nF	200	±10%	1.80
12	CL32B473KGFHNNN □		47nF	500	±10%	1.80
13	CL32B683KDINNN □		68nF	200	±10%	2.20
14	CL32B104KEJNNN □		100nF	250	±10%	2.70
15	CL32B104KDINNN □		100nF	200	±10%	2.20
16	CL32B154KCFNNN □		150nF	100	±10%	1.45
17	CL32B154KDJNNN □		150nF	200	±10%	2.70
18	CL32B154KEJNNN □		150nF	250	±10%	2.70
19	CL32B224KCHNNN □		220nF	100	±10%	1.80
20	CL32B224KDJNNN □		220nF	200	±10%	2.70
21	CL32B224KEJNNN □		220nF	250	±10%	2.70
22	CL32B334KCHNNN □		330nF	100	±10%	1.80
23	CL32B474KCIINN □		470nF	100	±10%	2.20
24	CL32B105KCJNNN □		1μF	100	±10%	2.70
25	CL32B155KCHNNN □		1.5μF	100	±10%	1.80
26	CL32B225KCJNNN □		2.2μF	100	±10%	2.70
1	CL43B102KJFNNN □	4.50×3.20	1nF	2000	±10%	1.45
2	CL43B152KJFNNN □		1.5nF	2000	±10%	1.45
3	CL43B222KIFNNN □		2.2nF	1000	±10%	1.45
4	CL43B222KJFNNN □		2.2nF	2000	±10%	1.45
5	CL43B332KJFNNN □		3.3nF	2000	±10%	1.45
6	CL43B103KIFNNN □		10nF	1000	±10%	1.45
7	CL43B333KIJNNN □		33nF	1000	±10%	2.70
8	CL43B473KGFNNN □		47nF	500	±10%	1.45
9	CL43B473KHFNNN □		47nF	630	±10%	1.45
10	CL43B104KGINNN □		100nF	500	±10%	2.20
11	CL43B104KDFNNN □		100nF	200	±10%	1.45
12	CL43B104KHINNN □		100nF	630	±10%	2.20
13	CL43B224KCFNNN □		220nF	100	±10%	1.45
14	CL43B334KCFNNN □		330nF	100	±10%	1.45
15	CL43B474KEJNNN □		470nF	250	±10%	2.70
16	CL43B474KCHNNN □		470nF	100	±10%	1.80
17	CL43B474KDJNNN □		470nF	200	±10%	2.70
18	CL43B105KCJNNN □		1μF	100	±10%	2.70
1	CL55B103KJHNNN □	5.70×5.00	10nF	2000	±10%	1.80
2	CL55B473KIINN □		47nF	1000	±10%	2.20
3	CL55B224KGJNNN □		220nF	500	±10%	2.70
4	CL55B224KHJNNN □		220nF	630	±10%	2.70
5	CL55B105KCHNNN □		1μF	100	±10%	1.80
6	CL55B105KDJNNN □		1μF	200	±10%	2.70
7	CL55B105KEJNNN □		1μF	250	±10%	2.70
8	CL55B475KCJNNN □		4.7μF	100	±10%	2.70

※ □ mark means packaging code. If you want to learn the code or quantity in detail, please see p74.



## Feature

- Reduction in required space (more than 50%)
- Reduction in cost and time for replacement of PCB
- Reduction in amount of solder joints
- Easier PCB design
- Reduced waste from tape and reel packaging process
- It protect EMI bypassing digital signal line nose

## Application

- A bypass for digital and analog signal line noise generated by telecommunication equipment and other common electronic circuits

## Structure and Dimensions



Code	Size (mm)	EIA Code	Dimension (mm)					
			L	W	T	BW	SW	P
A	0906	0302	$0.90 \pm 0.05$	$0.60 \pm 0.05$	$0.45 \pm 0.05$	$0.25 \pm 0.05$	$0.15 \pm 0.1$	$0.45 \pm 0.05$
A	1410	0504	$1.37 \pm 0.15$	$1.0 \pm 0.15$	$0.35 \pm 0.05$ $0.50 \pm 0.05$ $0.60 \pm 0.06$ $0.80 \pm 0.08$	$0.36 \pm 0.1$	$0.2 \pm 0.1$	$0.64 \pm 0.1$
A	2012	0805	$2.0 \pm 0.15$	$1.25 \pm 0.15$	$0.85 \pm 0.1$	$0.5 \pm 0.2$	$0.25 \pm 0.15$	$1.0 \pm 0.1$
B	2012	0805	$2.0 \pm 0.15$	$1.25 \pm 0.15$	$0.85 \pm 0.1$	$0.25 \pm 0.1$	$0.25 \pm 0.15$	$0.5 \pm 0.1$
B	3216	1206	$3.2 \pm 0.15$	$1.6 \pm 0.15$	$0.85 \pm 0.15$	$0.4 \pm 0.2$	$0.3 \pm 0.15$	$0.8 \pm 0.2$

## Structure and Control Code

### ■ A : ARRAY(2-element)

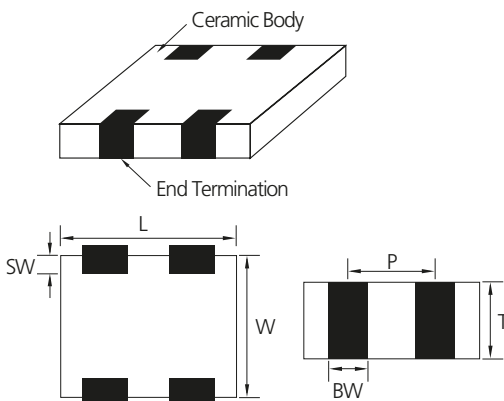

### ■ B : ARRAY(4-element)

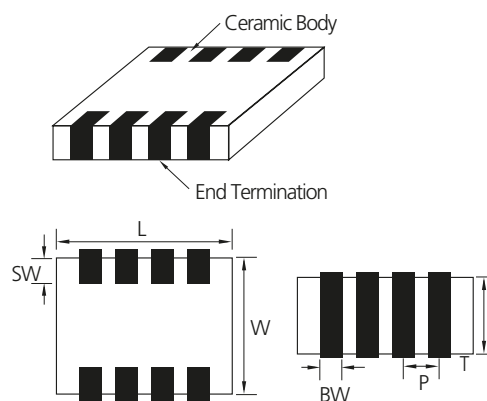

Part Numbering System

Standard & High Capacitors

Super Small Size Capacitors

High-Q Capacitors

Medium-High Voltage Capacitors

Array Type Capacitors

Low ESL Capacitors

Reliability Test Condition

Premium Capacitors for Automotive Applications

Packaging Specification

Application Manual for Surface Mounting





Product Lineup (Array Type Capacitors )

	Part Number	Element Type	Size L x W (mm)	Capacitance	Rated Voltage (Vdc)	Capacitance Tolerance	Thickness Max.(mm)
1	CL14C270KA6NAN □	2-Array	1.40×1.00	27pF	25	± 10%	0.66
1	CL31C100JBCNBN □	4-Array	3.20×1.60	10pF	50	± 5%	1.00
2	CL31C150JBCNBN □			15pF	50	± 5%	1.00
3	CL31C220JBCNBN □			22pF	50	± 5%	1.00
4	CL31C270JBCNBN □			27pF	50	± 5%	1.00
5	CL31C330KBCNBN □			33pF	50	± 10%	1.00
6	CL31C390KBCNBN □			39pF	50	± 10%	1.00
7	CL31C680JBCNBN □			68pF	50	± 5%	1.00
8	CL31C820JBCNBN □			82pF	50	± 5%	1.00
9	CL31C101JBCNBN □			100pF	50	± 5%	1.00
10	CL31C151KBCNBN □			150pF	50	± 10%	1.00
11	CL31C181JBCNBN □			180pF	50	± 5%	1.00
12	CL31C331JBCNBN □			330pF	50	± 5%	1.00
13	CL31C471JBCNBN □			470pF	50	± 5%	1.00
1	CL21B471KBCNBN □	4-Array	2.00×1.25	470pF	50	± 10%	0.95
2	CL21B104KOCNBN □			100nF	16	± 10%	0.95
3	CL21B104MPCNBN □			100nF	10	± 20%	0.95
1	CL31B102MBCNBN □	4-Array	3.20×1.60	1nF	50	± 20%	1.00
2	CL31B103MBCNBN □			10nF	50	± 20%	1.00
3	CL31B153KBCNBN □			15nF	50	± 10%	1.00
4	CL31B473KACNBN □			47nF	25	± 10%	1.00
5	CL31B104KACNBN □			100nF	25	± 10%	1.00
6	CL31B104KOCNBN □			100nF	16	± 10%	1.00
1	CL09A104KP4SAN □	2-Array	0.90×0.60	100nF	10	± 10%	0.50
2	CL09A104KQ4SAN □			100nF	6.3	± 10%	0.50
3	CL09A105MQ4NAN □			1 μF	6.3	± 20%	0.50
4	CL09A105MR4NAN □			1 μF	4	± 20%	0.50
1	CL14A104KA6NAN □	2-Array	1.40×1.00	100nF	25	± 10%	0.66
2	CL14A104KO6NAN □			100nF	16	± 10%	0.66
3	CL14A104KP6NAN □			100nF	10	± 10%	0.66
4	CL14A105MA5NAN □			1 μF	25	± 20%	0.55
5	CL14A105KP8NAN □			1 μF	10	± 10%	0.88
6	CL14A105MO3NAN □			1 μF	16	± 20%	0.40
7	CL14A105MO8NAN □			1 μF	16	± 20%	0.88
8	CL14A105MO5NAN □			1 μF	16	± 20%	0.55
9	CL14A105MP3NAN □			1 μF	10	± 20%	0.40
10	CL14A105MP5NAN □			1 μF	10	± 20%	0.55
11	CL14A225KP8NAN □			2.2 μF	10	± 10%	0.88
12	CL14A225KQ8NAN □			2.2 μF	6.3	± 10%	0.88
1	CL21A105KOCNAN □	2-Array	2.00×1.25	1 μF	16	± 10%	0.95
2	CL21A105MPCNAN □			1 μF	10	± 20%	0.95
1	CL31F473ZBCNBN □	4-Array	3.20×1.60	47nF	50	+80/-20%	1.00
2	CL31F104ZACNBN □			100nF	25	+80/-20%	1.00

※ □ mark means packaging code. If you want to learn the code or quantity in detail, please see p74.

Part Numbering System

Standard & High Capacitors

Super Small Size Capacitors

High-Q Capacitors

Medium-High Voltage Capacitors

Array Type Capacitors

Low ESL Capacitors

Reliability Test Condition

Premium Capacitors for Automotive Applications

Packaging Specification

Application Manual for Surface Mounting

# Low ESL Capacitors



## Feature

- Low ESL, good for noise reduction for high frequency
- Highly reliable tolerance and high speed automatic chip placement on PCBs
- Highly reliable performance
- Highly resistant termination metal
- Tape & reel for surface mount assembly

## Application

- High Speed Microprocessor
- High Frequency Digital Equipment

## LICC(Low Inductance Ceramic Capacitors)



Code	Size (mm)	EIA Code	Dimension(mm)			
			L	W	T	BW
L5	0510	0204	$0.52 \pm 0.05$	$1.0 \pm 0.05$	$0.3 \pm 0.05$	$0.18 \pm 0.06$
01	0816	0306	$0.8 \pm 0.15$	$1.6 \pm 0.2$	$0.5 + 0.05 / - 0.1$	$0.25 \pm 0.15$

## SLIC(Super Low Inductance Capacitors)

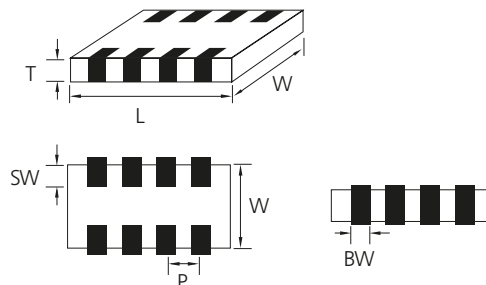

Code	Size (mm)	EIA Code	Dimension(mm)					
			L	W	T	BW	SW	P
10	1608	0603	$1.6 \pm 0.1$	$0.8 \pm 0.1$	$0.5 / + 0.05 - 0.1$	$0.25 \pm 0.1$	$0.15 \pm 0.1$	$0.4 \pm 0.1$
21	2012	0805	$2.0 \pm 0.1$	$1.25 \pm 0.1$	$0.5 / + 0.05 - 0.1$	$0.25 + 0.15 - 0.1$	$0.2 + 0.15 - 0.1$	$0.5 \pm 0.1$

**Low ESL capacitance Table (LICC)**

TC	Size(mm)	Tmax(mm)	Vr(V)	Capacitance( $\mu$ F)									
				0.01	0.022	0.047	0.1	0.22	0.47	1	2.2	4.7	10
X6S /X7S /X7T	0204(0510)	0.35	2.5								X7T		
			4				X7S		X6S				
			6.3				X7S						
	0306(0816)	0.55	4							X7S			

TC	Size(mm)	Tmax(mm)	Vr(V)	Capacitance( $\mu$ F)									
				0.01	0.022	0.047	0.1	0.22	0.47	1	2.2	4.7	10
X7R /X5R	0306(0816)	0.55	6.3			X7R					X5R		
			10			X7R							
			16			X7R							
			25			X7R							
			50		X7R								

**Low ESL capacitance Table (SLIC)**

TC	Size(mm)	Tmax(mm)	Vr(V)	Capacitance( $\mu$ F)								
				0.1	0.47	0.68	1	2.2	4.7	10	22	
X7R /X7S /X7T	0603(1608)	0.55	4			X7S						
	0805(2012)	0.55	4			X7R			X7S			
			6.3			X7R						
			16			X7R						

Part Numbering System

Standard & High Capacitors

Super Small Size Capacitors

High-Q Capacitors

Medium-High Voltage Capacitors

Array Type Capacitors

Low ESL Capacitors

Reliability Test Condition

Premium Capacitors for Automotive Applications

Packaging Specification

Application Manual for Surface Mounting



Product Lineup (Low ESL Capacitors-X7R, X6S, X7S, X7T)

	Part Number	Size L x W (mm)	Capacitance	Rated Voltage (Vdc)	Capacitance Tolerance	Thickness Max.(mm)
1	CL21B104MO5NJJN □	2.00×1.25	100nF	16	± 20%	0.55
2	CL21B684MO5NJJN □		680nF	16	± 20%	0.55
3	CL21B684MQ5NJJN □		680nF	6.3	± 20%	0.55
1	CLL5X224MR3NLLN □	0.50×1.00	220nF	4	± 20%	0.35
2	CLL5X474MR3NLLN □		470nF	4	± 20%	0.35
3	CLL5X105MR3NLLN □		1 $\mu$ F	4	± 20%	0.35
1	CLL5Y104MQ3NLLN □	0.50×1.00	100nF	6.3	± 20%	0.35
1	CL01Y105MR5NLLN □	0.80×1.60	1 $\mu$ F	4	± 20%	0.55
2	CL01Y225MR5NLLN □		2.2 $\mu$ F	4	± 20%	0.55
1	CL10Y474MR5NJJN □	1.60×0.80	470nF	4	± 20%	0.55
2	CL10Y105MR5NJJN □		1 $\mu$ F	4	± 20%	0.55
3	CL10Y225MR5NJJN □		2.2 $\mu$ F	4	± 20%	0.55
1	CL21Y105MR5NJJN □	2.00×1.25	1 $\mu$ F	4	± 20%	0.55
2	CL21Y225MR5NJJN □		2.2 $\mu$ F	4	± 20%	0.55
1	CLL5Z105MS3NLLN □	0.50×1.00	1 $\mu$ F	2.5	± 20%	0.35

※ □ mark means packaging code. If you want to learn the code or quantity in detail, please see p74.

No	Item	Performance	Test Condition		
1	Appearance	No abnormal exterior appearance	Visual Inspection through Microscope (x10)		
2	Insulation Resistance	10,000MΩ min. or 500MΩ · μF min. (or *100MΩ · μF) product whichever is smaller (Rated voltage ≤ 16V: 10,000MΩ min. or 100MΩ · μF min. product whichever is smaller)	Apply the rated voltage for 60~120 sec. Rated voltage > 500V: Insulation Resistance shall be measured with 500 ± 50Vdc		
3	Withstanding Voltage	No dielectric breakdown or mechanical breakdown	Apply the specified voltage* for 1~5 sec. Charge / Discharge current limit: 50mA max. *CLASS I (Rated Voltage < 100V) : 300% of the rated Voltage CLASS II (Rated Voltage < 100V) : 250% of the rated Voltage  In the case of Vr ≥ 100V products, following condition should be applied. 100V ≤ Rated Voltage < 500V : 200% of the rated Voltage 500V ≤ Rated Voltage < 1000V : 150% of the rated Voltage Rated Voltage ≥ 1000V : 120% of the rated Voltage		
4	Capacitance	CLASS I Within the specified tolerance	Capacitance	Frequency	Voltage
			≤ 1,000 pF	1MHz ± 10%	0.5 ~ 5 Vrms
		> 1,000 pF	1KHz ± 10%		
		CLASS II Within the specified tolerance	Capacitance	Frequency	Voltage
≤ 10 μF	1KHz ± 10%		1.0 ± 0.2 Vrms		
> 10 μF	120Hz ± 20%		0.5 ± 0.1 Vrms		
		*	1KHz ± 10%	0.5 ± 0.1 Vrms	
* A capacitor prior to measuring the capacitance is heat treated at 150°C+0/-10°C and maintained in ambient air for 24±2 hours.					
Q	CLASS I	Capacitance ≥ 30pF : Q ≥ 1,000 < 30pF : Q ≥ 400 + 20 × C (C : Capacitance)	Capacitance	Frequency	Voltage
			≤ 1,000 pF	1MHz ± 10%	0.5 ~ 5 Vrms
		> 1,000 pF	1KHz ± 10%		
5	Tan δ	CLASS II	1. Characteristic : A(X5R)		
			Rated Voltage	Spec	
			50V / 35V	0.025 max / 0.05 max*	
			25V	0.025 max / 0.05 max* / 0.10 max*	
			16V	0.035 max / 0.05 max* / 0.10 max*	
			≤ 10V	0.05 max / 0.10 max*	
			2. Characteristic : B(X7R), X(X6S), Y(X7S)		
			Rated Voltage	Spec	
			50V ≥ / 35V / 25V	0.025 max / 0.05 max* / 0.10 max*	
			16V	0.035 max / 0.10 max*	
			≤ 10V	0.05 max / 0.10 max*	
			3. Characteristic : F(Y5V)		
Rated Voltage	Spec				
50V / 35V / 25V	0.05 max / 0.07 max* / 0.09 max*				
16V	0.07 max / 0.09 max* / 0.125 max*				
10V	0.125 max / 0.16 max*				
≤ 6.3V	0.16 max				
You can check the specification at the web site or contact sales people for each product with mark*					

※ The conditions of measurement may be altered upon request.

Part Numbering System

Standard & High Capacitors

Super Small Size Capacitors

High-Q Capacitors

Medium-High Voltage Capacitors

Array Type Capacitors

Low ESL Capacitors

Reliability Test Condition

Premium Capacitors for Automotive Applications

Packaging Specification

Application Manual for Surface Mounting

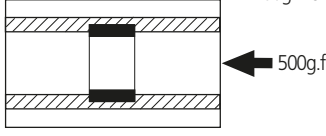
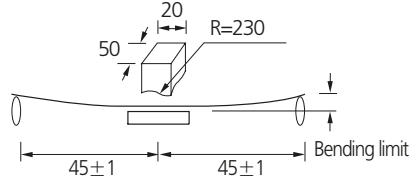
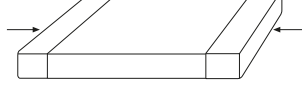
No	Item	Performance	Test Condition																		
6	Temperature Characteristics of Capacitance	<table border="1"> <tr> <th colspan="2">CLASS I</th> </tr> <tr> <th>Characteristic</th> <th>Temp.Coefficient(PPM/°C)</th> </tr> <tr> <td>C</td> <td>0±30</td> </tr> </table>	CLASS I		Characteristic	Temp.Coefficient(PPM/°C)	C	0±30	Capacitance shall be measured by the steps shown in the following table. <table border="1"> <tr> <th>Step</th> <th>Temperature (°C)</th> </tr> <tr> <td>1</td> <td>25±2</td> </tr> <tr> <td>2</td> <td>Min. Operating Temp. ±2</td> </tr> <tr> <td>3</td> <td>25±2</td> </tr> <tr> <td>4</td> <td>Max. Operating Temp. ±2</td> </tr> <tr> <td>5</td> <td>25±2</td> </tr> </table> <p>(1) CLASS I Temperature Coefficient shall be calculated from the formula as below  <math display="block">\text{Temp. Coefficient} = \frac{C_2 - C_1}{C_1 \times \Delta T} \times 10^6 [\text{ppm}/^\circ\text{C}]</math>           C1: Capacitance at step 3            C2: Capacitance at 125°C            ΔT: 100°C (=125°C - 25°C)</p> <p>(2) CLASS II Capacitance Change shall be calculated from the formula as below  <math display="block">\Delta C = \frac{C_2 - C_1}{C_1} \times 100(\%)</math>           C1: Capacitance at step 3            C2: Capacitance at step 2 or 4</p>	Step	Temperature (°C)	1	25±2	2	Min. Operating Temp. ±2	3	25±2	4	Max. Operating Temp. ±2	5	25±2
		CLASS I																			
Characteristic	Temp.Coefficient(PPM/°C)																				
C	0±30																				
Step	Temperature (°C)																				
1	25±2																				
2	Min. Operating Temp. ±2																				
3	25±2																				
4	Max. Operating Temp. ±2																				
5	25±2																				
<table border="1"> <tr> <th colspan="2">CLASS II</th> </tr> <tr> <th>Characteristic</th> <th>Capacitance Change(%) with No bias</th> </tr> <tr> <td>A(X5R), B(X7R)</td> <td>±15%</td> </tr> <tr> <td>X(X6S), Y(X7S)</td> <td>±22%</td> </tr> <tr> <td>Z(X7T)</td> <td>+22%~-33%</td> </tr> <tr> <td>F(Y5V)</td> <td>+22%~-82%</td> </tr> </table>	CLASS II		Characteristic	Capacitance Change(%) with No bias	A(X5R), B(X7R)	±15%	X(X6S), Y(X7S)	±22%	Z(X7T)	+22%~-33%	F(Y5V)	+22%~-82%									
CLASS II																					
Characteristic	Capacitance Change(%) with No bias																				
A(X5R), B(X7R)	±15%																				
X(X6S), Y(X7S)	±22%																				
Z(X7T)	+22%~-33%																				
F(Y5V)	+22%~-82%																				
7	Adhesive Strength of Termination	No indication of peeling shall occur on the terminal electrode	Apply 500g.f* pressure for 10±1 sec. *200g.f for 0201 *100g.f for 01005 																		
8	Appearance	No indication of peeling shall occur	<ul style="list-style-type: none"> <li>Bending Limit: 1mm</li> <li>Test Speed: 1.0mm/sec.</li> <li>Keep the test board at the limit point in 5 sec.</li> <li>Then Measure Capacitance</li> </ul> 																		
	Capacitance	<table border="1"> <tr> <th>Characteristic</th> <th>Capacitance Change</th> </tr> <tr> <td>CLASS I</td> <td>±5% or ±0.5 pF whichever is larger</td> </tr> <tr> <td>CLASS II</td> <td></td> </tr> <tr> <td>A(X5R), B(X7R), X(X6S), Y(X7S), Z(X7T)</td> <td>±12.5%</td> </tr> <tr> <td>F(Y5V)</td> <td>±30%</td> </tr> </table>		Characteristic	Capacitance Change	CLASS I	±5% or ±0.5 pF whichever is larger	CLASS II		A(X5R), B(X7R), X(X6S), Y(X7S), Z(X7T)	±12.5%	F(Y5V)	±30%								
Characteristic	Capacitance Change																				
CLASS I	±5% or ±0.5 pF whichever is larger																				
CLASS II																					
A(X5R), B(X7R), X(X6S), Y(X7S), Z(X7T)	±12.5%																				
F(Y5V)	±30%																				
9	Solderability	More than 75% of the terminal surface is to be soldered newly, so metal part does not come out or dissolve 	<table border="1"> <tr> <td>Solder</td> <td>Sn-3Ag-0.5Cu</td> </tr> <tr> <td>Solder Temp.</td> <td>245±5°C</td> </tr> <tr> <td>Flux</td> <td>RMA Type</td> </tr> <tr> <td>Dip time</td> <td>3±0.3 sec.</td> </tr> <tr> <td>Pre-heating</td> <td>at 80~120°C for 10~30 sec.</td> </tr> </table>	Solder	Sn-3Ag-0.5Cu	Solder Temp.	245±5°C	Flux	RMA Type	Dip time	3±0.3 sec.	Pre-heating	at 80~120°C for 10~30 sec.								
Solder	Sn-3Ag-0.5Cu																				
Solder Temp.	245±5°C																				
Flux	RMA Type																				
Dip time	3±0.3 sec.																				
Pre-heating	at 80~120°C for 10~30 sec.																				
10	Appearance	No mechanical damage shall occur	Solder temperature: 270±5°C, DIP TIME:10±1 sec. Each termination shall be fully immersed and preheated as below: <table border="1"> <tr> <th>Step</th> <th>Temperature(°C)</th> <th>Time (sec.)</th> </tr> <tr> <td>1</td> <td>80~100</td> <td>60</td> </tr> <tr> <td>2</td> <td>150~180</td> <td>60</td> </tr> </table> <p>Leave the capacitor in ambient condition for specified time* before measurement            *24±2 hours(CLASS I)            24±2 hours(CLASS II)</p>	Step	Temperature(°C)	Time (sec.)	1	80~100	60	2	150~180	60									
	Step	Temperature(°C)		Time (sec.)																	
	1	80~100		60																	
	2	150~180		60																	
	Capacitance	<table border="1"> <tr> <th>Characteristic</th> <th>Capacitance Change</th> </tr> <tr> <td>CLASS I</td> <td>±2.5% or ±0.25 pF whichever is larger</td> </tr> <tr> <td>CLASS II</td> <td></td> </tr> <tr> <td>A(X5R), B(X7R), X(X6S), Y(X7S), Z(X7T)</td> <td>±7.5%</td> </tr> <tr> <td>F(Y5V)</td> <td>±20%</td> </tr> </table>		Characteristic	Capacitance Change	CLASS I	±2.5% or ±0.25 pF whichever is larger	CLASS II		A(X5R), B(X7R), X(X6S), Y(X7S), Z(X7T)	±7.5%	F(Y5V)	±20%								
	Characteristic	Capacitance Change																			
	CLASS I	±2.5% or ±0.25 pF whichever is larger																			
CLASS II																					
A(X5R), B(X7R), X(X6S), Y(X7S), Z(X7T)	±7.5%																				
F(Y5V)	±20%																				
Q (CLASS I)	Within the specified initial value																				
Tanδ (CLASS II)	Within the specified initial value																				
Insulation resistance	Within the specified initial value																				
Withstanding voltage	Within the specified initial value																				

No	Item	Performance	Test Condition			
11	Vibration Test	Appearance	No mechanical damage shall occur	The capacitor shall be subjected to a harmonic motion having a total amplitude of 1.5mm changing frequency from 10Hz to 55Hz and back to 10Hz in about 1 min.  Repeat this for 2hours each in 3 mutually perpendicular directions.		
		Capacitance	Characteristic		Capacitance Change	
			CLASS I		$\pm 2.5\%$ or $\pm 0.25$ pF whichever is larger	
			CLASS II		A(X5R), B(X7R)	$\pm 5\%$
					X(X6S), Y(X7S) Z(X7T)	$\pm 10\%$
		F(Y5V)			$\pm 20\%$	
Q (CLASS I)	Within the specified initial value					
Tan $\delta$ (CLASS II)	Within the specified initial value					
Insulation resistance	Within the specified initial value					
12	Moisture Resistance	Appearance	No mechanical damage shall occur	Applied Voltage: rated voltage Temperature: $40 \pm 2^\circ\text{C}$ Humidity: 90~95% RH Duration Time: 500+12/-0 Hr. Charge/Discharge Current: 50mA max.  Perform the initial measurement according to Note1. Perform the final measurement according to Note2.		
		Capacitance	Characteristic		Capacitance Change	
			CLASS I		$\pm 7.5\%$ or $\pm 0.75$ pF whichever is larger	
			CLASS II		A(X5R), B(X7R), X(X6S), Y(X7S) Z(X7T)	$\pm 12.5\%$
					F(Y5V)	$\pm 30\%$
		Q (CLASS I)			Capacitance $\geq 30$ pF : $Q \geq 200$ < 30 pF : $Q \geq 100 + 10/3 \times C$ (C: Capacitance)	
Tan $\delta$ (CLASS II)	1.Capacitance: A(X5R) 0.05 max / 0.075 max* (35V / 50V) 0.05 max / 0.075 max* / 0.125 max*(16V / 25V) 0.075 max / 0.125 max* ( $\leq 10$ V)  2.Capacitance: B(X7R), X(X6S) 0.05 max / 0.125 max* (16V / 25V / 35V / 50V $\geq$ ) 0.075 max / 0.125 max* ( $\leq 10$ V)  3.Capacitance: F(Y5V) 0.09 max (50V) 0.09 max / 0.125 max* (25V / 35V) 0.09 max / 0.125 max* / 0.16 max* (16V) 0.16 max / 0.195 max* (10V) 0.195 max (4V / 6.3V)					
Insulation resistance	500M $\Omega$ min. or 25M $\Omega$ $\cdot \mu\text{F}$ min. product whichever is smaller / 12.5M $\Omega$ $\cdot \mu\text{F}$ or over*					
13	High Temperature Resistance	Appearance	No mechanical damage shall occur	Temperature : max. operating temperature  Duration Time: 1000+48/-0 Hr. Charge/Discharge Current: 50mA max.  Vr $\leq 200$ V : 200% of the rated Voltage 250V $\leq$ Vr $\leq 500$ V : 150% of the rated Voltage Vr=630V : 120% of the rated Voltage 1000V $\leq$ Vr $\leq 3000$ V : 100% of the rated Voltage * : 150% or 100% of the rated Voltage  Perform the initial measurement according to Note1 for class II Perform the final measurement according to Note2.		
		Capacitance	Characteristic		Capacitance Change	
			CLASS I		$\pm 3\%$ or $\pm 0.3$ pF whichever is larger	
			CLASS II		A(X5R), B(X7R), X(X6S), Y(X7S) Z(X7T)	$\pm 12.5\%$
					F(Y5V)	$\pm 30\%$
		Q (CLASS I)			Capacitance $\geq 30$ pF : $Q \geq 350$ 10 $\leq$ Capacitance < 30 pF : $Q \geq 275 + 2.5 \times C$ Capacitance < 10 pF : $Q \geq 200 + 10 \times C$ (C: Capacitance)	
Tan $\delta$ (CLASS II)	1.Capacitance : A(X5R) 0.05 max / 0.075 max* (35V / 50V) 0.05 max / 0.075 max* / 0.125 max*(16V / 25V) 0.075 max / 0.125 max* ( $\leq 10$ V)  2.Capacitance : B(X7R), X(X6S) 0.05 max / 0.125 max* (16V / 25V / 35V / 50V $\geq$ ) 0.075 max / 0.125 max* ( $\leq 10$ V)  3.Capacitance : F(Y5V) 0.09 max (50V) 0.09 max / 0.125 max* (25V / 35V) 0.09 max / 0.125 max* / 0.16 max* (16V) 0.16 max / 0.195 max* (10V) 0.195 max (4V / 6.3V)					
Insulation resistance	1,000M $\Omega$ min. or 50M $\Omega$ $\cdot \mu\text{F}$ min. product whichever is smaller / 25M $\Omega$ $\cdot \mu\text{F}$ or over*					

Part Numbering System

Standard & High Capacitors

Super Small Size Capacitors

High-Q Capacitors

Medium-High Voltage Capacitors

Array Type Capacitors

Low ESL Capacitors

Reliability Test Condition

Premium Capacitors for Automotive Applications

Packaging Specification

Application Manual for Surface Mounting



No	Item	Performance	Test Condition															
14	Temperature Cycle	Appearance	No mechanical damage shall occur															
		Capacitance	Characteristic	Capacitance Change														
			CLASS I		$\pm 2.5\%$ or $\pm 0.25\text{pF}$ whichever is larger													
			CLASS II	A(X5R), B(X7R)	$\pm 7.5\%$													
				X(X6S), Y(X7S) Z(X7T)	$\pm 15\%$													
		F(Y5V)		$\pm 20\%$														
		Q (CLASS I)	Within the specified initial value															
Tan $\delta$ (CLASS II)	Within the specified initial value																	
Insulation resistance	Within the specified initial value																	
			Capacitor shall be subjected to 5 cycles. Condition for 1 cycle:															
			<table border="1"> <thead> <tr> <th>Step</th> <th>Temperature(°C)</th> <th>Time(min.)</th> </tr> </thead> <tbody> <tr> <td>1</td> <td>min. operating temperature +0/-3</td> <td>30</td> </tr> <tr> <td>2</td> <td>25</td> <td>2~3</td> </tr> <tr> <td>3</td> <td>max. operating temperature +0/-3</td> <td>30</td> </tr> <tr> <td>4</td> <td>25</td> <td>2~3</td> </tr> </tbody> </table>	Step	Temperature(°C)	Time(min.)	1	min. operating temperature +0/-3	30	2	25	2~3	3	max. operating temperature +0/-3	30	4	25	2~3
Step	Temperature(°C)	Time(min.)																
1	min. operating temperature +0/-3	30																
2	25	2~3																
3	max. operating temperature +0/-3	30																
4	25	2~3																
			Leave the capacitor in ambient condition for specified time* before measurement *24 $\pm$ 2 hours(CLASS I) 24 $\pm$ 2 hours(CLASS II)															

No	Recommended Soldering Method						
15	Recommended Soldering Method By Size & Capacitance	Size inch(mm)	Temperature Characteristic	Capacitance	Condition		
					Flow	Reflow	
		01005(0402)	-	-	-	-	○
		0201 (0603)					
		0402 (1005)					
		0603(1608)	Class I	-	-	○	○
			Class II	$C < 1 \mu\text{F}$	-	○	○
					$C \geq 1 \mu\text{F}$	-	○
		0805 (2012)	Class I	-	-	○	○
			Class II	$C < 4.7 \mu\text{F}$	-	○	○
					$C \geq 4.7 \mu\text{F}$	-	○
			Array	-	-	-	○
		1206 (3216)	Class I	-	-	○	○
			Class II	$C < 10 \mu\text{F}$	-	○	○
					$C \geq 10 \mu\text{F}$	-	-
	Array	-	-	-	○		
1210 (3225)	-	-	-	-	○		
1808 (4520)					○		
1812 (4532)					○		
2220 (5750)					○		
					○		

**Note 1. Initial Measurement For Class II**

Perform the heat treatment at 150°C +0/-10°C for 1 hour. Then Leave the capacitor in ambient condition for 24  $\pm$  2 hours before measurement. Then perform the measurement.

**Note 2. Latter Measurement**

1. CLASS I

Leave the capacitor in ambient condition for 24  $\pm$  2 hours before measurement. Then perform the measurement.

2. CLASS II

Perform the heat treatment at 150°C +0/-10°C for 1 hour. Then Leave the capacitor in ambient condition for 24  $\pm$  2 hours before measurement. Then perform the measurement.

Note 3. All Size in Reliability Test Condition Section is "inch"

Note 4. Camera Strobe Circuit Capacitors Should be Following a Special Reliability Test Condition.  
Please check with our sales representatives or product engineers.





*Premium Capacitors for Automotive Applications*

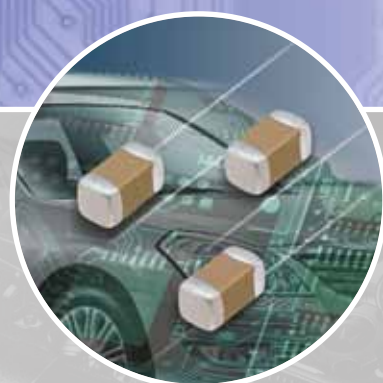

**SAMSUNG  
ELECTRO-MECHANICS**

**SAMSUNG**



**\* Class I**

Symbol	EIA Code	Operation Temperature Range(°C)	Temperature Coefficient Range(ppm/°C)
C	C0G	-55~+125	0±30

**Class II**

Symbol	EIA Code	Operation Temperature Range(°C)	Capacitance Change(ΔC%)
B	X7R	-55~+125	0±15

**\*\* Capacitance Tolerance**

Code	Capacitance Tolerance	TC	Capacitance Step	Rated Capacitance
C	±0.25pF	C0G	Under 5pF	E-12 series *
D	±0.5pF	C0G	6.0 to 9.0pF	E-12 series *
J	±5%	C0G	Over 10pF	E-12 series
K	±10%	X7R	Under 0.01μF	E-3 series
			Over 0.01μF	E-6 series
M	±20%	X7R	Under 0.01μF	E-3 series
			Over 0.01μF	E-6 series

\* E-24 series is also available

Series	Capacitance Step											
	1.0				2.2				4.7			
E-3	1.0				2.2				4.7			
E-6	1.0		1.5		2.2		3.3		4.7		6.8	
E-12	1.0	1.2	1.5	1.8	2.2	2.7	3.3	3.9	4.7	5.6	6.8	8.2
E-24	1.0	1.1	1.2	1.3	2.2	2.4	2.7	3.0	4.7	5.1	5.6	6.2
	1.5	1.6	1.8	2.0	3.3	3.6	3.9	4.3	6.8	7.5	8.2	9.1

\*\*\*

Size	Code	Thickness(mm)	Spec(mm) *
0402(1005)	5	0.50	±0.05
0603(1608)	8	0.80	±0.10
0805(2012)	6	0.60	±0.10
	C	0.85	±0.10
	F	1.25	±0.10
	Q	1.25	±0.15
1206(3216)	C	0.85	±0.15
	P	1.15	±0.10
	H	1.60	±0.20
1210(3225)	I	2.00	±0.20
	J	2.50	±0.20

Part Numbering System

Standard & High Capacitors

Super Small Size Capacitors

High-Q Capacitors

Medium-High Voltage Capacitors

Array Type Capacitors

Low ESL Capacitors

Reliability Test Condition

Premium Capacitors for Automotive Applications

Packaging Specification

Application Manual for Surface Mounting

# Premium Capacitors for Automotive Applications

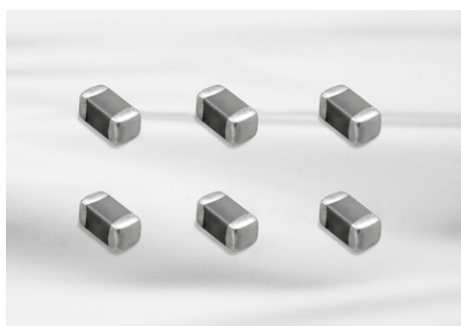

## Feature

- Automotive products are manufactured in state of the art facilities recommended for registration to ISO/TS 16949:2002.
- Automotive products meet AEC-Q-200 requirements.
- Automotive products are RoHS compliant.
- Samsung terminations are suitable for all flow and reflow soldering systems. (10/21/31 size type only)
- Automotive products meet JEDEC-020-D requirements.
- COG dielectric components contain BME and copper terminations with a Ni/Sn plated overcoat.
- X7R dielectric components have BME and soft terminations with a Ni/Sn plated overcoat.

## Application

- Automotive Electronic Equipment  
(Powertrain, Safety, Body & Chassis, Convenience, Infotainment)

## Structure and Dimensions



Code	EIA Code	Dimension(mm)			
		L	W	T	BW
05	0402	1.00±0.05	0.50±0.05	0.50(± 0.05)	0.25±0.10
10	0603	1.60±0.10	0.80±0.10	0.80(± 0.10)	0.30±0.20
21	0805	2.00±0.10	1.25±0.10	0.60(± 0.10)	0.5+0.2/-0.3
				0.85(± 0.10)	
				1.25(± 0.10)	
		2.00±0.15	1.25±0.15	1.25(± 0.15)	
31	1206	3.20±0.20	1.60±0.20	0.85(± 0.15)	0.50±0.30
				1.15(± 0.10)	
				1.60(± 0.20)	
32	1210	3.20±0.30	2.50±0.20	2.00(± 0.20)	0.60±0.30
				2.50(± 0.20)	

**Automotive Capacitors Table (C0G, X7R)**

TC	Size (mm)	Thickness (mm)	Vr	Capacitance (pF)			Capacitance (nF)								
				100	220	470	1	2.2	4.7	10	22	47	100		
COG	0402(1005)	0.50	50	[Bar]											
			100	[Bar]											
	0603(1608)	0.80	50	[Bar]											
			100	[Bar]			271								
	0805(2012)	0.60 0.85 1.25	50	[Bar]											
			100	[Bar]											
TC	Size (mm)	Thickness (mm)	Vr	Capacitance (nF)					Capacitance (μF)						
				10	22	47	100	220	470	1	2.2	4.7	10	22	
X7R	0402(1005)	0.50	10	[Bar]											
			16	[Bar]											
			25	[Bar]											
			50	[Bar]											
	0603(1608)	0.80	10	[Bar]											
			16	[Bar]											
			25	[Bar]											
			50	[Bar]											
			100	[Bar]											
	0805(2012)	1.25	10	[Bar]											
			16	[Bar]											
		0.60	25	[Bar]											
			0.85	[Bar]											
			1.25	[Bar]											
		0.60	50	25	[Bar]										
				0.85	[Bar]										
			100	1.25	[Bar]										
				0.60	[Bar]										
				0.85	[Bar]										
	1206(3216)	1.60	10	[Bar]											
			16	[Bar]											
		0.85	25	[Bar]											
			1.15	[Bar]											
			1.60	[Bar]											
0.85		50	1.15	[Bar]											
			1.60	[Bar]											
		1.60	[Bar]												
3225(1210)	2.70	16	[Bar]												

- Part Numbering System
- Standard & High Capacitors
- Super Small Size Capacitors
- High-Q Capacitors
- Medium-High Voltage Capacitors
- Array Type Capacitors
- Low ESL Capacitors
- Reliability Test Condition
- Premium Capacitors for Automotive Applications
- Packaging Specification
- Application Manual for Surface Mounting



**Product Lineup (Automotive Capacitors-COG)**

	Part Number	Size L x W (mm)	Capacitance	Rated Voltage (Vdc)	Capacitance Tolerance	Thickness Max.(mm)
1	CL05C4R7CB51PN □	1.00×0.50	4.7pF	50	±0.25pF	0.55
2	CL05C4R7CC51PN □		4.7pF	100	±0.25pF	0.55
3	CL05C6R8DB51PN □		6.8pF	50	±0.5pF	0.55
4	CL05C6R8DC51PN □		6.8pF	100	±0.5pF	0.55
5	CL05C100JB51PN □		10pF	50	±5%	0.55
6	CL05C100JC51PN □		10pF	100	±5%	0.55
7	CL05C120JB51PN □		12pF	50	±5%	0.55
8	CL05C120JC51PN □		12pF	100	±5%	0.55
9	CL05C150JB51PN □		15pF	50	±5%	0.55
10	CL05C150JC51PN □		15pF	100	±5%	0.55
11	CL05C180JB51PN □		18pF	50	±5%	0.55
12	CL05C180JC51PN □		18pF	100	±5%	0.55
13	CL05C220JB51PN □		22pF	50	±5%	0.55
14	CL05C220JC51PN □		22pF	100	±5%	0.55
15	CL05C270JB51PN □		27pF	50	±5%	0.55
16	CL05C270JC51PN □		27pF	100	±5%	0.55
17	CL05C330JB51PN □		33pF	50	±5%	0.55
18	CL05C330JC51PN □		33pF	100	±5%	0.55
19	CL05C390JB51PN □		39pF	50	±5%	0.55
20	CL05C390JC51PN □		39pF	100	±5%	0.55
21	CL05C470JB51PN □		47pF	50	±5%	0.55
22	CL05C470JC51PN □		47pF	100	±5%	0.55
23	CL05C560JB51PN □		56pF	50	±5%	0.55
24	CL05C560JC51PN □		56pF	100	±5%	0.55
25	CL05C680JB51PN □		68pF	50	±5%	0.55
26	CL05C680JC51PN □		68pF	100	±5%	0.55
27	CL05C820JB51PN □		82pF	50	±5%	0.55
28	CL05C820JC51PN □		82pF	100	±5%	0.55
29	CL05C101JB51PN □		100pF	50	±5%	0.55
30	CL05C101JC51PN □		100pF	100	±5%	0.55
31	CL05C121JB51PN □		120pF	50	±5%	0.55
32	CL05C151JB51PN □		150pF	50	±5%	0.55
33	CL05C221JB51PN □		220pF	50	±5%	0.55
1	CL10C4R7CB81PN □	1.60×0.80	4.7pF	50	±0.25pF	0.90
2	CL10C4R7CC81PN □		4.7pF	100	±0.25pF	0.90
3	CL10C6R8DB81PN □		6.8pF	50	±0.5pF	0.90
4	CL10C6R8DC81PN □		6.8pF	100	±0.5pF	0.90
5	CL10C100JB81PN □		10pF	50	±5%	0.90
6	CL10C100JC81PN □		10pF	100	±5%	0.90
7	CL10C120JB81PN □		12pF	50	±5%	0.90
8	CL10C120JC81PN □		12pF	100	±5%	0.90
9	CL10C150JB81PN □		15pF	50	±5%	0.90
10	CL10C150JC81PN □		15pF	100	±5%	0.90
11	CL10C180JB81PN □		18pF	50	±5%	0.90
12	CL10C180JC81PN □		18pF	100	±5%	0.90
13	CL10C220JB81PN □		22pF	50	±5%	0.90
14	CL10C220JC81PN □		22pF	100	±5%	0.90
15	CL10C270JB81PN □		27pF	50	±5%	0.90
16	CL10C270JC81PN □		27pF	100	±5%	0.90
17	CL10C330JB81PN □		33pF	50	±5%	0.90

※ □ mark means packaging code. If you want to learn the code or quantity in detail, please see p74.

**Product Lineup (Automotive Capacitors-COG)**

	Part Number	Size L x W (mm)	Capacitance	Rated Voltage (Vdc)	Capacitance Tolerance	Thickness Max.(mm)
18	CL10C330JC81PN □	1.60×0.80	33pF	100	±5%	0.90
19	CL10C390JB81PN □		39pF	50	±5%	0.90
20	CL10C390JC81PN □		39pF	100	±5%	0.90
21	CL10C470JB81PN □		47pF	50	±5%	0.90
22	CL10C470JC81PN □		47pF	100	±5%	0.90
23	CL10C560JB81PN □		56pF	50	±5%	0.90
24	CL10C560JC81PN □		56pF	100	±5%	0.90
25	CL10C680JB81PN □		68pF	50	±5%	0.90
26	CL10C680JC81PN □		68pF	100	±5%	0.90
27	CL10C820JB81PN □		82pF	50	±5%	0.90
28	CL10C820JC81PN □		82pF	100	±5%	0.90
29	CL10C101JB81PN □		100pF	50	±5%	0.90
30	CL10C101JC81PN □		100pF	100	±5%	0.90
31	CL10C121JB81PN □		120pF	50	±5%	0.90
32	CL10C151JB81PN □		150pF	50	±5%	0.90
33	CL10C221JB81PN □		220pF	50	±5%	0.90
34	CL10C221JC81PN □		220pF	100	±5%	0.90
35	CL10C271JB81PN □		270pF	50	±5%	0.90
36	CL10C331JB81PN □		330pF	50	±5%	0.90
37	CL10C391JB81PN □		390pF	50	±5%	0.90
38	CL10C471JB81PN □		470pF	50	±5%	0.90
39	CL10C561JB81PN □		560pF	50	±5%	0.90
40	CL10C681JB81PN □		680pF	50	±5%	0.90
41	CL10C821JB81PN □		820pF	50	±5%	0.90
42	CL10C102JB81PN □	1.0nF	50	±5%	0.90	
1	CL21C100JB61PN □	2.00×1.25	10pF	50	±5%	0.70
2	CL21C100JC61PN □		10pF	100	±5%	0.70
3	CL21C120JB61PN □		12pF	50	±5%	0.70
4	CL21C120JC61PN □		12pF	100	±5%	0.70
5	CL21C150JB61PN □		15pF	50	±5%	0.70
6	CL21C150JC61PN □		15pF	100	±5%	0.70
7	CL21C180JB61PN □		18pF	50	±5%	0.70
8	CL21C180JC61PN □		18pF	100	±5%	0.70
9	CL21C220JB61PN □		22pF	50	±5%	0.70
10	CL21C220JC61PN □		22pF	100	±5%	0.70
11	CL21C270JC61PN □		27pF	100	±5%	0.70
12	CL21C330JB61PN □		33pF	50	±5%	0.70
13	CL21C330JC61PN □		33pF	100	±5%	0.70
14	CL21C390JB61PN □		39pF	50	±5%	0.70
15	CL21C390JC61PN □		39pF	100	±5%	0.70
16	CL21C470JB61PN □		47pF	50	±5%	0.70
17	CL21C470JC61PN □		47pF	100	±5%	0.70
18	CL21C560JB61PN □		56pF	50	±5%	0.70
19	CL21C560JC61PN □		56pF	100	±5%	0.70
20	CL21C680JB61PN □		68pF	50	±5%	0.70
21	CL21C680JC61PN □		68pF	100	±5%	0.70
22	CL21C820JB61PN □		82pF	50	±5%	0.70
23	CL21C820JC61PN □		82pF	100	±5%	0.70
24	CL21C101JB61PN □		100pF	50	±5%	0.70
25	CL21C101JC61PN □		100pF	100	±5%	0.70

※ □ mark means packaging code. If you want to learn the code or quantity in detail, please see p74.

- Part Numbering System
- Standard & High Capacitors
- Super Small Size Capacitors
- High-Q Capacitors
- Medium-High Voltage Capacitors
- Array Type Capacitors
- Low ESL Capacitors
- Reliability Test Condition
- Premium Capacitors for Automotive Applications
- Packaging Specification
- Application Manual for Surface Mounting





**Product Lineup (Automotive Capacitors-COG)**

	Part Number	Size L x W (mm)	Capacitance	Rated Voltage (Vdc)	Capacitance Tolerance	Thickness Max.(mm)
26	CL21C121JB61PN □	2.00×1.25	120pF	50	±5%	0.70
27	CL21C121JC61PN □		120pF	100	±5%	0.70
28	CL21C151JB61PN □		150pF	50	±5%	0.70
29	CL21C151JC61PN □		150pF	100	±5%	0.70
30	CL21C221JB61PN □		220pF	50	±5%	0.70
31	CL21C221JC61PN □		220pF	100	±5%	0.70
32	CL21C271JB61PN □		270pF	50	±5%	0.70
33	CL21C271JC61PN □		270pF	100	±5%	0.70
34	CL21C331JB61PN □		330pF	50	±5%	0.70
35	CL21C331JC61PN □		330pF	100	±5%	0.70
36	CL21C471JBC1PN □		470pF	50	±5%	0.95
37	CL21C471JCC1PN □		470pF	100	±5%	0.95
38	CL21C561JBC1PN □		560pF	50	±5%	0.95
39	CL21C561JCC1PN □		560pF	100	±5%	0.95
40	CL21C681JBC1PN □		680pF	50	±5%	0.95
41	CL21C681JCC1PN □		680pF	100	±5%	0.95
42	CL21C821JBC1PN □		820pF	50	±5%	0.95
43	CL21C821JCC1PN □		820pF	100	±5%	0.95
44	CL21C102JBF1PN □		1.0nF	50	±5%	1.35
45	CL21C102JBC1PN □		1.0nF	50	±5%	0.95
46	CL21C102JCF1PN □		1.0nF	100	±5%	1.35
47	CL21C102JCC1PN □		1.0nF	100	±5%	0.95
48	CL21C122JBF1PN □		1.2nF	50	±5%	1.35
49	CL21C122JBC1PN □		1.2nF	50	±5%	0.95
50	CL21C152JBF1PN □		1.5nF	50	±5%	1.35
51	CL21C152JBC1PN □		1.5nF	50	±5%	0.95
52	CL21C182JBF1PN □		1.8nF	50	±5%	1.35
53	CL21C182JBC1PN □		1.8nF	50	±5%	0.95
54	CL21C222JBF1PN □		2.2nF	50	±5%	1.35
55	CL21C222JBC1PN □		2.2nF	50	±5%	0.95
56	CL21C272JBF1PN □		2.7nF	50	±5%	1.35
57	CL21C272JBC1PN □		2.7nF	50	±5%	0.95
58	CL21C332JBF1PN □		3.3nF	50	±5%	1.35
59	CL21C332JBC1PN □		3.3nF	50	±5%	0.95
60	CL21C392JBF1PN □		3.9nF	50	±5%	1.35
61	CL21C392JBC1PN □		3.9nF	50	±5%	0.95
62	CL21C472JBF1PN □		4.7nF	50	±5%	1.35
63	CL21C472JBC1PN □		4.7nF	50	±5%	0.95
64	CL21C562JBF1PN □		5.6nF	50	±5%	1.35
65	CL21C562JBC1PN □		5.6nF	50	±5%	0.95
66	CL21C682JBF1PN □		6.8nF	50	±5%	1.35
67	CL21C822JBF1PN □		8.2nF	50	±5%	1.35
68	CL21C103JBF1PN □		10nF	50	±5%	1.35

※ □ mark means packaging code. If you want to learn the code or quantity in detail, please see p74.



**Product Lineup (Automotive Capacitors-X7R)**

	Part Number	Size L x W (mm)	Capacitance	Rated Voltage (Vdc)	Capacitance Tolerance	Thickness Max.(mm)
1	CL05B331KB5VPN □	1.00×0.50	330 pF	50	±10%	0.55
2	CL05B471KB5VPN □		470 pF	50	±10%	0.55
3	CL05B681KB5VPN □		680 pF	50	±10%	0.55
4	CL05B102KA5VPN □		1.0 nF	25	±10%	0.55
5	CL05B102KB5VPN □		1.0 nF	50	±10%	0.55
6	CL05B152KA5VPN □		1.5 nF	25	±10%	0.55
7	CL05B152KB5VPN □		1.5 nF	50	±10%	0.55
8	CL05B222KA5VPN □		2.2 nF	25	±10%	0.55
9	CL05B222KB5VPN □		2.2 nF	50	±10%	0.55
10	CL05B332KA5VPN □		3.3 nF	25	±10%	0.55
11	CL05B332KB5VPN □		3.3 nF	50	±10%	0.55
12	CL05B472KA5VPN □		4.7 nF	25	±10%	0.55
13	CL05B472KB5VPN □		4.7 nF	50	±10%	0.55
14	CL05B682KA5VPN □		6.8 nF	25	±10%	0.55
15	CL05B682KB5VPN □		6.8 nF	50	±10%	0.55
16	CL05B103KA5VPN □		10 nF	25	±10%	0.55
17	CL05B103KB5VPN □		10 nF	50	±10%	0.55
18	CL05B153KA5VPN □		15 nF	25	±10%	0.55
19	CL05B153KB5VPN □		15 nF	50	±10%	0.55
20	CL05B223KA5VPN □		22 nF	25	±10%	0.55
21	CL05B223KB5VPN □		22 nF	50	±10%	0.55
22	CL05B333KO5VPN □		33 nF	16	±10%	0.55
23	CL05B473KO5VPN □		47 nF	16	±10%	0.55
24	CL05B683KO5VPN □		68 nF	16	±10%	0.55
25	CL05B104KO5VPN □		100 nF	16	±10%	0.55

※ □ mark means packaging code. If you want to learn the code or quantity in detail, please see p74.

Part Numbering System

Standard & High Capacitors

Super Small Size Capacitors

High-Q Capacitors

Medium-High Voltage Capacitors

Array Type Capacitors

Low ESL Capacitors

Reliability Test Condition

Premium Capacitors for Automotive Applications

Packaging Specification

Application Manual for Surface Mounting



**Product Lineup (Automotive Capacitors-X7R)**

	Part Number	Size L x W (mm)	Capacitance	Rated Voltage (Vdc)	Capacitance Tolerance	Thickness Max.(mm)
1	CL10B221KC8WPN □	1.60×0.80	220pF	100	±10%	0.90
2	CL10B331KC8WPN □		330pF	100	±10%	0.90
3	CL10B471KC8WPN □		470pF	100	±10%	0.90
4	CL10B681KC8WPN □		680pF	100	±10%	0.90
5	CL10B102KB8WPN □		1.0nF	50	±10%	0.90
6	CL10B102KC8WPN □		1.0nF	100	±10%	0.90
7	CL10B152KB8WPN □		1.5nF	50	±10%	0.90
8	CL10B152KC8WPN □		1.5nF	100	±10%	0.90
9	CL10B222KB8WPN □		2.2nF	50	±10%	0.90
10	CL10B222KC8WPN □		2.2nF	100	±10%	0.90
11	CL10B332KB8WPN □		3.3nF	50	±10%	0.90
12	CL10B332KC8WPN □		3.3nF	100	±10%	0.90
13	CL10B472KB8WPN □		4.7nF	50	±10%	0.90
14	CL10B472KC8WPN □		4.7nF	100	±10%	0.90
15	CL10B682KB8WPN □		6.8nF	50	±10%	0.90
16	CL10B682KC8WPN □		6.8nF	100	±10%	0.90
17	CL10B103KB8WPN □		10nF	50	±10%	0.90
18	CL10B103KC8WPN □		10nF	100	±10%	0.90
19	CL10B153KB8WPN □		15nF	50	±10%	0.90
20	CL10B223KB8WPN □		22nF	50	±10%	0.90
21	CL10B333KA8WPN □		33nF	25	±10%	0.90
22	CL10B333KB8WPN □		33nF	50	±10%	0.90
23	CL10B473KA8WPN □		47nF	25	±10%	0.90
24	CL10B473KB8WPN □		47nF	50	±10%	0.90
25	CL10B683KA8WPN □		68nF	25	±10%	0.90
26	CL10B683KB8WPN □		68nF	50	±10%	0.90
27	CL10B104KA8WPN □		100nF	25	±10%	0.90
28	CL10B104KB8WPN □		100nF	50	±10%	0.90
29	CL10B154KO8VPN □		150nF	16	±10%	0.90
30	CL10B154KA8VPN □		150nF	25	±10%	0.90
31	CL10B224KO8VPN □		220nF	16	±10%	0.90
32	CL10B224KA8VPN □		220nF	25	±10%	0.90
33	CL10B334KO8VPN □		330nF	16	±10%	0.90
34	CL10B334KA8VPN □		330nF	25	±10%	0.90
35	CL10B474KO8VPN □		470nF	16	±10%	0.90
36	CL10B474KA8VPN □		470nF	25	±10%	0.90
37	CL10B684KO8VPN □		680nF	16	±10%	0.90
38	CL10B105KO8VPN □		1.0μF	16	±10%	0.90

※ □ mark means packaging code. If you want to learn the code or quantity in detail, please see p74.

**Product Lineup (Automotive Capacitors-X7R)**

	Part Number	Size L x W (mm)	Capacitance	Rated Voltage (Vdc)	Capacitance Tolerance	Thickness Max.(mm)
1	CL21B102KC6WPN □	2.00×1.25	1.0 nF	100	±10%	0.70
2	CL21B152KC6WPN □		1.5 nF	100	±10%	0.70
3	CL21B222KC6WPN □		2.2 nF	100	±10%	0.70
4	CL21B332KC6WPN □		3.3 nF	100	±10%	0.70
5	CL21B472KC6WPN □		4.7 nF	100	±10%	0.70
6	CL21B682KC6WPN □		6.8 nF	100	±10%	0.70
7	CL21B103KC6WPN □		10 nF	100	±10%	0.70
8	CL21B153KC6WPN □		15 nF	100	±10%	0.70
9	CL21B223KC6WPN □		22 nF	100	±10%	0.70
10	CL21B333KCCWPN □		33 nF	100	±10%	0.95
11	CL21B473KCCWPN □		47 nF	100	±10%	0.95
12	CL21B683KCCWPN □		68 nF	100	±10%	0.95
13	CL21B104KBFWPN □		100 nF	50	±10%	1.35
14	CL21B104KBCWPN □		100 nF	50	±10%	0.95
15	CL21B104KCFWPN □		100 nF	100	±10%	1.35
16	CL21B104KCCWPN □		100 nF	100	±10%	0.95
17	CL21B154KAFVFN □		150 nF	25	±10%	1.35
18	CL21B154KBFVFN □		150 nF	50	±10%	1.35
19	CL21B224KAFVFN □		220 nF	25	±10%	1.35
20	CL21B224KBFVFN □		220 nF	50	±10%	1.35
21	CL21B334KAFVFN □		330 nF	25	±10%	1.35
22	CL21B334KBFVFN □		330 nF	50	±10%	1.35
23	CL21B474KOFVFN □		470 nF	16	±10%	1.35
24	CL21B474KAFVFN □		470 nF	25	±10%	1.35
25	CL21B474KBFVFN □		470 nF	50	±10%	1.35
26	CL21B684KOFVFN □		680 nF	16	±10%	1.35
27	CL21B684KAFVFN □		680 nF	25	±10%	1.35
28	CL21B105KOFVFN □		1.0 μF	16	±10%	1.35
29	CL21B105KAFVFN □		1.0 μF	25	±10%	1.35
30	CL21B225KPFVFN □		2.2 μF	10	±10%	1.35
31	CL21B225KOFVFN □		2.2 μF	16	±10%	1.35
32	CL21B335KPQVFN □		3.3 μF	10	±10%	1.40
33	CL21B475KPQVFN □		4.7 μF	10	±10%	1.40
1	CL31B104KBPWPN □	3.20×1.60	100 nF	50	±10%	1.25
2	CL31B104KBCVFN □		100 nF	50	±10%	1.00
3	CL31B154KBPWPN □		150 nF	50	±10%	1.25
4	CL31B224KBPWPN □		220 nF	50	±10%	1.25
5	CL31B334KBHWPN □		330 nF	50	±10%	1.80
6	CL31B474KBHWPN □		470 nF	50	±10%	1.80
7	CL31B684KBHWPN □		680 nF	50	±10%	1.80
8	CL31B105KAPWPN □		1.0 μF	25	±10%	1.25
9	CL31B105KBHWPN □		1.0 μF	50	±10%	1.80
10	CL31B155KAHVFN □		1.5 μF	25	±10%	1.80
11	CL31B155KBHVFN □		1.5 μF	50	±10%	1.80
12	CL31B225KOHVFN □		2.2 μF	16	±10%	1.80
13	CL31B225KAHVFN □		2.2 μF	25	±10%	1.80
14	CL31B225KBHVFN □		2.2 μF	50	±10%	1.80
15	CL31B335KOHVFN □		3.3 μF	16	±10%	1.80
16	CL31B335KAHVFN □		3.3 μF	25	±10%	1.80
17	CL31B475KOHVFN □		4.7 μF	16	±10%	1.80
18	CL31B475KAHVFN □		4.7 μF	25	±10%	1.80
19	CL31B685KOHVFN □		6.8 μF	16	±10%	1.80
20	CL31B106KOHVFN □		10.0 μF	16	±10%	1.80
1	CL32B226KOJVFN □	3.20×2.50	22 μF	16	±10%	2.70

- Part Numbering System
- Standard & High Capacitors
- Super Small Size Capacitors
- High-Q Capacitors
- Medium-High Voltage Capacitors
- Array Type Capacitors
- Low ESL Capacitors
- Reliability Test Condition
- Premium Capacitors for Automotive Applications
- Packaging Specification
- Application Manual for Surface Mounting

※ □ mark means packaging code. If you want to learn the code or quantity in detail, please see p74.



**Reliability Test Condition (Automotive Capacitors)**

No	Item	Performance	Test Condition															
1	Pre-and Post-Stress Electrical Test	—																
2	High Temperature Exposure	Appearance	No abnormal exterior appearance															
		Capacitance Change	CLASS I	Within $\pm 2.5\%$ or $0.25\mu\text{F}$ , (Whichever is larger)														
			CLASS II	Within $\pm 10\%$														
		Q	CLASS I	Capacitance $\geq 30\mu\text{F}$ : $Q \geq 1,000$ $< 30\mu\text{F}$ : $Q \geq 400 + 20 \times C$ (C : Capacitance)														
		Tan $\delta$	CLASS II	Rated Voltage $\geq 25\text{V}$ : $0.03$ max $\geq 16\text{V}$ : $0.05$ max $\geq 10\text{V}$ : $0.075$ max *1)														
IR		More than $10,000\text{M}\Omega$ or $500\text{M}\Omega \times \mu\text{F}$ (Whichever is smaller) *1)																
3	Temperature Cycling	Appearance	No abnormal exterior appearance															
		Capacitance Change	CLASS I	Within $\pm 2.5\%$ or $0.25\mu\text{F}$ , (Whichever is larger)														
			CLASS II	Within $\pm 10\%$														
		Q	CLASS I	Capacitance $\geq 30\mu\text{F}$ : $Q \geq 1,000$ $< 30\mu\text{F}$ : $Q \geq 400 + 20 \times C$ (C : Capacitance)														
		Tan $\delta$	CLASS II	Rated Voltage $\geq 25\text{V}$ : $0.03$ max $\geq 16\text{V}$ : $0.05$ max $\geq 10\text{V}$ : $0.075$ max *1)														
IR		More than $10,000\text{M}\Omega$ or $500\text{M}\Omega \times \mu\text{F}$ (Whichever is smaller) *1)																
			1000Cycles															
			Initial Measurement															
			Final Measurement															
			Measurement at $24 \pm 2$ hrs after test conclusion															
			<table border="1"> <thead> <tr> <th>Step</th> <th>Temperature(°C)</th> <th>Time(min.)</th> </tr> </thead> <tbody> <tr> <td>1</td> <td>Min. operating Temp. <math>\pm 2</math></td> <td><math>15 \pm 3</math></td> </tr> <tr> <td>2</td> <td><math>25 \pm 2</math></td> <td>1</td> </tr> <tr> <td>3</td> <td>Max. operating Temp. <math>\pm 2</math></td> <td><math>15 \pm 3</math></td> </tr> <tr> <td>4</td> <td><math>25 \pm 2</math></td> <td>1</td> </tr> </tbody> </table>	Step	Temperature(°C)	Time(min.)	1	Min. operating Temp. $\pm 2$	$15 \pm 3$	2	$25 \pm 2$	1	3	Max. operating Temp. $\pm 2$	$15 \pm 3$	4	$25 \pm 2$	1
Step	Temperature(°C)	Time(min.)																
1	Min. operating Temp. $\pm 2$	$15 \pm 3$																
2	$25 \pm 2$	1																
3	Max. operating Temp. $\pm 2$	$15 \pm 3$																
4	$25 \pm 2$	1																
4	Destructive Physical Analysis	No defects or abnormalities	Per EIA 469															
5	Moisture Resistance	Appearance	No abnormal exterior appearance															
		Capacitance Change	CLASS I	Within $\pm 2.5\%$ or $0.25\mu\text{F}$ , (Whichever is larger)														
			CLASS II	Within $\pm 12.5\%$														
		Q	CLASS I	Capacitance $\geq 30\mu\text{F}$ : $Q \geq 350$ $10 \leq \text{Capacitance} < 30\mu\text{F}$ : $Q \geq 275 + (5/2) \times C$ Capacitance $< 10\mu\text{F}$ : $Q \geq 200 + 10 \times C$ (C : Capacitance)														
		Tan $\delta$	CLASS II	Rated Voltage $\geq 25\text{V}$ : $0.03$ max $\geq 16\text{V}$ : $0.05$ max $\geq 10\text{V}$ : $0.075$ max *1)														
IR		More than $10,000\text{M}\Omega$ or $500\text{M}\Omega \times \mu\text{F}$ (Whichever is smaller) *1)																
			<p>10Cycles, <math>t=24</math>hrs/cycle Heat (<math>25\text{--}65^\circ\text{C}</math>) and humidity (80~98%), Unpowered measurement at <math>24 \pm 2</math>hrs after test conclusion</p> <p>The graph shows a temperature profile over 24 hours. The temperature starts at 25°C, rises to 75°C at 5 hours, stays at 75°C until 8 hours, then drops to 25°C at 11 hours. It then rises to 75°C again at 14 hours, stays at 75°C until 17 hours, and finally drops to 25°C at 19 hours, remaining at 25°C until 24 hours. Humidity is indicated as 90-100% RH during the high-temperature periods and 80-100% RH during the low-temperature periods.</p>															

※ \*1) : Indicates typical specification. Please refer to individual specifications.

No	Item	Performance	Test Condition	
6	Biased Humidity	Appearance	No abnormal exterior appearance	
		Capacitance Change	CLASS I	Within $\pm 2.5\%$ or 0.25pF, (Whichever is larger)
			CLASS II	Within $\pm 12.5\%$
		Q	CLASS I	Capacitance $\geq 30\text{pF}$ : $Q \geq 200$ $< 30\text{pF}$ : $Q \geq 100 + (10/3) \times C$ (C : Capacitance)
		Tan $\delta$	CLASS II	Rated Voltage $\geq 25\text{V}$ : 0.035 max $\geq 16\text{V}$ : 0.05 max $\geq 10\text{V}$ : 0.075max *1)
IR		More than 500M $\Omega$ or 25M $\Omega \times \mu\text{F}$ (Whichever is Smaller) *1)		
7	High Temperature Operating Life	Appearance	No abnormal exterior appearance	
		Capacitance Change	CLASS I	Within $\pm 3.0\%$ or 0.3pF, (Whichever is larger)
			CLASS II	Within $\pm 12.5\%$
		Q	CLASS I	Capacitance $\geq 30\text{pF}$ : $Q \geq 350$ $\geq 10\text{pF}$ : $Q \geq 275 + (5/2) \times C$ $< 10\text{pF}$ : $Q \geq 200 + 10 \times C$ (C : Capacitance)
		Tan $\delta$	CLASS II	Rated Voltage $\geq 25\text{V}$ : 0.035 max $\geq 16\text{V}$ : 0.05 max $\geq 10\text{V}$ : 0.075max *1)
IR		More than 1,000M $\Omega$ or 50M $\Omega \times \mu\text{F}$ (Whichever is smaller) *1)		
8	External Visual	No abnormal exterior appearance	Microscope (x10)	
9	Physical Dimensions	Within the specified dimensions	Using the calipers	
10	Mechanical Shock	Appearance	No abnormal exterior appearance	
		Capacitance Change	CLASS I	Within $\pm 2.5\%$ or 0.25pF, (Whichever is larger)
			CLASS II	Within $\pm 10\%$
		Q	CLASS I	Capacitance $\geq 30\text{pF}$ : $Q \geq 1,000$ $< 30\text{pF}$ : $Q \geq 400 + 20 \times C$ (C : Capacitance)
		Tan $\delta$	CLASS II	Rated Voltage $\geq 25\text{V}$ : 0.025 max $\geq 16\text{V}$ : 0.035 max $\geq 10\text{V}$ : 0.05 max *1)
IR		More than 10,000M $\Omega$ or 500M $\Omega \times \mu\text{F}$ (Whichever is smaller) *1)		

※ \*1) : Indicates typical specification. Please refer to individual specifications.

\*2) : Some of the parts are applicable in rated voltage 150%, Please refer to individual specifications.

- Part Numbering System
- Standard & High Capacitors
- Super Small Size Capacitors
- High-Q Capacitors
- Medium-High Voltage Capacitors
- Array Type Capacitors
- Low ESL Capacitors
- Reliability Test Condition
- Premium Capacitors for Automotive Applications
- Packaging Specification
- Application Manual for Surface Mounting



No	Item	Performance	Test Condition	
11	Vibration	Appearance	No abnormal exterior appearance	
		Capacitance Change	CLASS I	Within $\pm 2.5\%$ or 0.25pF, (Whichever is larger)
			CLASS II	Within $\pm 10\%$
		Q	CLASS I	Capacitance $\geq 30\text{pF}$ : $Q \geq 1,000$ < 30pF : $Q \geq 400+20 \times C$ (C : Capacitance)
		Tan $\delta$	CLASS II	Rated Voltage $\geq 25\text{V}$ : 0.025 max $\geq 16\text{V}$ : 0.035 max $\geq 10\text{V}$ : 0.05max *1)
IR		More than 10,000M $\Omega$ or 500M $\Omega \times \mu\text{F}$ (Whichever is smaller) *1)		
12	Resistance to Solder Heat	Appearance	No abnormal exterior appearance	
		Capacitance Change	CLASS I	Within $\pm 2.5\%$ or 0.25pF, (Whichever is larger)
			CLASS II	Within $\pm 10\%$
		Q	CLASS I	Capacitance $\geq 30\text{pF}$ : $Q \geq 1,000$ < 30pF : $Q \geq 400+20 \times C$ (C : Capacitance)
		Tan $\delta$	CLASS II	Rated Voltage $\geq 25\text{V}$ : 0.025 max $\geq 16\text{V}$ : 0.035 max $\geq 10\text{V}$ : 0.05max *1)
IR		More than 10,000M $\Omega$ or 500M $\Omega \times \mu\text{F}$ (Whichever is smaller) *1)		
13	Thermal Shock	Appearance	No abnormal exterior appearance	
		Capacitance Change	CLASS I	Within $\pm 2.5\%$ or 0.25pF, (Whichever is larger)
			CLASS II	Within $\pm 10\%$
		Q	CLASS I	Capacitance $\geq 30\text{pF}$ : $Q \geq 1,000$ < 30pF : $Q \geq 400+20 \times C$ (C : Capacitance)
		Tan $\delta$	CLASS II	Rated Voltage $\geq 25\text{V}$ : 0.025 max $\geq 16\text{V}$ : 0.035 max $\geq 10\text{V}$ : 0.05max *1)
IR		More than 10,000M $\Omega$ or 500M $\Omega \times \mu\text{F}$ (Whichever is smaller) *1)		
14	ESD	Appearance	No abnormal exterior appearance	
		Capacitance Change	CLASS I	Within $\pm 2.5\%$ or 0.25pF, (Whichever is larger)
			CLASS II	Within $\pm 10\%$
		Q	CLASS I	Capacitance $\geq 30\text{pF}$ : $Q \geq 1,000$ < 30pF : $Q \geq 400+20 \times C$ (C : Capacitance)
		Tan $\delta$	CLASS II	Rated Voltage $\geq 25\text{V}$ : 0.025 max $\geq 16\text{V}$ : 0.035 max $\geq 10\text{V}$ : 0.05max *1)
IR		More than 10,000M $\Omega$ or 500M $\Omega \times \mu\text{F}$ (Whichever is smaller) *1)		

※ \*1) : Indicates typical specification. Please refer to individual specifications.

No	Item		Performance	Test Condition																		
15	Solderability		95% of the terminations is to be soldered evenly and continuously	a) Preheat at 155°C for 4 hrs, Immerse in solder for 5s at 235±5°C b) Steam aging for 8 hrs, Immerse in solder for 5s at 235±5°C c) Steam aging for 8 hrs, Immerse in solder for 120s at 260±5°C solder : a solution ethanol and rosin																		
16	Electrical Characterization	Capacitance	Within specified tolerance	The Capacitance /D.F. should be measured at 25°C, *A capacitor prior to measuring the capacitance is heat treated at 150+0/-10°C and maintained in ambient air for 24±2hrs.																		
		Q	CLASS I Capacitance ≥ 30pF : Q ≥ 1,000 < 30pF : Q ≥ 400+20×C (C : Capacitance)																			
		Tanδ	CLASS II Rated Voltage ≥ 25V : 0.025 max ≥ 16V : 0.035 max ≥ 10V : 0.05max *1)	<table border="1"> <thead> <tr> <th>Class</th> <th>Capacitance</th> <th>Frequency</th> <th>Vrms</th> </tr> </thead> <tbody> <tr> <td rowspan="2">Class I</td> <td>1000pF ↓</td> <td>1kHz ±10%</td> <td>0.5~5Vrms</td> </tr> <tr> <td>1000pF ↑</td> <td>1kHz ±10%</td> <td>1.0±0.2Vrms</td> </tr> <tr> <td rowspan="2">Class II</td> <td>10μF ↓</td> <td>1kHz ±10%</td> <td>1.0±0.2Vrms</td> </tr> <tr> <td>10μF ↑</td> <td>120Hz ±20%</td> <td>0.5±0.1Vrms</td> </tr> </tbody> </table>	Class	Capacitance	Frequency	Vrms	Class I	1000pF ↓	1kHz ±10%	0.5~5Vrms	1000pF ↑	1kHz ±10%	1.0±0.2Vrms	Class II	10μF ↓	1kHz ±10%	1.0±0.2Vrms	10μF ↑	120Hz ±20%	0.5±0.1Vrms
		Class	Capacitance	Frequency	Vrms																	
		Class I	1000pF ↓	1kHz ±10%	0.5~5Vrms																	
			1000pF ↑	1kHz ±10%	1.0±0.2Vrms																	
Class II	10μF ↓	1kHz ±10%	1.0±0.2Vrms																			
	10μF ↑	120Hz ±20%	0.5±0.1Vrms																			
IR@25°C	CLASS I More than 100,000MΩ or 1,000 MΩ × μF (Whichever is smaller)	Initial measurement Perform a heat treatment at 150+0/-10°C for one hour after soldering process. And then let sit for 24±2hrs at room temperature. Perform the initial measurement.																				
CLASS II More than 10,000MΩ or 500 MΩ × μF (Whichever is smaller)																						
IR@125°C	CLASS I More than 10,000MΩ or 100 MΩ × μF (Whichever is smaller)	I.R. should be measured with a DC voltage not exceeding Rated Voltage @25°C , @125°C for 60~120 sec.																				
CLASS II More than 1,000MΩ or 10 MΩ × μF (Whichever is smaller)	Dielectric Strength : 250% of the rated voltage for 1~5 seconds The charge/discharge current is less than 50mA.																					
Dielectric Strength	No dielectric breakdown or mechanical breakdown																					
17	Board Flex	Appearance	No abnormal exterior appearance	Bending to the limit for 60 seconds Limit : Class I -3mm Class II - 3mm																		
		Capacitance Change	CLASS I Within ± 5.0% or 0.5pF, (Whichever is larger)	The figure indicates typical specification. Please refer to individual specifications Initial Measurement Perform a heat treatment at 150+0/-10°C for 1hr after soldering process. And then let sit for 24±2hrs at room temperature. Perform the initial measurement. Final measurement Let measure within 24hrs at room temperature after test conclusion.																		
			CLASS II Within ± 10%																			
18	Terminal Strength(SMD)	Appearance	No abnormal exterior appearance	18N, for 60±1 sec. * 0603(1608) -10N, 0402(1005) -2N																		
		Capacitance Change	CLASS I Within ± 2.5% or 0.25pF, (Whichever is larger)	Initial Measurement Perform a heat treatment at 150+0/-10°C for 1hr after soldering process. And then let sit for 24±2hrs at room temperature. Perform the initial measurement. Final measurement Let measure within 24hrs at room temperature after test conclusion.																		
			CLASS II Within ± 10%																			
19	Beam Load	Destruction value should be exceed Chip Length ≤ 2.5mm a) Chip Thickness > 0.5mm : 20N b) Chip Thickness ≤ 0.5mm : 8N Chip Length ≥ 3.2mm a) Chip Thickness ≥ 1.25mm : 54.5N b) Chip Thickness < 1.25mm : 15N		Beam speed Chip Length ≤ 2.5mm , 0.5±0.05mm/sec Chip Length ≥ 3.2mm , 2.5±0.25mm/sec																		
		Capacitance Change	CLASS I 0±30 ppm/°C	<table border="1"> <thead> <tr> <th>Step</th> <th>Temperature(°C)</th> </tr> </thead> <tbody> <tr> <td>1</td> <td>25 ± 2</td> </tr> <tr> <td>2</td> <td>Min. Operating Temp. ±2</td> </tr> <tr> <td>3</td> <td>25 ± 2</td> </tr> <tr> <td>4</td> <td>Max. Operating Temp. ±2</td> </tr> <tr> <td>5</td> <td>25 ± 2</td> </tr> </tbody> </table>	Step	Temperature(°C)	1	25 ± 2	2	Min. Operating Temp. ±2	3	25 ± 2	4	Max. Operating Temp. ±2	5	25 ± 2						
Step	Temperature(°C)																					
1	25 ± 2																					
2	Min. Operating Temp. ±2																					
3	25 ± 2																					
4	Max. Operating Temp. ±2																					
5	25 ± 2																					
20	Capacitance Temperature Characteristics	Temperature Coefficient	CLASS I 0±30 ppm/°C																			
		Capacitance Drift	CLASS I Within ± 0.2% or 0.05pF, (Whichever is larger)																			

※ \*1) : Indicates typical specification. Please refer to individual specifications.

\*If you want more detailed information, Please Visit Samsung Electro-mechanics website ( www.semclcr.com )

Part Numbering System

Standard & High Capacitors

Super Small Size Capacitors

High-Q Capacitors

Medium-High Voltage Capacitors

Array Type Capacitors

Low ESL Capacitors

Reliability Test Condition

Premium Capacitors for Automotive Applications

Packaging Specification

Application Manual for Surface Mounting

## Cardboard Paper Tape(4mm)



Unit: inch(mm)

Symbol Type		A	B	W	F	E	P1	P2	P0	D	t
Dimension	0504 (1410)	1.3 ±0.2	1.7 ±0.2	8.0 ±0.3	3.5 ±0.05	1.75 ±0.1	4.0 ±0.1	2.0 ±0.05	4.0 ±0.1	Ø1.5 +0.1/-0	1.1 Below
	0603 0306 (1608) (0816)	1.1 ±0.2	1.9 ±0.2								
	0805 0508 (2012) (1220)	1.6 ±0.2	2.4 ±0.2								
	1206 0612 (3216) (1632)	2.0 ±0.2	3.6 ±0.2								

## Cardboard Paper Tape(2mm)



Unit: inch(mm)

Symbol Type		A	B	W	F	E	P1	P2	P0	D	t
Dimension	01005 (0402)	0.25 ±0.02	0.45 ±0.02	8.0 ±0.3	3.5 ±0.05	1.75 ±0.1	2.0 ±0.05	2.0 ±0.05	4.0 ±0.1	Ø1.5 +0.1 /-0.03	0.25 ±0.02
	0201 (0603)	0.38 ±0.03	0.68 ±0.03								0.37 ±0.03
	0402 (1005)	0.62 ±0.05	1.12 ±0.05								0.37 ±0.05
											0.60 ±0.05
	0204 (0510)	0.62 +0.05 /-0.10	1.12 +0.05 /-0.10								0.37 ±0.03



### Embossed Plastic Tape



Unit: inch(mm)

Symbol Type	A	B	W	F	E	P1	P2	P0	D	t1	t0
	01005 (0402)	0.25 ±0.02	0.45 ±0.02	4.0 ±0.05	1.8 ±0.02	0.9 ±0.05	1.0 ±0.02	1.0 ±0.02	2.0 ±0.04	∅0.8 ±0.04	0.25 ±0.02
Dimension	0603 (1608)	1.05 ±0.15	1.9 ±0.15	8.0 ±0.3	3.5 ±0.05	4.0 ±0.1	2.0 ±0.05	4.0 ±0.1	∅1.5 +0.1/ -0.03	2.9 max	0.6 Below
	0805 (2012)	1.45 ±0.2	2.3 ±0.2								
	1206 (3216)	1.9 ±0.2	3.5 ±0.2								
	1210 (3225)	2.8 ±0.2	3.6 ±0.2	12.0 ±0.3	5.60 ±0.05	1.75 ±0.1	8.0 ±0.1	2.0 ±0.05	4.0 ±0.1	3.8 max	
	1808 (4520)	2.3 ±0.2	4.9 ±0.2								
	1812 (4532)	3.6 ±0.2	4.9 ±0.2								
	2220 (5750)	5.5 ±0.2	6.2 ±0.2	0.8 ±0.3	3.5 ±0.05	4.0 ±0.1	2.0 ±0.05	4.0 ±0.1	∅1.5 +0.1/ -0.03	2.5 max	
	0204 (5010)	0.62 +0.05 /-0.10	1.12 +0.05 /-0.10								
	0306 (0816)	1.1 ±0.2	1.9 ±0.2								
	0508 (1220)	1.45 ±0.2	2.3 ±0.2	0.8 ±0.3	3.5 ±0.05	4.0 ±0.1	2.0 ±0.05	4.0 ±0.1	∅1.5 +0.1/ -0.03	2.5 max	
	0612 (1632)	2.0 ±0.2	3.6 ±0.2								

Part Numbering System

Standard & High Capacitors

Super Small Size Capacitors

High-Q Capacitors

Medium-High Voltage Capacitors

Array Type Capacitors

Low ESL Capacitors

Reliability Test Condition

Premium Capacitors for Automotive Applications

Packaging Specification

Application Manual for Surface Mounting

### Peeling off of Cover Tape

- 10 g.f ≤ Peel off force ≤ 70 g.f

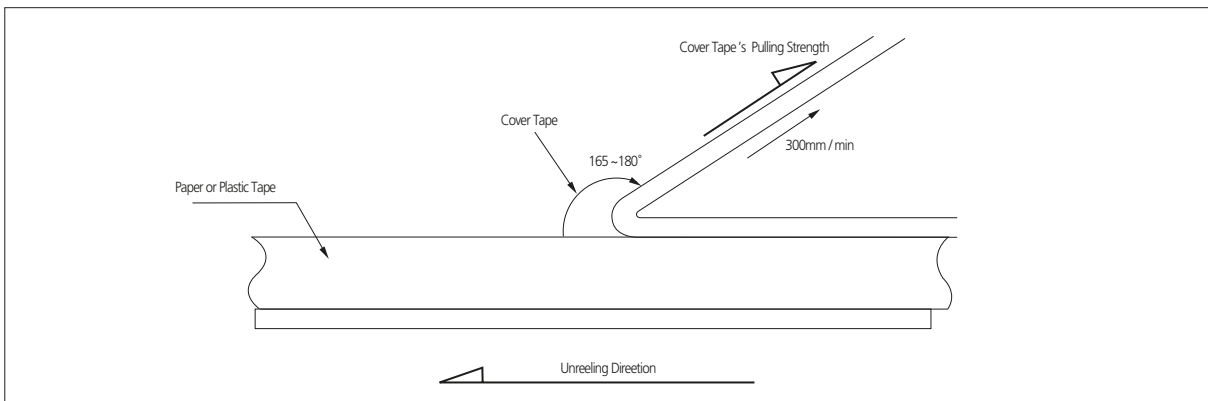



### Reel Dimensions



Unit: mm

Symbol	Tape Width	A	B	C	D
7" Reel	8mm	$\varnothing 180+0/-3$	$\varnothing 60\pm 1.0$	$\varnothing 13\pm 0.3$	$4\pm 0.2$
	12mm	$\varnothing 180+0/-3$	$\varnothing 60+1/-0$	$\varnothing 13\pm 0.3$	$4\pm 0.2$
10" Reel	8mm	$\varnothing 258+0/-3$	$\varnothing 80+1/-0$	$\varnothing 13\pm 0.3$	$4\pm 0.2$
	12mm	$\varnothing 258+0/-3$	$\varnothing 80+1/-0$	$\varnothing 13\pm 0.3$	$4\pm 0.2$
13" Reel	8mm	$\varnothing 330\pm 2.0$	$\varnothing 80\pm 1.0$	$\varnothing 13\pm 0.3$	$4\pm 0.2$
	12mm	$\varnothing 330\pm 2.0$	$\varnothing 80\pm 1.0$	$\varnothing 13\pm 0.3$	$4\pm 0.2$

Symbol	Tape Width	E	W	t
7" Reel	8mm	$2.0\pm 0.5$	$9\pm 0.5$	$1.2\pm 0.2$
	12mm	$2.0\pm 0.5$	$13\pm 0.5$	$1.2\pm 0.2$
10" Reel	8mm	$2.0\pm 0.5$	$9\pm 0.5$	$1.8\pm 0.2$
	12mm	$2.0\pm 0.5$	$13\pm 0.5$	$1.8\pm 0.2$
13" Reel	8mm	$2.0\pm 0.5$	$9\pm 0.5$	$2.2\pm 0.2$
	12mm	$2.0\pm 0.5$	$13\pm 0.5$	$2.2\pm 0.2$

Part Numbering System

Standard & High Capacitors

Super Small Size Capacitors

High-Q Capacitors

Medium-High Voltage Capacitors

Array Type Capacitors

Low ESL Capacitors

Reliability Test Condition

Premium Capacitors for Automotive Applications

Packaging Specification

Application Manual for Surface Mounting

### Bulk Case Packaging

- Bulk case packaging can reduce the stock space and transportation costs.
- The bulk feeding system can increase the productivity.
- It can eliminate the components loss.



Unit: mm

Symbol	A	B	T	C	D	E
Dimension	$6.8\pm 0.1$	$8.8\pm 0.1$	$12\pm 0.1$	$1.5+0.1/-0$	$2+0/-0.1$	$3.0+0.2/-0$

Symbol	F	W	G	H	L	I
Dimension	$31.5+0.2/-0$	$36+0/-0.2$	$19\pm 0.35$	$7\pm 0.35$	$110\pm 0.7$	$5\pm 0.35$

#### • QUANTITY

Unit: inch(mm) and pcs

Size	0402(1005)	0603(1608)	0805(2012)	
			T≤0.85mm	T≥1.0mm
Quantity	50,000	10,000 or 15,000	10,000	5,000

# Application Manual for Surface Mounting

## 1.Storage of products

### 1-1. Storage Environment

Tape packing materials are designed to withstand long-term storage, but they will degrade more rapidly in the presence of high temperature or high humidity, Therefore, the products must be stored in an ambient 5~40°C with a relative humidity of 20~70%. Allowable storage period is within 6 months from the outgoing date of delivery.

### 1-2. Corrosive Gases

Since sulfur and chlorine may degrade the solderability of the end termination, it is important to store the capacitors in an environment free of these gases

### 1-3. Temperature Fluctuations

Since dew condensation may occur by the differences in temperature when the products are taken out of storage, it is important to maintain a temperature-controlled environment.

## 2.Design of Solder Land Pattern

When designing printed circuit boards, the shape and size of the solder lands must allow for the proper amount of solder on the capacitor. The amount of solder at the end terminations has a direct effect on the probability that the chip will crack. The greater amount of solder, the larger amount of stress on the chip, and the more likely that it will break. Use the following illustrations as guidelines for proper Solder land design.

Recommendation of solder Land Shape and Size



## 3.Adhesives

MLCCs generally require the use of an adhesive to position the chips to the circuit board prior to soldering.

### 3-1. Requirements for Adhesives

They must have enough adhesion so that the chips will not fall off or move during the handling of the circuit board.

They must maintain their adhesive strength when exposed to soldering temperatures.

They should not spread or run when applied to the circuit board.

They should have a long pot life.

They should harden quickly.

They should not corrode the circuit board or chip material.

They should be a good insulator.

They should be non-toxic, and not produce harmful gases, nor be harmful when touched.

### 3-2. Application Method

It is important to use the proper amount of adhesive. Too little will cause poor adhesion to the circuit board, and too much may strain the conductor pattern, thereby causing defective soldering. The following illustrations show the proper quantity of adhesive.



Unit: mm		
Type	21	31
a	0.2min	0.2min
b	70~100 μm	70~100 μm
c	>0	>0

### 3-3. Adhesive hardening Characteristics

To prevent oxidation of the terminations, the adhesive must harden at 160°C or less, within 2 minutes or less.

## 4. Mounting

### 4-1. Mounting Head Pressure

Excessive pressure will cause chip capacitors to crack. The pressure between nozzle and chip capacitor will be 300g maximum during mounting.

### 4-2. Bending Stress

Bending of printed circuit board by mounting head when double-sided circuit boards are used, chip capacitors first are mounted and soldered onto one side of the board. When the capacitors are mounted onto the other side, it is important to support the board as shown in the illustration. If the circuit board is not supported, it may bend, causing the already-installed capacitors to crack.



## 5. Flux

Although highly-activated flux gives better solderability, substances which increase activity may also degrade the insulation of the chip capacitors. To avoid such degradation, it is recommended that a mildly activated rosin flux (less than 0.2% chlorine) be used.

## 6. Soldering

Since a multilayer ceramic chip capacitor comes into direct contact with melted solder during soldering, it is exposed to potentially mechanical stress caused by the sudden temperature change. The capacitor may also be subject to silver migration, and to contamination by the flux. Because of these factors, soldering technique is critical.

### 6-1. Soldering Methods

Method	Classification	
Reflow soldering	· Overall heating	· Infrared rays · Hot plate · VPS (Vapor phase)
	· Local heating	· Air heater · Laser · Light beam
Flow soldering	· Single wave · Double wave	

### 6-2. Soldering Profile

To avoid the crack problem by sudden temperature change, follow the temperature profile in the adjacent graph.

Part Numbering System

Standard & High Capacitors

Super Small Size Capacitors

High-Q Capacitors

Medium-High Voltage Capacitors

Array Type Capacitors

Low ESL Capacitors

Reliability Test Condition

Premium Capacitors for Automotive Applications

Packaging Specification

Application Manual for Surface Mounting

**6-2-1 Pb-Free (Sn 100%) Plating**

▪ **REFLOW SOLDERING**



Soldering Temp. (°C)	Pre-heating Time (①, sec.)	Soldering Time (②, sec.)
260+0/-5°C	60~120	60~150

▪ **FLOW SOLDERING**



ΔT (°C)	Soldering Temp. (°C)	Pre-heating Time (①+②, sec.)	Soldering Time (③, sec.)
≤150 (1206 and below size)	260±3	≥120	≤5

▪ **SOLDER IRON(Hand Soldering)**

Variation of Temp.(°C)	Soldering Temp.(°C)	Pre-heating Time(sec.)	Soldering Time(sec.)	Cooling Time(sec.)	Condition of Iron Facilities		
					Wattage	Tip Diameter	Soldering Time
ΔT≤130	300±10°C max.	≥ 60 sec.	≤ 4 sec.	—	20W max.	3mm max.	4 sec max.

※ Caution - Iron tip should not contact with ceramic body directly

### 6-3. Manual Soldering

Manual soldering can pose a great risk of creating thermal cracks in chip capacitors. The hot soldering iron tip comes into direct contact with the end terminations, and operator's carelessness may cause the tip of the soldering iron to come into direct contact with the ceramic body of the capacitor. Therefore the soldering iron must be handled carefully, and close attention must be paid to the selection of the soldering iron tip and to temperature control of the tip.

### 6-4. Amount of Solder

Too much Solder		Cracks tend to occur due to large stress.
Not enough solder		Weak holding force may cause bad connections or detaching of the capacitor

### 6-5. Cooling

Natural cooling using air is recommended. If the chips are dipped into solvent for cleaning, the temperature difference ( $\Delta T$ ) must be less than 100°C

### 6-6. Cleaning

If rosin flux is used, cleaning usually is unnecessary. When strongly activated flux is used, chlorine in the flux may dissolve into some types of cleaning fluids, thereby affecting the chip capacitors. This means that the cleaning fluid must be carefully selected, and should always be new.

## 7. Notes for Separating Multiple, Shared PC Boards

A multi-PC board is separated into many individual circuit boards after soldering has been completed. If the board is bent or distorted at the time of separation, cracks may occur in the chip capacitors. Carefully choose a separation method that minimizes the bending of the circuit board.

Part Numbering System

Standard & High Capacitors

Super Small Size Capacitors

High-Q Capacitors

Medium-High Voltage Capacitors

Array Type Capacitors

Low ESL Capacitors

Reliability Test Condition

Premium Capacitors for Automotive Applications

Packaging Specification

Application Manual for Surface Mounting

 **Attention**

1. This catalogue is valid only to the products purchased either from us or through our official distributors.
2. Product specifications included in this catalogue are effective as of Nov 1, 2015.  
Please be advised that they are standard product specifications for reference only.  
We may change, modify or discontinue the product specifications without notice at any time.  
So, you need to approve the product specifications before placing an order. Should you have any question regarding our product specifications, please contact our sales personnel or application engineers.
3. We may modify or cease to produce the products listed in this catalogue without notice. Should you have any question, please contact our sales personnel or application engineers.
4. Without obtaining our permission, you should not be allowed to reproduce, copy, use or transfer any content or information contained this catalogue in any manner whatsoever for any purpose.
5. In no event, will we be responsible for any claim, dispute, damage or liability whatsoever arising from, relating to or in connection with your misuse of the products or/and information included in this catalogue.  
We will also not assume any responsibilities whatsoever for any claim, dispute, damage or liability with regards to the intellectual property rights or other related rights of ours or any third party associated with your use of our products and/or information contained in this catalogue. We expressly disclaim that no license is granted regarding the aforementioned rights.
6. Please note that the products in this catalogue are not designed or intended to use for the applications set forth below. So, if you intend to use the products in this catalogue for the applications listed below, you should contact our sales personnel or application engineers before using.  
Please be aware that any misuse of the products deviating from product specifications or information provided in this catalogue may cause a serious property damage or a personal injury.
  - ① Aerospace/Aviation equipment
  - ② Transportation equipment (vehicles, trains, ships, etc)
  - ③ Medical equipment
  - ④ Military equipment
  - ⑤ Disaster prevention/crime prevention equipment
  - ⑥ Any other applications with the same as or similar complexity or reliability to the applications set forth above.



Certifications

ISO/TS 16949

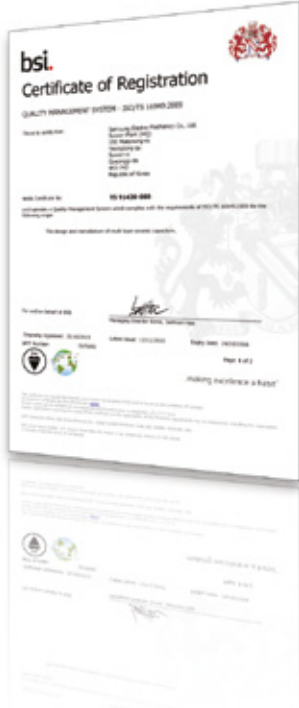

ISO 14001



OHSAS18001



Sony Green Partner



QC 080000 IECQ HSPM



**Quality System Certification status for each factory site**

<b>Certification</b>	<b>Suwon (Korea)</b>	<b>Busan (Korea)</b>	<b>Calamba (Philippines)</b>	<b>Tianjin (China)</b>	<b>Binhai (China)</b>
<b>ISO / TS 16949</b>	<b>BSI TS 91430 - 000</b>	<b>BSI TS 91430 - 001</b>	<b>BSI TS 91430 - 005</b>	<b>BSI TS 91430 - 007</b>	<b>BSI TS 91430 - 007</b>
Date Validity	2013-10-25 ~2016-10-24	2013-08-08 ~2016-08-07	2012-08-03 ~2015-08-02	2011-11-29 ~2014-11-28	2011-11-29 ~2014-11-28
<b>ISO 14001</b>	<b>BSI EMS 599427</b>	<b>BSI EMS 599427</b>	<b>BSI EMS 77354</b>	<b>BSI EMS 585363</b>	<b>BSI EMS 585363</b>
Date Validity	2013-06-25 ~2016-06-24	2013-06-25 ~2016-06-24	2012-07-13 ~2015-07-12	2012-04-17 ~2015-04-16	2012-04-17 ~2015-04-16
<b>OHSAS 18001</b>	<b>BSI OHS 599428</b>	<b>BSI OHS 599428</b>	<b>BSI OHS 568723</b>	<b>BSI OHS 585364</b>	<b>BSI OHS 585364</b>
Date Validity	2013-06-25 ~2016-06-24	2013-06-25 ~2016-06-24	2013-10-14 ~2016-10-13	2012-04-17 ~2015-04-16	2012-04-17 ~2015-04-16
<b>Sony Green Partner Date Validity</b>	2012-06-01 ~2014-05-31	2012-06-01 ~2014-05-31	2012-06-01 ~2014-05-31	2012-06-01 ~2014-05-31	2012-06-01 ~2014-05-31
<b>QC 080000</b>	<b>UL KR-HSPM-1011</b>	<b>UL KR-HSPM-1012</b>	<b>UL PI-HSPM-1001</b>	<b>UL PRC-HSPM-1767</b>	<b>UL PRC-HSPM-1767-2</b>
Date Validity	2013-06-17 ~2016-07-01	2013-06-27 ~2016-07-19	2013-06-27 ~2016-07-04	2013-07-08 ~2016-07-26	2013-07-08 ~2016-07-26

Note



## Passive components sales offices

### • Head office

150, Meayoungro(Maetan-dong)  
Yeongtong-gu, Suwon-city,  
Gyeonggi province, Korea,443-743  
Tel : +82-31-210-5114

#### Europe

Tel : +82-31-210 -6328  
E-mail : james.pyun@samsung.com

#### America

Tel : +82-31-210 -6803  
E-mail : wesley.roh@samsung.com

#### China

Tel : +82-31-210-3476  
E-mail : james.h.lee@samsung.com

#### Japan

Tel : +82-31-210-6304  
E-mail : jdkim1@samsung.com

#### Domestic

Tel : +82-31-210-3692  
E-mail : jeongki.um@samsung.com

### • Manufacturing sites

#### Suwon Plant(Korea)

150,Meayoungro(Maetan-dong)  
Yeongtong-gu, Suwon-city,  
Gyeonggi province, Korea,443-743  
Tel : +82-31-210-5114

#### Busan Plant (Korea)

333,Noksan Sanupjoongro(Songjeong-  
dong,)Gangseo-gu, Busan, Korea,  
618-270  
Tel : +82-51-970-7114

#### Tianjin Plant (China)

27, Heiniucheng-Road,Tianjin,  
China 300210  
Tel : +86-22-2830-3333

#### Binhai Plant(China)

No 80 xiaqing road,  
TEDA west District, China  
Tel : +86-22-6686-3333

#### Philippines Plant (Philippines)

Block 5 Calamba Premiere Industrial Park  
Calamba City, Philippines  
Tel : +63-49-508-8311

### • Asia sales offices

#### Shenzhen office

46 F, New World Center, Yitian Road, Futian  
District,Shenzhen, China 518026  
Tel : +86-755-8608-5579  
E-mail : andy.li@samsung.com

#### Shanghai office

Rm. 1211, Shanghai International Trade  
CenterNo.2201 Yan An(W) Rd., Shanghai, China  
200335  
Tel : +86-21-2231-4341  
E-mail : koogil@samsung.com

#### Beijing office

12/F China Merchants Tower No. 118, Jian Guo  
Lu, Chao Yang District, Beijing, China  
Tel : +86-10-6566-8100-6606  
E-mail : kiko.wang@samsung.com

#### Qingdao Office

Rm 1201. Growne Plaza Qingdao 76,  
Xiang Gang Zhong Rd, Qingdao,  
266071 China  
Tel : +86-532-85779102  
E-mail : zhengguo.cui@samsung.com

#### Taipei Office

9F-1, Np. 399 Ruey Kuang Rd., Neihu  
District, Taipei City, Taiwan, 114  
Tel : +886-2-2656-8350  
E-mail : kevin0130.wang@samsung.com

#### Singapore office

Samsung Electro-Mechanics Private LimitedP  
3 Church Street Samsung Hub #23-01  
Singapore 049483  
Tel : +65-6933-2630  
E-mail : alvin.koh@samsung.com

#### Bangkok office

24180 Wellgrow Industrial Estate, 93 Moo 5,  
Bangsamak A. Bangpakong, Chachoensao,  
Thailand  
Tel : +66-38-562-110  
E-mail : kyunghoon1.lee@samsung.com

#### Japan office

108-0075 Minato-ku Tokyo Kounan 2-16-4  
Shinagawa Grand Cnetral Tower 9F, Japan  
Tel : +81-3-6369-6452  
E-mail : hikota.suga@samsung.com

### • America sales office

#### Irvine office

3333 Michelson Drive, Suite 500, Irvine, CA  
92612, USA  
Tel : +1-949-797-8016  
E-mail : andrew.skelly@samsung.com

#### San Jose office

601, McCarthy Blvd., San Jose, CA 95035, USA  
Tel : +1-408-544-4552  
E-mail : jay.pauer@samsung.com

#### Chicago office

1870 West Winchester Rd, Suite 247,  
Libertyville IL 60048, USA  
Tel : +1-847-549-9424  
E-mail : sweety@samsung.com

### • Europe sales offices

#### Frankfurt office

Samsung, Haus, Am Kronberger Hang 6,  
D-65824 Schwalbach/Ts. Germany  
Tel : +49-6196-66-7255  
E-mail : frank.goebell@samsung.com

#### London office

KT130NY 2nd floor, No 5. No 5. The Heights,  
Brooklands, Weybridge Surrey, England  
Tel : +44-1932-826-811  
E-mail : river.lee@samsung.com

#### Helsinki office

02600, Lars Sonckin Kaari 14, Espoo, Finland  
Tel : +358-9-853-1132  
E-mail : jouni.riuttanen@samsung.com

### • Domestic Distributors

#### Korchip Corporation

359, Manan-ro, Manan-gu, Anyang-si,  
Gyeonggi-do, Korea  
Tel : +82-31-361-8100  
E-mail : parts@korchip.com

#### SAMT

315, Yeongdong-daero, Gangnam-gu, Seoul,  
Korea  
Tel : +82-2-3458-9000  
E-mail : info@samt.com

#### CHUNGMAC

40-3, Gokseon-ro 49beon-gil, Gwonseon-gu,  
Suwon-si, Gyeonggi-do, Korea  
Tel : +82-31-234-2367  
E-mail : webmaster@chungmac.co.kr

#### YOUNGDUK

632, Seobusaet-gil, Geumcheon-gu, Seoul,  
Korea  
Tel : +82-2-2107-7860  
E-mail : dryblood@hanmail.net

All information indicated in this catalog is as of November. 2015

\* The specifications and designs contained herein may be subject to change without notice.

## X-ON Electronics

Largest Supplier of Electrical and Electronic Components

*Click to view similar products for [Multilayer Ceramic Capacitors MLCC - SMD/SMT category:](#)*

*Click to view products by [Samsung manufacturer:](#)*

Other Similar products are found below :

[M39014/01-1467](#) [M39014/02-1218V](#) [M39014/02-1225V](#) [M39014/02-1262V](#) [M39014/02-1301](#) [M39014/22-0631](#) [1210J5000102JCT](#)  
[1210J2K00102KXT](#) [1210J5000103KXT](#) [1210J5000223KXT](#) [D55342E07B379BR-TR](#) [D55342E07B523DR-T/R](#) [1812J1K00103KXT](#)  
[1812J1K00473KXT](#) [1812J2K00680JCT](#) [1812J4K00102MXT](#) [1812J5000102JCT](#) [1812J5000103JCT](#) [1812J5000682JCT](#) [NIN-FB391JTRF](#)  
[NIN-FC2R7JTRF](#) [NPIS27H102MTRF](#) [C1206C101J1GAC](#) [C1608C0G1E472JT000N](#) [C2012C0G2A472J](#) [2220J2K00101JCT](#)  
[KHC201E225M76N0T00](#) [1812J1K00222JCT](#) [1812J2K00102KXT](#) [1812J2K00222KXT](#) [1812J2K00472KXT](#) [2-1622820-7-CUT-TAPE](#)  
[2220J3K00102KXT](#) [2225J2500824KXT](#) [CCR07CG103KM](#) [CGA2B2C0G1H010C](#) [CGA2B2C0G1H040C](#) [CGA2B2C0G1H050C](#)  
[CGA2B2C0G1H060D](#) [CGA2B2C0G1H070D](#) [CGA2B2C0G1H151J](#) [CGA2B2C0G1H1R5C](#) [CGA2B2C0G1H2R2C](#) [CGA2B2C0G1H3R3C](#)  
[CGA2B2C0G1H680J](#) [CGA2B2C0G1H6R8D](#) [CGA2B2X8R1H221K](#) [CGA2B2X8R1H472K](#) [CGA3E1X7R1C474K](#)  
[CGA3E2C0G1H561JT0Y0N](#)