

## General-purpose Relay MY

### Versatile and Function-filled Miniature Power Relay for Sequence Control and Power Switching Applications

- Models with lockable test buttons now available.
- Many variations possible through a selection of operation indicators (mechanical and LED indicators), lockable test button, built-in diode and CR (surge suppression), bifurcated contacts, etc.
- Arc barrier standard on 4-pole Relays.
- Dielectric strength: 2,000 VAC (coil to contact)
- Environment-friendly cadmium-free contacts.
- Safety standard approvals obtained.
- Wide range of Sockets (PY, PYF Series) and optional parts are available.
- Max. Switching Current: 2-pole: 10 A, 4-pole: 5 A
- Provided with nameplate.



## Ordering Information

### ■ Relays

#### Standard Coil Polarity

Type	Contact form	Plug-in socket/Solder terminals		Without LED indicator
		Standard with LED indicator	With LED indicator and lockable test button	
Standard	DPDT	MY2N	MY2IN	MY2
	4PDT	MY4N	MY4IN	MY4
	4PDT (bifurcated)	MY4ZN	MY4ZIN	MY4Z
With built-in diode (DC only)	DPDT	MY2N-D2	MY2IN-D2	---
	4PDT	MY4N-D2	MY4IN-D2	---
	4PDT (bifurcated)	MY4ZN-D2	MY4ZIN-D2	---
With built-in CR (220/240 VAC, 110/120 VAC only)	DPDT	MY2N-CR	MY2IN-CR	---
	4PDT	MY4N-CR	MY4IN-CR	---
	4PDT (bifurcated)	MY4ZN-CR	MY4ZIN-CR	---

#### Reverse Coil Polarity

Type	Contact form	Plug-in socket/Solder terminals	
		With LED indicator	With LED indicator and lockable test button
Standard (DC only)	DPDT	MY2N1	MY2IN1
	4PDT	MY4N1	MY4IN1
	4PDT (bifurcated)	MY4ZN1	MY4ZIN1
With built-in diode (DC only)	DPDT	MY2N1-D2	MY2IN1-D2
	4PDT	MY4N1-D2	MY4IN1-D2
	4PDT (bifurcated)	MY4ZN1-D2	MY4ZIN1-D2

**Note:** When ordering, add the rated coil voltage and "(s)" to the model number. Rated coil voltages are given in the coil ratings table.

Example: MY2 6VAC (S)

↑  
Rated coil voltage

## ■ Accessories (Order Separately)

### Sockets

Poles	Front Mounting Socket (DIN-rail/screwless clamp [SLC])	Front-mounting Socket (DIN-rail/screw mounting)	Back-mounting Socket				PCB terminals
			Solder terminals		Wire-wrap terminals		
			Without clip	With clip	Without clip	With clip	
2	PYF08S	PYF08A-E PYF08A-N	PY08	PY08-Y1	PY08QN PY08QN2	PY08QN-Y1 PY08QN2-Y1	PY08-02
4	PYF14S	PYF14A-E PYF14A-N PYF14-ESS-B PYF14-ESN-B	PY14	PY14-Y1	PY14QN PY14QN2	PY14QN-Y1 PY14QN2-Y1	PY14-02

### Socket Hold-down Clip Pairing

Relay type	Poles	Front Mounting Socket (DIN-rail/screwless clamp [SLC])	Front-connecting Socket (DIN-rail screw mounting)		Back-connecting Socket				
			Socket	Clip	Solder/Wire-wrap terminals		PCB terminals		
					Socket	Clip	Socket	Clip	
Without 2-pole test button	2	PYF08S	PYCM-08S	PYF08A-E PYF08A-N	PYC-A1	PY08(QN)	PYC-P PYC-P2	PY08-02	PYC-P PYC-P2
	4	PYF14S	PYCM-14S	PYF14A-E PYF14A-N PYF14-ESS-B PYF14-ESN-B	PYC-0 (metal) PYC35-B (plastic)	PY14(QN)		PY14-02	
2-pole test button	2	PYF08S	PYCM-08S	PYF08A-E PYF08A-N	PYC-E1	PY08(QN)	PYC-P2	PY08-02	PYC-P2

### Mounting Plates for Sockets

Socket model	For 1 Socket	For 18 Sockets	For 36 Sockets
PY08, PY08QN(2), PY14, PY14QN(2)	PYP-1	PYP-18	PYP-36

Note: PYP-18 and PYP-36 can be cut into any desired length in accordance with the number of Sockets.

### DIN-rail and Accessories

Supporting DIN-rail (length = 500 mm)	PFP-50N
Supporting DIN-rail (length = 1,000 mm)	PFP-100N, PFP-100N2
End Plate	PFP-M
Spacer	PFP-S

## Specifications

### ■ Coil Ratings

Rated voltage		Rated current		Coil resistance	Coil inductance (reference value)		Must operate voltage	Must release voltage	Max. voltage	Power consumption (approx.)
		50 Hz	60 Hz		Arm. OFF	Arm. ON				
AC	6 V*	214.1 mA	183 mA	12.2 Ω	0.04 H	0.08 H	80% max.	30% min.	110%	1.0 to 1.2 VA (60 Hz)
	12 V	106.5 mA	91 mA	46 Ω	0.17 H	0.33 H				
	24 V	53.8 mA	46 mA	180 Ω	0.69 H	1.30 H				
	48/50 V*	24.7/25.7 mA	21.1/22.0 mA	788 Ω	3.22 H	5.66 H				
	110/120 V	9.9/10.8 mA	8.4/9.2 mA	4,430 Ω	19.20 H	32.1 H				
	220/240 V	4.8/5.3 mA	4.2/4.6 mA	18,790 Ω	83.50 H	136.4 H				
DC	6 V*	151 mA		39.8 Ω	0.17 H	0.33 H		10% min.		0.9 W
	12 V	75 mA		160 Ω	0.73 H	1.37 H				
	24 V	37.7 mA		636 Ω	3.20 H	5.72 H				
	48 V*	18.8 mA		2,560 Ω	10.60 H	21.0 H				
	100/110 V	9.0/9.9 mA		11,100 Ω	45.60 H	86.2 H				

Note: 1. The rated current and coil resistance are measured at a coil temperature of 23°C with tolerances of +15%/–20% for rated currents and ±15% for DC coil resistance.

2. Performance characteristic data are measured at a coil temperature of 23°C.

3. AC coil resistance and impedance are provided as reference values (at 60 Hz).

4. Power consumption drop was measured for the above data. When driving transistors, check leakage current and connect a bleeder resistor if required.

5. Rated voltage denoted by "\*" will be manufactured upon request. Ask your OMRON representative.

## ■ Contact Ratings

Item	2-pole		4-pole		4-pole (bifurcated)	
	Resistive load ( $\cos\phi = 1$ )	Inductive load ( $\cos\phi = 0.4, L/R = 7\text{ ms}$ )	Resistive load ( $\cos\phi = 1$ )	Inductive load ( $\cos\phi = 0.4, L/R = 7\text{ ms}$ )	Resistive load ( $\cos\phi = 1$ )	Inductive load ( $\cos\phi = 0.4, L/R = 7\text{ ms}$ )
Rated load	5A, 250 VAC 5A, 30 VDC	2A, 250 VAC 2 A, 30 VDC	3 A, 250 VAC 3 A, 30 VDC	0.8 A, 250 VAC 1.5 A, 30 VDC	3 A, 250 VAC 3 A, 30 VDC	0.8 A, 250 VAC 1.5 A, 30 VDC
Carry current	10 A (see note)		5 A (see note)			
Max. switching voltage	250 VAC 125 VDC		250 VAC 125 VDC			
Max. switching current	10 A		5 A			
Max. switching power	2,500 VA 300 W	1,250 VA 300 W	1,250 VA 150 W	500 VA 150 W	1,250 VA 150 W	500 VA 150 W
Failure rate (reference value)	5 VDC, 1 mA		1 VDC, 1 mA		1 VDC, 100 $\mu$ A	

**Note:** Don't exceed the carry current of a Socket in use. Please see page G-10.

## ■ Characteristics

Item	All Relays
Contact resistance	100 m $\Omega$ max.
Operate time	20 ms max.
Release time	20 ms max.
Max. operating frequency	Mechanical: 18,000 operations/hr Electrical: 1,800 operations/hr (under rated load)
Insulation resistance	1,000 M $\Omega$ min. (at 500 VDC)
Dielectric strength	2,000 VAC, 50/60 Hz for 1.0 min (1,000 VAC between contacts of same polarity)
Vibration resistance	Destruction: 10 to 55 to 10 Hz, 0.5 mm single amplitude (1.0 mm double amplitude) Malfunction: 10 to 55 to 10 Hz, 0.5 mm single amplitude (1.0 mm double amplitude)
Shock resistance	Destruction: 1,000 m/s <sup>2</sup> Malfunction: 200 m/s <sup>2</sup>
Endurance	See the following table.
Ambient temperature	Operating: -55°C to 70°C (with no icing)
Ambient humidity	Operating: 5% to 85%
Weight	Approx. 35 g

**Note:** The values given above are initial values.

## ■ Endurance Characteristics

Pole	Mechanical life (at 18,000 operations/hr)	Electrical life (at 1,800 operations/hr under rated load)
2-pole	AC:50,000,000 operations min.	500,000 operations min.
4-pole	DC:100,000,000 operations min.	200,000 operations min.
4-pole (bifurcated)	20,000,000 operations min.	100,000 operations min.

■ Approved Standards

**VDE Recognitions (File No. 112467UG, IEC 255, VDE 0435)**

No. of poles	Coil ratings	Contact ratings	Operations
2	6, 12, 24, 48/50, 100/110 110/120, 200/220, 220/240 VAC	10 A, 250 VAC (cosφ=1) 10 A, 30 VDC (L/R=0 ms)	10 x 10 <sup>3</sup>
4	6, 12, 24, 48, 100/110, 125 VDC	5 A, 250 VAC (cosφ=1) 5 A, 30 VDC (L/R=0 ms)	100 x 10 <sup>3</sup> MY4Z AC; 50 x 10 <sup>3</sup>

**UL508 Recognitions (File No. 41515)**

No. of poles	Coil ratings	Contact ratings	Operations
2	6 to 240 VAC 6 to 125 VDC	10 A, 30 VDC (General purpose) 10 A, 250 VAC (General purpose)	6 x 10 <sup>3</sup>
4		5 A, 250 VAC (General purpose) 5 A, 30 VDC (General purpose)	

**CSA C22.2 No. 14 Listings (File No. LR31928)**

No. of poles	Coil ratings	Contact ratings	Operations
2	6 to 240 VAC 6 to 125 VDC	10 A, 30 VDC 10 A, 250 VAC	6 x 10 <sup>3</sup>
4		5 A, 250 VAC (Same polarity) 5 A, 30 VDC (Same polarity)	

**IMQ (File No. EN013 to 016)**

No. of poles	Coil ratings	Contact ratings	Operations
2	6, 12, 24, 48/50, 100/110 110/120, 200/220, 220/240 VAC	10 A, 30 VDC 10 A, 250 VAC	10 x 10 <sup>3</sup>
4		5 A, 250 VAC 5 A, 30 VDC	100 x 10 <sup>3</sup> MY4Z AC; 50 x 10 <sup>3</sup>

**LR Recognitions (File No. 98/10014)**

No. of poles	Coil ratings	Contact ratings	Operations
2	6 to 240 VAC 6 to 125 VDC	10 A, 250 VAC (Resistive) 2 A, 250 VAC (PF0.4) 10 A, 30 VDC (Resistive) 2 A, 30 VDC (L/R=7 ms)	50 x 10 <sup>3</sup>
4		5 A, 250 VAC (Resistive) 0.8 A, 250 VAC (PF0.4) 5 A, 30 VDC (Resistive) 1.5 A, 30 VDC (L/R=7 ms)	50 x 10 <sup>3</sup>

**SEV Listings (File No. 99.5 50902.01)**

No. of poles	Coil ratings	Contact ratings	Operations
2	6 to 240 VAC 6 to 125 VDC	10 A, 250 VAC 10 A, 30 VDC	10 x 10 <sup>3</sup>
4		5 A, 250 VAC 5 A, 30 VDC	100 x 10 <sup>3</sup> MY4Z AC; 50 x 10 <sup>3</sup>

# Engineering Data

## Maximum Switching Power

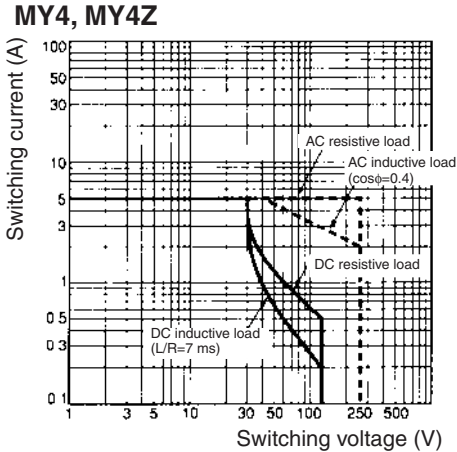
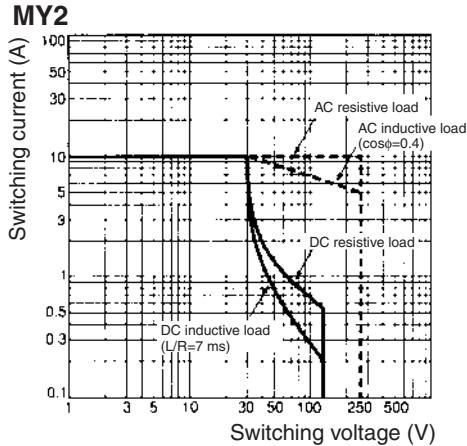

## Endurance

**MY2 (Resistive Loads)**

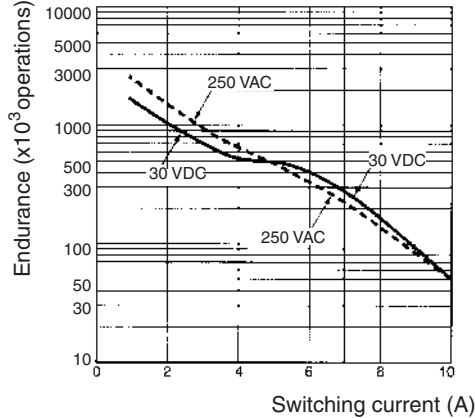

**MY2 (Inductive Loads)**

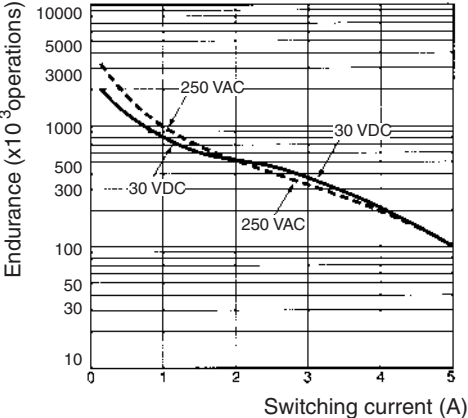

**MY4 (Resistive Loads)**

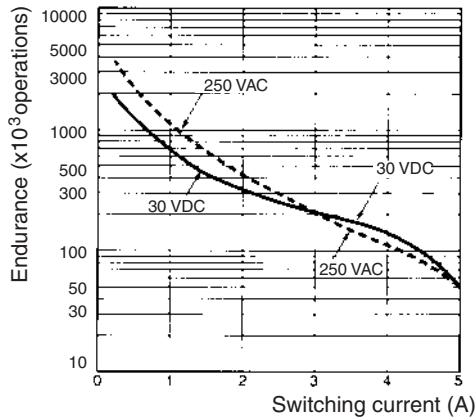

**MY4 (Inductive Loads)**

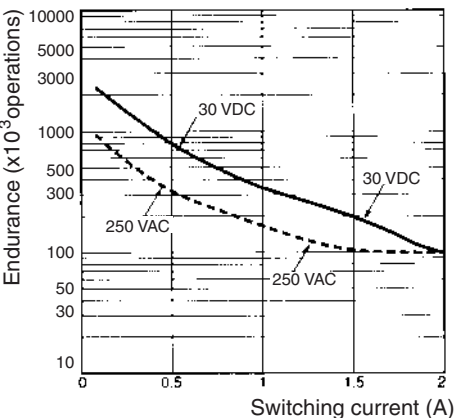

**MY4Z (Resistive Loads)**

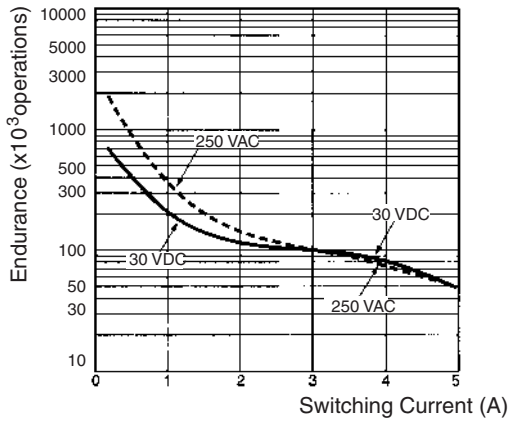

**MY4Z (Inductive Loads)**

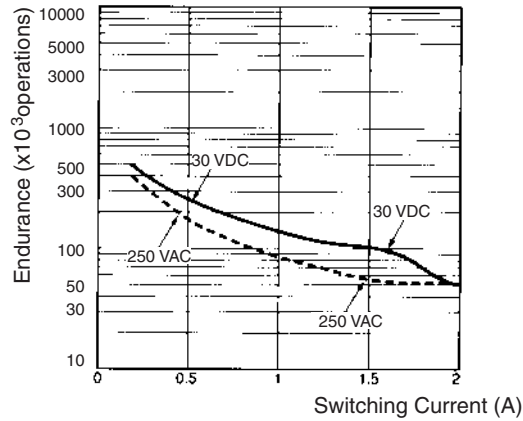

**Technical and Environmental Properties**

	2-Pole model	4-Pole model
DIN-railing Resistance	600 CTI (base)	600 CTI (base)
Environmental Protection	RT1	RT1
Flammability Class	Base, Insulator, Spool Case, Indicator, Nameplate, Push Button	ul 94V-0 ul 94V-2
Pollution Degree	2	1
Creepage Distance	4.0 mm	3.2 mm
Clearance Distance	3.0 mm	3.0 mm
Contact Material	Ag	AgNi + Au

**Two-way action test button**

Relay in normal operation



For momentary operation

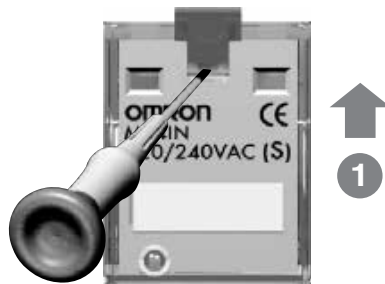

For lock operation

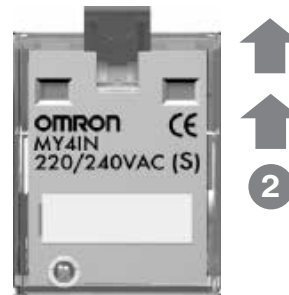

Push up the test button to the first position, then press the yellow button with an insulated tool to operate the contact.

Push up the test button to the second position. (The contact is now in the locked position).

**Typical information for reference only**

The following data is provided as experimental and/or calculated data for reference only. These figures fall under the category of typical behaviour and the operation of individual relays will vary according to the exact operating conditions.

Typical Operate / Release Times	2-Pole model	4-Pole model
AC Type (operate / release time)	8 ms/8 ms	10 ms/10 ms
DC Type (operate / release time)	14 ms/4 ms	14 ms/6 ms

**Load reduction Factor**

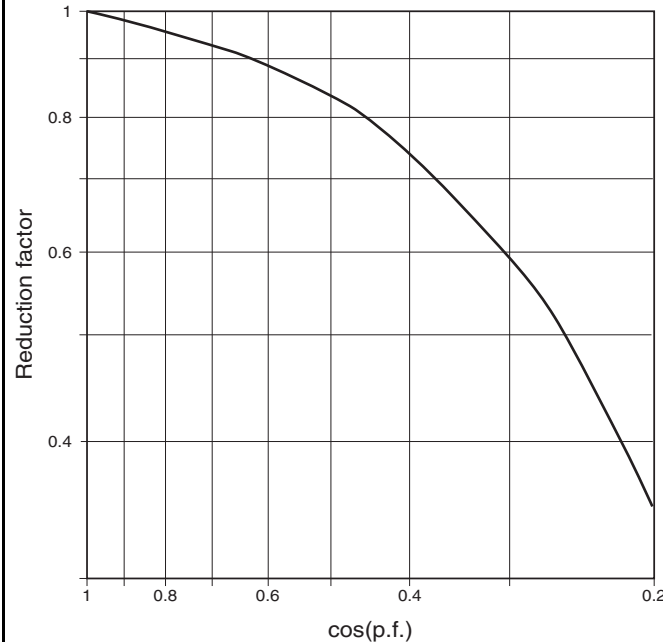

For AC inductive loads (such as solenoids, contactors coils, etc.) the reduction factor corresponding to  $\cos(p.f.)$  (cosine of the power factor) is multiplied by the rated current in order to identify the maximum allowable current. This approximation is not valid for loads with high inrush currents such as electric motors or fluorescent lamps.

**Multiple Contact DC Switching Capacity**

Switching capacity of DC resistive load

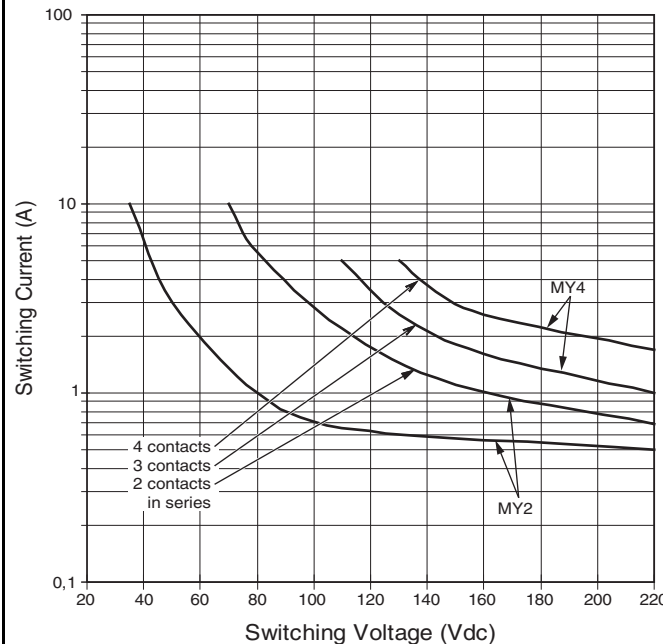

This graph can be used to estimate the number of contacts that can be used to switch DC resistive loads

**Effect of temperature on coil voltages**

MY2/4 Operating range (DC and AC type) vs ambient temperature

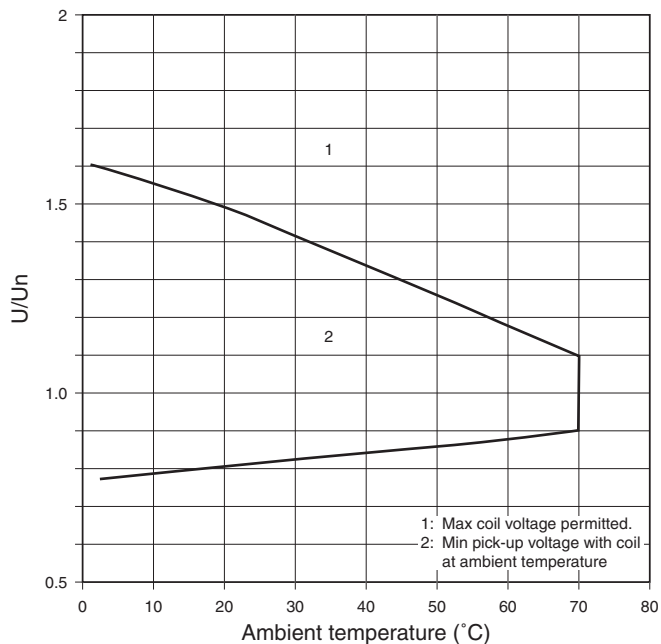

This graph shows the typical relationship between the maximum / minimum coil and pick-up voltage and ambient temperature

# Dimensions

Note: All units are in millimeters unless otherwise indicated.

## 2-Pole Models

MY2N

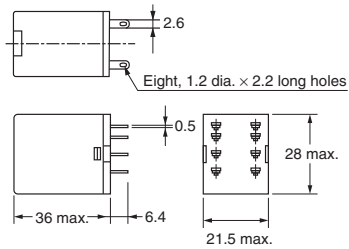
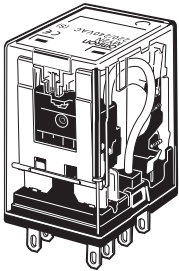

## 4-Pole Models

MY4N

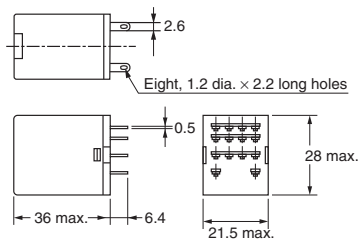
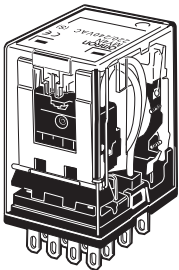

## Models with Test Button

MY2IN

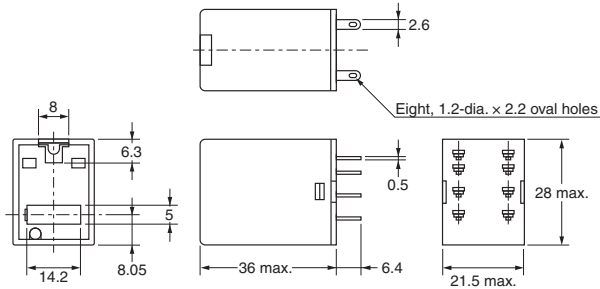
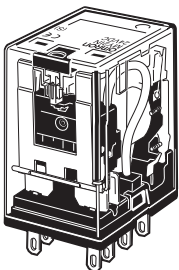

MY4IN

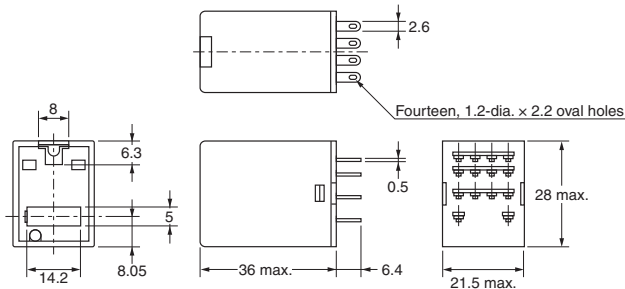
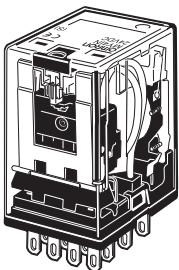



# Terminal Arrangement/Internal Connections (Bottom View)

MY2

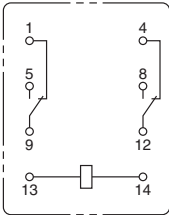

MY2N/MY2IN  
(AC Models)

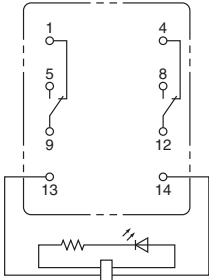

MY2N/MY2IN  
(DC Models)

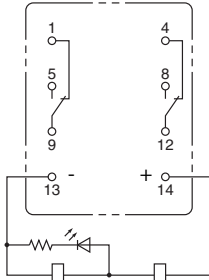

MY2N-D2/MY2IN-D2  
(DC Models Only)

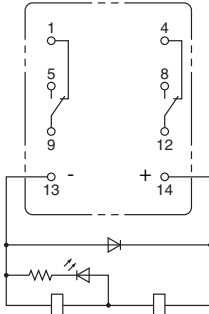

MY2N-CR/MY2IN-CR  
(AC Models Only)

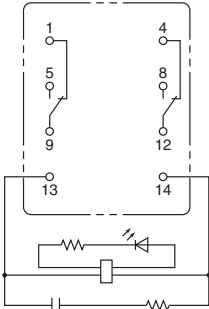

MY2N1/MY2IN1  
(DC Models Only)

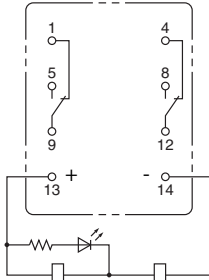

MY2N1-D2/MY2IN1-D2  
(DC Models Only)

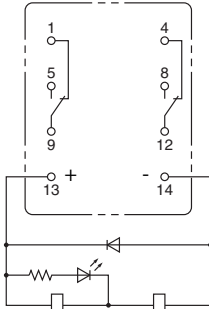

MY4(Z)

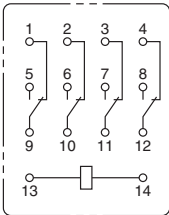

MY4(Z)N/MY4(Z)IN  
(AC Models)

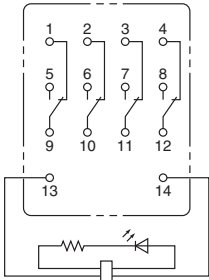

MY4(Z)N/MY4(Z)IN  
(DC Models)

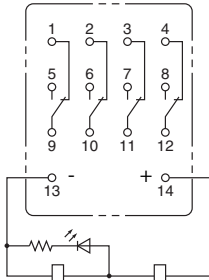

MY4(Z)N-D/MY4(Z)IN-D2  
(DC Models Only)

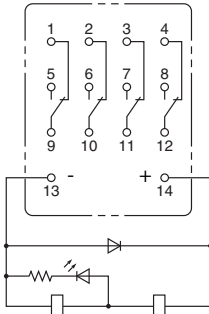

MY4(Z)N-CR/MY4(Z)IN-CR  
(AC Models Only)

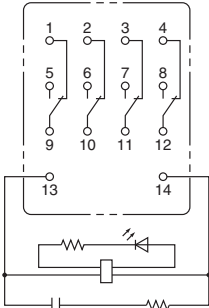

MY4(Z)N1/MY4(Z)IN1  
(DC Models Only)

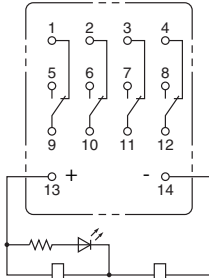

MY4(Z)N1-D2/MY4(Z)IN1-D2  
(DC Models Only)

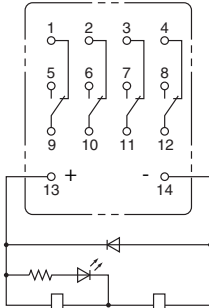

Note: The DC models have polarity.

# Sockets for MY

## DIN-rail-mounted (DIN-rail) Socket Conforms to VDE 0106, Part 100

- Snap into position along continuous sections of any mounting DIN-rail.
- Facilitates sheet metal design by standardized mounting dimensions.
- Design with sufficient dielectric separation between terminals eliminates the need of any insulating sheet.

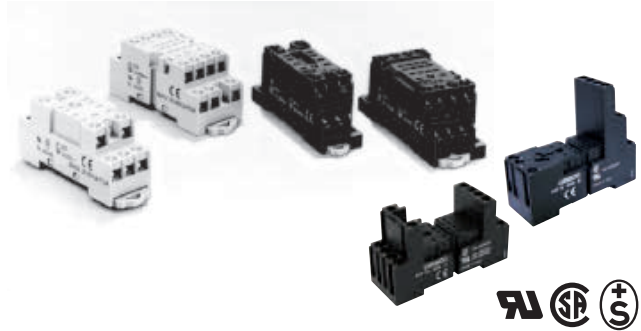

## ■ Safety Standards for Sockets

Model	Standards	File No.
PYF08A-E, PYF08A-N PYF14A-E, PYF14A-N	UL508 CSA22.2	E87929 LR31928
PYF14-ESN-B, PYF14-ESS-B	UL508 CSA22.2	E244189 LR225761

## Back-connecting Sockets

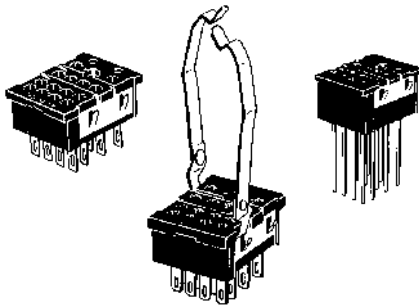





## ■ Specifications

Item	Pole	Model	Carry current	Dielectric withstand voltage	Insulation resistance (see note 2)
Screwless Clamp Terminal Socket	2	PYF08S	10 A	2,000 VAC, 1 min	Less than 1,000 MΩ
	4	PYF14S	5 A		
DIN-rail-mounted Socket	2	PYF08A-E	7 A	2,000 VAC, 1 min	1,000 MΩ min.
		PYF08A-N (see note 3)	7 A (see note 4)		
	4	PYF14A-E	5 A		
		PYF14A-N (see note 3)	5 A (see note 4)		
4	PYF14-ESN-B/-ESS-B	12 A	> 3 kV	> 5 MΩ	
Back-connecting Socket	2	PY08(-Y1)	7 A	1,500 VAC, 1 min	100 MΩ min.
		PY08QN(-Y1)			
		PY08-02			
	4	PY14(-Y1)	3 A		
		PY14QN(-Y1)			
		PY14-02			

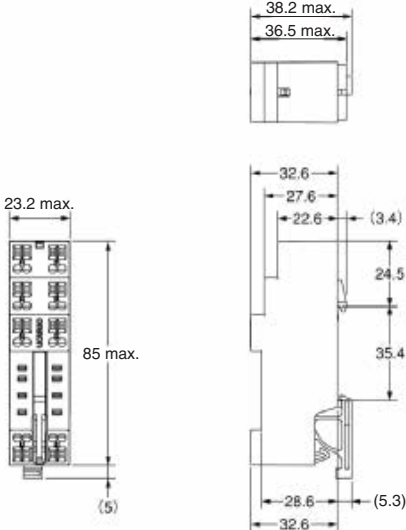
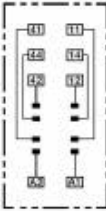

- Note:**
1. The values given above are initial values.
  2. The values for insulation resistance were measured at 500 V at the same place as the dielectric strength.
  3. The maximum operating ambient temperature for the PYF08A-N and PYF14A-N is 55°C.
  4. When using the PYF08A-N or PYF14A-N at an operating ambient temperature exceeding 40°C, reduce the current to 60%.
  5. The MY2(S) can be used at 70°C with a carry current of 7 A.

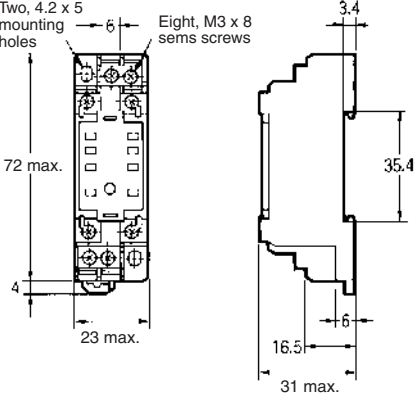
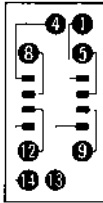
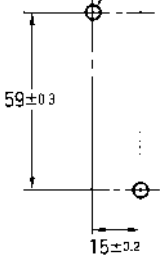

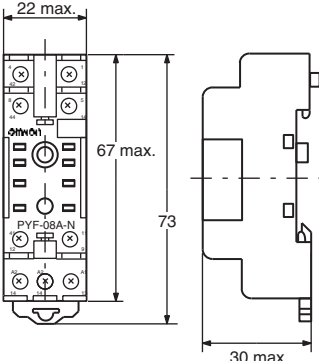

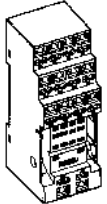
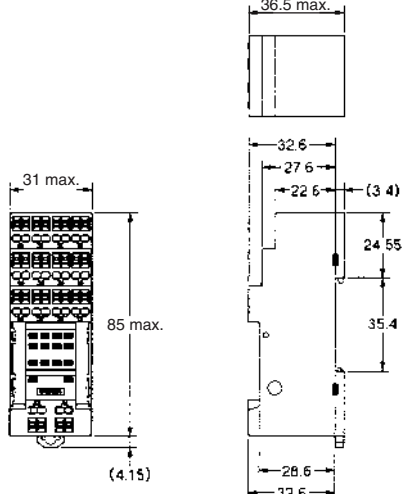
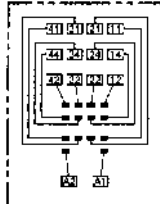
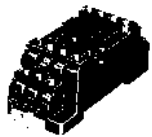
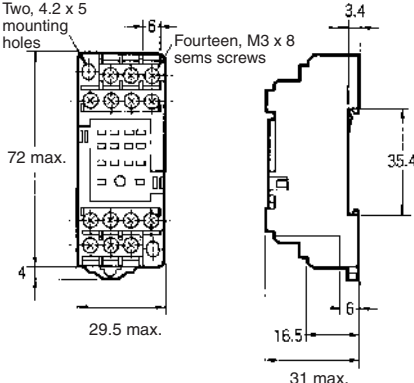
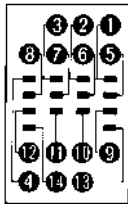
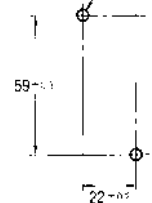
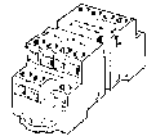
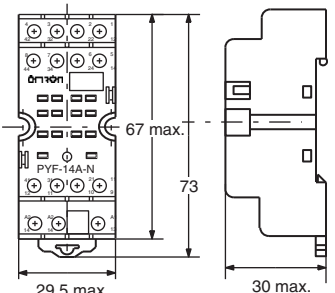
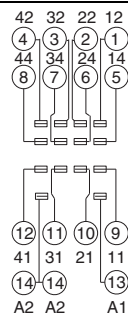
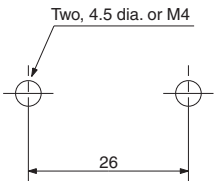
■ Dimensions

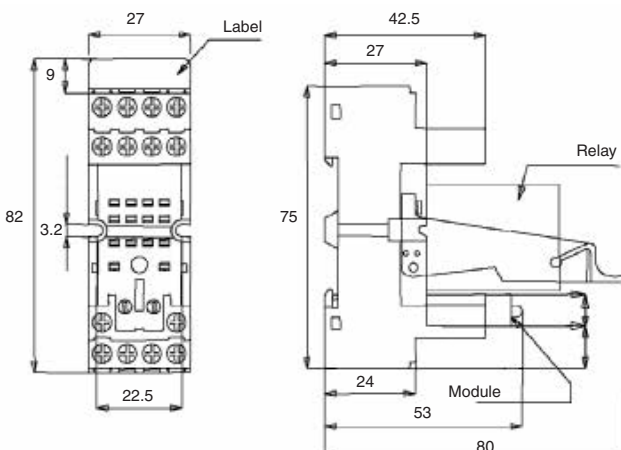
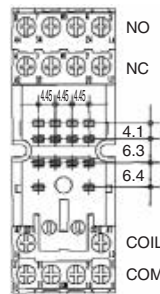
Note: All units are in millimeters unless otherwise indicated.

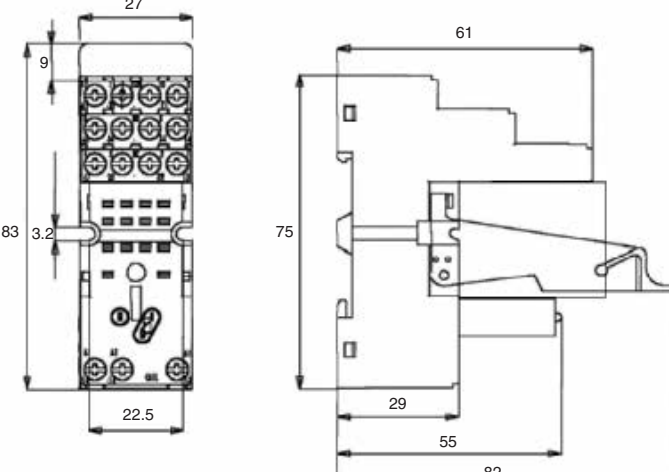
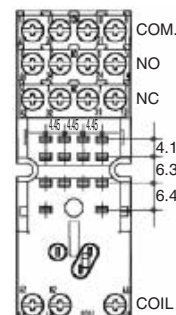
Socket	Dimensions	Terminal arrangement/ Internal connections (top view)	Mounting holes
<p>PYF08S</p> 			<p>---</p>
<p>PYF08A-E</p> 	<p>Two, 4.2 x 5 mounting holes</p> <p>Eight, M3 x 8 sems screws</p> 		<p>Two, M3, M4, or 4.5-dia. holes</p>  <p>(TOP VIEW)</p> <p><b>Note:</b> DIN-rail mounting is also possible. Refer to page G-15-G-16 for supporting DIN-rails.</p>
<p>PYF08A-N</p> 			

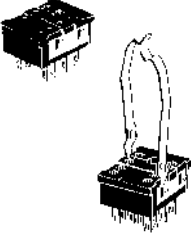
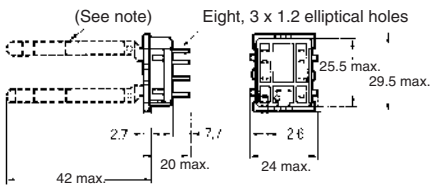
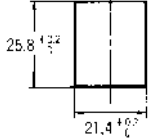
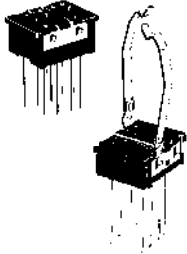
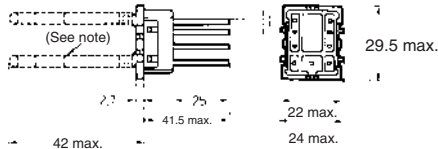
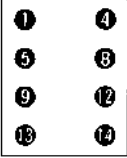
Socket	Dimensions	Terminal arrangement/ Internal connections (top view)	Mounting holes
<p>PYF14S</p> 			<p>---</p>
<p>PYF14A-E</p> 	<p>Two, 4.2 x 5 mounting holes</p> <p>Fourteen, M3 x 8 sems screws</p> 		<p>Two, M3, M4, or 4.5-dia. holes</p>  <p>(TOP VIEW)</p> <p><b>Note:</b> DIN-rail mounting is also possible. Refer to page G-15-G-16 for supporting DIN-rails.</p>
<p>PYF14A-N</p> 			<p>Two, 4.5 dia. or M4</p>  <p><b>Note:</b> DIN-rail mounting is also possible. Refer to page G-15-G-16 for supporting DIN-rails.</p>

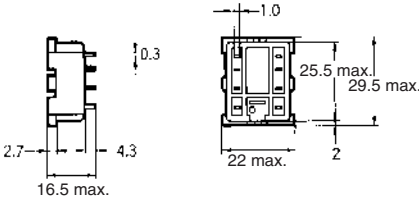
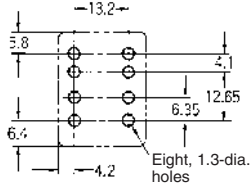
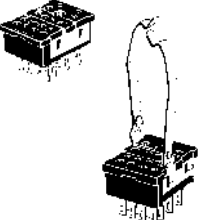
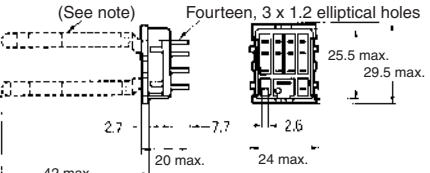
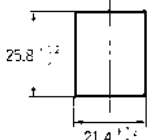
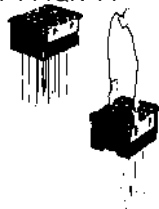
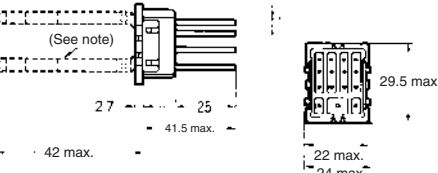
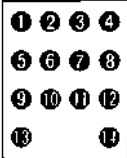
Socket	Dimensions	Terminal arrangement/ internal connections (top view)/ mounting holes
<p>PYF14-ESN-B</p> 		
<p>PYF14-ESS-B</p> 		

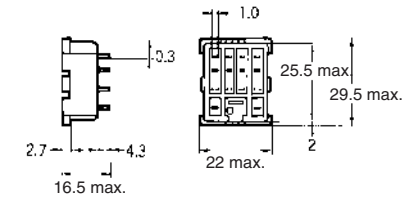
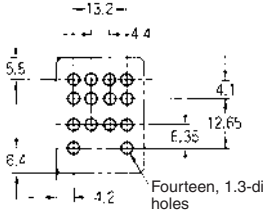
Socket	Dimensions	Terminal arrangement/ Internal connections (bottom view)	Mounting holes
<p>PY08/PY08-Y1</p> 	 <p>(See note) Eight, 3 x 1.2 elliptical holes</p> <p><b>Note:</b> The PY08-Y1 includes sections indicated by dotted lines.</p>		
<p>PY08QN/ PY08QN-Y1</p> 	 <p>(See note)</p> <p><b>Note:</b> The PY08QN-Y1 includes sections indicated by dotted lines.</p>		
<p>PY08-02</p> 			 <p>Eight, 1.3-dia. holes</p>
<p>PY14/PY14-Y1</p> 	 <p>(See note) Fourteen, 3 x 1.2 elliptical holes</p> <p><b>Note:</b> The PY14-Y1 includes sections indicated by dotted lines.</p>		
<p>PY14QN/ PY14QN-Y1</p> 	 <p>(See note)</p> <p><b>Note:</b> The PY14QN-Y1 includes sections indicated by dotted lines.</p>		
<p>PY14-02</p> 			 <p>Fourteen, 1.3-dia. holes</p>

**Note:** Use a panel with plate thickness of 1 to 2 mm for mounting the Sockets.

**Hold-down Clips**

**PYC-A1**  
(2 pcs per set)

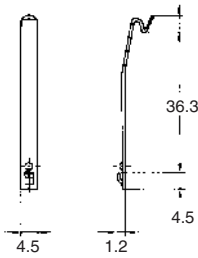

**PYC-E1**  
(2 pcs per set)

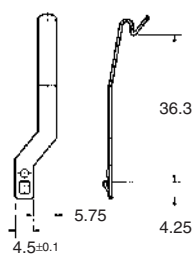

For sockets PYF14-ESN-B/-ESS-B

Model	Description
PYC-0	Metal spring clip (Used with Relay only)
PYC 35-B	Plastic holding clip (Used with Relay only)
PYC TR1	Thermoplastic writeable label

**Note:** For total dimensions with plastic clip please refer to drawings of the sockets.

**PYC-P**

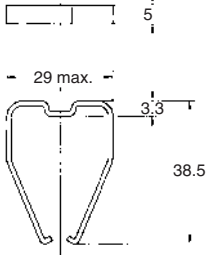

**PYC-P2**

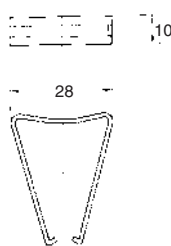

**Mounting Plates for Back-connecting Sockets**

**PYP-1**

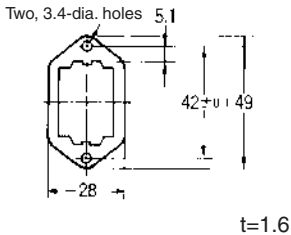

**PYP-36**

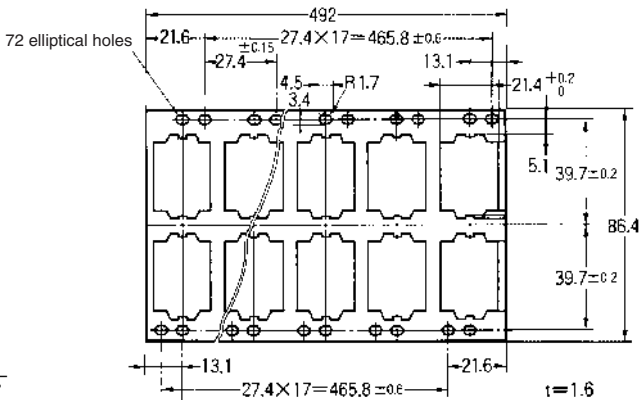

**PYP-18**

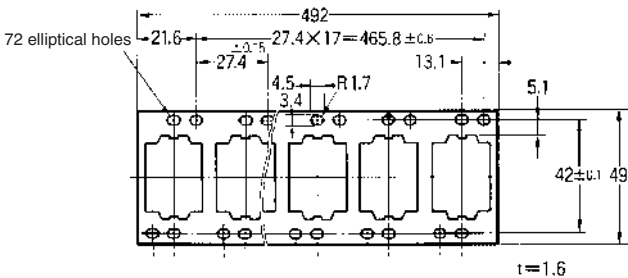

**DIN-rails and Accessories**

**Supporting DIN-rails**

**PFP-50N/PFP-100N**

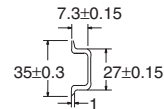
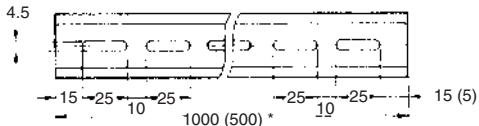
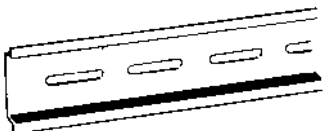

**Note:** The figure in the parentheses is for PFP-50N.

PFP-100N2

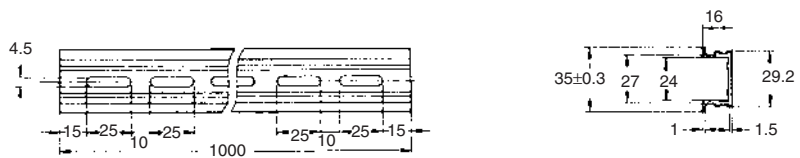
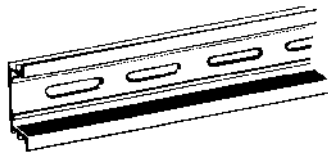

End Plate

PFP-M

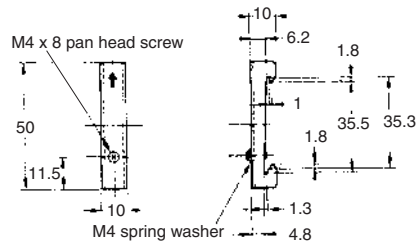
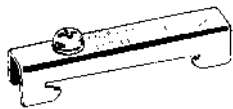

Spacer

PFP-S

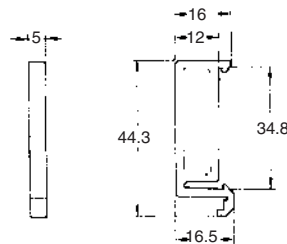
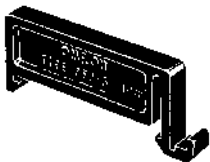

Precautions

Refer to *General Precautions* on page 11 of the *General-purpose Relays and Power Relays Group Catalog (X034)*.

■ Connections

Do not reverse polarity when connecting DC-operated Relays with built-in diodes or indicators or high-sensitivity DC-operated Relays.

■ Mounting

- Whenever possible, mount Relays so that it is not subject to vibration or shock in the same direction as that of contact movement.

**ALL DIMENSIONS SHOWN ARE IN MILLIMETERS.**

To convert millimeters into inches, multiply by 0.03937. To convert grams into ounces, multiply by 0.03527.

Cat. No. J03E-EN-03

In the interest of product improvement, specifications are subject to change without notice.

OMRON EUROPE B.V.

Wegalaan 67-69,  
 NL-2132 JD, Hoofddorp,  
 The Netherlands  
 Phone: +31 23 568 13 00  
 Fax: +31 23 568 13 88  
 industrial.omron.eu



## X-ON Electronics

Largest Supplier of Electrical and Electronic Components

*Click to view similar products for [Relay Sockets & Fixings](#) category:*

*Click to view products by [Omron](#) manufacturer:*

Other Similar products are found below :

[M41G](#) [7-1616360-5](#) [8000-DG2-5](#) [GDA12HA](#) [GDA12HD](#) [GDA12SA](#) [GDA12SD](#) [GDA16HD](#) [GDA22HA](#) [GDA95A](#) [GDA95D](#) [GFX20](#)  
[GUA1](#) [GUA2-11](#) [GUA2-20](#) [GUA4-04](#) [GUA4-31](#) [GUM5R](#) [GUR-120](#) [GUR-24](#) [GUR-240](#) [GUR-277](#) [GURX-277](#) [GUW12](#) [GUW95](#)  
[GUZ32S](#) [GUZ63L](#) [GUZ95L](#) [AS-11](#) [AX-4MS-31](#) [AX-4MS-40](#) [2-1608090-3](#) [PB-16](#) [SM2S-61](#) [SQ9Z-C](#) [SYSWINSMP](#) [AR-12MW](#) [AR-400](#)  
[GDA16HA](#) [GDA16SA](#) [GDA16SD](#) [GDA22HD](#) [GDA22SA](#) [GDA22SD](#) [GDA32HA](#) [GDA32HD](#) [GDA32SA](#) [GDA32SD](#) [GDA63A](#) [GDA63D](#)