

Ceramic Capacitor Solutions

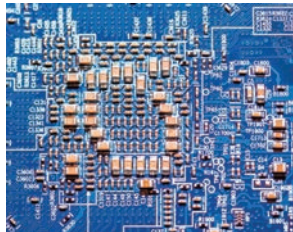

AC Safety Certified

High Voltage SMT

High Capacitance

High Temperature

X2Y[®] Low ESL

LICC Low ESL

SMPS Stacks

High Voltage Radials

Planar Array

Discoidal

CapStrate[®]

Custom Solutions

Your Technology Partner



The mission of the Johanson Companies is to translate our customer needs into quality electronic components, produced in factories that are models of excellence, supported by innovative service. With over 30 years of experience, Johanson Dielectrics provides both standard and custom technology solutions tailored to your specific electronic applications.

Our standard product range includes High Voltage and AC Safety Capacitors providing solutions for Lighting, IT and Business Equipment designs. Our X2Y® Capacitor line provides advanced EMI filtering and IC decoupling solutions and our High Capacitance Tanceram® products provide the highest capacitance values in the smallest cases sizes.

Customized solutions in the areas of High Temperature and High AC power ceramic capacitors are available to customers who require a partnered technology solution.

Johanson Dielectrics design and manufacturing operations are located in Sylmar, California and Zhaoqing, PRC. Our quality minded management system utilizes continuous improvement programs focused on increased product reliability, manufacturing through-put, and product performance. Our broad experience, applications support, and responsive service enhance our ability to drive down your total cost of procurement and speed your time to market.

HIGH FREQUENCY CERAMIC SOLUTIONS

Johanson Technology Inc., Camarillo CA. Products include High Q Capacitors, Ceramic and Wirewound Chip Inductors, and a broad range of LTCC based RF IPCs such as Antennas, Filters, Baluns, Couplers, Matched Filter Baluns, etc.

www.johansontechnology.com



Johanson Dielectrics, Inc. reserves the right to make design and price changes without notice. All sales are subject to the Johanson terms and conditions, including a limited warranty and remedies for non-conforming goods or defective goods. Download the Johanson terms and conditions from our website at <http://www.johansondielectrics.com/purchasing-terms-and-conditions.html>.

INDEX OF PRODUCTS

SURFACE MOUNT CERAMIC CAPACITORS

Ceramic Capacitor Prototyping Kits	4-5
High Voltage Capacitors 250 - 6,000 VDC	6-7
Safety Capacitors 250 VAC, Y2, Y3, Japan Standard	8-9
Low Inductance X2Y [®] Capacitors	10-13
Low Inductance Capacitors	14
Chip Feedthru Filter Capacitors	15
High Temperature - 200°C Capacitors	16-17
High Capacitance Tanceram [®] Capacitors	18-19
SMT Multi-layer Ceramic Capacitors 10 - 200 VDC	20-21

LEADED CERAMIC CAPACITORS

SMPS Stacked Capacitors, 125°C & 200°C versions	22-23
Mini-SMPS Stacked Capacitors	24-25
Maxi-Cap [™] SMPS Capacitors	26-27
X2Y [®] Low ESL SMPS Stacked Capacitors	28-29
Switch-mode Radial Leaded Capacitors	30-31
High Voltage Radial Leaded Capacitors, 125°C, 200°C, 250°C versions	32-33

PLANAR CAPACITORS & CUSTOM CERAMIC SOLUTIONS

Planar Array Capacitors	34-35
CapStrate [®] & Customer Ceramic Solutions	36-37
Part Number, Dielectric, Packaging Specifications	38-39

ON-LINE PRODUCTS

200°C Radial Leaded Capacitors
Tin-Lead Termination Capacitors
Polyterm[®] Termination Capacitors
Large Size MLC Capacitors
High Power AC Capacitors

ON-LINE INFORMATION

Packaging & Marking
Environmental Compliance Policies
Lead-Free Reflow Processing
High Voltage PCB Design
Capacitor Power Handling
X2Y[®] Filter Eval. & PCB Design Guide



CERAMIC CAPACITOR ENGINEERING DESIGN KITS

Johanson Dielectrics, Inc. offers a variety of multi-layer chip capacitor sample kits for proto-type design work. Each kit is grouped by type, size, or voltage and contains a selection of popular values and tolerances. The chips are individually packaged in labeled plastic compartments for easy access. The general range of kit contents is described below. Specific part number details may be found at www.johansondielectrics.com



0402 Ceramic Chip Capacitor Kit					P/N: S-0402	
1400 piece sample assortment of selected values from 1.0pF to 0.22μF						
Chip Size	Voltage Rating	Dielectric	Capacitanc Range	Qty / Value	Total Qty	
0402	50 VDC - 6.3 VDC	NP0, X7R, Y5V	1.0pF to 0.22μF	50 pcs	1400 pcs	

0603 Ceramic Chip Capacitor Kit					P/N: S-0603	
1400 piece sample assortment of selected values from 1.0pF to 0.22μF						
Chip Size	Voltage Rating	Dielectric	Capacitanc Range	Qty / Value	Total Qty	
0603	50 VDC - 16 VDC	NP0, X7R, Y5V	10pF to 0.22μF	50 pcs	1400 pcs	

0805 Ceramic Chip Capacitor Kit					P/N: S-0805	
1400 piece sample assortment of selected values from 1.0pF to 0.47μF						
Chip Size	Voltage Rating	Dielectric	Capacitanc Range	Qty / Value	Total Qty	
0805	100 VDC - 16 VDC	NP0, X7R	10pF to 0.47μF	50 pcs	1400 pcs	

TANCERAM® HIGH CAPACITANCE Ceramic Chip Capacitor Kit					P/N: S-TAN-X5R	
500 piece sample assortment of selected values from 1.0μF to 100μF						
Chip Size	Voltage Rating	Dielectric	Capacitanc Range	Qty / Value	Total Qty	
0402, 0603, 0805 1206, 1210	25 VDC - 6.3 VDC	X5R	1.0μF - 100μF	10 - 25 pcs	500 pcs	

500 VDC Ceramic Chip Capacitor Kit					P/N: S-500	
400 piece sample assortment of selected values from 33pF to 0.1μF						
Chip Size	Voltage Rating	Dielectric	Capacitanc Range	Qty / Value	Total Qty	
0805 - 1812	500 VDC	NP0, X7R	33pF to 0.1μF	10-20 pcs	400 pcs	

1000 VDC Ceramic Chip Capacitor Kit					P/N: S-1KV	
400 piece sample assortment of selected values from 22pF to 0.1μF						
Chip Size	Voltage Rating	Dielectric	Capacitanc Range	Qty / Value	Total Qty	
0805 - 2225	1000 VDC	NP0, X7R	22pF to 0.1μF	10-20 pcs	400 pcs	

*Johanson may from time-time adjust actual kit contents based on design demand trends.
Check the Johanson web site for design kit updates and kit content changes.*



CERAMIC CAPACITOR ENGINEERING DESIGN KITS

2000 VDC Ceramic Chip Capacitor Kit					P/N: S-2KV
300 piece sample assortment of selected values from 22pF to 0.022μF					
Chip Size	Voltage Rating	Dielectric	Capacitanc Range	Qty / Value	Total Qty
1206 - 2225	2000 VDC	NP0, X7R	22pF to 0.022μF	10-20 pcs	300 pcs

X2/Y3 SAFETY CERTIFIED Ceramic Chip Capacitor Kit					P/N: S-SY3
240 piece sample assortment of selected values from 10pF to 1500 pF					
Chip Size	Voltage Rating	Dielectric	Capacitanc Range	Qty / Value	Total Qty
1808	3KV DC / 250 AC	NP0, X7R	10pF to 1500 pF	20 pcs	240 pcs

X1/Y2 SAFETY CERTIFIED Ceramic Chip Capacitor Kit					P/N: S-SY2
200 piece sample assortment of selected values from 10pF to 2200 pF					
Chip Size	Voltage Rating	Dielectric	Capacitanc Range	Qty / Value	Total Qty
1808 - 2220	5KV DC / 250 AC	NP0, X7R	10pF to 2200pF	20 pcs	200 pcs

X2Y [®] EMI FILTER Capacitor Kit - 0402 Size					P/N: S-X07CBK
600 piece sample assortment of selected values from 1.0pF to 0.01μF					
Chip Size	Voltage Rating	Dielectric	Capacitanc Range	Qty / Value	Total Qty
0402	10 - 50 VDC	NP0, X7R	1.0pF to 0.01μF	50 pcs	600 pcs

X2Y [®] EMI FILTER Capacitor Kit - 0603 Size					P/N: S-X14CBK
700 piece sample assortment of selected values from 1.0pF to 0.01μF					
Chip Size	Voltage Rating	Dielectric	Capacitanc Range	Qty / Value	Total Qty
0603	50 - 100 VDC	NP0, X7R	1.0pF to 0.01μF	50 pcs	700 pcs

X2Y [®] POWER BYPASS Capacitor Kit - 0603 Size					P/N: S-X14-PBP
300 piece sample assortment of selected values from 1.0nF to 1.0μF					
Chip Size	Voltage Rating	Dielectric	Capacitanc Range	Qty / Value	Total Qty
0603	6.3 - 100 VDC	X7R, X5R	1.0nF to 1.0μF	20 pcs	300 pcs

X2Y [®] EMI FILTER Capacitor Kit - 0805 Size					P/N: S-X15-EMI
300 piece sample assortment of selected values from 1.0pF to 0.01μF					
Chip Size	Voltage Rating	Dielectric	Capacitanc Range	Qty / Value	Total Qty
0805	50 - 100 VDC	NP0, X7R	1.0pF to 0.01μF	20 pcs	300 pcs

X2Y [®] DC MOTOR FILTER Capacitor Kit					P/N: S-X2Y-MTR
300 piece sample assortment of selected values from 0.10μF to 0.47μF					
Chip Size	Voltage Rating	Dielectric	Capacitanc Range	Qty / Value	Total Qty
1206 - 1812	100 VDC	X7R	0.10μF to 0.47μF	30 pcs	300 pcs

*Johanson may from time-time adjust actual kit contents based on design demand trends.
Check the Johanson web site for design kit updates and kit content changes.*



HIGH VOLTAGE SURFACE MOUNT MLCCs 250 - 6,000 VDC

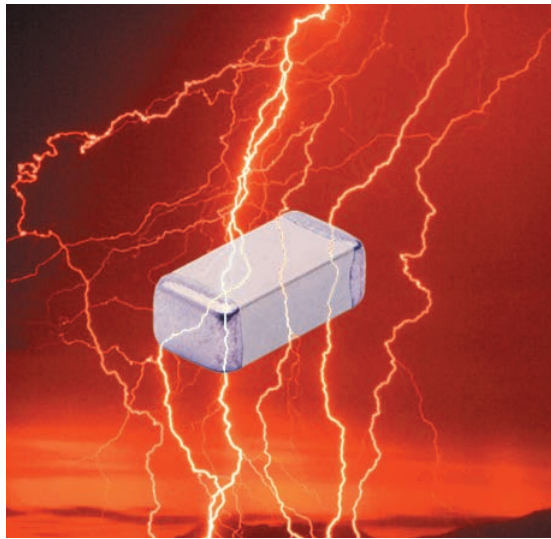

These high voltage capacitors feature a special internal electrode design which reduces voltage concentrations by distributing voltage gradients throughout the entire capacitor.

This unique design also affords increased capacitance values in a given case size and voltage rating. The capacitors are designed and manufactured to the general requirement of EIA198 and are subjected to a 100% electrical testing making them well suited for a wide variety of telecommunication, commercial, and industrial applications.





APPLICATIONS

- Analog & Digital Modems
- LAN/WAN Interface
- Lighting Ballast Circuits
- Voltage Multipliers
- DC-DC Converters
- Back-lighting Inverters

Polyterm® soft termination option for demanding environments & processes available on select parts, please contact the factory.

CASE SIZE

CAPACITANCE SELECTION





JDI / EIA	INCHES	(MM)	RATED VOLTAGE	NP0 DIELECTRIC		X7R DIELECTRIC		
				MINIMUM	MAXIMUM	MINIMUM	MAXIMUM	
R15/0805 	L	.080 ±.010	(2.03 ±.25)	250 VDC	-	-	1000 pF	0.022 µF
	W	.050 ±.010	(1.27 ±.25)	500 VDC	10 pF	680 pF	1000 pF	0.010 µF
	T	.055 Max.	(1.40)	630 VDC	10 pF	560 pF	1000 pF	6800 pF
	E/B	.020 ±.010	(0.51±.25)	1000 VDC	10 pF	390 pF	100 pF	2700 pF
				250 VDC	-	-	1000 pF	0.068 µF
R18/1206 	L	.125 ±.010	(3.17 ±.25)	500 VDC	10 pF	1500 pF	1000 pF	0.033 µF
	W	.062 ±.010	(1.57 ±.25)	630 VDC	10 pF	1200 pF	1000 pF	0.027 µF
	T	.067 Max.	(1.70)	1000 VDC	10 pF	1000 pF	100 pF	0.010 µF
	E/B	.020 ±.010	(0.51±.25)	2000 VDC	10 pF	220 pF	100 pF	4700 pF
				3000 VDC	10 pF	82 pF	100 pF	1000 pF
				250 VDC	-	-	1000 pF	0.150 µF
S41/1210 	L	.125 ±.010	(3.18 ±.25)	500 VDC	10 pF	3900 pF	1000 pF	0.068 µF
	W	.095 ±.010	(2.41 ±.25)	630 VDC	10 pF	2700 pF	1000 pF	0.047 µF
	T	.080 Max.	(2.03)	1000 VDC	10 pF	1800 pF	100 pF	0.015 µF
	E/B	.020 ±.010	(0.51±.25)	2000 VDC	10 pF	560 pF	100 pF	4700 pF
				3000 VDC	10 pF	220 pF	100 pF	1000 pF
				500 VDC	10 pF	4700 pF	1000 pF	0.100 µF
R29/1808 	L	.185 ±.020	(4.70 ±.51)	630 VDC	10 pF	3300 pF	1000 pF	0.047 µF
	W	.080 ±.010	(2.03 ±.25)	1000 VDC	1.0 pF	2200 pF	100 pF	0.022 µF
	T	.085 Max.	(2.16)	2000 VDC	1.0 pF	820 pF	100 pF	0.010 µF
	E/B	.020 ±.010	(0.51±.25)	3000 VDC	1.0 pF	470 pF	100 pF	3300 pF
				4000 VDC	1.0 pF	180 pF	100 pF	1800 pF
				5000 VDC	1.0 pF	75 pF	47 pF	390 pF
				6000 VDC	1.0 pF	75 pF	47 pF	150 pF

Available cap. values include these significant retma values and their multiples: 1.0 1.2 1.5 1.8 2.2 2.7 3.3 3.9 4.7 5.6 6.8 8.2 (1.0 = 1.0, 10, 100, 1000, etc.) Consult factory for non-retma values and sizes or voltages not shown.

HIGH VOLTAGE SURFACE MOUNT MLCCs 250 - 6,000 VDC

CASE SIZE

CAPACITANCE SELECTION

JDI / EIA	INCHES	(MM)	RATED VOLTAGE	NP0 DIELECTRIC		X7R DIELECTRIC						
				MINIMUM	MAXIMUM	MINIMUM	MAXIMUM					
S43 / 1812 	L W T E/B	.177 ±.012 .125 ±.010 .110 Max. .025 ±.015	(4.50 ±.30) (3.17 ±.25) (2.80) (0.64±.38)	250 VDC	-	-	0.010 µF	0.470 µF				
				500 VDC	100 pF	8200 pF	1000 pF	0.330 µF				
				630 VDC	100 pF	6800 pF	1000 pF	0.120 µF				
				1000 VDC	10 pF	5600 pF	1000 pF	0.100 µF				
				2000 VDC	10 pF	1800 pF	100 pF	0.010 µF				
				3000 VDC	10 pF	1000 pF	100 pF	4700 pF				
				4000 VDC	10 pF	390 pF	100 pF	1200 pF				
				5000 VDC	10 pF	150 pF	100 pF	820 pF				
				6000 VDC	10 pF	150 pF	10 pF	330 pF				
				S49 / 1825 	L W T E/B	.180 ±.010 .250 ±.010 .140 Max. .025 ±.015	(4.57 ±.25) (6.35 ±.25) (3.56) (0.64±.38)	500 VDC	100 pF	0.018 µF	0.01 µF	0.390 µF
630 VDC	100 pF	0.015 µF	0.01 µF					0.270 µF				
1000 VDC	10 pF	0.012 µF	1000 pF					0.180 µF				
2000 VDC	10 pF	5600 pF	100 pF					0.039 µF				
3000 VDC	10 pF	2200 pF	100 pF					8200 pF				
4000 VDC	10 pF	1200 pF	100 pF					2200 pF				
5000 VDC	10 pF	390 pF	100 pF					1500 pF				
6000 VDC	10 pF	390 pF	100 pF					820 pF				
S47 / 2220 	L W T E/B	.225 ±.015 .200 ±.015 .150 Max. .025 ±.015	(5.72 ±.38) (5.08 ±.38) (3.81) (0.64±.38)					500 VDC	1000 pF	0.018 µF	0.01 µF	0.470 µF
								630 VDC	1000 pF	0.018 µF	0.01 µF	0.270 µF
				1000 VDC	100 pF	0.015 µF	1000 pF	0.120 µF				
				2000 VDC	100 pF	5600 pF	1000 pF	0.039 µF				
				3000 VDC	10 pF	2700 pF	100 pF	0.010 µF				
				4000 VDC	10 pF	1500 pF	100 pF	2700 pF				
				5000 VDC	10 pF	470 pF	100 pF	1500 pF				
				6000 VDC	10 pF	470 pF	100 pF	820 pF				
				S48 / 2225 	L W T E/B	.225 ±.010 .255 ±.015 .160 Max. .025 ±.015	(5.72 ±.25) (6.48 ±.38) (4.06) (0.64±.38)	500 VDC	1000 pF	0.027 µF	0.01 µF	0.560 µF
								630 VDC	1000 pF	0.022 µF	0.01 µF	0.390 µF
1000 VDC	100 pF	0.018 µF	1000 pF					0.180 µF				
2000 VDC	100 pF	8200 pF	1000 pF					0.056 µF				
3000 VDC	10 pF	3300 pF	100 pF					0.012 µF				
4000 VDC	10 pF	1800 pF	100 pF					3300 pF				
5000 VDC	10 pF	470 pF	100 pF					2700 pF				
6000 VDC	10 pF	470 pF	100 pF					1200 pF				

Available cap. values include these significant retma values and their multiples: 1.0 1.2 1.5 1.8 2.2 2.7 3.3 3.9 4.7 5.6 6.8 8.2 (1.0 = 1.0, 10, 100, 1000, etc.) Consult factory for non-retma values and sizes or voltages not shown.

ELECTRICAL CHARACTERISTICS

Meets the standard NP0 & X7R dielectric specifications listed on page 39

DIELECTRIC WITHSTANDING VOLTAGE DWV = 1.5 X rated WVDC for ratings 500-999 WVDC,
DWV = 1.2 X rated WVDC for ratings ≥ 1,000 WVDC

NOTE: Capacitors may require a surface coating to prevent external arcing. Solder mask should not be used beneath capacitors. For more information see JDI Tech Note "Surface Arc Season"

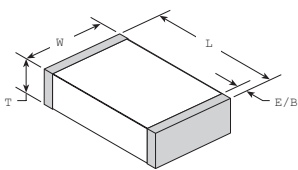

HOW TO ORDER HIGH VOLTAGE SURFACE MOUNT

P/N written: 202R18W102KV4E

202	R18	W	102	K	V	4	E
VOLTAGE	SIZE	DIELECTRIC	CAPACITANCE	TOLERANCE	TERMINATION	MARKING	PACKING
501 = 500 V 631 = 630 V 102 = 1000 V 202 = 2000 V 302 = 3000 V 402 = 4000 V 502 = 5000 V 602 = 6000 V	R15 = 0805 R18 = 1206 R29 = 1808 S41 = 1210 S43 = 1812 S47 = 2220 S48 = 2225 S49 = 1825	N = NP0 W = X7R	1st two digits are significant; third digit denotes number of zeros. 102 = 1000 pF 104 = 0.10 µF	J = ± 5% K = ± 10% M = ± 20%	V = Ni Barrier with 100% Sn Plating (Matte) F = Polyterm flexible termination T = SnPb	4 = Unmarked 6 = EIA Code	E = Embossed 7" T = Punched 7" No code = bulk Tape specs. per EIA RS481



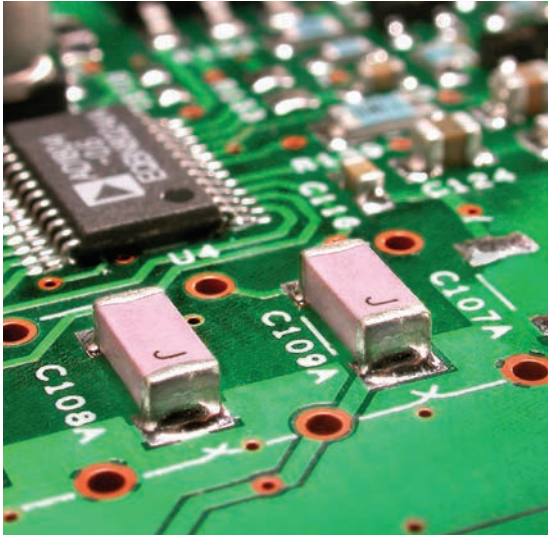

Johanson Dielectrics Type SC ceramic chip capacitors are designed for AC voltage surge and lightning protection in line-to-ground interface applications in computer networks, modem, facsimile and other equipment.

Johanson's safety capacitor offering includes four different case sizes and NP0 and X7R dielectric materials.

These devices are surface mount ready with barrier terminations and tape and reel packaging.

Information on capacitor safety ratings and certification details may be found below.

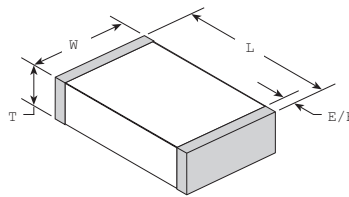





Polyterm® soft termination option for demanding environments & processes available on select parts, please contact the factory.

SAFETY RATING	VOLTAGE RATING	WITHSTANDING VOLTAGE	IMPULSE VOLTAGE	CASE SIZE	JOHANSON ORDERING P/N
X2/Y3	250 VAC	1,500 VAC	2,500 V	1808	302R29____V3E-****-SC
STANDARDS: IEC 60384-14:2005, EN 60950 2001 • UL 60950-01 CERTIFICATIONS: TUV Rheinland R 50227900 • UL File E121609 • Semko 0026092-1 & 0003222-1					
Y3	250 VAC	1,500 VAC	2,500 V	1812	302S43____V3E-****-SC
STANDARDS: IEC 60384-14:2005, EN 60950:2001 CERTIFICATIONS: TUV Rheinland R 50227900					
X1/Y2	250 VAC	1,500 VAC	5,000 V	1808	502R29____V3E-****-SC
STANDARDS: IEC 60384-14:2005 • UL 60950-01 CERTIFICATIONS: TUV Rheinland R 50227900 / UL File E121609					
Y2	250 VAC	1,500 VAC	5,000 V	2211	502R30____V3E-****-SC
STANDARDS: IEC 60384-14:2005 • UL 60950-01 CERTIFICATIONS: TUV Rheinland R 50227900 • UL File: E121609					
X1/Y2	250 VAC	1,500 VAC	5,000 V	2220	502S47____V3E-****-SC
STANDARDS: IEC 60384-14:2005 • UL 60950-01 CERTIFICATIONS: TUV Rheinland R 50227900 • UL File: E121609					

X Capacitors are defined as suitable for use in situations where failure of the capacitor would not lead to danger of electric shock.

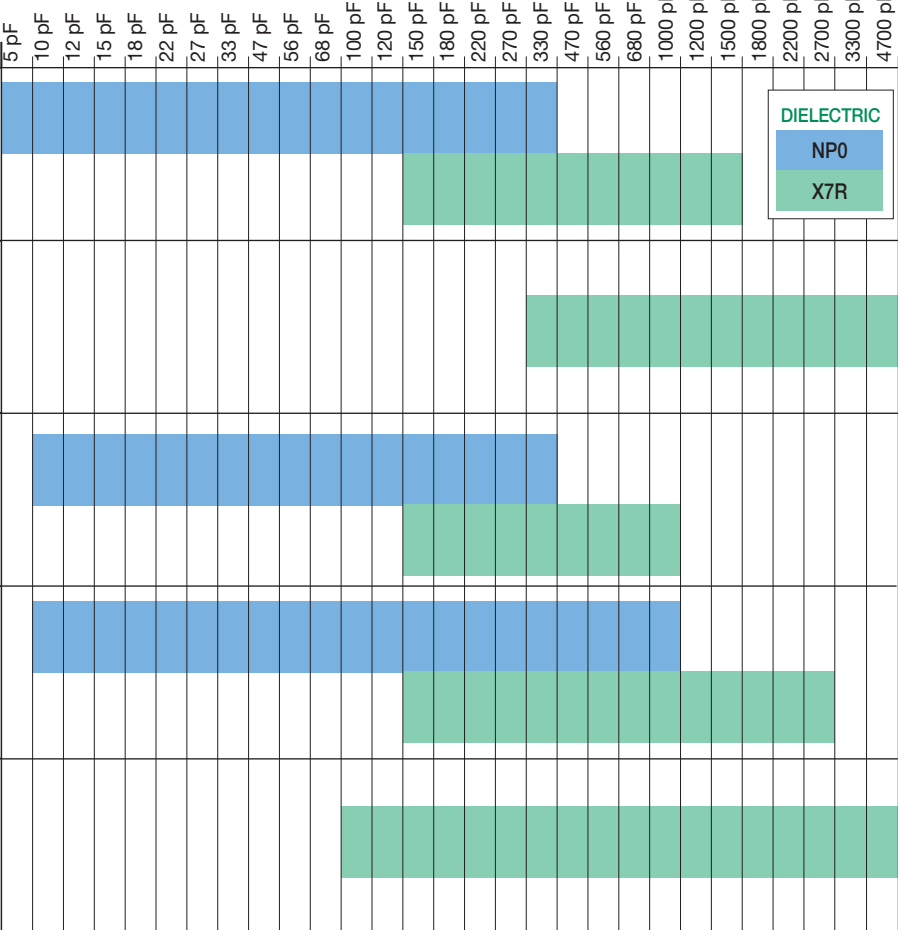
Y Capacitors are defined as suitable for use in situations where failure of the capacitor could lead to danger of electric shock.

SAFETY CERTIFIED

		INCHES	(MM)	5 pF	10 pF	12 pF	15 pF	18 pF	22 pF	27 pF	33 pF	47 pF	56 pF	68 pF	100 pF	120 pF	150 pF	180 pF	220 pF	270 pF	330 pF	470 pF	560 pF	680 pF	1000 pF	1200 pF	1500 pF	1800 pF	2200 pF	2700 pF	3300 pF	4700 pF
R29 / 1808  X2/Y3	L	.185 ±.015	(4.80 ±.38)																			<table border="1"> <tr><th colspan="2">DIELECTRIC</th></tr> <tr><td>NPO</td></tr> <tr><td>X7R</td></tr> </table>		DIELECTRIC		NPO	X7R					
	DIELECTRIC																															
NPO																																
X7R																																
W	.080 ±.010	(2.03 ±.25)																														
T	.085 Max.	(2.16)																														
E/B	.020 ±.010	(0.51±.25)																														
S43 / 1812  Y3	L	.175 ±.010	(4.45 ±.25)																													
	W	.125 ±.010	(3.17 ±.25)																													
T	.115 Max.	(2.92)																														
E/B	.025 ±.015	(0.64±.38)																														
R29 / 1808  X1/Y2	L	.185 ±.015	(4.80 ±.38)																													
	W	.080 ±.015	(2.03 ±.25)																													
T	.085 Max.	(2.16)																														
E/B	.012 ±.015	(0.30±.13)																														
R30 / 2211  Y2	L	.225 ±.016	(5.72 ±.40)																													
	W	.110 ±.010	(2.80 ±.25)																													
T	.115 Max.	(2.92)																														
E/B	.020 ±.010	(0.51±.25)																														
S47 / 2220  X1/Y2	L	.225 ±.015	(5.72 ±.38)																													
	W	.200 ±.015	(5.08 ±.38)																													
T	.150 Max.	(3.81)																														
E/B	.025 ±.015	(0.64±.38)																														

HOW TO ORDER AC SAFETY CAPACITORS

P/N written: 302R29W102MV3E-****-SC

502	R29	W	102	M	V	3	E	-****-SC
VOLTAGE	SIZE	DIELECTRIC	CAPACITANCE	TOLERANCE	TERMINATION	MARKING	PACKING	TYPE
302 = 250VAC [2500V Impulse] 502 = 250VAC [5000V Impulse]	R29=1808 R30=2211 S43=1812 S47=2220 AC2=2220	N = NP0 W = X7R	1st two digits are significant; third digit denotes number of zeros, R = decimal. 102 = 1000 pF 104 = 0.10 µF 5R0 = 5.0pF	J = ± 5% K = ± 10% M = ± 20%	V = NI Barrier with 100% Sn Plating (Matte) F = Polyterm flexible termination	3 = Required Safety Mark	E = Embossed 7" No code = bulk Tape specs. per EIA RS481	SC = Safety Certified



X2Y[®] FILTER & DECOUPLING CAPACITORS

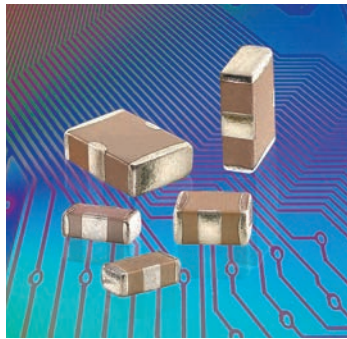

X2Y[®] filter capacitors employ a unique, patented low inductance design featuring two balanced capacitors that are immune to temperature, voltage and aging performance differences. These components offer superior decoupling and EMI filtering performance, virtually eliminate parasitics, and can replace multiple capacitors and inductors saving board space and reducing assembly costs.

ADVANTAGES

- One device for EMI suppression or decoupling
- Replace up to 7 components with one X2Y
- Differential and common mode attenuation
- Matched capacitance line to ground, both lines
- Low inductance due to cancellation effect

APPLICATIONS

- Amplifier Filter & Decoupling
- High Speed Data Filtering
- EMC I/O Filtering
- FPGA / ASIC / μ -P Decoupling
- DDR Memory Decoupling

EMI Filtering (1 Y-Cap.)		<10pF	10pF	22pF	27pF	33pF	47pF	100pF	220pF	470pF	1000pF	1500pF	2200pF	4700pF	.010 μ F	.015 μ F	.022 μ F	.039 μ F	.047 μ F	0.10 μ F	0.18 μ F	0.22 μ F	0.33 μ F	0.40 μ F	0.47 μ F	1.0 μ F	
Power Bypass (2 Y-Caps.)		<20pF	20pF	44pF	54pF	66pF	94pF	200pF	440pF	940pF	2000pF	3000pF	4400pF	9400pF	.020 μ F	.030 μ F	.044 μ F	.078 μ F	.094 μ F	0.20 μ F	0.36 μ F	0.44 μ F	0.68 μ F	0.80 μ F	0.94 μ F	2.0 μ F	
SIZE	CAP. CODE	XR	100	220	270	330	470	101	221	471	102	152	222	472	103	153	223	393	473	104	184	224	334	404	474	105	
0402 (X07)	NP0	50	50	50	50	50	50	50																			
	X7R								50	50	50	50	50	50	16												
0603 (X14)	NP0	100	100	100	100	100	50	50	50																		
	X7R						100	100	100	100	100	100	100	100	50	25	25		16	10		10					
	X5R																					16	10		10	10	
0805 (X15)	NP0		100	100	100	100	100	100	100	50																	
	X7R							100	100	100	100	100	100	100	50	50		50	25	10							
1206 (X18)	NP0										100																
	X7R														100	100	100		100	100		16	16		10		
1210 (X41)	X7R														500				100		100	100		25	16		
1410 (X44)	X7R															500							100				
1812 (X43)	X7R																	500							100		

Contact factory for part combinations not shown.

Filtering capacitance is specified as Line-to-Ground (Terminal A or B to G)

Power Bypass capacitance is specified Power-to-Ground (A + B to G)

Rated voltage is from line to ground in Circuit 1, power to ground in Circuit 2 .

HOW TO ORDER X2Y[®] CAPACITORS

P/N written: 101X14W102MV4T

100	X14	W	102	M	V	4	T
VOLTAGE	SIZE	DIELECTRIC	CAPACITANCE	TOLERANCE	TERMINATION	MARKING	PACKING
6R3 = 6.3 V 100 = 10 V 160 = 16 V 250 = 25 V 500 = 50 V 101 = 100 V 501 = 500 V	X07 = 0402 X14 = 0603 X15 = 0805 X18 = 1206 X41 = 1210 X44 = 1410 X43 = 1812	N = NP0 W = X7R X = X5R	1st two digits are significant; third digit denotes number of zeros, R = decimal. 102 = 1000 pF 104 = 0.10 μ F 5R6 = 5.6pF	M = \pm 20% * D = \pm 0.50 pF *Values < 10 pF only	V = Ni Barrier with 100% Tin Plating (Matte) F = Polyterm flexible termination T = SnPb	4 = Unmarked (Not available)	E = Embossed 7" T = Punched 7" No code = bulk Tape specs. per EIA RS481

X2Y[®] technology patents and registered trademark under license from X2Y ATTENUATORS, LLC



X2Y® FILTER & DECOUPLING CAPACITORS

EMI Filtering S21 Signal-to-Ground

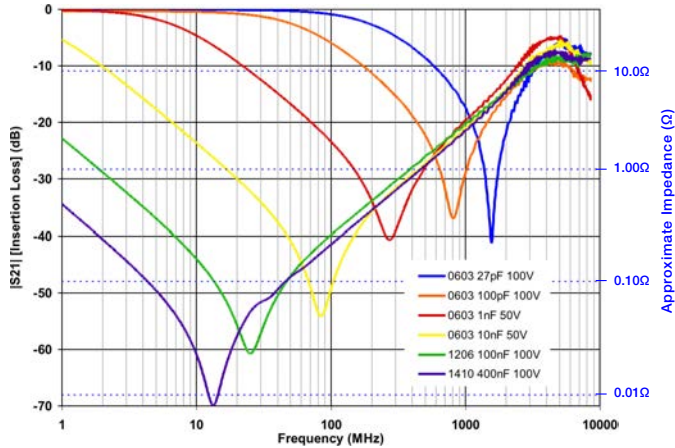
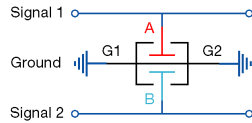

Power Bypass S21 Power-to-Ground

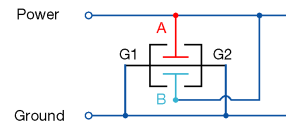

Labeled capacitance values below follow the P/N order code (single Y cap value)
Effective capacitance measured in Circuit 2 is 2X of the labeled single Y cap value.

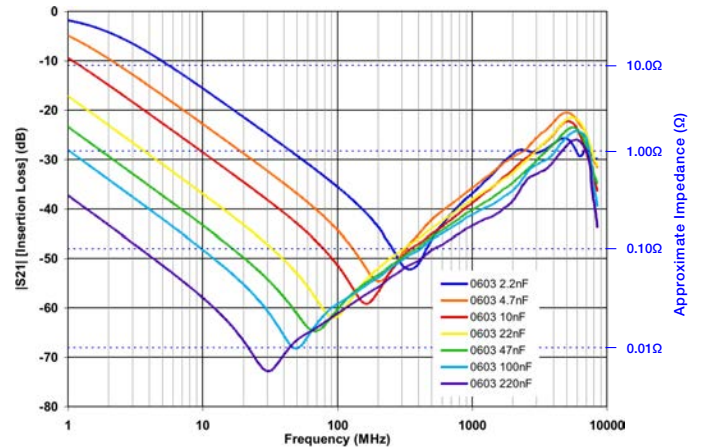

ELECTRICAL CHARACTERISTICS

	NPO	X7R	X5R
TEMPERATURE COEFFICIENT:	0±30ppm/°C (-55 to +125°C)	±15% (-55 to +125°C)	±15% (-55 to +85°C)
DIELECTRIC STRENGTH:	Vrated ≤100VDC: DWV = 2.5 X WVDC, 25°C, 50mA max. Vrated = 500VDC: DWV = 1.5 X WVDC, 25°C, 50mA max.		
DISSIPATION FACTOR:	0.1% max.	WVDC ≥ 50 VDC: 2.5% max. WVDC = 25 VDC: 3.5% max. WVDC = 10-16 VDC: 5.0% max. WVDC = 6.3 VDC: 10% max.	WVDC ≥ 50 VDC: 5% max. WVDC ≤ 25 VDC: 10% max.
INSULATION RESISTANCE (MIN. @ 25°C, WVDC)	C ≤ 0.047μF: 1000 ΩF or 100 GΩ, whichever is less C > 0.047μF: 500 ΩF or 10 GΩ, whichever is less		
TEST CONDITIONS:	C > 100 pF; 1kHz ±50Hz; 1.0±0.2 VRMS C ≤ 100 pF; 1Mhz ±50kHz; 1.0±0.2 VRMS	1.0kHz±50Hz @ 1.0±0.2 Vrms	
OTHER:	See page 39 for additional dielectric specifications.		

Equivalent Circuits

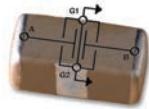
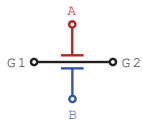

Cross-sectional View

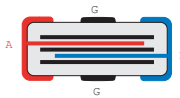

Dimensional View

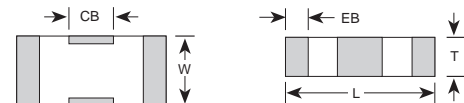

CASE SIZE

	0402 (X07)		0603 (X14)		0805 (X15)		1206 (X18)		1210 (X41)		1410 (X44)		1812 (X43)	
	IN	MM	IN	MM	IN	MM	IN	MM	IN	MM	IN	MM	IN	MM
L	0.045 ± 0.003	1.143 ± 0.076	0.064 ± 0.005	1.626 ± 0.127	0.080 ± 0.008	2.032 ± 0.203	0.124 ± 0.010	3.150 ± 0.254	0.125 ± 0.010	3.175 ± 0.254	0.140 ± 0.010	3.556 ± 0.254	0.174 ± 0.010	4.420 ± 0.254
W	0.025 ± 0.003	0.635 ± 0.076	0.035 ± 0.005	0.889 ± 0.127	0.050 ± 0.008	1.270 ± 0.203	0.063 ± 0.010	1.600 ± 0.254	0.098 ± 0.010	2.489 ± 0.254	0.098 ± 0.010	2.490 ± 0.254	0.125 ± 0.010	3.175 ± 0.254
T	0.020 max	0.508 max	0.026 max	0.660 max	0.040 max	1.016 max	0.050 max	1.270 max	0.070 max	1.778 max	0.070 max	1.778 max	0.090 max	2.286 max
EB	0.008 ± 0.003	0.203 ± 0.076	0.010 ± 0.006	0.254 ± 0.152	0.012 ± 0.008	0.305 ± 0.203	0.016 ± 0.010	0.406 ± 0.254	0.018 ± 0.010	0.457 ± 0.254	0.018 ± 0.010	0.457 ± 0.254	0.022 ± 0.012	0.559 ± 0.305
CB	0.012 ± 0.003	0.305 ± 0.076	0.018 ± 0.004	0.457 ± 0.102	0.022 ± 0.005	0.559 ± 0.127	0.040 ± 0.005	1.016 ± 0.127	0.045 ± 0.005	1.143 ± 0.127	0.045 ± 0.005	1.143 ± 0.127	0.045 ± 0.005	1.143 ± 0.127



X2Y® FILTER & DECOUPLING CAPACITORS

THE X2Y® DESIGN - A BALANCED, LOW ESL, "CAPACITOR CIRCUIT"

The X2Y® capacitor design starts with standard 2 terminal MLC capacitor's opposing electrode sets, A & B, and adds a third electrode set (G) which surround each A & B electrode. The result is a highly versatile three node capacitive circuit containing two tightly matched, low inductance capacitors in a compact, four-terminal SMT chip.

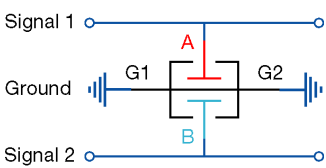
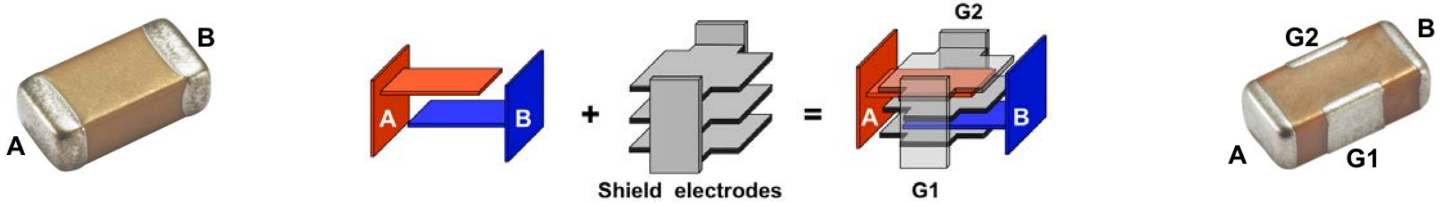

EMI FILTERING:

The X2Y® component contains two shunt or "line-to-ground" Y capacitors. Ultra-low ESL (equivalent series inductance) and tightly matched inductance of these capacitors provides unequalled high frequency Common-Mode noise filtering with low noise mode conversion. X2Y® components reduce EMI emissions far better than unbalanced discrete shunt capacitors or series inductive filters. Differential signal loss is determined by the cut off frequency of the single line-to-ground (Y) capacitor value of an X2Y®.

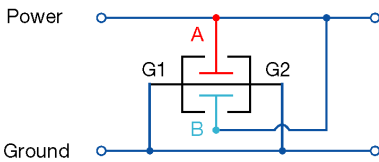

POWER BYPASS / DECOUPLING

For Power Bypass applications, X2Ys® two "Y" capacitors are connected in parallel. This doubles the total capacitance and reduces their mounted inductance by 80% or 1/5th the mounted inductance of similar sized MLC capacitors enabling high-performance bypass networks with far fewer components and vias. Low ESL delivers improved High Frequency performance into the GHz range.

GSM RFI ATTENUATION IN AUDIO & ANALOG

GSM handsets transmit in the 850 and 1850 MHz bands using a TDMA pulse rate of 217Hz. These signals cause the GSM buzz heard in a wide range of audio products from headphones to concert hall PA systems or "silent" signal errors created in medical, industrial process control, and security applications. Testing was conducted where an 840MHz GSM handset signal was delivered to the inputs of three different amplifier test circuit configurations shown below whose outputs were measured on a HF spectrum analyzer.

- 1) No input filter, 2 discrete MLC 100nF power bypass caps.
- 2) 2 discrete MLC 1nF input filter, 2 discrete MLC 100nF power bypass caps.
- 3) A single X2Y 1nF input filter, a single X2Y 100nF power bypass cap.

X2Y configuration provided a nearly flat response above the ambient and up to 10 dB improved rejection than the conventional MLCC configuration.

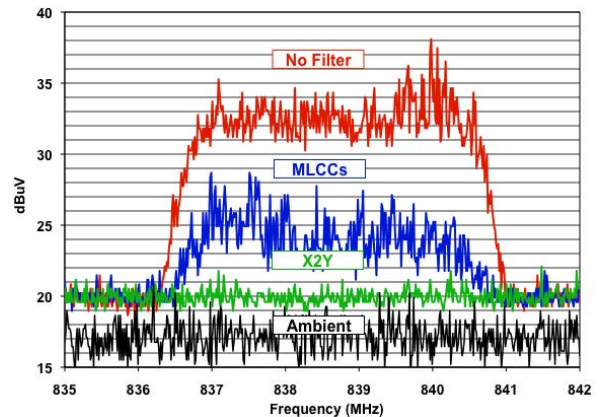

AMPLIFIER INPUT FILTER EXAMPLE

In this example, a single Johanson X2Y® component was used to filter noise at the input of a DC instrumentation amplifier. This reduced component count by 3-to-1 and costs by over 70% vs. conventional filter components that included 1% film Y-capacitors.

Parameter	X2Y® 10nF	Discrete 10nF, 2 @ 220 pF	Comments
DC offset shift	< 0.1 μ V	< 0.1 μ V	Referred to input
Common mode rejection	91 dB	92 dB	

Source: Analog Devices, "A Designer's Guide to Instrumentation Amplifiers (2nd Edition)" by Charles Kitchin and Lew Counts

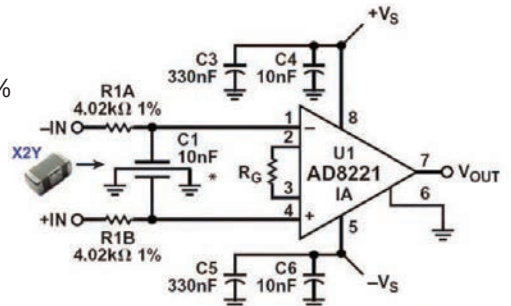

X2Y[®] FILTER & DECOUPLING CAPACITORS

COMMON MODE CHOKE REPLACEMENT

- Superior High Frequency Emissions Reduction
 - Smaller Sizes, Lighter Weight
 - No Current Limitation
 - Vibration Resistant
 - No Saturation Concerns
- See our website for a detailed application note with component test comparisons and circuit emissions measurements.

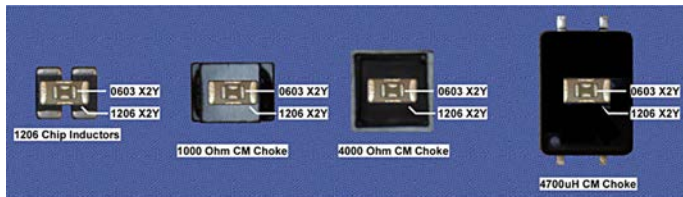

Measured Common Mode Rejection

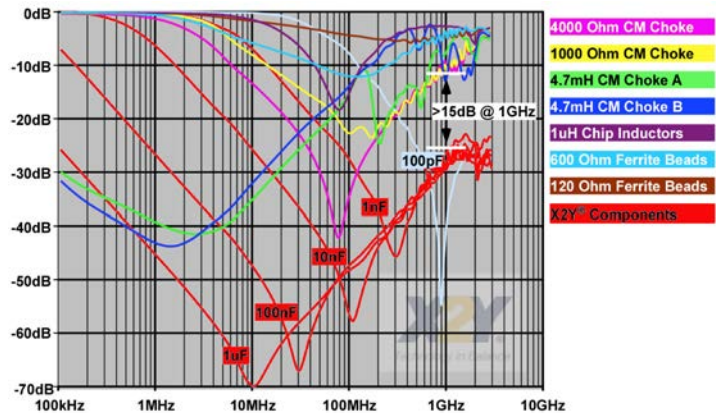

PARALLEL CAPACITOR SOLUTION

A common design practice is to parallel decade capacitance values to extend the high frequency performance of the filter network. This causes an unintended and often over-looked effect of anti-resonant peaks in the filter networks combined impedance. X2Y's very low mounted inductance allows designers to use a single, higher value part and completely avoid the anti-resonance problem. The impedance graph on right shows the combined impedance of a 1nF, 10nF & 100nF MLC in parallel in RED. The MLC networks anti-resonance peaks are nearly 10 times the desired impedance. A 100nF and 47nF X2Y are plotted in BLUE and GREEN. (The total capacitance of X2Y (Circuit 2) is twice the value, or 200nF and 98nF in this example.) The single X2Y is clearly superior to the three paralleled MLCs.

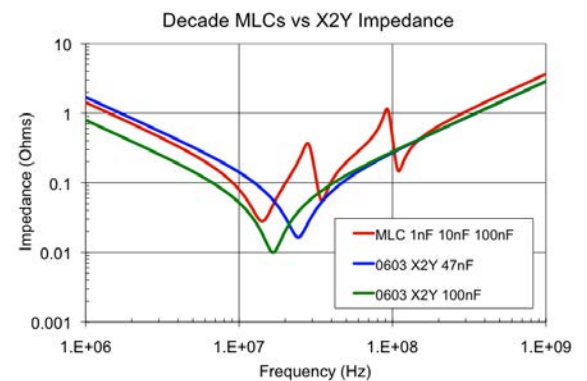

X2Y HIGH PERFORMANCE POWER BYPASS - IMPROVE PERFORMANCE, REDUCE SPACE & VIAS

Actual measured performance of two high performance SerDes FPGA designs demonstrate how a 13 component X2Y bypass network significantly out performs a 38 component MLC network. For more information see http://johansondielectrics.com/pdfs/JDI_X2Y_STXII.pdf

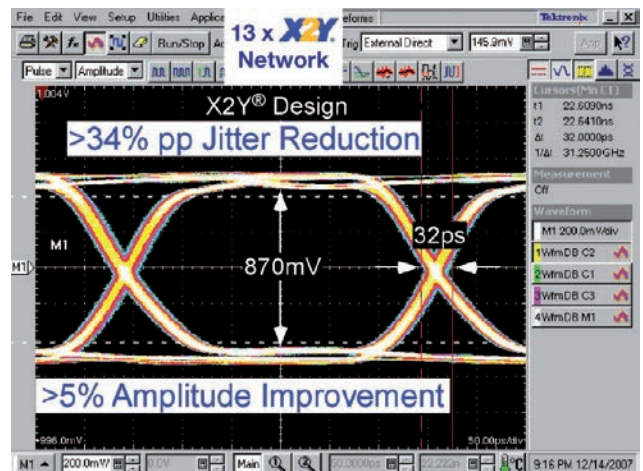
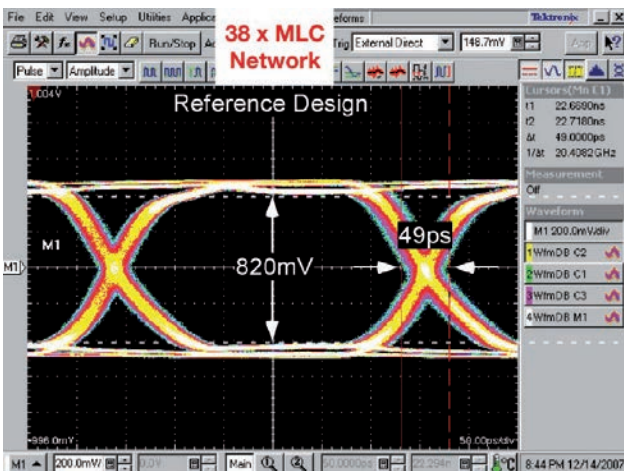
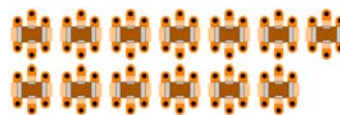
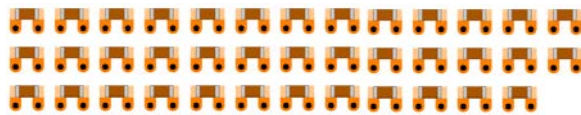

LOW INDUCTANCE CHIP CAPACITORS (LICC)

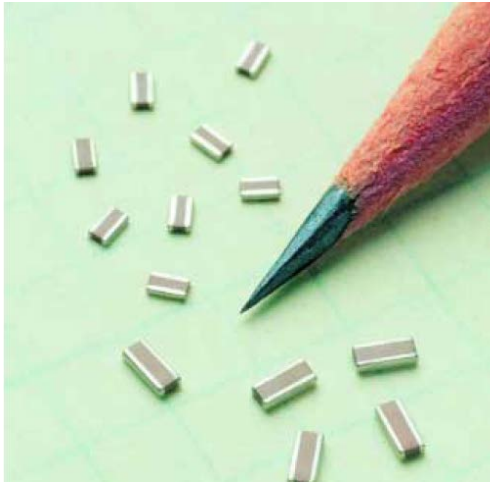

LICC capacitors are specially designed to exhibit lower inductance by altering the aspect ratio of the terminations. The smaller current loop length results in Equivalent Series Inductance (ESL) that is typically 60% lower than standard MLCs of the same size. This ESL improvement is extremely advantageous in the high frequency power decoupling of high speed digital MPU, FPGA, DSP, etc..

FEATURES

- Low Inductance
- High Series Resonant Frequency
- Sn-Pb and Polyterm® Termination Options
- Surface Mount
- Small Size
- RoHS Compliant

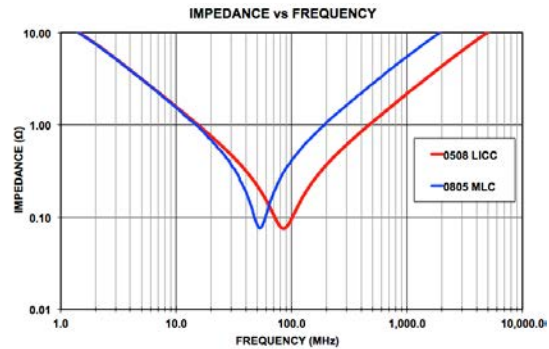
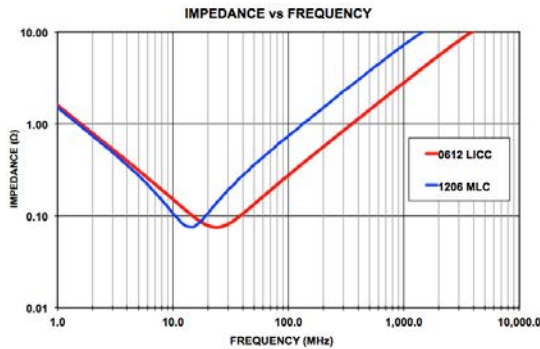
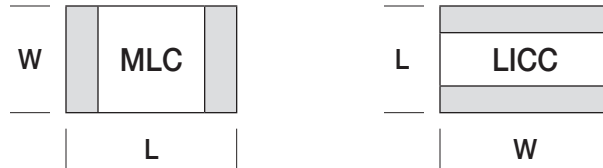

CASE SIZE

AVAILABLE CAPACITANCE

JDI	EIA	MM	DIELECTRIC	10nF	22nF	47nF	0.10uF	0.22uF	0.47uF	1.00uF	2.2uF	4.7uF	10uF
B14	0306	0816	X7R	25V	25V	25V	16V	6.3V					
			X5R				10V	10V	6.3V	6.3V	6.3V		
B15	0508	1220	X7R	50V	50V	25V	25V	16V	6.3V	6.3V			
			X5R						10V	10V	6.3V		
B18	0612	1632	X7R	50V	50V	50V	50V	25V	16V	6.3V			
			X5R								10V	10V	6.3V

Please visit our website for complete specifications

HOW TO ORDER LICC CAPACITORS

P/N written: 101X14W102MV4T

100

VOLTAGE
 6R3 = 6.3 V
 100 = 10 V
 160 = 16 V
 250 = 25 V
 500 = 50 V

B14

SIZE
 B14 = 0306
 B15 = 0508
 B18 = 0612

X

DIELECTRIC
 W = X7R
 X = X5R

224

CAPACITANCE
 1st two digits are significant; third digit denotes number of zeros
 103 = 0.01 µF (10NF)
 104 = 0.10 µF

M

TOLERANCE
 M = ± 20%
 *Values < 10 pF only

V

TERMINATION
 V = NI Barrier with 100% Tin Plating (Matte)
 T = SnPb

4

MARKING
 4 = Unmarked (Not available)

T

PACKING
 E = Embossed 7"
 T = Punched 7"
 No code = bulk
 Tape specs. per EIA RS481



CHIP FILTER / FEED-THRU CAPACITORS



Our Feed-Thru Capacitors provide excellent EMI, I/O & Power Line filtering exhibiting much lower inductance than standard SMT capacitors which results in broader frequency response. These are Precious Metal Electrode (PME) products with higher current ratings than comparable Base Metal Electrode (BME) parts.

FEATURES

- 1 Amp Current Rating
- Low Inductance, High SRF
- Surface Mount Non-polarized
- Sn-Pb and Polyterm® Options

APPLICATIONS

- DC Power Line EMI Filter
- RF Immunity Filter
- RF Amplifier Gain Filter

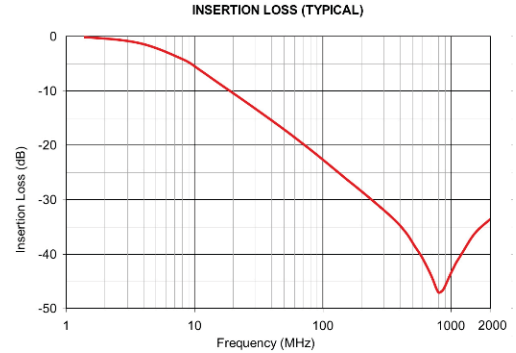
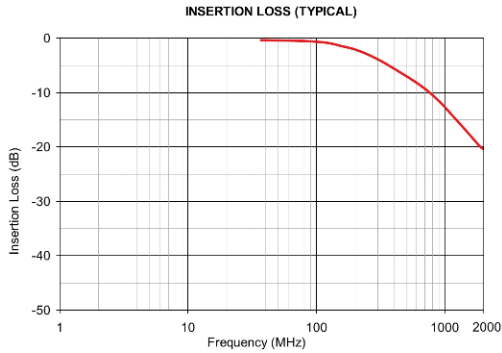
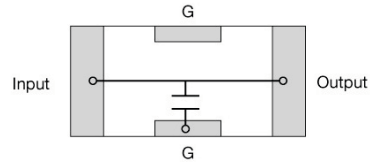

CASE SIZE

AVAILABLE CAPACITANCE

JDI	EIA	MM	DIELECTRIC	22pF	47pF	100pF	220pF	470pF	1.0nF	2.2nF	4.7nF	10nF	22nF	47nF	100nF	220nF
F14	0603	1608	NP0	50V	50V	50V	50V									
			X7R					25V	25V	25V	25V	25V	25V	25V		
F15	0805	2012	NP0	50V	50V	50V	50V	50V								
			X7R						50V	50V	50V	50V	50V	50V	50V	
F18	1206	3216	NP0	100V	100V	100V	100V	100V	100V							
			X7R								50V	50V	50V	50V	50V	50V

Please visit our website for complete specifications

HOW TO ORDER CHIP FILTER / FEED-THRU

P/N written: 250F14W103YV4E

250	F14	W	103	Y	V	4	E
VOLTAGE	SIZE	DIELECTRIC	CAPACITANCE	TOLERANCE	TERMINATION	MARKING	PACKING
250 = 25 V 500 = 50 V 101 = 100 V 201 = 200 V	F14 = 0603 F15 = 0805 F18 = 1206	N = NP0 W = X7R	1st two digits are significant; third digit denotes number of zeros. 102 = 1000 pF 103 = 0.01 μF 104 = 0.10 μF	K = ± 10% M = ± 20% Y = + 50% -20%	V = Ni Barrier w/ 100% Sn Plating (150°C) T = Ni Barrier w/ 95%Sn/5%Pb Plating (150°C)	4 = Unmarked (Not available)	E = Embossed 7" T = Punched 7" No code = bulk Tape specs. per EIA RS481



HIGH TEMPERATURE SURFACE MOUNT MLCCs 200°C



Johanson's high temperature MLCC series exhibit stable performance across an extended operating temperature range of -55°C to +200°C. Both Class I and Class II parts are available with DC voltage ratings of 50, 100 and 200V satisfying a wide range of demanding applications.

FEATURES

- Stable 200°C Operation
- Compact SMD Chip
- Polyterm® Termination Option
- Sn-Pb Termination Option

APPLICATIONS

- Deep Hole Drilling Electronics
- High Temperature Modules
- Industrial Equipment
- Automotive • Avionics

ELECTRICAL CHARACTERISTICS

	NP0	X7R
OPERATING RANGE:	-55 to +200°C	-55 to +200°C
TEMPERATURE COEFFICIENT:	0±30ppm/°C (-55to+125°C)	0±15% (-55to+125°C)
200°C CAP. DROP:	-0.5% max.	-45% max.
DISSIPATION FACTOR:	0.001 (0.1%) max.	0.020 (2.0%) max.
AGING RATE:	None	<1.0% per decade
INSULATION RESISTANCE:	25°C IR >100GΩ or 1000ΩF (whichever is less) 200°C IR >1ΩF or 100MΩ	
WITHSTANDING VOLTAGE:	2.5 X WVDC for ratings ≤ 200 VDC 1.5 X WVDC for ratings 201-500 VDC	
TEST CONDITIONS:	C > 100 pF; 1kHz ±50Hz; 1.0±0.2 VRMS C ≤ 100 pF; 1Mhz ±50kHz; 1.0±0.2 VRMS	

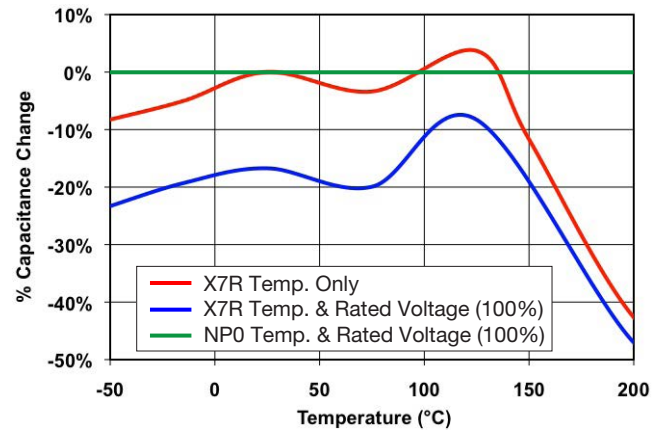





MECHANICAL CHARACTERISTICS

			RATED VOLTAGE	NP0 DIELECTRIC		X7R DIELECTRIC	
				MINIMUM	MAXIMUM	MINIMUM	MAXIMUM
T07/0402	L	Inches (mm)	25 VDC	10 pF	270 pF	100 pF	4700 pF
	W	.040 ±.004 (1.02 ±.10)	50 VDC	10 pF	120 pF	100 pF	1500 pF
	T	.020 ±.004 (0.51 ±.10)	100 VDC	10 pF	82 pF	10 pF	390 pF
	E/B	.025 Max. (0.64)	200 VDC	10 pF	50 pF	10 pF	100 pF
		.008±.004 (.20±.10)					
T14/0603	L	Inches (mm)	25 VDC	10 pF	820 pF	1000 pF	0.022 μF
	W	.063 ±.008 (1.60 ±.20)	50 VDC	10 pF	330 pF	1000 pF	0.010 μF
	T	.032 ±.008 (0.81 ±.20)	100 VDC	10 pF	220 pF	100 pF	2200 pF
	E/B	.035 Max. (0.89)	200 VDC	10 pF	120 pF	100 pF	560 pF
		.010±.005 (.25±.13)					
T15/0805	L	Inches (mm)	25 VDC	100 pF	2200 pF	1000 pF	0.100 μF
	W	.080 ±.010 (2.03 ±.25)	50 VDC	100 pF	1500 pF	1000 pF	0.033 μF
	T	.050 ±.010 (1.27 ±.25)	100 VDC	100 pF	1000 pF	1000 pF	0.010 μF
	E/B	.055 Max. (1.40)	200 VDC	10 pF	680 pF	100 pF	2200 pF
		.020±.010 (0.51±.25)					

HIGH TEMPERATURE SURFACE MOUNT MLCCs 200°C

MECHANICAL CHARACTERISTICS

				RATED VOLTAGE		NP0 DIELECTRIC		X7R DIELECTRIC	
				MINIMUM	MAXIMUM	MINIMUM	MAXIMUM		
T18/1206 		Inches	(mm)	25 VDC	100 pF	6800 pF	1000 pF	0.220 μF	
	L	.125 ±.010	(3.17 ±.25)	50 VDC	100 pF	3300 pF	1000 pF	0.100 μF	
	W	.062 ±.010	(1.57 ±.25)	100 VDC	100 pF	2200 pF	1000 pF	0.022 μF	
	T	.067 Max.	(1.70)	200 VDC	100 pF	1500 pF	1000 pF	5600 pF	
	E/B	.020±.010	(0.51±.25)						
T41/1210 		Inches	(mm)	25 VDC	1000 pF	0.015 μF	0.047 μF	0.470 μF	
	L	.125 ±.010	(3.18 ±.25)	50 VDC	1000 pF	5600 pF	0.047 μF	0.220 μF	
	W	.095 ±.010	(2.41 ±.25)	100 VDC	100 pF	4700 pF	0.047 μF	0.056 μF	
	T	.090 Max.	(2.03)	200 VDC	100 pF	3300 pF	0.047 μF	0.015 μF	
	E/B	.020±.010	(0.51±.25)						
T43/1812 		Inches	(mm)	25 VDC	1000 pF	0.033 μF	0.047 μF	1.000 μF	
	L	.175 ±.010	(4.45 ±.25)	50 VDC	1000 pF	0.012 μF	0.047 μF	0.470 μF	
	W	.125 ±.010	(3.17 ±.25)	100 VDC	1000 pF	0.010 μF	0.047 μF	0.180 μF	
	T	.110 Max.	(2.80)	200 VDC	1000 pF	8200 pF	0.047 μF	0.047 μF	
	E/B	.025±.015	(0.64±.38)						
T49/1825 		Inches	(mm)	25 VDC	1000 pF	0.033 μF	0.10 μF	2.200 μF	
	L	.180 ±.010	(4.57 ±.25)	50 VDC	1000 pF	0.027 μF	0.10 μF	1.000 μF	
	W	.250 ±.010	(6.35 ±.25)	100 VDC	1000 pF	0.022 μF	0.10 μF	0.560 μF	
	T	.140 Max.	(3.56)	200 VDC	1000 pF	0.018 μF	0.10 μF	0.150 μF	
	E/B	.025±.015	(0.64±.38)						
T48/2225 		Inches	(mm)	25 VDC	1000 pF	0.100 μF	0.10 μF	3.300 μF	
	L	.225 ±.010	(5.72 ±.25)	50 VDC	1000 pF	0.039 μF	0.10 μF	1.500 μF	
	W	.255 ±.015	(6.48 ±.38)	100 VDC	1000 pF	0.033 μF	0.10 μF	0.820 μF	
	T	.160 Max.	(4.06)	200 VDC	1000 pF	0.022 μF	0.10 μF	0.220 μF	
	E/B	.025±.015	(0.64±.38)						

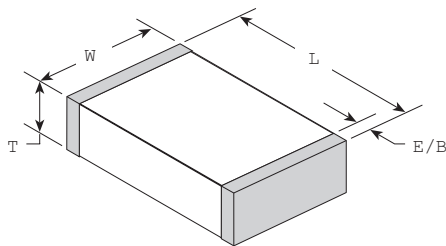

HOW TO ORDER 200°C MLCCs

P/N written: 500T14W103KV4E

500	T14	W	103	K	V	4	E
VOLTAGE	SIZE	DIELECTRIC	CAPACITANCE	TOLERANCE	TERMINATION	MARKING	PACKING
250 = 25 V 500 = 50 V 101 = 100 V 201 = 200 V	T07 = 0402 T14 = 0603 T15 = 0805 T18 = 1206 T41 = 1210 T43 = 1812 T49 = 1825 T48 = 2225	N = NP0 W = X7R	1st two digits are significant; third digit denotes number of zeros. 102 = 1000 pF 103 = 0.01 μF 104 = 0.10 μF	NP0 J = ± 5% K = ± 10% X7R K = ± 10% M = ± 20%	V = Ni Barrier w/ 100% Sn Plating (150°C) T = Ni Barrier w/ 95%Sn/5%Pb Plating (150°C) E = Ni Barrier w/ 100% Sn Plating (180°C) P = Palladium Silver Pd-Ag (250°C)	4 = Unmarked (Not available)	E = Embossed 7" T = Punched 7" No code = bulk Tape specs. per EIA RS481



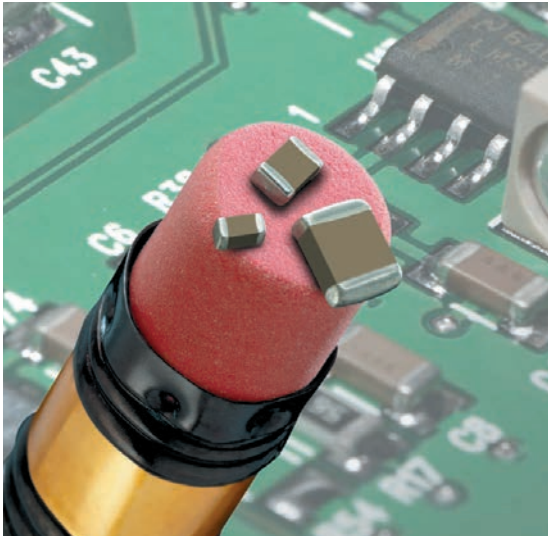

TANCERAM® chip capacitors can replace tantalum capacitors in many applications and offer several key advantages over traditional tantalums. Because TANCERAM® capacitors exhibit extremely low ESR, equivalent circuit performance can often be achieved using considerably lower capacitance values. Low DC leakage reduces current drain, extending the battery life of portable products. TANCERAM® high DC breakdown voltage ratings offer improved reliability and eliminate large voltage de-rating common when designing with tantalums.

ADVANTAGES

- Low ESR
- Higher Surge Voltage
- Reduced CHIP Size
- Higher Insulation Resistance
- Low DC Leakage
- Non-polarized Devices
- Improved Reliability
- Higher Ripple Current

APPLICATIONS

- Switching Power Supply Smoothing (Input/Output)
- DC/DC Converter Smoothing (Input/Output)
- Backlighting Inverters
- General Digital Circuits

Typical ESR Comparison

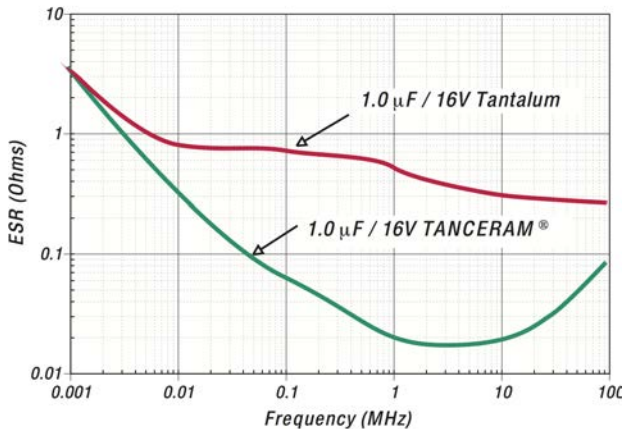

Typical Breakdown Voltage Comparison

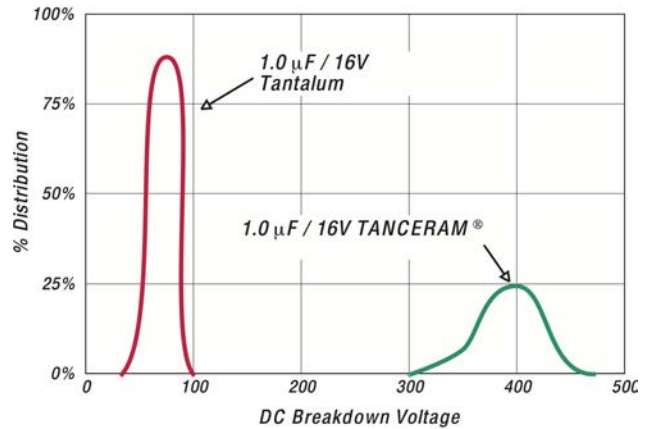

HOW TO ORDER TANCERAM®

Part number written: 100R15X106MV4E

100	R15	X	106	M	V	4	E
VOLTAGE	SIZE	DIELECTRIC	CAPACITANCE	TOLERANCE	TERMINATION	MARKING	PACKING
6R3 = 6.3 V 100 = 10 V 160 = 16 V 250 = 25 V 500 = 50 V 101 = 100 V	See Chart	W = X7R X = X5R	1st two digits are significant; third digit denotes number of zeros. 105 = 1.00 µF 476 = 47.0 µF 107 = 100 µF	K = ±10% M = ±20%	V = Nickel Barrier with 100% Tin Plating (Matte) T = SnPb* (*available on select parts)	4 = Unmarked	Code Type Reel E Plastic 7" T Paper 7" Tape specifications conform to EIA RS481

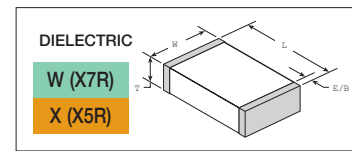

CASE SIZE

CAPACITANCE SELECTION

EIA / JDI	INCHES	(mm)	VDC	1.0 μF	2.2 μF	3.3 μF	4.7 μF	10 μF	22 μF	47 μF	100 μF
0402 R07	L	.040 ±.004	(1.02 ±.10)								
	W	.020 ±.004	(0.51 ±.10)								
	T	.025 Max.	(0.64)								
	EB	.008 ±.004	(0.20±.10)								
0603 R14	L	.063 ±.008	(1.60 ±.20)								
	W	.032 ±.008	(0.81 ±.20)								
	T	.035 Max.	(0.89)								
	EB	.010±.005	(.25±.13)								
0805 R15	L	.080 ±.010	(2.03 ±.25)								
	W	.050 ±.010	(1.27 ±.25)								
	T	.060 Max.	(1.52)								
	EB	.020±.010	(0.51±.25)								
1206 R18	L	.125 ±.013	(3.17 ±.35)								
	W	.062 ±.010	(1.57 ±.25)								
	T	.070 Max.	(1.78)								
	EB	.020 +.015-.010	(0.51+.38-.25)								
				100							
				50							
1210 S41	L	.126 ±.016	(3.20 ±.40)								
	W	.098 ±.012	(2.50 ±.30)								
	T	.110 Max.	(2.8)								
	EB	.020 +.015-.010	(0.51+.38-.25)								
				100							
				50							
1812 S43	L	.177 ±.016	(4.50 ±.40)								
	W	.126 ±.015	(3.20 ±.38)								
	T	.140 Max.	(3.55)								
	EB	.035 ±.020	(0.89 ±0.51)								
				100							
			50								
			25								
			16								
			10								
			6.3								
				W	X	W	X	W	X	W	X

ELECTRICAL CHARACTERISTICS

DIELECTRIC:	X7R	X5R
TEMPERATURE COEFFICIENT:	±15% (-55 to +125°C)	±15% (-55 to +85°C)
DISSIPATION FACTOR:	For ≥ 50 VDC: 5% max. For ≤ 35 VDC: 10% max.	For ≥ 50 VDC: 5% max. For ≤ 35 VDC: 10% max.
INSULATION RESISTANCE (MIN. @ 25°C, WVDC)	100 ΩF or 10 GΩ, whichever is less	
DIELECTRIC STRENGTH:	2.5 X WVDC, 25°C, 50mA max.	
TEST CONDITIONS:	Capacitance values ≤ 10 μF: 1.0kHz±50Hz @ 1.0±0.2 Vrms Capacitance values > 10 μF: 120Hz±10Hz @ 0.5V±0.1 Vrms	
OTHER:	See page 39 for additional dielectric specifications.	

SURFACE MOUNT MLCCs 10 - 200 VDC

CASE SIZE			Voltage	AVAILABLE CAPACITANCE CODE																									
JDI	Inches	(mm)		0R5	XR5	100	120	150	180	220	270	330	390	470	560	680	820	101	121	151	181	221	271	331	391	471	561	681	821
R05	0201	(0603) L .024 ±.001 W .012 ±.001 T .012 ±.001 EB .006 ±.002 (0.60 ±.03) (0.30 ±.03) (0.30 ±.03) (0.15±.05)	25V	█											█							█							
			16V	█											█							█							
			10V	█											█							█							
				█											█							█							
R07	0402	(1005) L .040 ±.004 W .020 ±.004 T .025 Max. EB .008 ±.004 (1.02 ±.10) (0.51 ±.10) (0.64) (0.20±.10)	50V	█											█							█							
			25V	█											█							█							
			16V	█											█							█							
			10V	█											█							█							
R14	0603	(1608) L .063 ±.008 W .032 ±.008 T .035 Max. EB .010±.005 (1.60 ±.20) (0.81 ±.20) (0.89) (.25±.13)	200V	█											█							█							
			100V	█											█							█							
			50V	█											█							█							
			25V	█											█							█							
			16V	█											█							█							
R15	0805	(2012) L .080 ±.010 W .050 ±.010 T .050 Max. EB .020±.010 (2.03 ±.25) (1.27 ±.25) (1.27) (0.51±.25)	200V	█											█							█							
			100V	█											█							█							
			50V	█											█							█							
			25V	█											█							█							
			16V	█											█							█							
R18	1206	(3216) L .125 ±.010 W .062 ±.010 T .050 Max. EB .020 ±.010 (3.17 ±.25) (1.57 ±.25) (1.27) (0.51 ±.25)	200V	█																									
			100V	█																									
			50V	█																									
			25V	█																									
S41	1210	(3224) L .125 ±.010 W .095 ±.010 T .065 Max. EB .020 ±.010 (3.18 ±.25) (2.41 ±.25) (1.65) (0.51 ±.25)	200V	█											█							█							
			100V	█											█							█							
			50V	█											█							█							
			25V	█											█							█							
			16V	█											█							█							
S43	1812	(4532) L .175 ±.010 W .125 ±.010 T .085 Max. EB .025 ±.015 (4.45 ±.25) (3.17 ±.25) (2.16) (0.64 ±.38)	200V	█											█							█							
			100V	█											█							█							
			50V	█											█							█							
			25V	█											█							█							

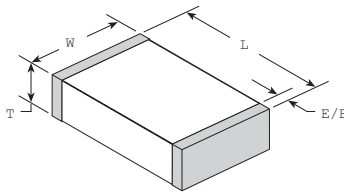

NP0
X7R
X5R

How To ORDER - SURFACE MOUNT MLCC

Part number written: 100R07W104KV4E

100	R 07	W	104	K	V	4	E
VOLTAGE	SERIES/SIZE	DIELECTRIC	CAPACITANCE	TOLERANCE	TERMINATION	MARKING	PACKING
100 = 10 V DC 160 = 16 V DC 250 = 25 V DC 500 = 50 V DC 101 = 100 V DC 201 = 200 V DC	R05 = 0201 R07 = 0402 R14 = 0603 R15 = 0805 R18 = 1206 S41 = 1210 S43 = 1812	N = NP0 W = X7R X = X5R	1st two digits are significant; third digit denotes number of zeros, R = decimal. 5R6 = 5.6 pF 100 = 10 pF 102 = 1,000 pF 474 = 0.47 μF	* B = ± 0.10 pF * C = ± 0.25 pF * D = ± 0.50 pF F = ± 1 % G = ± 2 % J = ± 5 % K = ± 10 % M = ± 20 % *Values < 10 pF only	V = Nickel Barrier with 100% Tin Plating (Matte) T = SnPb	3 = Special 4 = Unmarked 6 = EIA Code* *Not available on sizes ≤ 0402	E = Embossed 7" T = Punched 7" U = Embossed 13" R = Punched 13" No code = bulk Tape specifications on page 48. Not all tape styles are available on all parts.



STACKED SMPS CERAMIC CAPACITORS

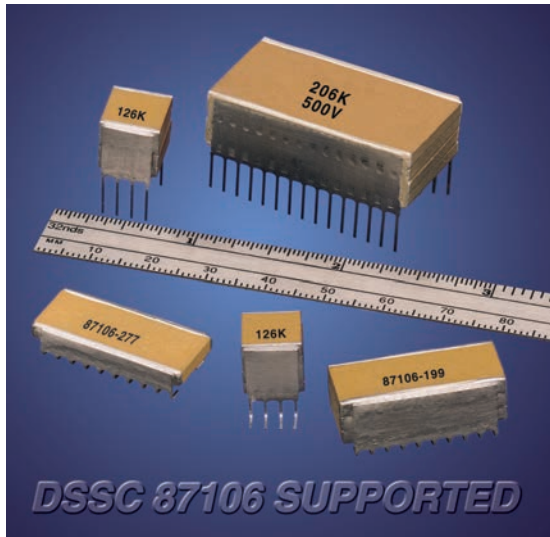

Stacked Switch-Mode ceramic capacitors feature large capacitance values and exhibit low ESR (equivalent series resistance) and low ESL (equivalent series inductance) making them well suited for high power and high frequency applications where tantalum or aluminum electrolytic capacitors may not be suitable. The P-Series feature mechanical and pin-out configurations per DSCC 87106 and 88011 drawings while the E-Series feature mechanical and pin-out configurations more common in European design applications.

KEY FEATURES

- P-Series Approved to DSCC Drawings 87106 & 88011 MIL-PRF-49470
- New T-Series 200°C for downhole tools and aircraft engine control applications.
- E-Series Common European Lead Styles available to MIL-PRF-49470 requirements.
- NP0 & X7R Dielectrics, 50 to 500 VDC Ratings
- Low ESR / Low ESL, Ideal for SMPS Filtering Applications
- Custom Sizes, Voltages, and Values Available

CASE SIZE

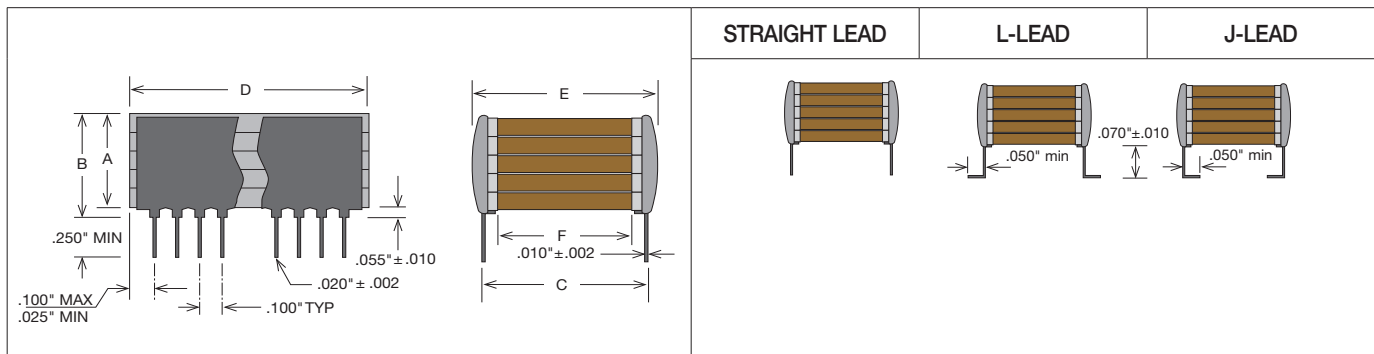

HOW TO ORDER STACKED SMPS

Part number written: 201P03W275KJ4H

201	P03	W	275	K	J	4	H
VOLTAGE	SIZE	DIELECTRIC	CAPACITANCE	TOLERANCE	TERMINATION	MARKING	PACKING
500 = 50 V 101 = 100 V 201 = 200 V 501 = 500 V	See Chart	N = NP0 B = BX W = X7R	1st two digits are significant; third digit denotes number of zeros. 101 = 100 pF 102 = 1000 pF 103 = 0.01 μF 105 = 1.00 μF	J = ±5% K = ±10% L = ±15% M = ±20% N = ±30% Z = +80% -20% P = +100% -0%	J = "J" Leads (formed in) K = "J" Leads with reduced height of .045" ±.010" L = "L" Leads (formed out) M = "L" Leads with reduced height of .045" ±.010" N = Straight Lead	4 = Standard 3 = Specified	T = Tape and Reel H = High Reliability testing per customer requirements S = Special Part



STACKED SMPS CERAMIC CAPACITORS

P-SERIES DSCC STYLE X7R CAPACITANCE / VOLTAGE SELECTION

CASE SIZE	CHIP LAYERS	LEADS /SIDE	MECHANICAL SIZE RANGE (IN.)			X7R MAX CAPACITANCE (μF)			
			LENGTH (D)	WIDTH (E)	TMAX (B)	50V	100V	200V	500V
P05	1	3	0.275	0.300	.185	3.0	2.2	1.0	0.50
P55	5				.715	15	11	5.0	2.5
P04	1	4	0.425	0.440	.185	9.0	6.5	3.0	1.5
P54	5				.715	45	32	15	7.5
P03	1	10	1.075	0.500	.185	28	20	9.5	4.7
P53	5				.715	140	100	47	23
P01	1	20	2.075	0.500	.185	50	40	19	9.4
P51	5				.715	250	200	95	46
P02	1	15	1.535	0.870	.185	75	55	25	14
P52	5				.715	370	270	125	70
P06	1	20	2.075	1.350	.185	160	110	50	25
P56	5				.715	800	550	250	125

Please refer to our website for complete offering including NP0 & BX capacitance ranges.

NEW 200°C T-SERIES CAPACITANCE / VOLTAGE SELECTION

CASE SIZE	CHIP LAYERS	LEADS /SIDE	MECHANICAL SIZE RANGE (IN.)			MAX CAPACITANCE (μF)		
			LENGTH (D)	WIDTH (E)	TMAX (B)	50V	100V	200V
T05	1	3	0.275	0.300	.185	1.20	0.68	0.33
T55	5				.715	5.60	3.30	1.50
T04	1	4	0.425	0.440	.185	2.70	1.50	0.82
T54	5				.715	15.0	8.20	3.90
T03	1	10	1.075	0.500	.185	10.0	5.60	2.70
T53	5				.715	47.0	27.0	12.0

Please refer to our website for complete offering including NP0 capacitance ranges.

E-SERIES EUROPEAN STYLE X7R CAPACITANCE / VOLTAGE SELECTION

CASE SIZE	CHIP LAYERS	LEADS /SIDE	MECHANICAL SIZE RANGE (MM)			X7R MAX CAPACITANCE (μF)			
			LENGTH (D)	WIDTH (E)	TMAX (B)	50V	100V	200V	500V
E24	1	3	8.7	9.2	3.8	5.0	4.0	2.5	1.0
E54	4				14.8	20	16	10	4.0
E26	1	5	13.6	14.9	3.	16	12	7.5	3.3
E56	4				14.8	64	48	30	13
E21	1	6	16.6	21.6	3.8	30	22	14	6.0
E51	4				14.8	120	88	56	24
E28	1	14	38.2	12.0	3.8	35	25	16	7.0
E58	4				14.8	140	100	64	28
E29	1	14	40.6	24.0	3.8	75	50	35	16
E59	4				14.8	300	200	140	64

Please refer to our website for complete offering including NP0 & BX capacitance ranges.



MINI SWITCH-MODE® CAPACITORS



JDI's Mini Switch-Mode® ceramic capacitors combine the advantages of high capacitance found in tantalum capacitors with very low ESR performance of ceramic capacitors. The “J” and “L” lead configurations replace 1825 and 2225 SMT chips to provide stress relief and prevent cracking due to thermal cycling or mechanical board flexing. Another plus of the J-lead style is that this configuration allows use of the same solder lands as the SMT chips. See the Stacked Switch-Mode section for larger values. See also the Technical Notes on soldering and handling and suggested solder lands.

FEATURES

- High Capacitance, Small Size
- Low ESR/ESL
- Leadframe reduces thermal & mechanical stress due to board flexure and TCE mismatch

APPLICATIONS

- DC-DC Converters
- Power Supply Input & Output Filters

CAPACITANCE SELECTION

SIZE CODE	EIA CHIP SIZE	NP0 Max Capacitance (uF)					X7R Max Capacitance (uF)				
		25V	50V	100V	200V	500V	25V	50V	100V	200V	500V
P09	1825	0.056	0.047	0.039	0.027	0.018	1.5	1.2	0.75	0.56	0.27
P29	1825	0.11	0.094	0.078	0.054	0.036	3.0	2.4	1.5	1.1	0.54
P39	1825	0.16	0.14	0.11	0.081	0.054	4.5	3.6	2.2	1.6	0.81
P49	1825	0.22	0.18	0.15	0.10	0.07	6.0	4.8	3.0	2.2	1.0
P08	2225	0.068	0.056	0.047	0.033	0.027	2.7	2.2	1.5	1.2	0.39
P28	2225	0.13	0.11	0.094	0.066	0.054	5.4	4.4	3.0	2.4	0.78
P38	2225	0.20	0.16	0.14	0.10	0.081	8.1	6.6	4.5	3.6	1.1
P48	2225	0.27	0.22	0.18	0.13	0.10	10	8.8	6.0	4.8	1.5

MINI SWITCH-MODE® CAPACITORS

CASE SIZE

DIMENSIONS APPLICABLE TO ALL SIZES:																			
	IN.	MM																	
H ±	.010	.070	1.78																
C TYP.	.100	2.54																	
P ±	.015	.065	1.65																
DIMENSIONS APPLICABLE TO SPECIFIC SIZES:			P08		P09		P28		P29		P38		P39		P48		P49		
	IN.	MM	IN.	MM	IN.	MM	IN.	MM	IN.	MM	IN.	MM	IN.	MM	IN.	MM	IN.	MM	
L MAX	.280	7.11	0.24	6.1	0.28	7.11	0.24	6.1	0.28	7.11	0.24	6.1	0.28	7.11	0.24	6.1	0.28	7.11	
W MAX	.270	6.86	0.27	6.86	0.27	6.86	0.27	6.86	0.27	6.86	0.27	6.86	0.27	6.86	0.27	6.86	0.27	6.86	
T MAX	.095	2.41	0.095	2.41	0.19	4.83	0.19	4.83	0.285	7.24	0.285	7.24	380	9.65	380	9.65			

Note: J-Lead and L-Lead options are available on all sizes above

ELECTRICAL CHARACTERISTICS

DIELECTRIC:	NP0	X7R
TEMPERATURE COEFFICIENT:	0 ±30ppm/°C (-55 to +125°C)	±15% (-55 to +125°C)
DISSIPATION FACTOR:	0.1% max.	2.5% max.
AGING	None	-2.5% per decade hour
INSULATION RESISTANCE (MIN. @ 25°C, WVDC)	1000 ΩF or 100 GΩ, whichever is less	500 ΩF or 50 GΩ, whichever is less
DIELECTRIC STRENGTH:	For 500V Ratings: 750VDC, 25°C, 50mA max For 200V Ratings: 2xWVDC, 25°C, 50mA max For 25-100V Ratings: 2.5xWVDC, 25°C, 50mA max	
TEST CONDITIONS:	1kHz ±50Hz; 1.0±0.2 VRMS	
OTHER:	See page 39 for additional dielectric specifications.	

HOW TO ORDER - MINI SWITCHMODE®

Part number written: 500P28W395KJ4U

500	P28	W	395	K	J	4	U
VOLTAGE	SIZE	DIELECTRIC	CAPACITANCE	TOLERANCE	TERMINATION	MARKING	PACKING
250 = 25 V 500 = 50 V 101 = 100 V 201 = 200 V 501 = 500 V	See Chart	N = NP0 W = X7R	1st two digits are significant; third digit denotes number of zeros. 103 = 0.01 μF 105 = 1.0 μF 106 = 10 μF	J = ±5% K = ±10% M = ±20% Z = +80% -20%	J = "J" Leads (formed in) L = "L" Leads (formed out)	3 = Standard 4 = Unmarked	U = Tape and Reel 16mm, 13" Reel NONE = Bulk pack H = High Reliability testing per customer requirements S = Special Part



BME MINI SWITCH-MODE® CAPACITORS



This new series of miniature switchmode power supply filter capacitors uses BME (Base Metal Electrode) construction to achieve 300-400% capacitance increases and component size reductions compared to their PME (Precious Metal Electrode) counterparts per the comparison examples below.

BME Size / Capacitance Comparison

Technology	Chips	Volts	Max. Cap.
PME	1x 1825	50V	1.2µF
BME	1x 1812	50V	4.7µF
PME	2x 2225	100V	4.4µF
BME	2x 2220	100V	10µF

FEATURES

- High Capacitance, Small Size
- Low ESR/ESL
- Leadframe reduces thermal & mechanical stress due to board flexure and TCE mismatch
- Green / ROHS Compliant

APPLICATIONS

- DC-DC Converters
- Power Supply Input & Output Filters
- High Capacitance Applications Where Increased Reliability is Required

CAPACITANCE / VOLTAGE

CAPACITANCE RATING	DC VOLTAGE RATING	SIZE P0A 1812 SINGLE STACK		SIZE P07 2220 SINGLE STACK		SIZE P2A 1812 DOUBLE STACK		SIZE P27 2220 DOUBLE STACK		
		IN.	MM	IN.	MM	IN.	MM	IN.	MM	
2.2 µF	100V	101P0AW225MJ4U+RC								
4.7 µF	50V	500P0AW475MJ4U+RC								
4.7 µF	100V			101P07W475MJ4U+RC		101P2AW475MJ4U+RC				
10 µF	50V			500P07W106MJ4U+RC		500P2AW106MJ4U+RC				
10 µF	100V							101P27W106MJ4U+RC		
22 µF	50V							500P27W226MJ4U+RC		
Dimensions Applicable to specific sizes:	L MAX:	0.217	5.5	0.256	6.5	0.217	5.5	0.256	6.5	
	W MAX:	0.157	4.0	0.217	5.5	0.157	4.0	0.217	5.5	
	H MAX:	0.118	3.0	0.118	3.0	0.236	6.0	0.236	6.0	
Dimensions Applicable to all sizes:										
	IN.	MM								
H1 MAX	.059	1.50								
C TYP.	.100	2.54								
P1 TYP.	.020	0.50								
P2 ± 0.02	.065	1.65								

CASE SIZE / PART NUMBER

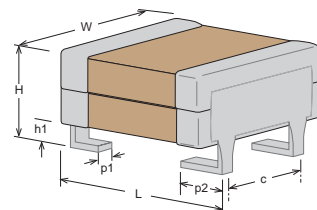
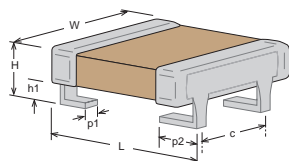

TYPICAL APPLICATION: DC-DC CONVERTER INPUT & OUTPUT FILTERING

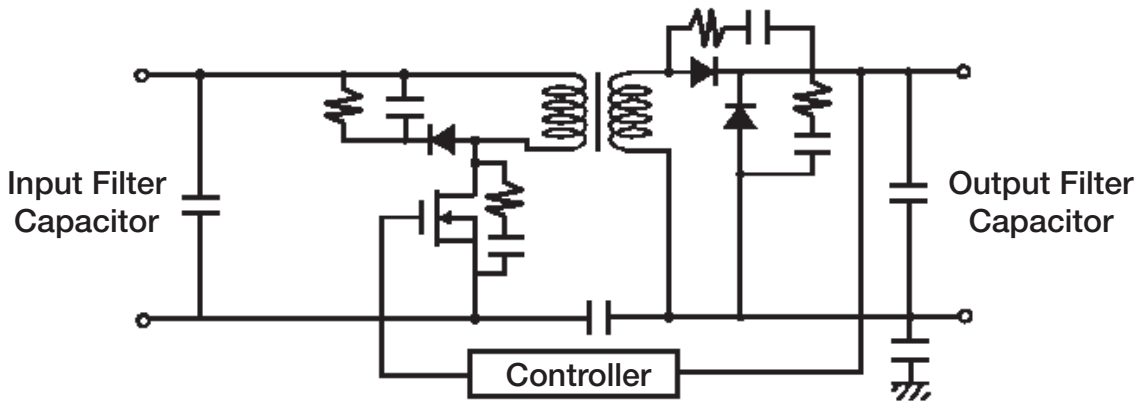

ELECTRICAL CHARACTERISTICS

OPERATING RANGE:	-55 to +125°C
TEMPERATURE COEFFICIENT:	X7R, ±15%
DISSIPATION FACTOR:	0.020 (2.0%) max.
AGING RATE:	<2.5% per decade
INSULATION RESISTANCE:	25°C IR >100GΩ or 1000 ΩF whichever is less
WITHSTANDING VOLTAGE:	2.5 X WVDC for 50 VDC 2.0 X WVDC for 100 VDC
TEST CONDITIONS:	1kHz ±50Hz; 1.0±0.2 VRMS, 25°C

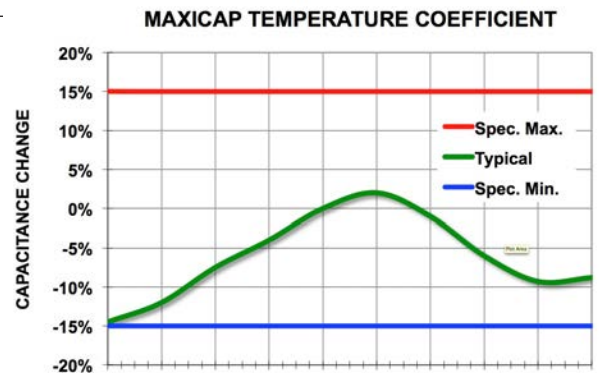

HOW TO ORDER - BME MINI SWITCH-MODE®

Part number written: 500P07W106MJ4U+RC

500	P07	W	106	M	J	4	U	+RC
VOLTAGE	SIZE	DIELECTRIC	CAPACITANCE	TOLERANCE	TERMINATION	MARKING	PACKING	ROHS CODE
500 = 50 V 101 = 100 V	See Chart	W = X7R	1st two digits are significant; third digit denotes number of zeros. 225 = 2.2 μF 106 = 10 uF	M = ±20%	J = "J" Leads (formed in)	4 = Unmarked	U = Embossed Tape 13" Reel per EIA RS481	+RC = RoHS Compliant



X2Y[®] SWITCH-MODE CERAMIC CAPACITORS

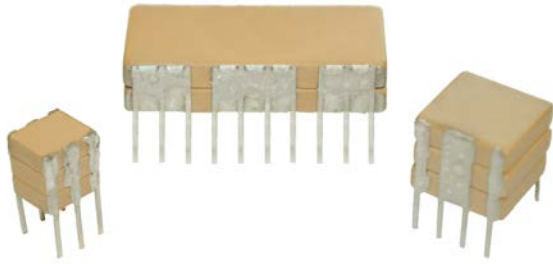

JDI's new X2Y[®] Technology Switch-Mode ceramic capacitors exhibit significantly lower ESL making them ideally suited for applications where high frequency filtering performance is critical. Lower ESL performance translates to significant size and weight reduction because lower capacitance values perform as well or better

KEY FEATURES

- Low ESR / Low ESL, Ideal for SMPS Filtering Applications
- Same Package Size as DSCC Drawings 87106 & 88011 MIL-PRF-49470
- NP0 & X7R Dielectrics, 50 to 500 VDC Ratings
- Custom Sizes, Voltages, and Values Available

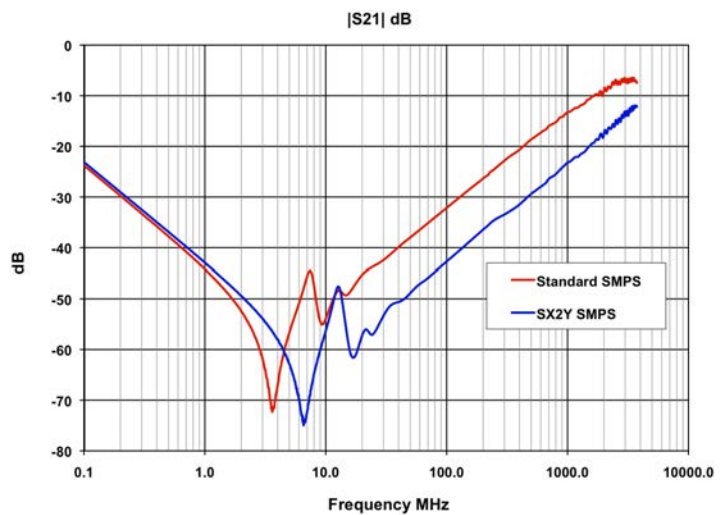
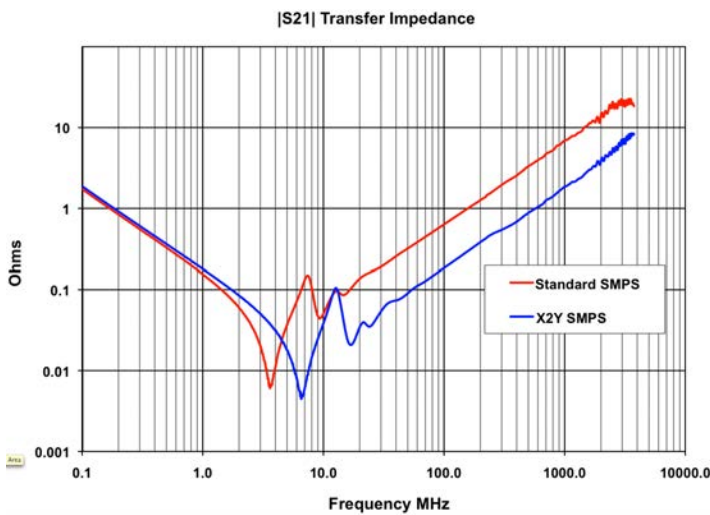

CAPACITANCE / VOLTAGE SELECTION

Rated DC Voltage	Maximum X7R Capacitance Per Case Size (μF)														
	Y05	Y25	Y35	Y45	Y55	Y04	Y24	Y34	Y44	Y54	Y03	Y23	Y33	Y43	Y53
50V	2.7	5.0	8.0	11	14	8.3	17	25	33	41	29	58	87	116	145
100V	2.0	4.0	6.0	8.0	10	6.0	12	17	24	29	21	41	62	83	104
200V	0.9	1.8	2.7	4.0	5.0	2.8	5.5	8.3	11	14	9.8	20	29	39	49
500V	0.5	0.9	1.4	1.8	2.3	1.4	2.8	4.1	5.5	6.9	4.9	9.7	14	19	24

X2Y[®] SWITCH-MODE CERAMIC CAPACITORS

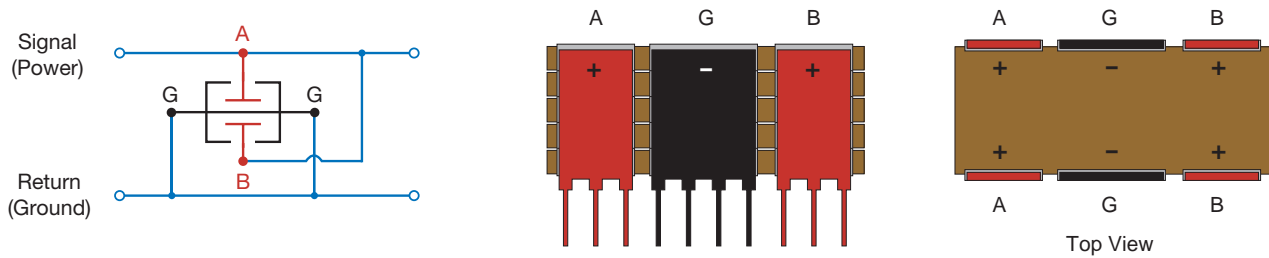

Contact the factory for additional connection options for dual signal line EMI filtering applications.

CASE SIZE

	Y05	Y25	Y35	Y45	Y55	Y04	Y24	Y34	Y44	Y54	Y03	Y23	Y33	Y43	Y53
A	.120	.240	.360	.480	.650	.120	.240	.360	.480	.650	.120	.240	.360	.480	.650
B	.185	.305	.425	.545	.715	.185	.305	.425	.545	.715	.185	.305	.425	.545	.715
C			.250					.400					.450		
D-			.224					.350					.950		
D+			.275					.425					1.075		
E			.300					.440					.500		
Pins	3 per side, configuration: a = 1, b = 1, g = 1					5 per side, configuration a = 1, b = 1, g = 3					10 per side, configuration a = 3, b = 3, g = 4				

All dimensions are in Inches. Tolerances are maximum except: C = ± 0.025 " D- = minimum, D+ = maximum, F = minimum

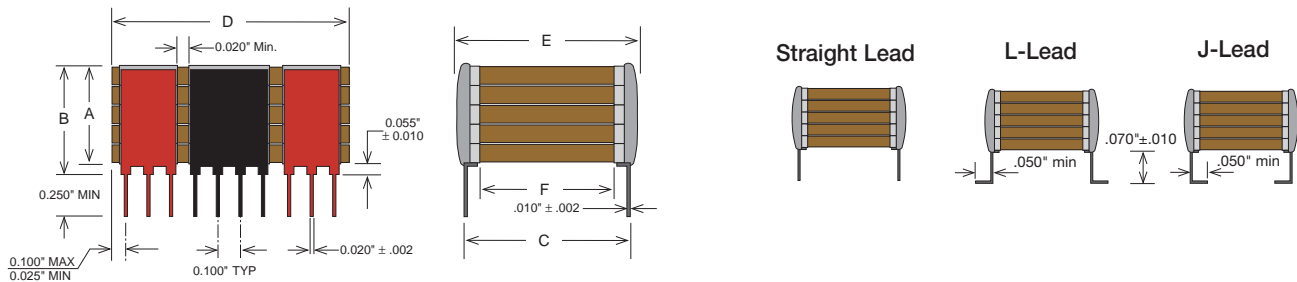

HOW TO ORDER - X2Y[®] SMPS

Part number written: 201Y03W475KJ4H

201	Y03	W	475	M	J	4	H
VOLTAGE	SIZE	DIELECTRIC	CAPACITANCE	TOLERANCE	TERMINATION	MARKING	PACKING
500 = 50 V 101 = 100 V 201 = 200 V 501 = 500 V	See Chart	W = X7R	1st two digits are significant; third digit denotes number of zeros. 104 = 0.10 μ F 105 = 1.00 μ F 476 = 47.0 μ F	M = $\pm 20\%$	J = "J" Leads (formed in) L = "L" Leads (formed out) N = Straight Lead	4 = Standard 3 = Specified	T = Tape and Reel H = High Reliability testing per customer requirements S = Special Part



SWITCH-MODE RADIAL LEADED CAPACITORS

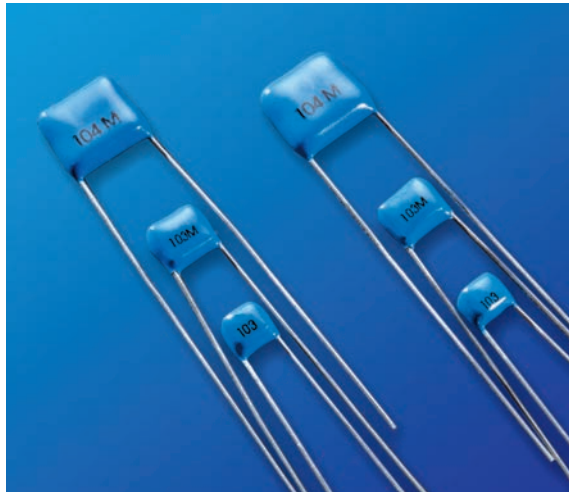





KEY FEATURES

- Rated Working Voltages from 25 to 500 VDC
- Rugged Epoxy Coating Offers Increased Protection
- Hi-Rel Screened Versions Available
- Custom Sizes, Voltages, and Values Available

ADVANTAGES





- Power Supplies
- Voltage Multipliers
- Data Isolation
- Surge Protection
- Industrial Control Circuits
- Custom Applications

CASE SIZE

		IN.	(MM)	RATED VOLTAGE	NP0 CAPACITANCE (MAX.)		X7R CAPACITANCE (MAX.)	
					VALUE	CODE	VALUE	CODE
 H03	W	.300 max.	(7.62 max.)	25 VDC	.070 μ F	703	2.00 μ F	205
	H	.300 max.	(7.62 max.)	50 VDC	.060 μ F	603	1.60 μ F	165
	T	.200 max.	(5.08 max.)	100 VDC	.050 μ F	503	1.10 μ F	115
	S	.200 nom.	(5.08 nom.)	200 VDC	.040 μ F	403	.730 μ F	734
	LD	.020 nom.	(.510 nom.)	500 VDC	.020 μ F	203	.250 μ F	254
					25 VDC	.120 μ F	124	5.10 μ F
 H04	W	.400 max.	(10.2 max.)	50 VDC	.100 μ F	104	4.10 μ F	415
	H	.400 max.	(10.2 max.)	100 VDC	.082 μ F	823	2.70 μ F	275
	T	.200 max.	(5.08 max.)	200 VDC	.050 μ F	503	1.80 μ F	185
	S	.200 nom.	(5.08 nom.)	500 VDC	.030 μ F	303	.670 μ F	674
	LD	.020 nom.	(.510 nom.)	25 VDC	.240 μ F	244	8.70 μ F	875
					50 VDC	.200 μ F	204	7.20 μ F
 H05	W	.500 max.	(12.7 max.)	100 VDC	.180 μ F	184	4.80 μ F	485
	H	.500 max.	(12.7 max.)	200 VDC	.110 μ F	114	3.30 μ F	335
	T	.200 max.	(5.08 max.)	500 VDC	.070 μ F	703	1.10 μ F	115
	S	.400 nom.	(10.2 nom.)	25 VDC	.750 μ F	754	22.0 μ F	226
	LD	.025 nom.	(.635 nom.)	50 VDC	.620 μ F	624	17.0 μ F	176
					100 VDC	.560 μ F	564	13.0 μ F
 H06	W	.870 max.	(22.1 max.)	200 VDC	.360 μ F	364	8.00 μ F	805
	H	.600 max.	(15.2 max.)	500 VDC	.240 μ F	244	2.90 μ F	295
	T	.200 max.	(5.08 max.)	25 VDC	.750 μ F	754	22.0 μ F	226
	S	.790 nom.	(20.1 nom.)	50 VDC	.620 μ F	624	17.0 μ F	176
	LD	.032 nom.	(.813 nom.)	100 VDC	.560 μ F	564	13.0 μ F	136
					200 VDC	.360 μ F	364	8.00 μ F

SWITCH-MODE RADIAL LEADED CAPACITORS

CASE SIZE

		IN.	(MM)	RATED VOLTAGE	NP0 CAPACITANCE (MAX.)		X7R CAPACITANCE (MAX.)	
					VALUE	CODE	VALUE	CODE
 H07	W	1.10 max.	(27.9 max.)	25 VDC	.680 µF	684	35.0 µF	356
	H	.600 max.	(15.2 max.)	50 VDC	.560 µF	564	28.0 µF	286
	T	.200 max.	(5.08 max.)	100 VDC	.470 µF	474	19.0 µF	196
	S	.980 nom.	(24.9 nom.)	200 VDC	.330 µF	334	13.0 µF	136
	LD	.032 nom.	(.813 nom.)	500 VDC	.200 µF	204	4.60 µF	465
					25 VDC	1.20 µF	125	70.0 µF
 H08	W	1.10 max.	(27.9 max.)	50 VDC	1.10 µF	115	56.0 µF	566
	H	.600 max.	(15.2 max.)	100 VDC	.820 µF	824	37.0 µF	376
	T	.350 max.	(8.89 max.)	200 VDC	.470 µF	474	26.0 µF	266
	S	.980 nom.	(24.9 nom.)	500 VDC	.300 µF	304	8.70 µF	875
	LD	.032 nom.	(.813 nom.)					
					25 VDC	.450 µF	454	13.0 µF
 H09	W	.670 max.	(17 max.)	50 VDC	.360 µF	364	10.0 µF	106
	H	.540 max.	(13.7 max.)	100 VDC	.330 µF	334	7.20 µF	725
	T	.200 max.	(5.08 max.)	200 VDC	.240 µF	244	5.00 µF	505
	S	.575 nom.	(14.6 nom.)	500 VDC	.180 µF	184	1.70 µF	175
	LD	.025 nom.	(.635 nom.)					
					25 VDC	1.00 µF	105	38.0 µF
 H10	W	.930 max.	(23.6 max.)	50 VDC	.900 µF	904	30.0 µF	306
	H	.720 max.	(18.3 max.)	100 VDC	.750 µF	754	20.0 µF	206
	T	.250 max.	(6.35 max.)	200 VDC	.470 µF	474	14.0 µF	146
	S	.800 nom.	(20.3 nom.)	500 VDC	.300 µF	304	5.80 µF	585
	LD	.032 nom.	(.813 nom.)					

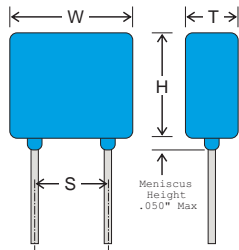

NOTE: Lead lengths are typically 1.25" for orders in bulk packaging. Leads are typically 1.00" for tape and reel packaging. Tape and reel packaging comes in 1000 piece reels.

HOW TO ORDER SWITCH-MODE RADIALS

Part number written: 201H07W105KQ4

201	H07	W	105	K	Q	4	T
VOLTAGE	SIZE	DIELECTRIC	CAPACITANCE	TOLERANCE	TERMINATION	MARKING	PACKING
250 = 25 V 500 = 50 V 101 = 100 V 201 = 200 V 501 = 500 V	See Chart	N = NP0 W = X7R	1st two digits are significant; third digit denotes number of zeros. 101 = 100 pF 102 = 1000 pF 103 = 0.01 µF 105 = 1.00 µF	J = ± 5% K = ± 10% M = ± 20% Z = +80% -20%	Q = Leaded & Encapsulated	4 = Standard 3 = Specified	T = Tape and Reel H = High Rel Testing per customer requirements S = Special Part



HIGH VOLTAGE RADIAL LEADED CAPACITORS

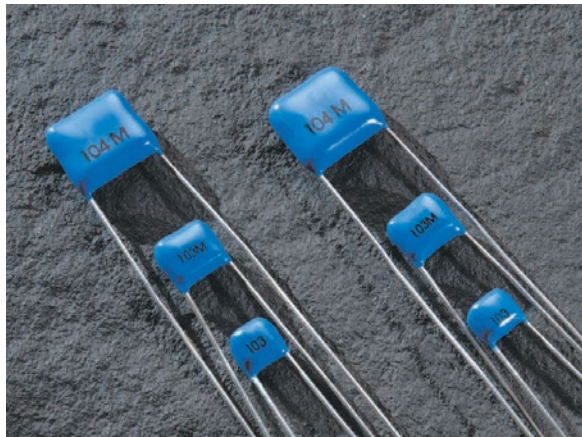





KEY FEATURES

- Rated Working Voltages from 25 to 5000 VDC
- Rugged Epoxy Coating Offers Increased Protection
- Compact MLC Designs Smaller Than Film or Disc
- NEW 200°C & 250°C Versions Available for Oil & Geophysical Tool, Aircraft Engine Control Applications
- DSCC Drawing & Other Screened Versions Available

ADVANTAGES



- Power Supplies
- Voltage Multipliers
- Data Isolation
- Surge Protection
- Industrial Control Circuits
- Custom Applications

CASE SIZE

		IN.	(MM)	RATED VOLTAGE	NP0 CAPACITANCE (MAX.)		X7R CAPACITANCE (MAX.)	
					VALUE	CODE	VALUE	CODE
 H42	W	0.250 Max	(6.35 Max)	500 VDC	4700 pF	472	.150 µF	154
	H	0.220 Max	(5.59 Max)	1000 VDC	1500 pF	152	.055 µF	553
	T	0.270 Max	(6.86 Max)	2000 VDC	680 pF	681	9000 pF	902
	S	0.170 ±0.03	(4.32 ±0.76)	3000 VDC	330 pF	331	2800 pF	282
	LD	0.025 ±.002	(0.64 ±0.05)	4000 VDC	150 pF	151	630 pF	631
					5000 VDC	100 pF	101	550 pF
 H47	W	0.370 Max	(9.40 Max)	500 VDC	.022 µF	223	.480 µF	484
	H	0.300 Max	(7.62 Max)	1000 VDC	3300 pF	332	.170 µF	174
	T	0.270 Max	(6.86 Max)	2000 VDC	1500 pF	152	.025 µF	253
	S	0.275 ±0.03	(6.99 ±0.76)	3000 VDC	680 pF	681	.011 µF	113
	LD	0.025 ±.002	(0.64 ±0.05)	4000 VDC	330 pF	331	1800 pF	182
					5000 VDC	220 pF	221	940 pF
 H51	W	0.470 Max	(12.0 Max)	500 VDC	.056 µF	563	1.20 µF	125
	H	0.400 Max	(10.2 Max)	1000 VDC	4700 pF	472	.450 µF	454
	T	0.320 Max	(8.13 Max)	2000 VDC	3300 pF	332	.094 µF	943
	S	0.375 ±0.03	(9.53 ±0.76)	3000 VDC	1500 pF	152	.043 µF	433
	LD	0.025 ±.002	(0.64 ±0.05)	4000 VDC	1000 pF	102	.010 µF	103
					5000 VDC	470 pF	471	4900 pF
 H62	W	0.570 Max	(14.5 Max)	500 VDC	.100 µF	104	2.20 µF	225
	H	0.500 Max	(12.7 Max)	1000 VDC	.010 µF	103	.804 µF	804
	T	0.320 Max	(8.13 Max)	2000 VDC	6800 pF	682	.240 µF	244
	S	0.475 ±0.03	(12.1 ±0.76)	3000 VDC	3300 pF	332	.073 µF	733
	LD	0.025 ±.002	(0.64 ±0.05)	4000 VDC	2200 pF	222	.028 µF	283
					5000 VDC	1000 pF	102	.013 µF
 H66	W	0.670 Max	(17.0 Max)	500 VDC	.150 µF	154	3.30 µF	335
	H	0.600 Max	(15.2 Max)	1000 VDC	.015 µF	153	1.20 µF	125
	T	0.320 Max	(8.13 Max)	2000 VDC	.010 µF	103	.440 µF	444
	S	0.575 ±0.03	(14.6 ±0.76)	3000 VDC	4700 pF	472	.013 µF	134
	LD	0.025 ±.002	(0.64 ±0.05)	4000 VDC	3300 pF	332	.041 µF	413
					5000 VDC	2200 pF	222	.020 µF

HIGH VOLTAGE RADIAL LEADED CAPACITORS

CASE SIZE

		IN.	(MM)	RATED VOLTAGE	NP0 CAPACITANCE (MAX.)		X7R CAPACITANCE (MAX.)	
					VALUE	CODE	VALUE	CODE
	W	0.770 Max	(19.6 Max)	500 VDC	.220 µF	224	5.70 µF	575
	H	0.720 Max	(18.3 Max)	1000 VDC	.022 µF	223	2.10 µF	215
	T	0.320 Max	(8.13 Max)	2000 VDC	.015 µF	153	.620 µF	624
	S	0.675 ±0.03	(17.1 ±0.76)	3000 VDC	6800 pF	682	.190 µF	194
	LD	0.025 ±.002	(0.64 ±0.05)	4000 VDC	4700 pF	472	.054 µF	543
					5000 VDC	3300 pF	332	.026 µF
	W	0.870 Max	(22.1 Max)	500 VDC	.330 µF	334	7.30 µF	735
	H	0.750 Max	(19.1 Max)	1000 VDC	.100 µF	104	2.80 µF	285
	T	0.320 Max	(8.13 Max)	2000 VDC	.056 µF	563	.800 µF	804
	S	0.775 ±0.03	(19.7 ±0.76)	3000 VDC	.033 µF	333	.250 µF	254
	LD	0.025 ±.002	(0.64 ±0.05)	4000 VDC	.010 µF	103	.080 µF	803
					5000 VDC	6800 pF	682	.041 µF
	W	1.450 Max	(36.8 Max)	500 VDC	.470 µF	474	12.0 µF	126
	H	0.720 Max	(18.3 Max)	1000 VDC	.150 µF	154	4.60 µF	465
	T	0.320 Max	(8.13 Max)	2000 VDC	.082 µF	823	1.20 µF	125
	S	1.375 ±0.03	(34.9 ±0.76)	3000 VDC	.047 µF	473	.390 µF	394
	LD	0.025 ±.002	(.064 ±0.05)	4000 VDC	.015 µF	153	.130 µF	134
					5000 VDC	.010 µF	103	.068 µF

T-SERIES 200°C & 250°C

Johanson also offers two different series of high temperature radial leaded capacitors for 200°C and 250°C. These components feature rugged premolded cases with Hi-Temp epoxy fill. The 200°C line is offered in voltage ratings of 25V to 4KV and maximum capacitance loss of -0.5% in NP0 and -45% in X7R. The 250°C line is offered in voltage ratings of 50V & 100V with maximum capacitance loss of -1.5% in NP0 and -55% in X7R. Please visit our website for complete component selection & specifications

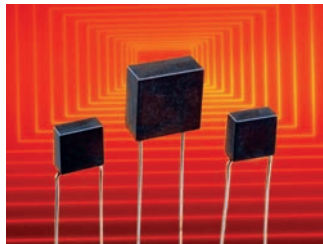

APPLICATIONS

- Oil Well Logging (Downhole)
- Geophysical Probes
- Jet Engine Controls

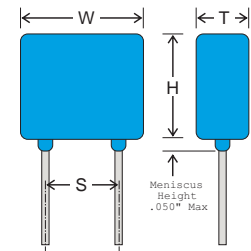

NOTE: Lead lengths are typically 1.25" for orders in bulk packaging. Leads are typically 1.00" for tape and reel packaging. Tape and reel packaging comes in 1000 piece reels.

HOW TO ORDER HIGH VOLTAGE RADIALS

Part number written: 102H42W101KQ4

102	H42	W	101	K	Q	4	
VOLTAGE	SIZE	DIELECTRIC	CAPACITANCE	TOLERANCE	TERMINATION	MARKING	PACKING
501 = 500 V 102 = 1000 V 202 = 2000 V 302 = 3000 V 402 = 4000 V 502 = 5000 V	See Chart	N = NP0 W = X7R	1st two digits are significant; third digit denotes number of zeros. 102 = 1000 pF 103 = 0.01 µF 105 = 1.00 µF	J = ± 5% K = ± 10% M = ± 20% Z = +80% -20%	Q = Leaded & Encapsulated	4 = Standard 3 = Specified	T = Tape and Reel H = High Rel Testing per customer requirements S = Special Part



PLANAR CAPACITOR ARRAYS FOR EMI FILTERING

Johanson Dielectrics is the premier supplier of Planar Capacitor EMI Filter Arrays to the Filtered Connector Industry.

Planar Capacitors are the fundamental building block for filtered connectors in Aerospace, Biomedical, Military, Satellite, Industrial and Communication electronics.

Johanson offers high value Arrays in standard and custom solutions to fit your needs.

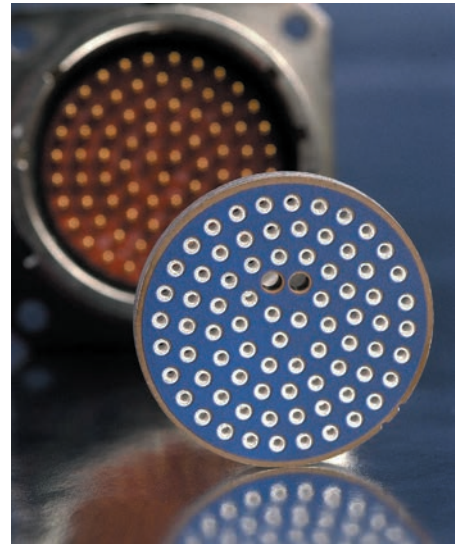

CIRCULAR ARRAYS

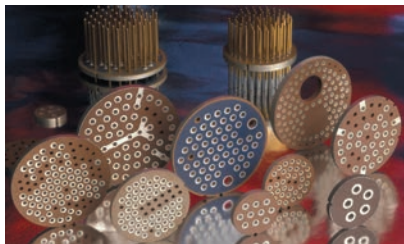

PHYSICAL LAYOUT	DIELECTRIC MATERIAL	AVAILABLE CAPACITANCE	WORKING VOLTAGE	DWV VOLTAGE
MIL-1560 MIL-1554 MIL-1669 MIL-1651 MIL-1698 MIL-33702 MIL-AUDIO	X7R & NPO	47 pF to 800 nF	Up to 2,000 VDC	Up to 3,000 VDC

RECTANGULAR ARRAYS (ARINC 404/600)

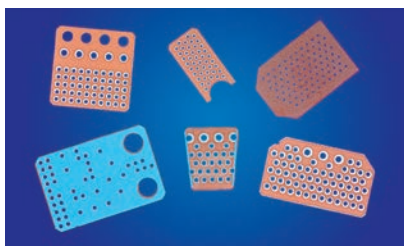

PHYSICAL LAYOUT	DIELECTRIC MATERIAL	AVAILABLE CAPACITANCE	WORKING VOLTAGE	DWV VOLTAGE
AR-010 Through AR-150	X7R & NPO	47 pF to 940 nF	Up to 1,330 VDC	Up to 2,000 VDC

D-SUBMINATURE RECTANGULAR ARRAYS

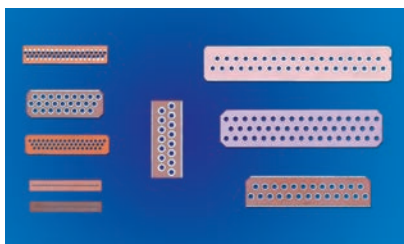

PHYSICAL LAYOUT	DIELECTRIC MATERIAL	AVAILABLE CAPACITANCE	WORKING VOLTAGE	DWV VOLTAGE
Full Size	X7R & NPO	47pF - 210nF	≤ 2,400	≤ 3,600
Mini-D		47pF - 100nF	≤ 1,000	≤ 1,500
Micro-D		47pF - 22.5nF	≤ 680	≤ 1,020
Nano-D		47pF - 3.0nF	≤ 200	≤ 500
Combo-D		47pF - 6.0nF	≤ 800	≤ 1,200
Power-D		47pF - 120nF	≤ 680	≤ 1,020
Special		47pF - 50nF	≤ 300	≤ 750

PLANAR CAPACITOR ARRAYS FOR EMI FILTERING

CUSTOM ARRAYS

Johanson Dielectrics's design expertise and CNC manufacturing process enable broad custom array capability. Many shapes, configurations and geometries are possible. Share your requirements and we will create a solution!

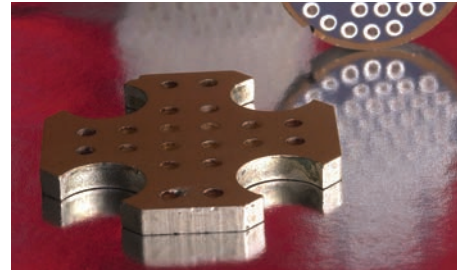

DISCOIDAL CAPACITORS

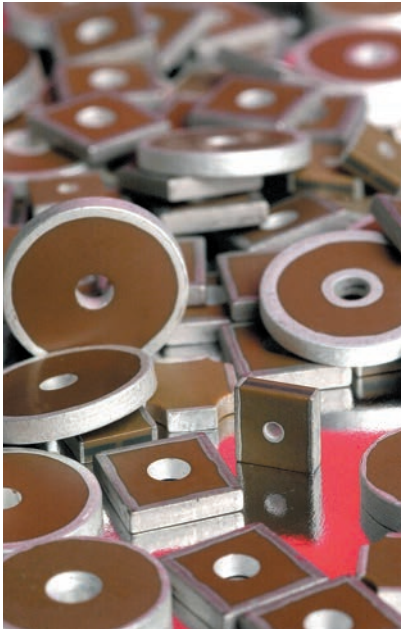

JOHANSON Discoidal Feed-through Capacitors are the functional element in widely used EMI feed-through filters. This capacitor configuration offers very low impedance and inductance. Discoidal capacitors are ideal for by-pass, filtering, coupling, single line EMI/RFI suppression, and high frequency applications.

- Capacitance values from 10 pF to 11.2 μ F
- Test standards and procedures per MIL-STD-202 and MIL-C-123
- Voltage ratings from 50 to 3000 VDC and 50 to 240 VAC
- Low ESR and ESL, non-polar designs

Call us to discuss your special requirements!

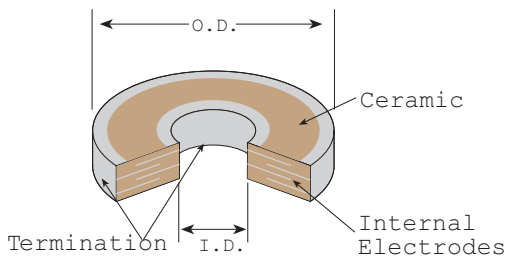

NOMINAL O.D. (IN.)	DIELECTRIC MATERIAL	AVAILABLE CAPACITANCE	INSIDE DIAMETER (IN.)	THICKNESS (IN.)	RATED VOLTAGE
0.100 ±.005	X7R & NPO	10 pF – 66 nF	0.025 ±0.048	0.025 ±0.070	Up to 200 VDC
0.150 ±.005		10 pF – 200 nF	0.037 ±0.058	0.025 ±0.070	Up to 200 VDC
0.335 ±.005		10 pF – 2.8 μ F	0.034 ±0.088	0.040 ±0.110	Up to 500 VDC
0.345 ±.005		10 pF – 6.0 μ F	0.040 ±0.085	0.055 ±0.110	Up to 750 VDC
0.376 ±.005		10 pF – 8.0 μ F	0.050 ±0.075	0.065 ±0.125	Up to 750 VDC
0.643 ±.005		10 pF – 15 μ F	0.063 ±0.080	0.055 ±0.150	Up to 750 VDC
0.840 ±.005		10 pF – 20 μ F	0.050 ±0.075	0.080 ±0.130	Up to 1000 VDC



CAPSTRATE® CAPACITOR SUBSTRATES

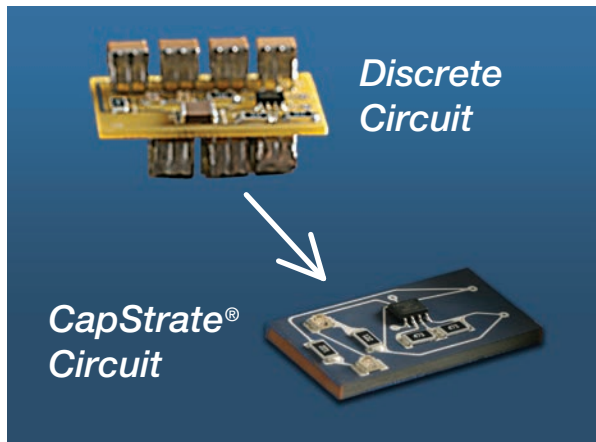

Johanson CapStrate® products integrate bulk capacitance into a ceramic substrate eliminating large discrete capacitive components which saves critical space and simplifies the assembly process. Our design and manufacturing expertise in large format, custom geometries provides innovative solutions that economically solve a wide variety of your design challenges.

ADVANTAGES

- Major Size & Weight Reduction
- Fewer Solder Joints
- Lower Assembly Cost
- Circuit Assembly Available

KEY FEATURES

- Integrated Capacitance in The Substrate
- Rated Working Voltages from 50V to 5,000V
- Temperature ranges: -55°C to 125°C (specials to 200°C and 250°C)
- Compact Designs Utilizing Military Grade Ceramics
- Custom Sizes, Values, and Voltages Available

SIZE / CAPACITANCE CAPABILITY EXAMPLES

SUBSTRATE SIZE		LENGTH	WIDTH	THICK	NP0 50V	NP0 100V	NP0 200V	NP0 500V	X7R 50V	X7R 100V	X7R 200V	X7R 500V
CapStrate 4	In	0.400	0.400	0.120	0.22µF	0.15µF	0.12µF	0.07µF	9.0µF	6.0µF	3.0µF	1.5µF
	mm	10.2	10.2	3.1								
CapStrate 3	In	0.450	1.00	0.120	0.70µF	0.50µF	0.39µF	0.22µF	28.0µF	20.0µF	9.0µF	4.7µF
	mm	11.43	25.4	3.1								
CapStrate 1	In	0.450	2.00	0.120	1.40µF	1.00µF	0.75µF	0.44µF	50.0µF	40.0µF	18.0µF	9.4µF
	mm	11.4	50.8	3.1								
CapStrate 2	In	0.800	1.50	0.120	2.00µF	1.40µF	1.00µF	0.60µF	75.0µF	55.0µF	25.0µF	14.0µF
	mm	20.3	38.1	3.1								
CapStrate 6	In	1.250	2.00	0.120	4.00µF	2.80µF	2.00µF	1.20µF	150.0µF	110.0µF	50.0µF	28.0µF
	mm	31.8	50.8	3.1								
Circular CapStrate® Capacitance Formula					1.3 -1.6 µF / In ²	0.9 -1.1 µF / In ²	0.7 -0.8 µF / In ²	50 - 62 µF / In ²	35 - 45 µF / In ²	18 - 20 µF / In ²	1.3 -1.6 µF / In ²	9 -10 µF / In ²

This chart is intended to provide capability examples. Not all possibilities are shown and we invite application specific inquiries. Circular CapStrate® example lists available capacitance per area.

CUSTOM CAPACITOR SOLUTIONS

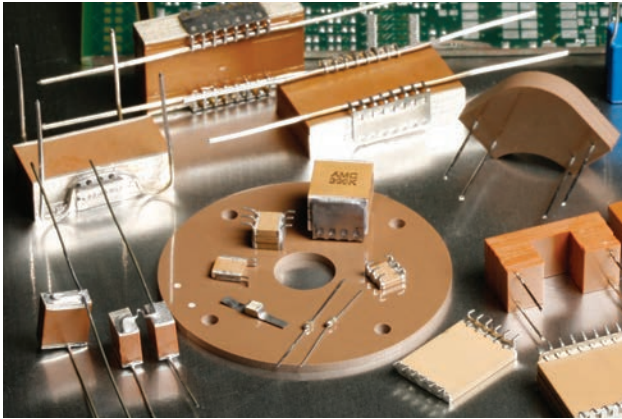

Johanson's extensive experience in design and manufacture of large format, custom geometries allows us to develop unique and innovative solutions which successfully solve a wide variety of our customer's design challenges. We'll work pro actively with you to fully understand your requirements and recommend the best solution possible.

KEY FEATURES

- Custom shapes to fit specific requirements
- Multiple capacitors in a single assembly
- NP0/COG and X7R solutions from -55°C to +125°C
- Multiple pin, lead-frame, and flying wire options
- Bare ceramic, epoxy coated, potted solutions

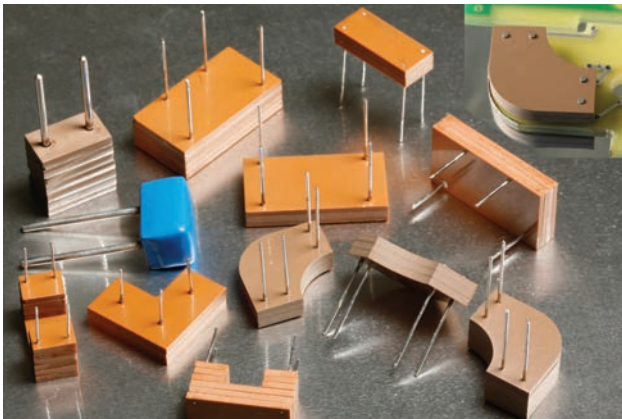
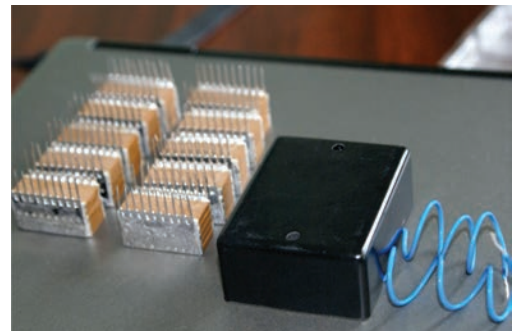

VARIABLE PITCH ASSEMBLIES

Another custom approach is our variable pitch design. No longer are you limited to a vendor's standard catalogue offering or only square or rectangular custom designs. We let you become your own capacitor designer by not only telling us the desired capacitance and voltage, but also the size, shape, and location of leads! This process helps insure that the resulting capacitor satisfies every aspect of your design requirements.



CAPACITOR PACKAGING

Johanson capacitors are available taped per EIA standard 481. Tape options include 7" and 13" diameter reels. Johanson uses high quality, dust free, punched 8mm paper tape and plastic embossed 8mm tape for thicker MLCCs. Quantity per reel ranges are listed in the tables below and are dependent on chip thickness.

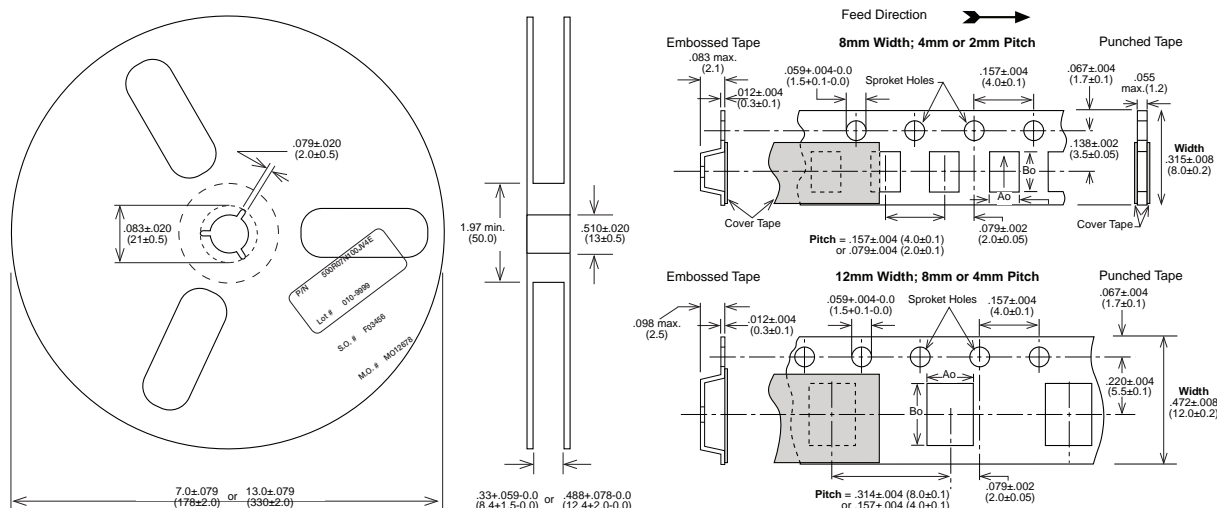

COMPONENT	7" DIAMETER REEL				13" DIAMETER REEL			
	REEL QTY	TAPE TYPE	WIDTH / PITCH	CODE	REEL QTY	TAPE TYPE	WIDTH / PITCH	CODE
R05 / 0201 MLCC	15000	Paper	8mm/2mm	T	N/A	N/A		N/A
R07 / 0402 MLCC	10000	Paper	8mm/2mm	T	N/A	N/A		N/A
R14 / 0603 MLCC	4000	Paper	8mm/4mm	T	10000	Paper	8mm/4mm	R
R15 / 0805 MLCC	4000 / 3000	Paper / Embossed	8mm/4mm	T / E	10000	Paper / Embossed	8mm/4mm	R / U
R18 / 1206 MLCC	4000 / 3000	Paper / Embossed	8mm/4mm	T / E	10000	Paper / Embossed	8mm/4mm	R / U
S41 / 1210 MLCC	2000 - 4000	Embossed	8mm/4mm	E	5000-10000	Embossed	8mm/4mm	U
R29 / 1808 MLCC	2000	Embossed	12mm/4mm	E	5000 - 8000	Embossed	12mm/4mm	U
R30 / 2211 MLCC	1000 - 2000	Embossed	12mm/4mm	E	2000 - 5000	Embossed	12mm/4mm	U
S43 / 1812 MLCC	500 - 1000	Embossed	12mm/8mm	E	3000 - 5000	Embossed	12mm/8mm	U
S47 / 2220 MLCC	250 - 1000	Embossed	12mm/8mm	E	2000 - 5000	Embossed	12mm/8mm	U
S49 / 1825 MLCC	250 - 1000	Embossed	12mm/8mm	E	2000 - 4000	Embossed	12mm/8mm	U
S48 / 2225 MLCC	250 - 1000	Embossed	12mm/8mm	E	2000 - 4000	Embossed	12mm/8mm	U
X07 / 0402 X2Y	4000	Paper	8mm/2mm	T	10000	Paper	8mm/2mm	R
X14 / 0603 X2Y	4000	Paper	8mm/4mm	T	10000	Paper	8mm/4mm	R
X15 / 0805 X2Y	4000	Embossed	8mm/4mm	E	10000	Embossed	8mm/4mm	U
X18 / 1206 X2Y	3000 - 4000	Embossed	8mm/4mm	E	10000	Embossed	8mm/4mm	U
X41 / 1210 X2Y	2000 - 3000	Embossed	8mm/4mm	E				
X44 / 1410 X2Y	1000 - 2000	Embossed	8mm/4mm	E				
X43 / 1812 X2Y	1000	Embossed	12mm/8mm	E				

Actual reel quantities based on part thickness and tape type. Contact sales for reel quantities of specific part numbers.



ELECTRICAL CHARACTERISTICS

PARAMETER	NPO		X7R		X5R	
TEMPERATURE COEFFICIENT:	0 ± 30 ppm/°C	-55 to +125°C	± 15%	-55 to +125°C	± 15%	-55 to +85°C
DISSIPATION FACTOR:	.001 (0.1%) max		WVDC ≥ 50 VDC, DF = 2.5% max WVDC = 25 VDC, DF = 3.0% max WVDC = 16 VDC, DF = 3.5% max		For Vrated ≥ 50 VDC, DF = 5% max For Vrated ≤ 25 VDC: DF = 10% max	
AGING:	None		2.5% / decade hour		2.5 % / decade hour	
INSULATION RESISTANCE:	1000ΩF or 100GΩ whichever is less @ 25°C, WVDC		500ΩF or 50GΩ whichever is less @ 25°C, WVDC		100ΩF or 10GΩ whichever is less @ 25°C, WVDC	
DIELECTRIC STRENGTH:	For Vrated = 6 - 200 VDC, DWV = 2.5 X WVDC, 25°C, 50mA max. For Vrated = 201 - 499 VDC, DWV = 2.0 X WVDC, 25°C, 50mA max. For Vrated = 500 - 999 VDC, DWV = 1.5 X WVDC, 25°C, 50mA max. For Vrated = 1000+ VDC, DWV = 1.2 X WVDC, 25°C, 50mA max.				DWV = 2.5 X WVDC, 25°C, 50mA max.	
TEST PARAMETERS:	C > 100 pF; 1kHz ±50Hz; 1.0±0.2 VRMS C ≤ 100 pF 1Mhz ±50kHz; 1.0±0.2 VRMS		1kHz ±50Hz; 1.0±0.2 VRMS		1kHz ±50Hz; 0.5±0.2 VRMS	
NOTES:	Tanceram IR = 100 ΩF or 10 GΩ Tanceram DF for Vrated ≥ 50 VDC = 5% max. Tanceram DF for Vrated ≤ 25 VDC, DF = 10% max					

PART NUMBER BREAKDOWN - SURFACE MOUNT

Part number written: 502R29W102KV3E-****-SC

502	R 29	W	102	K	V	3	E
VOLTAGE	SERIES/SIZE	DIELECTRIC	CAPACITANCE	TOLERANCE	TERMINATION	MARKING	PACKING
6R3 = 6.3 V DC 100 = 10 V DC 160 = 16 V DC 250 = 25 V DC 500 = 50 V DC 101 = 100 V DC 201 = 200 V DC 251 = 250 V DC 301 = 300 V DC 501 = 500 V DC 631 = 630 V DC 102 = 1000 V DC 202 = 2000 V DC 302 = 3000 V DC* 402 = 4000 V DC 502 = 5000 V DC* ACJ = 250 VAC * For Safety Caps with -****-SC P/N suffix only: 302 = 250VAC [2500V Impulse] 502 = 250VAC [5000V Impulse]	A__ = ARRAY B__ = LICC F__ = F-T FILTER R__ = MLCC S__ = MLCC T__ = HI TEMP MLCC X__ = X2Y _05=0201 _07=0402 _14=0603 _15=0805 _18=1206 _41=1210 _29=1808 _30=2211 _43=1812 _44=1410 _47=2220 _49=1825 _48=2225	N = NPO W = X7R X = X5R	1st two digits are significant; third digit denotes number of zeros, R = decimal. 5R6 = 5.6 pF 100 = 10 pF 102 = 1,000 pF 474 = 0.47 μF 475 = 4.7 μF 106 = 10 μF	* B = ± 0.10 pF * C = ± 0.25 pF * D = ± 0.50 pF F = ± 1 % G = ± 2 % J = ± 5 % K = ± 10 % M = ± 20 % Y = +50 -20 % Z = +80 -20 % *Values < 10 pF only	V = Nickel Barrier with 100% Tin Plating (Matte) F = Polyterm flexible termination G = Gold T = SnPb P = PdAg	3 = Special 4 = Unmarked 6 = EIA Code* *Not available on sizes ≤ 0402	E = Embossed 7" T = Punched 7" U = Embossed 13" R = Punched 13" No code = bulk pack Tape specifications conform to EIA RS481 Not all tape styles are available on all parts.
<div style="border: 1px solid black; display: inline-block; padding: 2px;">-****-</div> <div style="border: 1px solid black; display: inline-block; padding: 2px; margin-left: 5px;">SC</div>							
PART NUMBER MODIFIER Used on select parts such as Safety Certified or for customer specific requirements.							

PLEASE NOTE: Not all combinations of JDI P/Ns are valid. Please refer to the "How to Order" detail section of the specific product or contact your Sales Representative if you need assistance.



Your Technology Partner



High Voltage

AC Safety



X2Y

High Capacitance



High Temperature

AC Power



Feedthru Filter

Low ESL



SMPS

Radial Leaded

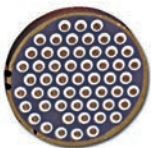

Planar Arrays

Custom Solutions



JOHANSON
DIELECTRICS 

EUROPE:

JOHANSON EUROPE, LTD.

Flackwell Heath,

Bucks, England HP10 9NR

TEL +44 1628 531154 • FAX +44 1628 532703

eurosales@johansondielectrics.com

UNITED STATES:

HEADQUARTERS

15191 Bledsoe St.,

Sylmar, California 91342

TEL (818) 364 9800 • FAX (818) 364 6100

<http://www.johansondielectrics.com>

HONG KONG:

JOHANSON HONG KONG, LTD.

Unit E, 11/F., Phase 1 Kaiser Estate

41 Man Yue St., Hunghom

Kowloon, Hong Kong

TEL +852 2334 6310 • FAX +852 2334 8858

asiasales@johansondielectrics.com

X-ON Electronics

Largest Supplier of Electrical and Electronic Components

Click to view similar products for johanson manufacturer:

Other Similar products are found below :

[S-X2Y-MTR](#) [502R29W331KF3E--SC](#) [L603DC](#) [502R30W681KF3E--SC](#) [502R29W331KF3E-***-SC](#) [251R14S100FV4T](#)
[RWCSG4Q006R0FS](#) [RWCSG3U040R0FS](#) [RM CJ2U00R03FS](#) [RHXH1N001R0F4](#) [0868AT43A0020-EB1SMA](#) [5500L/C402D](#)
[6R3S43X107MV4E](#) [S-500](#) [L/C-402DS](#) [251R14S1R5BV4T](#) [S-SY2](#) [S805TS](#) [S805DS](#) [RWCSG4U020R0FS](#) [S-X15-EMI](#) [2450AT45A100E](#)
[6R3R14X475MV4T](#) [9702-2](#) [S-2KV](#) [S111TVE](#) [501S42E220JV4E](#) [102R18N471JV4E](#) [RWCSG4Q002R0FS](#) [S-X2Y-AEC](#) [2450L/C603D](#)
[S201TL](#) [S111DVE](#) [S-X14-PBP](#) [S-X07CBK](#) [L/C-603DS](#) [L/C-805DS](#) [S-1KV](#) [RWCSG4Q00R25FS](#) [87043-27](#) [2450FB15L0001E](#) [L201DC](#) [S-](#)
[PLY-2](#) [S-0805](#) [RWCSG1U020K0FS](#) [RM CJ3U0R005FS](#) [1200BP44A575E](#) [L402W](#) [L603W](#) [2500AT44M0400E](#)