

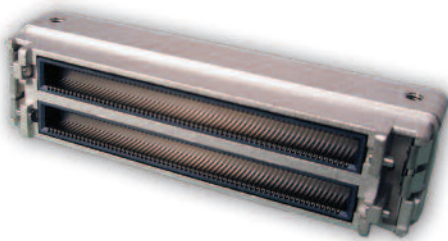

ITT

Interconnect Solutions

**Cannon
DL Series
ZIF Connectors**

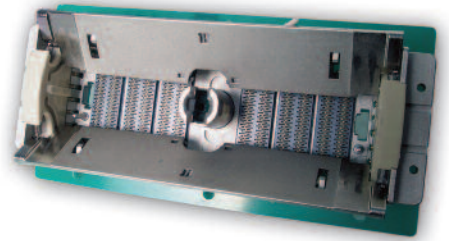
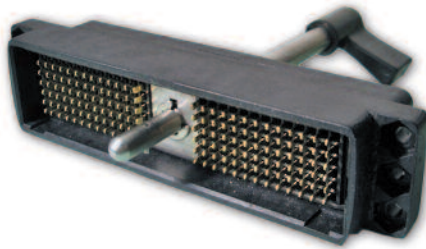

Engineered for life

Cannon, VEAM, BIW

A Historical Achievement of Technology Leadership

Defining and Championing Innovation

Showcasing a portfolio of creativity, ITT's "Engineered For Life" execution embraces products which have become ubiquitous in a broad collection of markets including: Military/Aerospace, Civil Aircraft, Industrial Instrumentation, Medical, Oil & Gas, Energy, Transportation, Telecom/Handset, Computer, Consumer, and Automotive.

ITT's rich interconnect history embraces contributions to both technological breakthroughs and social movements. With one of the industry's broadest product offerings, ITT's interconnect products have supported:

- Every Free World space mission, bringing the universe to our doorstep.
- Motion picture, radio, and television equipment, serving laughter and entertainment to millions.
- Commercial and military communications systems, linking the voices of the world.
- Computerized tools, reshaping the information highway.
- Aircraft, rapid transit, and automobiles, mobilizing our expanding society.
- Oil and natural gas production, powering the world's economies.
- Agricultural equipment, attacking the roots of world hunger.

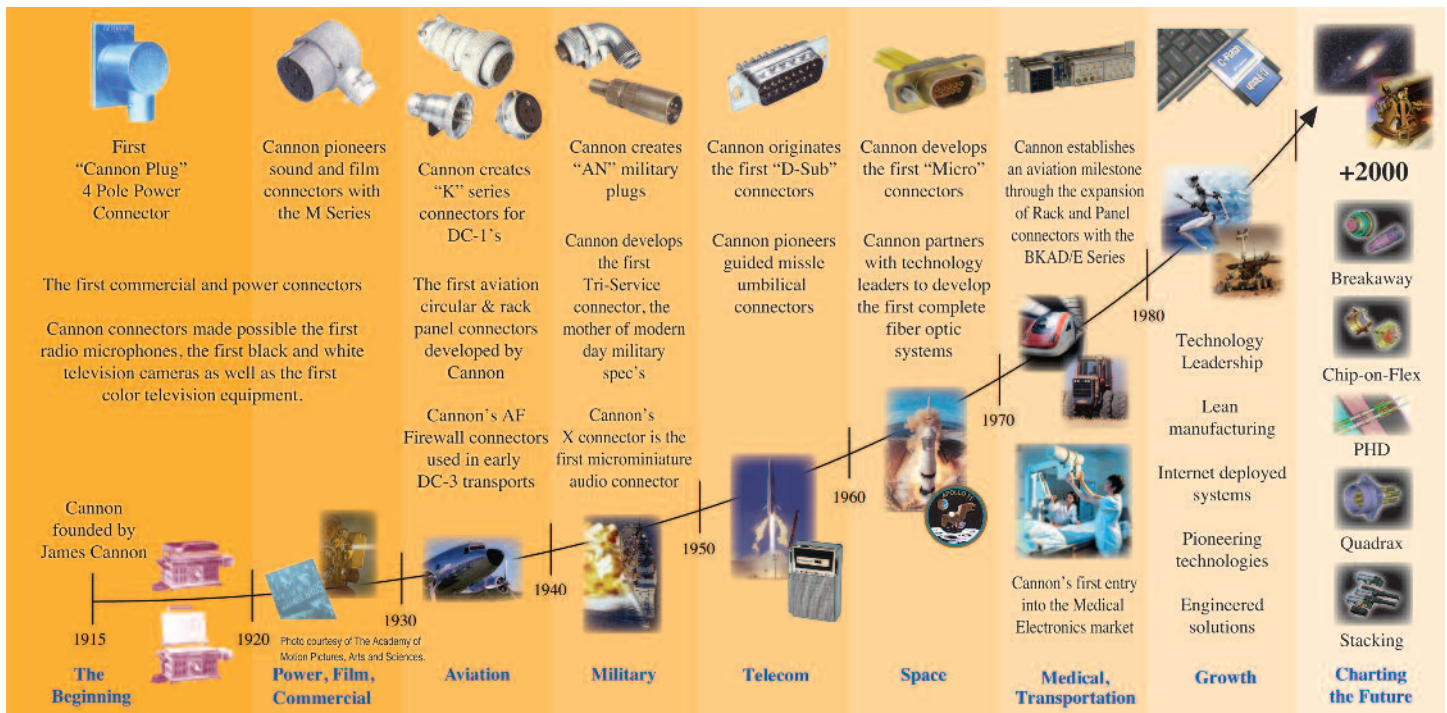

ITT Interconnect Solutions

ITT Interconnect Solutions is a division of the multi-national ITT Corporation, a \$9 billion dollar global enterprise representing the brands Cannon, VEAM, and BIW. Our connector portfolio remains the most extensive in the industry offering the most reliable and cost effective range of interconnect solutions. These innovations have enabled ITT to provide products and technologies to such markets as:

- Automotive
- Computer/Consumer
- Industrial/Instrumentation
- Military/Aerospace
- Oil Fields
- Telecom/Handset
- Transportation

When you specify a Cannon, VEAM or BIW connector, you can rely on a product designed, developed, and manufactured to the highest quality and reliability standards. This tradition of excellence is based on ITT's corporate culture of operating its businesses under the principles of Six Sigma. At ITT, Six Sigma is not just a quality philosophy but a complete corporate culture that drives the entire business. Our Value Based Management and Value Based Product Development systems are two cornerstones that allow for the development of both leadership and product engineering principles, ensuring the correct industry leading products are developed to the accepted market driven lead times. These principles have allowed ITT to become the market leader in all of our business portfolios.

Six Sigma Manufacturing

ITT operates manufacturing facilities in the United States, Germany, Italy, Mexico, China, Japan and the UK, all of which have particular product area strengths allowing ITT to offer a truly global footprint to our customers. Our facilities are world class and accommodate full vertical integration utilizing the latest manufacturing technologies including: automated and robotic machining centers, Super Market manufacturing cells, Kanban pull systems, and automated electrical, mechanical, and optical test and inspection equipment. The combination of our manufacturing strength

and our advanced manufacturing facilities allows ITT to offer products at market driven prices. Our capabilities, especially in robotics, computerized precision tooling, Kaizen Project Management, Six Sigma tools, and testing, give ITT the most optimized global manufacturing footprint in the interconnect industry.

The Custom Difference

As the industry leader in harsh environment interconnect applications, ITT's world class engineering teams will work directly with our customers to design and develop cost effective solutions for their applications. In many cases we may modify one of our standard designs to ensure a highly reliable solution where timing is critical. Yet, in those cases where a complete custom interconnect solution is required, ITT will work with our customer's Engineers to design an interconnect solution which will be cost effective yet highly reliable. As professional consultants, our Engineering teams will provide a thorough systems and mechanical analysis of any proposed solution. These analyses provide our customers with sophisticated electrical signal and mechanical characterizations to determine the best solution for their application.

RoHS Compliance Information

ITT has implemented a strict parts control plan for all ITT electronics plants worldwide that allows the Cannon, VEAM, and BIW connector product portfolios to meet the requirements of European Union Directive 2002/95/EC better known as the Reduction of Hazardous Substances initiative. As appropriate, specific Cannon, VEAM, and BIW products may be ordered with an R prefix number which insures our customers will receive RoHS compliant parts for their commercial electronics applications and equipment. Since most RoHS hazardous substances center around specific metal plating and lead solder coatings, ITT's products for RoHS compliance are available in the following plating finishes: black zinc electroless nickel, stainless steel, Anodize over aluminum and Gold plating. It should be noted that gold plating would be recommended as the replacement for tin-lead solder when ordering board mount connec-



DL



- Plastic Body
- 60, 96, 156, or 260 Contact Cavities
- Single Hand Actuation
- Crimp or Square Post Contacts

Introduction 10
 Product Specifications 11
 How to Order 12
 Layout Information. 13-16

DLD Drawer

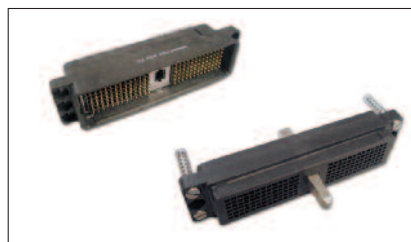

- Drawer Style
- Plastic Body
- 96 or 156 Contact Cavities
- Sliding Actuation
- Crimp or Square Post Contacts

Introduction 17
 Product Specification. 17
 How to Order 18
 Layout Information. 19-20
 Drawer Assembly Dimensions 72

DLM



- Metal Body
- EMI/RFI Shielding
- 60, 96, 156, 260 or 360 Contact Cavities
- Single Hand Actuation
- Crimp, Square Post or PC/RC Contacts

Introduction 21
 Product Specifications 22
 How to Order 23
 Layout Information. 24-28

DL4

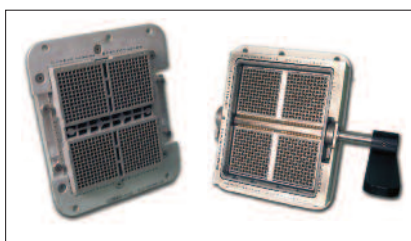

- Panel Mount
- 624, 1248, or 2496 Contact Cavities
- Lever Actuation
- Crimp or Square Post Contacts

Introduction 29
 Product Specifications 30
 How to Order 31
 Layout Information. 32-33

DLP

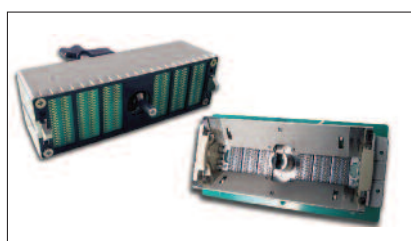

- Metal Body
- EMI/RFI Shielding
- Modular Landed Contact System
 (DLP-272- 34 Contacts/Module
 DLP-408 - 68 Contacts/Module)
- Single Hand Actuation

Introduction 34
 Product Specifications 34
 How to Order 35
 Layout Information. 36-37



QLC



- Metal Body
- EMI / RFI Shielding
- 260 Contacts
- Small form factor. For portable equipment

Introduction 38
 Product Specifications 38
 Layout Information. 39

Accessories



- Cannon offers a large selection of accessories to meet a variety of application requirements
- Allows customization using standard components

Introduction 40
 Selection Guide 40
 Junction Shells, Plastic 41-42
 Backshells, Metal 43
 Actuating Handles 44
 Protective Covering. 44-45
 Polarizing Posts 46
 Shells (EMI/RFI) 47

Contacts



- Crimp and Buss contacts are available loose or reeled
- Accommodates wire sizes #42-#18AWG
- Customer installed. Field installable/removable

Introduction 48
 Buss Contacts 49
 Crimp Contacts-Loose / Reeled 50







Tools and Assembly

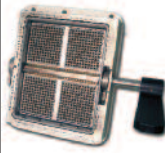

- Cannon offers hand crimp tooling for low volume applications
- Contact extraction tools
- Automatic tooling can be leased for large volume applications

Introduction 51
 Hand Crimp Tools 51
 Extraction Tools 52
 Assembly Instructions. 53-55
 Lease Automatic Tooling. 56-57

PCB Hole Pattern and Pad Layout. 58-65
 Panel Cutouts. 66-68
 Contact Cavity Arrangements. 69-71

	DL	DLD	DLM	DL4	DLP 136 - 272	DLP 408	QLC
							
Type	Plug & Receptacle	Plug & Receptacle	Plug & Receptacle	Plug & Receptacle	Plug & Receptacle	Plug & Receptacle	Plug & Receptacle
Body	Plastic	Plastic	Metal	Metal	Metal	Metal	Metal
Body Material	Thermoplastic	Thermoplastic	Aluminum	Aluminum	Aluminum	Zinc Alloy	Zinc
Available Layouts	60; 96; 156; and 260 signal	96 and 156 signal	60; 96; 156 260 and 360 signal	624 and 1248 signal	136, 204 and 272 signal	408 signal	260 signal
Crimp Contacts	yes	yes	yes	yes	-	-	-
Square Post Contacts	yes	yes	yes	yes	-	-	-
PC/RC Contacts	-	-	yes	-	-	-	-
Pressfit Contacts	yes (1)	-	yes (2)	-	no	yes	no
Current Rating	5 A max. (3)	5 A max. (3)	5 A max. (3) / 4 A max. (4)	5 A max. (3)	0,5 A max.	0,3 A max	0,5A max
Contact Resistance	15 milliohms max.	15 milliohms max.	15 milliohms max.	15 milliohms max.	30 milliohms max. (Initial)	30 milliohms max. (Initial)	100 milliohms max (includes bulk resistance)
	20 milliohms max. (5)	20 milliohms max. (5)	20 milliohms max. (5)	20 milliohms max. (5)			
			30 milliohms max. (4)				
Contact Material	20 or 50□ inches gold plated copper alloy	50□ inches gold plated copper alloy	20 or 50□ inches gold plated copper alloy	20 or 50□ inches gold plated copper alloy	Gold plated copper Alloy	Gold plated copper Alloy	40□ inch gold plated copper alloy
Operating temperature	-55°C to 105°C	-55°C to 105°C	-55°C to 105°C	-55°C to 71°C	-55°C to 85°C	-55°C to 85°C	-55°C to 85°C
RoHS compliant	yes	yes	yes	yes	yes	yes	yes
Factory terminated	Solder to PCB Through Hole	Solder to PCB Through Hole	Solder to PCB Through Hole	Solder to PCB Through Hole	Solder to PCB Through Hole	Press-fit	Solder to PCB through hole
Mating cycles	10,000 min.	100,000 min.	10,000 min.	20,000 min.	10,000 max	10,000 max	20,000 max
EMI/RFI shielding	-	-	yes	yes	yes	yes	yes
Accessories See Pages 40-47							
Actuating handles	yes	-	yes	included	yes	yes	yes
Protective Cover (Rubber) (6)	yes	-	yes	yes	-	-	-
Protective Cover (Plastic) (7)	yes	-	yes	-	yes	-	-
Metals Shell for EMI/RFI shielding	yes (5)	-	-	-	-	-	-
Plastic Junction Shell	yes	-	yes	-	-	-	-
Cable Clamps	yes	-	yes	-	-	-	-
Metals Backshell	yes	-	yes	-	-	-	-
Polarizing Posts	yes	-	yes	-	-	-	-
Page number	10-16	17-20	21-28	29-33	34-36	37	38-39

Notes:

- (1) DL5 only
- (2) DLM5 only
- (3) Crimp or Square Post Contacts
- (4) PC/RC contact
- (5) Specification for Crimp Contacts smaller than 28 AWG

The mechanical function of the new DLP ZIF connector

A quarter turn of knob (shaft) mates all the contact at once by the function of cam and bearing.

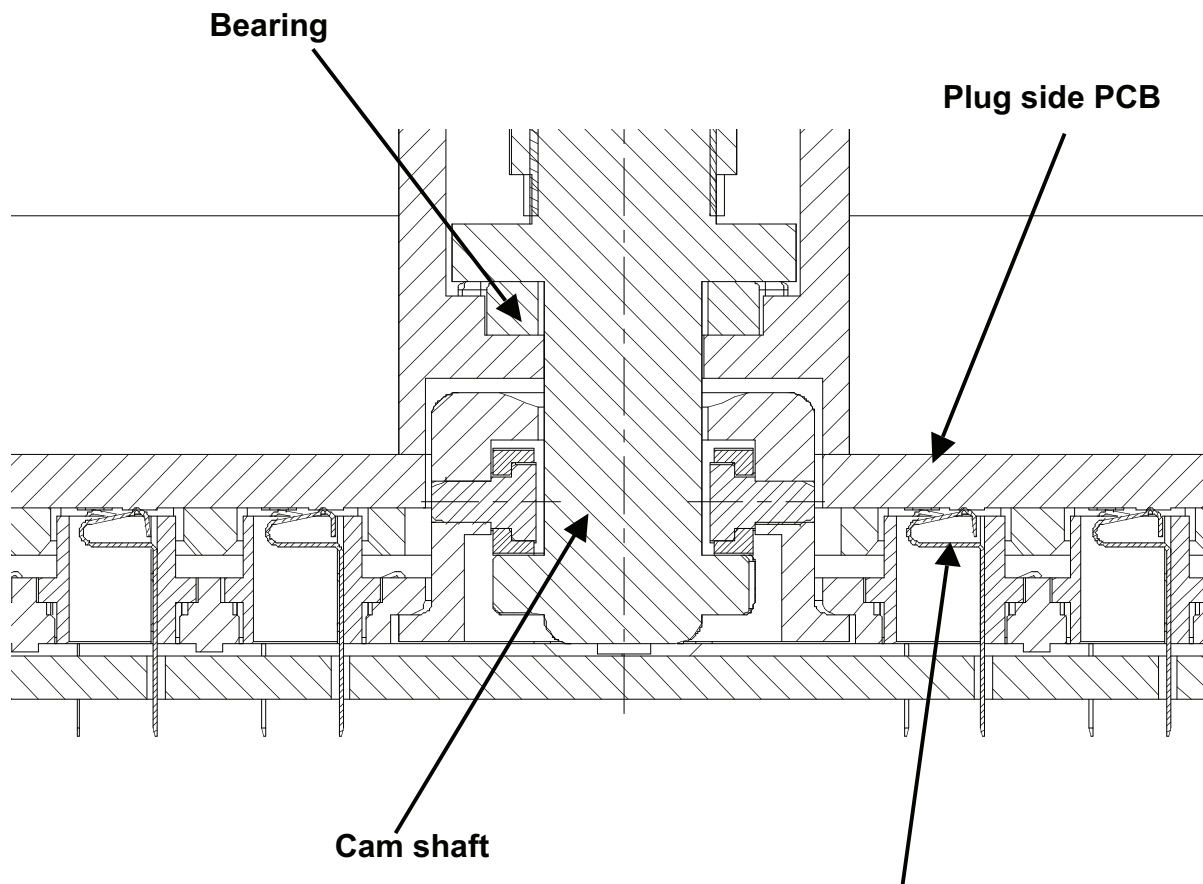

Our DLP connector uses our landed contact system. Modules of 34 or 68 contacts each are populated in to the receptacle to the customer's requirements. These contacts are positioned to land on pads that are designed into the customer supplied PCB and mounted to the plug connector housing. When mated, the contacts do not touch the pads on the plug PCB. Once the handle is rotated and locked, the shape of the receptacle contact generates a slight wipe on the plug PCB pads.

The long life and rapid mating are achieved through the use of our Zero Insertion Force design. Contact in the plug and receptacle do not touch each other while the connector halves are being engaged.

Step 1:

The plug is placed over the receptacle.

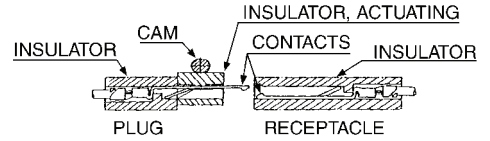
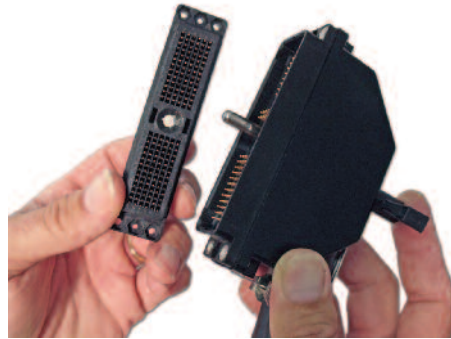

Step 2:

A "quarter turn" of an actuating shaft mates all contacts at once.

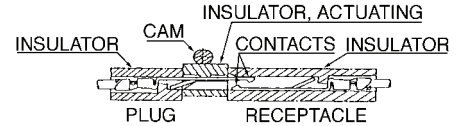
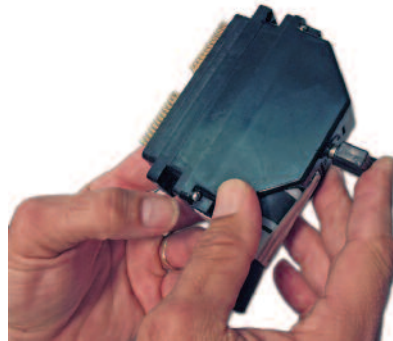

Step 3:

The same "quarter turn" also physically locks the connector halves together.

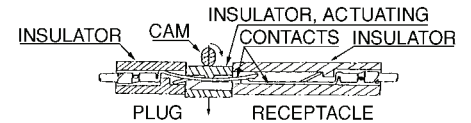

Connector engagement force is zero, and the only wear on the contacts occurs as they are pressed together and lightly wiped past each other during the camming and locking operation.



Medical

- Ultrasound Diagnostic
- Patient Monitoring
- Hospital Equipment
- MRI (Non-Magnetic)
- Portable Equipment (Imaging)

Commercial / Industrial Manufacturing

- Automation
- Robotics
- Electrical Controls

Telecommunications

- Systems Interconnect
- Manufacturing Test Equipment
- Switching Systems

Test & Instrument

- Avionics
- Automated Test Equipment
- Computer and Peripheral Equipment
- Semiconductor

Entertainment

- Recording Studio Equipment
- Stage Lighting and Sound
- Broadcasting Equipment

Transportation

- Locomotive Systems
- Automotive Electronics
- Aircraft Simulators

The Cannon DL Series of Zero Insertion Force (ZIF) connectors fill the need in the medical, commercial / industrial, computer, and peripheral equipment market places for low-cost, high performance, multiple-wire power and signal connectors.

DL connectors feature: a minimum rated life of 10,000 complete mating and unmating cycles with no performance loss; can be mated and unmated in less than two seconds even with as many as 2496 contacts; and they cost less (often as much as 25% less) per mated line than singular high-density rack-and-panel connectors.

Simple. Effective. Reliable. Durable

Combining their special design with commercial-grade materials and low cost crimp, PCB, and wrappable hermaphroditic contacts, that may be hand or machine terminated, makes the DL Series of ZIF connectors the finest low-cost-per-mated-line I/O connectors available today.

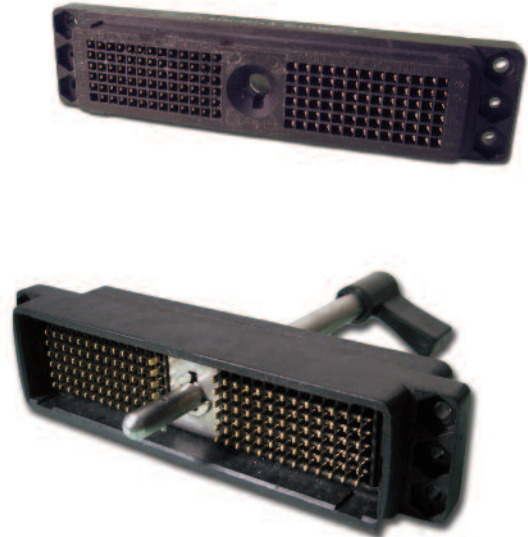

Derating Curves

DL1

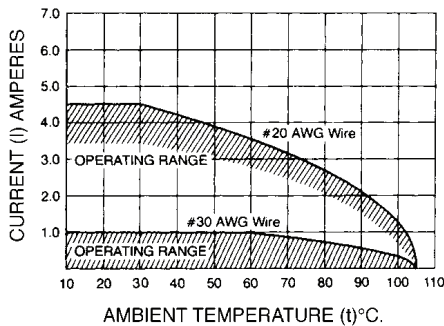

DL2

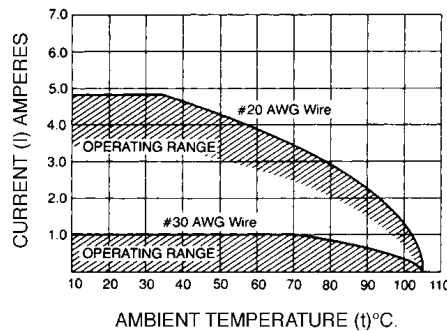

DL3

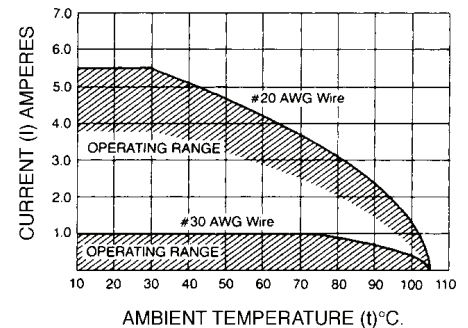

The ambient temperature curves shown represent the rated current carrying capacity of the Cannon DL1/2/3/4, electrical connectors, derated to 80% of the values recorded during the methods specified by International Electro-Technical Commission Document 48 (1975).

Current was applied to the total connector (all contacts) in one-half ampere increments and maintained at each current level until thermal stability was achieved. A thermocouple inserted into the "hottest area" of each connector then measured the connector temperature at the same time that an ambient temperature reading was taken. The difference between the two measured values is the heat rise or self-heating created solely by the current flow, and this temperature rise for the current level was deducted from the insulator material rated temperature. These values were then derated to 80% to obtain the curves shown.

Standard Materials and Finishes

DL Housing:	Glass Filled Thermoplastic, UL 94V-1 rated, Color: Black
Crimp Contacts and Square Post Contacts:	- Copper alloy, 20 or 50 microinches gold over 50 microinches nickel in mated area, gold flash on balance
Actuating Camshaft:	Stainless steel, Passivated
Insulator Retainer (Plug Only)	Stainless steel, Passivated

Electrical Data

No. of Contacts:	60, 96, 156, and 260 signal
Wire Size:	#18 AWG through #42 AWG
Contact Termination:	- Crimp - Square Post - Wrap Post - Buss - Pressfit

Mechanical Data

Actuation:	Single Hand
Coupling:	Rotating latch
Polarization:	Polarizing Posts
Contact Spacing:	2,54 (0.100) Square Grid
Shell Styles:	Plug and Receptacle

Performance Data

Current Rating:	5 A max - Crimp/Square Post/PCB contact 10 A, 20 A, 30 A, 40 A, 50 A, 60 A max - Buss contact
Dielectric Withstanding Voltage:	1200 VAC RMS - Crimp/Square Post Contact
Operating Temperature:	-55°C to 105°C (DL/DLM/DLD)
Insulation Resistance:	5000 Megaohms minimum
Durability:	10,000 Cycles minimum
Contact Resistance:	15 m Ω max. - Crimp/Square Post Contact 20 m Ω max. - Crimp #32 AWG - #30 AWG Contact
Insulation Resistance:	5000 M Ω min.
Wire Accommodation:	#42 AWG - #18 AWG
Contact Retention:	8 lb (35.585 N) minimum

How to Order

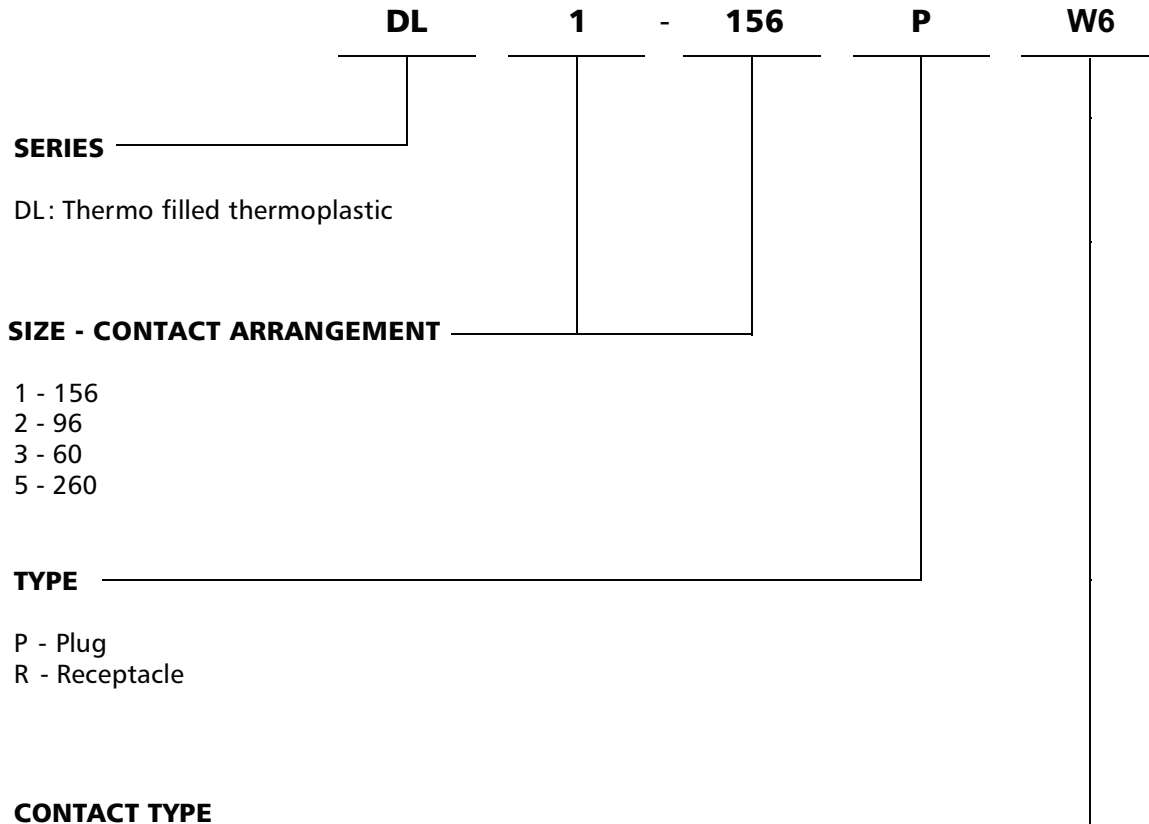

Plug



- Order Actuating Handle Kit sold separately, see page 44.
- Crimp Contacts are to be ordered separately and to be installed by customer, see pages 48-50.
- For contact cavity arrangements see pages 69-70.
- For panel cutout and mounting hole pattern, see page 66.
- For PC hole pattern, see pages 59-61.

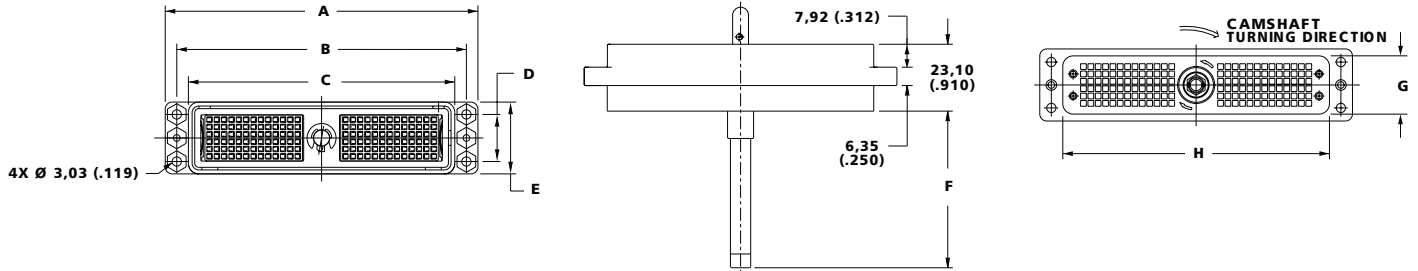

Description	A	B	C	D	E	F	G	H
DL3-60P	65,80 (2.592)	57,91 (2.280)	50,55 (1.992)	11,89 (0.466)	24,90 (0.981)	39,19 (1.543)	24,90 (0.981)	49,02 (1.931)
DL2-96P	65,80 (2.592)	57,91 (2.280)	50,60 (1.994)	19,38 (.763)	28,12 (1.108)	39,19 (1.543)	24,05 (0.947)	50,60 (1.994)
DL1-156P	108,00 (4.255)	100,03 (3.938)	92,26 (3.631)	16,26 (0.640)	24,90 (0.980)	54,81 (2.158)	20,10 (0.792)	92,10 (3.626)
DL5-260P	108,00 (4.255)	100,03 (3.938)	92,26 (3.631)	26,00 (1.024)	35,00 (1.378)	54,26 (2.136)	30,30 (1.193)	92,10 (3.626)

Receptacle

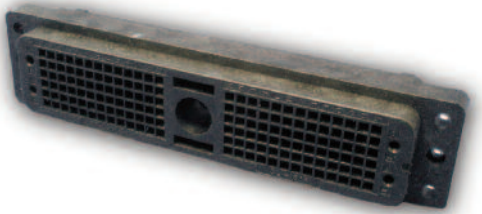

- Crimp Contacts are to be ordered separately and to be installed by customer, see pages 48-50.
- For contact cavity arrangements see pages 69-70.
- For panel cutout and mounting hole pattern, see page 66.
- For PC hole pattern, see pages 59-61.

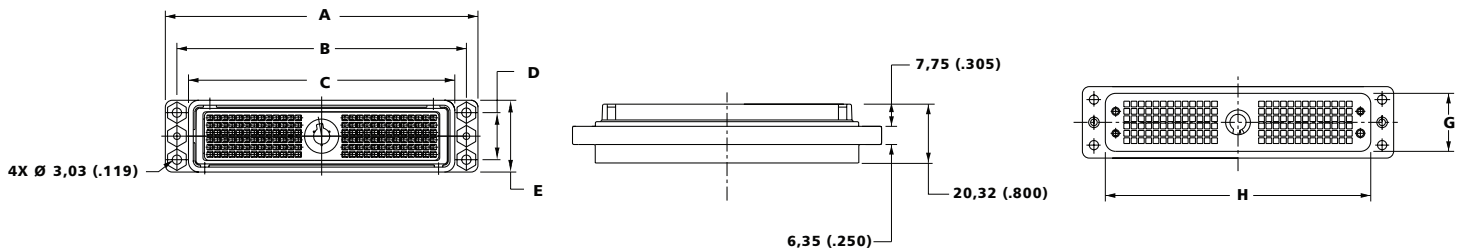

Description	A	B	C	D	E	G	H
DL3-60R	65,80 (2.592)	57,91 (2.280)	50,50 (1.988)	11,89 (0.468)	24,90 (0.981)	19,18 (0.755)	49,02 (1.931)
DL2-96R	65,80 (2.592)	57,91 (2.280)	50,60 (1.994)	19,38 (.763)	28,12 (1.108)	24,05 (0.947)	50,60 (1.994)
DL1-156R	108,00 (4.255)	100,03 (3.938)	92,10 (3.622)	16,26 (0.640)	24,90 (0.980)	20,10 (0.792)	92,10 (3.626)
DL5-260R	108,00 (4.255)	100,03 (3.938)	92,10 (3.622)	26,00 (1.024)	35,00 (1.378)	30,30 (1.193)	92,10 (3.626)

Notes:
Crimp contacts are to be ordered separately and to be installed by customer, see pages 49-50.

Dimensions shown in mm (inch)
Specifications and dimensions subject to change

Cannon ZIF Connectors

DL - Plastic Body - Square / Wrap Post Contacts

Plug

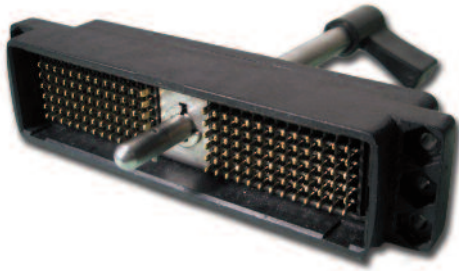

- Order Actuating Handle Kit sold separately, see page 44.
- For contact cavity arrangements see pages 69-70.
- For panel cutout and mounting hole pattern, see page 66.
- For PC hole pattern, see pages 59-61.

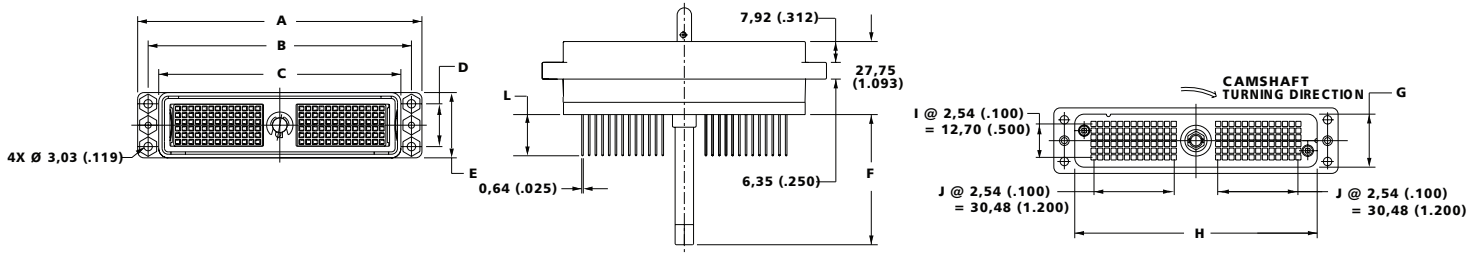

Description	A	B	C	D	E	F	G	H	I	J	L
DL3-60PW4 DL3-60PW4A	65,80 (2.592)	57,91 (2.280)	50,55 (1.992)	11,89 (.468)	24,90 (.981)	34,54 (1.360)	19,94 (.785)	49,02 (1.931)	5 spaces	4 spaces	15,37 (.605)
DL3-60PW6 DL3-60PW6A	65,80 (2.592)	57,91 (2.280)	50,55 (1.992)	11,89 (.468)	24,90 (.981)	34,54 (1.360)	19,94 (.785)	49,02 (1.931)	5 spaces	4 spaces	7,11 (.280)
DL3-60PW9A	65,80 (2.592)	57,91 (2.280)	50,55 (1.992)	11,89 (.468)	24,90 (.981)	34,54 (1.360)	19,94 (.785)	49,02 (1.931)	5 spaces	4 spaces	3,18 (.125)
DL2-96PW4 DL2-96PW4A	65,80 (2.592)	57,91 (2.280)	50,60 (1.994)	19,38 (.763)	28,12 (1.108)	34,54 (1.360)	24,05 (.947)	50,60 (1.994)	7 spaces	6 spaces	15,37 (.605)
DL2-96PW6 DL2-96PW6A	65,80 (2.592)	57,91 (2.280)	50,60 (1.994)	19,38 (.763)	28,12 (1.108)	34,54 (1.360)	24,05 (.947)	50,60 (1.994)	7 spaces	6 spaces	7,11 (.280)
DL2-96PW9A	65,80 (2.592)	57,91 (2.280)	50,60 (1.994)	19,38 (.763)	28,12 (1.108)	34,54 (1.360)	24,05 (.947)	50,60 (1.994)	7 spaces	6 spaces	3,18 (.125)
DL1-156PW4 DL1-156PW4A	108,00 (4.255)	100,03 (3.983)	92,26 (3.631)	16,26 (.640)	24,90 (.981)	50,16 (1.975)	20,10 (.792)	92,10 (3.626)	5 spaces	12 spaces	15,37 (.605)
DL1-156PW6 DL1-156PW6A	108,00 (4.255)	100,03 (3.983)	92,26 (3.631)	16,26 (.640)	24,90 (.981)	50,16 (1.975)	20,10 (.792)	92,10 (3.626)	5 spaces	12 spaces	7,11 (.380)
DL1-156PW9A	108,00 (4.255)	100,03 (3.983)	92,26 (3.631)	16,26 (.640)	24,90 (.981)	50,16 (1.975)	20,10 (.792)	92,10 (3.626)	5 spaces	12 spaces	3,18 (.125)
DL5-260PW4 DL5-260PW4A	108,00 (4.255)	100,03 (3.983)	92,26 (3.631)	26,00 (1.024)	35,00 (1.378)	49,61 (1.953)	30,30 (1.193)	92,10 (3.626)	9 spaces	12 spaces	15,37 (.604)
DL5-260PW6 DL5-260PW6A	108,00 (4.255)	100,03 (3.983)	92,26 (3.631)	26,00 (1.024)	35,00 (1.378)	49,61 (1.953)	30,30 (1.193)	92,10 (3.626)	9 spaces	12 spaces	7,11 (.280)
DL5-260PW9A	108,00 (4.255)	100,03 (3.983)	92,26 (3.631)	26,00 (1.024)	35,00 (1.378)	49,61 (1.953)	30,30 (1.193)	92,10 (3.626)	9 spaces	12 spaces	3,18 (.125)

Notes:
Front removable 0,64 (0.025) square posts 2,54 (0.100) Centers.
1 space at 2,54 (0.100)

Dimensions shown in mm (inch)
Specifications and dimensions subject to change



www.ittcannon.com

Receptacle



- For contact cavity arrangements see pages 69-70.
- For panel cutout and mounting hole pattern, see page 66.
- For PC hole pattern, see pages 59-61.

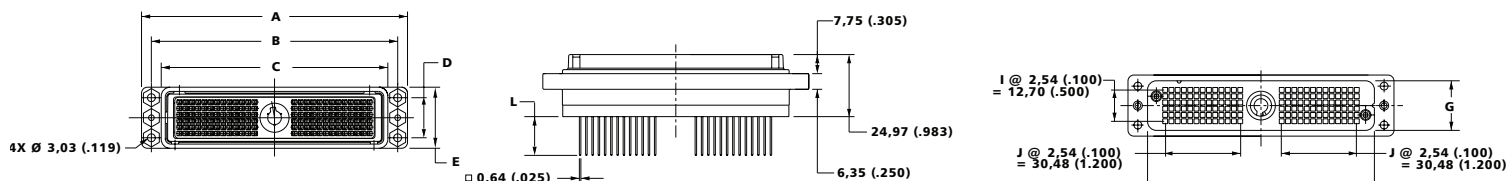

Description	A	B	C	D	E	G	H	I	J	L
DL3-60RW4 DL3-60RW4B	65,80 (2.592)	57,91 (2.280)	50,50 (1.988)	11,89 (.466)	24,90 (.980)	19,94 (0.785)	49,02 (1.931)	5 spaces	4 spaces	15,37 (.605)
DL3-60RW6 DL3-60RW6B	65,80 (2.592)	57,91 (2.280)	50,50 (1.988)	11,89 (.466)	24,90 (1.360)	19,94 (.785)	49,02 (1.931)	5 spaces	4 spaces	7,11 (.280)
DL3-60RW9B	65,80 (2.592)	57,91 (2.280)	50,50 (1.988)	11,89 (0.466)	24,90 (1.360)	19,94 (.785)	49,02 (1.931)	5 spaces	4 spaces	3,18 (.125)
DL2-96TW4 DL2-96RW4B	65,80 (2.592)	57,91 (2.280)	50,60 (1.994)	19,38 (.763)	28,12 (1.108)	24,05 (.947)	50,60 (1.994)	7 spaces	6 spaces	15,37 (.605)
DL2-96RW6 DL2-96RW6B	65,80 (2.592)	57,91 (2.280)	50,60 (1.994)	19,38 (.763)	28,12 (1.108)	24,05 (.947)	50,60 (1.994)	7 spaces	6 spaces	7,11 (.280)
DL2-96RW9B	65,80 (2.592)	57,91 (2.280)	50,60 (1.994)	19,38 (.763)	28,12 (1.108)	24,05 (.947)	50,60 (1.994)	7 spaces	6 spaces	3,18 (.125)
DL1-156RW4 DL1-156RW4B	108,00 (4.255)	100,03 (3.983)	92,00 (3.622)	16,26 (.640)	24,90 (.980)	20,10 (.792)	92,10 (3.626)	5 spaces	12 spaces	15,37 (.605)
DL1-156RW6 DL1-156RW6B	108,00 (4.255)	100,03 (3.983)	92,00 (3.622)	16,26 (.640)	24,90 (.980)	20,10 (.792)	92,10 (3.626)	5 spaces	12 spaces	7,11 (.380)
DL1-156RW9B	108,00 (4.255)	100,03 (3.983)	92,00 (3.622)	16,26 (.640)	24,90 (.980)	20,10 (.792)	92,10 (3.626)	5 spaces	12 spaces	3,18 (.125)
DL5-260RW4 DL5-260RW4B	108,00 (4.255)	100,03 (3.983)	92,00 (3.622)	26,00 (1.024)	35,00 (1.378)	30,30 (1.193)	92,10 (3.626)	9 spaces	12 spaces	15,37 (.604)
DL5-260RW6 DL5-260RW6B	108,00 (4.255)	100,03 (3.983)	92,00 (3.622)	26,00 (1.024)	35,00 (1.378)	30,30 (1.193)	92,10 (3.626)	9 spaces	12 spaces	7,11 (.280)
DL5-260RW9B	108,00 (4.255)	100,03 (3.983)	92,00 (3.622)	26,00 (1.024)	35,00 (1.378)	30,30 (1.193)	92,10 (3.626)	9 spaces	12 spaces	3,18 (.125)

Notes:

Front removable 0,64 (0.025) square posts 2,54 (0.100) Centers.

1 space at 2,54 (0.100)

Receptacle only



- For contact cavity arrangements see page 70.
- For panel cutout and mounting hole pattern, see page 66.
- For PC hole pattern, see page 62.

Part Number	Nomenclature
11987-0008	DL5-260R-F

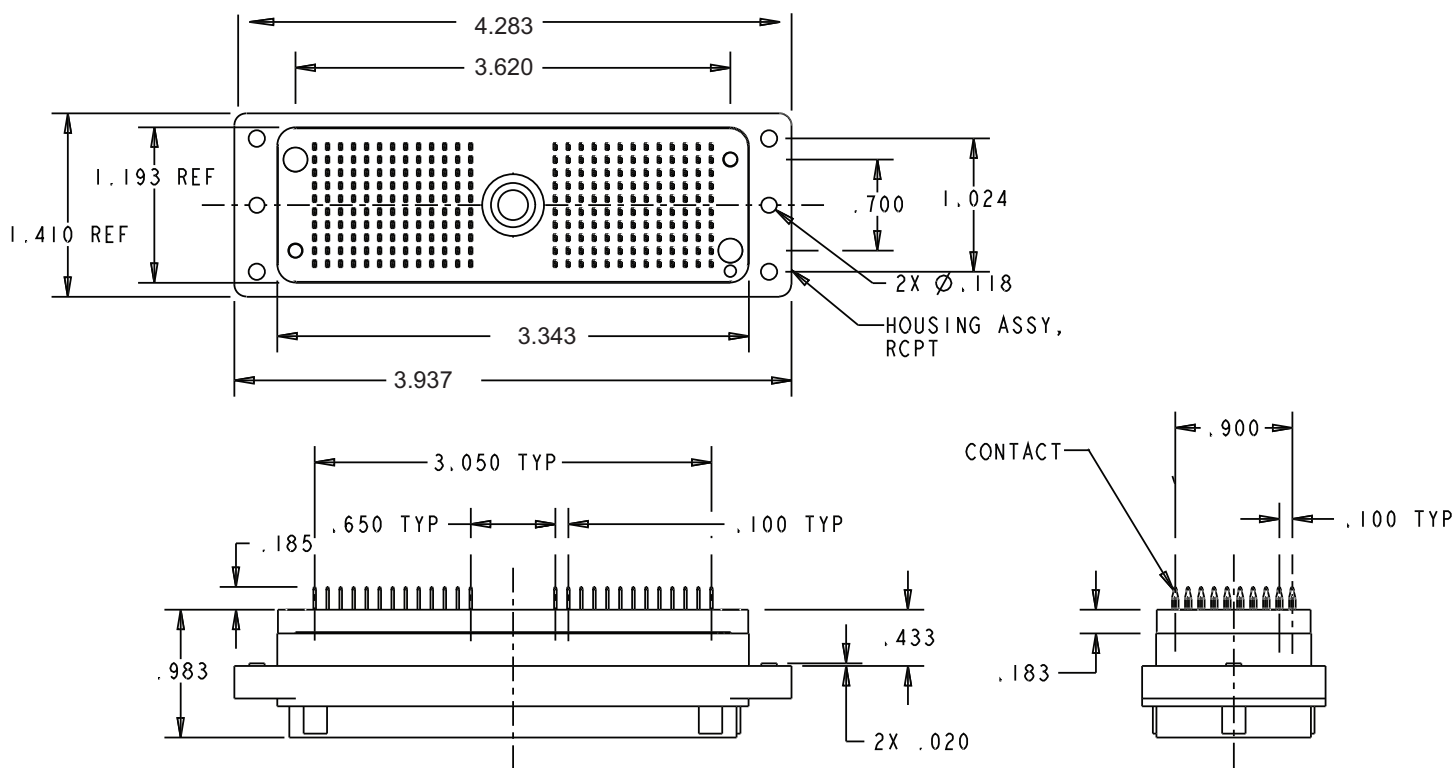

Cannon has combined Zero Insertion Force (ZIF) technology with remote electrical engagement. The DLD Drawer allows the movement of a drawer or panel to effortlessly mate/unmate the connector halves. As an example: electrical sub-systems can be easily removed for service, interchangeability, or portability.

By specifying DLD Drawer interconnect systems, your packaging design is simplified as the need for expensive, complicated, and space-consuming manual actuation mechanisms is eliminated. Tight space requirements no longer restrict your use of ZIF connectors.

The contacts in the DLD Drawer product line do not touch each other while the connector halves are mating. This unique ZIF technology, introduced in the Cannon DL series in the early 1970's, has time-tested proven reliability and durability.

The DLD Drawer's remote mating feature utilizes the axial thrust of a cam to move and mate the contacts. At the end of the cam travel, the cam ramps on a flat surface thereby negating any uncoupling forces.

This rack-and-panel connector is available with crimp or square post contacts, allowing cable, PCB, or flat-flex termination.

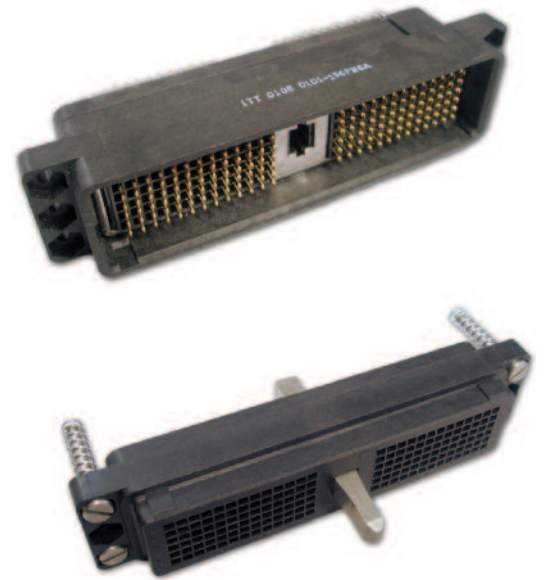

Standard Materials and Finishes

DLD Housing:	Glass Filled Thermoplastic, UL 94V-1 rated, Color: Black
Crimp Contacts:	Copper alloy, 20 or 50 microinches gold over 50 microinches nickel in mated area, gold flash on balance
Insulator Retainer (1):	Stainless steel, Passivated
Actuating Camshaft (2):	Stainless steel
Spring Mounting Screw (2):	Stainless steel, Passivated

Electrical Data

No. of Contacts:	96 and 156 signal
Wire Size:	#18 AWG through #42 AWG
Contact Termination:	Crimp, Square Post, Wrap Post, Buss

Mechanical Data

Actuation:	Sliding
Coupling:	Guide Cam
Polarization:	Polarizing Posts
Contact Spacing:	2,54 (.100) Square Grid
Shell Styles:	Plug and Receptacle

Performance Data

Dielectric Withstanding Voltage:	1200 VAC RMS - Crimp/Square Post Contact
Insulation Resistance	5000 Megaohms minimum
Durability:	100,000 Cycles minimum
Contact Resistance:	- 15 milliohms maximum - Crimp/Square Post Contact - 20 milliohms maximum - Crimp #30- #32 AWG contact
Contact Retention:	6 lb (35,564 N) minimum

How to Order

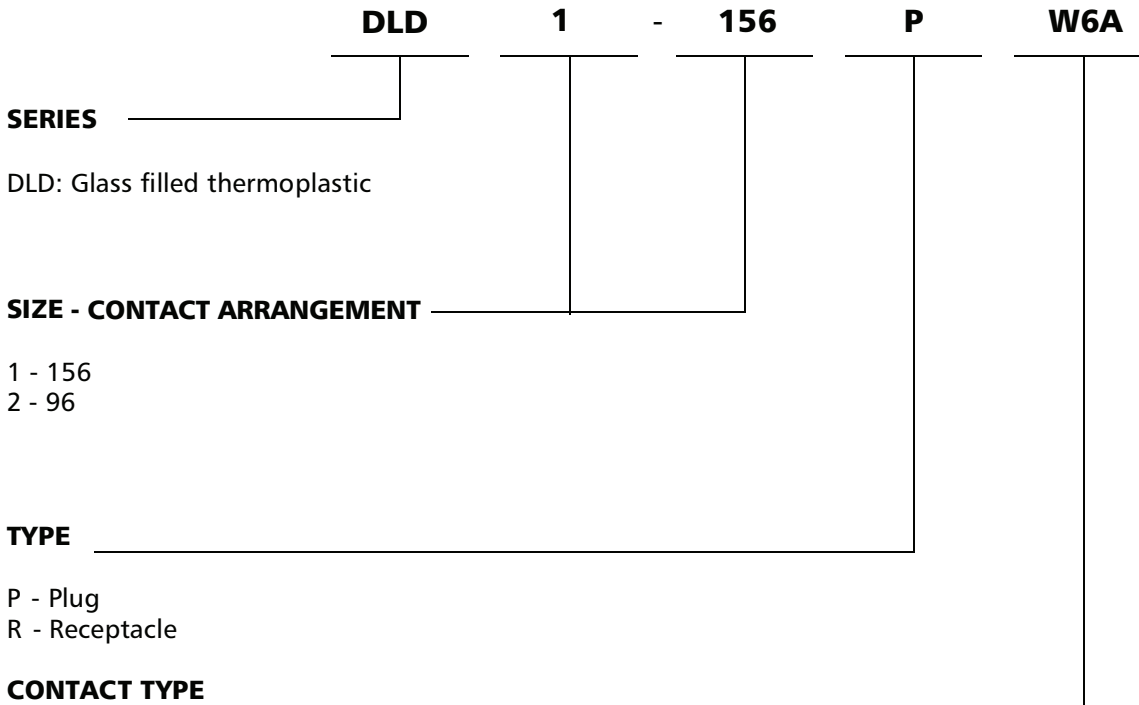

No letter - Crimp #18 thru #42 AWG
TO BE ORDERED SEPARATELY AND INSTALLED BY CUSTOMER

- W4 - Wrap Post 15,37 (0.605), 20 μinches Gold
- W4A - Wrap Post 15,37 (0.605), 50 μinches Gold, Plug only
- W4B - Wrap Post 15,37 (0.605), 50 μinches Gold, Receptacle only
- W6 - Square Post 7,11 (0.280), 20 μinches Gold
- W6A - Square Post 7,11 (0.280), 50 μinches Gold, Plug only
- W6B - Square Post 7,11 (0.280), 50 μinches Gold, Receptacle only
- W9A - Square Post 3,18 (0.125), 50 μinches Gold
- W9B - Square Post 3,18 (0.125), 50 μinches Gold, Receptacle only



Plug



- Crimp contacts are to be ordered separately and to be installed by customer, see pages 48-50.
- For contact cavity arrangements see page 69.
- For panel cutout and mounting hole pattern, see pages 67-68.

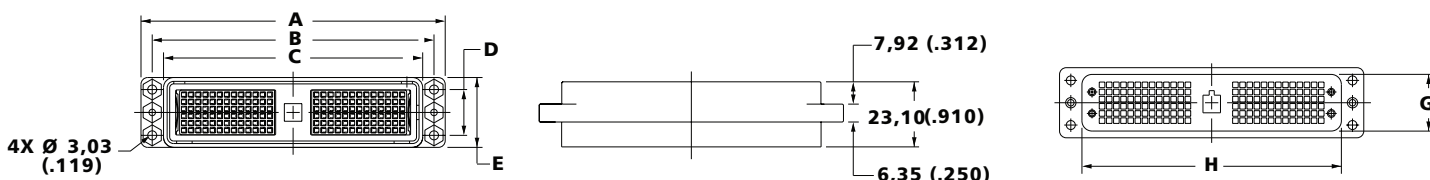

Description	A	B	C	D	E	G	H
DLD2-96P	65,80 (2.592)	57,91 (2.280)	50,60 (1.994)	19,38 (0.763)	26,12 (1.108)	24,05 (0.947)	50,60 (1.994)
DLD1-156P	108,00 (4.255)	100,03 (3.983)	92,26 (3.631)	16,26 (0.640)	24,90 (0.980)	20,10 (0.792)	92,10 (3.626)

Receptacle



- Crimp contacts are to be ordered separately and to be installed by customer, see pages 48-50.
- For contact cavity arrangements see page 69.
- For panel cutout and mounting hole pattern, see pages 67-68.

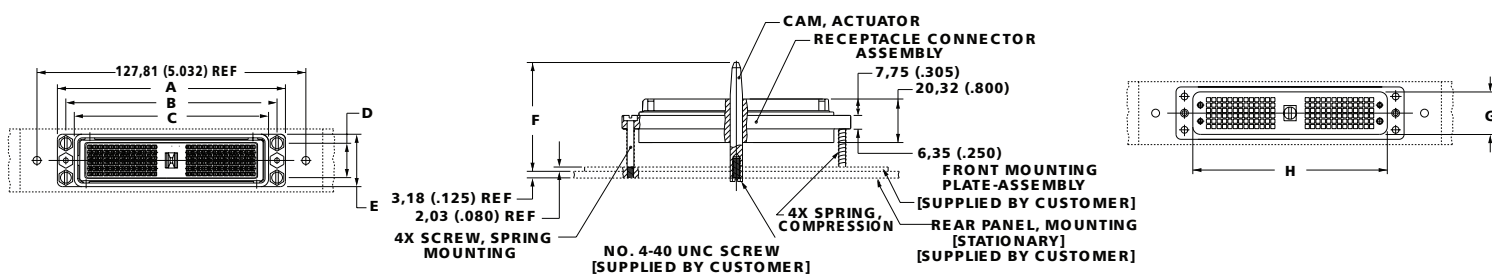

Description	A	B	C	D	E	F	G	H
DLD2-96R	65,80 (2.592)	57,91 (2.280)	50,60 (1.994)	19,38 (.763)	28,12 (1.108)	46,87 (1.845)	24,05 (0.947)	50,60 (1.994)
DLD-156R	108,00 (4.255)	100,03 (3.983)	92,00 (3.622)	16,26 (0.640)	24,90 (0.980)	46,86 (1.845)	20,10 (0.792)	92,10 (3.626)

Dimensions shown in mm (inch)
Specifications and dimensions subject to

www.ittcannon.com



Cannon ZIF Connectors

DLD - Plastic Body - Square / Wrap Post Contacts

Plug



- For contact cavity arrangements see page 69.
- For panel cutout and mounting hole pattern, see pages 67-68.
- For PC hole pattern, see pages 60-61.

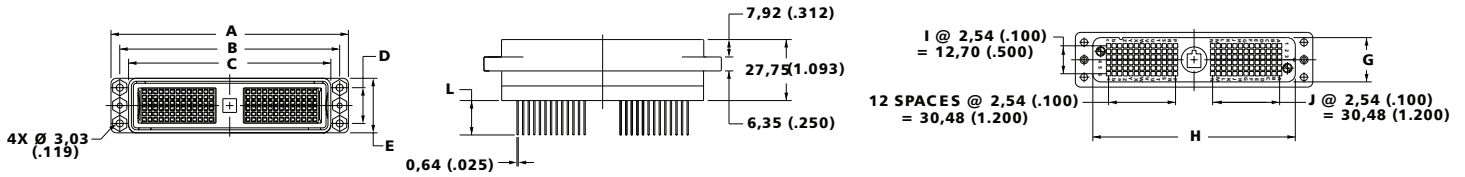

Description	A	B	C	D	E	G	H	I	J	L
DLD2-96PW4 DLD2-96PW4A	65,80 (2.592)	57,91 (2.280)	50,60 (1.994)	19,38 (.763)	28,12 (1.108)	24,05 (.947)	50,60 (1.994)	7 spaces	6 spaces	15,37 (.605)
DLD2-96PW6 DLD2-96PW6A	65,80 (2.592)	57,91 (2.280)	50,60 (1.994)	19,38 (.763)	28,12 (1.108)	24,05 (.947)	50,60 (1.994)	7 spaces	6 spaces	7,11 (.280)
DLD2-96PW9A	65,80 (2.592)	57,91 (2.280)	50,60 (1.994)	19,38 (.763)	28,12 (1.108)	24,05 (.947)	50,60 (1.994)	7 spaces	6 spaces	3,18 (.125)
DLD1-156PW4 DLD1-156PW4A	108,00 (4.255)	100,03 (3.983)	92,26 (3.631)	16,26 (.640)	24,80 (.977)	20,10 (.792)	92,10 (3.626)	5 spaces	12 spaces	15,37 (.605)
DLD1-156PW6 DLD1-156PW6A	108,00 (4.255)	100,03 (3.983)	92,26 (3.631)	16,26 (.640)	24,90 (.980)	20,10 (.792)	92,10 (3.626)	5 spaces	12 spaces	7,11 (.280)
DLD1-156PW9A	108,00 (4.255)	100,03 (3.983)	92,26 (3.631)	16,26 (.640)	24,90 (.980)	20,10 (.792)	92,10 (3.626)	5 spaces	12 spaces	3,18 (.125)

Receptacle



- For contact cavity arrangements see page 69.
- For panel cutout and mounting hole pattern, see pages 67-68.
- For PC hole pattern, see pages 60-61.

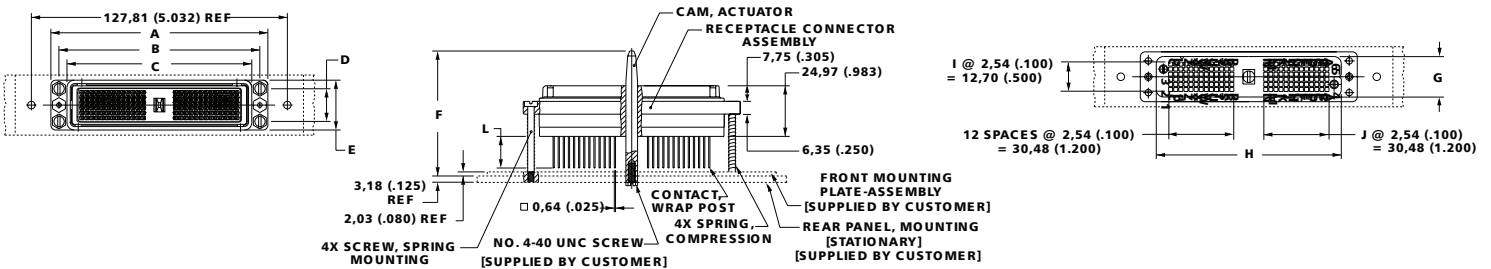

Description	A	B	C	D	E	F	G	H	I	J	L
DLD2-96RW4 DLD2-96RW4B	65,80 (2.592)	57,91 (2.280)	50,60 (1.994)	19,38 (.763)	28,12 (1.108)	57,03 (1.245)	24,05 (.947)	50,60 (1.994)	7 spaces	6 spaces	15,37 (0.605)
DLD2-96RW6 DLD2-96RW6B	65,80 (2.592)	57,91 (2.280)	50,60 (1.994)	19,38 (.763)	26,12 (1.108)	57,03 (1.245)	24,05 (.947)	50,60 (1.994)	7 spaces	6 spaces	7,11 (0.280)
DLD1-156RW4 DLD1-156RW4B	108,00 (4.255)	100,03 (3.983)	92,26 (3.631)	16,26 (.640)	24,80 (.977)	57,03 (1.245)	20,10 (.792)	92,10 (3.626)	5 spaces	12 spaces	15,37 (0.605)
DLD1-156RW6 DLD1-156RW6B	108,00 (4.255)	100,03 (3.983)	92,00 (3.622)	16,26 (.640)	24,90 (.980)	57,03 (1.245)	20,10 (.792)	92,10 (3.626)	5 spaces	12 spaces	7,11 (0.380)
DLD1-156RW9A	108,00 (4.255)	100,03 (3.983)	92,00 (3.622)	16,26 (.640)	24,90 (.980)	57,03 (1.245)	20,10 (.792)	92,10 (3.626)	5 spaces	12 spaces	7,11 (0.380)



Dimensions shown in mm (inch)
Specifications and dimensions subject to change

www.ittcannon.com

Cannon has expanded the DL-ZIF series offering with the addition of the DLM (Metal Shell) versions. The DLM uses a rugged nickel plated aluminum housing. The Shield-Locking Mechanism feature (see illustration below) ensures uniform mating pressure around the perimeter of the mated connector to create an EMI/RFI shield which facilitates compliance of equipment to CE EMC directives.



The DLM Series connectors are intermateable to the DL (Plastic) versions for backwards/forwards compatibility. The DLM Series are offered with all of the DL plastic contacts from crimp, square post, and round PL/RC tail contacts.

Derating Curves

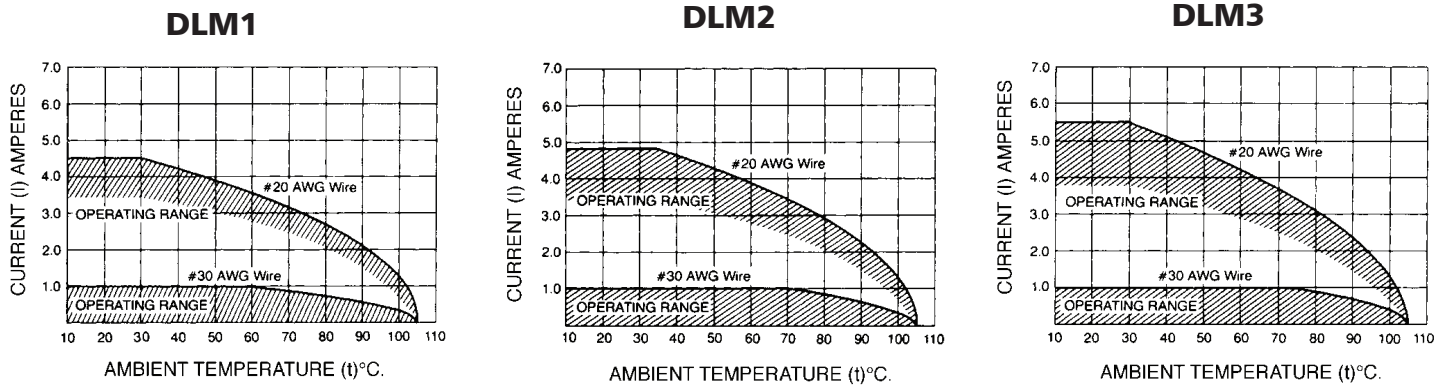

The ambient temperature curves shown represent the rated current carrying capacity of the Cannon DL1/2/3/4, DLM1/2/3 and DLD1/2 electrical connectors, derated to 80% of the values recorded during the methods specified by International Electro-Technical Commission Document 48 (1975).

Current was applied to the total connector (all contacts) in one-half ampere increments and maintained at each current level until thermal stability was achieved. A thermocouple inserted into the "hottest area" of each connector then measured the connector temperature at the same time that an ambient temperature reading was taken. The difference between the two measured values is the heat rise or self-heating created solely by the current flow, and this temperature rise for the current level was deducted from the insulator material rated temperature. These values were then derated to 80% to obtain the curves shown.

Standard Materials and Finishes

DLM Housing:	Aluminum alloy, nickel plated
DLM Insulator Crimp Contacts and Square Post Contacts:	Copper alloy, 20 or 50 microinches gold over 50 microinches nickel in mated area, gold flash on balance
PC/RC Contacts:	Copper alloy, 20 microinches gold over nickel in mated area, Sn over Nickel in tail area
Actuating Camshaft:	Stainless steel, Passivated
Insulator Retainer (Plug only):	Stainless steel, Passivated

Electrical Data

No. of Contacts:	60, 96, 156, 260 and 360 signal
Wire Size:	#18 AWG through #42 AWG
Contact Termination:	<ul style="list-style-type: none"> - PC/RC - Crimp - Square Post - Wrap Post - Buss - Pressfit

Mechanical Data

Actuation:	Single Hand
Coupling:	Rotating Latch
Polarization:	Polarizing Posts
Contact Spacing:	2,54 (.100) Square Grid
Shell Styles:	Plug and Receptacle
Actuation:	Single Hand

Performance Data

Dielectric Withstanding Voltage:	1200 VAC RMS - Crimp/Square Post Contact 1000 VAC RMS - PC/RC Contacts
Insulation Resistance	5000 Megaohms minimum
Durability:	10,000 Cycles minimum
Contact Resistance:	<ul style="list-style-type: none"> - 15 milliohms maximum - Crimp/Square Post Contact - 20 milliohms maximum - Crimp #30- #32 AWG contact - 30 milliohms maximum - PC/RC Contact
Contact Retention:	8 lb (35,585 N) minimum



How to Order

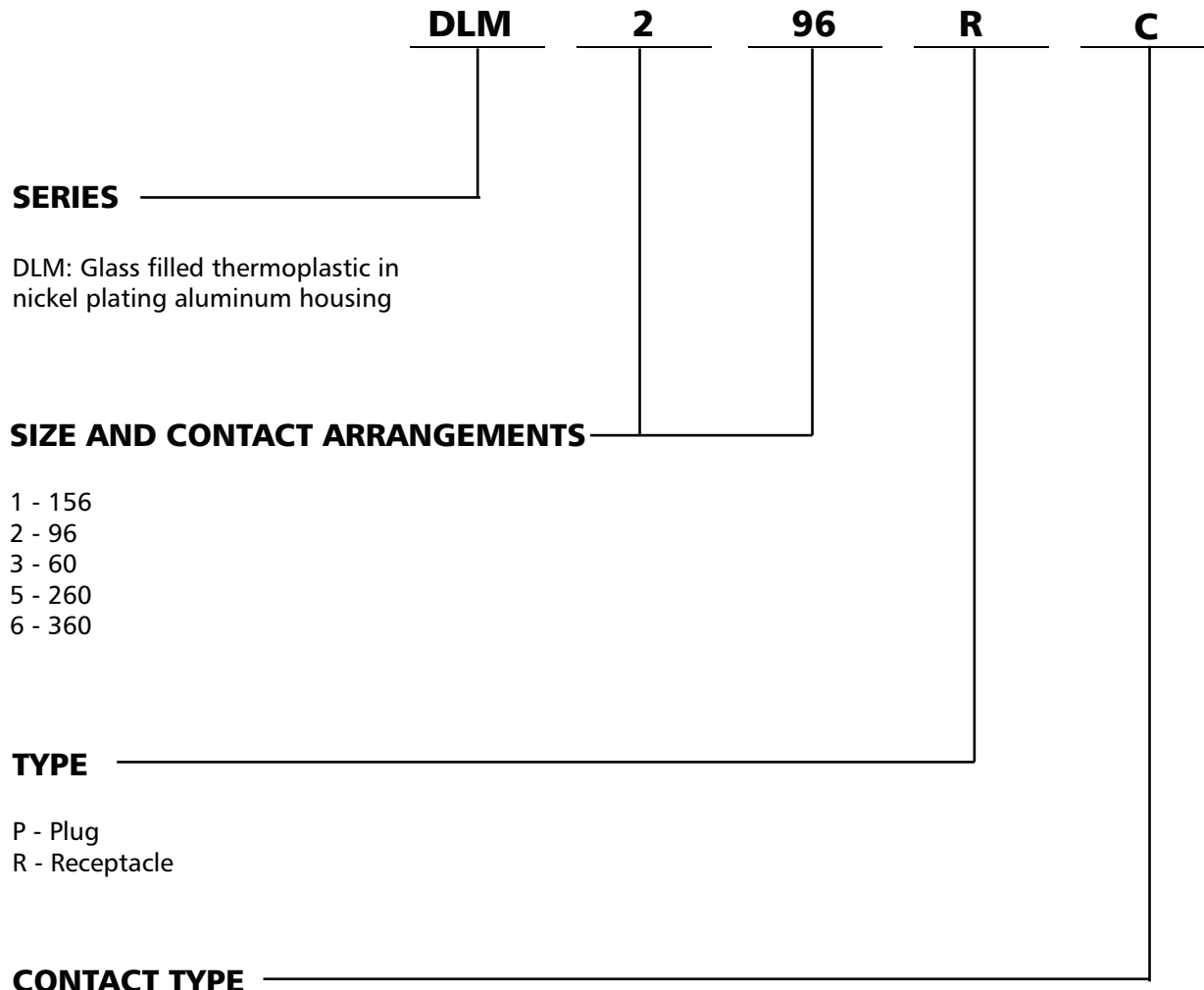

DLM: Glass filled thermoplastic in nickel plating aluminum housing

- 1 - 156
- 2 - 96
- 3 - 60
- 5 - 260
- 6 - 360

- P - Plug
- R - Receptacle

No letter - Crimp #18 thru #42 AWG.
 TO BE ORDERED SEPARATELY AND INSTALLED BY CUSTOMER

- W4 - Wrap Post 15,37 (0.605) 20 μ inches Gold
- W4A - Wrap Post 15,37 (0.605) 50 μ inches Gold, Plug only
- W4B - Wrap Post 15,37 (0.605) 50 μ inches Gold, Receptacle only
- W6 - Square Post 7,11 (0.260) 20 μ inches Gold
- W6A - Square Post 7,11 (0.260) 50 μ inches Gold, Plug only
- W6B - Square Post 7,11 (0.260) 50 μ inches Gold, Receptacle only
- W9A - Square Post 3,18 (0.125), 50 μ iinches Gold, Plug only
- W9B - Square Post 3,18 (0.125), 50 μ inches Gold, Receptacle only
- C - F - PC / RC 4,50 (0.177), 20 μ inches Gold
- PF- Pressfit - DLM5 Plug and Receptacle only

Plug

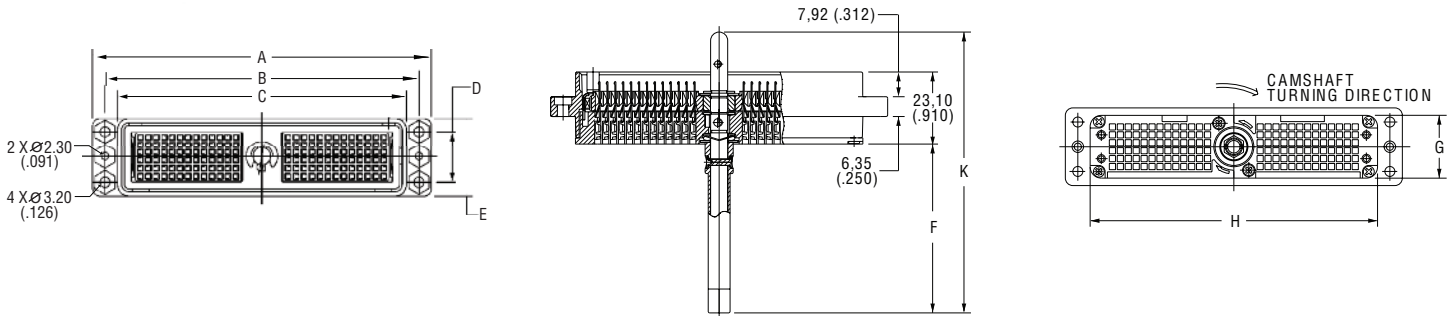

- Order Actuating Handle Kit sold separately, see page 44.
- Crimp contacts are to be ordered separately and to be installed by customer, see pages 48-50.
- For contact cavity arrangements see pages 69-70.
- For panel cutout and mounting hole pattern, see page 66.

Description	A	B	C	D	E	F	G	H	K
DLM3-60P	65,80 (2.592)	57,91 (2.280)	50,55 (1.992)	11,89 (.468)	24,90 (.981)	38,85 (1.530)	24,90 (.981)	49,02 (1.931)	74,75 (2.945)
DLM2-96P	65,80 (2.592)	57,91 (2.280)	50,60 (1.994)	19,38 (.763)	28,12 (1.108)	38,85 (1.530)	24,05 (.947)	50,60 (1.994)	74,75 (2.945)
DLM1-156P	108,00 (4.255)	100,03 (3.983)	92,00 (3.622)	16,26 (.640)	24,80 (.977)	54,10 (2.132)	20,10 (0.792)	92,10 (3.626)	90,00 (3.546)
DLM5-260P	108,00 (4.255)	100,03 (3.983)	92,00 (3.622)	26,00 (1.024)	35,00 (1.378)	54,81 (2.158)	26,00 (1.024)	92,00 (3.626)	90,00 (3.546)
DLM6-360P	125,00 (4.921)	115,00 (4.528)	104,30 (4.106)	29,00 (1.142)	42,60 (1.677)	69,00 (2.717)	37,80 (1.488)	107,30 (4.224)	104,70 (4.122)

Receptacle



- Crimp contacts are to be ordered separately and to be installed by customer, see pages 48-50.
- For contact cavity arrangement see pages 69-70.
- For panel cutout and mounting hole pattern, see page 66.

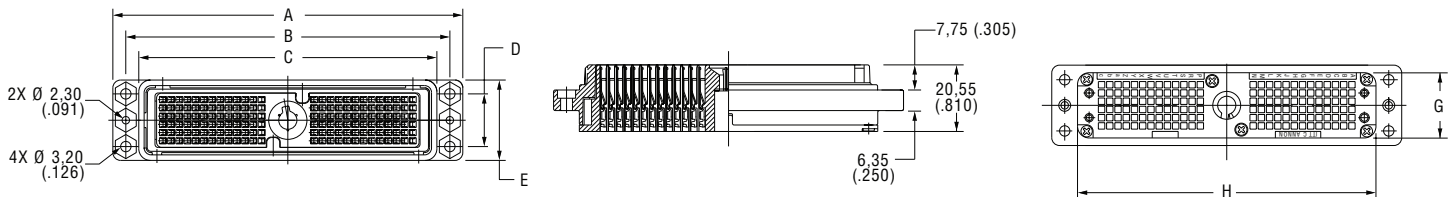

Description	A	B	C	D	E	G	H
DLM3-60R	65,80 (2.592)	57,91 (2.280)	50,55 (1.992)	11,89 (.468)	24,90 (.981)	19,94 (.785)	49,02 (1.931)
DLM2-96PR	65,80 (2.592)	57,91 (2.280)	50,60 (1.994)	19,38 (.763)	28,12 (1.108)	24,05 (.947)	50,60 (1.994)
DLM1-156R	108,00 (4.255)	100,03 (3.983)	92,00 (3.622)	16,26 (.640)	24,80 (.977)	20,10 (.792)	92,10 (3.629)
DLM5-260R	108,00 (4.255)	100,03 (3.983)	92,00 (3.626)	26,00 (1.024)	35,00 (1.378)	30,30 (1.193)	92,10 (3.629)
DLM6-360R	125,00 (4.921)	115,00 (4.528)	104,30 (4.106)	29,00 (1.142)	42,60 (1.677)	37,80 (1.488)	107,30 (4.224)



Dimensions shown in mm (inch)
Specifications and dimensions subject to change

Plug



- Order Actuating Handle Kit sold separately, see page 44.
- For contact cavity arrangements see pages 69-70
- For panel cutout and mounting hole pattern, see page 66.
- For PC hole pattern, see pages 59-61.

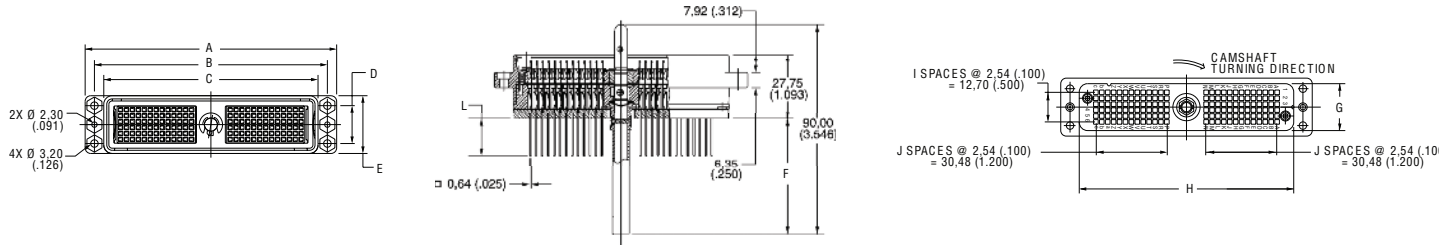

Description	A	B	C	D	E	F	G	H	I	J	L
DLM3-60PW4 DLM3-60PW4A	65,80 (2.592)	57,91 (2.280)	50,55 (1.992)	11,89 (.468)	24,90 (.981)	34,20 (1.347)	19,94 (.785)	49,02 (1.931)	5 spaces	4 spaces	15,37 (.605)
DLM3-60PW6 DLM3-60PW6A	65,80 (2.592)	57,91 (2.280)	50,55 (1.992)	11,89 (.468)	24,90 (.981)	34,20 (1.347)	19,94 (.785)	49,02 (1.931)	5 spaces	4 spaces	15,37 (.605)
DLM3-60PW9A	65,80 (2.592)	57,91 (2.280)	50,55 (1.992)	11,89 (.468)	24,90 (.981)	34,20 (1.347)	19,94 (.785)	49,02 (1.931)	5 spaces	4 spaces	7,11 (.280)
DLM2-96PW4 DLM2-96PW4A	65,80 (2.592)	57,91 (2.280)	50,60 (1.994)	19,38 (.763)	26,12 (1.108)	34,20 (1.347)	24,05 (.947)	50,60 (1.994)	7 spaces	6 spaces	15,37 (.605)
DLM2-96PW6 DLM2-96PW6A	65,80 (2.592)	57,91 (2.280)	50,60 (1.994)	19,38 (.763)	26,12 (1.108)	34,20 (1.347)	24,05 (.947)	50,60 (1.994)	7 spaces	6 spaces	7,11 (.280)
DLM2-96PW9A	65,80 (2.592)	57,91 (2.280)	50,60 (1.994)	19,38 (.763)	26,12 (1.108)	34,20 (1.347)	24,05 (.947)	50,60 (1.994)	7 spaces	6 spaces	3,18 (.125)
DLM1-156PW4 DLM1-156PW4A	108,00 (4.255)	100,03 (3.983)	92,00 (3.622)	16,26 (.640)	24,90 (.981)	49,45 (1.948)	20,10 (.792)	92,10 (3.626)	5 spaces	12 spaces	15,37 (.605)
DLM1-156PW6 DLM1-156PW6A	108,00 (4.255)	100,03 (3.983)	92,00 (3.622)	16,26 (.640)	24,90 (.981)	49,45 (1.948)	20,10 (.792)	92,10 (3.626)	5 spaces	12 spaces	7,11 (.280)
DLM1-156PW9A	108,00 (4.255)	100,03 (3.983)	92,00 (3.622)	16,26 (.640)	24,90 (.981)	49,45 (1.948)	20,10 (.792)	92,10 (3.626)	5 spaces	12 spaces	3,18 (.125)
DLM5-260PW4 DLM5-260PW4A	108,00 (4.255)	100,03 (3.983)	92,00 (3.622)	26,00 (1.024)	35,00 (1.378)	49,90 (1.965)	30,30 (1.193)	92,10 (3.626)	9 spaces	12 spaces	15,37 (.604)
DLM5-260PW6 DLM5-260PW6A	108,00 (4.255)	100,03 (3.983)	92,00 (3.622)	26,00 (1.024)	35,00 (1.378)	49,90 (1.965)	30,30 (1.193)	92,10 (3.626)	9 spaces	12 spaces	7,11 (.280)
DLM5-260PW9A	108,00 (4.255)	100,03 (3.983)	92,00 (3.622)	26,00 (1.024)	35,00 (1.378)	49,90 (1.965)	30,30 (1.193)	92,10 (3.626)	9 spaces	12 spaces	3,18 (.125)
DLM6-260PW4 DLM6-360PW4A	125,00 (4.291)	115,00 (4.528)	104,30 (4.106)	29,00 (1.142)	42,60 (1.677)	64,30 (2.531)	37,80 (1.488)	107,30 (4.224)	9 spaces	14 spaces	15,37 (.604)
DLM6-360PW6 DLM6-360PW6A	125,00 (4.291)	115,00 (4.528)	104,30 (4.106)	29,00 (1.142)	42,60 (1.677)	64,30 (2.531)	37,80 (1.488)	107,30 (4.224)	9 spaces	14 spaces	7,11 (.280)
DLM6-360PW9A	125,00 (4.291)	115,00 (4.528)	104,30 (4.106)	29,00 (1.142)	42,60 (1.677)	64,30 (2.531)	37,80 (1.488)	107,30 (4.224)	9 spaces	14 spaces	3,18 (.125)

Notes:

Front removable 0,64 (0.025) square posts 2,54 (0.100) Centers.
1 space at 2,54 (0.100)

Dimensions shown in mm (inch)

Specifications and dimensions subject to change

Receptacle



- For contact cavity arrangements see pages 69-70.
- For panel cutout and mounting hole pattern, see page 66.
- For PC hole pattern, see pages 59-61.

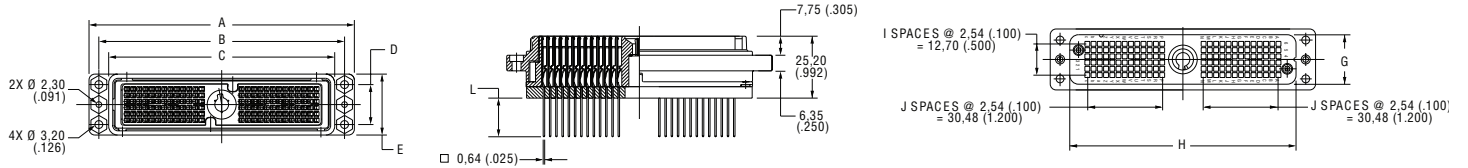

Description	A	B	C	D	E	G	H	I	J	L
DLM3-60RW4 DLM3-60RW4B	65,80 (2.592)	57,91 (2.280)	50,55 (1.992)	11,89 (.466)	24,80 (.980)	19,94 (.785)	49,02 (1.931)	5 spaces	4 spaces	15,37 (.605)
DLM3-60RW6 DLM3-60RW6B	65,80 (2.592)	57,91 (2.280)	50,55 (1.992)	11,89 (.466)	24,80 (1.360)	19,94 (.785)	49,02 (1.931)	5 spaces	4 spaces	7,11 (.280)
DLM3-60RW9B	65,80 (2.592)	57,91 (2.280)	50,55 (1.992)	11,89 (.466)	24,80 (1.360)	19,94 (.785)	49,02 (1.931)	5 spaces	4 spaces	3,18 (.125)
DLM2-96RW4 DLM2-96RW4B	65,80 (2.592)	57,91 (2.280)	50,60 (1.994)	19,38 (.763)	28,12 (1.108)	24,05 (.947)	50,60 (1.994)	7 spaces	6 spaces	15,37 (.605)
DLM2096RW6 DLM2-96RW6B	65,80 (2.592)	57,91 (2.280)	50,60 (1.994)	19,38 (.763)	28,12 (1.108)	24,05 (.947)	50,60 (1.994)	7 spaces	6 spaces	7,11 (.280)
DLM2-96RW9B	65,80 (2.592)	57,91 (2.280)	50,60 (1.994)	19,38 (.763)	28,12 (1.108)	24,05 (.947)	50,60 (1.994)	7 spaces	6 spaces	3,18 (.125)
DLM1-156RW4 DLM1-156RW4B	108,00 (4.255)	100,03 (3.983)	92,00 (3.622)	16,26 (.640)	24,80 (.976)	20,10 (.792)	92,10 (3.626)	5 spaces	12 spaces	15,37 (.605)
DLM1-156RW6 DLM1-156RW6B	108,00 (4.255)	100,03 (3.983)	92,00 (3.622)	16,26 (.640)	24,80 (.976)	20,10 (.792)	92,10 (3.626)	5 spaces	12 spaces	7,11 (.380)
DLM1-156RW9B	108,00 (4.255)	100,03 (3.983)	92,00 (3.622)	16,26 (.640)	24,80 (.976)	20,10 (.792)	92,10 (3.626)	5 spaces	12 spaces	3,18 (.125)
DLM5-260RW4 DLM5-260RW4B	108,00 (4.255)	100,03 (3.983)	92,00 (3.622)	26,00 (1.024)	49,61 (1.953)	30,30 (1.193)	92,10 (3.626)	9 spaces	12 spaces	15,37 (.604)
DLM5-260RW6 DLM5-260RW6B	108,00 (4.255)	100,03 (3.983)	92,00 (3.622)	26,00 (1.024)	49,61 (1.953)	30,30 (1.193)	92,10 (3.626)	9 spaces	12 spaces	7,11 (.280)
DLM5-260RW9B	108,00 (4.255)	100,03 (3.983)	92,00 (3.622)	26,00 (1.024)	49,61 (1.953)	30,30 (1.193)	92,10 (3.626)	9 spaces	12 spaces	3,18 (.125)
DLM6-360RW4 DLM6-360RW4B	125,00 (4.291)	115,00 (4.528)	104,30 (4.106)	29,00 (1.142)	42,60 (1.677)	37,80 (1.488)	107,30 (4.224)	11 spaces	14 spaces	15,37 (.604)
DLM6-360RW6 DLM6-360RW6B	125,00 (4.291)	115,00 (4.528)	104,30 (4.106)	29,00 (1.142)	42,60 (1.677)	37,80 (1.488)	107,30 (4.224)	11 spaces	14 spaces	7,11 (.280)
DLM360RW9B	125,00 (4.291)	115,00 (4.528)	104,30 (4.106)	29,00 (1.142)	42,60 (1.677)	37,80 (1.488)	107,30 (4.224)	11 spaces	14 spaces	3,18 (.125)

Notes:
Front removable 0,64 (0.025) square posts 2,54 (0.100) Centers.
1 space at 2,54 (0.100)



Plug



- Order Actuating Handle Kit sold separately, see page 44.
- For contact cavity arrangements see pages 69-70.
- For panel cutout and mounting hole pattern, see page 66.
- For PC hole pattern, see pages 59-61.

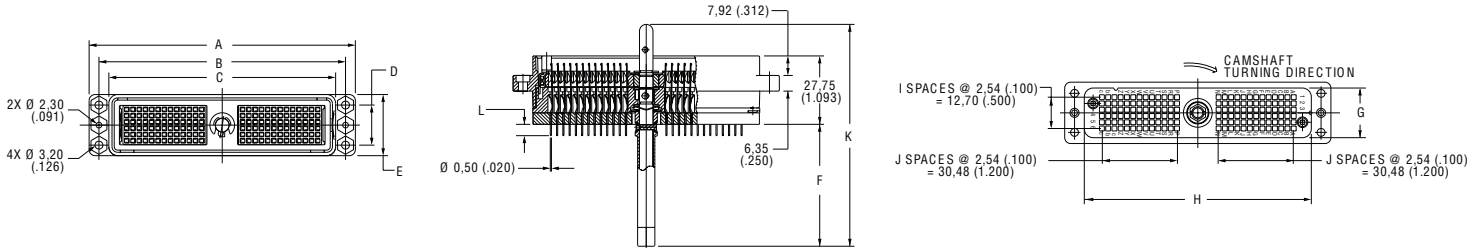

Description	A	B	C	D	E	F	G	H	I	J	K	L
DLM3-60PC-F	65,80 (2.592)	57,91 (2.280)	50,55 (1.992)	11,89 (.468)	24,90 (.980)	34,20 (1.347)	19,94 (.785)	49,02 (1.994)	5	4	74,75 (2.945)	4,60 (.181)
DLM2-96PC-F	65,80 (2.592)	57,91 (2.280)	50,60 (1.994)	19,38 (.763)	28,12 (1.108)	34,20 (1.347)	24,05 (.947)	50,60 (1.994)	7	6	74,75 (2.945)	4,60 (.181)
DLM1-156PC-F	108,00 (4.255)	100,03 (3.983)	92,20 (3.626)	16,26 (.640)	24,80 (0.977)	49,45 (1.948)	20,10 (0.792)	92,10 (3.626)	5	12	90,00 (3.546)	4,60 (.181)
DLM5-260PC-F	108,00 (4.255)	100,03 (3.983)	92,00 (3.626)	26,00 (1.024)	35,00 (1.378)	49,90 (1.965)	30,30 (1.193)	92,10 (3.626)	9	12	90,00 (3.546)	4,60 (.181)
DLM6-360PC-F	125,00 (4.291)	115,00 (4.528)	104,30 (4.106)	29,00 (1.142)	42,60 (1.677)	64,30 (2.531)	37,80 (1.488)	107,30 (4.224)	11	14	104,70 (4.122)	4,60 (.181)

Notes:
1 space at 2,54 (0.100)

Receptacle



- For contact cavity arrangements see pages 69-70.
- For panel cutout and mounting hole pattern, see page 66.
- For PC hole pattern, see pages 59-61.

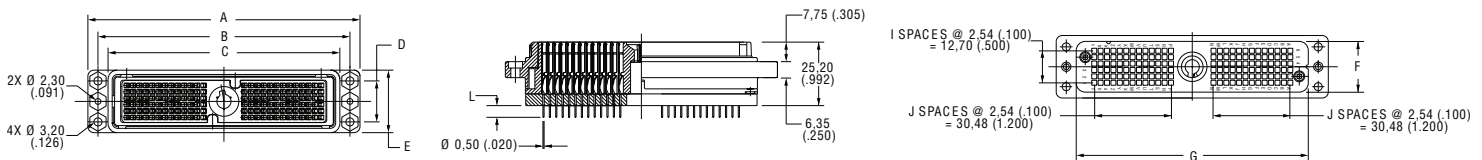

Description	A	B	C	D	E	G	H	I	J	L
DLM3-60RC-F	65,80 (2.592)	57,91 (2.280)	50,55 (1.992)	11,89 (.468)	24,90 (.980)	19,94 (.785)	49,02 (1.994)	5	4	4,60 (.181)
DLM2-96RC-F	65,80 (2.592)	57,91 (2.280)	50,60 (1.994)	19,38 (.763)	28,12 (1.108)	24,05 (.947)	50,60 (1.994)	7	6	4,60 (.181)
DLM1-156RC-F	108,00 (4.255)	100,03 (3.983)	92,20 (3.626)	16,26 (.640)	24,80 (.977)	49,45 (1.948)	20,10 (0.792)	5	12	4,60 (.181)
DLM5-260RC-F	108,00 (4.255)	100,03 (3.983)	92,00 (3.626)	26,00 (1.024)	35,00 (1.378)	49,90 (1.965)	30,30 (1.193)	9	12	4,60 (.181)
DLM6-360RC-F	125,00 (4.291)	115,00 (4.528)	104,30 (4.106)	29,00 (1.142)	42,60 (1.677)	64,30 (2.531)	37,80 (1.488)	11	14	4,60 (.181)

Notes:
1 space at 2,54 (0.100)

Dimensions shown in mm (inch)
Specifications and dimensions subject to change

www.ittcannon.com



Cannon ZIF Connectors

DLM - Metal Body - Pressfit Contacts

Plug



- Order Actuating Handle Kit sold separately, see page 44.
- For contact cavity arrangements see page 61.
- For panel cutout and mounting hole pattern, see page 66.
- For PC hole pattern, see page 62.

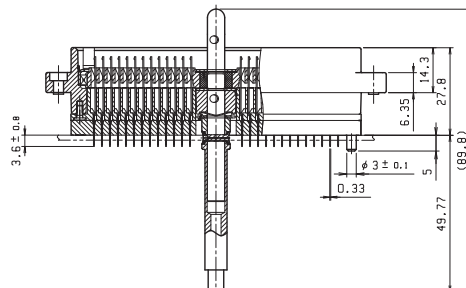
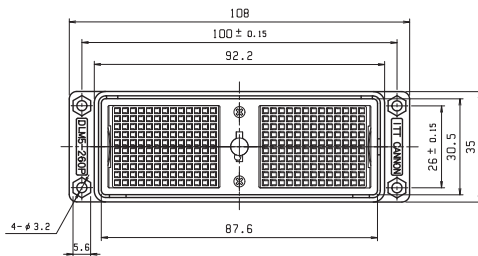

Part Number	Nomenclature
127050-0378	DLM5-260P-PF

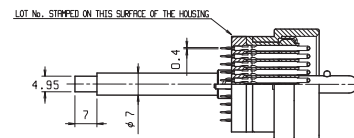
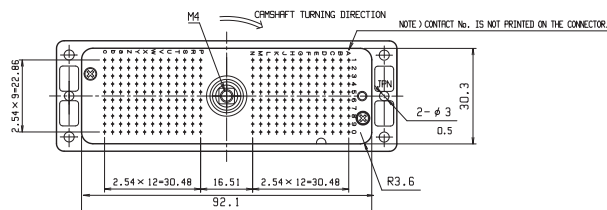

Receptacle



- For contact cavity arrangements see page 61
- For panel cutout and mounting hole pattern, see page 66
- For PC hole pattern, see page 62

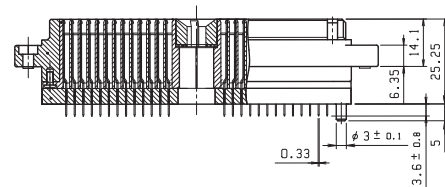
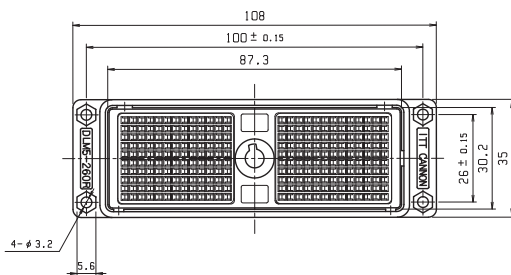

Part Number	Nomenclature
127050-0313	DLM5-260R-PF

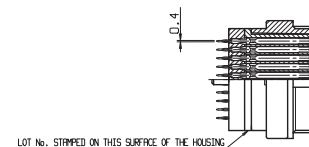
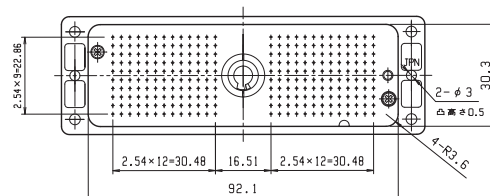

Dimensions shown in mm (inch)
Specifications and dimensions subject to change

www.ittcannon.com

The Cannon DL4 Series of Zero Insertion Force (ZIF) connectors fill the need in the commercial/industrial, aerospace/military, computer, and peripheral equipment marketplace for low-cost, high performance multiple wire power and signal connectors. The DL4 Series is a panel mounted connector with easy actuating lever from the side.

DL connectors feature: a minimum rated life of 20,000 complete mating and unmating cycles with no performance loss; can be mated and unmated in less than two seconds even with as many as 624 contacts; and they cost less (often as much as 25% less) per mated line than singular high-density rack-and-panel connectors.

Simple. Effective. Reliable. Durable.

Combining their special design with commercial-grade materials and low cost crimp. PCB and wrappable hermaphroditic contacts, that may be hand or machine terminated, makes the DL Series of ZIF connectors the finest low-cost-per-mated-line I/O connectors available today.



Derating Curves

DL4

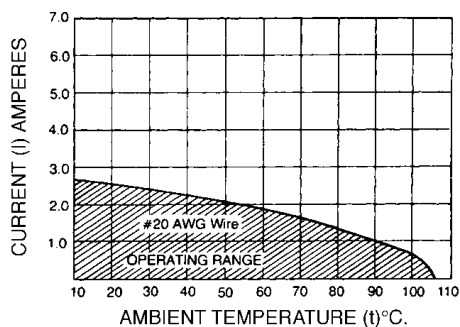

The ambient temperature curves shown represent the rated current carrying capacity of the Cannon DL electrical connectors, derated to 80% of the values recorded during the methods specified by International Electro-Technical Commission Document 48 (1975). Current was applied to the total connector (all contacts) in one-half ampere increments and maintained at each current level until thermal stability was achieved. A thermocouple inserted into the "hottest area" of each connector then measured the connector temperature at the same time that an ambient temperature reading was taken. The difference between the two measured values is the heat rise or self-heating created solely by the current flow, and this temperature rise for the current level was deducted from the insulator material rated temperature. These values were then derated to 80% to obtain the curves shown.

Standard Materials and Finishes

Insulator:	Glass filled thermoplastic, UL 94V-1 rated, Color: Black
Housing Frame:	Aluminum alloy, nickel plated
Mounting Plate:	Aluminum alloy, clear anodized
Crimp Contacts and Square Post Contacts:	Copper alloy, 20 or 50 μ inches gold over 50 μ inches nickel in mated area, gold flash on balance
Actuating Camshaft:	Stainless steel, Passivated
Insulator Retainer (Plug only):	Stainless steel, Passivated

Electrical Data

No. of Contacts:	624, 1248*, and 2496* signal
Wire Size:	#18 AWG through #42 AWG
Contact Termination:	- Crimp - Square Post - Wrap Post - Buss

Mechanical Data

Actuation:	Lever
Coupling:	Dual Latch
Polarization:	-
Contact Spacing:	2,54 (.100) Square Grid
Shell Styles:	Plug and Receptacle

Performance Data

Dielectric Withstanding Voltage:	750 VAC RMS - DL4
Insulation Resistance	5000 Megaohms minimum
Durability:	20,000 Cycles minimum
Contact Resistance:	- 15 milliohms maximum - Crimp/Square Post Contact - 20 milliohms maximum - Crimp #30- #32 AWG contact
Contact Retention:	8 lb (35,585 N) minimum

* Contact Factory for availability

How to Order

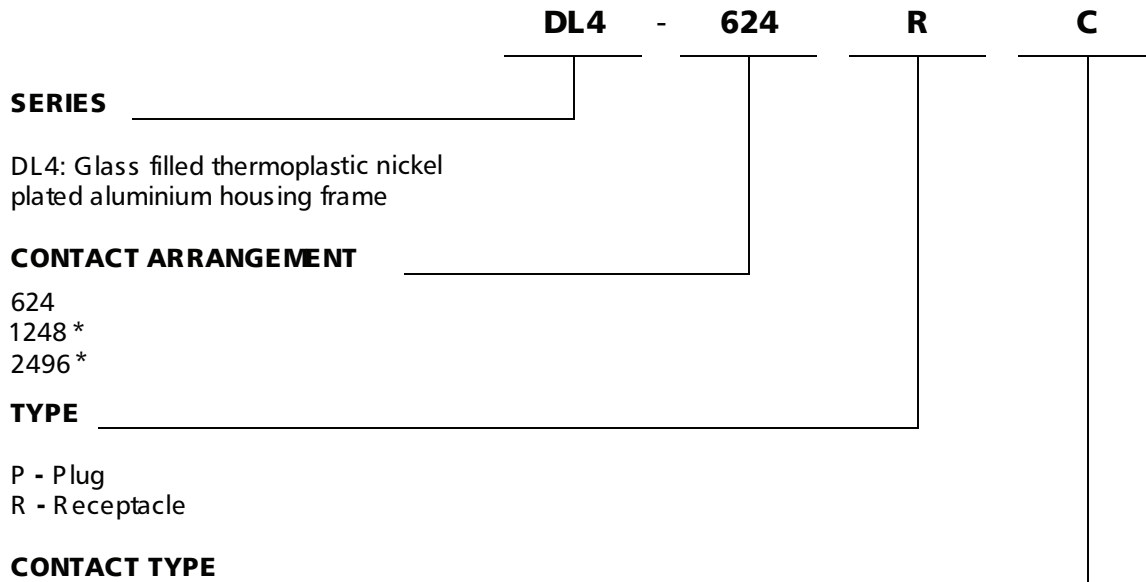

TO BE ORDERED SEPERATALY AND INSTALLED BY CUSTOMER

- W4 - Wrap Post 15,37 (0.605), 20 µinches Gold
- W4A - Wrap Post 15,37 (0.605), 50 µinches Gold, Plug only
- W4B - Wrap Post 15,37 (0.605), 50 µinches Gold, Receptacle only
- W6 - Square Post 7,11 (0.280), 20 µinches Gold
- W6A - Square Post 7,11 (0.280), 50 µinches Gold, Plug only
- W6B - Square Post 7,11 (0.280), 50 µinches Gold, Receptacle only
- W9A - Square Post 3,18 (0.125), 50 µinches Gold, Plug only
- W9B - Square Post 3,18 (0.125), 50 µinches Gold, Receptacle only

* Contact Factory for availability

Plug

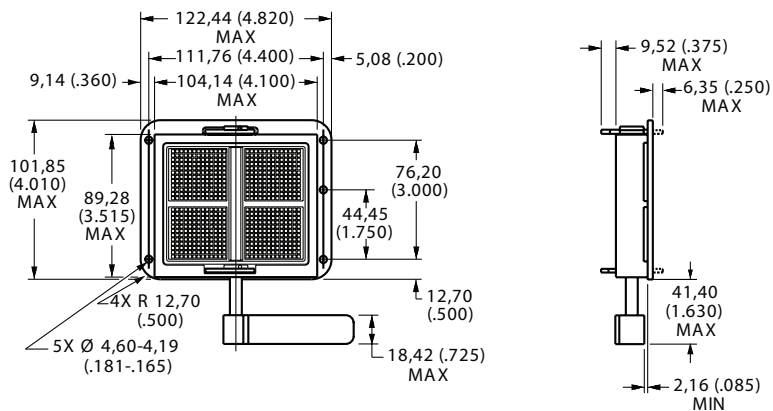

Part Number	Nomenclature
110959-0002	DL4-624P

- Actuating Handles are part of the completed assembly.
- Crimp contacts are to be ordered separately and to be installed by customer, see pages 48-50.
- For contact cavity arrangements see page 70.
- For panel cutout and mounting hole pattern, see page 66.

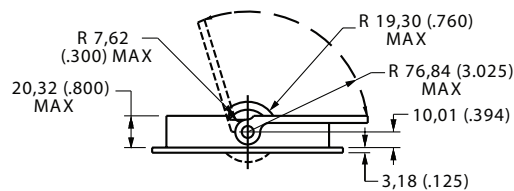

Receptacle

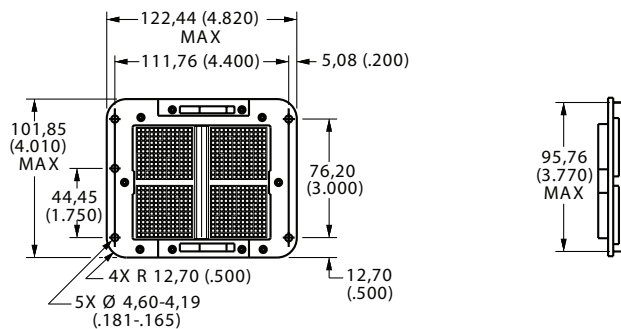
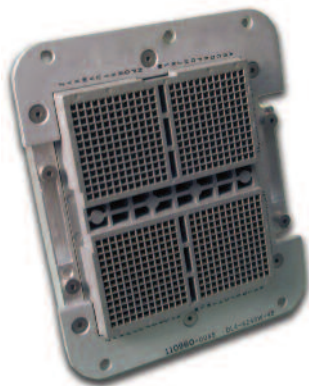

Part Number	Nomenclature
110960-0002	DL4-624R

- Crimp contacts are to be ordered separately and to be installed by customer, see pages 48-50.
- For contact cavity arrangements see page 70.
- For panel cutout and mounting hole pattern, see page 66.

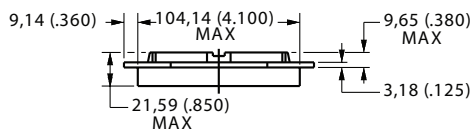

Plug

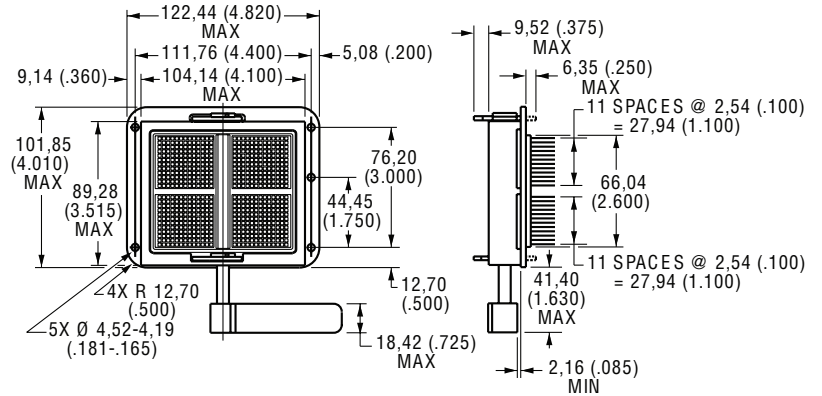
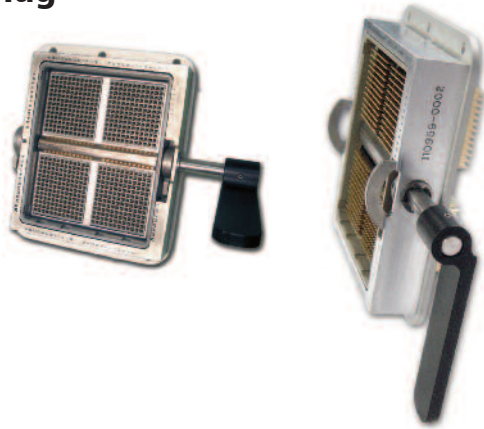

Nomenclature	L
DL4-624-PW4 DL4-624PW4A	15,37 (.605)
DL4-624PW6 DL4-624PW6A	7,11 (.280)
DL4-624PW9A	3,18 (.125)

Front removable 0,64 (0.025) square posts 2,54 (0.100) Centers.

- Actuating handles are part of the completed assembly.
- For contact cavity arrangements see page 70.
- For panel cutout and mounting hole pattern, see page 66.

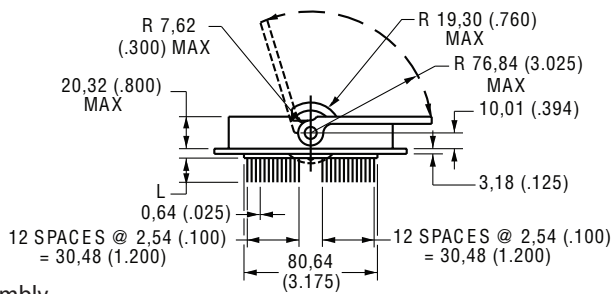

Receptacle

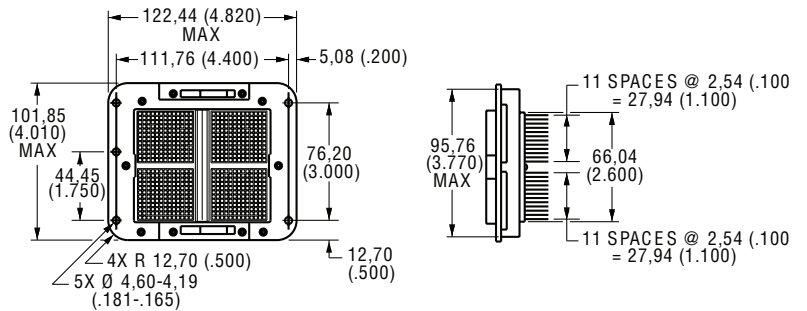
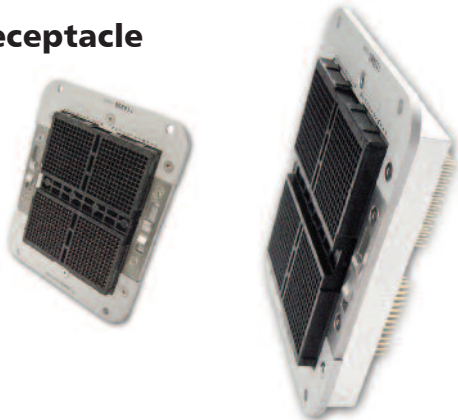

Nomenclature	L
DL4-624RW4 DL4-624RW4A	15,37 (.605)
DL4-624RW6 DL4-624RW6A	7,11 (.280)
DL4-624RW9B	3,18 (1.125)

Front removable 0,64 (0.025) square posts 2,54 (0.100) Centers

- For contact cavity arrangement see page 70.
- For panel cutout and mounting hole pattern, see page 66.

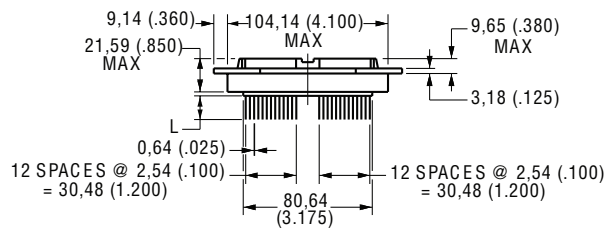

Dimensions shown in mm (inch)
Specifications and dimensions subject to change

Cannon has developed a 'Resilient Contact' that provides reliable performance with contact wiping action directly on a PCB pad. A high density contact module enables a high pin count connector and flexibility. The nickel plated aluminum housing along with the embedded grounding springs offer superior performance under the harshest EMI conditions. The DLP, like that of the DL, is capable of over 10,000 mating cycles. With the PCB acting as the mated contacts, electronics can be mounted at the signal source, thus reducing cross talk and minimizing real-estate. The DLP-408 is offered with mechanical shutters to meet the IEC requirements for finger protection.

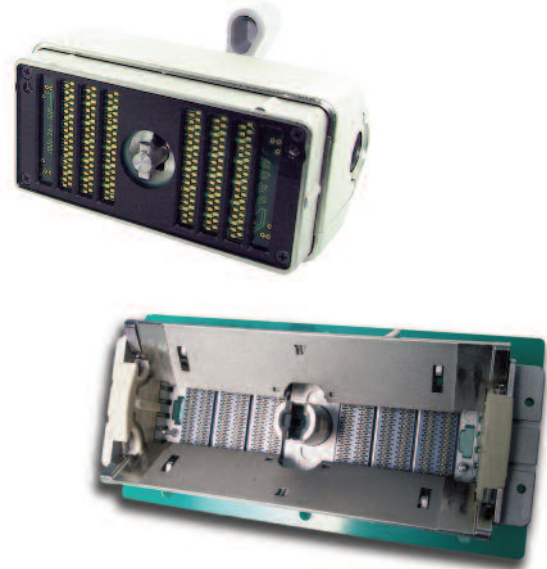

Materials and Finishes

Housing	Aluminum Alloy (DLP136, 204, 272). Zinc Alloy (DLP408) Nickel Plated
Actuating Camshaft	Stainless Steel, Passivated

Electrical Data

No. of Contacts:	136, 204, 272, 408
Wire Size:	N/A
Contact Termination:	Receptacle DIP Soldering to PCB - DLP 136, 204, 272 Pressfit to PCB (408)
	Plug Cable termination to PCB Direct soldering to daughter board stacked to PCB Interface connector between cable and PCB

Mechanical Data

Actuation:	Single Hand
Coupling:	Rotating Latch
Polarization:	Polarizing Posts
Contact Spacing:	1.9 (0.075 Pitch (DLP136 204, 272)), 1.6 (0.063) Pitch (DLP408)
Shell Styles:	Plug and Receptacle

Performance Data

Dielectric Withstanding Voltage:	500 VAC RMS
Insulation Resistance	1000 Megaohms minimum
Durability:	10,000 Cycles minimum
Contact Resistance:	30 milliohms maximum (Initial)
Contact Retention:	4.9N (1.1 LBS)



How to Order

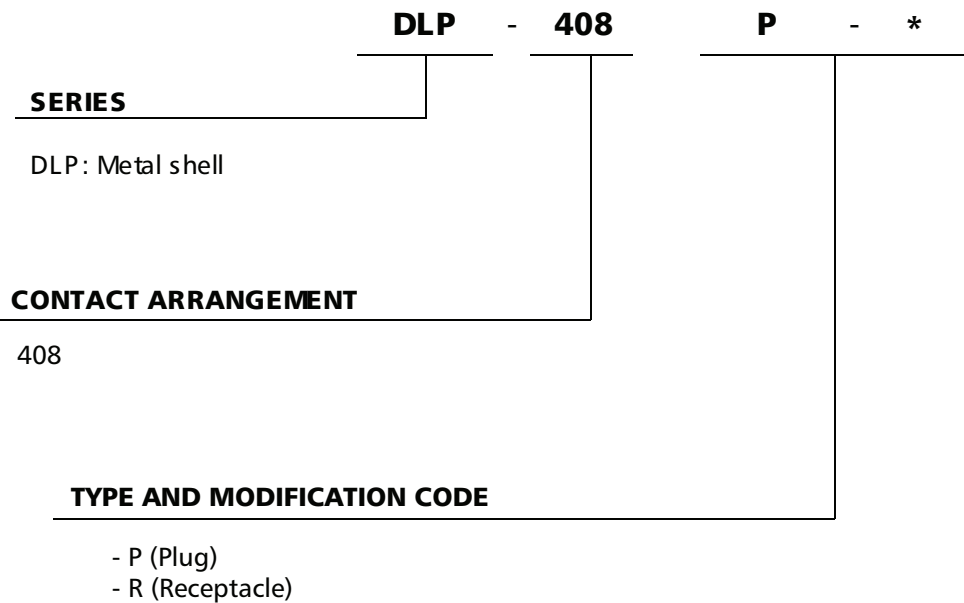
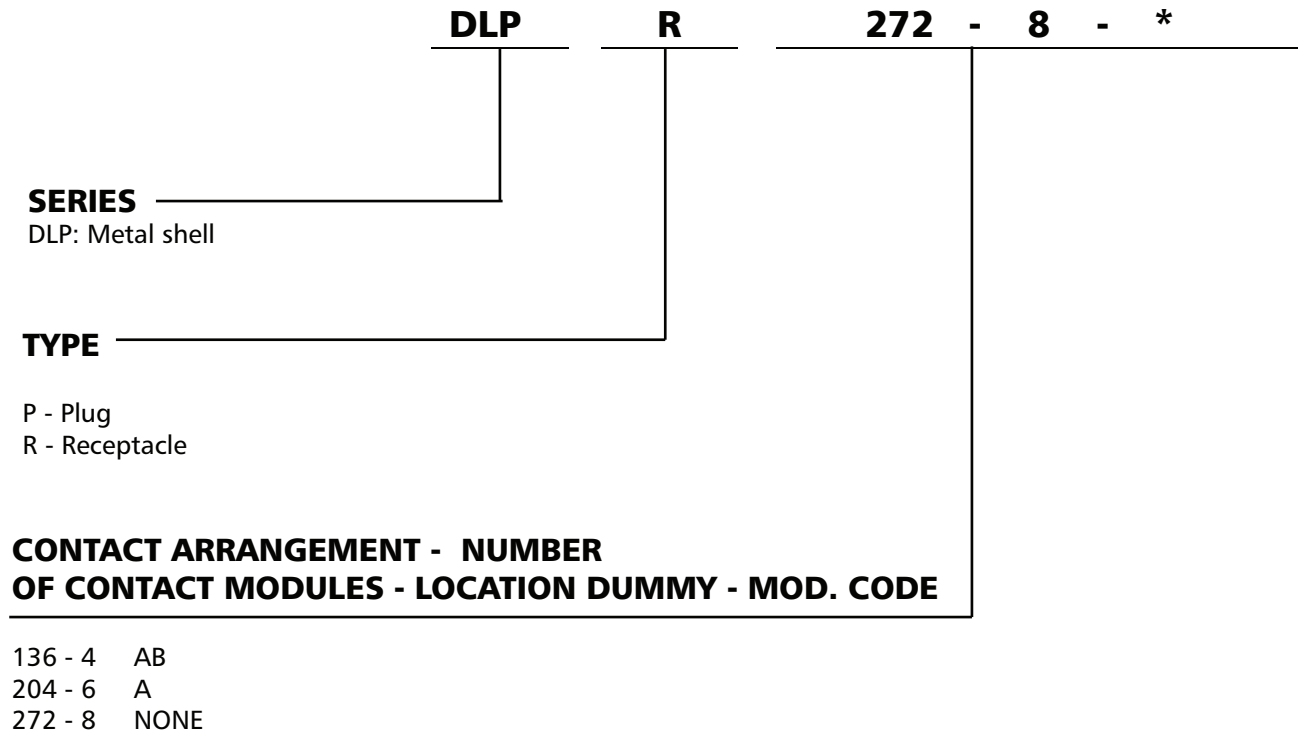

Plug

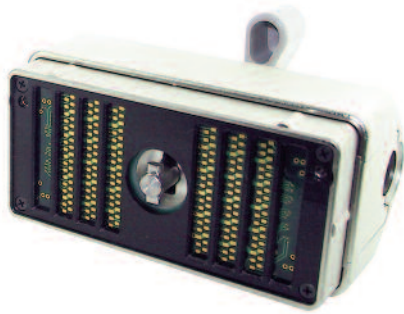

Part Number	Nomenclature
127050-0299	DLP-P

Part Number	Description
127000-2721	DLP PWB Plate 8
127000-2721	DLP PWB Plate 6
M2.5 x 15mm	PWB Plate Mounting Screw

Note: Flat head screw length dependent on customer backshell design

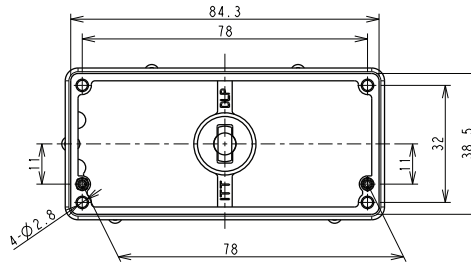
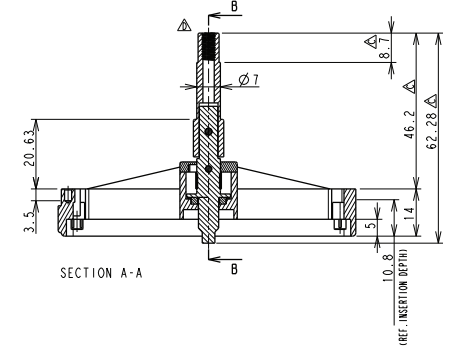
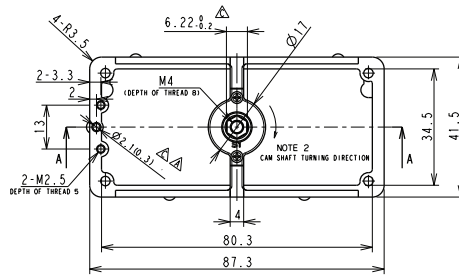

- Order Protective cover, sold separately. See page 45.
- For PC pad layout, see page 64.
- Not including backshell, handle, and screw.
- For contact cavity arrangements, see page 71.

Receptacle

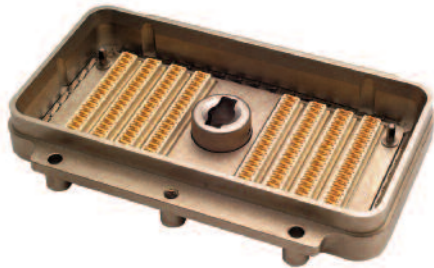

Part Number	Nomenclature
127050-0444	DLP-R204-6-A-F
127050-0391	DLP-R272-8-F

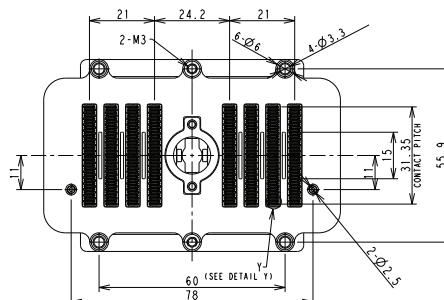
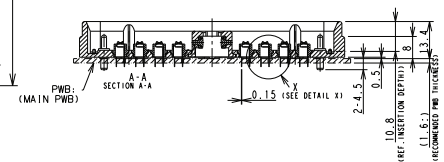
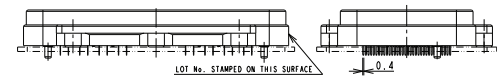
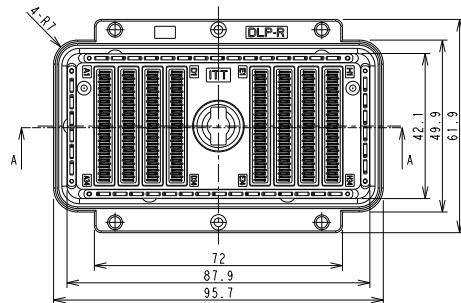

- For PC hole pattern, see page 64.
- For contact cavity arrangements, see page 71

Plug

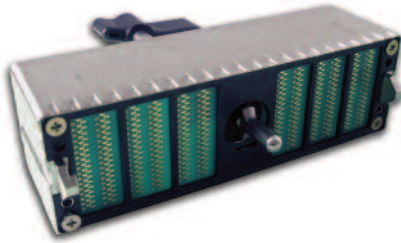

- Order Actuating Handle Kit, sold separately. See page 44.
- For Contact Cavity arrangements, see page 71.
- For PC pad layout, see page 65.
- PWB Protective Plate included. Screws sold separately.

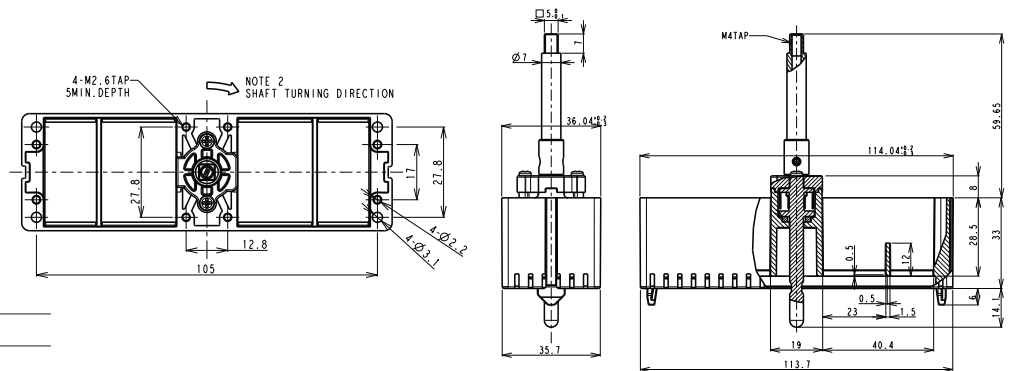

Part Number	Nomenclature
127050-0516	DLP408P
127059-0053	PWB Plate Screws (center)*
127059-0054	PWB Plate Screws (corners)**

* Two Center plate screws required.
 ** Four Corner plate screws required.

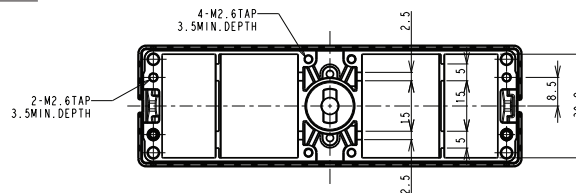

Receptacle

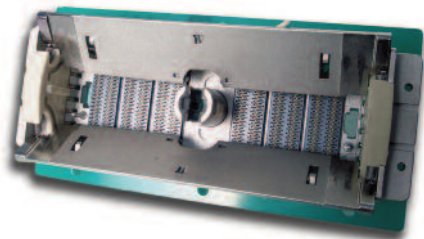

- For PC hole pattern, see page 65.
- For contact cavity arrangements, see page 71.

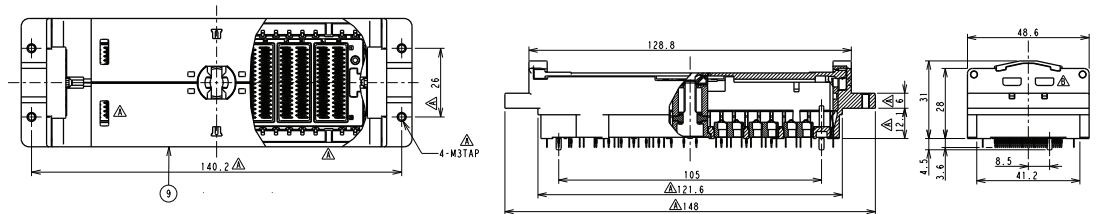

Part Number	Nomenclature
127050-0452	DLP408R

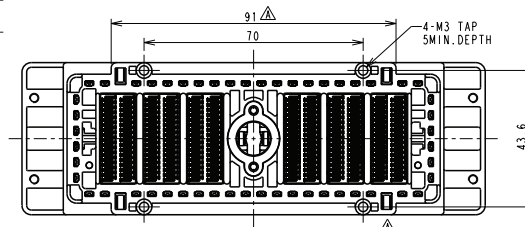

Dimensions shown in mm (inch)
 Specifications and dimensions subject to change

ITT Expands its DL Family of Connectors with the Miniature QLC Device to Meet Size, Reliability, and Mating Requirements for Portable Medical Equipment. Similar to the DL Series connectors, the QLC connector is highly reliable, easily assembled during harness and mating, and features a high pin count—up to 260 contacts in PC board-mount style. The QLC connector employs rugged nickel-plated aluminum housings and features a minimum rated life of 20,000 complete mating cycles with no performance loss. The interface of the QLC connector utilizes EMI springs and a shield-locking mechanism to ensure uniform mating pressure around the perimeter of the mated connector, creating an EMI/RFI shield.

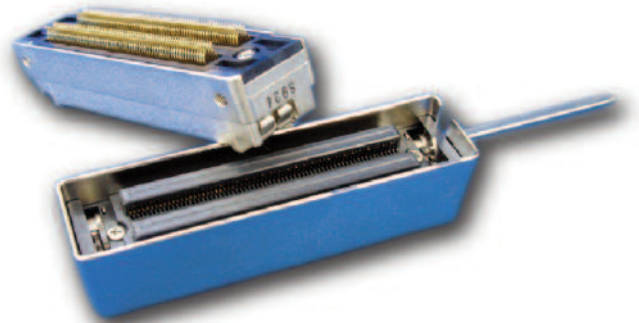

With technology advances for small portable imaging equipment, the demand for a smaller, higher pin count, shielded, reliable connector proves essential.

Consequently, ITT reduced the spacing from the standard DL to 0.8mm, thus reducing the overall size by more than 60% with the same number of contacts. The high pin count allows the engineer to utilize various grounding schemes to maintain signal integrity. The reduction in size, coupled with the superior shield design of the QLC, creates a sound interconnect choice for today’s portable market.

Materials and Finishes

QLC Housing:	Zinc, Nickel plated
Contacts:	Copper Alloy, 40 μinches gold over nickel in mating area, gold flash over nickel in tail area
Shaft Assembly:	Stainless steel and plastic
Ground Spring:	Stainless steel
Insert Mold:	Plastic

Electrical Data

No. of Contacts:	260
Wire Size:	N/A
Contact Termination:	Receptacle - DIP Solder to PCB Plug - Solder to Daughter Board

Mechanical Data

Actuation:	Roating Handle
Coupling:	Quad Latch
Polarization:	Polarizing Posts
Contact Spacing:	0.8mm
Shell Styles:	Plug and Receptacle

Performance Data

Dielectric Withstanding Voltage:	1000 VAC RMS
Insulation Resistance	1000 Megaohms minimum
Durability:	20,000 Cycles maximum
Contact Resistance:	100 milliohms maximum (including bulk resistance)
Contact Retention:	N/A

Plug

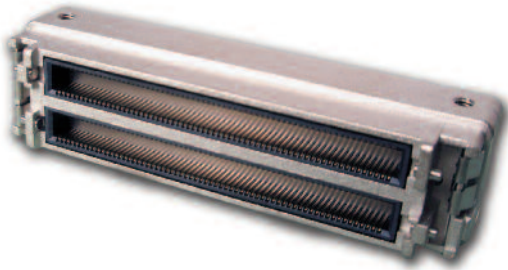

- Insulator retaining screw sold separately.
- For PC hole pattern, see page 65.

Part Number	Nomenclature
127050-0529	QLC260P
127059-0067	Insulator Retaining Screw (2 required)

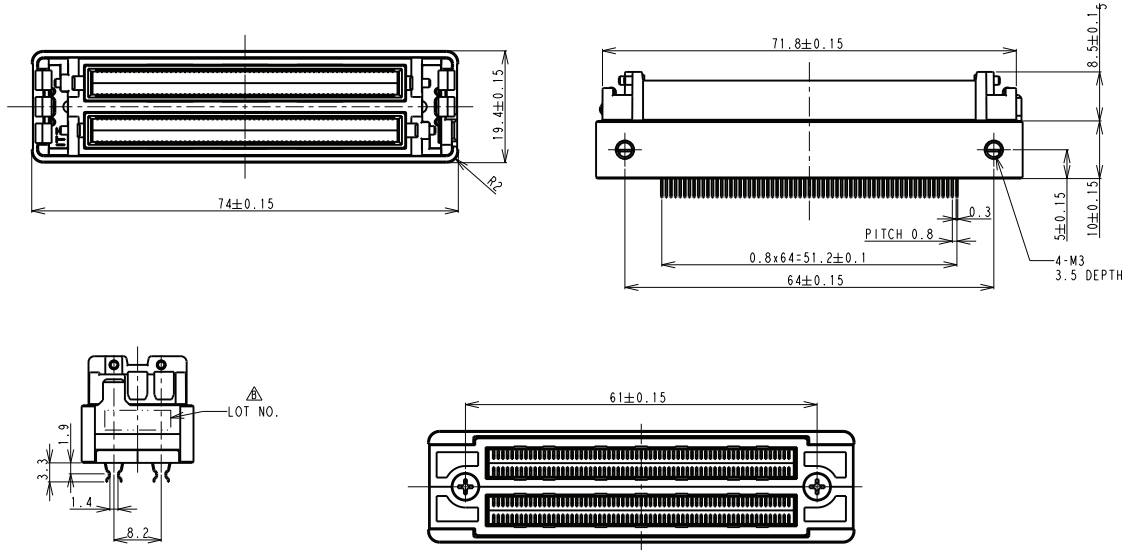

Receptacle

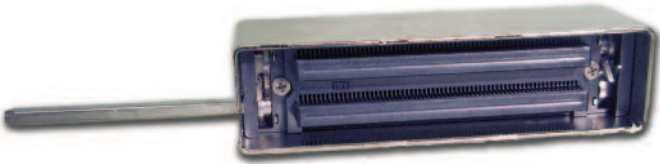

- Order actuating handle kit, sold separately. See page 44.
- For contact cavity arrangements, see page 71.
- For PC pad layout, see page 65.

Part Number	Nomenclature
127050-0530	QLC260R

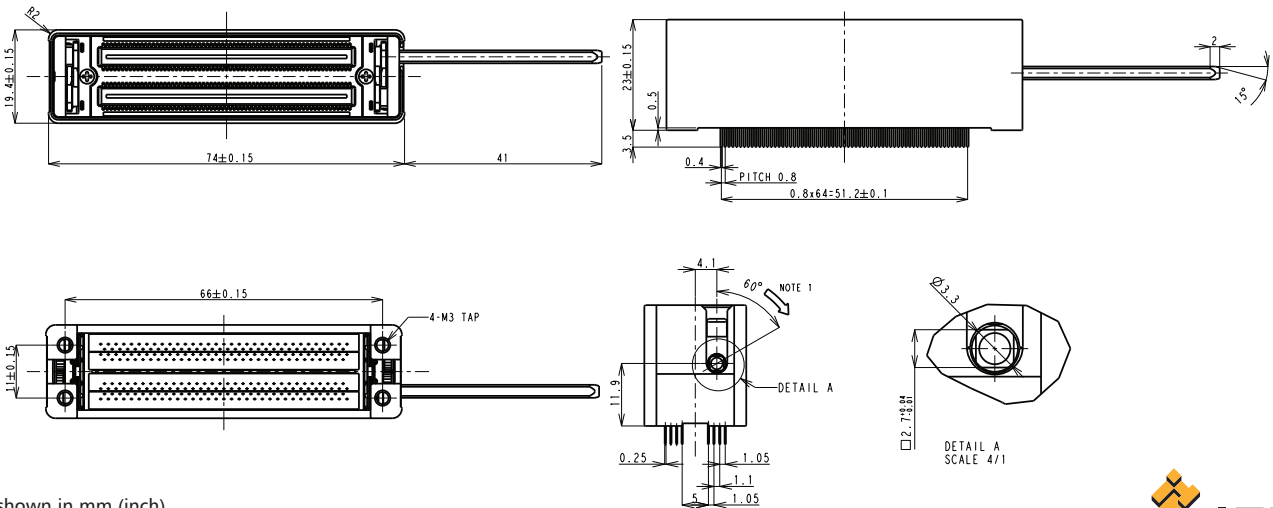

Dimensions shown in mm (inch)
 Specifications and dimensions subject to change
www.ittcannon.com



Cannon offers a wide selection of accessories that allow the design engineers to configure the product for their exact needs. The accessories range from the simple actuating handle to junction and backshells, as well as polarizing posts and protective covers for the contacts.

Actuating handles are the same for the DL1/2/3 and DLM1/2/3 series. The DL5/DLM5 and DLM6 series have specific handles. Handles are sold separately since many applications require the connector to be attached or removed only by an authorized technician.

Plastic junction shells are available for the DL1/2/3 series for encasement of the crimp contacts after complete installation into the connector. These shells also make it possible for the DL to be used as a cable-to-cable mating connector as they can be used both on the plug and the receptacle. The DL1/2/3 plastic junction shells have optional secondary cable entry capability by removing the molding in the cable entry plugs. Cable clamp kits are available to affix the cable to the second entry. This second entry option is very useful in applications where the large wire sizes make the cable diameter too large to be handled from a single entry port.

Metal Backshells are available for the entire DL/DLM series. The metal backshells are constructed from die cast aluminum with a nickel plating to facilitate in EMI/RFI shielding of the connector systems. Shielding has become a driving force because of the ever increasing stringent EMI/RFI regulations



Polarizing posts are available to offer a keying feature for both the DL and DLM connectors. The polarizing posts can be installed in specific orientation so that plugs of the same size connectors can only be mated in pre-determined receptacles. This feature offers the designer the ability to fool-proof the attachment possibilities to protect accidental damage to the system. Protective covers of plastic and anti-static rubber are available to

offer contact protection from physical damage or dust. Since the DL series has a high density of contacts in an exposed area, these covers are very useful for many applications. For example, where systems have multiple connectors, or when the connections are often left unattached, or when the system parts are put into storage.

Accessory Selection Guide

Connector Series	Actuating Handles see page	Protective Covers		Metal Shell EMI/RFI Shielding see page	Plastic Junction Shell see page	Cable Clamps see page	Metal Backshell see page	Polarizing Posts see page
		Rubber see page	Plastic see page					
DL1-156				-				
DL2-96				-				
DL3-60				-				
DL4-624	included		-	-	-	-	-	-
DL4-1248	included		-	-	-	-	-	-
DL4-2496	included		-	-	-	-	-	-
DL5-260		-	-	-	-	-		
DLM1-256				-				
DLM2-86				-				
DLM3-60				-				
DLM5-260		-	-	-	-	-		
DLM6-360		-	-	-	-	-		
DLD1-156	-	-	-	-	-	-	-	-
DLD2-96	-	-	-	-	-	-	-	-

Compatible
- Not Compatible



Dimensions shown in mm (inch)
Specifications and dimensions subject to

www.ittcannon.com

Product Features

- Stainless steel cable clamps
- Thermoplastic UL 94V-1 rated
- Straight 90 or 45 cable entry
- Accommodates up to 22,22 (.875) cable
- For use with crimp contact connectors
- Knockout plug provides alternate second entry
- Complete with 4 attaching screws and nuts
- Complete with one cable clamp kit

Junction Shell Kit (Straight or 90° Mounting)



DL1 / DLM1

Description	Part Number	A	B	C	D	E	F	G	H	I	Max Cable Entry
DL1-J/S	249-1950-000	110,74 (4.360) MAX	62,36 (2.455) MAX	68,58 (2.700) MAX	86,36 (3.400) MAX	43,94 (1.730) MAX	57,78 (2.275) MAX	63,50 (2.500) MAX	27,69 (1.090) MAX	50,44 (1.988) MAX	22,23 (0.875)

Note: Single Piece Shell

DL2 / DLM2

DL3 / DLM3

Description	Part Number	A	B	C	D	E	F	G	H	I	Max Cable Entry
DL2-J/S	249-1985-000	68,83 (2.710) MAX	46,81 (1.843) MAX	52,45 (2.065) MAX	71,04 (2.797) MAX	30,05 (1.183) MAX	36,45 (1.435) MAX	39,29 (2.500) MAX	31,75 (1.547) MAX	44,04 (1.250) MAX	14,20 (0.560)
DL2-2-J/S	249-2238-000	68,83 (2.710) MAX	46,81 (1.843) MAX	52,45 (2.065) MAX	71,04 (2.797) MAX	30,05 (1.183) MAX	36,45 (1.435) MAX	39,29 (2.500) MAX	31,75 (1.547) MAX	44,04 (1.250) MAX	15,90 (0.625)
DL2-4-J/S	249-2238-001	68,83 (2.710) MAX	46,81 (1.843) MAX	52,45 (2.065) MAX	71,04 (2.797) MAX	30,05 (1.183) MAX	36,45 (1.435) MAX	39,29 (2.500) MAX	31,75 (1.547) MAX	44,04 (1.250) MAX	22,23 (0.875)
DL2-3-J/S	249-2060-000	68,83 (2.710) MAX	46,81 (1.843) MAX	52,45 (2.065) MAX	71,04 (2.797) MAX	30,05 (1.183) MAX	36,45 (1.435) MAX	39,29 (2.500) MAX	31,75 (1.547) MAX	44,04 (1.250) MAX	14,20 (0.560)
DL3-3-J/S	249-2237-000	68,83 (2.710) MAX	46,81 (1.843) MAX	52,45 (2.065) MAX	71,04 (2.797) MAX	30,05 (1.183) MAX	36,45 (1.435) MAX	39,29 (2.500) MAX	31,75 (1.547) MAX	44,04 (1.250) MAX	15,90 (0.625)
DL3-4-J/S	249-2237-001	68,83 (2.710) MAX	46,81 (1.843) MAX	52,45 (2.065) MAX	71,04 (2.797) MAX	30,05 (1.183) MAX	36,45 (1.435) MAX	39,29 (2.500) MAX	31,75 (1.547) MAX	44,04 (1.250) MAX	22,23 (0.875)

Note: Two Piece Shell

Junction Shell Kit (45° Mounting)



DL2 / DLM2

DL3 / DLM3

Description	Part Number	A	B	C	D	E	F	G	H	I	Max Cable Entry
DL2-1-J/S	249-1985-001	68,83 (2.710) MAX	46,81 (1.843) MAX	52,45 (2.065) MAX	71,04 (2.797) MAX	30,05 (1.183) MAX	36,45 (1.435) MAX	39,29 (2.500) MAX	31,75 (1.547) MAX	44,04 (1.250) MAX	15,90 (0.625)
DL3-2-J/S	249-2060-001	68,83 (2.710) MAX	46,81 (1.843) MAX	52,45 (2.065) MAX	71,04 (2.797) MAX	30,05 (1.183) MAX	36,45 (1.435) MAX	39,29 (2.500) MAX	31,75 (1.547) MAX	44,04 (1.250) MAX	15,90 (0.625)

Note: Two Piece Shell

Dimensions shown in mm (inch)

Specifications and dimensions subject to change

Cable Clamp Kit for optional second entry (Straight or 90° Mounting)

DL1 / DL2 / DL3

Description	Part Number	Max Cable Entry	Mounting
DL1-C/C	218-0179-000	22,23 (0.875)	Straight or 90°
DL1-C/C (1)	218-0180-000	14,20 (0.680)	Straight or 90°
DL2-2-C/C (1)	218-0180-001	15,90 (0.625)	Straight or 90°
DL2-3-C/C (1)	218-0200-000	22,23 (0.875)	Straight or 90°



Cable Clamp Kit for optional second entry (45° Mounting)

DL2

Description	Part Number	Max Cable Entry	Mounting
DL2-1-C/C (1)	218-0181-000	15,90 (0.625)	45°

Note: (1) Also suitable for DL3 Connectors



Standard Materials and Finishes

Shell:	Acrylic paint over die cast aluminum
Hardware:	Stainless Steel

Two Piece Shell Design (Straight or 90° Mounting)

DL2 / DLM2
DL3 / DLM3

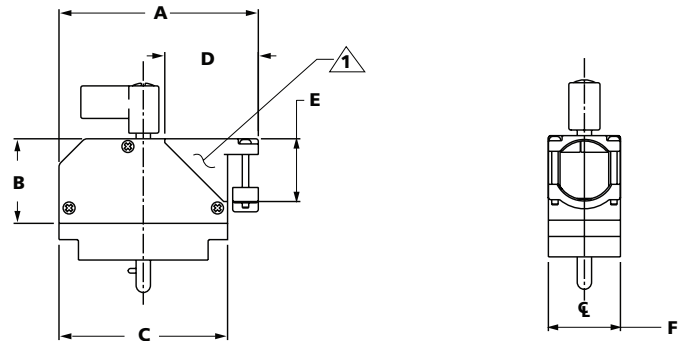

⚠ Wire hood may be installed in two positions. 90° cable entry as shown or straight entry by rotating wire hood.

Used On	Part Number	A	B	C	D	E	F	Max Cable Entry
DL2 / DLM2 (1)	249-4517-000	77,8 (3.06)	33,0 (1.30)	65,8 (2.59)	36,3 (1.43)	24,5 (.96)	28.1 (1.11)	19,05 (0.750)
DL3 / DLM3 (1)	249-4518-000	77,8 (3.06)	33,0 (1.30)	65,8 (2.59)	36,3 (1.43)	24,5 (.96)	28.1 (1.11)	19,05 (0.750)

Note: Kit consists of 2 shells, 9 screws, 1 wire hood, 1 wire clamp, 1 lock/open indication seal.

One Piece Shell Design (Straight or 90° Mounting)

DL1/DLM1
DL5/DLM5
DLM6

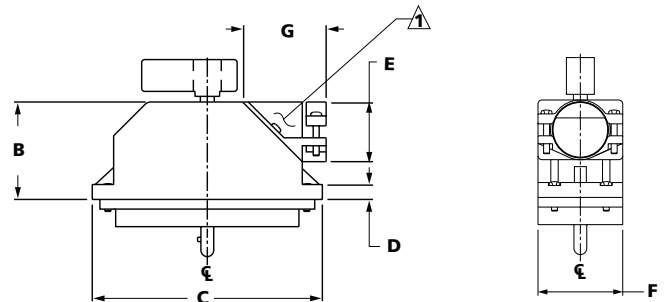
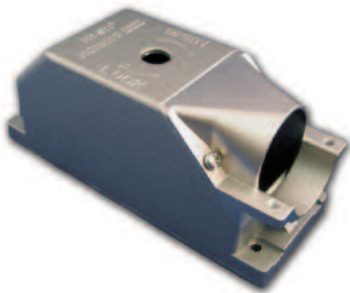

⚠ Wire hood may be installed in two positions. 90° cable entry as shown or straight entry by rotating wire hood.

Used On	Part Number	A	B	C	D	E	F	Max Cable Entry
DL1/ DLM1 (2)	249-4520-000	123,4 (4,86)	48,6 (1.91)	111,4 (4.38)	N/A	24,0 (0.945)	28,12 (1.11)	19,05 (0.750)
DL5/ DLM5 (3)	249-4501-000	N/A	49,0 (1.93)	115,8 (4.56)	7,6 (0,30)	30,0 (1.18)	42,6 (1.68)	22,3 (0.875)
DL6/ DLM6 (3)	249-4515-000	N/A	63,0 (2.48)	125,0 (4.92)	7,6 (0,30)	30,0 (1.18)	42,6 (1.68)	28,00 (1.102)

Notes: (2) Kit consists of 2 shells, 10 screws, 1 wire hood, 1 wire clamp, 1 lock/open indication seal.

(3) Kit consists of 1 shell, 8 screws, 1 wire hood, 1 wire clamp, 4 nuts.

Dimensions shown in mm (inch)

Specifications and dimensions subject to change

www.ittcannon.com

Product Features

- Provides a convenient method of actuating the contacts and cam for locking the connector.
- Kit provides actuating handle and attaching screw.
- Pointer on handle denotes "locked" and "open" positions.

Materials and Finishes

Handle: Glass filled thermoplastic

**DL1 / DL2 / DL3
DLM1 / DLM2 / DLM3**



Part Number: 204-0016-000

**DL5
DLM5
DLP408**



Part Number: 204-4501-000

DLM6



Part Number: 204-4500-000

QLC



Part Number: 127059-0069

Note: For DLP 272 Handle, please consult factory for more information.

Protective Covers

Product Features

- Fits snugly over mating faces
- Prevents foreign matter from permeating contact cavities

Protective Covers - Rubber

Materials and Finishes

Cover: Anti-static synthetic rubber

DL / DLM Receptacle



Cover for	Part Number
DL1-156R	039-0243-000
DL2-96R	039-0245-000
DL3-60R	039-0247-000
DL4-624R	039-0240-000

DL / DLM Plug



Cover for	Part Number
DL1-156P	039-0242-000
DL2-96P	039-0244-000
DL3-60P	039-0246-000
DL4-624P	039-0239-000

Protective Covers - Plastic

Materials and Finishes

Cover: Polyethylene

DL / DLM Plug



Cover for	Part Number
DL1-156P	025-0852-000
DL2-96P	025-0857-000
DL3-60P	025-0850-000

DL / DLM Receptacle



Cover for	Part Number
DL1-156R	025-4506-000
DL2-96R	025-4505-000
DL3-60R	025-4509-000
DL5-260R	025-1218-000

Note: Must remove/cut secondary cap from DL5 cover

DLP 272



Nomenclature	Part Number
DLP PWB Protect 6A/H	127000-2721
DLP PWB Protect 8	127000-2720
DLP Plug Dust Cap	127000-2719
DLP Receptacle Dust Cap	127000-2732

Dimensions shown in mm (inch)
 Specifications and dimensions subject to change

Center Mounting

Materials and Finishes

Post:	Zinc, copper over nickel
Screw:	Stainless Steel

DL1 / DL2 DLM1 / DLM2



Kit consists of	Part Number
2 posts and 2 no. 2- 56 X3/16 fil. Head screws	320-0021-005

Corner Mounting

Materials and Finishes

Post:	Zinc, nickel
Screw:	Stainless Steel

DL1 / DL2 / DL3 DLM6

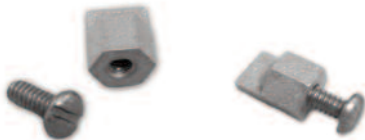

Kit consists of	Part Number
2 posts and 2 No. 4-40x9/32	320-0021-006

DLM1 / DLM2 / DLM3



Kit consists of	Part Number
4 posts and 4 M2.5x10 screws	320-4505-000

DL5 DLM5



Kit consists of	Part Number
4 posts and 4 M3x8 screws	320-4502-000

Materials and Finishes

Shell: Steel, Nickel Finish

Metal Shells (DL5 only)

Plug

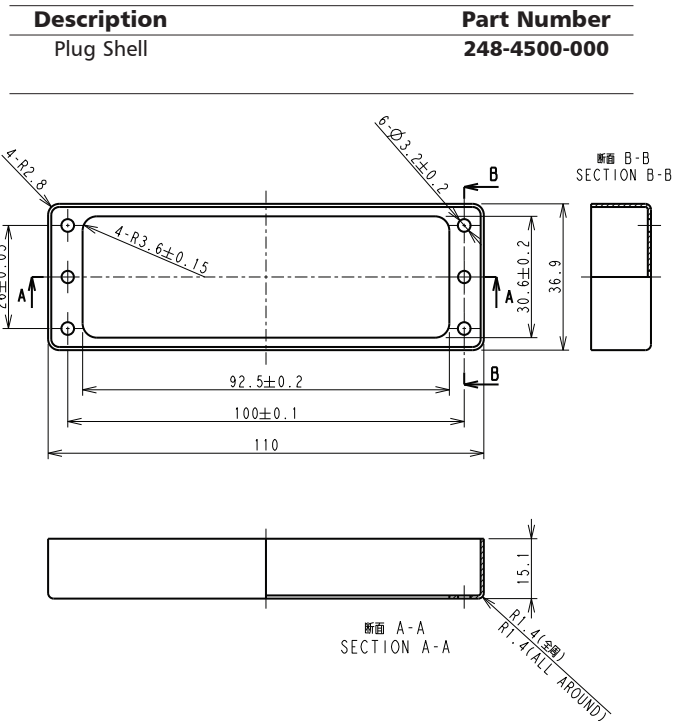

Receptacle

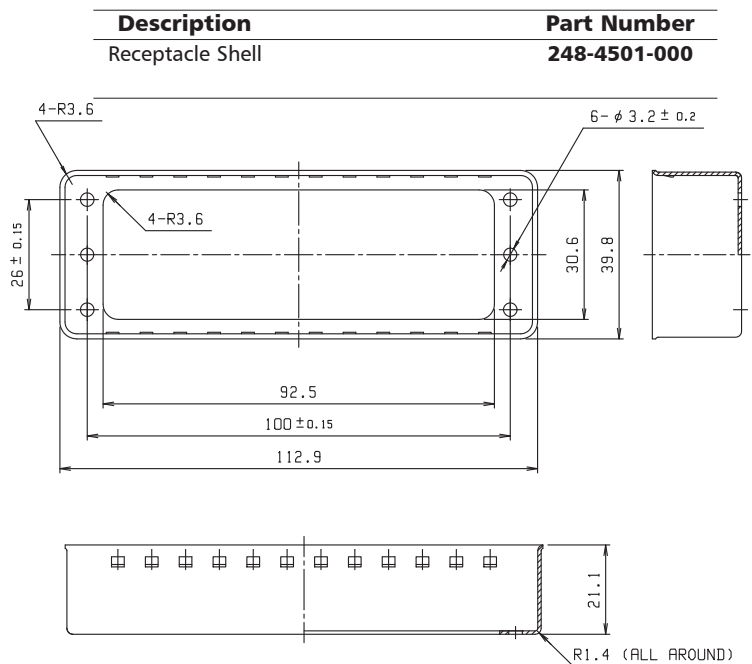

Dimensions shown in mm (inch)
Specifications and dimensions subject to change

www.ittcannon.com



The Cannon DL Crimp and Buss contacts are available in addition to the factory installed Square Post/PCB mount version contacts. Crimp contacts are available loose only.

The Buss Contacts make the DL series capable of providing higher than 5 amps per line. The Buss contacts are pairs of contact lines which increase the amperage capability in increments of 10 amps up to 60 amps. The contacts have solder holes at the tail section for soldering #30-#18 AWG. The tail is also designed to accommodate a 1/8 crimp lug for wire sizes larger than #18.

The Crimp contacts are available in two plating types. The 20µ inch gold hermaphroditic version which is the economical choice for applications requiring over 100 milliamps to 5 amps, and the 50µ gold bump to flat version which offers the most versatile range of applications requirements from micro-amps to 5 amps.

The Bump to Flat version was developed specifically to handle “dry circuit” requirements where the signal amperage is not enough to ensure a clean contact point. The 50µ inch gold Bump to Flat version is mandatory for applications with signals below 100 milliamps. The Bump contact is installed in the Plug and the Flat contact is installed in the receptacle. This combination increases the contact force and ensures that the wiping point becomes the current carrying point after mating. The 50µ inch gold Bump to Flat version has become the standard for all modern applications where power and low voltage signals are combined into one connector.



1 Pair

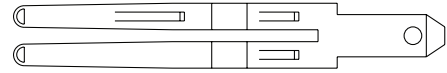
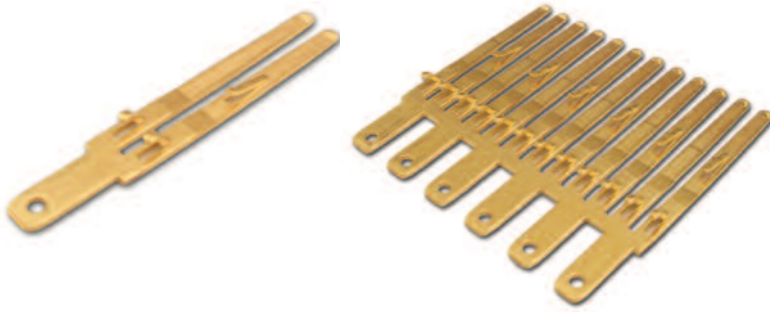

- Designed for power distribution of more than 5 amps.
- Accommodates #30-#18 AWG in hole 1,29-1,14 (.051-.045) for wire soldering.
- Accommodates 1/8 crimp lugs for larger wire sizes.

Buss Contact

Description	Part Number
1 Pair	030-7380-001
2 Pair	030-7380-002
3 Pair	030-7380-003
4 Pair	030-7380-004
5 Pair	030-7380-005
6 Pair	030-7380-006

Material: Copper Alloy

Finish: 20µ inch in mating area / gold flash on balance (terminating end)

Note: For more information on tools and assembly, see pages

Wire Termination - Solder

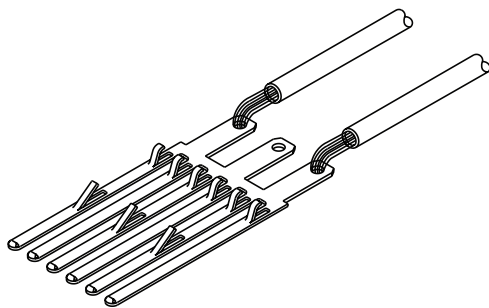

Wire Termination - Crimp Lug

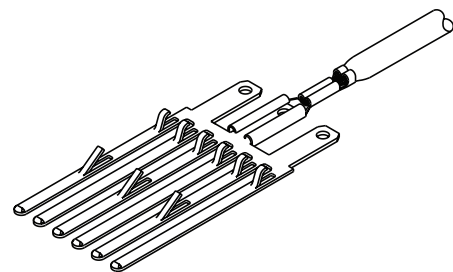

Note: Contacts must be installed in the vertical position.

50 inch Gold Contacts

- Recommended for all applications
- Offer the broadest amperage range
- Mandatory for low current applications, less than 100 milliamps.

Materials and Finishes

Material:	Copper Alloy
Finish:	50 inch Gold over Nickel in mated area, Gold flash on balance (terminating end)

Plug (Bump)

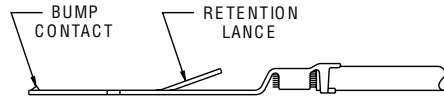

Wire Type	Loose Part Number	Reeled Part Number
28 thru 32 AWG	030-2416-003	110238-0482
24 thru 26 AWG	030-2410-003	110238-0480
20 thru 22 AWG	030-2409-003	110238-0479
18 thru 20 AWG (1)	030-2415-003	110238-0481

Note: Contact can be used in both plug and receptacle for applications above 100 MA.

Receptacle (Flat)



Wire Type	Loose Part Number	Reeled Part Number
28 thru 32 AWG	030-2494-001	110238-0486
24 thru 26 AWG	030-2492-001	110238-0484
20 thru 22 AWG	030-2491-001	110238-0483
18 thru 20 AWG (1)	030-2493-001	110238-0485

Caution: Flat contacts can only be used in the receptacle

20 inch Gold Contacts

Materials and Finishes

Material:	Copper Alloy
Finish:	20 inch Gold over Nickel, in mated area, Gold flash on balance (terminating end)

Plug and Receptacle (Bump) (3)

Wire Type	Loose Part Number	Reeled Part Number
36 thru 38 AWG (2)	127000-2207	127000-1271
28 thru 32 AWG	030-2416-001	110238-1030
24 thru 26 AWG	030-2415-001	110238-1029
20 thru 22 AWG	030-2410-001	110238-1028
18 thru 20 AWG	030-2409-001	110238-1027

- Note: (1) Non insulation support
 (2) 20 inch gold in mating area/Gold flash on balance (terminating end), RoHS compliant, sold in lots of 100 pieces.
 (3) 20 inch gold Bump contact are used for both Plug and Receptacle

A key feature of the Cannon DL connector series is easy contact termination, both in the field and in high-volume production. An ergonomically designed hand crimp tool is available for the low volume (loose contact) applications and will accommodate two different crimp contact sizes. To reduce overall costs, the crimp jaws are replaceable.

Automatic crimp and strip/crimp machines are available for high volume applications requiring a large number of crimps (50,000 crimps per year or more). These machines are leased to customers to eliminate the need for heavy investment. They also improve productivity for large pin count applications.

DL Crimp contacts are designed to be hand installed into the connector, no tooling is needed for the insertion process. Extraction tools are available for the removal of Crimp contacts for easy repair even in field applications. Extraction tools are also available for the Buss contacts, as well as the factory installed Square Post contacts.

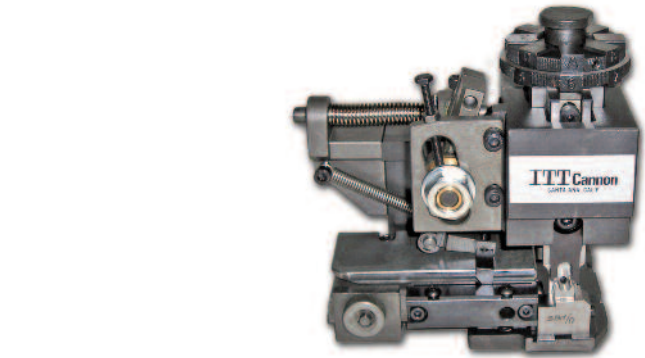

Hand Crimp Tool



Hand Crimp Tool with Replaceable Jaw Set

Hand Tool	Description	Part Number
1	CHDLT 28-32	112108-0002
2	CHDLT 20-26	112108-0001
3	CHDLT 18-20	112108-0000

Crimp Tensile Strength

Crimp tensile strength is a measure of how hard a wire can be pulled without breaking or separating from the contact. This is the best way to verify that the wire is properly terminated to the contact. Periodic crimp tensile measurements are recommended to insure the integrity of the crimp. The table below contains the appropriate values for DL crimp contacts.

Wire Trim Dimension

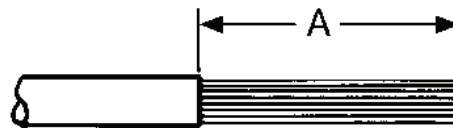

Wire Size (AWG)	32	30	28	26	24	22	20	18
Tensile Min. (lbs)	1	1.5	3	7	10	15	19	30
Wire Trim Dimension "A"	3,30 (.130)	3,30 (.130)	3,30 (.130)	3,30 (.130)	3,30 (.130)	3,30 (.130)	4,06 (.160)	4,06 (.160)
Insulation Dia. Max	1,35 (.053)	1,35 (.053)	1,35 (.053)	1,65 (.065)	1,65 (.065)	1,88 (.074)	1,88 (.074)	1,88 (.074)

Dimensions shown in mm (inch)
Specifications and dimensions subject to change

Extraction Tool - Buss Contacts



Extraction Tool for Buss Contact

Description	Contacts	Part Number
CET-DL3	1 pair	274-7029-003
CET-DL4	2 pair	274-7029-004
CET-DL4	3 pair	274-7029-004
CET-DL5	4 pair	274-7029-005
CET-DL6	5 pair	274-7029-006
CET-DL6	6 pair	274-7029-006

Extraction Tool - Crimp, Square Post, PC/RC Contacts

CET-DL10

CET-ECP

CET-ECP-1



Description	Part Number	Contact Type	PC Tail Extension
CET-DL10	274-7029-007	Crimp	-
CET-ECP	274-7045-000	Wrap Post	15,37 (.605)
CET-ECP-1	274-7045-001	Square Post	7,11 (.280)

Assembly Instructions for Crimp Contacts

Contact Insertion:

All crimp contacts inserted by hand. No tooling is required for either the plug or receptacle.

Caution: Do not force contacts into contact cavities. If contact encounters excessive resistance during installation remove and re-insert using a slight up and down motion. This will assure positive cavity alignment. *Do not* install contact if plug is in the *closed* or actuated position.

Plug:

Step 1. Prior to inserting contacts, turn the shaft counter-clockwise to its maximum *open* position.

Step 2. With the retention lance positioned away from the shaft, insert contacts from the rear of the contact plug.

Receptacle:

Step 1. With the retention lance positioned toward the shaft hole, insert contacts from the rear of the receptacle.

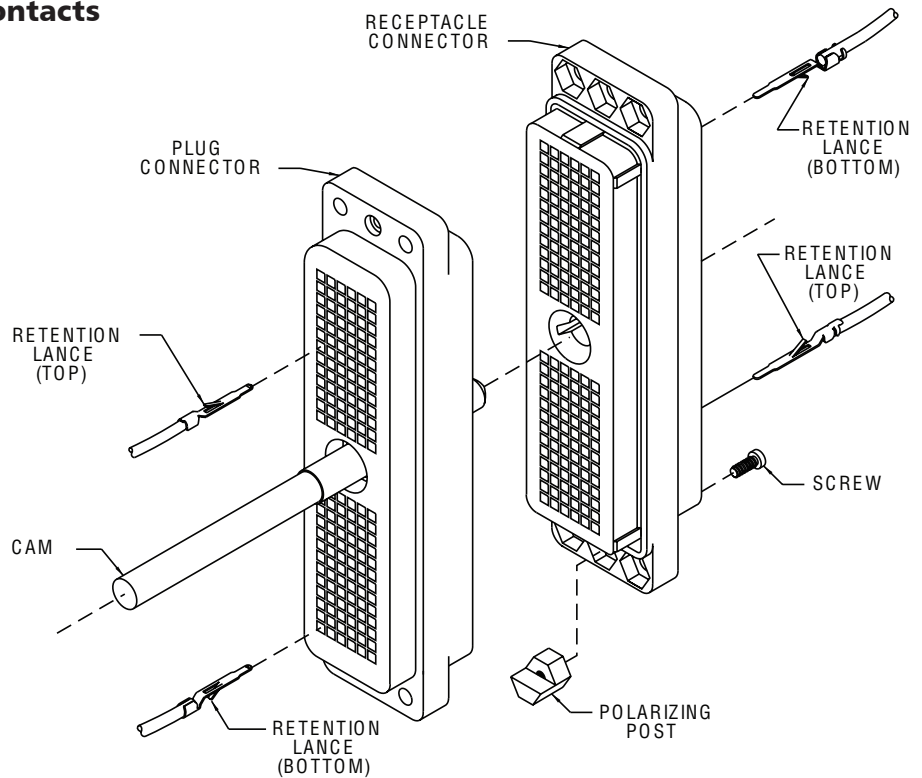

Contact Removal for Crimp Contacts

Tool: CET-DL10



Release retention lance by inserting tip of extraction tool into cavity until it bottoms on insulator shoulder. Gently pull wire in direction of arrow, see illustration, to remove contact from insulator.

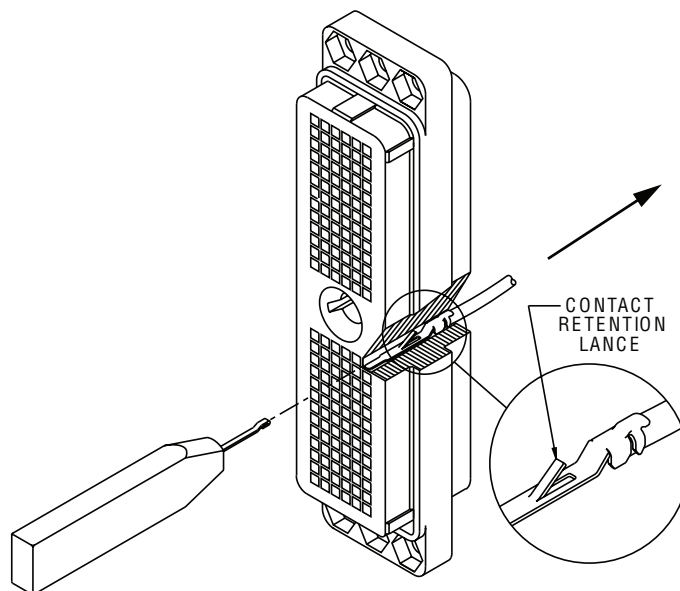

Assembly Instructions for Buss Contacts

Contact Insertion:

All buss contacts are inserted by hand. No tooling is required for either the plug or receptacle.

Caution: Do not force contacts into contact cavities. If contact encounters excessive resistance during installation remove and re-insert using a slight up and down motion. This will assure positive cavity alignment. *Do not* install contact if plug is in the *closed* or actuated position.

Plug:

Step 1. Prior to inserting contacts, turn the shaft counter-clockwise to its maximum *open* position.

Step 2. With the retention lance positioned away from the shaft, insert contacts from the rear of the contact plug.

Receptacle:

Step 1. With the retention lance positioned toward the shaft hole, insert contacts from the rear of the receptacle.

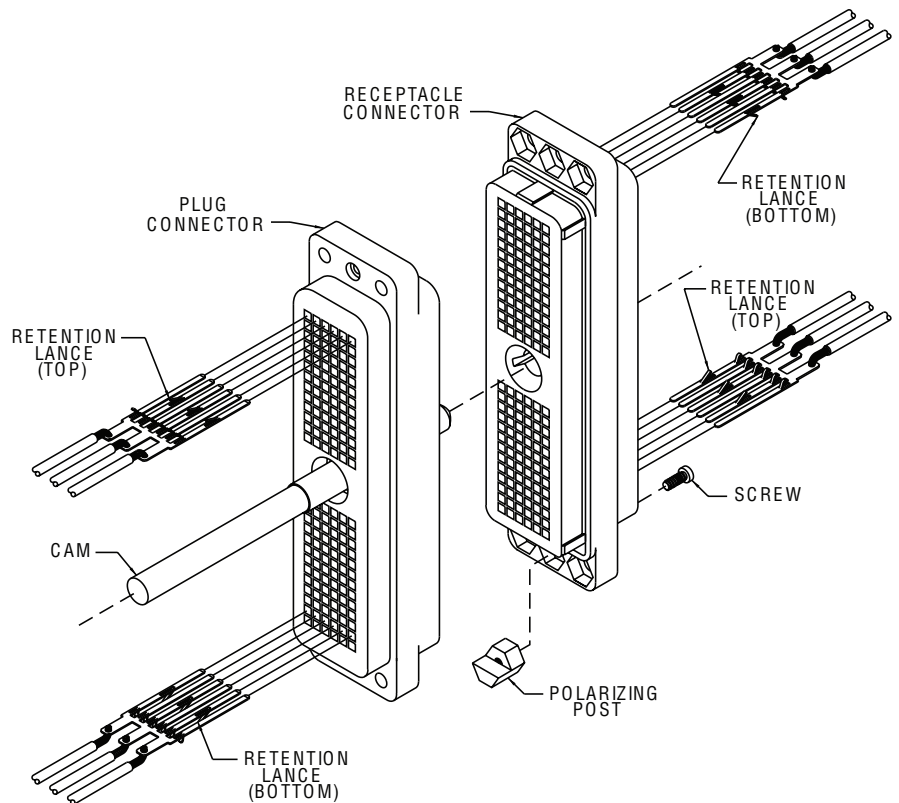

Contact Removal for Buss Contacts

Tool: CET-DL3/4/5/6



Release retention lance by inserting tip of extraction tool into cavity until it bottoms on insulator shoulder. Gently remove buss contact in direction of arrow, see illustration, to remove contact from insulator.

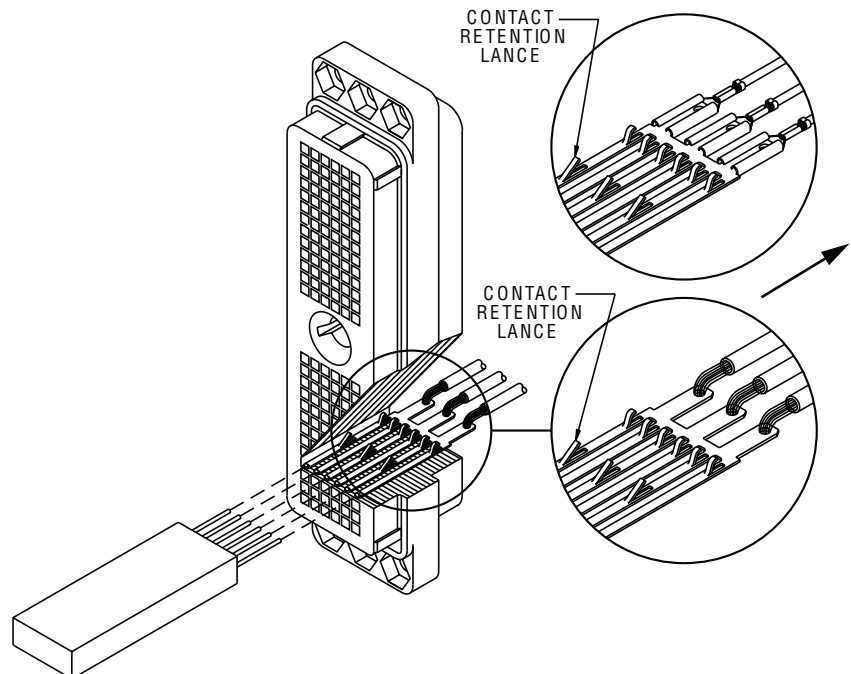

Assembly Instructions for Square Post Contacts

Contact Insertion:

Square Post Contacts are factory installed but can be removed and replaced if damaged in service.

Step 1. Prior to inserting contacts, actuating handle must be in the maximum open position.

Step 2. Contacts are inserted from the insulator front face by hand and are seated and clicked in the cavity by pulling on the terminal post with flat nose plier, see Figure 1.



Figure 1

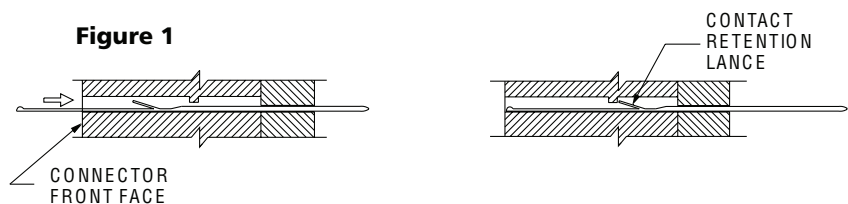

Contact Removal for Square Post Contacts

Tool: CET-ECP and CET-ECP-1



Place tool over square post terminal and impact tool. Apply sufficient force to collapse retention lance and push contact out of insulator. This process destroys the retention lance

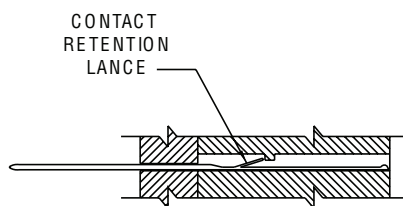
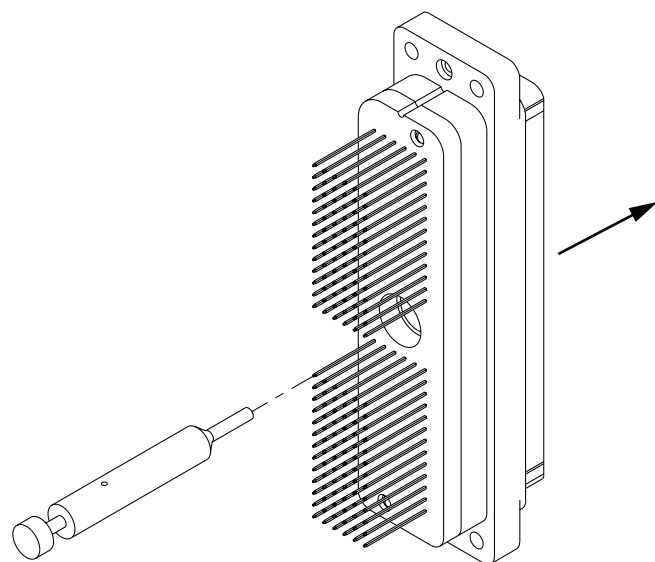

Lease Automatic Tooling - North America*

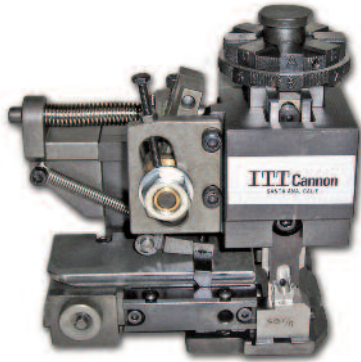

Mini Applicators are interchangeable modules that will fit into many standard crimping machines. They are available for all sizes of stamped and reeled contacts

Wire Size AWG	18-20	20-22	24-36	28-32
20 inches Gold	110238-0402*	110238-0400	110238-0401	110238-0403
50 inches Gold (Bump)	110238-0481*	110238-0479	110238-0480	110238-0482
50 inches Gold (Flat)	110238-0485*	110238-0483	110238-0484	110238-0486

* Without Insulation support

Mini Applicator	DL-T 18-20		DL-T 20-22		DL-T 24-26		DL-T 28-32		
Applicator p/n	112211-0002		112211-0003		112211-0009		112211-0010		
Wire Size	18	20	20	22	24	26	28	30	32
Strip Length Reference	4.00 (0.160)	4.00 (0.160)	3.3 (0.130)	3.3 (0.130)	3.3 (0.130)	3.3 (0.130)	3.3 (0.130)	3.3 (0.130)	3.3 (0.130)
Conductor Crimp Width - Max	1,80 (0.071)	1,80 (0.071)	1,710 (0.067)	1,710 (0.067)	1,5 (0.059)	1,5 (0.059)	1,5 (0.059)	1,5 (0.059)	1,5 (0.059)
Conductor Crimp Height +/- 0,03 (0.001)	1,52 (0.060)	1,34 (0.053)	1,25 (0.049)	1,22 (0.048)	1,04 (0.041)	0,96 (0.038)	0,84 (0.033)	0,79 (0.031)	0,74 (0.029)
Insulation crimp Height - Max	N/A	N/A	1,88 (0.074)	1,88 (0.074)	1,65 (0.065)	1,65 (0.065)	1,35 (0.053)	1,35 (0.053)	1,35 (0.053)
Tensile Pull Minimum (Newtons)	133 (30)	84 (19)	84 (19)	67 (15)	44 (10)	31 (7)	13 (3)	7 (1.5)	4 (1)

ABT-620 UCCS



The ABT-620 Universal Cannon Crimper / Stripper is a pneumatic powered, microprocessor controlled machine. It is designed to semi-automatically strip insulation from stranded or single conductor electrical wire and attach a stamped and formed contact by crimping. The machine will accommodate 34 thru 12 AWG wire. Primary application of the machine is the termination of jacketed cable where the individual leads cannot be stripped by fully automated equipment. The ABT-620 UCCS operates automatically upon insertion of a wire or it can be switched over to a foot pedal operation as desired.

Machined Strip / Crimp Rate:
1200+ per hour

Power Requirements:
Electrical = 115 VAC, 60 Hz, 20A
Pneumatic = 80 psi, 3 cu. ft per min.

* For other geographical regions, contact Cannon for details.



Lease or Buy Automatic Tooling - Europe

TT Crimping Press

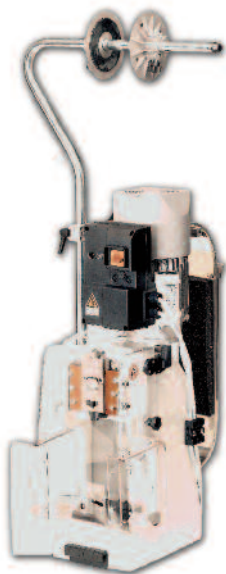

The TT Crimping Press is available either in semi-automatic (for bench-top use) configuration or in full automatic (integrated into a cut and strip machine) configuration. Very compact and light, its spheroidal cast iron, one-piece structure offers the highest rigidity for a very stable crimping height value. A proprietary safety cover (grants the operator a perfect view of the crimping zone while enjoying complete protection from any hazard). The semi-automatic configuration (for bench top use) always includes safety cover, reel arm, foot switch according to the international safety standard and CE regulation. Mini-applicators are available for all sizes of stamped and reeled contacts.

Part Number: 121586-5225

Mini-Applicators - Europe

Wire Size AWG	18-20	20-22	24-26	28-32
20 \square inches Gold		110238-0400	110238-0401	110238-0403
50 \square inches Gold (Bump)	-	110238-0479	110238-0480	110238-0482
50 \square inches Gold (Flat)	-	110238-0483	110238-0484	110238-0486

Mini Applicator	DL-T 18-20		DL-T 20-22		DL-T 24-26		DL-T 28-32		
Applicator p/n	-		-		-		-		
Wire Size AWG mm ²	18 0,82	20 0,52	20 0,52	22 0,33	24 0,25	26 0,14	28 0,08	30 0,05	32 0,03
Strip Length Reference	4.00 (0.160)	4.00 (0.160)	3.30 (0.130)	3.30 (0.130)	3.30 (0.130)	3.30 (0.130)	3.30 (0.130)	-	-
Conductor Crimp Width - Max	1,80 (0.071)	1,80 (0.071)	1,70 (0.067)	1,700 (0.067)	1,50 (0.059)	1,50 (0.059)	1,5 (0.059)	-	-
Conductor Crimp Height +/- 0,03 (0.001)	1,45 (0.057)	1,35 (0.053)	1,22 (0.048)	1,14 (0.045)	1,07 (0.042)	1,04 (0.041)	0,90 (0.035)	-	-
Insulation Crimp Height - Max	0	0	1,88 (0.074)	1,88 (0.074)	1,65 (0.065)	1,65 (0.065)	1,65 (0.065)	-	-
Tensile Pull Minimum (Newtons)	133	84	84	53	32	18	11	-	-

Note: All applicators are compatible with TT Crimping Press, #121586-5225. We advise all our customers to hold at least one set of consumable tooling (consisting of Conductor Crimp Blade, Insulation Crimp Blade, Combination Anvil, Shear Moving and Shear Fixed). Please consult factory to order consumable tooling.

PCB Pad Layout

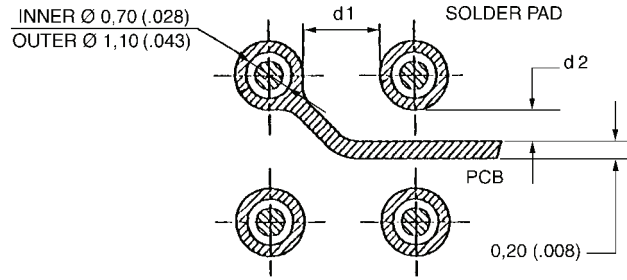
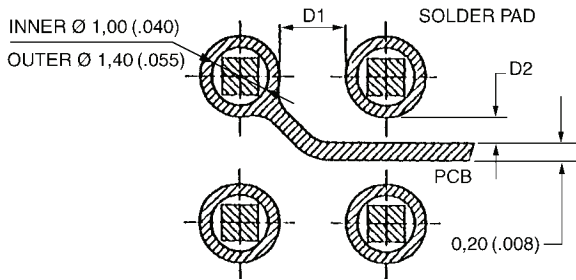
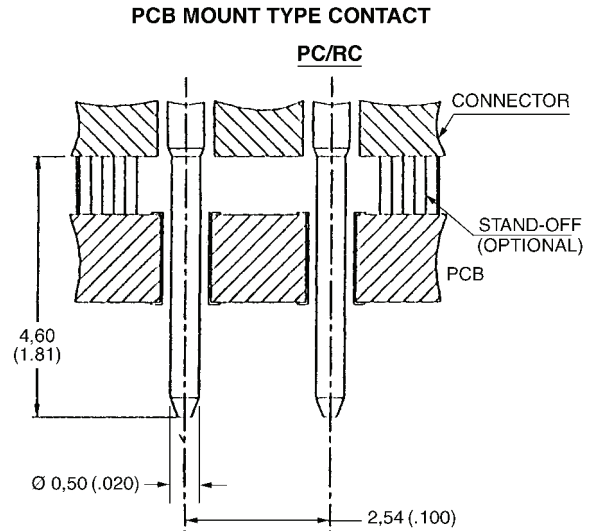
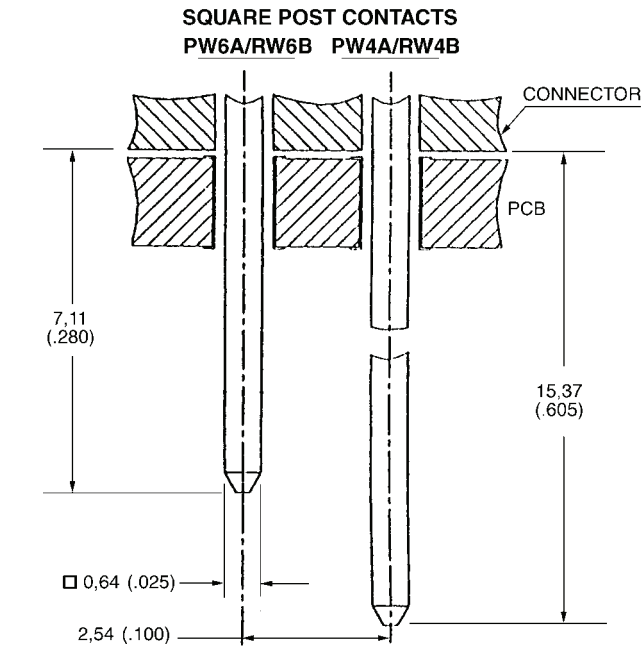

For the PC/RC Versions: The contact tail design has been modified from a 0,64 (.025) square pin to a 0,05 (.020) diameter round pin. The change enables a decrease in the diameter of the through holes as well as the solder mounds on PCB's (d1 and d2 can be wider than D1 and D2). This can reduce the crosstalk in RF circuits and enhance the dielectric withstanding voltage in high voltage circuits.

The soldering of contacts into through (THRU) holes on a PC Board has become standard for medical equipment and test equipment for semi-conductors. As a result of the narrow spacing between the solder pad and circuit pattern, crosstalk between signals increases. A solution to this problem is to make the diameter of the contacts and solder lands smaller to provide more space between the lands and the patterns. However a smaller diameter contact results in higher impedance.

Cannon designed a solution with a smaller diameter contact tail. This design

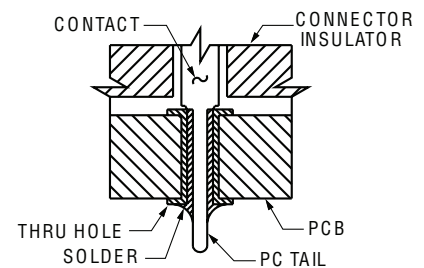

DL1 / DLM1 / DLD1 Printed Circuit Board Hole Patterns

DL1-156/DLM1-156

Plug 

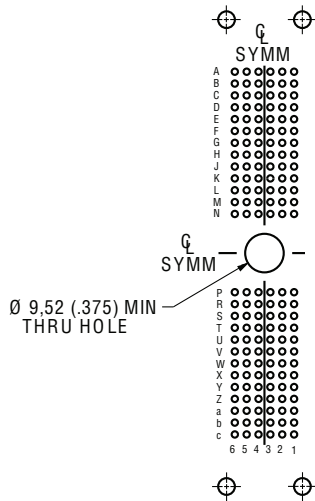

Receptacle

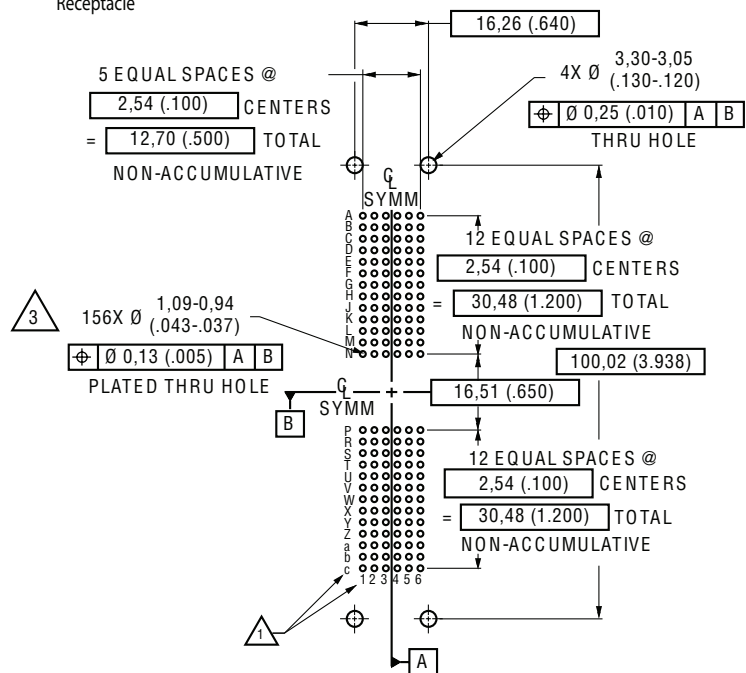

DLD1-156

Plug 

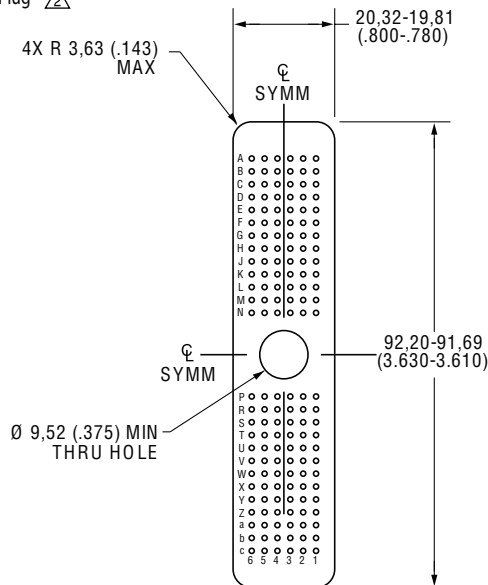

Receptacle

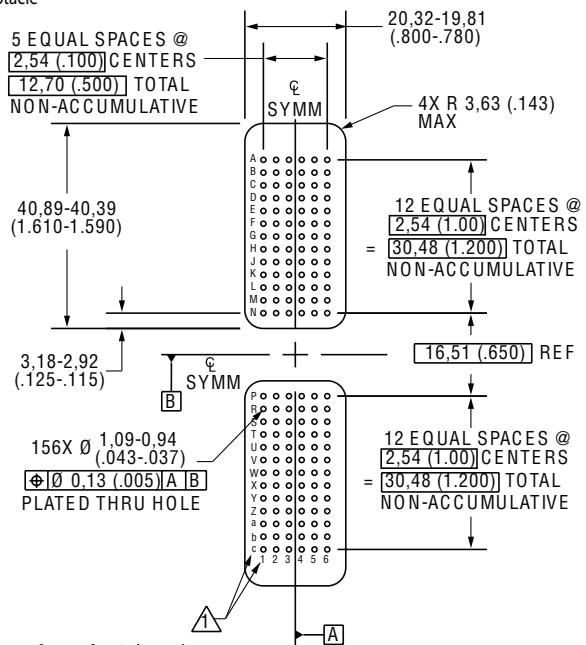

Notes:

- Contact hold cavity identifications shown are typical as viewed from top surface of P.C. board.
- All plug layout dimensions not shown are similar to the receptacle dimensions
- Plated through (THRU) hole diameters shown are for 0,64 (.025) post contacts. PC/RC contact plated through (THRU) hole diameters are 0,79 - 0,64 (.031-.025). For PCB pad layout configuration see page

DL2 / DLM2 / DLD2 Printed Circuit Board Hole Patterns

DL2-96/DLM2-96

Plug 

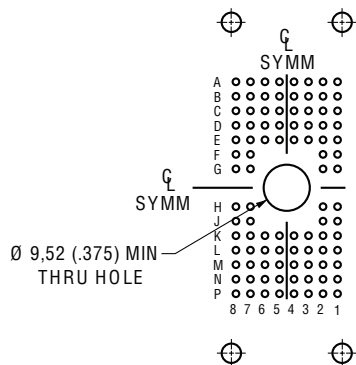

Receptacle

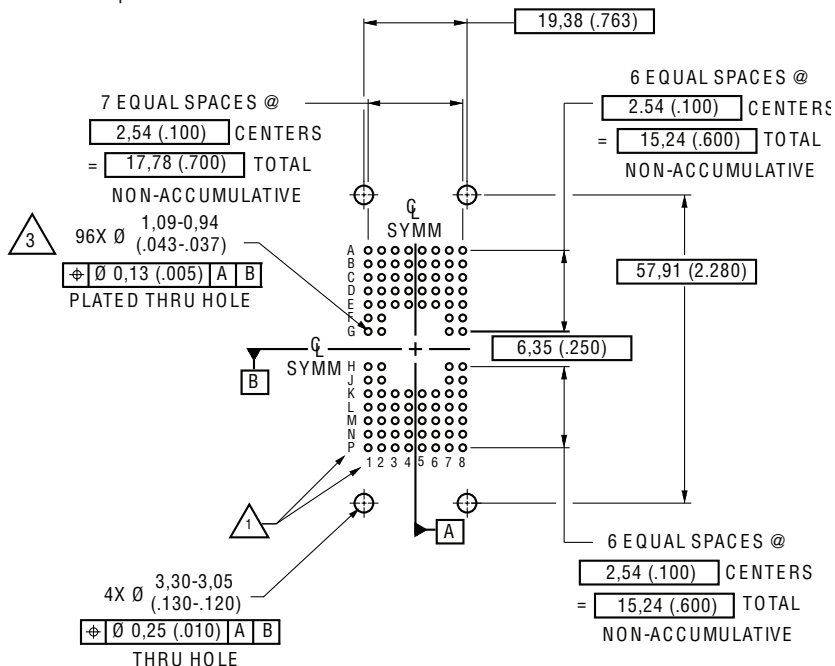

DLD2-96

Plug 

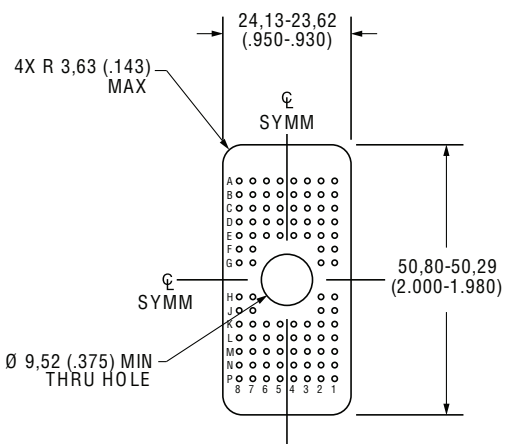

Receptacle

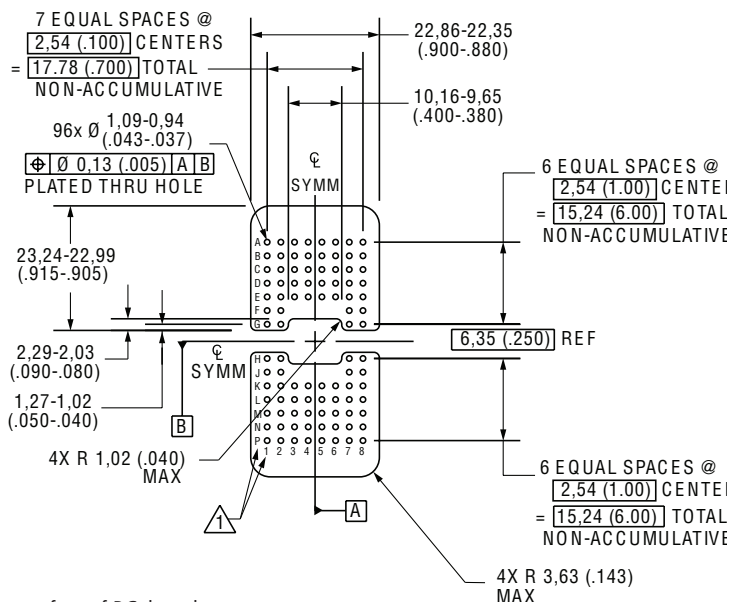

Notes:

1. Contact hold cavity identifications shown are typical as viewed from top surface of P.C. board.
2. All plug layout dimensions not shown are similar to the receptacle dimensions
3. Plated through (THRU) hole diameters shown are for 0,64 (.025) post contacts. PC/RC contact plated through (THRU) hole diameters are 0,79 - 0,64 (.031-.025). For PCB pad layout configuration see page



Dimensions shown in mm (inch)
Specifications and dimensions subject to

www.ittcannon.com

DL3 / DLM3 / DL5 / DLM5 Printed Circuit Board Hole Patterns

DL3-60/DLM3-60

Plug 

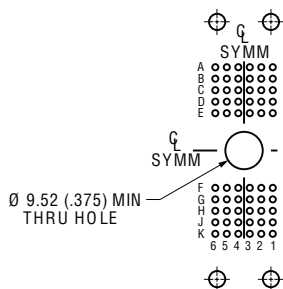

Receptacle

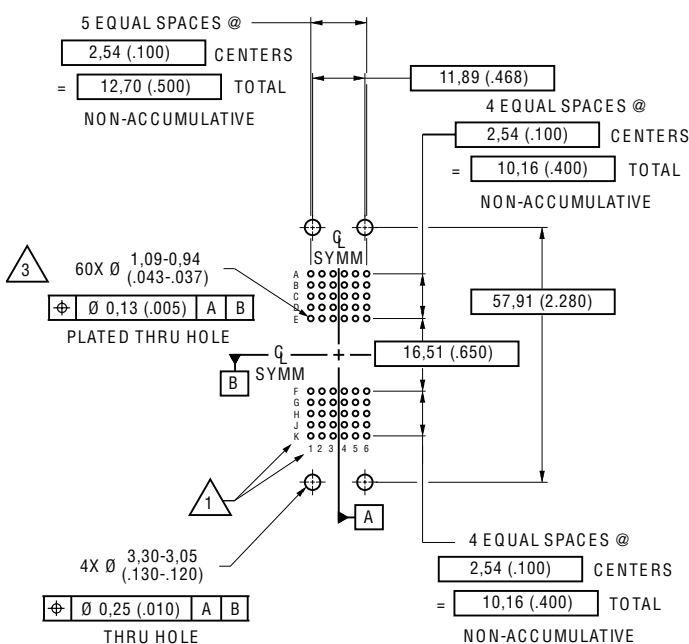

DL5-260/DLM5-260

Plug 

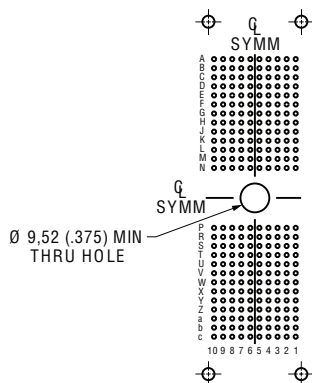

Receptacle

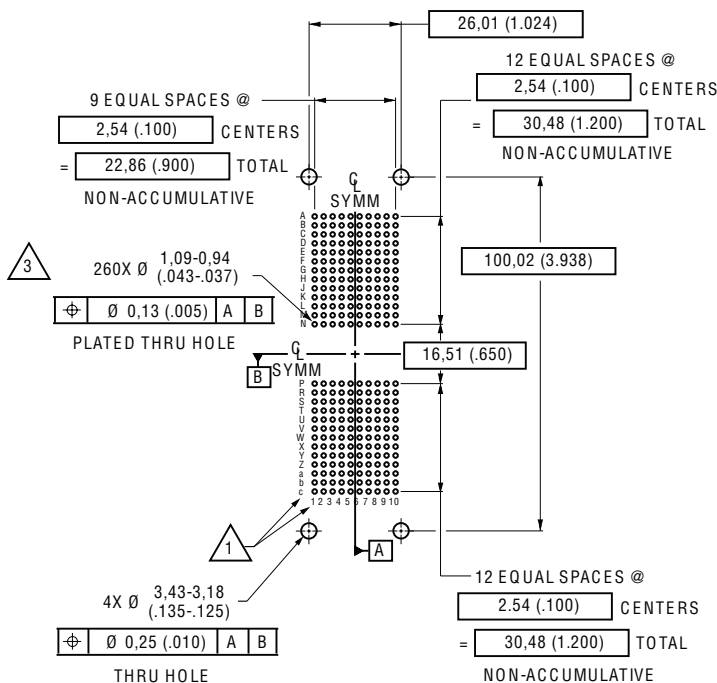

Notes:

1. Contact hold cavity identifications shown are typical as viewed from top surface of P.C. board.
2. All plug layout dimensions not shown are similar to the receptacle dimensions
3. Plated through (THRU) hole diameters shown are for 0,64 (.025) post contacts. PC/RC contact plated through (THRU) hole diameters are 0,79 - 0,64 (.031-.025). For PCB pad layout configuration see page

DL5 Plastic Press-Fit (Receptacle only)

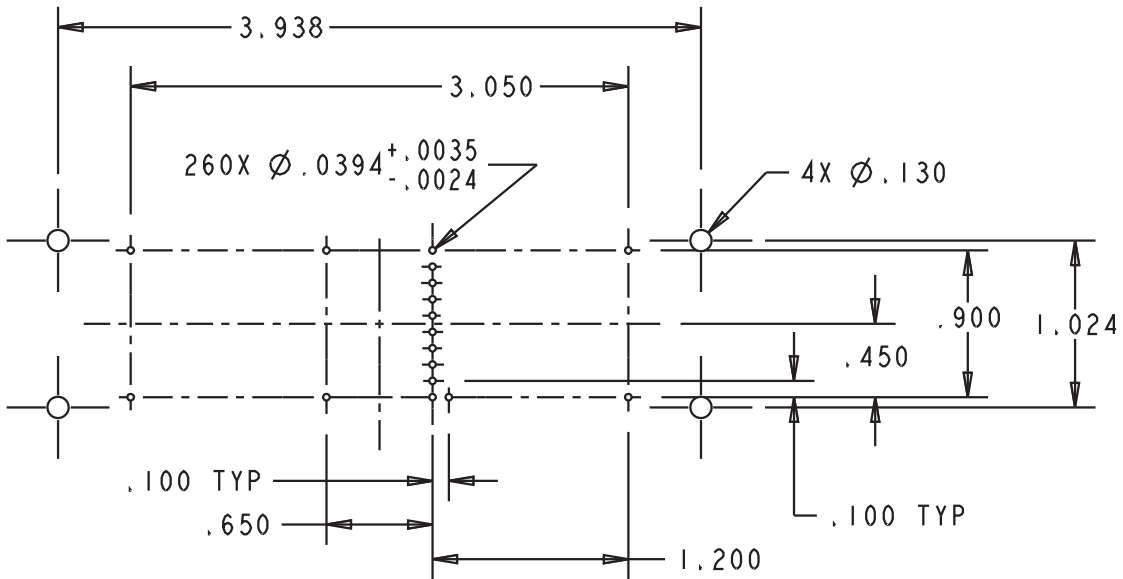

DLM5 Press-Fit Printed Circuit Board Hole Patterns

Plug

THROUGH HOLE SPECIFICATION 260-D T.H.

	T. H. SOLDER T.H.	T. H. COPPER T.H.
HOLE DIA. D	$\phi 0.6 \pm 0.075$	$\phi 0.6^{+0.075}_{-0.05}$
DRILL HOLE DIA.	$\phi 0.7 \pm 0.025$	$\phi 0.7 \pm 0.025$
Cu PLATING	20~50 μm	25~65 μm
Sn/Pb PLATING	5~15 μm	

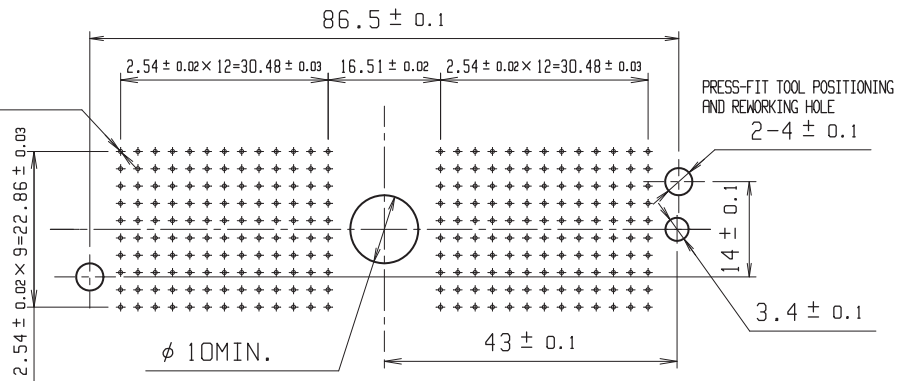

RECOMMENDED PCB THICKNESS t=1.6

Receptacle

THROUGH HOLE SPECIFICATION

	T. H. SOLDER T.H.	T. H. COPPER T.H.
HOLE DIA. D	$\phi 0.6 \pm 0.075$	$\phi 0.6^{+0.075}_{-0.05}$
DRILL HOLE DIA.	$\phi 0.7 \pm 0.025$	$\phi 0.7 \pm 0.025$
Cu PLATING	20~50 μm	25~65 μm
Sn/Pb PLATING	5~15 μm	

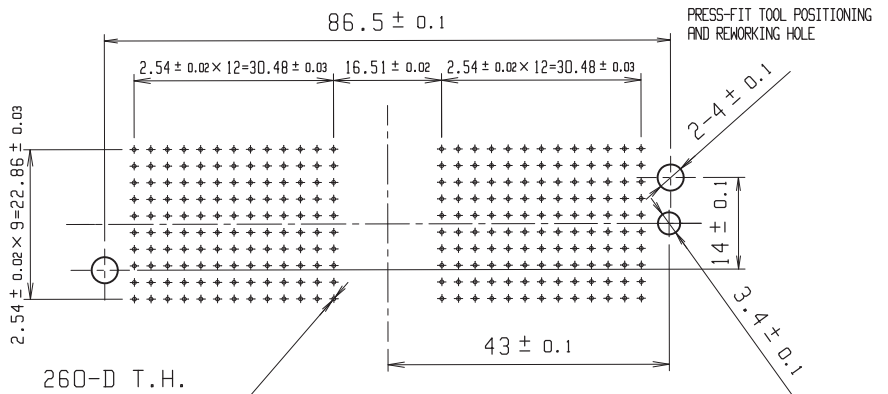

t=1.6



Dimensions shown in mm (inch)
Specifications and dimensions subject to

www.ittcannon.com

DLM6 Printed Circuit Board Hole Patterns

DLM6-360

Plug

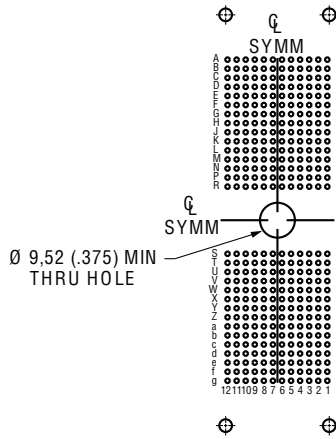

Receptacle

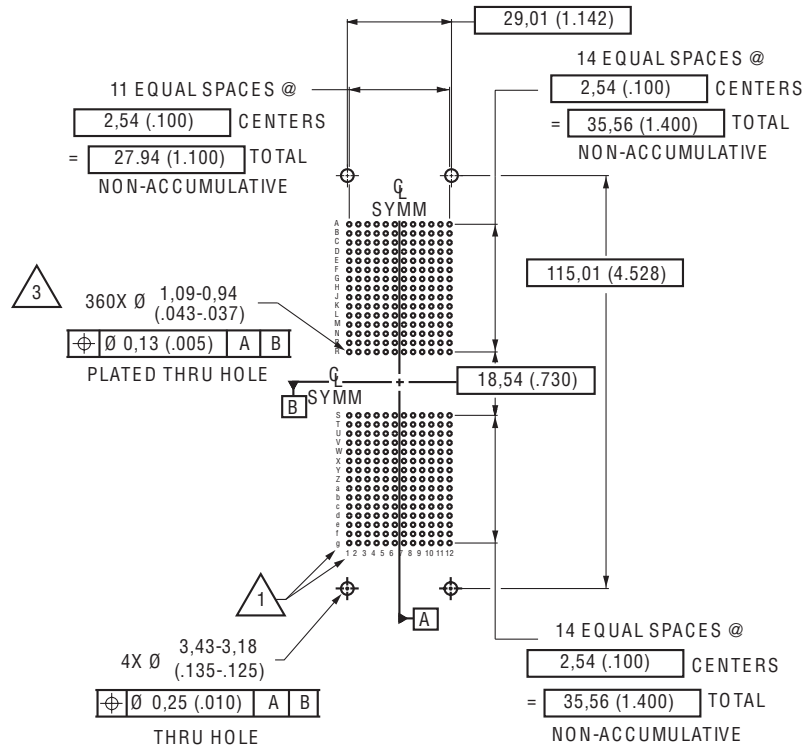

Notes:

1. Contact hold cavity identifications shown are typical as viewed from top surface of P.C. board.
2. All plug layout dimensions not shown are similar to the receptacle dimensions
3. Plated through (THRU) hole diameters shown are for 0,64 (.025) post contacts. PC/RC contact plated through (THRU) hole diameters are 0,79 - 0,64 (.031-.025). For PCB pad layout configuration see page

DLP-272 Printed Circuit Board Pad Layout

Plug

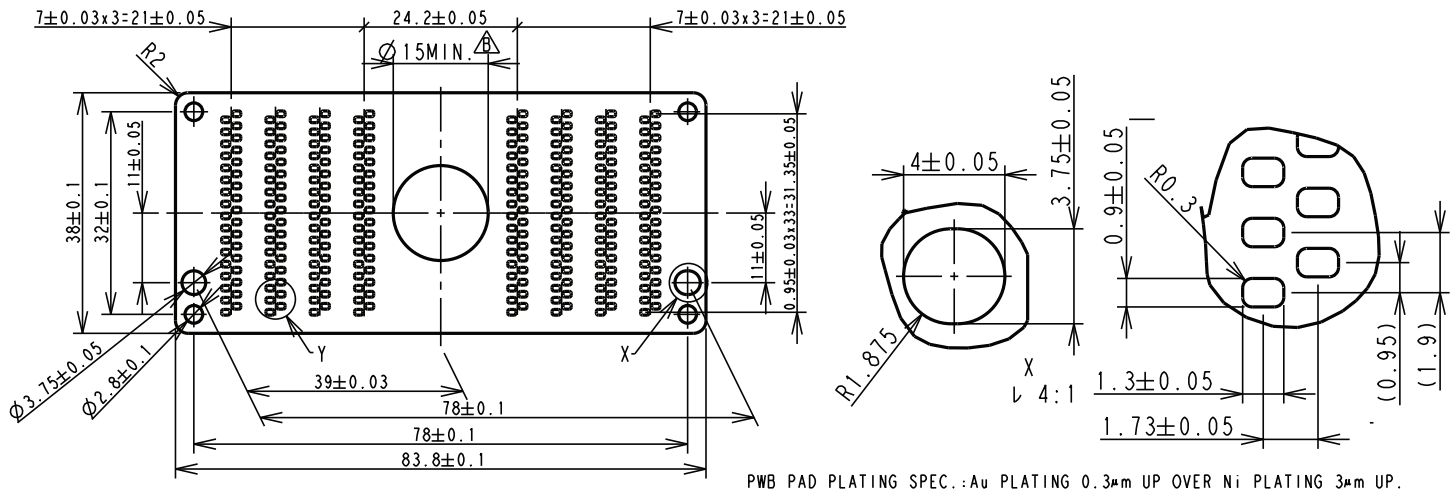

DLP-272 Printed Circuit Board Hole Pattern

Receptacle

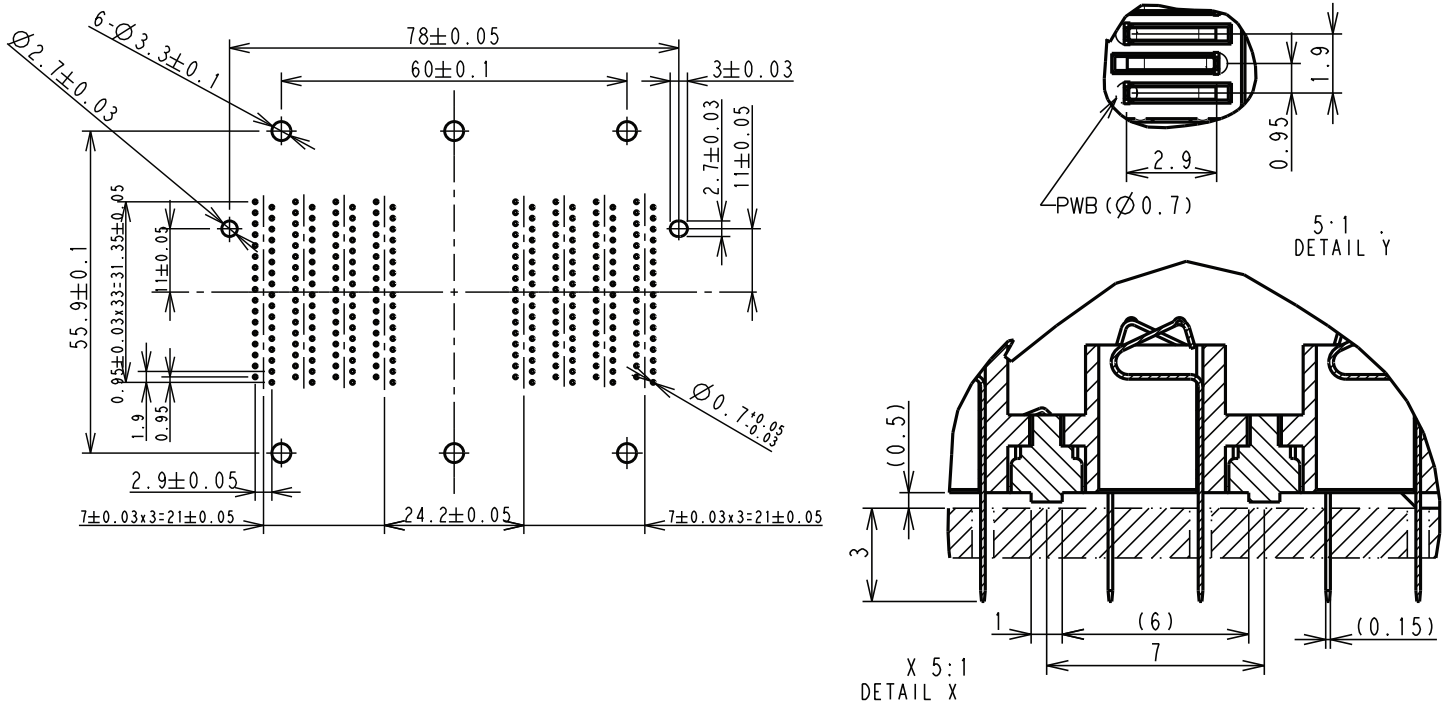

DLP 408 Printed Circuit Board Pad Layout / Hole Patterns

Plug

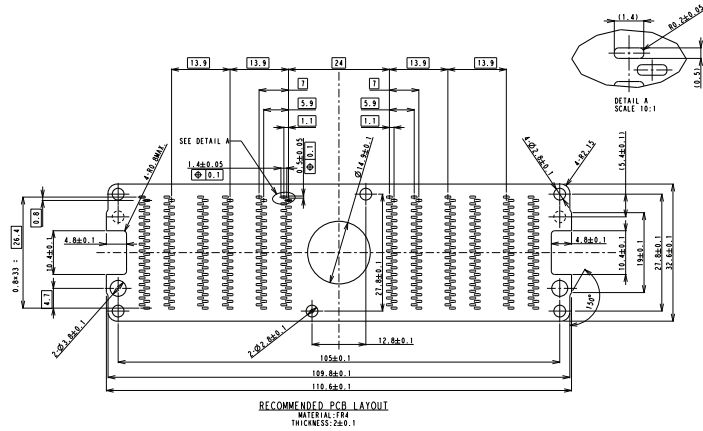

Receptacle

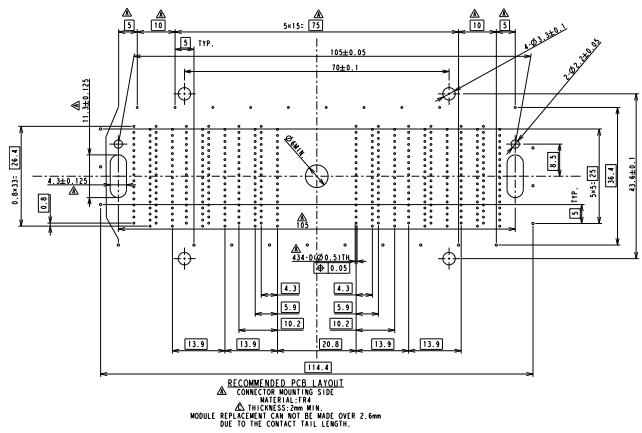

Note: PWB Pad plating Gold 5 μm up over nickel 6 μm up

QLC Printed Circuit Board Pad Layout / Hole Patterns

Plug

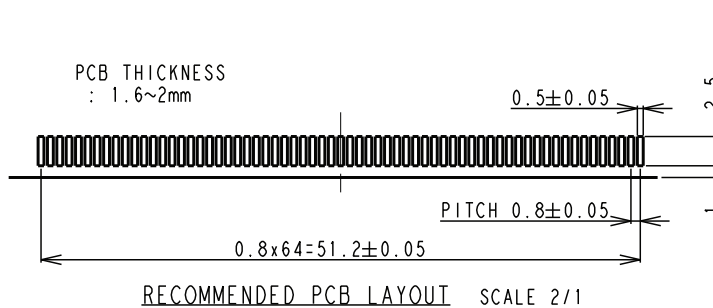

Receptacle

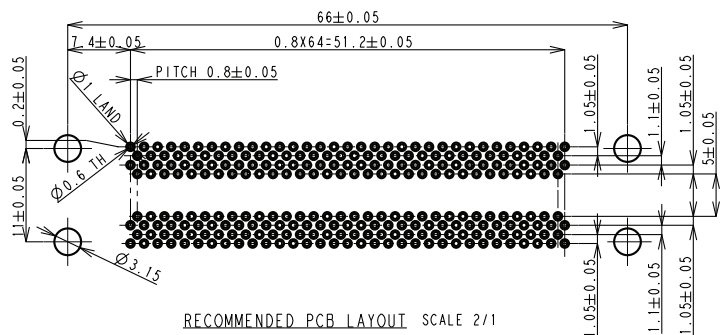

DL / DLM panel Cutouts and Mounting Hole Patterns

DL1-156/DLMI-156

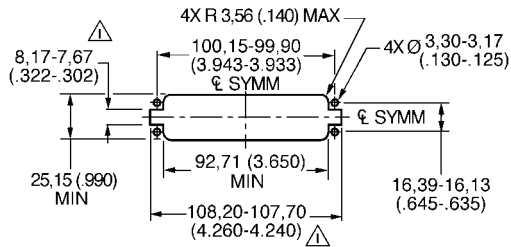

\triangle Required for Center Mounting Polarization Only

DL2-96/DLM2-96

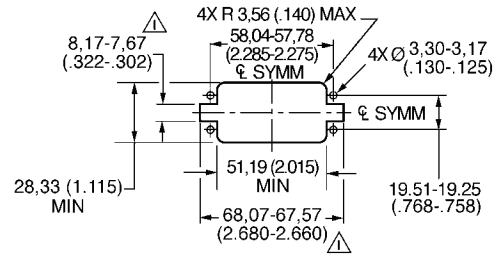

\triangle Required for Center Mounting Polarization Only

DL3-60/DLM3-60

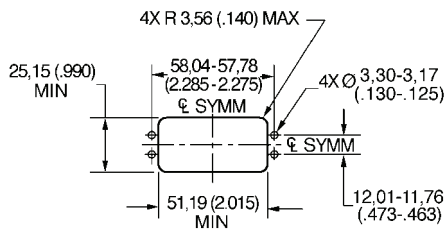

DL4-624

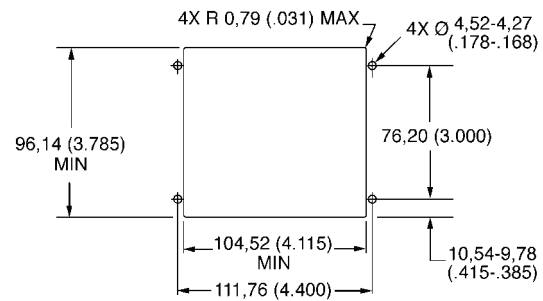

DL5-260/DLM5-260

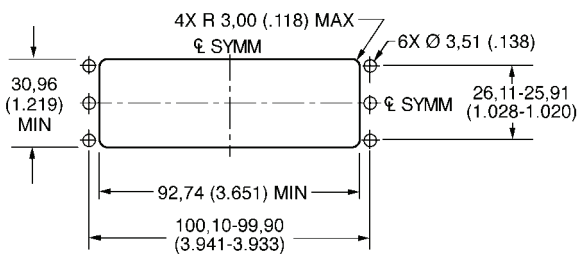

DLM6-360

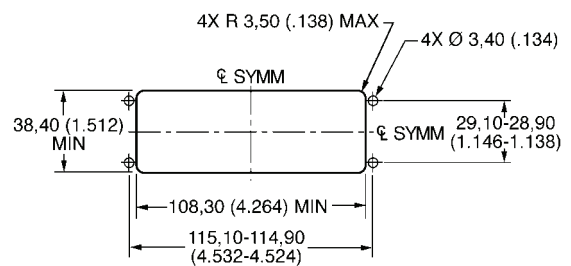

DLD1 Panel Cutouts and Mounting Hole Patterns

DLD1-156 Plug

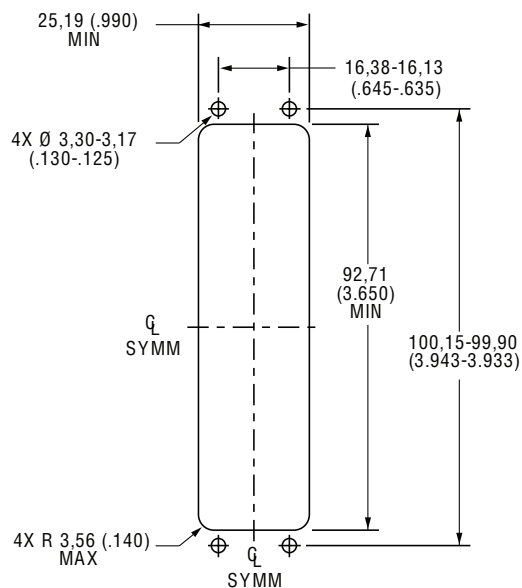

DLD1-156 Receptacle

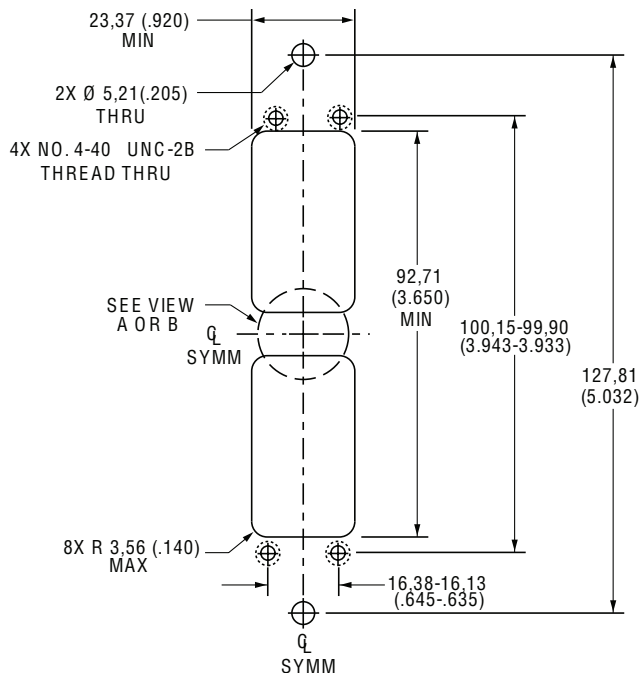

Front Panel Bridge

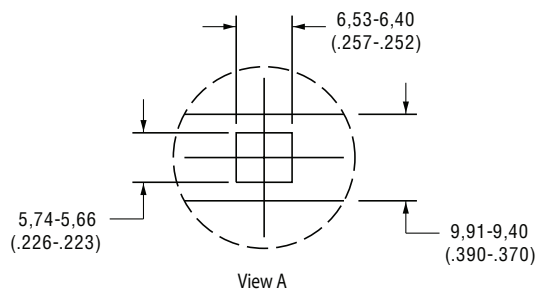

Rear Panel Bridge

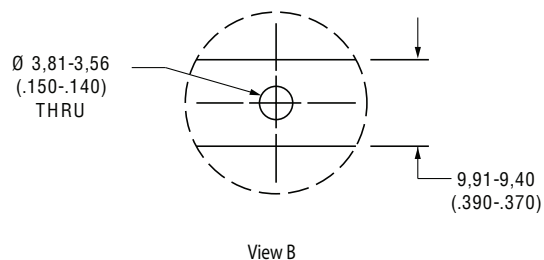

DLD2 Panel Cutouts and Mounting Hole Patterns

DLD2-96 Plug

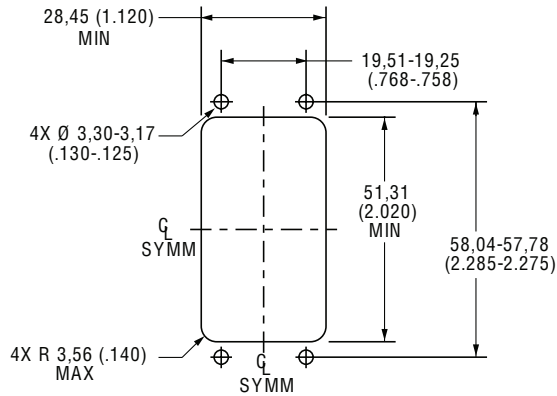

DLD2-96 Receptacle

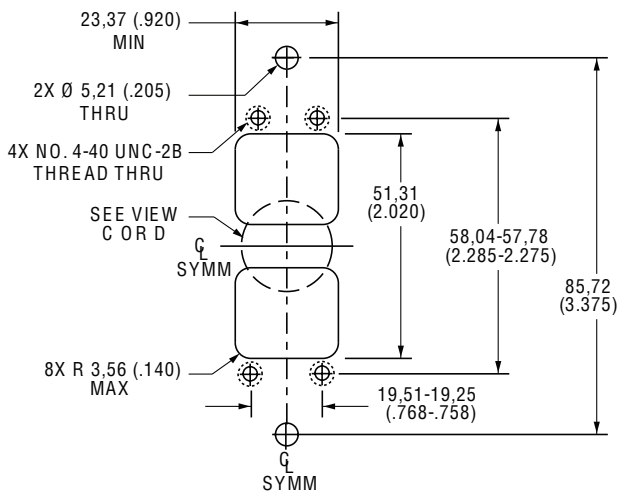

Front Panel Bridge

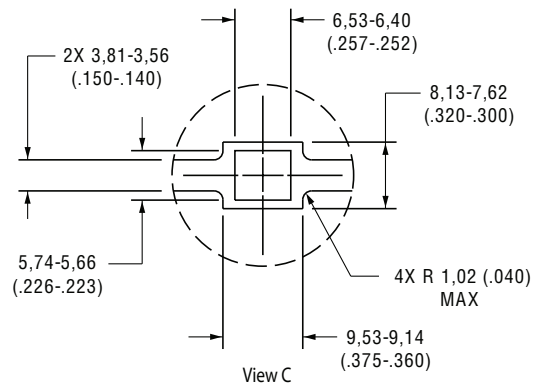

Rear Panel Bridge

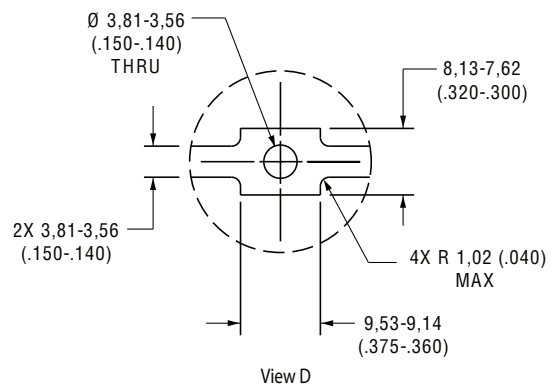

Dimensions shown in mm (inch)
Specifications and dimensions subject to

www.ittcannon.com

Contact Cavity Arrangements - Rear View

DL1-156/DLMI-156/DLDI-156

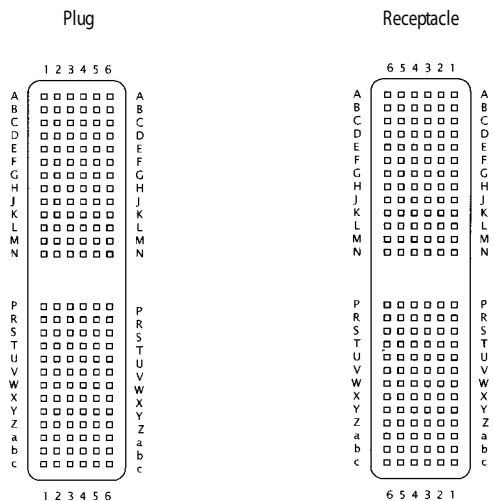

DL2-96/DLM2-96/DLD2-96

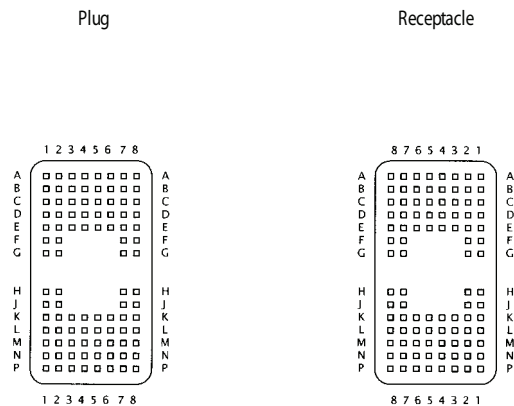

DL3-60/DLM3-60

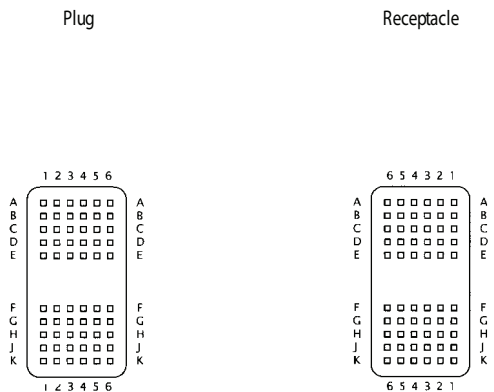

Contact Cavity Arrangements - Rear View

DL4-624

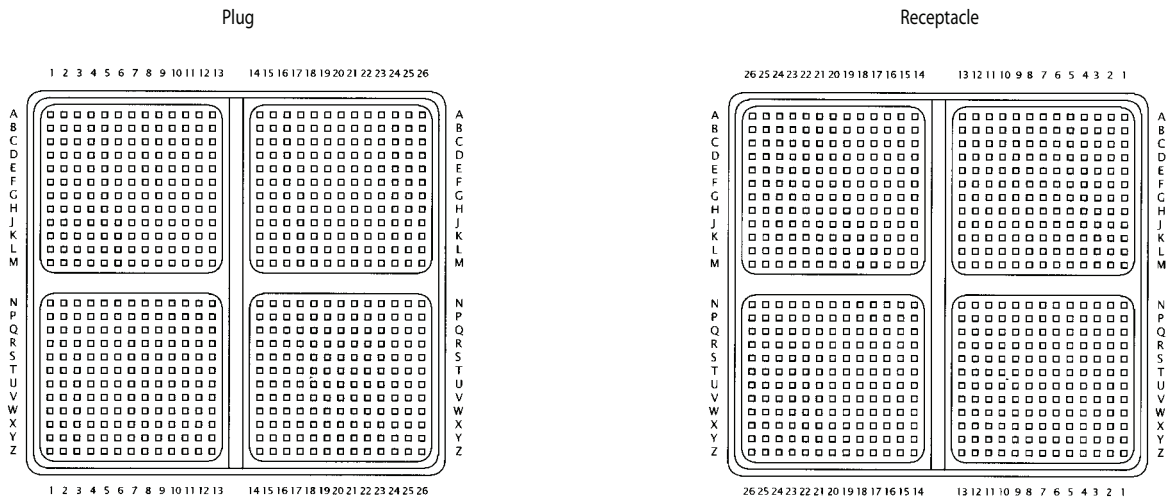

DL5-260/DLM5-260

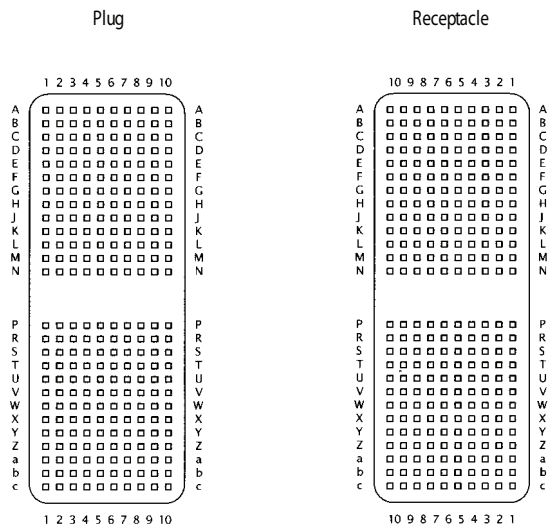

DLM6-360

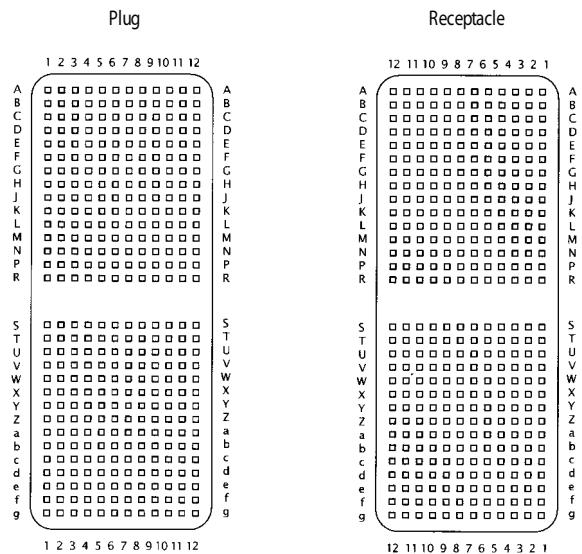

Cannon ZIF Connectors

Contact Cavity Arrangement

Contact Cavity Arrangements

DLP 272

Front View

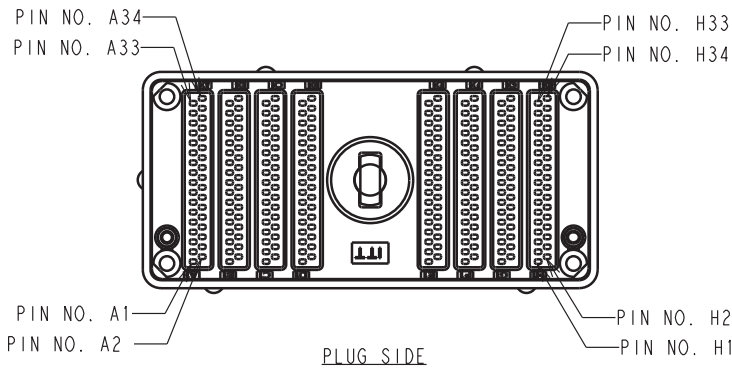

Rear View

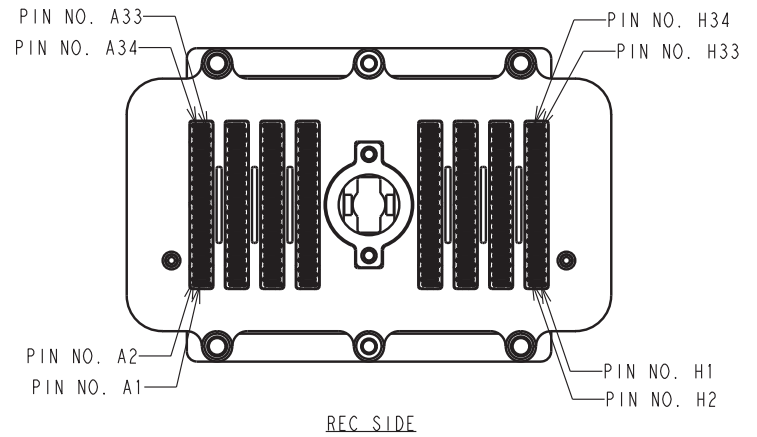

DLP 408

Front View

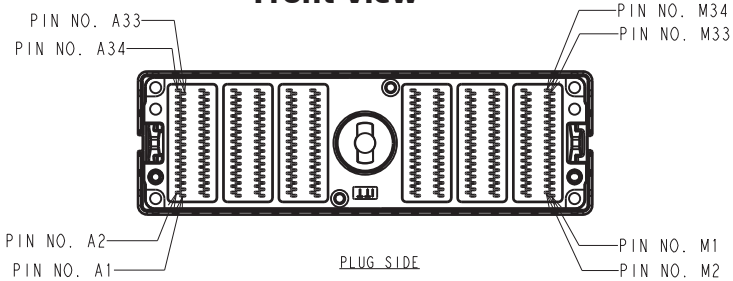

Rear View

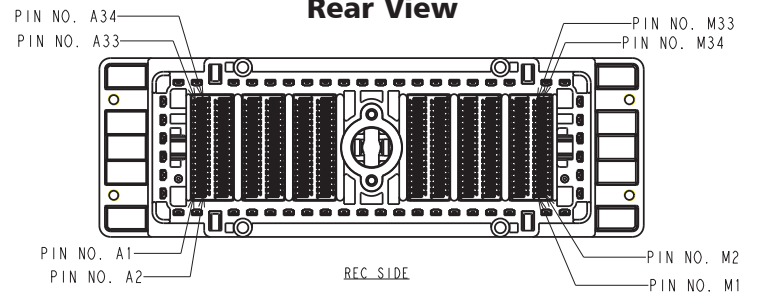

QLC

Front View

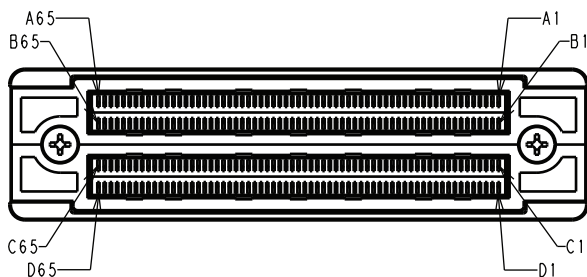

Rear View

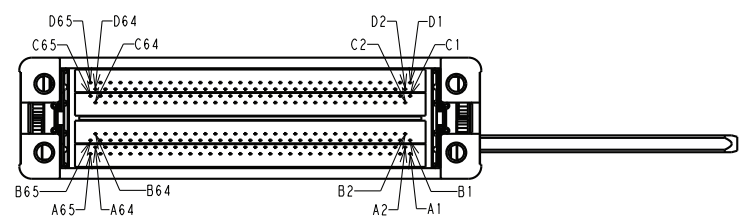

DLD Drawer - Assembly Dimensions

DLD Assembly Dimensions



The DLD Drawer features ZIF assembly for greater contact life and eliminates the rod normally used in such products.

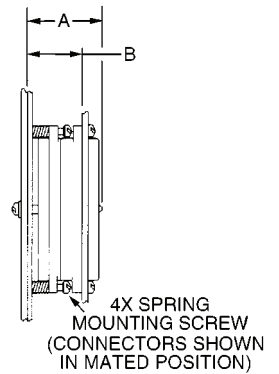
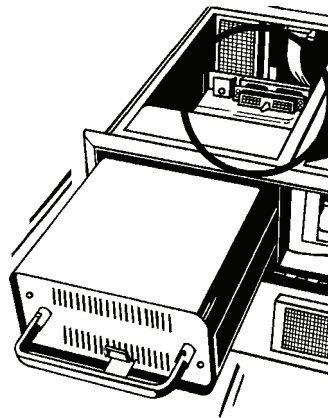
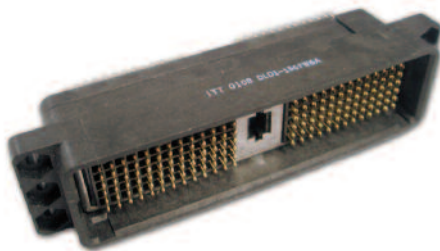

Shell Size	Contact Type	A REF	B REF
DLD1	Crimp	46,86 (1.845)	31,75 (1.250)
DLD1	Square Post	57,03 (2.245)	41,91 (1.650)
DLD2	Crimp	46,86 (1.845)	31,75 (1.250)
DLD2	Square Post	57,03 (2.245)	41,91 (1.650)

DLD Drawer -Mating Sequence

Figure 1

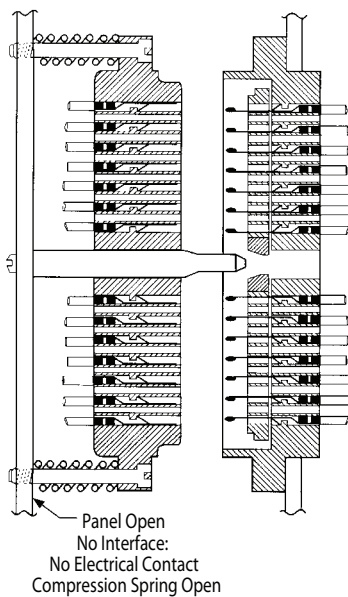

Contacts Aligned

Figure 2

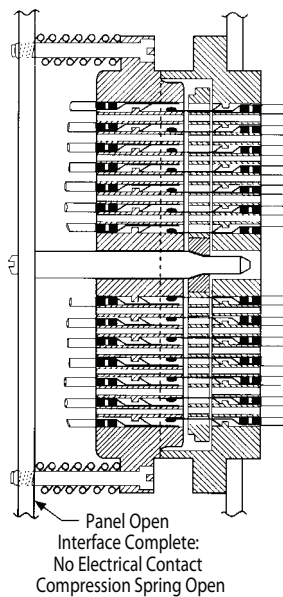

Contacts Aligned

Figure 3

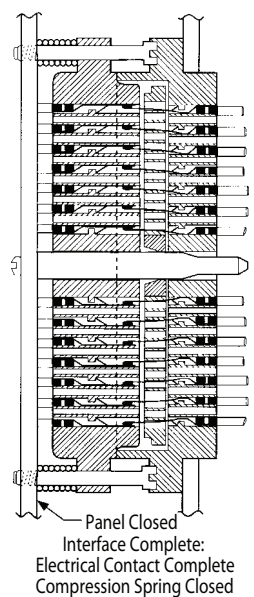

Contacts Aligned

1. MATERIAL CONTENT AND PHYSICAL FORM

Electrical connectors do not usually contain hazardous materials. They contain conducting and non-conducting materials and can be divided into two groups.

a) Printed circuit types and low cost audio types which employ all plastic insulators and casings.

b) Rugged, Fire Barrier and High Reliability types with metal casings and either natural rubber, synthetic rubber, plastic or glass insulating materials. Contact materials vary with type of connector and also application and are usually manufactured from either: Copper, copper alloys, nickel, alumel, chromel or steel. In special applications, other alloys may be specified.

2. FIRE CHARACTERISTICS AND ELECTRIC SHOCK HAZARD

There is no fire hazard when the connector is correctly wired and used within the specified parameters. Incorrect wiring or assembly of the connector or careless use of metal tools or conductive fluids, or transit damage to any of the component parts may cause electric shock or burns. Live circuits must not be broken by separating mated connectors as this may cause arcing, ionization and burning. Heat dissipation is greater at maximum resistance in a circuit. Hot spots may occur when resistance is raised locally by damage, e.g. cracked or deformed contacts, broken strands of wire. Local overheating may also result from the use of the incorrect application tools or from poor quality soldering or slack screw terminals. Overheating may occur if the ratings in the product Data Sheet/Catalog are exceeded and can cause breakdown of insulation and hence electric shock. If heating is allowed to continue it intensifies by further increasing the local resistance through loss of temper of spring contacts, formation of oxide film on contacts and wires and leakage currents through carbonization of insulation and tracking paths. Fire can then result in the presence of combustible materials and this may release noxious fumes. Overheating may not be visually apparent. Burns may result from touching overheated components.

3. HANDLING

Care must be taken to avoid damage to any component parts of electrical connectors during installation and use. Although there are normally no sharp edges, care must be taken when handling certain components to avoid injury to fingers. Electrical connectors may be damaged in transit to the customers, and damage may result in creation of hazards. Products should therefore be examined prior to installation/use and rejected if found to be damaged.

4. DISPOSAL

Incineration of certain materials may release noxious or even toxic fumes.

5. APPLICATION

Connectors with exposed contacts should not be selected for use on the current supply side of an electrical circuit, because an electric shock could result from touching exposed contacts on an unmated connector. Voltages in excess of 30 V ac or 42.5 V dc are potentially hazardous and care should be taken to ensure that such voltages cannot be transmitted in any way to exposed metal parts of the connector body. The connector and wiring should be checked, before making live, to have no damage to metal parts or insulators, no solder blobs, loose strands, conducting lubricants, swarf, or any other undesired conducting particles. Circuit resistance and continuity check should be made to make certain that there are no high resistance joints or spurious conducting paths. Always use the correct application tools as specified in the Data Sheet/Catalog. Do not permit untrained personnel to wire, assemble or tamper with connectors. For operation voltage please see appropriate national regulations.

IMPORTANT GENERAL INFORMATION

(i) Air and creepage paths/Operating voltage. The admissible operating voltages depend on the individual applications and the valid national and other applicable safety regulations.

For this reason the air and creepage path data are only reference values. Observe reduction of air and creepage paths due to PC board and/or harnessing.

(ii) Temperature

All information given are temperature limits. The operation temperature depends on the individual application.

(iii) Other important information

Cannon continuously endeavors to improve their products. Therefore, Cannon products may deviate from the description, technical data and shape as shown in this catalog and data sheets.

ITT Interconnect Solutions, a Division of ITT Corporation manufactures the highest quality products available in the marketplace; however these products are intended to be used in accordance with the specifications in this publication. Any use or application that deviates from the stated operating specifications is not recommended and may be unsafe. No information and data contained in this publication shall be construed to create any liability on the part of Cannon. Any new issue of this publication shall automatically invalidate and supersede any and all previous issues.

Product Warranty

A limited warranty applies to Cannon products. In general, except for obligations assumed by Cannon under this warranty, Cannon shall not be liable for any loss, damage, cost of repairs, incidental or consequential damages of any kind, whether or not based on express or implied warranty, contract, negligence or strict liability arising in connection with the design, manufacture, sale, use or repair of the products. Product availability, prices and delivery dates are exclusively subject to our respective order confirmation form; the same applies to orders based on development samples delivered. Please refer to www.ittcannon.com (General Terms of Sale) for the complete text of Cannon's applicable Terms and Conditions, including Warranty.

This publication is not to be construed as an offer. It is intended merely as an invitation to make an offer. By this publication, Cannon does not assume responsibility or any liability for any patent infringements or other rights of third parties which may result from its use.

Reprinting this publication is generally permitted, indicating the source. However, Cannon's prior consent must be obtained in all cases. "Engineered for life" is a registered trademark of ITT Corporation ©2006. All other trademarks or registered trademarks are property of their respective owners. All dates subject to change without notice.

Commodities in this catalog may be controlled for export by the International Traffic in Arms Regulations (ITAR) and Export Administration Regulations (EAR) when specifically designed modified, or configured for articles controlled by the United States Government.



Circular/Filter/Hermetic/Fiber Optic Connectors

As a world leader in circular, filter, and hermetic connectors, ITT can leverage its design and manufacturing expertise to fit virtually any application. Our expertise includes fast positive mating for a wide range of military applications, as well as numerous sizes and contact configurations for various harsh environments. Our wide variety of fiber optic products include hybrid contacts, multi-channel, rack and panel, and hi-rel assemblies, including MIL and ARINC standard solutions. ITT can meet numerous specs, including NATO and MIL standards.



www.ittcannon.com/circulars • www.ittcannon.com/filter • www.ittcannon.com/hermetics • www.ittcannon.com/fiberoptics

D-Subminiature Connectors

Cannon invented D-sub connectors in 1952. Our family of D-Subs now includes combinations of signal, power and RF, as well as severe service sealed connectors. Cannon D-Subs are available with an extensive line of backshells and accessories and are one of the most economical shielded connector solutions available. ITT D-Sub connectors are qualified to the MIL-DTL-24308 specification.

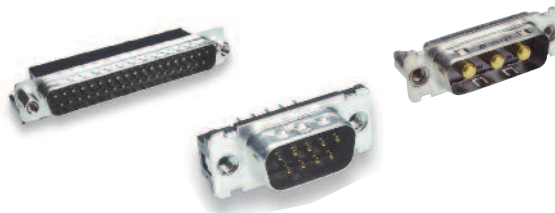

www.ittcannon.com/dsubs

Microminiature Connectors

Developed first by Cannon in the 1960's, Interconnect Solutions microminiature connectors offer high performance and reliability with exceptional versatility. Available in rectangular, circular, and strip configurations for countless applications, many of our connectors meet or exceed applicable requirements of the MIL-DTL-83513 specification.



www.ittcannon.com/micro

Rack and Panel Connectors

Initially pioneered by Cannon during the 1930s, Interconnect Solutions is the world leader in rack and panel connectors, offering unmatched variety of shell configurations and insert arrangements, materials, plating, and contact options. Many of our standard and custom designs meet the stringent requirements of ARINC 600, ARINC 404 (MIL-C-81659), and MIL-DTL-83733 standards.

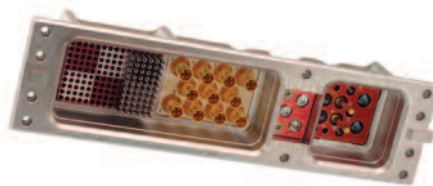

www.ittcannon.com/rackandpanel

RF Connectors

ITT Interconnect Solutions has been providing interconnect products to the Microwave and RF industry since 1963 (formerly The Sealectro Corporation). The RF 50 & 75 Ohm product lines cover UHF band through Ku band requirements. These connectors and cable assemblies are available with a thread type, snap type, bayonet type or slide on coupling method. The frequencies range from DC to 18+ GHz.



www.ittcannon.com/RF50 • www.ittcannon.com/RF75

Transportation

The ITT ICS interconnect range includes sealed circular and rectangular connectors in metal or plastic shells. These configurations include board to cable or cable to cable/ bulkhead applications. Both signal and power contacts can be combined in various layouts. All product lines within the Transportation segment offer very low contact resistance providing maximum signal integrity.



www.ittcannon.com/transportation

ITT Interconnect Solutions is an international manufacturer and supplier of connectors including circular, rectangular, fiber optic, RF, power and high voltage, audio, PCMCIA, Compact Flash Card, enclosures, cable assemblies, and application specific custom solutions. The Interconnect Solutions portfolio includes the brands Cannon, VEAM, and BIW. As a worldwide leader in connector technology for nearly a century, ITT offers one of the broadest product offerings, six sigma manufacturing capability, Value Based Product Development with exceptional engineering capability, and an extensive sales, distribution, and customer support network.





ITT

Customer Support Locations

CHINA

Tuopandun Industrial Area, Jinda Cheng,
Xiner Village, Shajing Town,
Baoan District, Shenzhen City,
Guangdong, China 518125
Phone: +86.755.2726.7238
Fax: +86.755.2726.7515

GERMANY

Cannonstrasse 1
Weinstadt, 71384
phone: +49.7151.699.0
fax: +49.7151.699.217

FRANCE

15, Boulevard Robert Thiboust
Serris, France 77700
phone: +33.1.60.04.93.93
fax: +33.1.60.04.93.90

HONG KONG

Units 2405-6, 24/F, ING Tower
308 Des Voeux Road
Central
Hong Kong
phone: +852.2732.2720
fax: +852.2732.2919

ITALY

Corso Europa 41/43
Linate (MI),
Italy 20020
phone: +39.02938721
fax: +39.0293872300

JAPAN

11-3, 5 Chome, Hibarigaoka, Zama-shi
Kanagawa, Japan 228-0003
phone: +52.631.311.0050
fax: + 52.631.314.0060

UK

Jays Close, Viables Estate
Basingstoke, RG22 4BA
phone: +44.1256.311200
fax: +44.1256.323356

USA

666 East Dyer Road
Santa Ana, CA 92705
toll free: 1.800.854.3028
phone: 1.714.557.4700
fax: 1.714.628.2142

©2009 ITT Corporation. "ITT," "Engineered for Life," the ITT Engineered Blocks Logo, "Cannon," "BIW Connector Systems," and "VEAM" are trademarks of ITT Corporation. Specification and other data are based on information available at the time of printing, and are subject to change without notice.

Space Connectors January 2009

www.ittcannon.com

X-ON Electronics

Largest Supplier of Electrical and Electronic Components

Click to view similar products for [Circular MIL Spec Tools, Hardware & Accessories](#) category:

Click to view products by [ITT](#) manufacturer:

Other Similar products are found below :

[809-199-3](#) [001104](#) [300 04](#) [0113-201-2025](#) [600-006-16](#) [600-079-06](#) [M10-101982-143](#) [M10-101982-163](#) [M10-101983-183](#) [M10-150912-083](#)
[M10-454396-008](#) [602GB18808](#) [CS3102A-22-14PW](#) [M225201-06](#) [M24758-20E21](#) [M2887610-BC](#) [M2887615-CD](#) [M38999/9-19B](#) [62GB-](#)
[812-10](#) [630A007NF083A](#) [630B007M051A](#) [630BJ003NF032H](#) [637-149NF04B](#) [M39029/29-215](#) [650FS002NF16](#) [M81969-14-02](#) [660-](#)
[008NF14S7-01](#) [660-009M22H8-03](#) [660-013NF19U6-210](#) [660-015M10S6-17](#) [660-015NF10S5-01](#) [660-015NF14R3.5-01](#) [660-023NF19H6-19](#)
[660-024N09S5-104](#) [660-024NF11S12-01](#) [660-024NF11S3-01](#) [660-024NF17S4-109](#) [660-050XM17F4-01](#) [660-068NF25R6-30G](#) [660-](#)
[070M23S8-04](#) [660-073MTCH9-20](#) [M83723/60-116RC](#) [M83723/61-18W](#) [M83723/61-218R](#) [M83723/61-224W](#) [667-084-23C](#) [667-084-35C](#)
[667-224NF16](#) [M85049/126S11N](#) [M85049130-07M](#) [M85049140-09BC](#)