

## Cylindrical High Power Surface Mount Metal Glaze™

### CHP Series

- Up to 2 watts
- Up to 1000 volts
- 0.2 ohm to 2.2 megohm range
- RoHS-compliant version available
- 150°C maximum operating temperature

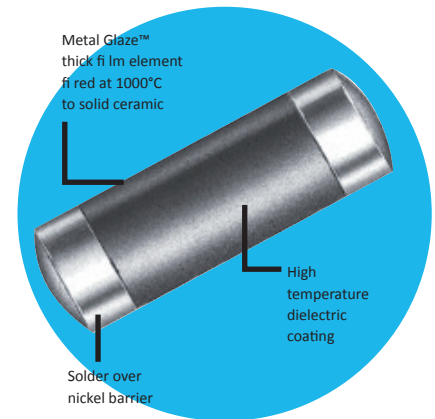

 All Pb-free parts comply with EU Directive 2011/65/EU (RoHS2)

### Electrical Data

IRC Type	Industry Foot-print	Size Code <sup>1</sup>	Maximum Power Rating	Working Voltage <sup>2</sup>	Maximum Voltage	Resistance Range (ohms) <sup>3</sup>	Product Category	Tolerance (±%) <sup>3</sup>	TCR (ppm/°C) <sup>3</sup>
CHP 1/8	1206	B & C	1/4W @ 70°C	200	400	0.1 to 0.99	Low Range	1, 2, 5	100
						1.0 to 1.0 M	Standard	1, 2, 5	50, 100
						20 to 348K	Tight Tolerance	0.25, 0.5	50, 100
CHP 1/2	2010	D & E	1/2W @ 70°C	300	600	0.1 to 0.99	Low Range	1, 2, 5	100
						1.0 to 348K	Standard	1, 2, 5	50, 100
						20 to 348K	Tight Tolerance	0.25, 0.5	50, 100
CHP 1	2512	F	1W @ 70°C	350	700	0.1 to 0.99	Low Range	1, 2, 5	100
						1.0 to 2.21M	Standard	1, 2, 5	50, 100
						20 to 348K	Tight Tolerance	0.25, 0.5	50, 100
CHP 2	3610	H	2W @ 25°C 1.33W @ 70°C	500	1000	0.2 to 0.99	Low Range	1, 2, 5	100
						1.0 to 2.21M	Standard	1, 2, 5	50, 100

<sup>1</sup>See pages 2 & 3 for product dimensions, recommended solder pads, and standard packaging.    <sup>2</sup>Not to exceed  $\sqrt{P \times R}$     <sup>3</sup>Consult factory for tighter TCR, tolerance, or resistance values.

### Environmental Data







Characteristics	Maximum Change	Test Method
Thermal Shock	±0.25% +.01 Ω	MIL-PRF-55342H, §4.8.3 (MIL-STD-202, Method 107G: +150°C / -65°C)
Low Temperature Operation	±0.25% +.01 Ω	MIL-PRF-55342H, §4.8.5 (-65°C)
Short Time Overload	±0.5% +.01 Ω ±1% for R>100KΩ	MIL-PRF-55342H, §4.8.6
High Temperature Exposure	±0.5% +.01 Ω	MIL-PRF-55342H, §4.8.7 (150°C x 100 Hours)
Resistance to Bonding Exposure	±0.25% +.01 Ω	MIL-PRF-55342H, §4.8.8.2
Moisture Resistance	±0.5% +.01 Ω	MIL-PRF-55342H, §4.8.8.2 (MIL-STD-202, Method 106G)
Temperature Coefficient	As specified	MIL-PRF-55342H, §4.8.10 (MIL-STD-202, Method 304)
Life Test	±1% +.01 Ω	MIL-PRF-55342H, §4.8.11 (MIL-STD-202, Method 108A: 2000 Hours @ 70°C)
Solderability	95% minimum coverage	MIL-PRF-55342H, §4.8.12 (MIL-STD-202, Method 208H)
Terminal Adhesion Strength (push)	±1% +.01 Ω (no mechanical damage)	IRC – defined 1200 gram push from underside of mounted device for 60 sec
Terminal Adhesion Strength (flex)	±1% +.01 Ω (no mechanical damage)	IRC-defined Device mounted in center of 90mm long board, deflected 1 mm to exert pull on contacts for 5 seconds

### General Note

TT Electronics reserves the right to make changes in product specification without notice or liability. All information is subject to TT Electronics' own data and is considered accurate at time of going to print.

CHP Series

## Physical Data

IRC Type	Size Code	Industry Footprint	Actual Size			
				Dimensions (Inches and (mm))		
				L	W	C
CHP 1/8	B	1206		0.128 ± 0.007 (3.25 ± 0.18)	0.057 ± 0.006 (1.45 ± 0.15)	0.020 ± 0.010 (0.51 ± 0.25)
MRC 1/2	C	1206		0.128 ± 0.007 (3.25 ± 0.18)	0.063 ± 0.010 (1.60 ± 0.25)	0.020 ± 0.010 (0.51 ± 0.25)
CHP 1/2	D	2010		0.200 ± 0.010 (5.08 ± 0.25)	0.079 (nom.) -0.006 / +0.011 (2.01 (nom.) -0.15 / +0.28)	0.030 ± 0.010 (0.761 ± 0.25)
CHP 1	F	2512		0.251 ± 0.010 (6.38 ± 0.25)	0.079 (nom.) -0.006 / +0.011 (2.01 (nom.) -0.15 / +0.28)	0.040 ± 0.010 (1.02 ± 0.25)
CHP 2	H	3610		0.367 ± 0.010 (9.32 ± 0.25)	0.105 (nom.) -0.006 / +0.011 (2.67 (nom.) -0.15 / +0.28)	0.050 ± 0.010 (1.27 ± 0.25)

## Recommended Solder Pad Dimensions (Reflow):

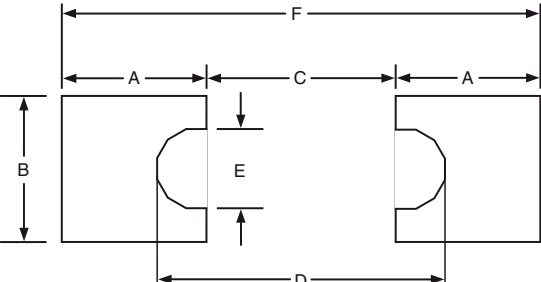
Size Code	Industry Footprint						
		A	B	C	D	E	F
B & C	1206	0.076 (1.93)	0.093 (2.36)	0.058 (1.47)	0.098 (2.49)	0.032 (0.81)	0.211 (5.36)
D	2010	0.111 (2.82)	0.126 (3.20)	0.096 (2.44)	0.152 (3.86)	0.040 (1.02)	0.318 (8.08)
E	2010	0.170 (4.32)	0.160 (4.06)	0.072 (1.83)	0.132 (3.35)	0.044 (1.12)	0.412 (10.46)
F	2512	0.121 (3.07)	0.126 (3.20)	0.127 (3.23)	0.183 (4.65)	0.040 (1.02)	0.369 (9.37)
H	3610	0.170 (4.32)	0.160 (4.06)	0.213 (5.41)	0.273 (6.93)	0.044 (1.12)	0.553 (14.05)

**General Note**

TT Electronics reserves the right to make changes in product specification without notice or liability.  
All information is subject to TT Electronics' own data and is considered accurate at time of going to print.

CHP Series

Standard Reel Packaging per EIA-481:

IRC Type	Size Code	Industry Footprint	Reel Diameter*	Quantity Per Reel	Carrier Tape Width	Component Pitch
CHP 1/8 MRC 1/2	B	1206	7"	2,500 max.	8mm	4mm
	C		13"	10,000 max.		
CHP 1/2 MRC 1	D	2010	7"	1,500 max.	12mm	4mm
	E		13"	5,000 max.		
CHP 1	F	2512	7"	1,500 max.	12mm	4mm
			13"	5,000 max.		
CHP 2	H	3610	13"	1,500 max.	24mm	4mm

\*The 13" reel is considered standard and will be supplied unless otherwise specified.

Power Derating Curve

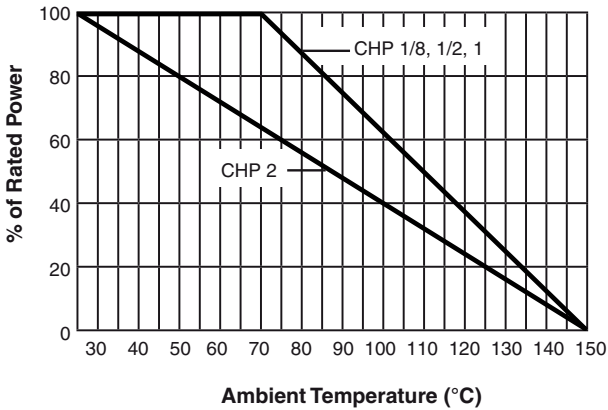

Repetitive Surge Curve

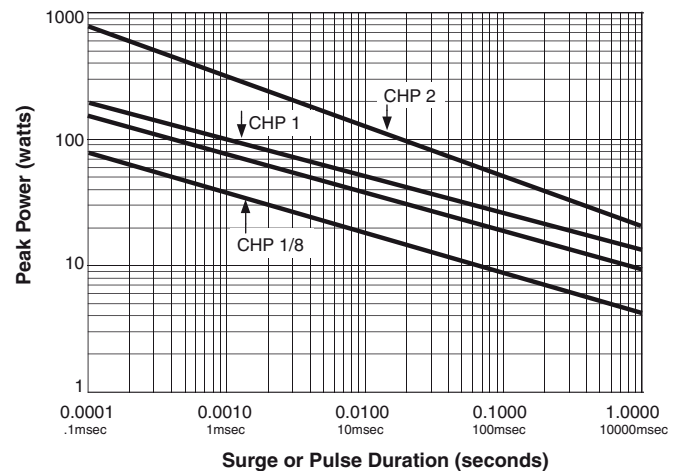

Note: Use for repetitive pulses where the average power dissipation is not to exceed the component rating at 70°C. Surge handling capacity for low-repetitive surges may be significantly greater than shown above. Contact factory for recommendations.

General Note

TT Electronics reserves the right to make changes in product specification without notice or liability. All information is subject to TT Electronics' own data and is considered accurate at time of going to print.

CHP Series

## Ordering Procedure

This product has two valid part numbers:

**European (Welwyn) Part Number: CHP1-220KFI** (CHP1 with TCR  $\pm 100\text{ppm}/^\circ\text{C}$  at 220 kilohms  $\pm 1\%$ , Pb-free)

C	H	P	1				-	2	2	0	K	F	I
1			2			3			4		5		

1 Type	2 TCR (ppm/°C)	3 Value	4 Tolerance	5 Termination & Packing	
CHP1/8	Omit for $\pm 100$	E24 = 3/4 characters	C = $\pm 0.25\%$	I = Pb-free, Tape Pack	
CHP1/2	$-50 = \pm 50$	E96 = 4/5 characters	D = $\pm 0.5\%$	PB = SnPb, Tape Pack	
CHP1		R = ohms	F = $\pm 1\%$	CHP1/8	2500/7" reel
CHP2		K = kilohms	G = $\pm 2\%$	CHP1/2, 1	Tape 1500/7" reel
		M = megohms	J = $\pm 5\%$	CHP2	1500/13" reel

**USA (IRC) Part Number: CHP11002203FLF** (CHP1 with TCR  $\pm 100\text{ppm}/^\circ\text{C}$  at 220 kilohms  $\pm 1\%$ , Pb-free)

C	H	P	1	1	0	0	2	2	0	3	F	L	F
1			2			3			4		5		

1 Type	2 TCR	3 Value	4 Tolerance	5 Termination & Packing	
CHP1/8	50 = $\pm 50$	3 digits + multiplier	C = $\pm 0.25\%$	Omit for SnPb, Standard pack	
CHP1/2	100 = $\pm 100$	R = ohms for values <100 ohms	D = $\pm 0.5\%$	LF = Pb-free, Standard pack	
CHP1			F = $\pm 1\%$	CHP1/8	2500/7" reel
CHP2			G = $\pm 2\%$	CHP1/2 & 1	1500/7" reel
			J = $\pm 5\%$	CHP2	1500/13" reel

**General Note**

TT Electronics reserves the right to make changes in product specification without notice or liability. All information is subject to TT Electronics' own data and is considered accurate at time of going to print.

## X-ON Electronics

Largest Supplier of Electrical and Electronic Components

*Click to view similar products for [TT ELECTRONICS](#) manufacturer:*

Other Similar products are found below :

[OPB482N11Z](#) [DST-1K098-003U-001REVJ](#) [CHP1501R00FLF](#) [898-3-R150K](#) [66XR10](#) [66XR200K](#) [66XR2K](#) [66XR50](#) [67WR1MEG](#)  
[67ZR200](#) [68WR5K](#) [68XR2MEG](#) [7216R500L.25](#) [72PXR10K](#) [72XR2.5K](#) [8109](#) [82PR25K](#) [84WR10KTR](#) [OP131](#) [OPB660N](#) [OPF430](#)  
[89XHR10K](#) [L083S222LF](#) [91XR5K](#) [SML100M12MSF](#) [PFC-W0805LF-03-2870-B](#) [2627](#) [RC55LF-D-196R-B-B](#) [3371R5KL.5](#) [HM00-01800](#)  
[3371R5KL.25](#) [L083C122](#) [040585XM](#) [6679-420-0](#) [OP133W](#) [OPB471T11](#) [OPB741WZ](#) [OPB743WZ](#) [OPB817Z](#) [OPB972T51](#) [7486R10KL.25](#)  
[WMHP100-50RF](#) [W23-15RJI](#) [RC55Y-11K3BI](#) [WH50-5R6JB006](#) [WH200-R10JI](#) [W31-560RJI](#) [HR0805F-1G55I](#) [LOB3R015FLF](#) [HM41-11510LF](#)