

# Amphenol MIL-DTL-38999, Series III, TV



**New  
Featured**



**Other New 38999**

Dualok™ see page 55      HD38999 see page 46



## TABLE OF CONTENTS

### Combined MIL-DTL-38999 Series I, II, III

- Shell Size & Insert Arrangements Availability . . . . . 6-9
- Insert Arrangement Drawings . . . . . 10-17
- Specifications - Contact Ratings, Service Ratings, Finish Data . . . . . 18, 19

### MIL-DTL-38999, Series III TV

- Performance, Options . . . . . 21, 22
- Weight Comparison (Composite vs. Metal) . . . . . 23
- Test Data . . . . . 24
- How to Order (Commercial & Military) . . . . . 25-27
- How to Order (Boeing BACC63) . . . . . 28

### Shell Styles:

- Crimp Wall Mounting Receptacle TVP00R (D38999/20) /CTVP00R (D38999/20) . . . . . 29
- Crimp Box Mounting Receptacle TVP02R / CTVP02R . . . . . 30
- Crimp Straight Plug TV06R (D38999/26) / CTV06R (D38999/26) . . . . . 31
- Crimp CLUTCH-LOK™ Straight Plug for High Vibration TV26/MTV26 . . . . . 32
- Crimp Jam Nut Receptacle TV07R (D38999/24) / CTV07R (D38999/24) . . . . . 33
- Crimp Line Receptacle TV01R / CTV01R . . . . . 34
- Crimp Flange Mounting Plug TV09R . . . . . 35
- Hermetic Box Mounting Receptacle TVPS02Y (D38999/21) . . . . . 36
- Hermetic Jam Nut Receptacle TVS07Y (D38999/23) . . . . . 37
- Hermetic Solder Mounting Receptacle TVSIY (D38999/25),  
Hermetic Weld Mounting Receptacle TVSHIY (D38999/27) . . . . . 38
- Breakaway Fail-Safe Lanyard Release Plug  
D38999/29 & /30 (88-5565 / 91-5565) . . . . . 39, 40
- Breakaway Fail-Safe How to Order (Military/Commercial) . . . . . 41, 42
- Breakaway MIL-STD-1760 Lanyard Release Plug D38999/31 . . . . . 43
- Breakaway MIL-STD-1760 How to Order (Military) . . . . . 44
- Breakaway Hybrid, Low Profile Lanyard Release Plug . . . . . 45
- Stores Management Type II, Rail Launch (MIL-STD-1760) . . . . . 45



## MIL-DTL-38999 Series III Typical Markets:

- Military & Commercial Aviation
- Military Vehicles
- Missiles & Ordnance
- C4ISR
- Space Applications

**Amphenol**  
Aerospace



# MIL-DTL-38999, Series I LJT, II JT, III TV, HD

## Insert Availability and Identification Chart



| Series | Series | Series  | Military | MIL-DTL-27599<br>JT/LJT<br>Solder | Crimp | Hermetics  |            |     | Service<br>Rating | Total<br>Contacts | Contact Size |     |     |    |    |    |    |              |               |             |                 |   |
|--------|--------|---------|----------|-----------------------------------|-------|------------|------------|-----|-------------------|-------------------|--------------|-----|-----|----|----|----|----|--------------|---------------|-------------|-----------------|---|
| JT II  | LJT I  | TV III  | III      |                                   |       | Class<br>H | Class<br>Y | TV* |                   |                   | 23<br>HD     | 22D | 22M | 22 | 20 | 16 | 12 | 12<br>(Coax) | 10<br>(Power) | 8<br>(Coax) | 8††<br>(Twinax) |   |
| 14-15  |        |         |          | X                                 | X     | P          | P          |     | I                 | 15                |              |     |     |    | 14 | 1  |    |              |               |             |                 |   |
|        | 15-15  | 15-15   | D15      | X                                 | X     | P/S        | P/S        | P   | I                 | 15                |              |     |     |    | 14 | 1  |    |              |               |             |                 |   |
| 14-18  |        |         |          | X                                 | X     | P/S        | P/S        |     |                   |                   |              |     |     |    |    |    |    |              |               |             |                 |   |
|        | 15-18  | 15-18   | D18      | X                                 | X     | P/S        | P/S        | P   | I                 | 18                |              |     |     |    | 18 |    |    |              |               |             |                 |   |
| 14-19■ |        |         |          | X                                 | X     |            |            |     |                   |                   |              |     |     |    |    |    |    |              |               |             |                 |   |
|        | 15-19  | 15-19   | D19      |                                   | X     | P          | P          | P   | I                 | 19                |              |     |     |    | 19 |    |    |              |               |             |                 |   |
| 14-35  |        |         |          |                                   | X     | P          | P          |     |                   |                   |              |     |     |    |    |    |    |              |               |             |                 |   |
|        | 15-35  | 15-35   | D35      |                                   | X     | P/S        | P/S        | P   | M                 | 37                |              | 37  |     |    |    |    |    |              |               |             |                 |   |
| 14-37  |        |         |          | X                                 | X     | P          | P          |     | M                 | 37                |              |     | 37  |    |    |    |    |              |               |             |                 |   |
|        | 15-37  |         |          | X                                 | X     | P          | P          |     | M                 | 37                |              |     |     |    |    |    |    |              |               |             |                 |   |
|        |        | 15-55■  |          |                                   |       |            |            |     | N                 | 55                | 55           |     |     |    |    |    |    |              |               |             |                 |   |
| 14-68■ |        |         |          |                                   | 2     | P          | P          |     |                   |                   |              |     |     |    |    |    |    |              |               |             |                 |   |
|        | 15-68■ |         |          | X                                 | 3     |            |            |     | 1                 | 8                 |              |     |     |    |    | 8  |    |              |               |             |                 |   |
| 14-97■ |        |         |          |                                   | X     | P          | P          |     |                   |                   |              |     |     |    |    |    |    |              |               |             |                 |   |
|        | 15-97  | 15-97   | D97      | X                                 | X     | P          | P          | P   | I                 | 12                |              |     |     |    | 8  | 4  |    |              |               |             |                 |   |
|        | 17-2   | 17-2    | E2       |                                   | X     | ◆          |            |     | M                 | 39                |              | 38  |     |    |    |    |    |              |               |             |                 | 1 |
| 16-6   |        |         |          |                                   | X     | P          | P          |     |                   |                   |              |     |     |    |    |    |    |              |               |             |                 |   |
|        | 17-6   | 17-6    | E6       |                                   | X     | P          | P          | P   | I                 | 6                 |              |     |     |    |    |    | 6  |              |               |             |                 |   |
| 16-8   |        |         |          | X                                 | X     | P          | P          |     |                   |                   |              |     |     |    |    |    |    |              |               |             |                 |   |
|        | 17-8★  | 17-8★   | E8       | X                                 | X     | P/S        | P/S        | P   | II                | 8                 |              |     |     |    | 8  |    |    |              |               |             |                 |   |
| 16-13■ |        |         |          |                                   | 2     |            |            |     |                   |                   |              |     |     |    |    |    |    |              |               |             |                 |   |
|        | 17-13■ |         |          |                                   | 2     |            |            |     | I                 | 13                |              |     |     |    |    | 13 |    |              |               |             |                 |   |
|        | 17-22■ | 17-22★■ |          |                                   | ◆     |            |            |     | Coax              | 4                 |              |     |     |    |    |    | 2  |              |               | 2           |                 |   |
|        | 17-25■ |         |          |                                   | 2     |            |            |     | M                 | 24                |              | 22  |     |    |    |    |    |              |               |             |                 |   |
| 16-26  |        |         |          | X                                 | X     | P/S        | P/S        |     |                   |                   |              |     |     |    |    |    |    |              |               |             |                 |   |
|        | 17-26  | 17-26   | E26      | X                                 | X     | P/S        | P/S        | P   | I                 | 26                |              |     |     |    | 26 |    |    |              |               |             |                 |   |
| 16-35  |        |         |          |                                   | X     | P          | P          |     |                   |                   |              |     |     |    |    |    |    |              |               |             |                 |   |
|        | 17-35  | 17-35   | E35      | X                                 | X     | P          | P          | P   | M                 | 55                |              | 55  |     |    |    |    |    |              |               |             |                 |   |
| 16-42  |        |         |          |                                   | X     |            |            |     |                   |                   |              |     |     |    |    |    |    |              |               |             |                 |   |
|        | 17-42■ |         |          |                                   | P     |            |            |     | M                 | 42                |              |     |     | 42 |    |    |    |              |               |             |                 |   |
|        |        | 17-52■  |          |                                   | X     | ◆          |            |     | M                 | 2                 |              |     |     |    |    |    |    |              |               |             |                 | 2 |
| 16-55  |        |         |          | X                                 | X     | P/S        | P/S        |     |                   |                   |              |     |     |    |    |    |    |              |               |             |                 |   |
|        | 17-55  |         |          | X                                 | X     | P/S        | P/S        |     | M                 | 55                |              |     | 55  |    |    |    |    |              |               |             |                 |   |
|        |        | 17-60■  |          |                                   | X     |            |            |     | I/Coax            | 10                |              | 8   |     |    |    |    |    |              |               |             | 2               |   |
|        |        | 17-73■  |          |                                   |       |            |            |     | N                 | 73                | 73           |     |     |    |    |    |    |              |               |             |                 |   |
| 16-99  |        |         |          | X                                 | X     | P          | P          |     |                   |                   |              |     |     |    |    |    |    |              |               |             |                 |   |
|        | 17-99  | 17-99   | E99      | X                                 | X     | P          | P          |     | I                 | 23                |              |     |     |    | 21 | 2  |    |              |               |             |                 |   |
|        |        | 19-AD■  |          |                                   | X     | ◆          |            |     | Inst.             | 17                |              |     |     |    | 16 |    |    |              |               |             |                 | 1 |
| 18-11  |        |         |          | X                                 | X     | P          | P          |     |                   |                   |              |     |     |    |    |    |    |              |               |             |                 |   |
|        | 19-11★ | 19-11★  | F11      | X                                 | X     | P          | P          | P   | II                | 11                |              |     |     |    |    | 11 |    |              |               |             |                 |   |
|        | 19-18  | 19-18   | F18      |                                   | 2     | 2          |            |     | M                 | 18                |              | 14  |     |    |    |    |    |              |               |             |                 | 4 |
| 18-28  |        |         |          | X                                 | X     |            |            |     |                   |                   |              |     |     |    |    |    |    |              |               |             |                 |   |
|        | 19-28■ | 19-28   | F28      | X                                 | P     | X          |            |     | I                 | 28                |              |     |     |    | 26 | 2  |    |              |               |             |                 |   |
| 18-30  |        |         |          | X                                 | X     |            |            |     |                   |                   |              |     |     |    |    |    |    |              |               |             |                 |   |
|        | 19-30■ |         |          | X                                 | P     |            |            |     | I                 | 30                |              |     |     |    |    | 29 | 1  |              |               |             |                 |   |
|        |        | 19-31■  |          |                                   | X     |            |            |     | M                 | 15                |              | 12  |     |    |    |    | 1  |              |               |             | 2               |   |
| 18-32  |        |         |          | X                                 | X     | P/S        | P/S        |     |                   |                   |              |     |     |    |    |    |    |              |               |             |                 |   |
|        | 19-32  | 19-32   | F32      | X                                 | X     | P/S        | P/S        | P   | I                 | 32                |              |     |     |    | 32 |    |    |              |               |             |                 |   |
| 18-35  |        |         |          |                                   | X     | P          | P          |     |                   |                   |              |     |     |    |    |    |    |              |               |             |                 |   |
|        | 19-35  | 19-35   | F35      |                                   | X     | P          | P          | P   | M                 | 66                |              | 66  |     |    |    |    |    |              |               |             |                 |   |
| 18-53  |        |         |          | X                                 | X     |            |            |     |                   |                   |              |     |     |    |    |    |    |              |               |             |                 |   |
|        | 19-53■ |         |          |                                   | P     |            |            |     | M                 | 53                |              |     |     | 53 |    |    |    |              |               |             |                 |   |
| 18-66  |        |         |          | X                                 | X     | P          | P          |     |                   |                   |              |     |     |    |    |    |    |              |               |             |                 |   |
|        | 19-66  |         |          |                                   | X     | P          | P          |     | M                 | 66                |              |     | 66  |    |    |    |    |              |               |             |                 |   |
|        | 19-67■ |         |          | X                                 | 3     | S          | S          |     | M                 | 67                |              |     | 67  |    |    |    |    |              |               |             |                 |   |
| 18-68■ |        |         |          |                                   | 2     |            |            |     |                   |                   |              |     |     |    |    |    |    |              |               |             |                 |   |
|        | 19-68■ | 19-68   |          |                                   | 3     | S          |            |     | I                 | 18                |              |     |     |    |    | 18 |    |              |               |             |                 |   |
| 18-96■ |        |         |          |                                   | 2     |            |            |     |                   |                   |              |     |     |    |    |    |    |              |               |             |                 |   |
|        |        | 19-88■  |          |                                   |       |            |            |     | N                 | 88                | 88           |     |     |    |    |    |    |              |               |             |                 |   |
| 20-1   |        |         |          |                                   | X     | P          | P          |     |                   |                   |              |     |     |    |    |    |    |              |               |             |                 |   |
|        | 21-1   |         |          |                                   | X     | P/S        | P/S        |     | M                 | 79                |              |     |     | 79 |    |    |    |              |               |             |                 |   |

38999

- III
- HD
- Dualok
- II
- I
- SJT
- Accessories
- Aquacon
- Herm/Seal
- PCB

- HIGH SPEED
- Fiber Optics
- Contacts Connectors Cables

EMI Filter  
Transient

26482  
Matrix 2

83723 III  
Matrix | Pyle

26500  
Pyle

5015  
Crimp Rear Release Matrix

22992  
Class 1

Back-Shell's

Options  
Others

38999

- III
- HD
- Dualok
- II
- I
- SJT
- Accessories
- Aquacon
- Herm/Seal
- PCB

HIGH SPEED

Fiber Optics

Contacts Connectors Cables

EMI Filter Transient

26482 Matrix 2

83723 III Matrix | Pyle

26500 Pyle

5015 Crimp Rear Release Matrix

22992 Class I

Back-Shells

Options Others

| Series | Series | Series   | Military | MIL-DTL-27599<br>JT/LJT Solder | Crimp | Hermetics |     |     | Service Rating | Total Contacts | Contact Size |     |     |     |    |    |    |           |            |          |              |   |
|--------|--------|----------|----------|--------------------------------|-------|-----------|-----|-----|----------------|----------------|--------------|-----|-----|-----|----|----|----|-----------|------------|----------|--------------|---|
| JT II  | LJT I  | TV III   | III      |                                |       | H         | Y   | TV* |                |                | 23 HD        | 22D | 22M | 22  | 20 | 16 | 12 | 12 (Coax) | 10 (Power) | 8 (Coax) | 8†† (Twinax) |   |
| 20-2   |        |          |          |                                | X     |           |     | M   | 65             |                |              |     |     | 65  |    |    |    |           |            |          |              |   |
|        | 21-2■  |          |          |                                | X     |           |     |     |                |                |              |     |     |     |    |    |    |           |            |          |              |   |
| 20-11■ |        |          |          |                                | 3     |           |     | I   | 11             |                |              |     |     |     |    |    | 11 |           |            |          |              |   |
|        | 21-11★ | 21-11★   | G11      |                                | X     |           |     |     |                |                |              |     |     |     |    |    |    |           |            |          |              |   |
| 20-16  |        |          |          |                                | X     | X         | P/S | P/S |                | II             | 16           |     |     |     |    |    | 16 |           |            |          |              |   |
|        | 21-16★ | 21-16★   | G16      | X                              | X     | P         | P   | P   |                | I              | 25           |     |     |     | 25 |    |    |           |            |          |              |   |
|        | 21-25■ |          |          |                                |       |           |     |     |                | I              | 27           |     |     |     | 27 |    |    |           |            |          |              |   |
|        | 21-27■ |          |          | X                              |       |           |     |     |                | I              | 27           |     |     |     | 19 | 4  | 4  |           |            |          |              |   |
|        |        | 21-29■   |          |                                | X     |           |     |     |                | I              | 27           |     |     |     |    |    |    |           |            |          |              |   |
| 20-35  |        |          |          |                                | X     | P         | P   |     | M              | 79             |              | 79  |     |     |    |    |    |           |            |          |              |   |
|        | 21-35  | 21-35    | G35      |                                | X     | P/S       | P/S | P   |                | I              | 39           |     |     |     | 37 | 2  |    |           |            |          |              |   |
| 20-39  |        |          |          | X                              | X     | P         | P   | P   |                | I              | 39           |     |     |     |    |    |    |           |            |          |              |   |
|        | 21-39  | 21-39    | G39      | X                              | X     | P         | P   | P   |                | I              | 41           |     |     |     |    |    |    |           |            |          |              |   |
| 20-41  |        |          |          | X                              | X     | P         | P   | P   |                | I              | 41           |     |     |     | 41 |    |    |           |            |          |              |   |
|        | 21-41  | 21-41    | G41      | X                              | X     | P/S       | P/S | P   |                | I              | 41           |     |     |     |    |    |    |           |            |          |              |   |
|        | 21-75★ | 21-75★◇  | G75      |                                | 2     | X         |     |     | N              | M              | 4            |     |     |     |    |    |    |           |            | 4        | (4)          |   |
|        | 21-79■ | 21-79■   |          |                                | 2     | X         |     |     | II             |                | 19           |     | 17  |     |    |    |    |           |            | 2        | (5)          |   |
|        |        | 21-121■  |          |                                |       |           |     |     | N              |                | 121          | 121 |     |     |    |    |    |           |            |          |              |   |
| 22-1   |        |          |          |                                | X     | P/S       | P/S |     | M              | 100            |              |     | 100 |     |    |    |    |           |            |          |              |   |
|        | 23-1   |          |          |                                | X     | P         | P   |     | M              | 100            |              |     |     |     |    |    |    |           |            |          |              |   |
| 22-2   |        |          |          | X                              | X     | P         | P   |     | M              | 85             |              |     |     | 85  |    |    |    |           |            |          |              |   |
|        | 23-2   |          |          | X                              | X     | P         | P   |     | M              | 85             |              |     |     |     |    |    |    |           |            |          |              |   |
|        | 23-6★■ | 23-6★■   |          |                                | P     |           |     |     | M              | 6              |              |     |     |     |    |    |    |           |            |          |              | 6 |
| 22-14■ |        |          |          |                                | 2     | ◇         |     |     | I              | 14             |              |     |     |     |    |    | 14 |           |            |          |              |   |
|        | 23-14■ | 23-14■   |          |                                | 2     | ◇         |     |     | I              | 14             |              |     |     |     |    |    |    |           |            |          |              |   |
| 22-21  |        |          |          | X                              | X     | P         | P   |     | II             | 21             |              |     |     |     |    | 21 |    |           |            |          |              |   |
|        | 23-21★ | 23-21★   | H21      | X                              | X     | P         | P   | P   |                | I              | 32           |     |     |     | 32 |    |    |           |            |          |              |   |
| 22-32  |        |          |          | X                              | X     | P         | P   |     | I              | 32             |              |     |     |     |    |    |    |           |            |          |              |   |
|        | 23-32■ |          |          | X                              | P     |           |     |     | I              | 34             |              |     |     |     | 34 |    |    |           |            |          |              |   |
|        | 23-34■ |          |          | X                              |       |           |     |     | I              | 34             |              |     |     |     |    |    |    |           |            |          |              |   |
| 22-35  |        |          |          |                                | X     | P/S       | P/S |     | M              | 100            |              | 100 |     |     |    |    |    |           |            |          |              |   |
|        | 23-35  | 23-35    | H35      |                                | X     | P         | P   | P   | M              | 100            |              | 100 |     |     |    |    |    |           |            |          |              |   |
| 22-53■ |        |          |          |                                | P     |           |     |     | I              | 53             |              |     |     |     | 53 |    |    |           |            |          |              |   |
|        | 23-53  | 23-53    | H53      | X                              | X     | P/S       | P/S | P   | I              | 53             |              |     |     |     |    |    |    |           |            |          |              |   |
|        |        | 23-54■   |          |                                | X     |           |     |     | M              | 53             |              | 40  |     |     | 9  | 4  |    |           |            |          |              |   |
| 22-55  |        |          |          | X                              | X     | P         | P   |     | I              | 55             |              |     |     |     | 55 |    |    |           |            |          |              |   |
|        | 23-55  | 23-55    | H55      |                                | X     |           |     | P   | I              | 55             |              |     |     |     |    |    |    |           |            |          |              |   |
|        | 23-97■ |          |          | X                              |       |           |     |     | II             | 16             |              |     |     |     |    | 16 |    |           |            |          |              |   |
|        | 23-99■ |          |          | X                              |       |           |     |     | II             | 11             |              |     |     |     |    | 11 |    |           |            |          |              |   |
|        |        | 23-151■  |          |                                |       |           |     |     | N              | 151            | 151          |     |     |     |    |    |    |           |            |          |              |   |
| 24-1   |        |          |          |                                | X     | P         | P   |     | M              | 128            |              |     | 128 |     |    |    |    |           |            |          |              |   |
|        | 25-1   |          |          |                                | X     | P         | P   |     | M              | 128            |              |     | 128 |     |    |    |    |           |            |          |              |   |
| 24-2   |        |          |          |                                | X     |           |     |     | M              | 100            |              |     |     | 100 |    |    |    |           |            |          |              |   |
|        | 25-2   |          |          |                                | X     |           |     |     | M              | 100            |              |     |     |     |    |    |    |           |            |          |              |   |
| 24-4   |        |          |          |                                | X     | P         | P   |     | I              | 56             |              |     |     |     | 48 | 8  |    |           |            |          |              |   |
|        | 25-4   | 25-4     | J4       |                                | X     |           |     | P   | I              | 56             |              |     |     |     |    |    |    |           |            |          |              |   |
|        | 25-7■  | 25-7     | J7       |                                | X     |           |     |     | M              | Twinax         | 99           |     | 97  |     |    |    |    |           |            |          | 2            |   |
|        |        | 25-8★    | J8       |                                | ◇     |           |     |     | Twinax         | 8              |              |     |     |     |    |    |    |           |            |          |              | 8 |
|        |        | 25-11*** | J11      |                                | 2     | ◇         |     |     | N              | 11             |              |     |     |     | 2  |    |    |           |            | 9        |              |   |
|        |        | 25-17■   |          |                                | ◇     |           |     |     | M              | 42             |              | 36  |     |     |    |    |    |           |            |          |              | 6 |
| 24-19■ |        |          |          |                                | X     | P         | P   |     | I              | 19             |              |     |     |     |    |    | 19 |           |            |          |              |   |
|        | 25-19★ | 25-19★   | J19      |                                | X     |           |     | P   | I              | 19             |              |     |     |     |    |    |    |           |            |          |              |   |
|        | 25-20■ | 25-20*** | J20      |                                | 2     | ◇         |     |     | N              | 30             |              |     |     |     | 10 | 13 | 4  |           |            |          |              | 3 |

- X Completely tooled.
- Majority of tooling is completed (contact Amphenol Aerospace for availability).
- ◇ Not tooled for 02-R.
- P Available with Pin contacts only
- S Available with Socket contacts only
- P/S Available with Pin contacts or Socket contacts
- ★ Ground plane proprietary option available. Arrg. 9-5, 26-62 is exclusively ground plane type.
- Not Mil-Qualified.
- ◇ 21-75 is Mil-Qualified with twinax contacts only.
- \* Hermetic inserts - solder termination standard. (Contact Amphenol Aerospace for optional PCB or eyelet termination).
- HD designates High Density 38999 Series III insert patterns which use size 23 contacts only. Not rated over 175°C.
- \*\* Two size 16 contacts dedicated to fiber optics. See the Fiber Optic Section for more information.
- \*\*\* For use in MIL-STD-1760 applications (see pages 43 & 44).
- † For RG 180/U and RG 195/U cables only.
- †† Size 8 Coax and Twinax are interchangeable.
- (2) Not Tooled for RP or 02RE
- (3) Pin inserts only, not tooled for RP or 02RE (Consult Amphenol for avail.)
- (4) MS connector 21-75 is supplied with size 8 twinax. Commercial connector 21-75 is supplied with size 8 coax.
- (5) MS Connector 21-79 has provision for two size 8 coax contacts. Coax contacts are not supplied unless specified by customer.

# MIL-DTL-38999, Series I LJT, II JT, III TV, HD

## Insert Availability and Identification Chart

| Series | Series | Series  | Military | MIL-DTL-27599 | Hermetics |   |   |     | Contact Size   |                |       |     |     |    |    |    |    |           |            |          |              |           |
|--------|--------|---------|----------|---------------|-----------|---|---|-----|----------------|----------------|-------|-----|-----|----|----|----|----|-----------|------------|----------|--------------|-----------|
| JT II  | LJT I  | TV III  | III      | JT/LJT Solder | Crimp     | H | Y | TV* | Service Rating | Total Contacts | 23 HD | 22D | 22M | 22 | 20 | 16 | 12 | 12 (Coax) | 10 (Power) | 8 (Coax) | 8†† (Twinax) | 8 Quadrax |
| 24-24  |        |         |          |               | X         | P | P |     | I              | 24             |       |     |     |    |    | 12 | 12 |           |            |          |              |           |
|        | 25-24★ | 25-24★  | J24      |               | X         | P | P |     | I              | 25             |       |     |     |    | 16 | 5  |    |           |            | 4        |              |           |
|        |        | 25-26■★ |          |               | ◆         |   |   |     | I              | 29             |       |     |     |    |    |    |    |           |            |          |              |           |
| 24-29  |        |         |          |               | X         |   |   |     | I              | 29             |       |     |     |    |    |    |    |           |            |          |              |           |
|        | 25-29★ | 25-29★  | J29      | X             | X         |   |   |     | I              | 29             |       |     |     |    |    |    |    |           |            |          |              |           |
| 24-35  |        |         |          |               | X         | P | P |     | New            |                |       |     |     |    |    |    |    |           |            |          |              |           |
|        | 25-35  | 25-35   | J35      |               | X         | P | P | P   | M              | 128            |       | 128 |     |    |    |    |    |           |            |          |              |           |
| 24-37  |        |         |          |               | X         |   |   |     | I              | 37             |       |     |     |    |    |    |    |           |            |          |              |           |
|        | 25-37★ | 25-37★  | J37      |               | X         |   |   |     | I              | 37             |       |     |     |    |    |    |    |           |            |          |              |           |
| 24-43■ |        |         |          |               | 3         |   |   |     | I              | 43             |       |     |     |    |    |    |    |           |            |          |              |           |
|        | 25-43  | 25-43   | J43      | X             | 2         | ◆ |   |     | I              | 43             |       |     |     |    |    | 23 | 20 |           |            |          |              |           |
|        | 25-46  | 25-46   | J46      |               | 2         | ◆ |   |     | I              | 46             |       |     |     |    |    | 40 | 4  |           |            | 2        |              |           |
| 24-61  |        |         |          |               | X         |   | P | P   | I              | 61             |       |     |     |    |    | 61 |    |           |            |          |              |           |
|        | 25-61  | 25-61   | J61      | X             | X         | P | P | P   | I              | 61             |       |     |     |    |    |    |    |           |            |          |              |           |
|        |        | 25-62■★ |          |               | X         | ◆ |   |     | I              | 12             |       |     |     |    |    |    | 8  |           |            |          |              | 4         |
|        |        | 25-90   |          |               | ◆         |   |   |     | I              | 46             |       |     |     |    |    | 40 | 4  |           |            |          | 2            |           |
|        |        | 25-187■ |          |               |           |   |   |     | N              | 187            | 187   |     |     |    |    |    |    |           |            |          |              |           |
|        |        | 25-F4■  |          |               | X         |   |   |     | M/I            | 66             |       | 49  |     |    |    | 13 | 4  |           |            |          |              |           |

- HD designates High Density 38999 Series III insert patterns which use size 23 contacts only. Not rated over 175°C
- X Completely tooled.
- ◆ Not tooled for 02-R.
- P Pin inserts only (contact Amphenol Aerospace for socket availability).
- ★ Ground plane proprietary option available. Arrg. 9-5, 25-62 is exclusively ground plane type.
- Not Mil-Qualified.

## TV Series III

### Select Shell Size - Special Insert Arrangement

(Not Mil-Spec Qualified)

| Shell Size-Insert Arrg. | Crimp | Hermetics* | Service Rating | Total Contacts | Comments         | Contact Size |    |    |    |
|-------------------------|-------|------------|----------------|----------------|------------------|--------------|----|----|----|
|                         |       |            |                |                |                  | 22D          | 20 | 16 | 12 |
| 9-2                     | X     |            | I              | 2              | Formerly Pyle    |              | 2  |    |    |
| 15-4                    | X     |            | II             | 4              | Formerly Pyle    |              |    | 4  |    |
| 15-25                   | X     |            | M              | 25             | Formerly Pyle    | 22           |    | 3  |    |
| 17-20                   | X     |            | M              | 20             | Formerly Pyle    |              | 16 | 4  |    |
| 21-12                   | X     |            | I              | 12             | Formerly Pyle    |              | 3  |    | 9  |
| 21-21                   | X     |            | M/Inst.        | 41             | Improved sealing | 32           |    |    | 9  |
| 21-99                   | X     |            | M              | 16             | Formerly Pyle    | 5            |    |    | 11 |
| 25-92                   | X     |            | M              | 101            | Formerly Pyle    | 92           |    | 9  |    |
| 25-97                   | X     |            | M              | 42             | Formerly Pyle    | 26           |    | 3  | 13 |

## Select Non-Standard Shell Size

### - Special Insert Arrangement

| Shell Size-Insert Arrg. | Crimp | Hermetics* | Service Rating | Total Contacts | Contact Size |    |   |   |   |
|-------------------------|-------|------------|----------------|----------------|--------------|----|---|---|---|
|                         |       |            |                |                | 22D          | 20 | 8 | 4 | 0 |
| 25-16                   | X     |            | M              | 8              |              | 6  |   | 2 |   |
| 25L-3                   | X     |            | II             | 3              |              |    | 1 | 2 |   |
| 25L-7                   | X     |            | II             | 7              |              |    | 7 |   |   |
| 33-3                    | X     |            | II             | 3              |              |    |   | 1 | 2 |
| 33-5                    | X     |            | II             | 5              |              |    |   | 5 |   |
| 33-6                    | X     |            | II             | 6              |              |    | 2 | 4 |   |
| 37-5                    | X     |            | II             | 4              |              |    |   |   | 4 |

(Insert arrangements requiring non-standard shells or larger contacts)

- X Completely tooled.
- Majority of tooling is completed (contact Amphenol Aerospace for availability).
- ◆ Not tooled for 02-R.
- P Pin inserts only (contact Amphenol Aerospace for socket availability).
- ★ Ground plane proprietary option available. Arrangement 9-5, 25-62 is exclusively ground plane type.
- Not Mil-Qualified.
- \* Hermetic inserts - solder termination standard. (Contact Amphenol Aerospace for optional PCB or eyelet termination).
- \*\* Two size 16 contacts dedicated to fiber optics. See the Fiber Optic section for more information.
- \*\*\* For use in MIL-STD-1760 applications (pgs. 43 & 44).
- † For RG 180/U and RG 195/U cables only.
- †† Size 8 Coax and Twinax are interchangeable. Note: 25L-3 and 25L-7 require longer shells.

38999

- III
- HD
- Dualok
- II
- I
- SJT
- Accessories
- Aquacon
- Herm/Seal
- PCB

HIGH SPEED

Fiber Optics

Contacts  
Connectors  
Cables

EMI Filter  
Transient

26482  
Matrix 2

83723 III  
Matrix | Pyle

26500  
Pyle

5015  
Crimp Rear  
Release  
Matrix

22992  
Class 1

Back-  
Shells

Options  
Others



Front face of pin inserts illustrated

### 38999

- III
- HD
- Dualok
- II
- I
- SJT
- Accessories
- Aquacon
- Herm/Seal
- PCB

Shell Size & Insert Arrg. for:



|                      |      |      |      |    |     |          |      |        |      |      |      |      |      |      |    |
|----------------------|------|------|------|----|-----|----------|------|--------|------|------|------|------|------|------|----|
| <b>Series II JT</b>  | 8-2  |      | 8-3  |    | 8-6 |          |      | 8-35   |      | 8-44 |      | 8-97 |      | 8-98 |    |
| <b>Series I LJT</b>  | 9-3  |      | 9-6  |    | 9-7 |          | 9-22 |        | 9-35 |      | 9-44 |      | 9-98 |      |    |
| <b>Series III TV</b> | 7-D2 | 7-D3 | 7-D4 |    | 9-5 |          |      | 9-9 HD |      | 9-35 |      | 9-94 |      | 9-98 |    |
| Service Rating       | M    | M    | M    | M  | M   | Grounded | M    | M      | N    | I    | M    | M    | M    | M    | I  |
| Number of Contacts   | 2    | 3    | 4    | 2  | 3   | 1        | 6    | 7      | 9    | 2    | 6    | 4    | 2    | 2    | 3  |
| Contact Size         | 22D  | 22D  | 22D  | 20 | 20  | 8 Twinax | 22M  | 22M    | 23   | 20   | 22D  | 22   | 20   | 22M  | 20 |

- HIGH SPEED
- Fiber Optics
- Contacts
- Connectors
- Cables

Shell Size & Insert Arrg. for:

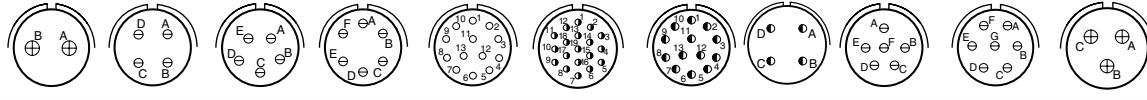

|                      |      |    |      |    |       |    |          |       |       |       |       |       |       |       |       |  |
|----------------------|------|----|------|----|-------|----|----------|-------|-------|-------|-------|-------|-------|-------|-------|--|
| <b>Series II JT</b>  | 10-4 |    | 10-5 |    | 10-13 |    |          | 10-35 |       | 10-98 |       | 10-99 |       | 12-3  |       |  |
| <b>Series I LJT</b>  | 11-2 |    | 11-4 |    | 11-5  |    | 11-6     |       | 11-13 |       | 11-35 |       | 11-98 |       | 11-99 |  |
| <b>Series III TV</b> | 11-2 |    | 11-4 |    | 11-5  |    | 11-19 HD |       |       | 11-35 |       | 11-54 |       | 11-98 |       |  |
| Service Rating       | I    | I  | I    | I  | I     | M  | N        | M     | II    | I     | I     | I     | I     | II    |       |  |
| Number of Contacts   | 2    | 4  | 5    | 6  | 13    | 19 | 13       | 4     | 6     | 7     | 3     | 16    |       |       |       |  |
| Contact Size         | 16   | 20 | 20   | 20 | 22M   | 23 | 22D      | 22D   | 20    | 20    | 16    |       |       |       |       |  |

- EMI Filter
- Transient

Shell Size & Insert Arrg. for:

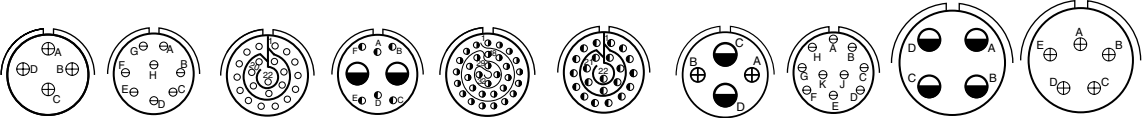

|                      |      |    |      |     |       |    |       |          |       |       |      |       |      |       |  |
|----------------------|------|----|------|-----|-------|----|-------|----------|-------|-------|------|-------|------|-------|--|
| <b>Series II JT</b>  | 12-4 |    | 12-8 |     | 12-22 |    |       | 12-35    |       | 12-98 |      | 14-4  |      | 14-5  |  |
| <b>Series I LJT</b>  | 13-4 |    | 13-8 |     | 13-22 |    | 13-35 |          | 13-98 |       | 15-4 |       | 15-5 |       |  |
| <b>Series III TV</b> | 13-4 |    | 13-8 |     | 13-26 |    |       | 13-32 HD |       | 13-35 |      | 13-63 |      | 13-98 |  |
| Service Rating       | I    | I  | M    | M   | N     | M  | I     | I        | I     | II    |      |       |      |       |  |
| Number of Contacts   | 4    | 8  | 22   | 6   | 2     | 32 | 22    | 2        | 2     | 10    | 4    | 5     |      |       |  |
| Contact Size         | 16   | 20 | 22M  | 22D | 12    | 23 | 22D   | 16       | 12    | 20    | 12   | 16    |      |       |  |

- 26482
- Matrix 2

Shell Size & Insert Arrg. for:

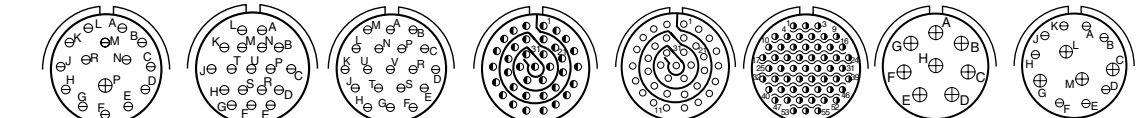

|                      |       |    |       |    |       |     |       |       |          |       |       |       |       |       |  |
|----------------------|-------|----|-------|----|-------|-----|-------|-------|----------|-------|-------|-------|-------|-------|--|
| <b>Series II JT</b>  | 14-15 |    | 14-18 |    | 14-19 |     |       | 14-35 |          | 14-37 |       | 14-68 |       | 14-97 |  |
| <b>Series I LJT</b>  | 15-15 |    | 15-18 |    | 15-19 |     | 15-35 |       | 15-37    |       | 15-68 |       | 15-97 |       |  |
| <b>Series III TV</b> | 15-15 |    | 15-18 |    | 15-19 |     | 15-35 |       | 15-55 HD |       |       | 15-97 |       |       |  |
| Service Rating       | I     |    | I     | I  | M     | M   | N     | I     | I        | I     |       |       |       |       |  |
| Number of Contacts   | 14    | 1  | 18    | 19 | 37    | 37  | 55    | 8     | 8        | 4     |       |       |       |       |  |
| Contact Size         | 20    | 16 | 20    | 20 | 22D   | 22M | 23    | 16    | 20       | 16    |       |       |       |       |  |

- 5015
- Crimp Rear Release
- Matrix

Shell Size & Insert Arrg. for:

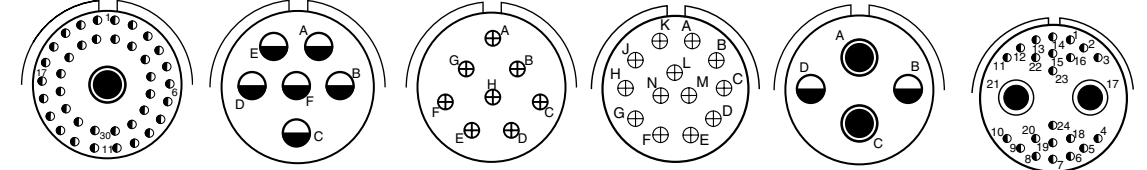

|                      |      |          |      |    |      |         |        |     |        |  |       |  |
|----------------------|------|----------|------|----|------|---------|--------|-----|--------|--|-------|--|
| <b>Series II JT</b>  | 16-6 |          | 16-8 |    |      | 16-13   |        |     |        |  |       |  |
| <b>Series I LJT</b>  | 17-2 |          | 17-6 |    | 17-8 |         | 17-13  |     | 17-22  |  | 17-25 |  |
| <b>Series III TV</b> | 17-2 |          | 17-6 |    | 17-8 |         | 17-22  |     |        |  |       |  |
| Service Rating       | M    |          | I    | II | I    | Coax    |        | M   |        |  |       |  |
| Number of Contacts   | 38   | 1        | 6    | 8  | 13   | 2       | 2      | 22  | 2      |  |       |  |
| Contact Size         | 22D  | 8 Twinax | 12   | 16 | 16   | 12 Coax | 8 Coax | 22D | 8 Coax |  |       |  |

- 22992
- Class I

- Back-Shells
- Options
- Others



HD: High Density HD38999 (use size 23 contacts only)

CONTACT LEGEND 8 10 12 16 20 22 22M 22D 23

# MIL-DTL-38999, Series I LJT, II JT, III TV, HD Insert Arrangements

Front face of pin inserts illustrated

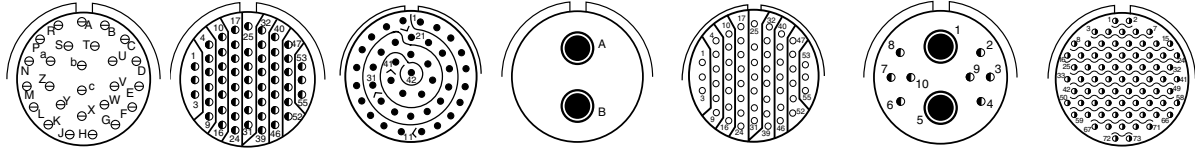

Shell Size & Insert Arrg. for:

|                    |       |       |       |          |       |               |
|--------------------|-------|-------|-------|----------|-------|---------------|
| Series I LJT       | 16-26 | 16-35 | 16-42 | 16-55    |       |               |
| Series II JT       | 17-26 | 17-35 | 17-42 | 17-55    |       |               |
| Series III TV      | 17-26 | 17-35 |       | 17-52    | 17-60 | 17-73 HD      |
| Service Rating     | I     | M     | M     | M        | M     | I/Coax N      |
| Number of Contacts | 26    | 55    | 42    | 2        | 55    | 8 2 73        |
| Contact Size       | 20    | 22D   | 22    | 8 Twinax | 22M   | 22D 8 Coax 23 |

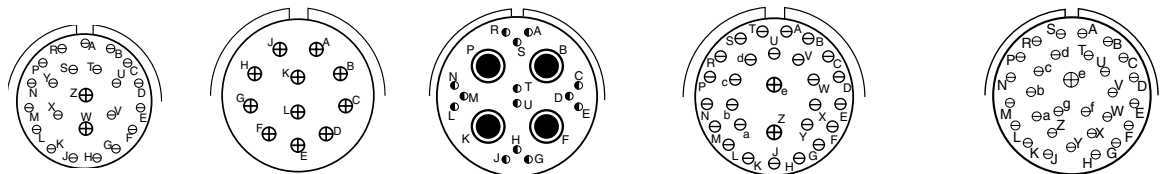

Shell Size & Insert Arrg. for:

|                    |       |       |              |       |       |
|--------------------|-------|-------|--------------|-------|-------|
| Series II JT       | 16-99 | 18-11 |              | 18-28 | 18-30 |
| Series I LJT       | 17-99 | 19-11 | 19-18        | 19-28 | 19-30 |
| Series III TV      | 17-99 | 19-11 | 19-18        | 18-28 |       |
| Service Rating     | I     | II    | M            | M     | I     |
| Number of Contacts | 21 2  | 11    | 14 4         | 26 2  | 29 1  |
| Contact Size       | 20 16 | 16    | 22D 8 Twinax | 20 16 | 20 16 |

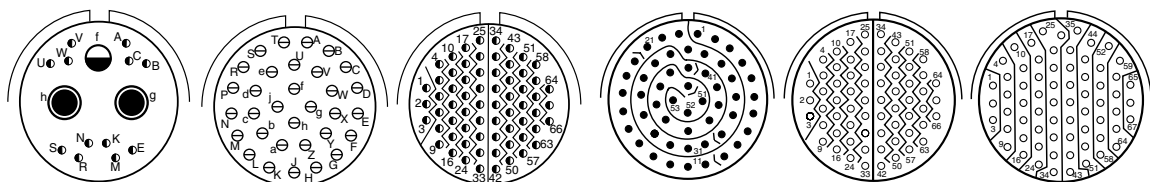

Shell Size & Insert Arrg. for:

|                    |               |       |       |       |       |       |
|--------------------|---------------|-------|-------|-------|-------|-------|
| Series II JT       |               | 18-32 | 18-35 | 18-53 | 18-66 |       |
| Series I LJT       |               | 19-32 | 19-35 | 19-53 | 19-66 | 19-67 |
| Series III TV      | 19-31         | 19-32 | 19-35 |       |       |       |
| Service Rating     | M             | 1     | M     | M     | M     | M     |
| Number of Contacts | 2 1 12        | 32    | 66    | 53    | 66    | 67    |
| Contact Size       | 8 Coax 12 22D | 20    | 22D   | 22    | 22M   | 22M   |

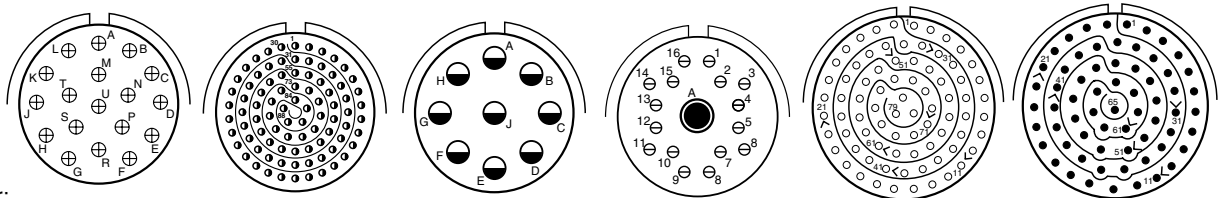

Shell Size & Insert Arrg. for:

|                    |       |          |       |             |      |      |
|--------------------|-------|----------|-------|-------------|------|------|
| Series II JT       | 18-68 |          | 18-96 |             | 20-1 | 20-2 |
| Series I LJT       | 19-68 |          |       |             | 21-1 | 21-2 |
| Series III TV      |       | 19-88 HD |       | 19-AD       |      |      |
| Service Rating     | I     | N        | I     | Inst.       | M    | II   |
| Number of Contacts | 18    | 88       | 9     | 16 1        | 79   | 65   |
| Contact Size       | 16    | 23       | 12    | 20 8 Twinax | 22M  | 22   |

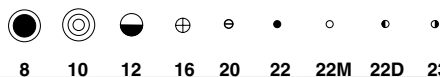

HD: High Density HD38999 (use size 23 contacts only)

38999

- III
- HD
- Dualco
- II
- I
- SJT
- Accessories
- Aquacon
- Herm/Seal
- PCB

- HIGH SPEED
- Fiber Optics
- Contacts
- Connectors
- Cables

- EMI Filter
- Transient

- 26482
- Matrix 2

- 83723 III
- Matrix | Pyle

- 26500
- Pyle

- 5015
- Crimp Rear Release Matrix

- 22992
- Class 1

- Back-Shells

- Options
- Others

38999

Front face of pin inserts illustrated

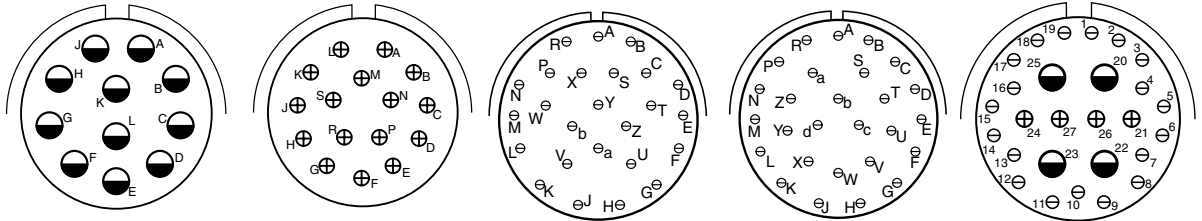

Shell Size & Insert Arrg. for:

| Series II JT       | 20-11 | 20-16 | 20-25 | 20-27 | 20-19 | 20-4 | 20-4 |
|--------------------|-------|-------|-------|-------|-------|------|------|
| Series I LJT       | 21-11 | 21-16 | 21-25 | 21-27 | 21-19 | 21-4 | 21-4 |
| Series III TV      | 21-11 | 21-16 |       |       |       |      |      |
| Service Rating     | I     | II    | I     | I     | I     | I    | I    |
| Number of Contacts | 11    | 16    | 25    | 27    | 19    | 4    | 4    |
| Contact Size       | 12    | 16    | 20    | 20    | 20    | 16   | 12   |

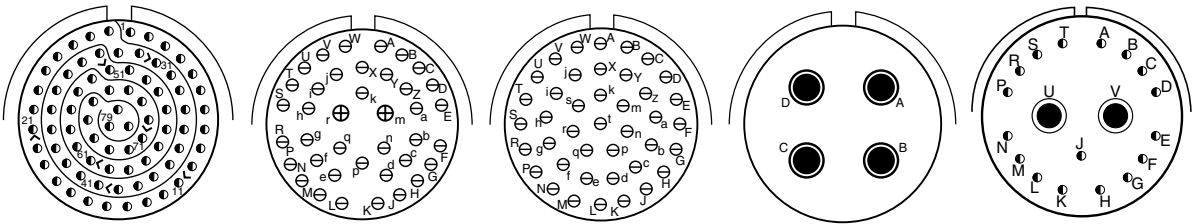

Shell Size & Insert Arrg. for:

| Series II JT       | 20-35 | 20-39 | 20-41 | 20-75      | 20-79         |
|--------------------|-------|-------|-------|------------|---------------|
| Series I LJT       | 21-35 | 21-39 | 21-41 | 21-75      | 21-79         |
| Series III TV      | 21-35 | 21-39 | 21-41 | 21-75      | 21-79         |
| Service Rating     | M     | I     | I     | N          | II            |
| Number of Contacts | 79    | 37 2  | 41    | 4          | 17 (See Note) |
| Contact Size       | 22D   | 20 16 | 20    | (See Note) | 22D           |

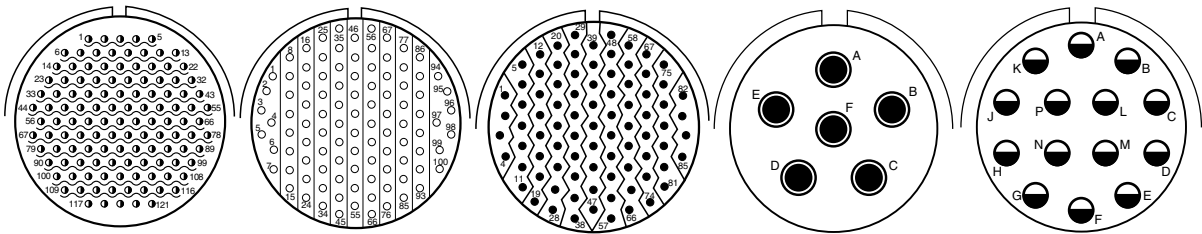

Shell Size & Insert Arrg. for:

| Series II JT       | 22-1      | 22-2 | 22-14    |
|--------------------|-----------|------|----------|
| Series I LJT       | 23-1      | 23-2 | 23-14    |
| Series III TV      | 21-121 HD |      | 23-6     |
| Service Rating     | N         | M    | M        |
| Number of Contacts | 121       | 100  | 6        |
| Contact Size       | 23        | 22M  | 8 Twinax |

**HD: High Density HD38999 (use size 23 contacts only)**

**Note:** MS connector 21-75 is supplied with four size 8 twinax contacts. Commercial connector 21-75 is supplied with four size 8 coax contacts. MS connector 21-79 has provision for two size 8 coax contacts. Coax contacts are not supplied unless specified by customers.

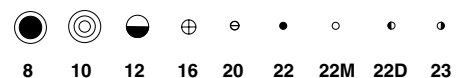

CONTACT LEGEND



Front face of pin inserts illustrated

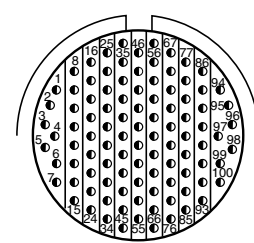
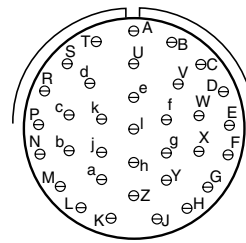
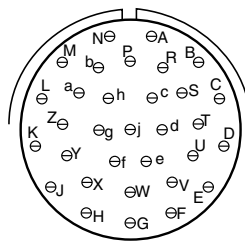

Shell Size & Insert Arrg. for:

|                      |              |              |              |
|----------------------|--------------|--------------|--------------|
| <b>Series II JT</b>  | <b>22-21</b> | <b>22-32</b> | <b>22-35</b> |
| <b>Series I LJT</b>  | <b>23-21</b> | <b>23-32</b> | <b>23-35</b> |
| <b>Series III TV</b> | <b>23-21</b> |              | <b>23-35</b> |
| Service Rating       | <b>II</b>    | <b>I</b>     | <b>M</b>     |
| Number of Contacts   | <b>21</b>    | <b>32</b>    | <b>100</b>   |
| Contact Size         | <b>16</b>    | <b>20</b>    | <b>22D</b>   |

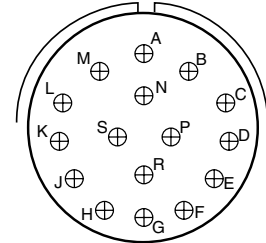
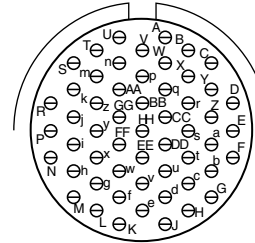
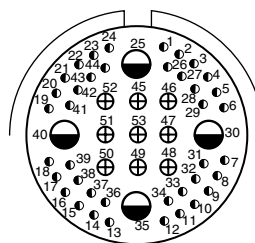

Shell Size & Insert Arrg. for:

|                      |              |                  |              |
|----------------------|--------------|------------------|--------------|
| <b>Series II JT</b>  | <b>22-53</b> | <b>22-55</b>     |              |
| <b>Series I LJT</b>  | <b>23-53</b> | <b>23-55</b>     | <b>23-97</b> |
| <b>Series III TV</b> | <b>23-53</b> | <b>23-54</b>     | <b>23-55</b> |
| Service Rating       | <b>I</b>     | <b>M</b>         | <b>II</b>    |
| Number of Contacts   | <b>53</b>    | <b>40 9 4</b>    | <b>16</b>    |
| Contact Size         | <b>20</b>    | <b>22D 16 12</b> | <b>16</b>    |

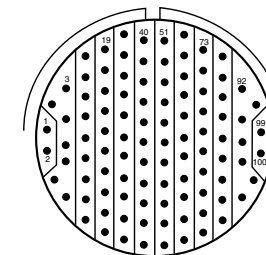
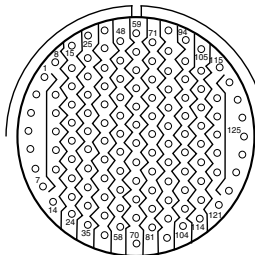
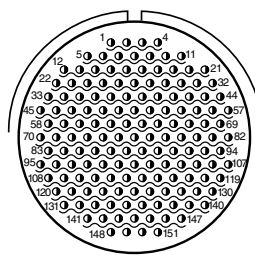
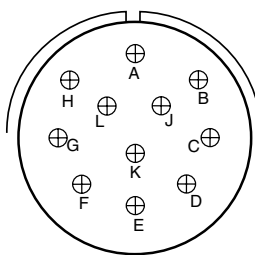

Shell Size & Insert Arrg. for:

|                      |              |                  |             |
|----------------------|--------------|------------------|-------------|
| <b>Series II JT</b>  |              | <b>24-1</b>      | <b>24-2</b> |
| <b>Series I LJT</b>  | <b>23-99</b> | <b>25-1</b>      | <b>25-2</b> |
| <b>Series III TV</b> |              | <b>23-151 HD</b> |             |
| Service Rating       | <b>II</b>    | <b>N</b>         | <b>M</b>    |
| Number of Contacts   | <b>11</b>    | <b>151</b>       | <b>100</b>  |
| Contact Size         | <b>16</b>    | <b>23</b>        | <b>22</b>   |

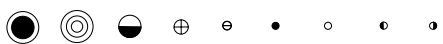

CONTACT LEGEND 8 10 12 16 20 22 22M 22D 23

HD: High Density HD38999 (use size 23 contacts only)

**38999**

- III
- HD
- Dualok
- II
- I
- SJT
- Accessories
- Aquacon
- Herm/Seal
- PCB

- HIGH SPEED
- Fiber Optics
- Contacts Connectors Cables

EMI Filter Transient

26482 Matrix 2

83723 III Matrix | Pyle

26500 Pyle

5015 Crimp Rear Release Matrix

22992 Class I

Back-Shells

Options Others

Front face of pin inserts illustrated

38999

- III
- HD
- Dualok
- II
- I
- SJT
- Accessories
- Aquacon
- Herm/Seal
- PCB

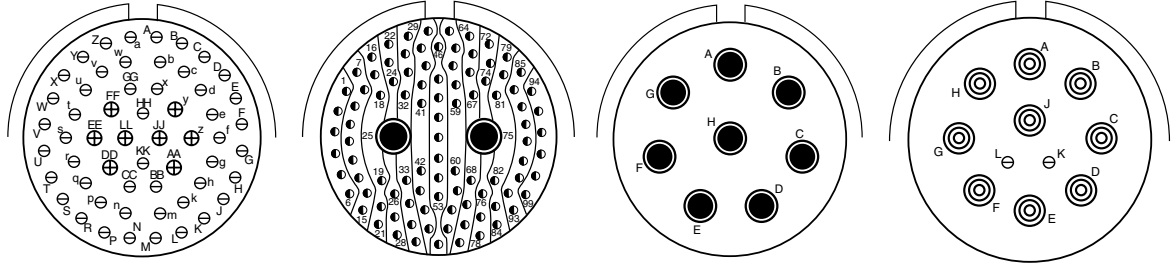

Shell Size & Insert Arrg. for:

| Series             | 24-4  | 25-7         | 25-8     | 25-11*** |
|--------------------|-------|--------------|----------|----------|
| Series II JT       | 24-4  |              |          |          |
| Series I LJT       | 25-4  | 25-7         |          | 25-11    |
| Series III TV      | 25-4  | 25-7         | 25-8     | 25-11*** |
| Service Rating     | I     | M            | Twinax   | N        |
| Number of Contacts | 48 8  | 97 2         | 8        | 2 9      |
| Contact Size       | 20 16 | 22D 8 Twinax | 8 Twinax | 20 10    |

- HIGH SPEED
- Fiber Optics
- Contacts Connectors Cables

- EMI Filter Transient

- 26482 Matrix 2

- 83723 III Matrix | Pyle

- 26500 Pyle

- 5015 Crimp Rear Release Matrix

- 22992 Class I

- Back-Shells

- Options Others

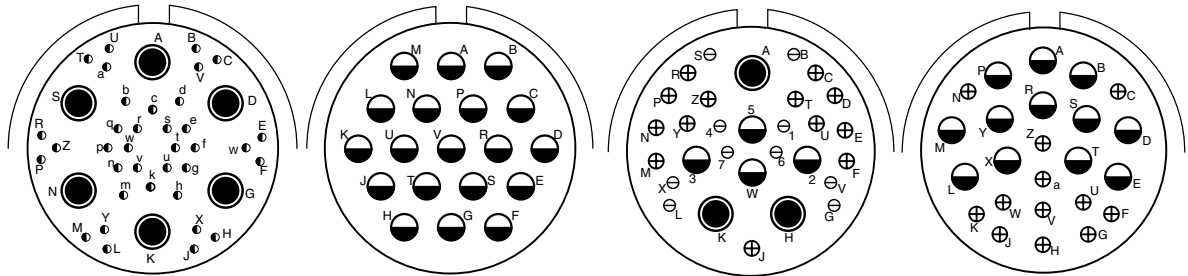

Shell Size & Insert Arrg. for:

| Series             | 24-19        | 25-19 | 25-20                  | 25-24 |
|--------------------|--------------|-------|------------------------|-------|
| Series II JT       | 24-19        |       |                        |       |
| Series I LJT       | 25-19        | 25-19 | 25-20                  | 25-24 |
| Series III TV      | 25-17        | 25-19 | 25-20***               | 25-24 |
| Service Rating     | M            | I     | N                      | I     |
| Number of Contacts | 36 6         | 19    | 10 13 3 4              | 12 12 |
| Contact Size       | 22D 8 Twinax | 12    | 20 16 8 Twinax 12 Coax | 16 12 |

(With Matched Impedance)

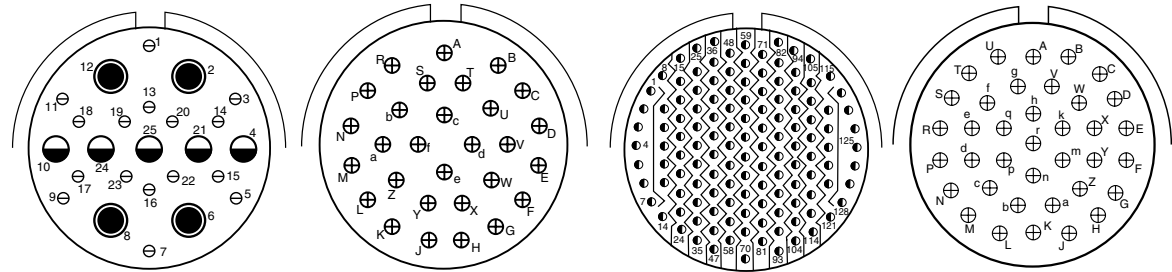

Shell Size & Insert Arrg. for:

| Series             | 24-29        | 25-29 | 25-35 | 25-37 |
|--------------------|--------------|-------|-------|-------|
| Series II JT       | 24-29        |       |       |       |
| Series I LJT       | 25-29        | 25-29 | 25-35 | 25-37 |
| Series III TV      | 25-26        | 25-29 | 25-35 | 25-37 |
| Service Rating     | I            | I     | M     | I     |
| Number of Contacts | 16 5 4       | 29    | 128   | 37    |
| Contact Size       | 20 12 8 Coax | 16    | 22D   | 16    |

\*\*\* For use in MIL-STD-1760 applications (see pages 43 and 44).

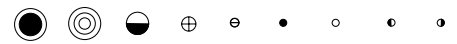

CONTACT LEGEND 8 10 12 16 20 22 22M 22D 23

Front face of pin inserts illustrated

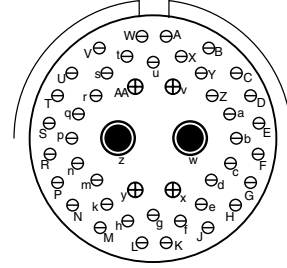
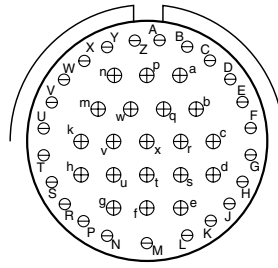

Shell Size & Insert Arrg. for:

|                      |              |              |              |
|----------------------|--------------|--------------|--------------|
| <b>Series II JT</b>  | <b>25-43</b> |              |              |
| <b>Series I LJT</b>  | <b>25-43</b> |              |              |
| <b>Series III TV</b> | <b>25-41</b> | <b>25-43</b> | <b>25-46</b> |
| Service Rating       | N/Inst.      |              |              |
| Number of Contacts   | 22           | 3            | 11           |
| Contact Size         | 22D          | 20           | 16           |

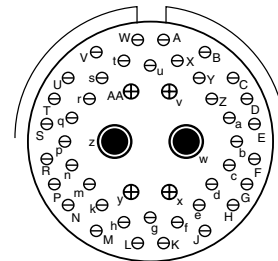
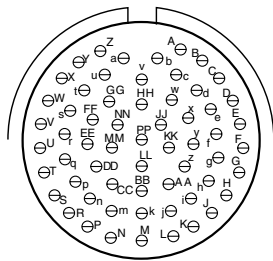

Shell Size & Insert Arrg. for:

|                      |              |              |              |
|----------------------|--------------|--------------|--------------|
| <b>Series II JT</b>  | <b>24-61</b> |              |              |
| <b>Series I LJT</b>  | <b>25-61</b> |              |              |
| <b>Series III TV</b> | <b>25-61</b> | <b>25-62</b> | <b>25-90</b> |
| Service Rating       | I            |              |              |
| Number of Contacts   | 61           | 8            | 4            |
| Contact Size         | 20           | 16           | 8            |

Ground Plane Only

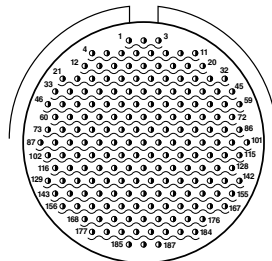
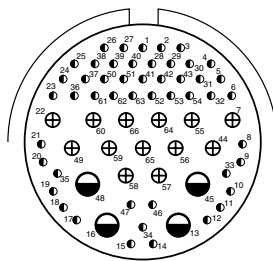

Shell Size & Insert Arrg. for:

|                      |                        |    |    |                  |
|----------------------|------------------------|----|----|------------------|
| <b>Series II JT</b>  | <b>25-F4</b>           |    |    | <b>25-187 HD</b> |
| <b>Series I LJT</b>  |                        |    |    |                  |
| <b>Series III TV</b> |                        |    |    |                  |
| Service Rating       | Size 22D=M, Balance =I |    |    | N                |
| Number of Contacts   | 49                     | 13 | 4  | 187              |
| Contact Size         | 22D                    | 16 | 12 | 23               |

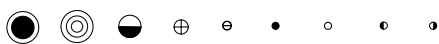

CONTACT LEGEND 8 10 12 16 20 22 22M 22D 23

† Coax contacts for RG180/U or RG195/U cable.

HD: High Density HD38999 (use size 23 contacts only)

38999

- III
- HD
- Duallok
- II
- I
- SJT
- Accessories
- Aquacon
- Herm/Seal
- PCB

- HIGH SPEED
- Fiber Optics
- Contacts Connectors Cables

EMI Filter Transient

26482 Matrix 2

83723 III Matrix | Pyle

26500 Pyle

5015 Crimp Rear Release Matrix

22992 Class I

Back-Shells

Options Others

38999

Front face of pin inserts illustrated

- III
- HD
- Dualok
- II
- I
- SJT
- Accessories
- Aquacon
- Herm/Seal
- PCB

- HIGH SPEED
- Fiber Optics
- Contacts Connectors Cables

- EMI Filter Transient

- 26482 Matrix 2

- 83723 III Matrix | Pyle

- 26500 Pyle

- 5015 Crimp Rear Release Matrix

- 22992 Class I

- Back-Shells

- Options Others

Shell Size & Insert Arrg. for:

| Series III TV      | 9-2 | 15-4* | 15-25  | 17-20  | 21-12 | 21-21   |
|--------------------|-----|-------|--------|--------|-------|---------|
| Service Rating     | I   | II    | M      | M      | I     | M/Inst. |
| Number of Contacts | 2   | 4     | 22 3   | 16 4   | 3 9   | 32 9    |
| Contact Size       | 20  | 16    | 22D 16 | 22D 12 | 20 12 | 22D 12  |

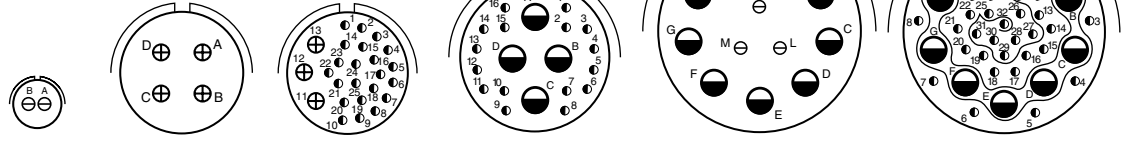

Shell Size & Insert Arrg. for:

| Series III TV      | 21-99  | 25-92  | 25-97     |
|--------------------|--------|--------|-----------|
| Service Rating     | M      | M      | M         |
| Number of Contacts | 5 11   | 92 9   | 26 3 13   |
| Contact Size       | 22D 12 | 22D 16 | 22D 16 12 |

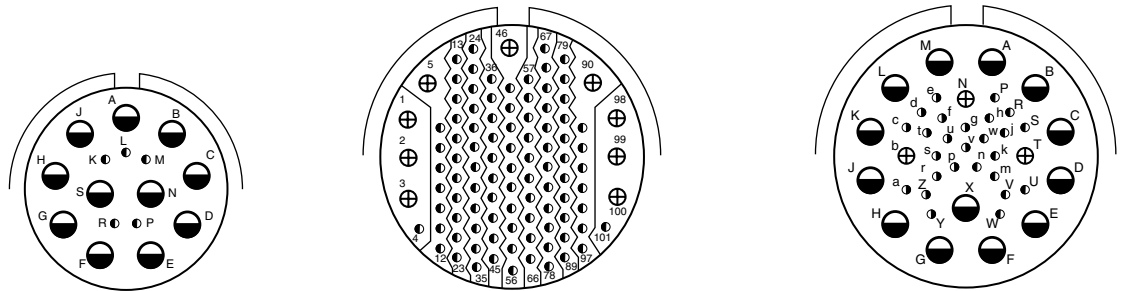

NOTE: Some specials shown here were formerly known as Pyle arrangements. Consult Amphenol for how to order information for connectors with these inserts. For further information on special arrangements consult Amphenol Aerospace, Sidney NY.

\* Pyle 15-4 does not mate with Amphenol Tri-Start 15-4 insert.

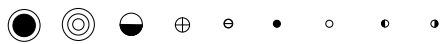

CONTACT LEGEND 8 10 12 16 20 22 22M 22D 23\*

Front face of pin inserts illustrated

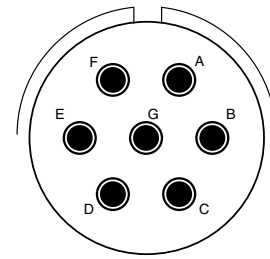
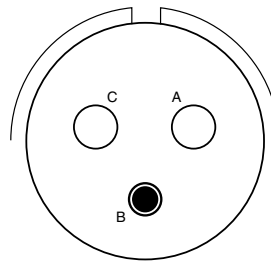
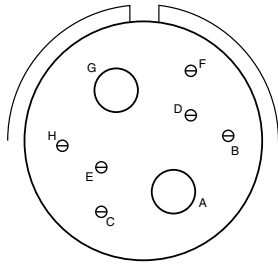

Shell Size & Insert Arrg. for:

| Series III TV      | 25-16 | 25L-3 | 25L-7 |
|--------------------|-------|-------|-------|
| Service Rating     | M     | II    | II    |
| Number of Contacts | 6 2   | 1 2   | 7     |
| Contact Size       | 20 4  | 8 4   | 8     |

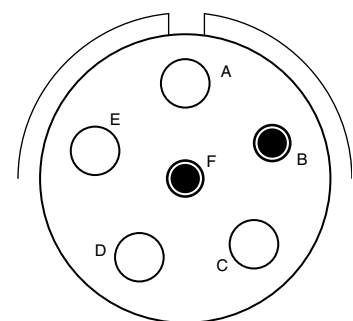
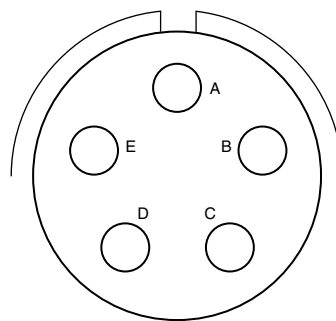
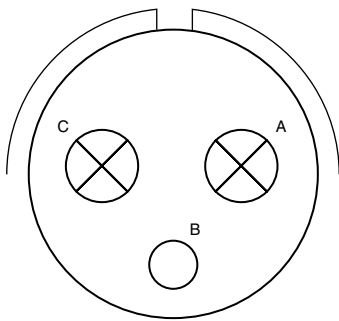

Shell Size & Insert Arrg. for:

| Series III TV      | 33-3 | 33-5 | 33-6 |
|--------------------|------|------|------|
| Service Rating     | II   | II   | II   |
| Number of Contacts | 1 2  | 5    | 2 4  |
| Contact Size       | 4 0  | 4    | 8 4  |



Shell Size & Insert Arrg. for:

| Series III TV      | 37-5 |
|--------------------|------|
| Service Rating     | II   |
| Number of Contacts | 4    |
| Contact Size       | 0    |

NOTE: Some specials shown here were formerly known as Pyle arrangements. Consult Amphenol for how to order information for connectors with these inserts.

Consult Amphenol Aerospace for longer shell drawings.

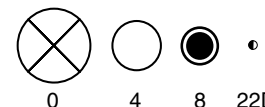

CONTACT LEGEND

38999

- III
- HD
- Dualok
- II
- I
- SJT
- Accessories
- Aquacon
- Herm/Seal
- PCB

- HIGH SPEED
- Fiber Optics
- Contacts
- Connectors
- Cables

EMI Filter  
Transient

26482  
Matrix 2

83723 III  
Matrix | Pyle

26500  
Pyle

5015  
Crimp Rear Release Matrix

22992  
Class 1

Back-Shell's

Options  
Others



38999

### CONTACT RATING FOR TV III, HD, JT II, LJT I, SJT

| Contact Size | Test Current (Amps) |          | Maximum Millivolt Drop Crimp* | Maximum Millivolt Drop |           |
|--------------|---------------------|----------|-------------------------------|------------------------|-----------|
|              | Crimp               | Hermetic |                               | Solder*                | Hermetic* |
| 23           | 5                   | 3        | 73                            | 20                     | 85        |
| 22M          | 3                   | 2        | 45                            | 20                     | 60        |
| 22D          | 5                   | 3        | 73                            |                        | 85        |
| 22           | 5                   | 3        | 73                            | 20                     | 85        |
| 20           | 7.5                 | 5        | 55                            | 20                     | 60        |
| 16           | 13                  | 10       | 49                            | 20                     | 85        |
| 12           | 23                  | 17       | 42                            | 20                     | 85        |
| 10 (Power)   | 33                  | NA       | 33                            | NA                     | NA        |
| 8 (Power)    | 46                  | NA       | 26                            | NA                     | NA        |
| 4            | 80                  | NA       | 23                            | NA                     | NA        |
| 0            | 150                 | NA       | 21                            | NA                     | NA        |

| Contact Size | Crimp Well Data |                   | Solder Well Data    |                    |
|--------------|-----------------|-------------------|---------------------|--------------------|
|              | Well Diameter   | Normal Well Depth | Well Diameter       | Nominal Well Depth |
| 23           | .0345 ± .0010   | .141              | .0345 ± .0010       | .130               |
| 22M          | .028 ± .001     | .141              | .029 +.004<br>-.000 |                    |
| 22D          | .0345 ± .0010   | .141              | .036 +.004<br>-.000 | .094               |
| 22           | .0365 ± .0010   | .141              | .036 +.004<br>-.000 | .094               |
| 20           | .047 ± .001     | .209              | .044 +.004<br>-.004 | .125               |
| 16           | .067 ± .001     | .209              | .078 +.000<br>-.004 | .141               |
| 12           | .100 ± .002     | .209              | .116 +.004<br>-.002 | .141               |
| 10 (Power)   | .137 ± .002     | .355              | NA                  | NA                 |
| 8            | .181 ± .002     | .490              | NA                  | NA                 |
| 4            | .281 ± .002     | .490              | NA                  | NA                 |
| 0            | .453 ± .002     | .585              | NA                  | NA                 |

\*When tested using silver plated wire.

### SERVICE RATING\*\*

| Service Rating | Suggested Oper. Voltage (Sea Level) |      | Test Voltage (Sea Level) | Test Voltage 50,000 Ft. | Test Voltage 70,000 Ft. | Test Voltage 110,000 Ft. |
|----------------|-------------------------------------|------|--------------------------|-------------------------|-------------------------|--------------------------|
|                | AC (RMS)                            | DC   |                          |                         |                         |                          |
| M              | 400                                 | 500  | 1300 VRMS                | 550 VRMS                | 350 VRMS                | 200 VRMS                 |
| N              | 300                                 | 450  | 1000 VRMS                | 400 VRMS                | 260 VRMS                | 200 VRMS                 |
| I              | 600                                 | 850  | 1800 VRMS                | 600 VRMS                | 400 VRMS                | 200 VRMS                 |
| II             | 900                                 | 1250 | 2300 VRMS                | 800 VRMS                | 500 VRMS                | 200 VRMS                 |

\*\*Please note that the establishment of electrical safety factors is left entirely in the designer's hands, since he is in the best position to know what peak voltage, switching surges, transients, etc. can be expected in a particular circuit.

### MIL-DTL-38999 Series III STANDARD 500 CYCLE CONTACTS FOR TV AND CTV, P & S

| Contact Size | TV/CTV Pins     |             | TV/CTV Sockets |             |
|--------------|-----------------|-------------|----------------|-------------|
|              | Military No.    | Supersedes  | Military No.   | Supersedes  |
| 8 (Coax)*    | M39029/60-367   | MS27536     | M39029/59-366  | MS27535     |
| 8 (Power)    | Contact Factory | "           | "              | "           |
| 8 (Twinax)   | M39029/90-529** | N/A         | M39029/91-530  | N/A         |
| 10 (Power)   | M39029/58-528   | N/A         | M39029/56-527  | N/A         |
| 12           | M39029/58-365   | MS27493-12  | M39029/56-353  | MS27490-12  |
| 16           | M39029/58-364   | MS27493-16  | M39029/56-352  | MS27490-16  |
| 20           | M39029/58-363   | MS27493-20  | M39029/56-351  | MS27490-20  |
| 22D          | M39029/58-360   | MS27493-22D | M39029/56-348  | MS27490-22D |
| 4            | N/A             | N/A         | N/A            | N/A         |
| 0            | N/A             | N/A         | N/A            | N/A         |

### MIL-DTL-38999 Series III SEALING PLUGS

| Contact Size | Commercial No. | Military No. |
|--------------|----------------|--------------|
| 8 (Coax)     | 10-482099-8    | N/A          |
| 8 (Twinax)   | T3-4008-59P    | N/A          |
| 8 (Power)    | 10-405996-83   | MS27488-8-3  |
| 10 (Power)   | T3-4010-59P    | M85049/81-10 |
| 12           | 10-405996-122  | MS27488-12-2 |
| 16           | 10-405996-162  | MS27488-16-2 |
| 20           | 10-405996-202  | MS27488-20-2 |
| 22D          | 10-405996-222  | MS27488-22-2 |
| 4            | 10-405996-43   | MS27488-4-3  |
| 0            | 10-405996-03   | MS27488-0-3  |

Above part numbers include standard 500 cycle finish designation - gold plating over suitable underplate in accordance with SAE AS39029. For other finish variations, consult Amphenol Aerospace.

\*For use with RG180B/U and RG195A/U cable. For other size 8 coax or optional sizes 12 and 16 coax contacts available for use in Tri-Start connectors, see High Speed Contact section in this catalog or consult Amphenol Aerospace.

\*\* For use with M17/M176-00002 cable.

† Optional design - see slash sheet MS39029.

For other contact options available for use in Tri-Start connectors (wire wrap, thermocouple, fiber optic), consult Amphenol.

### MIL-DTL-38999 Series III 1500 CYCLE CONTACTS FOR CTV, CLASSES H & J

| Contact Size | CTV Pins       |                |            | CTV Sockets    |                |            |
|--------------|----------------|----------------|------------|----------------|----------------|------------|
|              | Commercial No. | Military No.   | Supersedes | Commercial No. | Military No.   | Supersedes |
| 12           | 10-597072-2X   | M39029/107-623 | -          | 10-597073-2X   | M39029/106-617 | -          |
| 16           | 10-597068-2X   | M39029/107-622 | -          | 10-597069-2X   | M39029/106-616 | -          |
| 20           | 10-597064-2X   | M39029/107-621 | -          | 10-597065-2X   | M39029/106-615 | -          |
| 22D          | 10-597058-3X   | M39029/107-620 | -          | 10-597061-2X   | M39029/106-614 | -          |

### MIL-DTL-38999 Series II JT/ Series I LJT/SJT Series CRIMP CONTACTS

| Contact Size | JT/LJT/SJT Pins MS No. | JT Socket MS No. | LJT/SJT Sockets MS No. | Contact Size | JT/LJT Pins MS No. | JT Socket MS No. | LJT/SJT Sockets MS No. |
|--------------|------------------------|------------------|------------------------|--------------|--------------------|------------------|------------------------|
| 8 (Coax)*    | M39029/60-367          | NA               | M39029/59-366          | 20           | M39029/58-363      | M39029/57-357    | M39029/56-351          |
| 8 (Twinax)   | M39029/90-529**        | NA               | M39029/91-530          | 22           | M39029/58-362      | M39029/57-356    | M39029/56-350          |
| 10 (Power)   | M39029/58-528          | NA               | M39029/56-527          | 22M          | M39029/58-361      | M39029/57-355    | M39029/56-349          |
| 12           | M39029/58-365          | M39029/57-359    | M39029/56-353          | 22D          | M39029/58-360      | M39029/57-354    | M39029/56-348          |
| 16           | M39029/58-364          | M39029/57-358    | M39029/56-352          |              |                    |                  |                        |

### THERMOCOUPLE CONTACTS Series II JT/ I LJT

| Contact Size | Material   | JT/LJT Pins   | JT Sockets    | LJT Sockets   |
|--------------|------------|---------------|---------------|---------------|
| 20           | Chromel    | 10-407862-310 | 10-407863-310 | 10-407236-310 |
|              | Alumel     | 10-407862-320 | 10-407863-320 | 10-407865-320 |
|              | Iron       | 10-407862-335 | 10-407863-335 | 10-407865-335 |
|              | Constantan | 10-407862-342 | 10-407863-342 | 10-407865-342 |

Partial Listing. If you do not see the contact for your application, consult Amphenol Aerospace.

### THERMOCOUPLE CONTACTS PYLE VERSION Series II JT/ I LJT

| Contact Size | Pins (II JT/I LJT) |             | Sockets (LJT) |             | Material |
|--------------|--------------------|-------------|---------------|-------------|----------|
|              | Spec Number        | Pyle Number | Spec Number   | Pyle Number |          |
| 22D          | M39029/87-472      | T3-4022-10P | M39029/88-484 | T3-4122-10P | CHROMEL  |
| 22D          | M39029/87-471      | T3-4022-10R | M39029/88-483 | T3-4122-10R | ALUMEL   |
| 20           | M39029/87-476      | T3-4020-10P | M39029/88-488 | TS-4120-10P | CHROMEL  |
| 20           | M39029/87-475      | T3-4020-10R | M39029/88-487 | T3-4120-10R | ALUMEL   |
| 16           | M39029/87-480      | T3-4016-10P | M39029/88-492 | T3-4116-10P | CHROMEL  |
| 16           | M39029/87-479      | T3-4016-10R | M39029/88-491 | T3-4116-10R | ALUMEL   |

Above part numbers include standard finish designation - gold plating over suitable underplate in accordance with MIL-DTL-39029. For other finishes, consult Amphenol Aerospace. Note: 22M and 22D contacts are interchangeable. \*For use with RG180B/U and RG195A/U cable. For other size 8 coax or optional sizes 12 and 18 coax contacts available for use in JT/LJT connectors, see High Speed Contacts section of this catalog.\*\* For use with 17/M176-00002 cable.

### SEALING PLUGS Series II JT/ I LJT

| Contact Size | Commercial No. | Military No. |
|--------------|----------------|--------------|
| 8 (Coax)     | 10-482099-8    | MS27488-8    |
| 8 (Twinax)   | T3-4008-59P    | N/A          |
| 10 (Power)   | 10-576225      | N/A          |
| 12           | 10-405996-122  | MS27488-12-2 |
| 16           | 10-405996-162  | MS27488-16-2 |
| 20           | 10-405996-202  | MS27488-20-2 |
| 22           | 10-405996-222  | MS27488-22-2 |
| 22M          | 10-405996-222  | MS27488-22-2 |
| 22D          | 10-405996-222  | MS27488-22-2 |

### SEALING PLUGS SJT

| Contact Size | Commercial No.       |
|--------------|----------------------|
| 8 (Coax)     | 10-482099-8          |
| 8 (Twinax)   | 10-482099-8          |
| 10 (Power)   | NA                   |
| 12           | 10-405996-012 Yellow |
| 16           | 10-405996-016 Blue   |
| 20           | 10-405996-020 Red    |
| 22           | 10-405996-022 Black  |
| 22M          | 10-405996-022 Black  |
| 22D          | 10-405996-022 Black  |

### FINISH DATA MIL-DTL-38999, Tri-Start Series III TV

| Aluminum Shell Components Non-Hermetic*          |               |            |
|--------------------------------------------------|---------------|------------|
| Finish                                           | Service Class |            |
|                                                  | Military      | Commercial |
| Anodic Coating (Non-Conductive)                  | C*            | RX**       |
| Electroless Nickel                               | F (Metal)*    | RF         |
|                                                  | M (Composite) |            |
| Olive Drab Cadmium Plate Nickel Base             | W (Metal)*    | RW         |
|                                                  | J (Composite) |            |
| Stainless Steel with Nickel Plate (non-firewall) | L             |            |
| Stainless Steel with Nickel Plate (firewall)     | S             | RS         |
|                                                  | K             | RK         |
| Stainless Steel                                  | T*            | DT         |
| Durmalon plated                                  | Z*            | DZ         |

| Hermetic Shell Components         |               |            |
|-----------------------------------|---------------|------------|
| Material/Finish                   | Service Class |            |
|                                   | Military      | Commercial |
| Stainless Steel                   | Y             | Y          |
| Stainless Steel with Nickel Plate | N             | YN         |

\*\*Add Suffix (005) to part number.

### FINISH DATA MIL-DTL-38999, Series I LJT, II JT

| Finish                               | Aluminum Shell Components Non-Hermetic |            |                         | Indicated Finish Standard for JT Types Listed Below | Indicated Finish Standard for LJT Types Listed Below |
|--------------------------------------|----------------------------------------|------------|-------------------------|-----------------------------------------------------|------------------------------------------------------|
|                                      | Military                               | Commercial | Finish Plus "SR" Suffix |                                                     |                                                      |
| Cadmium Plated Nickel Base           | MS (A)                                 | -          | (SR)                    | JT/JTG/JTL/JTP                                      | LJT/LJTP                                             |
| Anodic Coating (Alumilite)           | MS (C)                                 | (005)      | (300)                   | JTS/JTPS/JTLS                                       | LJTSP/LJTSP                                          |
| Chromate Treated (Iridite 14-2)      |                                        | (011)      | (344)                   | JTN/JTPN/JTLN                                       | LJTNP/LJTNP                                          |
| Olive Drab Cadmium Plate Nickel Base | MS (B)                                 | (014)      | (386)                   |                                                     |                                                      |
| Electroless Nickel                   | MS (F)                                 | (023)      | (424)                   |                                                     |                                                      |
| Nickel-PTFE Durmalon                 |                                        | (038)      |                         |                                                     |                                                      |

| Finish                                                       | Hermetic Connectors |            | Indicated Finish Standard for JT Types Listed Below | Indicated Finish Standard for LJT Types Listed Below |
|--------------------------------------------------------------|---------------------|------------|-----------------------------------------------------|------------------------------------------------------|
|                                                              | Military            | Commercial |                                                     |                                                      |
| Carbon Steel Shell<br>Tin Plated Shell and Contacts          |                     |            | JT( )H / JT( )Y<br>JTL( )H / JTL( )Y                | LJT( )Y<br>LJT( )H                                   |
| Carbon Steel Shell Tin Plated Shell and Gold Plated Contacts | MS (D)              |            |                                                     |                                                      |
| Stainless Steel Shell Gold Plated Contacts                   | MS (E)              | (162)      | JTS( )Y<br>JTLS( )Y                                 | LJTS( )Y                                             |

38999

III

HD

Dualok

II

I

SJT

Accessories

Aquacon

Herm/Seal

PCB

HIGH SPEED

Fiber Optics

Contacts Connectors Cables

EMI Filter Transient

26482 Matrix 2

83723 III Matrix I Pyle

26500 Pyle

5015 Crimp Rear Release Matrix

22992 Class 1

Back-Shell's

Options Others



## Tri-Start™ MIL-DTL-38999 Series III with Metal Shells - Aluminum, Stainless Steel, Class K Firewall

Amphenol® Tri-Start MIL-DTL-38999\* Series III Connectors offer the highest performance capabilities for both general duty and severe environment applications. Meeting or exceeding MIL-DTL-38999 Series III requirements, the Tri-Start connector with standard metal shells (aluminum or stainless steel with several finish options) offers these features:

- **EMI Shielding** - solid metal-to-metal coupling, grounding fingers, electroless nickel plating, and thicker wall sections provide superior EMI shielding capability of 65dB minimum at 10 GHz
- **Contact Protection** - recessed pins in this 100% scoop-proof connector minimize potential contact damage
- **Moisture Resistance** - improved interfacial seal design helps prevent electrolytic erosion of contacts
- **Corrosion Resistance** - shells of stainless steel or cadmium over nickel plating withstand a 500 hour salt spray exposure
- **Vibration/Shock** - operates under severe high temperature vibration, through 200°C
- **Firewall Capability** - available in a stainless steel shell, class RK, RS
- **Lockwiring Eliminated** - unique, self-locking, quick coupling connector eliminates lockwiring
- **Quick Coupling** - completely mates and self-locks in a 360° turn of the coupling nut
- **Inventory Support Commonality** - uses standard MIL-DTL-38999 contacts, application tools, insert arrangements
- **Electrostatic Discharge Protection (ESD)** - protection for sensitive circuitry without diodes, varistors, etc., with the use of the Faraday Cage principle which shunts high voltage, high current discharge events (see page 331)
- **Hermetic**- air leakage limited to 1 X 10<sup>-7</sup> cm<sup>3</sup> per second optional
- **Qualified Specifications** - Stainless Steel qualified to BACC63DB and BACC63DC specifications

### Optional Shell Geometries

Amphenol offers a number of different shell configurations to fit your needs.

- Deep Reach Shells - For increased panel thickness
- Stand-off Flange Shells - For attachments to Printed Circuit Boards.
- Connector with Integral Strain Reliefs

\* MIL-DTL-38999 Series III supersedes MIL-C-38999 Series III.

#### Applicable Patents:

Tri-Start™ Connector Patent 4,109,990.

Composite Connector Patents:

4,268,103; 4,648,670; 4,682,832; 4,703,987.

Clutch-Lok® Patent 6,152,753.

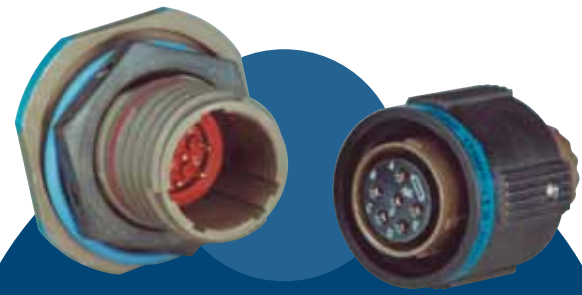

## Series III Composite Tri-Start, Qualified to MIL-DTL-38999, Rev. J

MIL-Qualified to MIL-DTL-38999, Rev. K, the Amphenol® Composite Tri-Start Connector offers a lightweight, corrosion resistant connector with the same high performance features as its metal counterpart. The Composite Tri-Start Connector also includes the following features:

- **Lightweight** - 17% – 70% weight savings (17–40% weight savings vs. Aluminum) (60–70% weight savings vs. Stainless steel) See Composite weight comparison chart on page 23.
- **Corrosion Resistance** - available in standard MIL-DTL-38999 olive drab cadmium (-65°C to 175°C) and electroless nickel plating (-65°C to 200°C), both withstanding 2000 hours of salt spray exposure. The base material is able to withstand an indefinite exposure to salt spray.
- **Durability** - 1500 couplings minimum (in reference to connector couplings, not contacts)
- **Extended Life Contact** - Mil-approved plating process which provides 1500 couplings minimum
- Qualified to BACC63CT and BACC63CU specifications



## CLUTCH-LOK™ MIL-DTL-38999 Series III High Vibration Connector

The Tri-Start option CLUTCH-LOK offers all advantages of stainless steel/Class K firewall for MIL-DTL-38999 Series III connectors, plus a unique clutch design that actually tightens itself under vibration. Features include:

- High degree of differential torque
- No settling back to the next ratchet tooth
- Completely intermateable with all existing MIL-DTL-38999 Series III connectors
- Offers advantage in inaccessible, hard to reach areas where mating torque is difficult to apply and complete coupling is not verifiable by inspection

See page 32 for description, 25 – 27 for ordering.

## 38999

|             |
|-------------|
| III         |
| HD          |
| Dualok      |
| II          |
| I           |
| SJT         |
| Accessories |
| Aquacon     |
| Herm/Seal   |
| PCB         |

|                            |
|----------------------------|
| HIGH SPEED                 |
| Fiber Optics               |
| Contacts Connectors Cables |

|                      |
|----------------------|
| EMI Filter Transient |
|----------------------|

|                |
|----------------|
| 26482 Matrix 2 |
|----------------|

|                         |
|-------------------------|
| 83723 III Matrix   Pyle |
|-------------------------|

|            |
|------------|
| 26500 Pyle |
|------------|

|                                |
|--------------------------------|
| 5015 Crimp Rear Release Matrix |
|--------------------------------|

|               |
|---------------|
| 22992 Class I |
|---------------|

|             |
|-------------|
| Back-Shells |
|-------------|

|                |
|----------------|
| Options Others |
|----------------|

## Series III, TV Tri-Start Connectors, offer more versatility & options than any other interconnection family!



High reliability and increased versatility best describe Amphenol MIL-DTL-38999, Series III circular connectors. Originally designed for the harshest of environments and most demanding of applications, Amphenol MIL-DTL-38999 Series III, Tri-Start connectors continue to evolve in pace with the needs of an ever-changing market.

Amphenol Tri-Start connectors can be configured with a number of application specific technologies like High Density HD38999, Duallok, Filters, Hermetics, PC Tails, Fiber Optics, Flex, CLUTCH-LOK, Fail Safe, and contacts. Flexibility aids in design optimization through the combination of different technologies within a common, time-tested, harsh environment connector body.

For more information about options, please call 800-678-0141 or visit [www.amphenol-aerospace.com](http://www.amphenol-aerospace.com).

## Performance

### Designed for Performance

Numerous advantages in performance capability are designed into the Amphenol Tri-Start Connector. A positive metal to metal coupling design, grounding fingers, and electroless nickel plating provide superior EMI shielding capability of 65 dB minimum at 10 GHz.

Acme threads provide coupling durability. Thicker wall sections and a greater coupling surface area improve strength and shock resistance. Blunting of the thread on both the coupling nut and receptacle eliminates cross coupling. The connector quickly mates and self locks in a 360° turn of the coupling nut.

Elongated mounting holes permit the Tri-Start Connector to intermount with various existing MIL-Spec box or wall mount receptacles, giving it a design replacement advantage.

Shells of stainless steel or cadmium over nickel plating prevent severe corrosion. Resistance is tested through exposure to a 500 hour salt spray. Composite versions provide protection from salt spray exposure for 2000 hours. Other finish options are available; see how to order Tri-Start metal and Tri-Start Composite.

Recessed pins minimize potential contact damage in this 100% scoop-proof connector. In a blind mating application, mating shells cannot "scoop" the pins and cause a shorting or bending of contacts.

The design of the Amphenol Tri-Start interfacial seal meets the MIL-DTL-38999 Series III requirements for electrolytic erosion resistance.

A rigid dielectric insert with excellent electrical characteristics provides durable protection to the contacts. The socket contacts are probe proof, and all contacts are rear removable. They are plated in the standard 50 micro inches minimum gold, with 100 micro inches as an option, and are available in standard Tri-Start insert arrangements and special Pyle® insert arrangements in sizes 10 power, 12, 16, 20 and 22D contacts. Special insert patterns are also available with larger contacts in sizes 4 and 0.

38999

III

HD

Dualok

II

I

SJT

Accessories

Aquacon

Herm/Seal

PCB

HIGH SPEED

Fiber Optics

Contacts  
Connectors  
Cables

EMI Filter  
Transient

26482  
Matrix 2

83723 III  
Matrix | Pyle

26500  
Pyle

5015  
Crimp Rear Release  
Matrix

22992  
Class I

Back-  
Shells

Options  
Others



# MIL-DTL-38999, Series III TV

## Weight Comparisons (Composite vs. Metal)

Depending on the shell style, shell size and contact count, weight savings can range from 17% to 40% compared to standard aluminum product.

**Tri-Start Weight in Ounces (includes contacts)**

# Weight

|       | Wall Mount Receptacle (00 • Military D38999/20) |        |          |        |           |        | Jam Nut Receptacle (07) • Military D38999/24 |        |          |        |           |        | Plug (06) • Military D38999/26 |        |          |        |           |        |
|-------|-------------------------------------------------|--------|----------|--------|-----------|--------|----------------------------------------------|--------|----------|--------|-----------|--------|--------------------------------|--------|----------|--------|-----------|--------|
|       | Stainless Steel                                 |        | Aluminum |        | Composite |        | Stainless                                    |        | Aluminum |        | Composite |        | Stainless Steel                |        | Aluminum |        | Composite |        |
|       | Pin                                             | Socket | Pin      | Socket | Pin       | Socket | Pin                                          | Socket | Pin      | Socket | Pin       | Socket | Pin                            | Socket | Pin      | Socket | Pin       | Socket |
| 9-35  | .7216                                           | .7840  | .3248    | .3777  | .2588     | .3121  | 1.1472                                       | 1.2096 | .4416    | .5040  | .3489     | .4413  | 1.0736                         | 1.1360 | .4236    | .4625  | .2606     | .2994  |
| 9-98  | .7216                                           | .7776  | .2496    | .3056  | .1664     | .2224  | 1.1472                                       | 1.2032 | .4416    | .4976  | .3744     | .4640  | 1.0736                         | 1.1296 | .3968    | .4624  | .2991     | .2337  |
| 11-35 | .9488                                           | 1.0800 | .3632    | .4960  | .2753     | .4081  | 1.4304                                       | 1.5632 | .5936    | .7264  | .4679     | .6007  | 1.2480                         | 1.3808 | .5312    | .6389  | .3450     | .4582  |
| 11-98 | .9488                                           | 1.0620 | .3632    | .4768  | .2753     | .3889  | 1.4304                                       | 1.5440 | .5936    | .7072  | .4679     | .5815  | 1.2480                         | 1.3616 | .5330    | .6283  | .3468     | .4457  |
| 13-8  | 1.2096                                          | 1.3888 | .4800    | .6592  | .3696     | .5488  | 1.9104                                       | 2.0896 | .7664    | .9456  | .6560     | .8352  | 1.8048                         | 1.9840 | .7936    | .9728  | .5237     | .5952  |
| 13-35 | 1.2160                                          | 1.4320 | .4864    | .7024  | .3762     | .5922  | 1.9168                                       | 2.1328 | .7728    | .9888  | .6136     | .8296  | 1.8112                         | 2.0272 | .8000    | .8472  | .5301     | .6531  |
| 13-98 | 1.2160                                          | 1.4016 | .4864    | .6720  | .3762     | .5618  | 1.9168                                       | 2.1024 | .7728    | .9584  | .6136     | .7992  | 1.8112                         | 1.9968 | .7978    | .9856  | .5244     | .7157  |
| 15-5  | 1.5312                                          | 1.7904 | .6352    | .8944  | .5027     | .7619  | 2.3792                                       | 2.6384 | .9728    | 1.2320 | .7749     | 1.0341 | 2.2704                         | 2.5456 | .9632    | 1.1719 | .6450     | .8467  |
| 15-18 | 1.5456                                          | 1.8416 | .7760    | .9456  | .6432     | .8128  | 2.3936                                       | 2.6896 | .9872    | 1.2832 | .8544     | 1.1504 | 2.2848                         | 2.5808 | .9776    | 1.2736 | .6594     | .8208  |
| 15-35 | 1.5424                                          | 1.8768 | .6464    | .9808  | .5139     | .8483  | 2.3904                                       | 2.7344 | .9840    | 1.3280 | .7861     | 1.1301 | 2.2816                         | 2.6256 | 1.2179   | 1.3184 | .8961     | 1.0002 |
| 17-6  | 2.1488                                          | 2.5904 | .9360    | 1.3776 | .7812     | 1.2228 | 2.9152                                       | 3.3568 | 1.2336   | 1.6752 | .9940     | 1.4356 | 2.5008                         | 3.1024 | 1.1408   | 1.7424 | .8160     | 1.4176 |
| 17-26 | 2.1344                                          | 2.5600 | .9216    | 1.3472 | .7668     | 1.1924 | 2.9008                                       | 3.3264 | 1.2192   | 1.6448 | .9796     | 1.4052 | 2.4864                         | 2.9120 | 1.1264   | 1.3343 | .8017     | .8062  |
| 17-35 | 2.1360                                          | 2.6640 | .9232    | 1.4512 | .7684     | 1.2964 | 2.9024                                       | 3.4304 | 1.2208   | 1.7488 | .9812     | 1.5092 | 2.4880                         | 3.0160 | 1.1280   | 1.5497 | .8033     | 1.2144 |
| 19-11 | 2.2592                                          | 2.6656 | .9696    | 1.4528 | .7925     | 1.2757 | 3.4352                                       | 3.9184 | 1.4720   | 1.9552 | 1.2033    | 1.6865 | 2.9808                         | 3.4640 | 1.3472   | 1.8304 | .9632     | 1.4464 |
| 19-32 | 2.1888                                          | 2.7264 | .9760    | 1.5136 | .7989     | 1.3365 | 3.4416                                       | 3.9792 | 1.4784   | 2.0160 | 1.2097    | 1.7473 | 2.9872                         | 3.5248 | 1.3536   | 1.8912 | .9696     | 1.5072 |
| 19-35 | 2.1920                                          | 2.8432 | .9792    | 1.6304 | .8021     | 1.4533 | 3.4448                                       | 4.0960 | 1.4816   | 2.1328 | 1.2129    | 1.8641 | 2.9904                         | 3.6416 | 1.3568   | 2.0080 | .9728     | 1.6240 |
| 21-11 | 2.7456                                          | 3.4640 | 1.3088   | 2.0272 | 1.1088    | 1.8272 | 3.9712                                       | 4.6896 | 1.8128   | 2.5312 | 1.6128    | 2.3312 | 3.4448                         | 4.1632 | 1.7344   | 2.5312 | 1.3039    | 1.8710 |
| 21-16 | 2.6784                                          | 3.3168 | 1.2416   | 1.8800 | 1.0422    | 1.6806 | 3.9040                                       | 4.5424 | 1.7456   | 2.3840 | 1.4505    | 2.0889 | 3.3776                         | 4.0160 | 1.6672   | 2.3168 | 1.2352    | 1.8736 |
| 21-35 | 2.6672                                          | 3.4992 | 1.2304   | 2.0624 | 1.0310    | 1.8630 | 3.8928                                       | 4.7248 | 1.7344   | 2.5664 | 1.4393    | 2.2713 | 3.3664                         | 4.1984 | 1.6560   | 2.2309 | 1.2255    | 1.8003 |
| 21-41 | 2.6768                                          | 3.3600 | 1.2400   | 1.9232 | 1.0406    | 1.7238 | 3.9024                                       | 4.5856 | 1.7440   | 2.4272 | 1.4489    | 2.1321 | 3.3760                         | 3.5792 | 1.6656   | 1.8688 | 1.2336    | 1.4368 |
| 23-21 | 3.0352                                          | 3.8624 | 1.4496   | 2.2768 | 1.2279    | 2.0551 | 4.2368                                       | 5.0640 | 1.9440   | 2.7712 | 1.6368    | 2.4640 | 3.7920                         | 4.6192 | 1.9216   | 2.7488 | 1.4637    | 2.2896 |
| 23-35 | 3.0240                                          | 4.0448 | 1.4384   | 2.4592 | 1.2167    | 2.2375 | 4.2256                                       | 5.2464 | 1.9328   | 2.9536 | 1.6256    | 2.6464 | 3.7808                         | 4.8016 | 1.9104   | 2.6087 | 1.4525    | 2.1507 |
| 23-53 | 2.8992                                          | 3.9072 | 1.4560   | 2.4816 | 1.2343    | 2.2599 | 4.2432                                       | 5.1088 | 1.9504   | 2.8160 | 1.6432    | 2.5088 | 3.7984                         | 4.6640 | 1.9280   | 2.7936 | 1.4672    | 2.2384 |
| 25-4  | 3.4512                                          | 4.4800 | 1.7312   | 2.8816 | 1.4864    | 2.1904 | 4.8048                                       | 5.8272 | 2.2016   | 3.2480 | 1.9568    | 2.8720 | 4.2224                         | 5.2496 | 2.2128   | 3.2560 | 1.7133    | 2.4163 |
| 25-19 | 3.5312                                          | 4.7264 | 1.8112   | 3.0064 | 1.5664    | 2.7616 | 4.8848                                       | 6.0816 | 2.2816   | 3.4784 | 2.0368    | 3.2336 | 4.3024                         | 5.4992 | 2.2928   | 3.4896 | 1.7933    | 2.7058 |
| 25-20 | 3.8190                                          | 4.7150 | 2.0173   | 3.1125 | 1.7733    | 2.8512 | 5.1430                                       | 6.0380 | 2.4877   | 3.5421 | 2.1872    | 3.2416 | 4.4350                         | 5.3300 | 2.2580   | 3.0182 | 1.8288    | 2.8928 |
| 25-35 | 3.4416                                          | 4.6656 | 1.7216   | 2.9456 | 1.4776    | 2.7016 | 4.7952                                       | 6.0192 | 2.1920   | 3.4160 | 1.8915    | 3.1155 | 4.2128                         | 5.4368 | 2.2032   | 3.4272 | 1.7037    | 2.9277 |
| 25-61 | 3.4304                                          | 4.4848 | 1.7282   | 2.7648 | 1.4841    | 2.5208 | 4.7840                                       | 5.8384 | 2.1808   | 3.2352 | 1.8803    | 2.9347 | 4.2016                         | 5.2560 | 2.1920   | 3.2464 | 1.6912    | 2.7456 |

All weight measurements are for reference only.

**38999**

- III
- HD
- Dualok
- II
- I
- SJT
- Accessories
- Aquacon
- Herm/Seal
- PCB

- HIGH SPEED
- Fiber Optics
- Contacts Connectors Cables

EMI Filter  
Transient

26482  
Matrix 2

83723 III  
Matrix | Pyle

26500  
Pyle

5015  
Crmp Rear Release Matrix

22992  
Class 1

Back-Shell's

Options  
Others



38999

- III
- HD
- Dualok
- II
- I
- SJT
- Accessories
- Aquacon
- Herm/Seal
- PCB

HIGH SPEED

- Fiber Optics
- Contacts
- Connectors
- Cables

EMI Filter Transient

26482 Matrix 2

83723 III Matrix | Pyle

26500 Pyle

5015 Crimp Rear Release Matrix

22992 Class I

Back-Shells

Options Others

### TRI-START, SERIES III TYPICAL SHIELDING EFFECTIVENESS TEST DATA

EMI/EMP SHIELDING EFFECTIVENESS dB  
TESTING BY TRIAXIAL METHOD

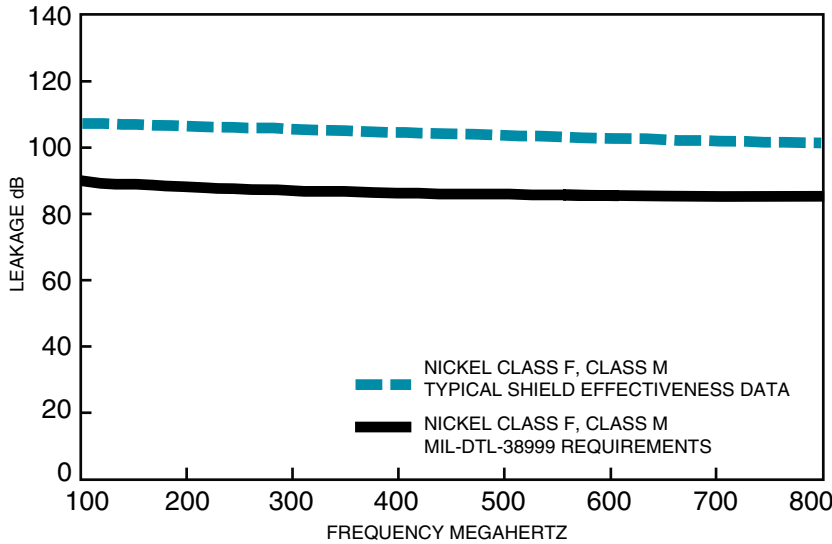

**Amphenol® Tri-Start connectors provide EMI/EMP shielding capability which exceeds MIL-DTL-38999 Series III requirements.**

The TV and CTV Series III connector with standard solid metal-to-metal coupling, EMI grounding fingers and conductive finishes have proven to be the ultimate in EMI/EMP shielding effectiveness. The charts illustrate shielding effectiveness data which is typical of Tri-Start connectors tested with the nickel finish (Class F-metal, Class M-composite) over a wide frequency range.

The vibration capability of the Tri-Start Series is shown in the chart below. This illustrates the most severe vibration envelope of any qualified connector available today. These capabilities along with a +200°C, -65°C temperature rating and superior moisture sealing protection provide the user with a connector that can withstand the most rigorous application.

### TRI-START, SERIES III TYPICAL SHIELDING EFFECTIVENESS TEST DATA

EMI/EMP SHIELDING EFFECTIVENESS dB  
TESTING BY MODE STIRRING METHOD

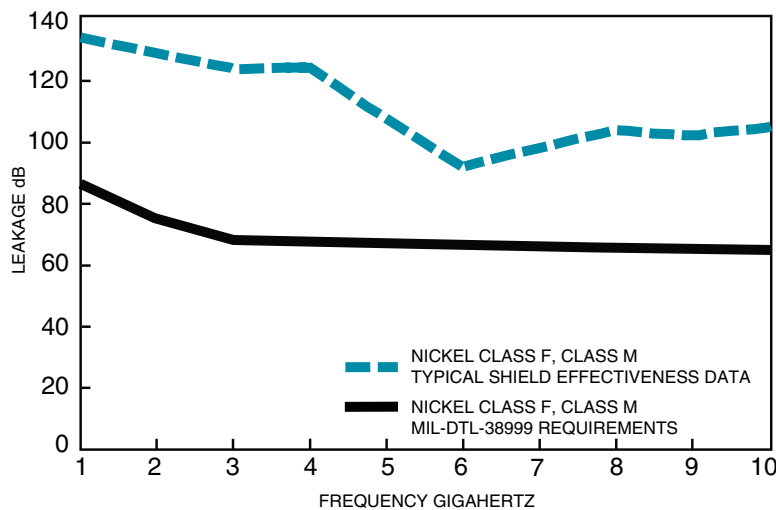

### TRI-START VIBRATION CRITERIA

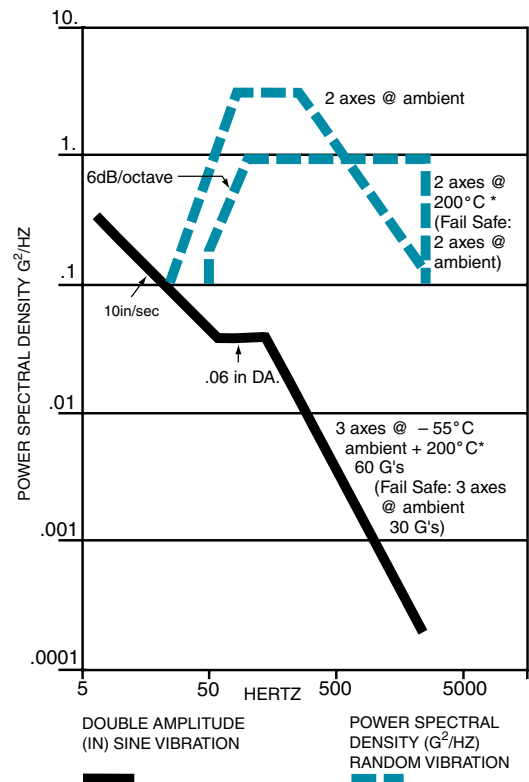

\* Dependant on shell finish

Test data beyond 2GHz is subject to equipment variation.

NOTE: For test data information on the new Clutch-Lok Tri-Start, high vibration connectors, consult Amphenol Aerospace.

### Easy Steps to build a part number... Tri-Start Series III TV

| 1.         | 2.          | 3.            | 4.                             | 5.           | 6.                        | 7.                 |
|------------|-------------|---------------|--------------------------------|--------------|---------------------------|--------------------|
| Commercial | Shell Style | Service Class | Shell Size– Insert Arrangement | Contact Type | Alternate Keying Position | Special Variations |
| TVPS       | 00          | RF            | 9-35                           | P            | B                         | (XXX)              |
| Military   | Shell Style | Service Class | Shell Size– Insert Arrangement | Contact Type | Alternate Keying Position |                    |
| D38999/    | 20          | J             | G35                            | P            | N                         |                    |

#### Step 1. Select a Connector Type

Do you need a Mil-Spec marked connector?

| Military-MIS-Spec Market |                                             |
|--------------------------|---------------------------------------------|
| D38999                   | Military MIL-DTL-38999 Series III Connector |

If you don't need Mil-Spec Marked Connector select from the choices below.

Next question to help you decide. What Shell Material & Temperature rating do you need?

| Aluminum 175°C                          |                                                                                                                    |
|-----------------------------------------|--------------------------------------------------------------------------------------------------------------------|
| TV                                      | Tri-Start 175°C                                                                                                    |
| TVP                                     | Panel mounted receptacle 175°C                                                                                     |
| Aluminum, Aluminum Bronze & Steel 200°C |                                                                                                                    |
| TVS                                     | 200°C rated                                                                                                        |
| TVPS                                    | Panel mounted, 200°C rated receptacle                                                                              |
| Composite 175°C                         |                                                                                                                    |
| CTV                                     | Composite 175°C                                                                                                    |
| CTVP                                    | Panel mounted composite receptacle 175°C                                                                           |
| Composite 200°C                         |                                                                                                                    |
| CTVS                                    | 200°C rated, composite                                                                                             |
| CTVPS                                   | Composite Panel mounted, 200° rated receptacle                                                                     |
| Steel 200°C                             |                                                                                                                    |
| MTV                                     | CLUTCH-LOK connector with "MS" stamping (Note: remove dashes in how to order part number when ordering CLUTCH-LOK) |

#### Step 2. Select a Shell Style

| COMMERCIAL             |         |     |      | MILITARY   |                 |                           | Designates                                              |
|------------------------|---------|-----|------|------------|-----------------|---------------------------|---------------------------------------------------------|
| TVP, TVPS, CTVP, CTVPS | TV, CTV | TVS | CTVS | CLUTCH-LOK | D38999 Military | D38999 Military Composite |                                                         |
| 00                     |         |     |      |            | 20              | 20                        | Wall Mount Receptacle                                   |
| 02                     |         |     |      |            |                 |                           | Box Mount Receptacle                                    |
|                        |         |     |      |            | 21              |                           | Box Mount Receptacle Hermetic                           |
|                        | 01      | 01  | 01   |            |                 |                           | Line Receptacle                                         |
|                        | 06      | 06  | 06   |            | 26              | 26                        | Straight Plug                                           |
|                        | 07      | 07  | 07   |            | 24              | 24                        | Jam Nut Receptacle                                      |
|                        | 09      | 09  |      |            |                 |                           | Flange Mounted Plug                                     |
|                        |         |     |      |            | 23              |                           | Jam Nut Receptacle Hermetic                             |
|                        |         | I   |      |            | 25              |                           | Solder Mount Receptacle Hermetic                        |
|                        |         | HI  |      |            | 27              |                           | Weld Mounted Receptacle, (Hermetic) Only                |
|                        | 56      | 56  | 56   |            |                 |                           | Straight plug with Dualok                               |
|                        |         |     |      | 26         |                 | 26                        | CLUTCH-LOK high vibration straight plug (Class RK only) |
|                        |         |     |      |            | 29              |                           | Lanyard release plug with pin contacts                  |
|                        |         |     |      |            | 30              |                           | Lanyard release plug with socket contacts               |
|                        |         |     |      |            | 31              |                           | Lanyard release plug for MIL-STD-1760 with pin contacts |
|                        |         |     |      |            | 32              |                           | Plug protection cap                                     |
|                        |         |     |      |            | 33              |                           | Receptacle protection cap                               |

Wall Mount Receptacle (00, 20)



Line Receptacle (01)



Box Mount Receptacle (02, 21)



Straight Plug (06)



Jam Nut Receptacle (07, 24)



Flange Mounting Plug (09)



Deep Reach Receptacle Consult Amphenol Aerospace

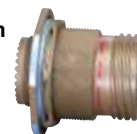

Solder Mount Hermetic Receptacle (I, 25)



Lanyard Release Plug (29, 30, 31)

38999

|             |
|-------------|
| III         |
| HD          |
| Dualok      |
| II          |
| I           |
| SJT         |
| Accessories |
| Aquacon     |
| Herm/Seal   |
| PCB         |

|                            |
|----------------------------|
| HIGH SPEED                 |
| Fiber Optics               |
| Contacts Connectors Cables |

EMI Filter Transient

26482 Matrix 2

83723 III Matrix | Pyle

26500 Pyle

5015 Crimp Rear Release Matrix

22992 Class 1

Back-Shell's

Options Others

38999

### Step 3. Select a Service Class

|                   |                |                  |                            |                 |                       |                       |
|-------------------|----------------|------------------|----------------------------|-----------------|-----------------------|-----------------------|
| 1. Connector Type | 2. Shell Style | 3. Service Class | 4. Shell Size-Insert Arrg. | 5. Contact Type | 6. Alternate Position | 7. Special Variations |
|                   |                | RX               |                            |                 |                       |                       |

| TV        | TVP       | CTV           | CTVP          | CTVS, CTVPS   | TVS       | TVPS      | CLUTCH-LOK | Military               | Finish                          | Description                                                                                                                                                                                  |
|-----------|-----------|---------------|---------------|---------------|-----------|-----------|------------|------------------------|---------------------------------|----------------------------------------------------------------------------------------------------------------------------------------------------------------------------------------------|
|           |           |               |               |               | RB        | RB        |            |                        | Aluminum Bronze                 | TBD<br>Corrosion resistant aluminum bronze for marine & other high corrosion applications, 200°C.                                                                                            |
|           |           |               |               |               |           |           |            | C                      | Anodic Coating                  | ■ Non-conductive, anodic coated aluminum, 500 hour salt spray, 200°C.                                                                                                                        |
| RX        | RX        |               |               |               | RX        | RX        |            |                        |                                 | TBD<br>Consult Amphenol Aerospace for details, options and availability of non-cadmium or ROHS Compliant Finishes.                                                                           |
|           |           |               |               | RF-Composite  | RF-Metal  | RF-Metal  |            | F-Metal<br>M-Composite | Electroless Nickel              | ■ Electroless nickel plated aluminum (composite) optimum EMI shielding effectiveness -65dB @ 10GHz specification min., 48 hour salt spray, 200°C (Composite-2000 hours dynamic salt spray).  |
|           |           |               |               | RGF-Composite | RGF-Metal | RGF-Metal |            |                        | Electroless Nickel              | ■ Electroless nickel plated ground plane aluminum (composite), 200°C                                                                                                                         |
|           |           |               |               |               |           |           |            | G                      | Electroless Nickel              | ■ Space grade, electroless nickel, 48 hour salt spray, 200°C                                                                                                                                 |
| RGW-Metal | RGW-Metal | RGW-Composite | RGW-Composite |               |           |           |            |                        | Olive Drab Cadmium              | ■ Olive drab cadmium plated ground plane aluminum (composite), 175°C                                                                                                                         |
|           |           |               |               |               | RK**      | RK**      | RK**       | K                      | Passivated Stainless Steel      | ■ Corrosion resistant stainless steel, fire-wall capability, plus 500 hour salt spray resistance, EMI -45 dB @ 10 GHz specification min., 200°C                                              |
|           |           |               |               |               | RKN       | RKN       |            |                        | Passivated Stainless Steel      | ■ Corrosion resistant stainless steel, non-firewall capability, plus 500 hour salt spray resistance, EMI -45 dB @ 10 GHz specification min., 200°C                                           |
|           |           |               |               |               | RL        | RL        |            | L                      | Stainless Steel w/ Nickel Plate | ■ Corrosion resistant steel, electro deposited nickel, 500 hour salt spray, 200°C, non firewall, EMI shielding -65dB @ 10GHz specification min.                                              |
| RW-Metal  | RW-Metal  | RW-Composite  | RW-Composite  |               |           |           |            | W-Metal<br>J-Composite | Olive Drab Cadmium              | ■ Corrosion resistant olive drab cadmium plate aluminum (composite), 500 hour salt spray, EMI Shielding -50 dB@10 GHz specification min., 175°C (Composite - 2000 hours dynamic salt spray). |
|           |           |               |               |               | Y         | Y         |            | Y                      | Stainless Steel                 | ■ Hermetic seal, passivated stainless steel, 200°C                                                                                                                                           |
|           |           |               |               |               | RS*       | RS*       | RS*        | S                      | Stainless Steel w/ Nickel Plate | ■ (Non-hermetic connectors), Nickel plated, corrosion resistant steel, firewall capability, 500 hour salt spray, 200°, EMI shielding -65dB @ 10GHz specification min.                        |
|           |           |               |               |               | YN        | YN        |            | N                      | Stainless Steel w/ Nickel Plate | ■ (Hermetic connectors), Nickel plated corrosion resistant steel, 200°C                                                                                                                      |
| DT        | DT        |               |               |               |           |           |            | T                      | Durmalon plated                 | ■ Nickel-PTFE alternative to Cadmium. Corrosion resistant, 500 hour salt spray, EMI -50dB at 10GHz specification min., 175°C                                                                 |
| DZ        | DZ        |               |               |               |           |           |            | Z                      | Zinc-Nickel Plated              | TBD<br>Zinc-Nickel Alternative to Cadmium, corrosion resistant, 500 hour salt spray, Conductive, -65°C to +175°C, EMI Shielding -50 dB @ 10 GHz specification min.                           |

\* Consult Amphenol Aerospace for availability. \*\*Coaxial arrangements are not available in these classes.

### Quadrax or Differential Twinax:

The incorporation of Quadrax or Differential Twinax contacts requires a modified connector to accommodate keyed contacts.

\* D38999/26KJ20PN, is a series III stainless steel plug with twin axial and coaxial contacts that may not meet the firewall requirement of the specification. D38999/26KJ61HN, is a series III stainless steel plug with high durability contacts. However, the connector will be limited to 500 cycles of durability. Insert arrangements using multi-axial (i.e. coax, twinax, triax shielded) contacts should not be used in firewall applications.

### Step 4. Select a Shell Size & Insert Arrangement see pages 6-9

| Double Start Threads | Triple Start Threads |   |    |    |    |    |    |    |    |    | Mil Shell Size      |
|----------------------|----------------------|---|----|----|----|----|----|----|----|----|---------------------|
|                      | A                    | B | C  | D  | E  | F  | G  | H  | J  |    |                     |
| 7                    | 7H                   | 9 | 11 | 13 | 15 | 17 | 19 | 21 | 23 | 25 | Amphenol Shell size |

|                   |                |                  |                            |                 |                       |                       |
|-------------------|----------------|------------------|----------------------------|-----------------|-----------------------|-----------------------|
| 1. Connector Type | 2. Shell Style | 3. Service Class | 4. Shell Size-Insert Arrg. | 5. Contact Type | 6. Alternate Position | 7. Special Variations |
|                   |                |                  | 23-2                       |                 |                       |                       |

Shell Size & Insert Arrangement are on pages 6-9. First number represents Shell Size, second number is the Insert Arrangement.

\* Size 7 and 7H are Double Start Threads only

### Step 5. Select a Contact Type

|          | Designates                                                                                           |
|----------|------------------------------------------------------------------------------------------------------|
| <b>P</b> | Pin Contacts                                                                                         |
| <b>S</b> | Socket Contacts                                                                                      |
| <b>H</b> | 1500 Cycle Pin Contacts                                                                              |
| <b>J</b> | 1500 Cycle Socket Contacts                                                                           |
| <b>A</b> | Same as "P" except supplied less pin Contacts                                                        |
| <b>B</b> | Same as "S" except supplied less socket contacts ( A & B designate nonstandard contact applications) |
| <b>X</b> | Eyelet contacts, hermetics only                                                                      |

### Step 6. Select an Alternate Keying Position

#### Key/Keyway Position

| Shell Size      | Key & Keyway Arrangement Identification Letter | AR° or AP° BSC | BR° or BP° BSC | CR° or CP° BSC | DR° or DP° BSC |
|-----------------|------------------------------------------------|----------------|----------------|----------------|----------------|
| 7, 7H           | <b>N*</b>                                      | 120            | 240            |                |                |
|                 | <b>A</b>                                       | 132            | 248            |                |                |
|                 | <b>B</b>                                       | 80             | 230            | NA             | NA             |
|                 | <b>C</b>                                       | 140            | 275            |                |                |
|                 | <b>D</b>                                       | 155            | 234            |                |                |
| 9               | <b>N*</b>                                      | 105            | 140            | 215            | 265            |
|                 | <b>A</b>                                       | 102            | 132            | 248            | 320            |
|                 | <b>B</b>                                       | 80             | 118            | 230            | 312            |
|                 | <b>C</b>                                       | 35             | 140            | 205            | 275            |
|                 | <b>D</b>                                       | 64             | 155            | 234            | 304            |
| 11, 13, and 15  | <b>N*</b>                                      | 95             | 141            | 208            | 236            |
|                 | <b>A</b>                                       | 113            | 156            | 182            | 292            |
|                 | <b>B</b>                                       | 90             | 145            | 195            | 252            |
|                 | <b>C</b>                                       | 53             | 156            | 220            | 255            |
|                 | <b>D</b>                                       | 119            | 146            | 176            | 298            |
| 17 and 19       | <b>N*</b>                                      | 80             | 142            | 196            | 293            |
|                 | <b>A</b>                                       | 135            | 170            | 200            | 310            |
|                 | <b>B</b>                                       | 49             | 169            | 200            | 244            |
|                 | <b>C</b>                                       | 66             | 140            | 200            | 257            |
|                 | <b>D</b>                                       | 62             | 145            | 180            | 280            |
| 21, 23, and 25  | <b>N*</b>                                      | 80             | 142            | 196            | 293            |
|                 | <b>A</b>                                       | 135            | 170            | 200            | 310            |
|                 | <b>B</b>                                       | 49             | 169            | 200            | 244            |
|                 | <b>C</b>                                       | 66             | 140            | 200            | 257            |
|                 | <b>D</b>                                       | 62             | 145            | 180            | 280            |
| 25L, 33, and 37 | <b>N*</b>                                      | 80             | 142            | 188            | 293            |
|                 | <b>A</b>                                       | 135            | 170            | 188            | 310            |
|                 | <b>B</b>                                       | 49             | 169            | 188            | 244            |
|                 | <b>C</b>                                       | 66             | 140            | 188            | 257            |
|                 | <b>D</b>                                       | 62             | 145            | 188            | 280            |
|                 | <b>E</b>                                       | 79             | 153            | 197            | 272            |

\* An "N" designation is used on D38999 military part number but not on the commercial versions

### Step 7. Special Variations

Consult Amphenol Aerospace for variations.

| 1.             | 2.          | 3.            | 4.                     | 5.           | 6.                 | 7.                 |
|----------------|-------------|---------------|------------------------|--------------|--------------------|--------------------|
| Connector Type | Shell Style | Service Class | Shell Size-Insert Arr. | Contact Type | Alternate Position | Special Variations |
|                |             |               |                        | P            | B                  |                    |

A plug with a given rotation letter will mate with a receptacle with the same rotation letter. The angles for a given connector are the same whether it contains pins or sockets. Master key stays fixed, minor keys rotate. Inserts are not rotated in conjunction with the master key/keyway.

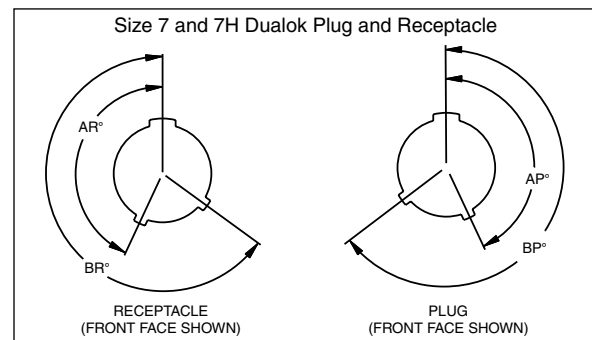
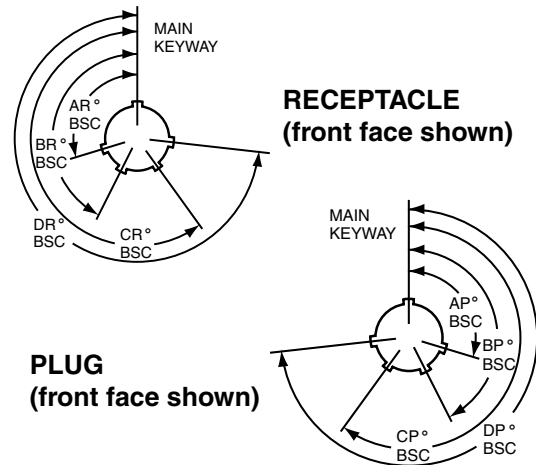

38999

- III
- HD
- Dualok
- II
- I
- SJT
- Accessories
- Aquacon
- Herm/Seal
- PCB

- HIGH SPEED
- Fiber Optics
- Contacts
- Connectors
- Cables

EMI Filter  
Transient

26482  
Matrix 2

83723 III  
Matrix | Pyle

26500  
Pyle

5015  
Crmp Rear Release Matrix

22992  
Class 1

Back-Shell's

Options  
Others

| 1.             | 2.          | 3.            | 4.                     | 5.           | 6.                 | 7.                 |
|----------------|-------------|---------------|------------------------|--------------|--------------------|--------------------|
| Connector Type | Shell Style | Service Class | Shell Size-Insert Arr. | Contact Type | Alternate Position | Special Variations |
|                |             |               |                        |              |                    | (xxx)              |

38999

### Easy Steps to build a part number... Boeing BACC63 CT & CU

1. 2. 3. 4. 5. 6. 7. 8.

| Boeing Basic Number | Style | Shell Size | Shell Finish & Contact | Insert Arrangement | Contact Type | Alternate Keying Position | Ordering Option |
|---------------------|-------|------------|------------------------|--------------------|--------------|---------------------------|-----------------|
| BACC63              | CT    | 15         | —                      | 19                 | P            | N                         | H               |

## Composite

**Step 1. Boeing Number BACC63**

**Step 2. Select a Style**

|    | Designates           |
|----|----------------------|
| CT | Composite Plug       |
| CU | Composite Receptacle |

**Step 3. Shell Size 15**

|    | Designates     |
|----|----------------|
| 15 | One Shell Size |

**Step 4. Select a Shell Finish & Contact**

|   | Designates                              |
|---|-----------------------------------------|
| C | CT Style Only. Cadmium Plated, Grounded |
| D | Cadmium Plated, ungrounded              |
| G | Nickel Plated, Grounded                 |
| — | Nickel Plated, Ungrounded               |

**Step 5. Insert Arrangements-**  
Consult Amphenol Aerospace for insert arrangements available.

**Step 6. Select a Contact Type**

|   | Designates |
|---|------------|
| P | Pin        |
| S | Socket     |

**Step 7. Select an Alternate Keying Position**

|     | Designates |
|-----|------------|
| N   | Normal     |
| A-E | Alternates |

**Step 8. Ordering Option**

|       | Designates                    |
|-------|-------------------------------|
| H     | Without Contacts & Seal Plugs |
| Blank | With Contacts & Seal Plugs    |

### Easy Steps to build a part number... Boeing BACC63 DB & DC

1. 2. 3. 4. 5. 6. 7. 8.

| Boeing Basic Number | Style | Shell Size | Separator | Insert Arrangement | Contact Type | Alternate Keying Position | Ordering Option |
|---------------------|-------|------------|-----------|--------------------|--------------|---------------------------|-----------------|
| BACC63              | DB    | 15         | —         | 19                 | P            | N                         | H               |
| BACC63              | DC    | 17         | —         | 8                  | P            | N                         | H               |

## Stainless Steel

**Step 1. Boeing Number BACC63**

**Step 2. Select a Style**

|    | Designates                 |
|----|----------------------------|
| DB | Stainless Steel Plug       |
| DC | Stainless Steel Receptacle |

**Step 3. Select a Shell Size**

|      | Designates |
|------|------------|
| 9-25 | Shell Size |

**Step 4. Separator**

|   | Designates |
|---|------------|
| — | Separator  |

**Step 5. Insert Arrangements-**  
Consult Amphenol Aerospace for insert arrangements available.

**Step 7. Select an Alternate Keying Position**

|     | Designates |
|-----|------------|
| N   | Normal     |
| A-E | Alternates |

**Step 8. Ordering Option**

|       | Designates                    |
|-------|-------------------------------|
| H     | Without Contacts & Seal Plugs |
| Blank | With Contacts & Seal Plugs    |

**Step 6. Select a Contact Type**

|   | Designates |
|---|------------|
| P | Pin        |
| S | Socket     |



# TVP00R (D38999/20) - Crimp, Metal CTVP00R (D38999/20) - Crimp, Composite

## Wall Mounting Receptacle

### PART #

To complete, see how to order pages 25-27.

| Connector Type | Shell Style | Service Class | Shell Size & Insert Arr | Contact Type | Alternate Position | Special Variations |
|----------------|-------------|---------------|-------------------------|--------------|--------------------|--------------------|
| TVP            | 00          | RW            | 9-35                    | P            | B                  | (453)              |
| TVPS           | 00          | RK            | X-X                     | X            | X                  | (XXX)              |
| TVPS           | 00          | RF            | X-X                     | X            | X                  | (XXX)              |
| TVPS           | 00          | RS            | X-X                     | X            | X                  | (XXX)              |
| CTVP           | 00          | RW            | X-X                     | X            | X                  | (XXX)              |
| CTVPS          | 00          | RF            | X-X                     | X            | X                  | (XXX)              |
| D38999/        | 20          | X             | X-X                     | X            | X                  | NA                 |



VIEW D FOR SIZE 8 COAXIAL ONLY, RELATIVE TO -A-

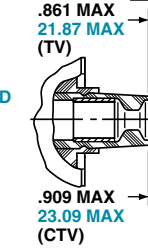

PANEL HOLE DIMENSIONS

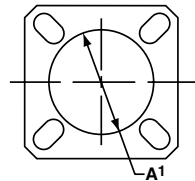

BACK PANEL MOUNTING

VIEW D FOR SIZE 8 TWINAX ONLY, RELATIVE TO -A-

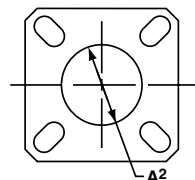
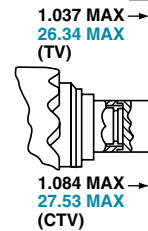

FRONT PANEL MOUNTING

† Red band indicates fully mated

†† Blue band indicates rear release contact retention system

| Shell Size | MS Shell Size Code | B Thread Class 2A 0.1P=0.3L-TS (Plated) | L Max. (TV) | L' Max. (CTV) | M +.000 - .005 (TV) | M' +.000 - .005 (CTV) | R <sup>1</sup> | R <sup>2</sup> | S Max. | T ±.008 | Z Max. (TV) | Z' Max. (CTV) | A <sup>1</sup> Back Panel Mount | A <sup>2</sup> Front Panel Mount | AA Max. Panel Thickness | LL +.006 - .000 (TV) | LL1 ±.005 (CTV) | TT ±.008 |
|------------|--------------------|-----------------------------------------|-------------|---------------|---------------------|-----------------------|----------------|----------------|--------|---------|-------------|---------------|---------------------------------|----------------------------------|-------------------------|----------------------|-----------------|----------|
| 9          | A                  | .6250                                   | .469        | .514          | .820                | .773                  | .719           | .594           | .948   | .128    | .153        | .198          | .650                            | .510                             | .234                    | .905                 | .908            | .216     |
| 11         | B                  | .7500                                   | .469        | .514          | .820                | .773                  | .812           | .719           | 1.043  | .128    | .153        | .198          | .800                            | .620                             | .234                    | .905                 | .908            | .194     |
| 13         | C                  | .8750                                   | .469        | .514          | .820                | .773                  | .906           | .812           | 1.137  | .128    | .153        | .198          | .910                            | .740                             | .234                    | .905                 | .908            | .194     |
| 15         | D                  | 1.0000                                  | .469        | .514          | .820                | .773                  | .969           | .906           | 1.232  | .128    | .153        | .198          | 1.040                           | .900                             | .234                    | .905                 | .908            | .173     |
| 17         | E                  | 1.1875                                  | .469        | .514          | .820                | .773                  | 1.062          | .969           | 1.323  | .128    | .153        | .198          | 1.210                           | 1.010                            | .234                    | .905                 | .908            | .194     |
| 19         | F                  | 1.2500                                  | .469        | .514          | .820                | .773                  | 1.156          | 1.062          | 1.449  | .128    | .153        | .198          | 1.280                           | 1.130                            | .234                    | .905                 | .908            | .194     |
| 21         | G                  | 1.3750                                  | .500        | .545          | .790                | .741                  | 1.250          | 1.156          | 1.575  | .128    | .183        | .228          | 1.410                           | 1.250                            | .204                    | .905                 | .904            | .194     |
| 23         | H                  | 1.5000                                  | .500        | .545          | .790                | .741                  | 1.375          | 1.250          | 1.701  | .154    | .183        | .228          | 1.530                           | 1.360                            | .204                    | .905                 | .904            | .242     |
| 25         | J                  | 1.6250                                  | .500        | .545          | .790                | .741                  | 1.500          | 1.375          | 1.823  | .154    | .183        | .228          | 1.660                           | 1.470                            | .204                    | .905                 | .904            | .242     |

Inches

| Shell Size | MS Shell Size Code | L Max. (TV) | L' Max. (CTV) | M +.00 - .13 (TV) | M' +.00 - .13 (CTV) | R <sup>1</sup> | R <sup>2</sup> | S Max. | T ±.20 | V Thread Metric | Z Max. (TV) | Z' Max. (CTV) | A <sup>1</sup> Back Panel Mount | A <sup>2</sup> Front Panel Mount | AA Max. | LL +.15 - .00 (TV) | LL1 ±.13 (CTV) | TT ±.20 |
|------------|--------------------|-------------|---------------|-------------------|---------------------|----------------|----------------|--------|--------|-----------------|-------------|---------------|---------------------------------|----------------------------------|---------|--------------------|----------------|---------|
| 9          | A                  | 11.91       | 13.06         | 20.83             | 19.63               | 18.26          | 15.09          | 24.1   | 3.25   | M12X1-6g        | 3.89        | 5.03          | 16.66                           | 13.11                            | 5.94    | 22.99              | 23.06          | 5.49    |
| 11         | B                  | 11.91       | 13.06         | 20.83             | 19.63               | 20.62          | 18.26          | 26.5   | 3.25   | M15X1-6g        | 3.89        | 5.03          | 20.22                           | 15.88                            | 5.94    | 22.99              | 23.06          | 4.93    |
| 13         | C                  | 11.91       | 13.06         | 20.83             | 19.63               | 23.01          | 20.62          | 28.9   | 3.25   | M18X1-6g        | 3.89        | 5.03          | 23.42                           | 19.05                            | 5.94    | 22.99              | 23.06          | 4.93    |
| 15         | D                  | 11.91       | 13.06         | 20.83             | 19.63               | 24.61          | 23.01          | 31.3   | 3.25   | M22X1-6g        | 3.89        | 5.03          | 26.59                           | 23.01                            | 5.94    | 22.99              | 23.06          | 4.39    |
| 17         | E                  | 11.91       | 13.06         | 20.83             | 19.63               | 26.97          | 24.61          | 33.7   | 3.25   | M25X1-6g        | 3.89        | 5.03          | 30.96                           | 25.81                            | 5.94    | 22.99              | 23.06          | 4.93    |
| 19         | F                  | 11.91       | 13.06         | 20.83             | 19.63               | 29.36          | 26.97          | 36.9   | 3.25   | M28X1-6g        | 3.89        | 5.03          | 32.94                           | 28.98                            | 5.94    | 22.99              | 23.06          | 4.93    |
| 21         | G                  | 12.70       | 13.84         | 20.07             | 18.82               | 31.75          | 29.36          | 40.1   | 3.25   | M31X1-6g        | 4.65        | 5.79          | 36.12                           | 32.16                            | 5.18    | 22.99              | 22.96          | 4.93    |
| 23         | H                  | 12.70       | 13.84         | 20.07             | 18.82               | 34.93          | 31.75          | 43.3   | 3.91   | M34X1-6g        | 4.65        | 5.79          | 39.29                           | 34.93                            | 5.18    | 22.99              | 22.96          | 6.15    |
| 25         | J                  | 12.70       | 13.84         | 20.07             | 18.82               | 38.10          | 34.93          | 46.4   | 3.91   | M37X1-6g        | 4.65        | 5.79          | 42.47                           | 37.69                            | 5.18    | 22.99              | 22.96          | 6.15    |

Millimeters

All dimensions for reference only

Designates true position dimensioning

38999

- III
- HD
- Dualok
- II
- I
- SJT
- Accessories
- Aquacon
- Herm/Seal
- PCB

- HIGH SPEED
- Fiber Optics
- Contacts Connectors Cables

- EMI Filter Transient
- Matrix 2
- 26482
- 83723 III

- Matrix 1 Pyle
- 26500
- Pyle

- 5015
- Crimp Rear Release Matrix
- 22992
- Class 1

- Back-Shell's
- Options Others

### Box Mounting Receptacle

38999

- III
- HD
- Dualok
- II
- I
- SJT
- Accessories
- Aquacon
- Herm/Seal
- PCB

- HIGH SPEED
- Fiber Optics
- Contacts
- Connectors
- Cables

- EMI Filter
- Transient

- 26482
- Matrix 2

- 83723 III
- Matrix (Pyle)

- 26500
- Pyle

- 5015
- Crimp Rear Release Matrix

- 22992
- Class I

- Back-Shells

- Options
- Others

#### PART #

To complete, see how to order pages 25-27.

| Connector Type | Shell Style | Service Class | Shell Size & Insert Arrg | Contact Type | Alternate Position | Special Variations |
|----------------|-------------|---------------|--------------------------|--------------|--------------------|--------------------|
| TVP            | 02          | RW            | 9-35                     | P            | B                  | (453)              |
| TVPS           | 02          | RK            | X-X                      | X            | X                  | (XXX)              |
| TVPS           | 02          | RF            | X-X                      | X            | X                  | (XXX)              |
| TVPS           | 02          | RS            | X-X                      | X            | X                  | (XXX)              |
| CTVP           | 02          | RW            | X-X                      | X            | X                  | (XXX)              |
| CTVPS          | 02          | RF            | X-X                      | X            | X                  | (XXX)              |

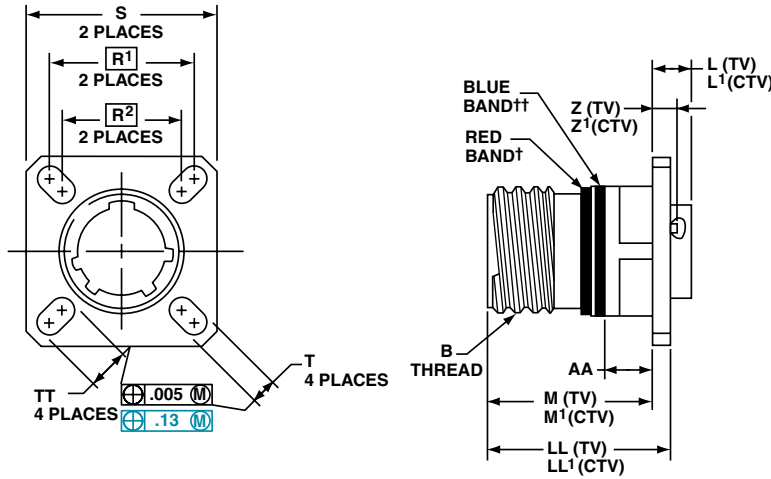

#### PANEL HOLE DIMENSIONS

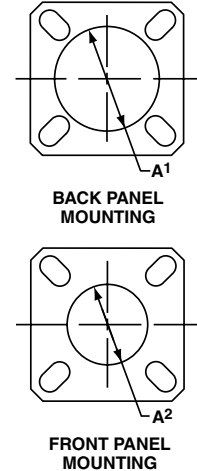

† Red band indicates fully mated

†† Blue band indicates rear release contact retention system

Consult Amphenol Aerospace for availability of composite box mount receptacles.

Inches

| Shell Size | MS Shell Size Code | B Thread Class 2A 0.1P=0.3L-TS (Plated) | L Max. (TV) | L' Max. (CTV) | M +.000 - .005 (TV) | M' +.000 - .005 (CTV) | R <sup>1</sup> | R <sup>2</sup> | S Max. | T ±.008 | Z Max. (TV) | Z' Max. (CTV) | A <sup>1</sup> Back Panel Mount | A <sup>2</sup> Front Panel Mount | AA Max. Panel Thickness | LL +.006 - .000 (TV) | LL1 ±.005 (CTV) | TT ±.008 |
|------------|--------------------|-----------------------------------------|-------------|---------------|---------------------|-----------------------|----------------|----------------|--------|---------|-------------|---------------|---------------------------------|----------------------------------|-------------------------|----------------------|-----------------|----------|
| 9          | A                  | .6250                                   | .205        | .250          | .820                | .773                  | .719           | .594           | .948   | .128    | .153        | .198          | .650                            | .510                             | .234                    | .905                 | .908            | .216     |
| 11         | B                  | .7500                                   | .205        | .250          | .820                | .773                  | .812           | .719           | 1.043  | .128    | .153        | .198          | .800                            | .620                             | .234                    | .905                 | .908            | .194     |
| 13         | C                  | .8750                                   | .205        | .250          | .820                | .773                  | .906           | .812           | 1.137  | .128    | .153        | .198          | .910                            | .740                             | .234                    | .905                 | .908            | .194     |
| 15         | D                  | 1.0000                                  | .205        | .250          | .820                | .773                  | .969           | .906           | 1.232  | .128    | .153        | .198          | 1.040                           | .900                             | .234                    | .905                 | .908            | .173     |
| 17         | E                  | 1.1875                                  | .205        | .250          | .820                | .773                  | 1.062          | .969           | 1.323  | .128    | .153        | .198          | 1.210                           | 1.010                            | .234                    | .905                 | .908            | .194     |
| 19         | F                  | 1.2500                                  | .205        | .250          | .820                | .773                  | 1.156          | 1.062          | 1.449  | .128    | .153        | .198          | 1.280                           | 1.130                            | .234                    | .905                 | .908            | .194     |
| 21         | G                  | 1.3750                                  | .235        | .280          | .790                | .741                  | 1.250          | 1.156          | 1.575  | .128    | .183        | .228          | 1.410                           | 1.250                            | .204                    | .905                 | .904            | .194     |
| 23         | H                  | 1.5000                                  | .235        | .280          | .790                | .741                  | 1.375          | 1.250          | 1.701  | .154    | .183        | .228          | 1.530                           | 1.360                            | .204                    | .905                 | .904            | .242     |
| 25         | J                  | 1.6250                                  | .235        | .280          | .790                | .741                  | 1.500          | 1.375          | 1.823  | .154    | .183        | .228          | 1.660                           | 1.470                            | .204                    | .905                 | .904            | .242     |

Millimeters

| Shell Size | MS Shell Size Code | L Max. (TV) | L' Max. (CTV) | M +.00 - .13 (TV) | M' +.00 - .13 (CTV) | R <sup>1</sup> | R <sup>2</sup> | S Max. | T ±.20 | Z Max. (TV) | Z' Max. (CTV) | A <sup>1</sup> Back Panel Mount | A <sup>2</sup> Front Panel Mount | AA Max. | LL +.15 - .00 (TV) | LL1 ±.13 (CTV) | TT ±.20 |
|------------|--------------------|-------------|---------------|-------------------|---------------------|----------------|----------------|--------|--------|-------------|---------------|---------------------------------|----------------------------------|---------|--------------------|----------------|---------|
| 9          | A                  | 5.21        | 6.35          | 20.83             | 19.63               | 18.26          | 15.09          | 24.1   | 3.25   | 3.89        | 5.03          | 16.66                           | 13.11                            | 5.94    | 22.99              | 23.06          | 5.49    |
| 11         | B                  | 5.21        | 6.35          | 20.83             | 19.63               | 20.62          | 18.26          | 26.5   | 3.25   | 3.89        | 5.03          | 20.22                           | 15.88                            | 5.94    | 22.99              | 23.06          | 4.93    |
| 13         | C                  | 5.21        | 6.35          | 20.83             | 19.63               | 23.01          | 20.62          | 28.9   | 3.25   | 3.89        | 5.03          | 23.42                           | 19.05                            | 5.94    | 22.99              | 23.06          | 4.93    |
| 15         | D                  | 5.21        | 6.35          | 20.83             | 19.63               | 24.61          | 23.01          | 31.3   | 3.25   | 3.89        | 5.03          | 26.59                           | 23.01                            | 5.94    | 22.99              | 23.06          | 4.39    |
| 17         | E                  | 5.21        | 6.35          | 20.83             | 19.63               | 26.97          | 24.61          | 33.7   | 3.25   | 3.89        | 5.03          | 30.96                           | 25.81                            | 5.94    | 22.99              | 23.06          | 4.93    |
| 19         | F                  | 5.21        | 6.35          | 20.83             | 19.63               | 29.36          | 26.97          | 36.9   | 3.25   | 3.89        | 5.03          | 32.94                           | 28.98                            | 5.94    | 22.99              | 23.06          | 4.93    |
| 21         | G                  | 5.97        | 7.11          | 20.07             | 18.82               | 31.75          | 29.36          | 40.1   | 3.25   | 4.65        | 5.79          | 36.12                           | 32.16                            | 5.18    | 22.99              | 22.96          | 4.93    |
| 23         | H                  | 5.97        | 7.11          | 20.07             | 18.82               | 34.92          | 31.75          | 43.3   | 3.91   | 4.65        | 5.79          | 39.29                           | 34.93                            | 5.18    | 22.99              | 22.96          | 6.15    |
| 25         | J                  | 5.97        | 7.11          | 20.07             | 18.82               | 38.10          | 34.92          | 46.4   | 3.91   | 4.65        | 5.79          | 42.47                           | 37.69                            | 5.18    | 22.99              | 22.96          | 6.15    |

All dimensions for reference only

Designates true position dimensioning

## Straight Plug

### PART #

To complete, see how to order pages 25-27.

| Connector Type | Shell Style | Service Class | Shell Size & Insert Arrg | Contact Type | Alternate Position | Special Variations |
|----------------|-------------|---------------|--------------------------|--------------|--------------------|--------------------|
| TV             | 06          | RW            | 9-35                     | P            | B                  | (453)              |
| TVS            | 06          | RK            | X-X                      | X            | X                  | (XXX)              |
| TVS            | 06          | RF            | X-X                      | X            | X                  | (XXX)              |
| TVS            | 06          | RS            | X-X                      | X            | X                  | (XXX)              |
| CTV            | 06          | RW            | X-X                      | X            | X                  | (XXX)              |
| CTVS           | 06          | RF            | X-X                      | X            | X                  | (XXX)              |
| D38999/        | 26          | X             | X-X                      | X            | X                  | NA                 |



† Blue band indicates rear release contact retention system

Inches

| Shell Size | MS Shell Size Code | B Thread<br>0.1P-0.3L-TS-2B<br>(Plated) | Q Dia. Max. |
|------------|--------------------|-----------------------------------------|-------------|
| 9          | A                  | .6250                                   | .858        |
| 11         | B                  | .7500                                   | .984        |
| 13         | C                  | .8750                                   | 1.157       |
| 15         | D                  | 1.0000                                  | 1.280       |
| 17         | E                  | 1.1875                                  | 1.406       |
| 19         | F                  | 1.2500                                  | 1.516       |
| 21         | G                  | 1.3750                                  | 1.642       |
| 23         | H                  | 1.5000                                  | 1.768       |
| 25         | J                  | 1.6250                                  | 1.890       |

All dimensions for reference only.

Millimeters

| Shell Size | MS Shell Size Code | Q Max. | V Thread Metric |
|------------|--------------------|--------|-----------------|
| 9          | A                  | 21.8   | M12X1-6g        |
| 11         | B                  | 25.0   | M15X1-6g        |
| 13         | C                  | 29.4   | M18X1-6g        |
| 15         | D                  | 32.5   | M22X1-6g        |
| 17         | E                  | 35.7   | M25X1-6g        |
| 19         | F                  | 38.5   | M28X1-6g        |
| 21         | G                  | 41.7   | M31X1-6g        |
| 23         | H                  | 44.9   | M34X1-6g        |
| 25         | J                  | 48.0   | M37X1-6g        |

38999

|             |
|-------------|
| III         |
| HD          |
| Dualok      |
| II          |
| I           |
| SJT         |
| Accessories |
| Aquacon     |
| Herm/Seal   |
| PCB         |

|              |
|--------------|
| HIGH SPEED   |
| Fiber Optics |
| Contacts     |
| Connectors   |
| Cables       |

EMI Filter  
Transient

26482  
Matrix 2

83723 III  
Matrix | Pyle

26500  
Pyle

5015  
Crimp Rear  
Release  
Matrix

22992  
Class 1

Back-Shell's

Options  
Others

**For High Vibration Applications**

38999

**PART #**

To complete, see how to order pages 25-27.

| Connector Type | Shell Style | Service Class | Shell Size & Insert Arrg | Contact Type | Alternate Position | Special Variations |
|----------------|-------------|---------------|--------------------------|--------------|--------------------|--------------------|
| TV             | 26          | RK            | 9-35                     | P            | N                  | (453)              |
| TV             | 26          | RS            | X-X                      | X            | N                  | (XXX)              |
| MTV            | 26          | RK            | X-X                      | X            | N                  | (XXX)              |
| MTV            | 26          | RS            | X-X                      | X            | N                  | (XXX)              |

For parts with MS Stamping use MTV26( ) part number as shown above.

Designed for high vibration and harsh environments such as aircraft gas turbine engines, the CLUTCH-LOK is also an ideal choice for demanding applications such as aircraft, space and military ground vehicles. The unique clutch design of the Amphenol CLUTCH-LOK means that you don't have to compromise the need for quick, smooth mating of plugs and receptacles in order to get increased uncoupling torque.

The CLUTCH-LOK has proven to not only remain mated and pass all the Series III specification requirements, it also has proven to actually tighten itself under vibration. This is a powerful advantage over the traditionally high vibration application connectors. The CLUTCH-LOK is also a tremendous advantage in inaccessible, hard to reach areas where mating torque is difficult to apply and complete coupling is not verifiable by inspection.

**CLUTCH-LOK features and benefits:**

- High degree of differential torque
- Infinite free coupling and positive metal-to-metal bottoming with each mating
- No settling back to the next ratchet tooth
- Available with stainless steel shells and Class K firewall inserts
- All the advantages of MIL-DTL-38999 Series III including EMI/RFI shielding, electrolytic erosion resistance and contact protection with recessed pins
- Enhanced connector performance at affordable prices
- Completely intermateable with all existing MIL-DTL-38999 Series III connectors
- Fully QPL'd

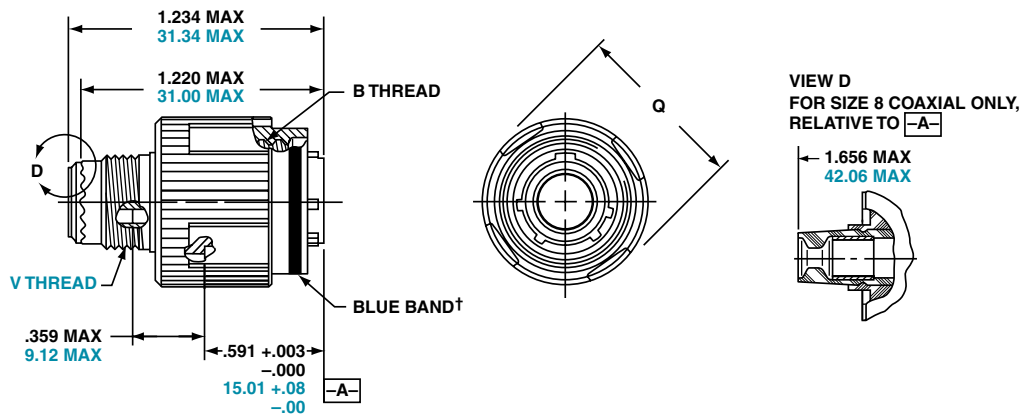

† Blue band indicates rear release contact retention system

Inches

| Shell Size | MS Shell Size Code | B Thread 0.1P-0.3L-TS-2B (Plated) | Q Dia. Max. |
|------------|--------------------|-----------------------------------|-------------|
| 9          | A                  | .6250                             | .858        |
| 11         | B                  | .7500                             | .984        |
| 13         | C                  | .8750                             | 1.157       |
| 15         | D                  | 1.0000                            | 1.280       |
| 17         | E                  | 1.1875                            | 1.406       |
| 19         | F                  | 1.2500                            | 1.516       |
| 21         | G                  | 1.3750                            | 1.642       |
| 23         | H                  | 1.5000                            | 1.768       |
| 25         | J                  | 1.6250                            | 1.890       |

Millimeters

| Shell Size | MS Shell Size Code | Q Max. | V Thread Metric |
|------------|--------------------|--------|-----------------|
| 9          | A                  | 21.8   | M12X1-6g        |
| 11         | B                  | 25.0   | M15X1-6g        |
| 13         | C                  | 29.4   | M18X1-6g        |
| 15         | D                  | 32.5   | M22X1-6g        |
| 17         | E                  | 35.7   | M25X1-6g        |
| 19         | F                  | 38.5   | M28X1-6g        |
| 21         | G                  | 41.7   | M31X1-6g        |
| 23         | H                  | 44.9   | M34X1-6g        |
| 25         | J                  | 48.0   | M37X1-6g        |

All dimensions for reference only.

- III
- HD
- Dualok
- II
- I
- SJT
- Accessories
- Aquacon
- Herm/Seal
- PCB

- HIGH SPEED
- Fiber Optics
- Contacts Connectors Cables

- EMI Filter Transient

- 26482 Matrix 2

- 83723 III Matrix (Pyle)

- 26500 Pyle

- 5015 Crimp Rear Release Matrix

- 22992 Class L

- Back-Shells

- Options Others

# TV07R (D38999/24) – Crimp, Metal CTV07R (D38999/24) – Crimp, Composite

## Jam Nut Receptacle

### PART #

To complete, see how to order pages 25-27.

| Connector Type | Shell Style | Service Class | Shell Size & Insert Arr | Contact Type | Alternate Position | Special Variations |
|----------------|-------------|---------------|-------------------------|--------------|--------------------|--------------------|
| TV             | 07          | RW            | 9-35                    | P            | B                  | (453)              |
| TVS            | 07          | RK            | X-X                     | X            | X                  | (XXX)              |
| TVS            | 07          | RF            | X-X                     | X            | X                  | (XXX)              |
| TVS            | 07          | RS            | X-X                     | X            | X                  | (XXX)              |
| CTV            | 07          | RW            | X-X                     | X            | X                  | (XXX)              |
| CTVS           | 07          | RF            | X-X                     | X            | X                  | (XXX)              |
| D38999/        | 24          | X             | X-X                     | X            | X                  | NA                 |

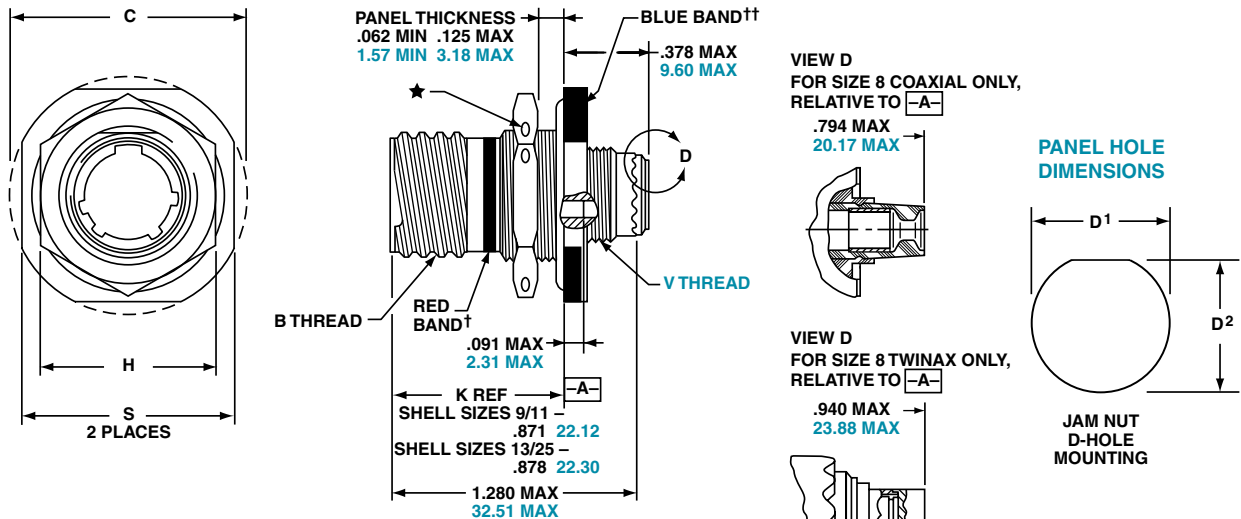

† Red band indicates fully mated

†† Blue band indicates rear release contact retention system

★ .059 dia min.

1.5 dia min., 3 lockwire holes Formed lockwire hole design (6 holes) is optional Inches

| Shell Size | MS Shell Size Code | B Thread Class 2A 0.1P-0.3L-TS (Plated) | C Max. | D <sup>1</sup> +.010 -0.000 | D <sup>2</sup> +.000 -0.010 | H Hex +.017 -0.016 | S ±.010 |
|------------|--------------------|-----------------------------------------|--------|-----------------------------|-----------------------------|--------------------|---------|
| 9          | A                  | .6250                                   | 1.199  | .693                        | .657                        | .875               | 1.062   |
| 11         | B                  | .7500                                   | 1.386  | .825                        | .770                        | 1.000              | 1.250   |
| 13         | C                  | .8750                                   | 1.511  | 1.010                       | .955                        | 1.188              | 1.375   |
| 15         | D                  | 1.0000                                  | 1.636  | 1.135                       | 1.085                       | 1.312              | 1.500   |
| 17         | E                  | 1.1875                                  | 1.761  | 1.260                       | 1.210                       | 1.438              | 1.625   |
| 19         | F                  | 1.2500                                  | 1.949  | 1.385                       | 1.335                       | 1.562              | 1.812   |
| 21         | G                  | 1.3750                                  | 2.073  | 1.510                       | 1.460                       | 1.688              | 1.938   |
| 23         | H                  | 1.5000                                  | 2.199  | 1.635                       | 1.585                       | 1.812              | 2.062   |
| 25         | J                  | 1.6250                                  | 2.323  | 1.760                       | 1.710                       | 2.000              | 2.188   |

Millimeters

| Shell Size | MS Shell Size Code | C Max. | D <sup>1</sup> +.25 -0.00 | D <sup>2</sup> +.00 -0.25 | H Hex +.43 -0.41 | S ±.25 | V Thread Metric |
|------------|--------------------|--------|---------------------------|---------------------------|------------------|--------|-----------------|
| 9          | A                  | 30.45  | 17.60                     | 16.70                     | 22.23            | 26.97  | M12X1-6g        |
| 11         | B                  | 35.20  | 20.96                     | 19.59                     | 25.40            | 31.75  | M15X1-6g        |
| 13         | C                  | 38.38  | 25.65                     | 24.26                     | 30.18            | 34.93  | M18X1-6g        |
| 15         | D                  | 41.55  | 28.83                     | 27.56                     | 33.32            | 38.10  | M22X1-6g        |
| 17         | E                  | 44.73  | 32.01                     | 30.73                     | 36.53            | 41.28  | M25X1-6g        |
| 19         | F                  | 49.50  | 35.18                     | 33.91                     | 39.67            | 46.02  | M28X1-6g        |
| 21         | G                  | 52.65  | 38.35                     | 37.08                     | 42.80            | 49.23  | M31X1-6g        |
| 23         | H                  | 55.85  | 41.53                     | 40.26                     | 46.02            | 52.37  | M34X1-6g        |
| 25         | J                  | 59.00  | 44.70                     | 43.43                     | 50.80            | 55.58  | M37X1-6g        |

All dimensions for reference only NOTE: Deep reach receptacles are available for panel thicknesses up to .750 max.

### 38999

- III
- HD
- Dualok
- II
- I
- SJT
- Accessories
- Aquacon
- Herm/Seal
- PCB

- HIGH SPEED
- Fiber Optics
- Contacts Connectors Cables

- EMI Filter
- Transient

- 26482
- Matrix 2

- 83723 III
- Matrix | Pyle

- 26500
- Pyle

- 5015
- Crimp Rear Release Matrix

- 22992
- Class 1

- Back-Shell's

- Options
- Others



### Line Receptacle

38999

- III
- HD
- Dualok
- II
- I
- SJT
- Accessories
- Aquacon
- Herm/Seal
- PCB

- HIGH SPEED
- Fiber Optics
- Contacts
- Connectors
- Cables

- EMI Filter
- Transient

- 26482
- Matrix 2

- 83723 III
- Matrix | Pyle

- 26500
- Pyle

- 5015
- Crimp Rear Release
- Matrix

- 22992
- Class 1

- Back-Shells

- Options
- Others

#### PART #

To complete, see how to order pages 25-27.

| Connector Type | Shell Style | Service Class | Shell Size & Insert Arrg | Contact Type | Alternate Position | Special Variations |
|----------------|-------------|---------------|--------------------------|--------------|--------------------|--------------------|
| TV             | 01          | RW            | 9-35                     | P            | B                  | (453)              |
| TVS            | 01          | RF            | X-X                      | X            | X                  | (XXX)              |
| CTV            | 01          | RW            | X-X                      | X            | X                  | (XXX)              |
| CTVS           | 01          | RF            | X-X                      | X            | X                  | (XXX)              |

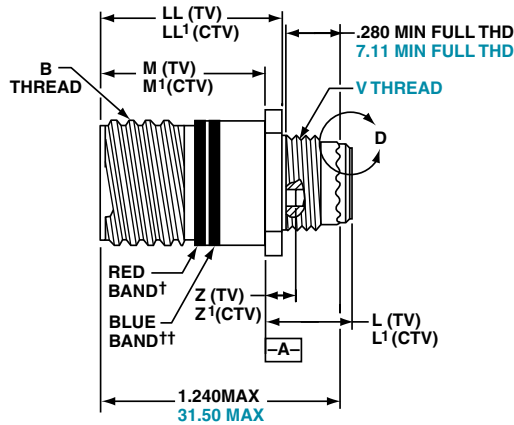
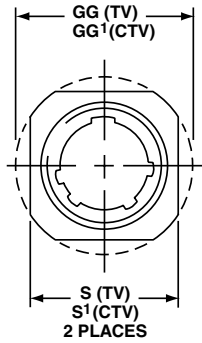

VIEW D  
FOR SIZE 8 COAXIAL ONLY,  
RELATIVE TO -A-

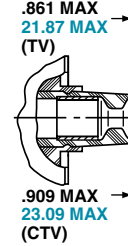

VIEW D  
FOR SIZE 8 TWINAX ONLY,  
RELATIVE TO -A-

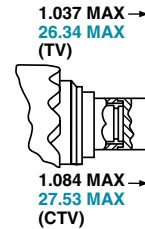

† Red band indicates fully mated  
†† Blue band indicates rear release contact retention system

Inches

| Shell Size | MS Shell Size Code | B Thread 0.1P-0.3L-TS-2A (Plated) | M +.000 - .005 (TV) | M' +.000 - .005 (CTV) | L Max. (TV) | L' Max. (CTV) | S ±.010 (TV) | S' ±.010 (CTV) | Z Max (TV) | Z' Max (CTV) | GG ±.010 (TV) | GG' ±.010 (CTV) | LL +.006 - .000 (TV) | LL' ±.005 (CTV) |
|------------|--------------------|-----------------------------------|---------------------|-----------------------|-------------|---------------|--------------|----------------|------------|--------------|---------------|-----------------|----------------------|-----------------|
| 9          | A                  | .6250                             | .820                | .773                  | .469        | .514          | .675         | .635           | .153       | .198         | .812          | .699            | .905                 | .908            |
| 11         | B                  | .7500                             | .820                | .773                  | .469        | .514          | .800         | .765           | .153       | .198         | .905          | .875            | .905                 | .908            |
| 13         | C                  | .8750                             | .820                | .773                  | .469        | .514          | .925         | .885           | .153       | .198         | 1.093         | 1.007           | .905                 | .908            |
| 15         | D                  | 1.0000                            | .820                | .773                  | .469        | .514          | 1.050        | 1.100          | .153       | .198         | 1.219         | 1.140           | .905                 | .908            |
| 17         | E                  | 1.1875                            | .820                | .773                  | .469        | .514          | 1.238        | 1.197          | .153       | .198         | 1.375         | 1.229           | .905                 | .908            |
| 19         | F                  | 1.2500                            | .820                | .773                  | .469        | .514          | 1.300        | 1.260          | .153       | .198         | 1.469         | 1.380           | .905                 | .908            |
| 21         | G                  | 1.3750                            | .790                | .741                  | .500        | .545          | 1.425        | 1.385          | .183       | .228         | 1.625         | 1.493           | .905                 | .904            |
| 23         | H                  | 1.5000                            | .790                | .741                  | .500        | .545          | 1.550        | 1.510          | .183       | .228         | 1.750         | 1.626           | .905                 | .904            |
| 25         | J                  | 1.6250                            | .790                | .741                  | .500        | .545          | 1.675        | 1.635          | .183       | .228         | 1.875         | 1.777           | .905                 | .904            |

Millimeters

| Shell Size | MS Shell Size Code | M +.00 - .013 (TV) | M' +.00 - .13 (CTV) | L Max. (TV) | L' Max. (CTV) | S ±.25 (TV) | S' ±.010 (CTV) | V Thread Metric | Z Max (TV) | Z' Max (CTV) | GG ±.25 (TV) | GG' ±.25 (CTV) | LL +.15 - .00 (TV) | LL' ±.13 (CTV) |
|------------|--------------------|--------------------|---------------------|-------------|---------------|-------------|----------------|-----------------|------------|--------------|--------------|----------------|--------------------|----------------|
| 9          | A                  | 20.83              | 19.63               | 11.91       | 13.06         | 17.15       | 16.13          | M12X1-6g        | 3.89       | 5.03         | 20.62        | 17.75          | 22.99              | 23.06          |
| 11         | B                  | 20.83              | 19.63               | 11.91       | 13.06         | 20.32       | 19.43          | M15X1-6g        | 3.89       | 5.03         | 22.99        | 22.22          | 22.99              | 23.06          |
| 13         | C                  | 20.83              | 19.63               | 11.91       | 13.06         | 23.50       | 22.47          | M18X1-6g        | 3.89       | 5.03         | 27.76        | 25.57          | 22.99              | 23.06          |
| 15         | D                  | 20.83              | 19.63               | 11.91       | 13.06         | 26.67       | 27.94          | M22X1-6g        | 3.89       | 5.03         | 30.96        | 28.95          | 22.99              | 23.06          |
| 17         | E                  | 20.83              | 19.63               | 11.91       | 13.06         | 31.45       | 30.40          | M25X1-6g        | 3.89       | 5.03         | 34.93        | 31.21          | 22.99              | 23.06          |
| 19         | F                  | 20.83              | 19.63               | 11.91       | 13.06         | 33.02       | 32.00          | M28X1-6g        | 3.89       | 5.03         | 37.31        | 35.05          | 22.99              | 23.06          |
| 21         | G                  | 20.07              | 18.82               | 12.70       | 13.84         | 36.20       | 35.18          | M31X1-6g        | 4.65       | 5.79         | 41.28        | 37.92          | 22.99              | 22.96          |
| 23         | H                  | 20.07              | 18.82               | 12.70       | 13.84         | 39.37       | 38.35          | M34X1-6g        | 4.65       | 5.79         | 44.45        | 41.30          | 22.99              | 22.96          |
| 25         | J                  | 20.07              | 18.82               | 12.70       | 13.84         | 42.55       | 41.53          | M37X1-6g        | 4.65       | 5.79         | 47.63        | 45.13          | 22.99              | 22.96          |

All dimensions for reference only

# TV09R – Crimp, Metal Flange Mounting Plug

**PART #**  
To complete, see how to  
order pages 25-27.

| Connector Type | Shell Style | Service Class | Shell Size & Insert Arrg | Contact Type | Alternate Position | Special Variations |
|----------------|-------------|---------------|--------------------------|--------------|--------------------|--------------------|
| TV             | 09          | RW            | 9-35                     | P            | B                  | (453)              |
| TVS            | 09          | RF            | X-X                      | X            | X                  | (XXX)              |

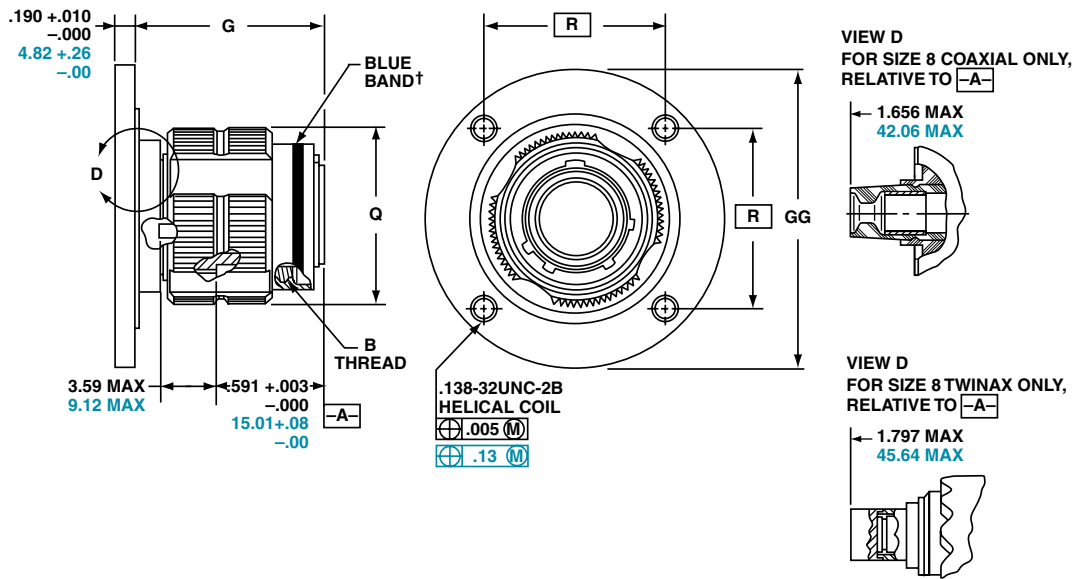

† Blue band indicates rear release contact retention system

Inches

| Shell Size | MS Shell Size Coded | B Thread 0.1P-0.3L-TS-2A (Plated) | G ±.060 | Q Dia. Max | R     | GG Dia ±.005 |
|------------|---------------------|-----------------------------------|---------|------------|-------|--------------|
| 9**        | A                   | .6250                             | 1.106   | .859       | 1.038 | 1.838        |
| 11         | B                   | .7500                             | 1.106   | .969       | 1.115 | 1.948        |
| 13**       | C                   | .8750                             | 1.106   | 1.141      | 1.240 | 2.124        |
| 15         | D                   | 1.0000                            | 1.106   | 1.266      | 1.327 | 2.248        |
| 17         | E                   | 1.1875                            | 1.106   | 1.391      | 1.417 | 2.375        |
| 19         | F                   | 1.2500                            | 1.356   | 1.500      | 1.557 | 2.495        |
| 21         | G                   | 1.3750                            | 1.356   | 1.625      | 1.624 | 2.568        |
| 23         | H                   | 1.5000                            | 1.356   | 1.750      | 1.713 | 2.723        |
| 25         | J                   | 1.6250                            | 1.356   | 1.875      | 1.801 | 2.848        |

Millimeters

| Shell Size | MS Shell Size Coded | G ±.152 | Q Dia. Max | R     | GG Dia ±.13 |
|------------|---------------------|---------|------------|-------|-------------|
| 9**        | A                   | 28.09   | 21.82      | 26.37 | 46.69       |
| 11         | B                   | 28.09   | 24.62      | 28.32 | 49.48       |
| 13**       | C                   | 28.09   | 28.98      | 31.50 | 53.95       |
| 15         | D                   | 28.09   | 32.16      | 33.71 | 57.10       |
| 17         | E                   | 28.09   | 35.33      | 35.99 | 60.33       |
| 19         | F                   | 34.44   | 38.10      | 39.55 | 63.37       |
| 21         | G                   | 34.44   | 41.28      | 41.25 | 65.23       |
| 23         | H                   | 34.44   | 44.45      | 43.51 | 69.16       |
| 25         | J                   | 34.44   | 47.63      | 45.75 | 72.34       |

All dimensions for reference only

\*\* Partially tooled. Consult Amphenol Aerospace for availability

□ Designates true position dimensioning

38999

- III
- HD
- Dualok
- II
- I
- SJT
- Accessories
- Aquacon
- Herm/Seal
- PCB

- HIGH SPEED
- Fiber Optics
- Contacts Connectors Cables

- EMI Filter
- Transient

- 26482
- Matrix 2

- 83723 III
- Matrix | Pyle

- 26500
- Pyle

- 5015
- Crimp Rear Release Matrix

- 22992
- Class 1

- Back-Shell's

- Options
- Others

38999

**PART #**

To complete, see how to order pages 25-27.

| Connector Type | Shell Style | Service Class | Shell Size & Insert Arrg | Contact Type | Alternate Position | Special Variations |
|----------------|-------------|---------------|--------------------------|--------------|--------------------|--------------------|
| TVPS           | 02          | Y             | 9-35                     | P            | B                  | (453)              |
| TVPS           | 02          | YN            | X-X                      | X            | X                  | (XXX)              |
| D38999/        | 21          | X             | X-X                      | X            | X                  | NA                 |



† Red band indicates fully mated

NOTE: Consult Amphenol Aerospace for availability of non-glass-sealed versions with printed circuit tail contacts.

Inches

| Shell Size | MS Shell Size Coded | B Thread 0.1P-0.3L-TS (Plated) | R1    | R2    | S ±.010 | T ±.008 | TT ±.008 |
|------------|---------------------|--------------------------------|-------|-------|---------|---------|----------|
| 9          | A                   | .6250                          | .719  | .594  | .938    | .128    | .216     |
| 11         | B                   | .7500                          | .812  | .719  | 1.031   | .128    | .194     |
| 13         | C                   | .8750                          | .906  | .812  | 1.125   | .128    | .194     |
| 15         | D                   | 1.0000                         | .969  | .906  | 1.219   | .128    | .173     |
| 17         | E                   | 1.1875                         | 1.062 | .969  | 1.312   | .128    | .194     |
| 19         | F                   | 1.2500                         | 1.156 | 1.062 | 1.438   | .128    | .194     |
| 21         | G                   | 1.3750                         | 1.250 | 1.156 | 1.562   | .128    | .194     |
| 23         | H                   | 1.5000                         | 1.375 | 1.250 | 1.688   | .154    | .242     |
| 25         | J                   | 1.6250                         | 1.500 | 1.375 | 1.812   | .154    | .242     |

Millimeters

| Shell Size | MS Shell Size Coded | R1    | R2    | S ±.25 | T ±.20 | TT ±.20 |
|------------|---------------------|-------|-------|--------|--------|---------|
| 9          | A                   | 18.26 | 15.09 | 23.83  | 3.25   | 5.49    |
| 11         | B                   | 20.62 | 18.26 | 26.19  | 3.25   | 4.93    |
| 13         | C                   | 23.01 | 20.62 | 28.58  | 3.25   | 4.93    |
| 15         | D                   | 24.61 | 23.01 | 30.96  | 3.25   | 4.39    |
| 17         | E                   | 26.97 | 24.61 | 33.32  | 3.25   | 4.93    |
| 19         | F                   | 29.36 | 26.97 | 36.53  | 3.25   | 4.93    |
| 21         | G                   | 31.75 | 29.36 | 39.67  | 3.25   | 4.93    |
| 23         | H                   | 34.93 | 31.75 | 42.88  | 3.91   | 6.15    |
| 25         | J                   | 38.10 | 34.93 | 46.02  | 3.91   | 6.15    |

All dimensions for reference only

  Designates true position dimensioning

# TVS07Y (D38999/23) – Hermetic

## Stainless Steel

### Jam Nut Receptacle

#### PART #

To complete, see how to order pages 25-27.

| Connector Type | Shell Style | Service Class | Shell Size & Insert Arrg | Contact Type | Alternate Position | Special Variations |
|----------------|-------------|---------------|--------------------------|--------------|--------------------|--------------------|
| TVS            | 07          | Y             | 9-35                     | P            | B                  | (453)              |
| TVS            | 07          | YN            | X-X                      | X            | X                  | (XXX)              |
| D38999/        | 23          | X             | X-X                      | X            | X                  | NA                 |

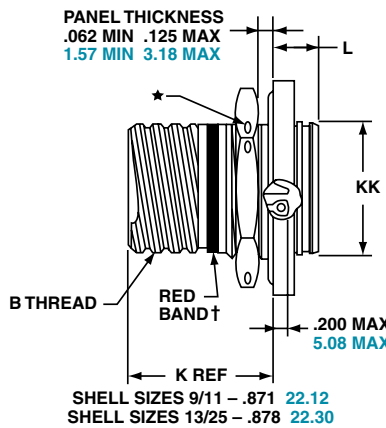
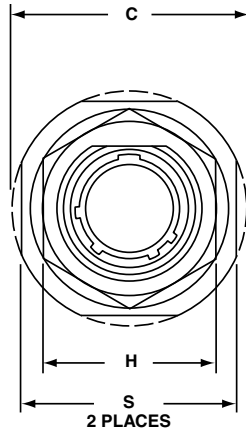

#### PANEL HOLE DIMENSIONS

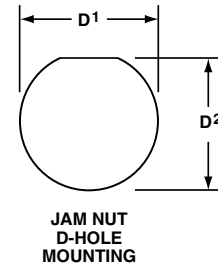

† Red band indicates fully mated

★ .059 dia min.

1.5 dia min. 3 lockwire holes

Formed lockwire hole design (6 holes) is optional.

Inches

| Shell Size | MS Shell Size code | B Thread Class 2A 0.1P-0.3L-TS (Plated) | C Max | D <sup>1</sup> +.010 - .000 | D <sup>2</sup> +.000 - .010 | H Hex +.017 - .016 | L Max | S ±.010 | KK +.011 - .000 |
|------------|--------------------|-----------------------------------------|-------|-----------------------------|-----------------------------|--------------------|-------|---------|-----------------|
| 9          | A                  | .6250                                   | 1.199 | .693                        | .657                        | .875               | .357  | 1.062   | .642            |
| 11         | B                  | .7500                                   | 1.386 | .825                        | .770                        | 1.000              | .357  | 1.250   | .766            |
| 13         | C                  | .8750                                   | 1.511 | 1.010                       | .955                        | 1.188              | .357  | 1.375   | .892            |
| 15         | D                  | 1.0000                                  | 1.636 | 1.135                       | 1.085                       | 1.312              | .357  | 1.500   | 1.018           |
| 17         | E                  | 1.1875                                  | 1.761 | 1.260                       | 1.210                       | 1.438              | .357  | 1.625   | 1.142           |
| 19         | F                  | 1.2500                                  | 1.949 | 1.385                       | 1.335                       | 1.562              | .381  | 1.812   | 1.268           |
| 21         | G                  | 1.3750                                  | 2.073 | 1.510                       | 1.460                       | 1.688              | .381  | 1.938   | 1.392           |
| 23         | H                  | 1.5000                                  | 2.199 | 1.635                       | 1.585                       | 1.812              | .381  | 2.062   | 1.518           |
| 25         | J                  | 1.6250                                  | 2.323 | 1.760                       | 1.710                       | 2.000              | .381  | 2.188   | 1.642           |

Millimeters

| Shell Size | MS Shell Size code | C Max | D <sup>1</sup> +.25 - .00 | D <sup>2</sup> +.00 - .25 | H Hex +.43 - .41 | L Max | S ±.25 | KK +.28 - .00 |
|------------|--------------------|-------|---------------------------|---------------------------|------------------|-------|--------|---------------|
| 9          | A                  | 30.45 | 17.60                     | 16.70                     | 22.23            | 9.07  | 26.97  | 16.31         |
| 11         | B                  | 35.20 | 20.96                     | 19.59                     | 25.40            | 9.07  | 31.75  | 19.46         |
| 13         | C                  | 38.38 | 25.65                     | 24.26                     | 30.18            | 9.07  | 34.93  | 22.66         |
| 15         | D                  | 41.55 | 28.83                     | 27.56                     | 33.32            | 9.07  | 38.10  | 25.86         |
| 17         | E                  | 44.73 | 32.01                     | 30.73                     | 36.53            | 9.07  | 41.28  | 29.01         |
| 19         | F                  | 49.50 | 35.18                     | 33.91                     | 39.67            | 9.68  | 46.02  | 32.21         |
| 21         | G                  | 52.65 | 38.35                     | 37.08                     | 42.80            | 9.68  | 49.23  | 35.36         |
| 23         | H                  | 55.85 | 41.53                     | 40.26                     | 46.02            | 9.68  | 52.37  | 38.56         |
| 25         | J                  | 59.00 | 44.70                     | 43.43                     | 50.80            | 9.68  | 55.58  | 41.71         |

All dimensions for reference only

38999

- III
- HD
- Dualok
- II
- I
- SJT
- Accessories
- Aquacon
- Herm/Seal
- PCB

- HIGH SPEED
- Fiber Optics
- Contacts
- Connectors
- Cables

EMI Filter  
Transient

26482  
Matrix 2

83723 III  
Matrix | Pyle

26500  
Pyle

5015  
Crmp Rear  
Release  
Matrix

22992  
Class 1

Back-  
Shells

Options  
Others

**Solder Mounting Receptacle**

38999

- III
- HD
- Dualok
- II
- I
- SJT
- Accessories
- Aquacon
- Herm/Seal
- PCB

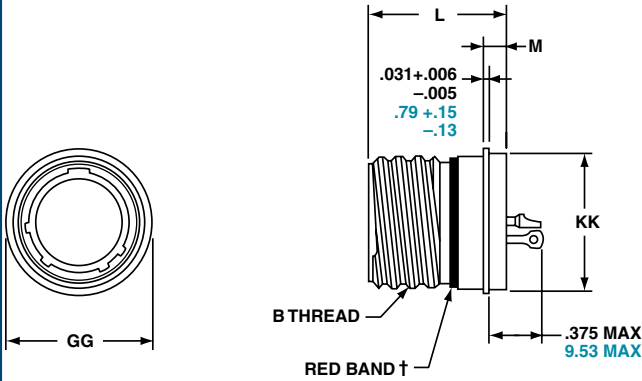

**PART #**

To complete, see how to order pages 25-27.

| Connector Type | Shell Style | Service Class | Shell Size & Insert Arrg | Contact Type | Alternate Position | Special Variations |
|----------------|-------------|---------------|--------------------------|--------------|--------------------|--------------------|
| TVS            | I           | Y             | 9-35                     | P            | B                  | (453)              |
| TVS            | I           | YN            | X-X                      | X            | X                  | (XXX)              |
| D38999/        | 25          | X             | X-X                      | X            | X                  | NA                 |

† Red band indicates fully mated

Inches

Millimeters

| Shell Size | MS Shell Size Code | B Thread Class 2A 0.1P-0.3L-TS (Plated) | L<br>+.011<br>-.005 | M<br>+.006<br>-.005 | GG Dia.<br>+.011<br>-.010 | KK Dia<br>+.011<br>-.005 |
|------------|--------------------|-----------------------------------------|---------------------|---------------------|---------------------------|--------------------------|
| 9          | A                  | .6250                                   | .806                | .125                | .750                      | .672                     |
| 11         | B                  | .7500                                   | .806                | .125                | .844                      | .781                     |
| 13         | C                  | .8750                                   | .806                | .125                | .969                      | .906                     |
| 15         | D                  | 1.0000                                  | .806                | .125                | 1.094                     | 1.031                    |
| 17         | E                  | 1.1875                                  | .806                | .125                | 1.218                     | 1.156                    |
| 19         | F                  | 1.2500                                  | .806                | .125                | 1.312                     | 1.250                    |
| 21         | G                  | 1.3750                                  | .806                | .125                | 1.438                     | 1.375                    |
| 23         | H                  | 1.5000                                  | .838                | .156                | 1.563                     | 1.500                    |
| 25         | J                  | 1.6250                                  | .838                | .156                | 1.688                     | 1.625                    |

| Shell Size | MS Shell Size Code | L<br>+.28<br>-.00 | M<br>+.15<br>-.13 | GG Dia.<br>+.28<br>-.25 | KK Dia<br>+.03<br>-.13 |
|------------|--------------------|-------------------|-------------------|-------------------------|------------------------|
| 9          | A                  | 20.47             | 3.18              | 19.05                   | 17.07                  |
| 11         | B                  | 20.47             | 3.18              | 21.44                   | 19.84                  |
| 13         | C                  | 20.47             | 3.18              | 24.61                   | 23.01                  |
| 15         | D                  | 20.47             | 3.18              | 27.79                   | 26.19                  |
| 17         | E                  | 20.47             | 3.18              | 30.94                   | 29.36                  |
| 19         | F                  | 20.47             | 3.18              | 33.32                   | 31.75                  |
| 21         | G                  | 20.47             | 3.18              | 36.53                   | 34.93                  |
| 23         | H                  | 21.29             | 3.96              | 39.70                   | 38.10                  |
| 25         | J                  | 21.29             | 3.96              | 42.88                   | 41.28                  |

**TVSHIY (D38999/27) – Hermetic, Stainless Steel**

**Weld Mounting Receptacle**

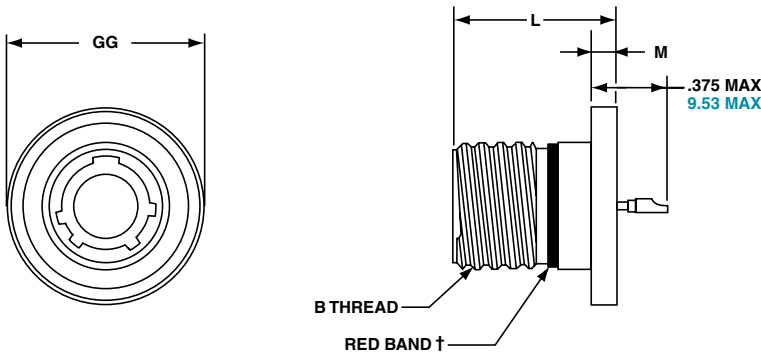

**PART #**

To complete, see how to order pages 25-27.

| Connector Type | Shell Style | Service Class | Shell Size & Insert Arrg | Contact Type | Alternate Position | Special Variations |
|----------------|-------------|---------------|--------------------------|--------------|--------------------|--------------------|
| TVS            | HI          | Y             | 9-35                     | P            | B                  | (453)              |
| TVS            | HI          | YN            | X-X                      | X            | X                  | (XXX)              |
| D38999/        | 27          | X             | X-X                      | X            | X                  | NA                 |

† Red band indicates fully mated

Inches

Millimeters

| Shell Size | MS Shell Size Code | B Thread Class 2A 0.1P-0.3L-TS (Plated) | L<br>+.011<br>-.000 | M<br>+.006<br>-.005 | GG Dia.<br>+.011<br>-.010 |
|------------|--------------------|-----------------------------------------|---------------------|---------------------|---------------------------|
| 9          | A                  | .6250                                   | .806                | .125                | .973                      |
| 11         | B                  | .7500                                   | .806                | .125                | 1.095                     |
| 13         | C                  | .8750                                   | .806                | .125                | 1.221                     |
| 15         | D                  | 1.0000                                  | .806                | .125                | 1.347                     |
| 17         | E                  | 1.1875                                  | .806                | .125                | 1.434                     |
| 19         | F                  | 1.2500                                  | .806                | .125                | 1.579                     |
| 21         | G                  | 1.3750                                  | .806                | .125                | 1.721                     |
| 23         | H                  | 1.5000                                  | .838                | .156                | 1.886                     |
| 25         | J                  | 1.6250                                  | .838                | .156                | 1.973                     |

| Shell Size | MS Shell Size Code | L<br>+.28<br>-.00 | M<br>+.15<br>-.13 | GG Dia.<br>+.25<br>-.00 |
|------------|--------------------|-------------------|-------------------|-------------------------|
| 9          | A                  | 20.47             | 3.18              | 24.71                   |
| 11         | B                  | 20.47             | 3.18              | 27.81                   |
| 13         | C                  | 20.47             | 3.18              | 31.01                   |
| 15         | D                  | 20.47             | 3.18              | 34.21                   |
| 17         | E                  | 20.47             | 3.18              | 36.42                   |
| 19         | F                  | 20.47             | 3.18              | 40.11                   |
| 21         | G                  | 20.47             | 3.18              | 43.71                   |
| 23         | H                  | 21.29             | 3.96              | 47.90                   |
| 25         | J                  | 21.29             | 3.96              | 50.11                   |

All dimensions for reference only

- High Speed
- Fiber Optics
- Contacts Connectors Cables
- EMI Filter Transient
- 26482 Matrix 2
- 83723 III Matrix I Pyle
- 26500 Pyle
- 5015 Crimp Rear Release Matrix
- 22992 Class I
- Back-Shells
- Options Others



# Series III, TV Breakaway Fail Safe Connectors

## Quick-Disconnect with an Axial Pull of Lanyard

38999

**Amphenol® Tri-Start Breakaway Fail Safe Connectors provide unequalled performance in environments requiring instant disengagement.**

Designed to provide quick disconnect of a connector plug and receptacle with an axial pull on the lanyard. The “Breakaway” Fail Safe connector family offers a wide range of electrical and mechanical features:

- Instant decoupling and damage free separation
- Completely intermateable with standard receptacles (D38999/20 and /24)
- Inventory support commonality through the use of standard insert arrangements and contacts

Breakaway unmating is initiated by applying a pull force to the lanyard which causes the operating sleeve on the plug to move away from the receptacle. Coupling segments on the plug then move away from the mating receptacle while expanding, thus releasing the receptacle. After completion of the unmating sequence, spring compression returns the sleeve and segments to their original positions. Unmating of the plug may also be accomplished by normal rotation of the coupling ring without affecting the breakaway capability.



**Amphenol offers a variety of lanyard plug styles including MIL-STD-1760 types 1, 2 and 6 for Stores Management applications.**

**The Tri-Start Breakaway Fail Safe connector exceeds the MIL-Spec Series III requirements for EM/EMP shielding and features include:**

- Solid metal-to-metal coupling
- EMI grounding fingers
- Conductive finishes

**Amphenol Breakaway Fail Safe connectors are qualified to MIL-DTL-38999/29, /30 and /31 (for MIL-STD-1760 Stores Management applications). In fact, Amphenol offers more qualified Breakaway shell size and insert combinations than any other QPL supplier.**

In addition to standard Breakaway connectors, Amphenol also manufactures custom breakaway connectors including those with:

- Highly durable non-metallic operating sleeves in a variety of lengths and diameters
- Increased pull-force capability
- Low-profile designs
- Custom lanyard lengths and backshells
- Low force separation capabilities
- Low insertion/separation force contacts
- Non-cadmium finishes

Whether you need a standard Breakaway, one of our custom Breakaways or a unique Breakaway design, please contact your local Amphenol representative.

Contact Amphenol Aerospace for more information on breakaway, quick-disconnect connectors. Other Amphenol circular families (MIL-DTL-26482, MIL-DTL-83723) also offer breakaway quick-disconnect connectors.

See accessories for breakaway connectors on page 111.



**Breakaway with Coax Contacts**



**Special configuration Fail Safe used on space telescope application.**

Lanyard is replaced by a swivel ring for remote disconnect and “wing arms” have been added for manual actuation accessibility by gloved astronauts.

|                            |
|----------------------------|
| III                        |
| HD                         |
| Dualok                     |
| II                         |
| I                          |
| SJT                        |
| Accessories                |
| Aquacon                    |
| Herm/Seal                  |
| PCB                        |
| <b>HIGH SPEED</b>          |
| Fiber Optics               |
| Contacts Connectors Cables |

|                                |
|--------------------------------|
| EMI Filter Transient           |
| 26482 Matrix 2                 |
| 83723 III Matrix   Pyle        |
| 26500 Pyle                     |
| 5015 Crimp Rear Release Matrix |
| 22992 Class 1                  |
| Back-Shells                    |
| Options Others                 |

38999

- III
- HD
- Dualok
- II
- I
- SJT
- Accessories
- Aquacon
- Herm/Seal
- PCB

- HIGH SPEED
- Fiber Optics
- Contacts Connectors Cables

- EMI Filter Transient

- 26482 Matrix 2

- 83723 III Matrix | Pyle

- 26500 Pyle

- 5015 Crimp Rear Release Matrix

- 22992 Class I

- Back-Shells

- Options Others

| PART #                                     | Connector Type | Shell Style | Shell Size & Insert Arrg | Lanyard Length Code | Contact Type/ Alternate Insert Rotation |                |
|--------------------------------------------|----------------|-------------|--------------------------|---------------------|-----------------------------------------|----------------|
| To complete, see how to order pages 41-42. | D38999         | 29          | 29                       | E                   | P                                       | (Pins Only)    |
|                                            | D38999         | 30          | X-X                      | X                   | X                                       | (Sockets Only) |
|                                            | 88             | 5565        | X-X                      | X                   | X                                       |                |
|                                            | 91             | 5565        | X-X                      | X                   | X                                       |                |

**METAL**

.374 MAX  
9.50 MAX  
OUTER SLEEVE MOVEMENT  
DURING UNMATING THREAD RELEASE

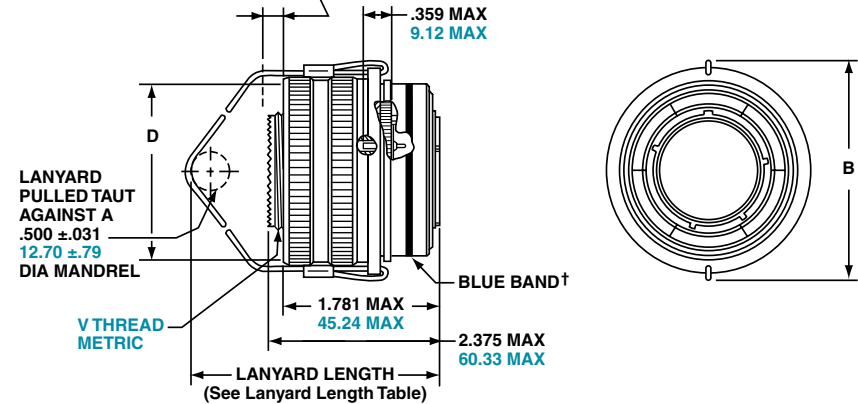

† Blue band indicates rear release contact retention system

Inches

| Shell Size | MS Shell Size Code | B Max | D Max Accessory Dia. |
|------------|--------------------|-------|----------------------|
| 11         | B                  | 1.846 | 1.109                |
| 13         | C                  | 1.972 | 1.250                |
| 15         | D                  | 2.079 | 1.375                |
| 17         | E                  | 2.205 | 1.500                |
| 19         | F                  | 2.301 | 1.625                |
| 21         | G                  | 2.472 | 1.750                |
| 23         | H                  | 2.594 | 1.875                |
| 25         | J                  | 2.705 | 2.000                |

Millimeters

| Shell Size | MS Shell Size Code | B Max | D Max Accessory Dia. | V Thread Metric |
|------------|--------------------|-------|----------------------|-----------------|
| 11         | B                  | 46.89 | 28.17                | M15X1.0-6g      |
| 13         | C                  | 50.09 | 31.75                | M18X1.0-6g      |
| 15         | D                  | 52.81 | 34.93                | M22X1.0-6g      |
| 17         | E                  | 56.01 | 38.10                | M25X1.0-6g      |
| 19         | F                  | 58.45 | 41.28                | M28X1.0-6g      |
| 21         | G                  | 62.79 | 44.45                | M31X1.0-6g      |
| 23         | H                  | 65.89 | 47.63                | M34X1.0-6g      |
| 25         | J                  | 68.71 | 50.08                | M37X1.0-6g      |

All dimensions for reference only

38999

### Easy Steps to build a part number... **Military**

- 1.
- 2.
- 3.
- 4.
- 5.
- 6.
- 7.

| DOD Number Prefix | Spec Sheet Number | Service Class | Shell Size | Insert Arrangement | Lanyard Length Code | Alternate Keying Position |
|-------------------|-------------------|---------------|------------|--------------------|---------------------|---------------------------|
| D38999/           | 29                | F             | E          | 35                 | P                   | N                         |

#### Step 1. DOD Number Prefix

**D38999/** designates MIL-DTL-38999, Series III, Tri-Start Connector

#### Step 2. Select a Specification Sheet Number

|           |                                                      |
|-----------|------------------------------------------------------|
| <b>29</b> | Designates Lanyard Release Plug with pin contacts    |
| <b>30</b> | Designates Lanyard Release Plug with socket contacts |

#### Step 4. & 5 Insert Availability

#### Step 3. Select a Service Class

|          |                                                                                                                                               |
|----------|-----------------------------------------------------------------------------------------------------------------------------------------------|
| <b>F</b> | Designates electroless nickel plated aluminum, optimum EMI shielding effectiveness -65dB@10 GHz specification min., 48 hour salt spray, 200°C |
| <b>W</b> | Designates corrosion resistant olive drab cadmium plate aluminum, 500 hour extended salt spray, EMI -50dB@10 GHz specification min., 175°C    |

| Commercial Basic Part#<br>Shell & Insert Arrg. Code | Shell Size-Insert Arrangement | Military Shell Size-Insert Arrangement | Service Rating | Total Contacts | Contact Size |    |    |    |         |        |          |  |
|-----------------------------------------------------|-------------------------------|----------------------------------------|----------------|----------------|--------------|----|----|----|---------|--------|----------|--|
|                                                     |                               |                                        |                |                | 22D          | 20 | 16 | 12 | 12 Coax | 8 Coax | 8 Twinax |  |
| 88/91-556508                                        | 11-2                          | N/A                                    | I              | 2              |              |    | 2  |    |         |        |          |  |
| 06                                                  | 11-35                         | N/A                                    | M              | 13             | 13           |    |    |    |         |        |          |  |
| 07                                                  | 11-98                         | N/A                                    | I              | 6              |              | 6  |    |    |         |        |          |  |
| 10                                                  | 13-4                          | N/A                                    | I              | 4              |              |    | 4  |    |         |        |          |  |
| 11                                                  | 13-8                          | N/A                                    | I              | 8              |              | 8  |    |    |         |        |          |  |
| 14                                                  | 13-35                         | N/A                                    | M              | 22             | 22           |    |    |    |         |        |          |  |
| 13                                                  | 13-98                         | N/A                                    | I              | 10             |              | 10 |    |    |         |        |          |  |
| 18                                                  | 15-5                          | N/A                                    | II             | 5              |              |    | 5  |    |         |        |          |  |
| 23                                                  | 15-15                         | N/A                                    | I              | 15             |              | 14 | 1  |    |         |        |          |  |
| 22                                                  | 15-18                         | N/A                                    | I              | 18             |              | 18 |    |    |         |        |          |  |
| 19                                                  | 15-19                         | N/A                                    | I              | 19             |              | 19 |    |    |         |        |          |  |
| 20                                                  | 15-35                         | N/A                                    | M              | 37             | 37           |    |    |    |         |        |          |  |
| 21                                                  | 15-97                         | N/A                                    | I              | 12             |              | 8  | 4  |    |         |        |          |  |
| 27                                                  | 17-6                          | E-6                                    | I              | 6              |              |    |    | 6  |         |        |          |  |
| 28                                                  | 17-8                          | E-8                                    | II             | 8              |              |    | 8  |    |         |        |          |  |
| 29                                                  | 17-26                         | E-26                                   | I              | 26             |              | 26 |    |    |         |        |          |  |
| 30                                                  | 17-35                         | E-35                                   | M              | 55             | 55           |    |    |    |         |        |          |  |
| 31                                                  | 17-99                         | E-99                                   | I              | 23             |              | 21 | 2  |    |         |        |          |  |
| 37                                                  | 19-11                         | F-11                                   | II             | 11             |              |    | 11 |    |         |        |          |  |
| 39                                                  | 19-32                         | F-32                                   | I              | 32             |              | 32 |    |    |         |        |          |  |
| 40                                                  | 19-35                         | F-35                                   | M              | 66             | 66           |    |    |    |         |        |          |  |
| 47                                                  | 21-11                         | G-11                                   | I              | 11             |              |    |    | 11 |         |        |          |  |
| 48                                                  | 21-16                         | G-16                                   | II             | 16             |              |    | 16 |    |         |        |          |  |
| 49                                                  | 21-35                         | G-35                                   | M              | 79             | 79           |    |    |    |         |        |          |  |
| 51                                                  | 21-39                         | G-39                                   | I              | 39             |              | 37 | 2  |    |         |        |          |  |
| 50                                                  | 21-41                         | G-41                                   | I              | 41             |              | 41 |    |    |         |        |          |  |
| 57                                                  | 23-21                         | H-21                                   | II             | 21             |              |    | 21 |    |         |        |          |  |
| 58                                                  | 23-35                         | H-35                                   | M              | 100            | 100          |    |    |    |         |        |          |  |
| 59                                                  | 23-53                         | H-53                                   | I              | 53             |              | 53 |    |    |         |        |          |  |
| 61                                                  | 23-54                         | H-54                                   | M              | 53             | 40           |    | 9  | 4  |         |        |          |  |
| 60                                                  | 23-55                         | H-55                                   | I              | 55             |              | 55 |    |    |         |        |          |  |
| 71                                                  | 25-4                          | J-4                                    | I              | 56             |              | 48 | 8  |    |         |        |          |  |
| 66                                                  | 25-19                         | J-19                                   | I              | 19             |              |    |    | 19 |         |        |          |  |
| 74                                                  | 25-20                         | J-20                                   | N              | 30             |              | 10 | 13 |    | 4       |        | 3        |  |
| 72                                                  | 25-24                         | J-24                                   | I              | 24             |              |    | 12 | 12 |         |        |          |  |
| 67                                                  | 25-29                         | J-29                                   | I              | 29             |              |    | 29 |    |         |        |          |  |
| 68                                                  | 25-35                         | J-35                                   | M              | 128            | 128          |    |    |    |         |        |          |  |
| 69                                                  | 25-43                         | J-43                                   | I              | 43             |              | 23 | 20 |    |         |        |          |  |
| 73                                                  | 25-46                         | J-46                                   | I              | 46             |              | 40 | 4  |    |         | 2*     |          |  |
| 70                                                  | 25-61                         | J-61                                   | I              | 61             |              | 61 |    |    |         |        |          |  |

|             |
|-------------|
| III         |
| HD          |
| Dualok      |
| II          |
| I           |
| SJT         |
| Accessories |
| Aquacon     |
| Herm/Seal   |
| PCB         |

|                            |
|----------------------------|
| HIGH SPEED                 |
| Fiber Optics               |
| Contacts Connectors Cables |

|            |
|------------|
| EMI Filter |
| Transient  |

|          |
|----------|
| 26482    |
| Matrix 2 |

|               |
|---------------|
| 83723 III     |
| Matrix   Pyle |

|       |
|-------|
| 26500 |
| Pyle  |

|                           |
|---------------------------|
| 5015                      |
| Crimp Rear Release Matrix |

|         |
|---------|
| 22992   |
| Class I |

|              |
|--------------|
| Back-Shell's |
|--------------|

|                |
|----------------|
| Options Others |
|----------------|

38999

- III
- HD
- Dualok
- II
- I
- SJT
- Accessories
- Aquacon
- Herm/Seal
- PCB

- HIGH SPEED
- Fiber Optics
- Contacts Connectors Cables

- EMI Filter Transient

- 26482 Matrix 2

- 83723 III Matrix | Pyle

- 26500 Pyle

- 5015 Crimp Rear Release Matrix

- 22992 Class I

- Back-Shells

- Options Others

### Step 6. Military/ Commercial Lanyard Length Code

Table II

| Lanyard Length (in.) ± .236 | Lanyard Length (mm) ± 6.0 | Lanyard Length Code For Part Number |
|-----------------------------|---------------------------|-------------------------------------|
| 4.016                       | 102                       | A                                   |
| 4.528                       | 115                       | B                                   |
| 5.000                       | 127                       | C                                   |
| 5.512                       | 140                       | D                                   |
| 6.024                       | 153                       | E                                   |
| 6.535                       | 166                       | F                                   |
| 7.008                       | 178                       | G                                   |
| 7.520                       | 191                       | H                                   |
| 7.992                       | 203                       | I                                   |
| 8.503                       | 216                       | J                                   |
| 9.016                       | 229                       | K                                   |
| 9.528                       | 242                       | L                                   |
| 10.000                      | 254                       | M                                   |
| 10.512                      | 267                       | N                                   |
| 11.024                      | 280                       | P                                   |
| 11.535                      | 293                       | R                                   |
| 12.008                      | 305                       | S                                   |
| 12.520                      | 318                       | T                                   |
| 13.031                      | 331                       | U                                   |
| 14.016                      | 356                       | V                                   |
| 15.000                      | 381                       | W                                   |
| 16.024                      | 407                       | X                                   |
| 17.008                      | 432                       | Y                                   |
| 18.031                      | 458                       | Z                                   |

### Step 7. Military Alternate Keying Position

For alternate positions of connector (to prevent cross-mating) see alternate positioning on page 27. (N indicates normal)

### Easy Steps to build a part number... Commercial

**FAIL SAFE 88-5565( ) & 91-5565( )**

Ordering procedure for example part number 88-556529-EP is shown below:

| 1.            | 2.                            | 3.                             | 4.             | 5.                  | 6.                                     |
|---------------|-------------------------------|--------------------------------|----------------|---------------------|----------------------------------------|
| Service Class | Connector Type Identification | Shell Size & Insert Arrg. Code | Required Field | Lanyard Length Code | Contact Type/Alternate Keying Position |
| 88            | 5565                          | 29                             | 0              | E                   | P                                      |

#### Step 1. Select a Service Class

|    |                                                                                                                                                 |
|----|-------------------------------------------------------------------------------------------------------------------------------------------------|
| 88 | Designates corrosion resistant olive drab cadmium plate over nickel, 500 hour extended salt spray, EMI -50dB @ 10 GHz specification min., 175°C |
| 91 | Designates electroless nickel plated aluminum, optimum EMI shielding effectiveness -65dB @ 10 GHz specification min., 48 hour salt spray, 200°C |

These are standard finishes. Consult Amphenol Aerospace for other variations.

#### Step 2. Select a Connector Type Identification

|      |                                                                     |
|------|---------------------------------------------------------------------|
| 5565 | Designates MIL-DTL-38999, Series III Tri-Start Lanyard Release Plug |
|------|---------------------------------------------------------------------|

#### Step 3. Select a Commercial Shell Size & Insert Arrangement Code

MIL-DTL-38999, see insert availability chart on page 41.

#### Step 4. Required Field

|   |                                  |
|---|----------------------------------|
| 0 | The required field is always a 0 |
|---|----------------------------------|

#### Step 5. Select a Lanyard Length Code

See Table II (to the left) for lanyard length code number.

#### Step 6. Select a Contact Type/Alternate Keying Position

P designates pin, S designates socket for normal positioning of contacts. When an alternate position of the connector is required to prevent cross-mating, a different letter (other than P or S) is used. See alternate positioning on page 27, then convert to Amphenol Commercial coding by the following chart.

| Pin Contacts |                   | Socket Contacts |                   |
|--------------|-------------------|-----------------|-------------------|
| MS Letter    | Amphenol letter   | MS Letter       | Amphenol Letter   |
| PN           | <b>P (normal)</b> | SN              | <b>S (normal)</b> |
| PA           | <b>G</b>          | SA              | <b>H</b>          |
| PB           | <b>I</b>          | SB              | <b>J</b>          |
| PC           | <b>K</b>          | SC              | <b>L</b>          |
| PD           | <b>M</b>          | SD              | <b>N</b>          |
| PE           | <b>R</b>          | SE              | <b>T</b>          |

### Lanyard Release Plug

PIN CONTACTS ONLY,  
SHELL SIZE 25 ONLY



TYPE 6



TYPE 2



TYPE 1  
(LONGER SHELL)

† Blue band indicates rear release contact retention system  
\*\* Lanyard pulled taut against a .500 ± .13 dia. Mandrel  
All dimensions for reference only

Pin Contact Data for MIL-STD-1760

| Insert Arrangement | Service Rating | Total Contacts | Contact |    |           |            |
|--------------------|----------------|----------------|---------|----|-----------|------------|
|                    |                |                | 20      | 16 | 12 (Coax) | 8 (Twinax) |
| 25-20              | N              | 30             | 10      | 13 | 4         | 3          |

Contacts for 25-20 Pattern

| Shell Size | Arrg. Number | Number of Contacts | Size Contacts                | Service Rating | Contact Location                      | Standard Contacts |                |
|------------|--------------|--------------------|------------------------------|----------------|---------------------------------------|-------------------|----------------|
|            |              |                    |                              |                |                                       | Pin               | Socket         |
| 25         | -20          | 3                  | 8                            | Twinax         | A, H, K                               | M39029/90-529     | M39029/91-530  |
|            |              | 4                  | 12                           | Coax           | 2,3                                   | M39029/28-211     | M39029/75-416  |
|            |              |                    |                              |                | W, 5                                  | M39029/102-558    | M39029/103-559 |
|            |              | 13                 | 16                           | N              | C, D, E, F, J, M, N, P, R, T, U, Y, Z | M39029/58-364     | M39029/56-352  |
| 10         | 20           | N                  | B, G, L, S, V, X, 1, 4, 6, 7 | M39029/58-363  | M39029/56-351                         |                   |                |

| Insert Arrangement | Service Rating | Total Contacts | Contact Size |            |
|--------------------|----------------|----------------|--------------|------------|
|                    |                |                | 20           | 10 (power) |
| 25-11              | N              | 11             | 2            | 9          |

\*Part number reference.  
To complete, see how to order page 41.

- D38999/31
- 88-555875/76 } Type 6
  - 91-555875/76 }
  - 88-558518/19 } Type 2
  - 91-558518/19 }
  - T3W-16B25-XXXX — Type 1

\*To order by Commercial Part numbers consult Amphenol.

Tri-Start Lanyard Separation Forces

| Shell Size | Straight Plug (lbs. max.) | 15 Degree Pull (lbs. max.) |
|------------|---------------------------|----------------------------|
| 25         | 90                        | 100                        |

**INSERT AVAILABILITY  
FAIL SAFE D38999/31  
FOR MIL-STD-1760**

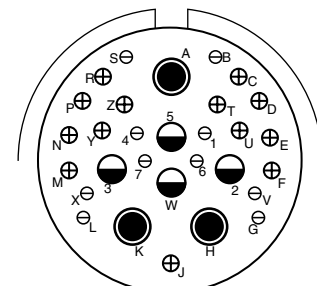

25-20

Primary Interface Signal Set

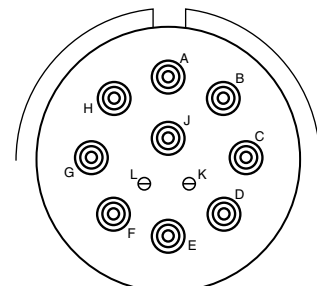

25-11

Auxiliary Power Signal Set

Contact Legend



8 (twinax) 10 (power) 12 (coax) 16 20

38999

|             |
|-------------|
| III         |
| HD          |
| Dualok      |
| II          |
| I           |
| SJT         |
| Accessories |
| Aquacon     |
| Herm/Seal   |
| PCB         |

|                            |
|----------------------------|
| HIGH SPEED                 |
| Fiber Optics               |
| Contacts Connectors Cables |

EMI Filter  
Transient

26482  
Matrix 2

83723 III  
Matrix | Pyle

26500  
Pyle

5015  
Crimp Rear Release Matrix

22992  
Class 1

Back-Shell's

Options  
Others



- 38999
- III
- HD
- Dualok
- II
- I
- SJT
- Accessories
- Aquacon
- Herm/Seal
- PCB

- HIGH SPEED
- Fiber Optics
- Contacts
- Connectors
- Cables

- EMI Filter
- Transient

- 26482
- Matrix 2

- 83723 III
- Matrix | Pyle

- 26500
- Pyle

- 5015
- Crimp Rear Release
- Matrix

- 22992
- Class 1

- Back-Shell

- Options
- Others

**HOW TO ORDER - BY MILITARY PART NUMBER FAIL SAFE D38999/31**

Ordering procedure for example part number D38999/31WE20PN1 is shown below:

**Easy Steps to build a part number... Military**

| 1.                | 2.                | 3.            | 4.                  | 5.                 | 6.            | 7.                        | 8.          |
|-------------------|-------------------|---------------|---------------------|--------------------|---------------|---------------------------|-------------|
| DOD Number Prefix | Spec Sheet Number | Service Class | Lanyard Length Code | Insert Arrangement | Contact Style | Alternate Keying Position | Type Number |
| D38999/           | 31                | W             | E                   | 20                 | P             | N                         | 1           |

**1. Select a DOD Number Prefix**

|         | Designates                                     |
|---------|------------------------------------------------|
| D38999/ | MIL-DTL-38999, Series III Tri-Start Connectors |

**2. Specification Sheet Number**

|    | Designates                                                         |
|----|--------------------------------------------------------------------|
| 31 | Designates Lanyard Release Plug for MIL-STD-1760 with pin contacts |

**3. Select a Service Class**

|   | Designates                                                                                                                           |
|---|--------------------------------------------------------------------------------------------------------------------------------------|
| F | Electroless nickel plated aluminum, optimum EMI shielding effectiveness –65dB @ 10 GHz specification min., 48 hour salt spray, 200°C |
| W | Corrosion resistant olive drab cadmium plate aluminum, 500 hour extended salt spray, EMI –50dB @ 10 GHz specification min., 175°C    |

**4. Select a Lanyard Length Code**

| Lanyard Length (in.) ±.236 | Lanyard Length (mm.) ± 6.0 | Lanyard Length Code for Part Number |
|----------------------------|----------------------------|-------------------------------------|
| 6.024                      | 153.0                      | E                                   |
| 6.535                      | 166.0                      | F                                   |
| 7.008                      | 178.0                      | G                                   |
| 7.520                      | 191.0                      | H                                   |
| 7.992                      | 203.0                      | I                                   |
| 8.504                      | 216.0                      | J                                   |
| 9.016                      | 229.0                      | K                                   |
| 9.528                      | 242.0                      | L                                   |

**5. Select an Insert Arrangement**

Only 11 or 20 are available contact arrangement numbers. See page 43.

**6. Contact Style – P & A are Valid Options**

|   | Designates                                                                                          |
|---|-----------------------------------------------------------------------------------------------------|
| P | Replaces the “no designation” option in the PIN on revision C and earlier revision of the Mil-Spec. |
| A | Designates supplied less contacts.                                                                  |

**7. Alternate Keying Position**

|   | Designates                       |
|---|----------------------------------|
| N | Is required for normal position. |

**8. Type Number**

Type 1, 2 or 6. See drawings on page 43.

For accessories for lanyard release plugs see Accessories section.

# D38999 Type Hybrid Breakaway – Series III

## Lower Profile Lanyard Release Plug, Crimp, Metal shells with Composite Operating Sleeve

**New Hybrid Lanyard Breakaway Fail Safe connector with a composite thermoplastic outer operating sleeve for greater durability.**

This new hybrid breakaway is the breakaway of choice for the Navy F-18 Program. Amphenol's hybrid lanyard design offers greater durability over D38999 aluminum and composite designs because of its ability to handle abuse taken after weapons release.

Other advantages include:

- Lower profile compared to full metal breakaway Fail Safe connectors
- Less weight

This Hybrid Breakaway meets the applicable requirements of MIL-DTL-38999/31 including random & sine vibration, ice resistance, fluid immersion and hydrolytic stability tests. (Test reports are available upon request).

Currently the hybrid breakaway is available in shell sizes 25 and 17. It uses standard inserts available for breakaway plugs sizes 25 and 17, and is also available with inserts 25-20 and 25-11 for MIL-STD-1760. Consult Amphenol Aerospace for ordering of the new hybrid breakaway connectors. These hybrid connectors will accommodate the standard backshells for breakaway connectors shown on Accessories section or the backshell section.



**New Hybrid Lanyard Release Plugs (Metal inside shells and Composite, lower profile outer sleeves)**

| Condition/Test             | Description                                                                                                                     | Reference                |
|----------------------------|---------------------------------------------------------------------------------------------------------------------------------|--------------------------|
| Durability                 | 400 complete mating/unmating cycles                                                                                             | MIL-DTL-38999/31D        |
| High Impact Shock          | Nine hammer blows from 1,3 and 5 feet, three each in three axes on mounting panel.                                              | MIL-S- 901D              |
| Vibration                  | 10 to 2000Hz in three perpendicular axes, 4 hours in each axis for a total of 12 hours with no fracturing or breaking of parts. | MIL-STD-202F, Method 204 |
| Ice Resistance             | Pull tested after conditioned with Ice water at -18C for 35 minutes.                                                            | MIL-DTL-38999/31D        |
| Fail Safe Disengagement    | Rotationally unmated 180° from full mate position and pull tested in both a straight direction and at 15°.                      | MIL-DTL-38999/31D        |
| High Speed Pull Separation | 100 cycles at 30 feet per second.                                                                                               | MIL-DTL-38999/31D        |

## Stores Management Type II, Rail Launch

### Plugs and Receptacles that meet MIL-STD-1760

**Amphenol provides a Breakaway Rail Launch connector that is designed for use on aircraft that carry rail launch missiles such as AMRAAM.**

These connectors are designed for blindmating of stores on rail launch applications. They consist of a buffer plug and a missile receptacle that meet the specifications of MIL-STD-1760 Stores Management.

Other features and benefits include:

- Designed to MIL-C-83538 specifications
- Bayonet and push pull coupling
- Use standard MIL-DTL-38999 crimp termination with power, coax and twinax contacts also available
- Buffer provides flame barrier
- Buffers are replaceable

Consult Amphenol Aerospace for more information and ordering.



**Stores Management Type II Rail Launch Connectors**

**38999**

- III
- HD
- Duallok
- II
- I
- SJT
- Accessories
- Aquacon
- Herm/Seal
- PCB

- HIGH SPEED
- Fiber Optics
- Contacts Connectors Cables

- EMI Filter Transient
- 26482 Matrix 2
- 83723 III Matrix | Pyle
- 26500 Pyle

- 5015 Crimp Rear Release Matrix
- 22992 Class 1

- Back-Shells
- Options Others

## X-ON Electronics

Largest Supplier of Electrical and Electronic Components

*Click to view similar products for [Circular MIL Spec Connector](#) category:*

*Click to view products by [Amphenol](#) manufacturer:*

Other Similar products are found below :

[89075GULPR](#) [0025-262-542](#) [0025-264-3014](#) [58-570121-04S](#) [0134-213-1208](#) [0134-213-2209](#) [0025-258-000](#) [60-042022-07P](#) [60-042022-19P](#)  
[60-042022-23P](#) [60-042217-10P](#) [0114-201-1278](#) [012-0467-000](#) [602GB06EG24-61SN](#) [0134-201-1207](#) [0134-213-1006](#) [6104-207-2302](#) [6104-](#)  
[208-1902](#) [61-168211-04P](#) [61-168617-10P](#) [6131-202-19149P](#) [6131-204-21149P](#) [6131-208-13149P](#) [6131-209-17149P](#) [6131-210-11149P](#) [6131-](#)  
[211-19149P](#) [6131-216-19149P](#) [6131-259-21149P](#) [6131-259-23149P](#) [6131-265-17149P](#) [6131-265-19149P](#) [CS3100A18-1P-472](#) [CS3100A-36-](#)  
[77P](#) [CS3101A-16-55P](#) [CS3102A-10SL-55P](#) [CS3102A-14S-58P](#) [CS3102A-32-17P](#) [CS3102A32-25S](#) [CS3102C18-4P-472](#)  
[CS3106A10SL3S004](#) [CS3106A-18-73S](#) [CS3108A-14S-52S](#) [CS3108A-28-51S](#) [6162-233-1277](#) [6162-324-1231](#) [M243082296Z](#)  
[M2884010AC1S1](#) [CT0-24-10SC](#) [CT0M20-7PCAU](#) [M28840/17AC1G3](#)