

C-band Medium Power Amplifier

GaAs Monolithic Microwave IC in SMD leadless package

Description

The CHA4107-QDG is a monolithic two-stage GaAs medium power amplifier designed for C-Band applications. The MPA provides typically 25.5dBm output power associated to 30% power added efficiency at 1dB gain compression. It is supplied in RoHS compliant SMD package.

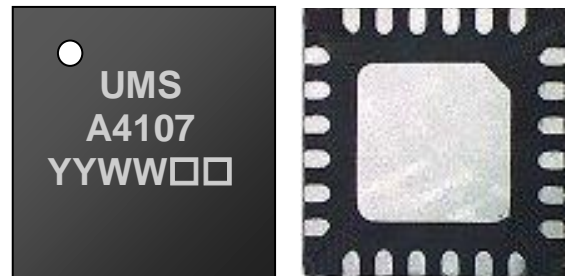

Main Features

- Frequency band: 4.5-6.5GHz
- Output power: 25.5dBm @ 1dBcomp
- Linear gain: 22.5dB
- High PAE: 30% @ 1dBcomp
- Quiescent bias point: $V_d=8V$, $I_d=120mA$
- 24L-QFN4x4
- MSL3

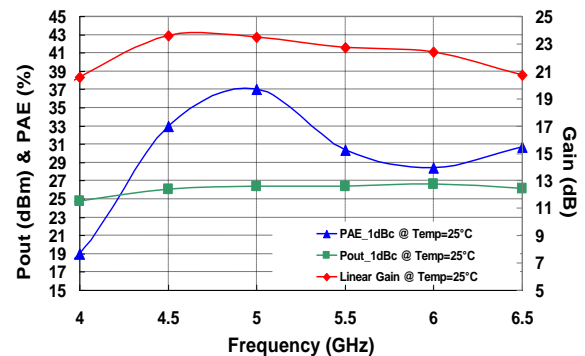

Main Characteristics

$T_{amb} = 25^{\circ}C$, $V_d = 8V$, I_d (Quiescent) = 120mA, Drain Pulse width= 50 μ s, Duty cycle = 10%

Symbol	Parameter	Min	Typ	Max	Unit
Fop	Operating frequency range	4.5		6.5	GHz
PAE_P-1dB	Power added efficiency @1dBcomp & 25°C		30		%
P-1dB	Output power @ 1dBcomp @ 25°C		25.5		dBm

Electrical Characteristics

Tamb = +25°C,

Vd = 8V, Id (Quiescent) = 120mA, Drain Pulse width = 50µs, Duty cycle = 10%

Symbol	Parameter	Min	Typ	Max	Unit
Fop	Operating frequency	4.5		6.5	GHz
G	Small signal gain		22.5		dB
RLin	Input Return Loss		14	8	dB
RLout	Output Return Loss		10	8	dB
P _{-1dB}	Output power @ 1dBcomp		25.5		dBm
PAE _{-1dB}	Power Added Efficiency @ 1dBcomp		30		%
Id _{-1dB}	Supply drain current @ 1dBcomp		145		mA
P _{-3dB}	Output power @ 3dBcomp		26		dBm
PAE _{-3dB}	Power Added Efficiency @ 3dBcomp		36		%
Id _{-3dB}	Supply drain current @ 3dBcomp		160		mA
Vd1, Vd2	Drain supply voltage		8		V
Id	Supply quiescent current ⁽¹⁾		120		mA
Vg	Gate supply voltage		-0.8		V

⁽¹⁾ Parameter can be adjusted by tuning of Vg.

Absolute Maximum Ratings ⁽¹⁾

Tamb.= +25°C

Symbol	Parameter	Values	Unit
Cmp	Compression level ⁽²⁾	6	dB
Vd	Supply voltage ⁽³⁾	9.5	V
Id	Supply quiescent current	170	mA
Id _{sat}	Supply current in saturation	200	mA
Vg	Supply voltage	[-3.0; -0.4]	V
Tj	Maximum junction temperature	175	°C
Tstg	Storage temperature range	-55 to +150	°C
Top	Operating temperature range	-40 to +85	°C

⁽¹⁾ Operation of this device above anyone of these parameters may cause permanent damage.

⁽²⁾ For higher compression the level limit can be increased by decreasing the voltage Vd using the rate 0.5V/dB of gain compression.

⁽³⁾ Without RF input power.

Device thermal performances

All the figures given in this section are obtained assuming that the QFN device is cooled down only by conduction through the package thermal pad (no convection mode considered). The temperature is monitored at the package back-side interface (T_{case}) as shown below. The system maximum temperature must be adjusted in order to guarantee that T_{case} remains below than the maximum value specified in the next table. So, the system PCB must be designed to comply with this requirement.

A derating must be applied on the dissipated power if the T_{case} temperature can not be maintained below than the maximum temperature specified (see the curve $P_{diss. Max}$) in order to guarantee the nominal device life time (MTTF).

DEVICE THERMAL SPECIFICATION : CHA4107-QDG	
Recommended max. junction temperature (T_j max)	: 148 °C
Junction temperature absolute maximum rating	: 175 °C
Max. continuous dissipated power @ $T_{case} = 85$ °C	: 2.4 W
=> P_{diss} derating above $T_{case}^{(1)} = 85$ °C	: 38 mW/°C
Junction-Case thermal resistance ($R_{th J-C}^{(2)}$)	: <26 °C/W
Min. package back side operating temperature ⁽³⁾	: -40 °C
Max. package back side operating temperature ⁽³⁾	: 85 °C
Min. storage temperature	: -55 °C
Max. storage temperature	: 150 °C

(1) Derating at junction temperature constant = T_j max

(2) $R_{th J-C}$ is calculated for a worst case where the **hottest junction** of the MMIC is considered.

(3) T_{case} = Package back side temperature measured under the die-attach-pad (see the drawing below).

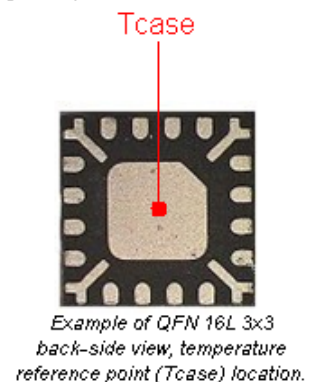
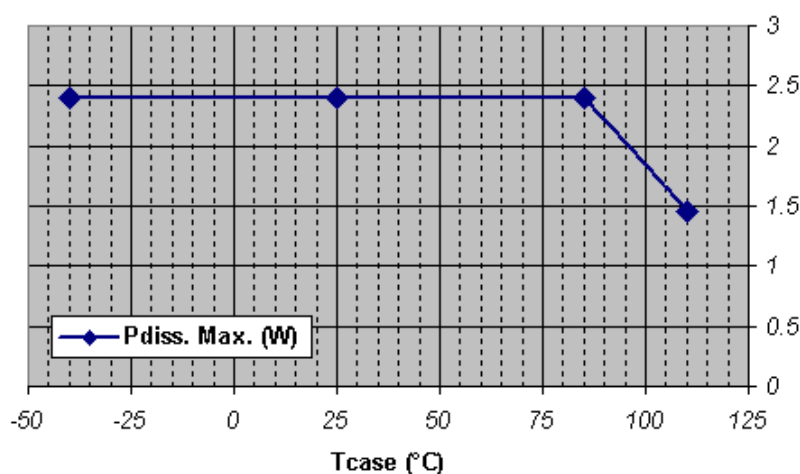

Typical Board Measurements

Vd = 8V, Id (Quiescent) = 120mA, Drain Pulse width = 50µs, Duty cycle = 10%

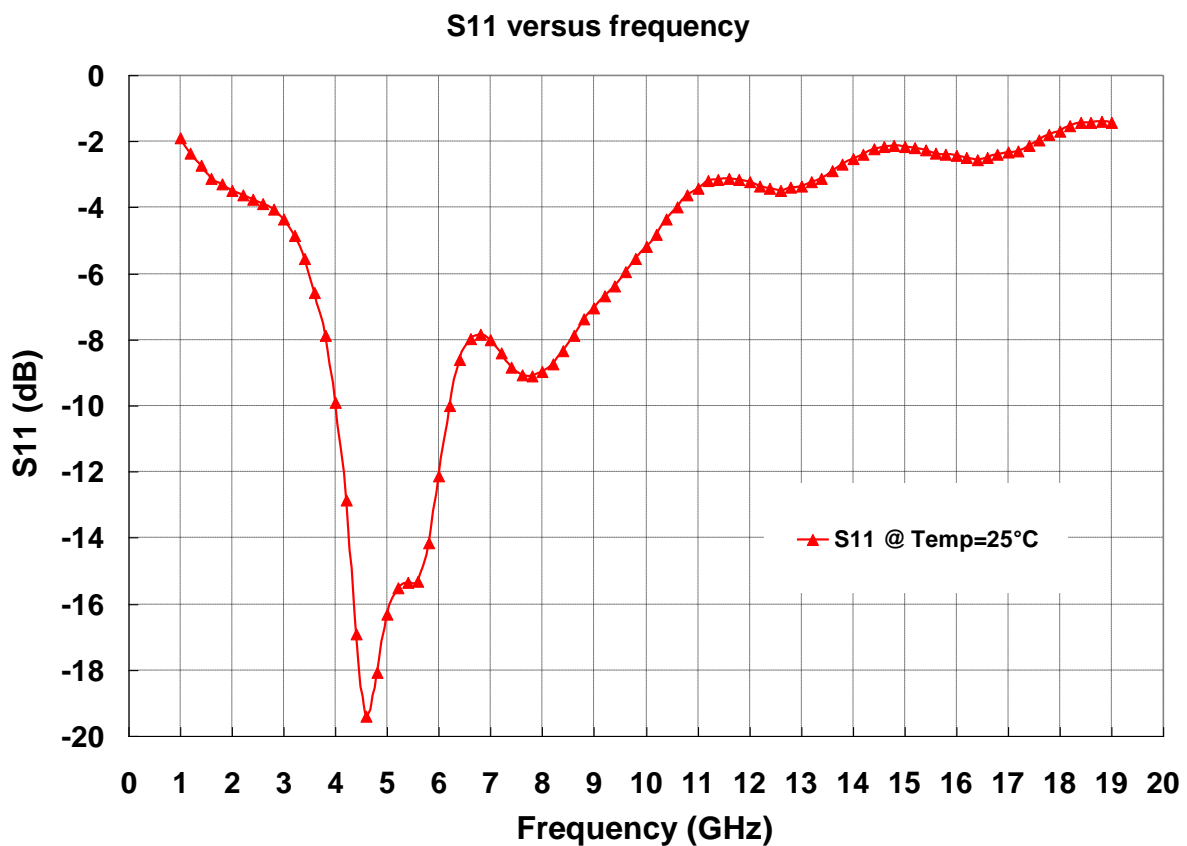
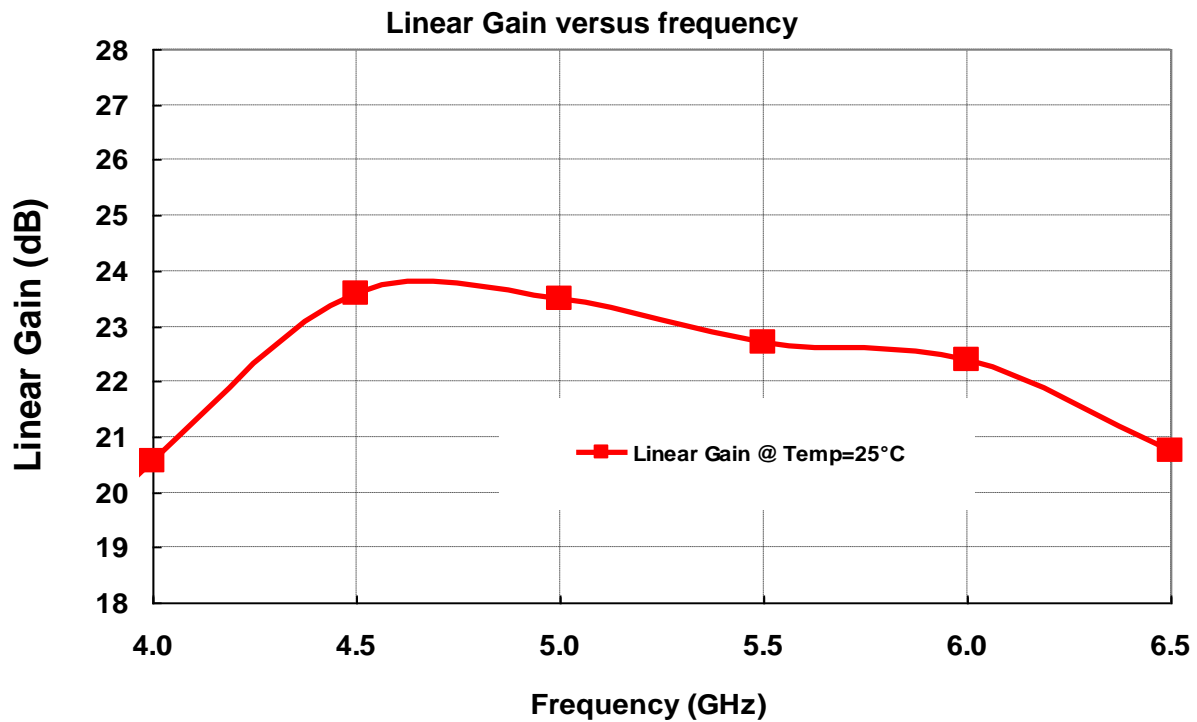

Typical on board Measurements

Vd = 8V, Id (Quiescent) = 120mA, Drain Pulse width = 50µs, Duty cycle = 10%

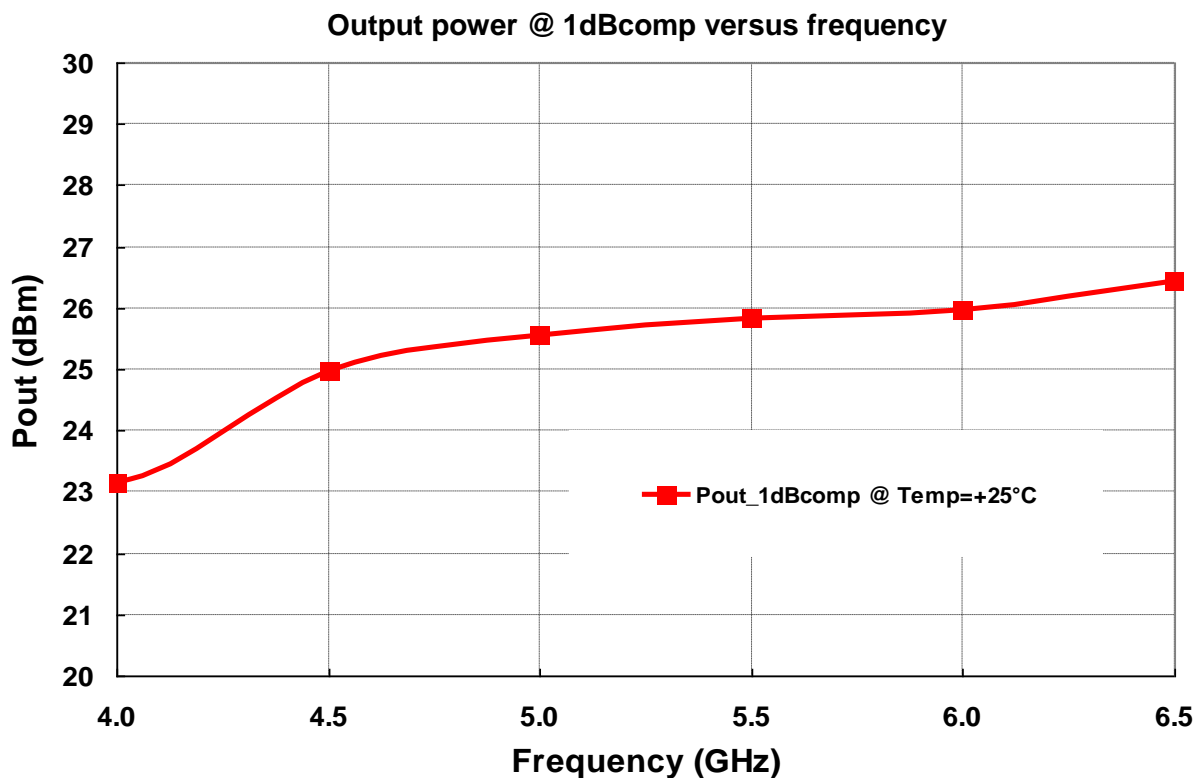
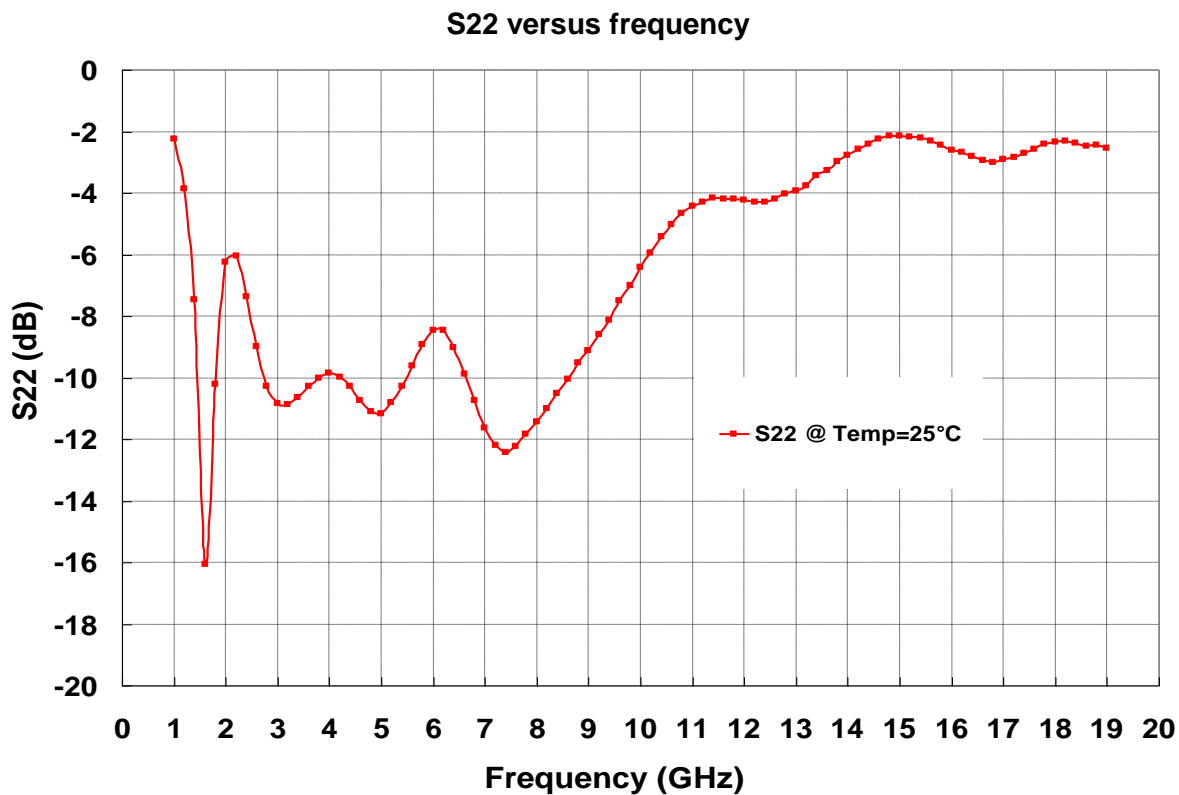

Typical on board Measurements

Vd = 8V, Id (Quiescent) = 120mA, Drain Pulse width = 50µs, Duty cycle = 10%

Power added efficiency @ 1dBcomp versus frequency

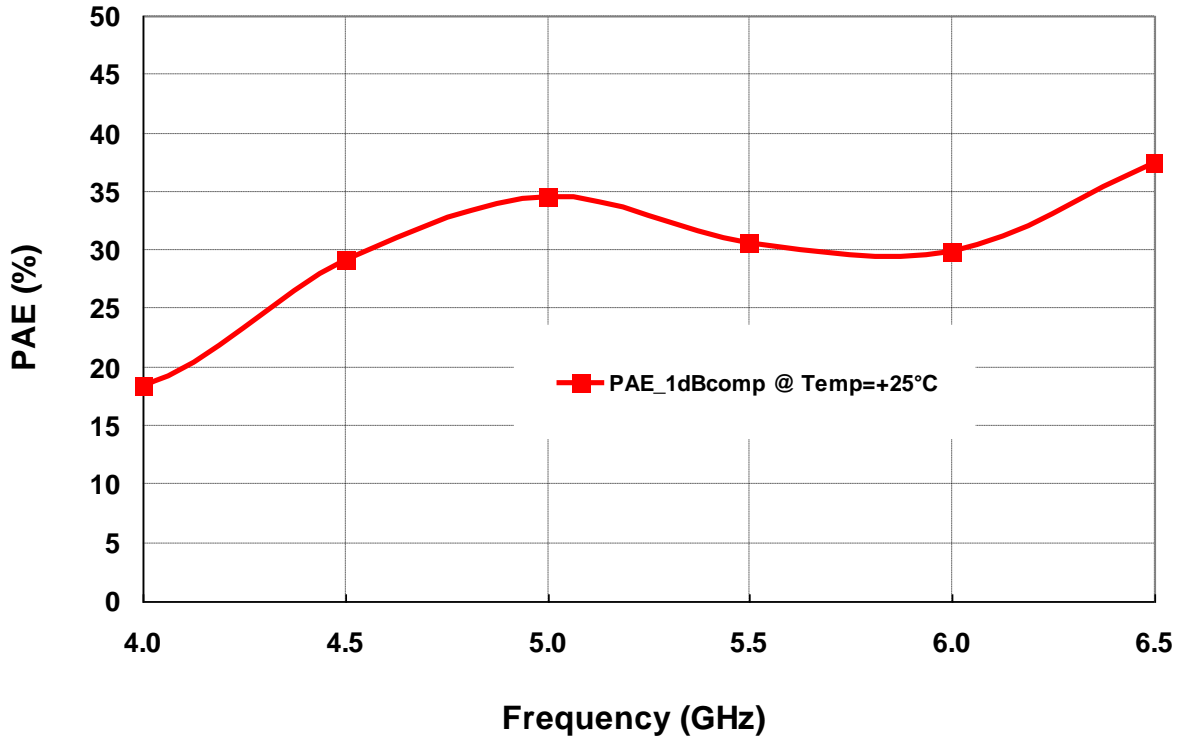

Drain Current @ 1dBcomp versus frequency

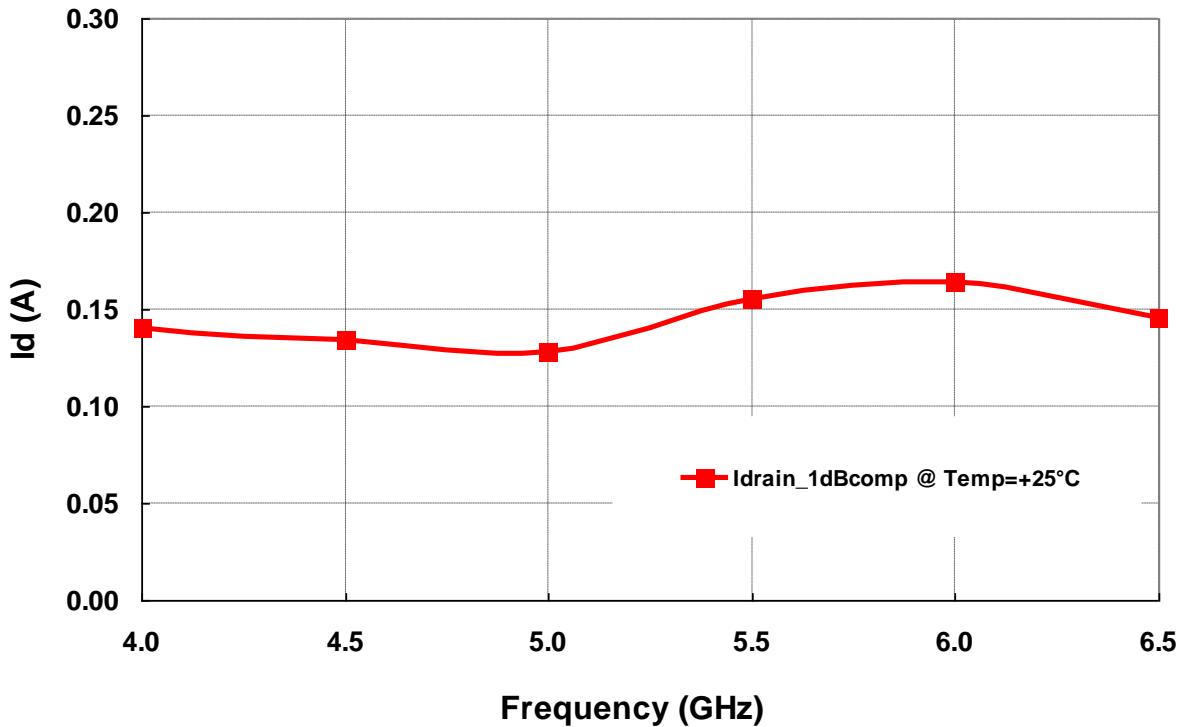

Typical on board Measurements

Vd = 8V, Id (Quiescent) = 120mA, Drain Pulse width = 50µs, Duty cycle = 10%

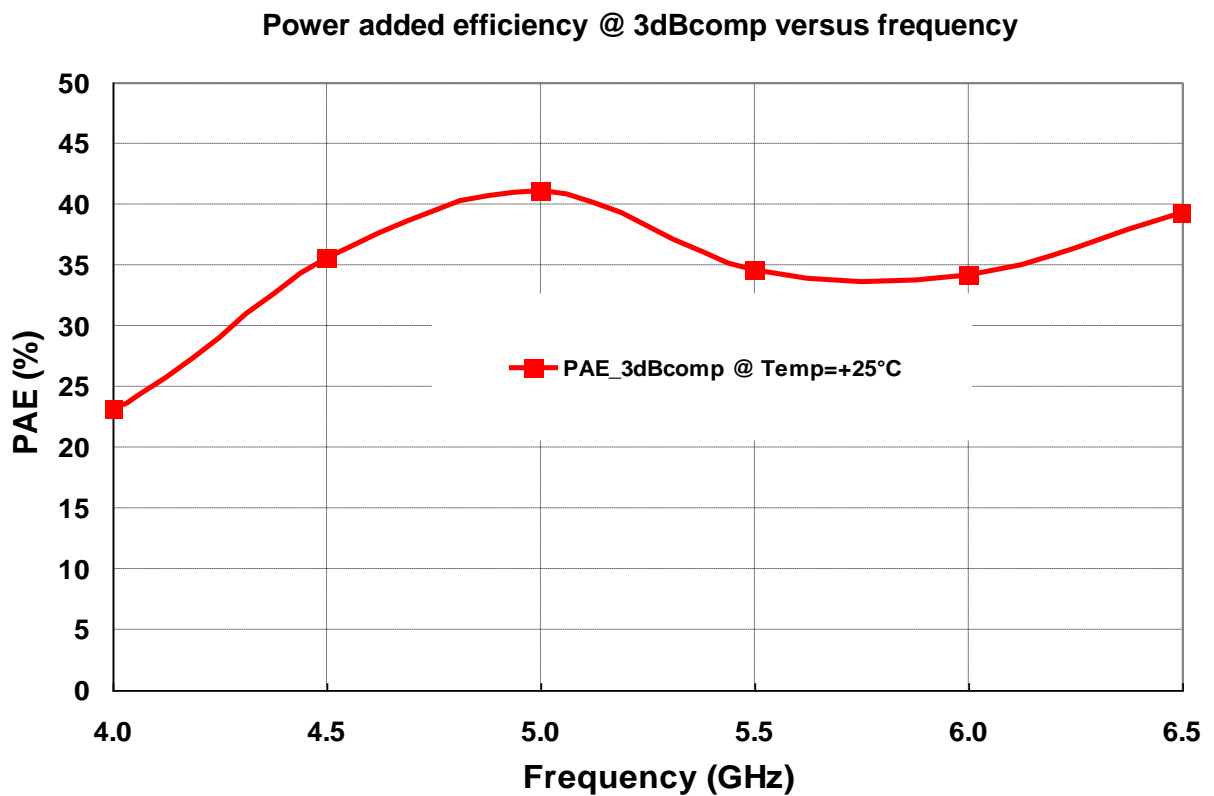
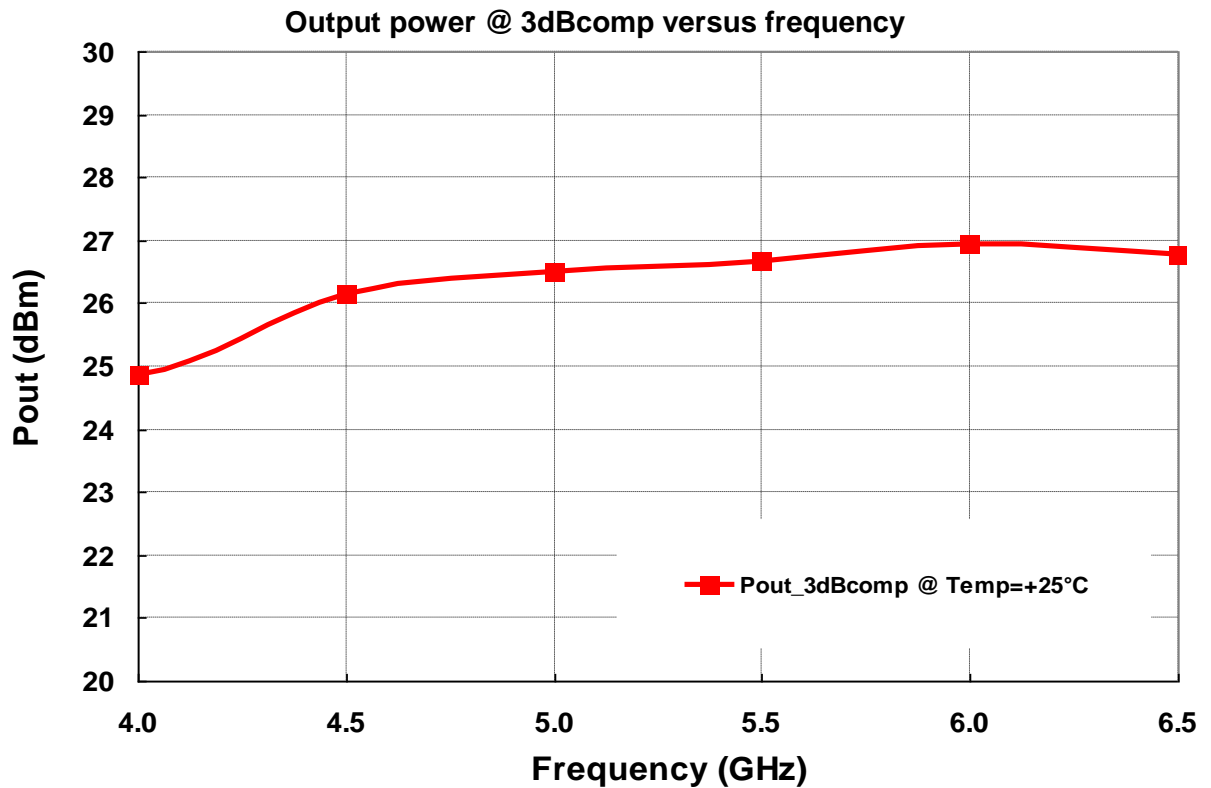

Typical on board Measurements

Vd = 8V, Id (Quiescent) = 120mA, Drain Pulse width = 50µs, Duty cycle = 10%

Drain Current @ 3dBcomp versus frequency

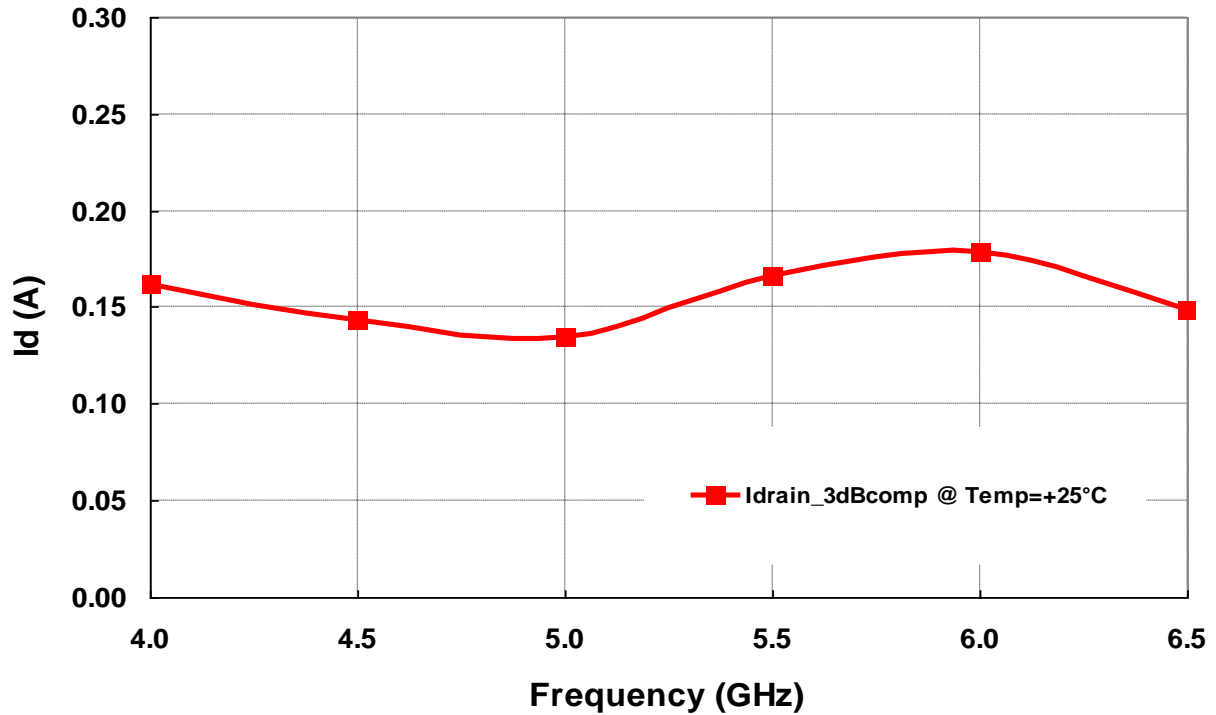

Package outline ⁽¹⁾

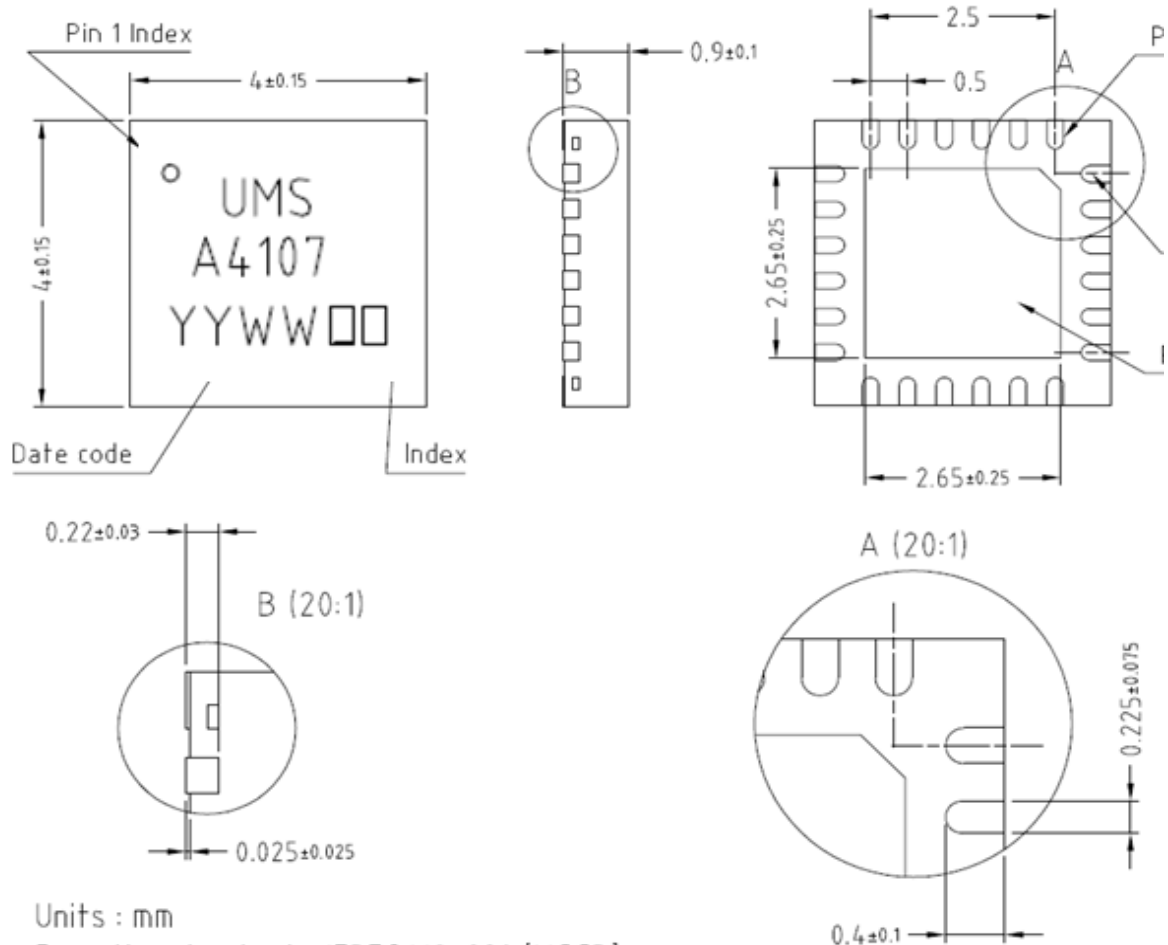

Units : mm
 From the standard : JEDEC MO-220 [VGGD]
 Matt tin, Lead free (Green)

Matt tin. Lead Free (Green)		1- Nc	9- Nc	17- Gnd
Units : mm		2- Gnd	10- Nc	18- Nc
From the standard : JEDEC MO-220 (VGGD)		3- Gnd	11- Nc	19- Nc
		4- RF In	12- Nc	20- Vd2
	25- GND	5- Gnd	13- Gnd	21- Gnd
		6- Gnd	14- Gnd	22- Vd1
		7- Nc	15- RF out	23- Vg
		8- Nc	16- Gnd	24- Gnd

⁽¹⁾ The package outline drawing included to this data-sheet is given for indication. Refer to the application note AN0017 (<http://www.ums-gaas.com>) for exact package dimensions.

⁽²⁾ It is strongly recommended to ground all pins marked "Gnd" through the PCB board. Ensure that the PCB board is designed to provide the best possible ground to the package.

Evaluation mother board

- Based on typically Ro4003 / 8mils or equivalent.
- Using a micro-strip to coplanar transition to access the package.
- Recommended for the implementation of this product on a module board.
- In CW mode, decoupling capacitors of 10nF \pm 10% are recommended for Drain & Gate accesses.
- In pulsed mode, decoupling capacitors of 100pF in parallel with decoupling capacitors of 1nF are recommended for Drain access. On Gate access, decoupling capacitors of 100pF and 1 μ F in parallel are recommended.
- See application note AN0017 for details.

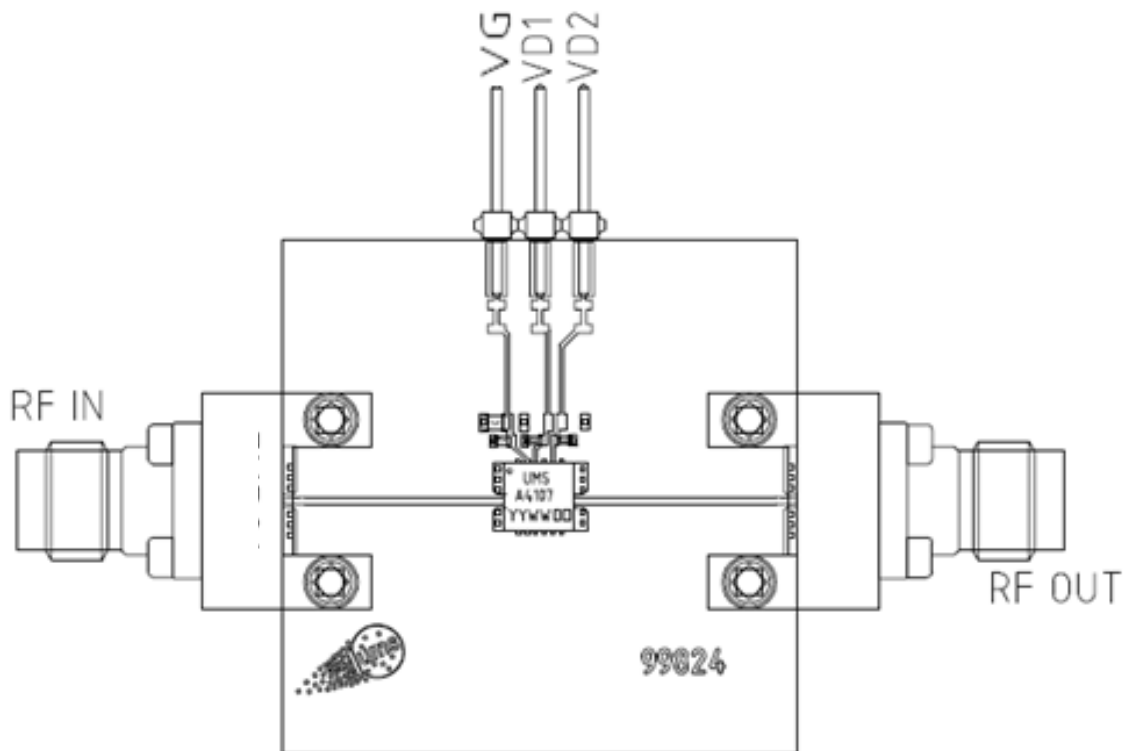

DC Schematic

Medium Power Amplifier: 8V, 120mA

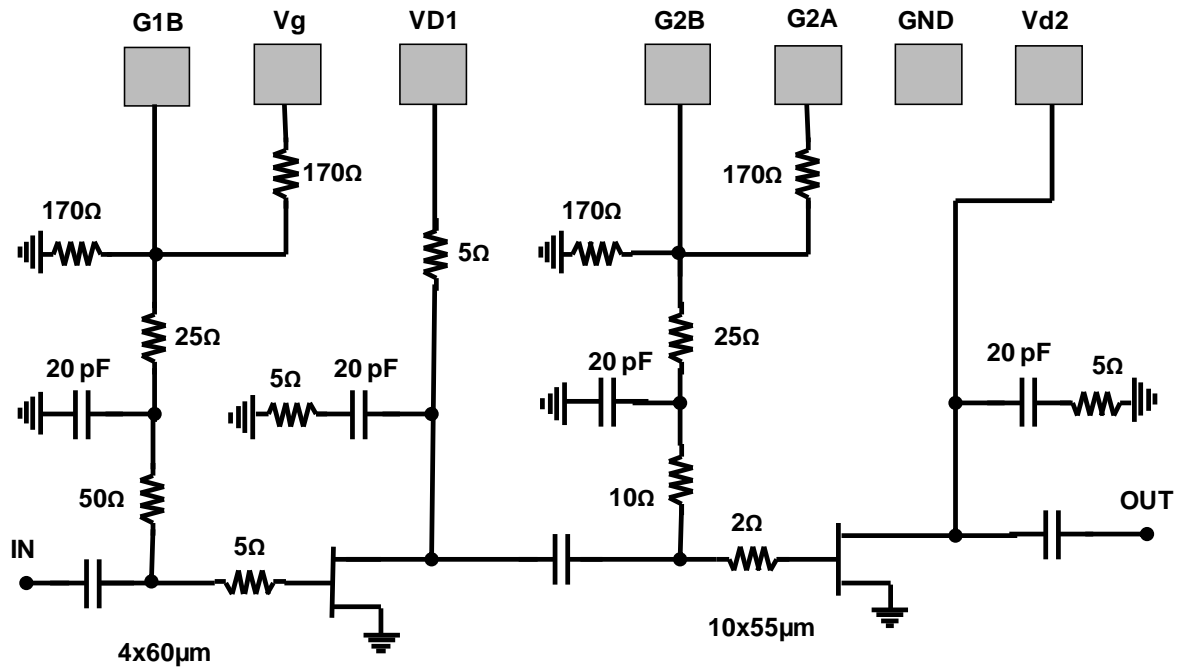

Recommended package footprint

Refer to the application note AN0017 available at <http://www.ums-gaas.com> for package footprint recommendations.

SMD mounting procedure

For the mounting process standard techniques involving solder paste and a suitable reflow process can be used. For further details, see application note AN0017.

Recommended environmental management

UMS products are compliant with the regulation in particular with the directives RoHS N°2011/65 and REACH N°1907/2006. More environmental data are available in the application note AN0019 also available at <http://www.ums-gaas.com>.

Recommended ESD management

Refer to the application note AN0020 available at <http://www.ums-gaas.com> for ESD sensitivity and handling recommendations for the UMS package products.

Ordering Information

QFN 4x4 package:

CHA4107-QDG/XY

Stick: XY = 20

Tape & reel: XY = 21

Information furnished is believed to be accurate and reliable. However **United Monolithic Semiconductors S.A.S.** assumes no responsibility for the consequences of use of such information nor for any infringement of patents or other rights of third parties which may result from its use. No license is granted by implication or otherwise under any patent or patent rights of **United Monolithic Semiconductors S.A.S.** Specifications mentioned in this publication are subject to change without notice. This publication supersedes and replaces all information previously supplied. **United Monolithic Semiconductors S.A.S.** products are not authorised for use as critical components in life support devices or systems without express written approval from **United Monolithic Semiconductors S.A.S.**

X-ON Electronics

Largest Supplier of Electrical and Electronic Components

Click to view similar products for [RF Amplifier](#) category:

Click to view products by [United Monolithic Semiconductors](#) manufacturer:

Other Similar products are found below :

[ADPA7006AEHZ](#) [CXE2089ZSR](#) [MGA-43828-BLKG](#) [A82-1](#) [RF2878TR7](#) [BGA 728L7 E6327](#) [BGB719N7ESDE6327XTMA1](#) [HMC1126-SX](#) [HMC342](#) [HMC561-SX](#) [HMC598-SX](#) [HMC-ALH382-SX](#) [HMC-ALH476-SX](#) [SE2433T-R](#) [SE2622L-R](#) [SMA3101-TL-E](#) [SMA39](#) [SMA70-1](#) [A66-1](#) [A66-3](#) [A67-1](#) [LX5535LQ](#) [LX5540LL](#) [RF2373TR7](#) [HMC3653LP3BETR](#) [HMC395](#) [HMC549MS8GETR](#) [HMC576-SX](#) [HMC754S8GETR](#) [HMC-ALH435-SX](#) [SMA101](#) [SMA1031](#) [SMA32](#) [SMA411](#) [SMA531](#) [SST12LP17E-XX8E](#) [SST12LP19E-QX6E](#) [TGA2598](#) [WPM0510A](#) [HMC5929LS6TR](#) [HMC5879LS7TR](#) [HMC906A-SX](#) [HMC1127](#) [HMC544A](#) [HMC1126](#) [HMC1110-SX](#) [HMC1087F10](#) [HMC1086](#) [HMC1016](#) [MMZ25332B4T1](#)